



Economic and Social Council

Distr.: General
5 September 2011

English only

Economic Commission for Europe

Inland Transport Committee

Working Party on Customs Questions affecting Transport

Informal Ad hoc Expert Group on Conceptual and Technical aspects of Computerization of the TIR Procedure

Nineteenth session

Belgrade, 13–14 September 2011

Item 3(c) of the provisional agenda

Reference Model of the TIR procedure:

Chapter 4 – Design

XML messages

Note by the secretariat

I. Background

1. At its eighteenth session, the Informal Ad hoc Expert Group on Conceptual and Technical aspects of Computerization of the TIR Procedure, further referred to as the Expert Group, welcomed document ECE/TRANS/WP.30/GE.1/2011/4 containing the revised UN/EDIFACT E9 and E10 messages. It supported the secretariat's proposal that Extensible Markup Language (XML) Schema Definition (XSD) files should not be included in the eTIR Reference Model but rather be made available on the eTIR web site. The Expert Group also reiterated that input from external experts will be required to ensure completion of the technical documentation and invited Governments to contribute to this task by means of providing either human or financial resources.

2. The Dutch Customs administration kindly offered to continue its support to the elaboration of Chapter 4. Dutch Customs invited the secretariat in Apeldoorn (Netherlands) for a working meeting (2–4 August 2011) on the elaboration of standard eTIR XML messages. Further to this meeting, Mr. Hans Greven, with the help of Mr. Sybrand Bootsma, developed XML Schemas for all eTIR messages, based on the results of the meeting as well as on international standards, including those from the World Customs Organization (WCO). Furthermore, they prepared the message structures and guidelines presented in the Annex to this document.

II. Open question

3. While developing the XML messages, a question arose with the E9 and E10 messages. Indeed, unlike all other messages, the structure of those two messages can fully be aligned to the WCO standards. The reason for this is that the scope of WCO data model (DM) version 3 was restricted to declaration messages – Business-to-Customs (B2C) – and the reply messages – Customs-to-Business (C2B). In eTIR, numerous messages go beyond the scope of the WCO DM. The major difference between the WCO message structure and the one used in most eTIR messages is that, in eTIR, the declaration class is not systematically the message header class. Instead, a generic message header class has been created allowing the submission of all kind of information. In the preliminary developments of version 4 of the WCO DM, the idea of creating a generic header class (document or message) has already been discussed and seems rather inevitable in case the WCO would like to widen the scope of the DM version 4 to include Customs-to-Customs (C2C) messages and the possibility to communicate other documents, e.g. certificates.

4. Bearing this in mind, it was unclear if the E9 and E10 messages should be defined with the same message header as all other eTIR messages or be kept fully compatible with WCO DM version 3.

5. Furthermore, data elements in Chapter 3 of the eTIR Reference Model have been defined with standard types. From a technical perspective, data types can be more complex than root type, such as binary, float or integer, and are, therefore, not only composed of a content component but also of supplementary components. This is particularly true when it comes to data elements such as codes and identifiers. Table 1 presents the list of all supplementary components in the identifiers and codes, as foreseen in the United Nations Core Components Library (UN/CCL)¹ list of unqualified data types (UDT).

Table 1

Supplementary components of the Identifier and Code core data types

<i>Identifier</i>	<i>Code</i>
- schemeID	- listID
- schemeName	- listAgencyID
- schemeAgencyID	- listAgencyName
- schemeAgencyName	- listName
- schemeVersionID	- listVersionID
- schemeDataURI	- name
- schemeURI	- languageID
	- listURI
	- listschemeURI

6. So far, the developed eTIR XSD files as well as XML structures and guidelines presented in the Annex, only have some of the supplementary components included, i.e. those that are in bold in the table, and their status is optional. The Expert Group might want to consider if other of those supplementary components would have to be included and decide on the status (mandatory or optional) of each of the supplementary components.

¹ www.unece.org/cefact/codesfortrade/uncc/CCL_index.htm

III. Further considerations

7. The Expert Group may wish to discuss the XML guidelines and schemas presented in the Annex, consider the open question presented in section II and, possibly, request the inclusion of the XML message structures and guidelines in Chapter 4 of the eTIR Reference model as well as the creation of a new page on the eTIR web site as a repository for the eTIR XSD files.

Annex

eTIR messages

XML structure and guidelines

4.2.3. Messages Implementation

4.2.3.1. XML

4.2.3.1.1. External messages

4.2.3.1.1.1. E1 – Register guarantee

a. Structure

Occurance	Element/Attribute
	Message
1 .. 1	xs:sequence
1 .. 1	TypeCode
optional	listID
optional	listAgencyID
1 .. 1	ReferenceNumberID
optional	schemeID
optional	schemeAgencyID
1 .. 1	FunctionCode
optional	listID
optional	listAgencyID
1 .. 1	Guarantee
1 .. 1	xs:sequence
1 .. 1	ReferenceID
optional	schemeID
optional	schemeAgencyID
1 .. 1	LPCOExpirationDateTime
required	formatCode
1 .. 1	SecurityDetailsCode
optional	listID
optional	listAgencyID
1 .. 1	IssueDateTime
required	formatCode
1 .. 1	Surety
1 .. 1	xs:sequence
1 .. 1	ID
optional	schemeID
optional	schemeAgencyID
1 .. 1	TransitPrincipal
1 .. 1	xs:sequence
1 .. 1	ID
optional	schemeID
optional	schemeAgencyID

b. Guidelines

Element/Attribute	Annotation
Message	<p>eTIR name Message Status R Occurrence 1 .. 1</p>
xs:sequence	
TypeCode	<p>Occurrence 1 .. 1 Type ds:MessageTypeCodeType WhiteSpace collapse Format an..3 eTIR name Type, coded Status R Code List CL26 Message types Restricted code(s) E1 Register guarantee</p>
listID	<p>Type xs:token Use optional WhiteSpace collapse</p>
listAgencyID	<p>Type clm63055:AgencyIdentificationCodeContentType Length 1 .. 3 Use optional WhiteSpace collapse</p>
ReferenceNumberID	<p>Occurrence 1 .. 1 Type ds:MessageReferenceNumberIDType WhiteSpace collapse Format an..14 eTIR name Message reference number Status R</p>
schemeID	<p>Type xs:token Use optional WhiteSpace collapse</p>
schemeAgencyID	<p>Type clm63055:AgencyIdentificationCodeContentType Length 1 .. 3 Use optional WhiteSpace collapse</p>
FunctionCode	<p>Occurrence 1 .. 1 Type ds:MessageFunctionCodeType WhiteSpace collapse Format n..2 eTIR name Message function, coded Code List CL16 Message function code Status R Restricted code(s) 9 Original</p>
listID	<p>Type xs:token Use optional WhiteSpace collapse</p>
listAgencyID	<p>Type clm63055:AgencyIdentificationCodeContentType Length 1 .. 3 Use optional WhiteSpace collapse</p>
Guarantee	<p>Occurrence 1 .. 1 eTIR name Guarantee Status R</p>
xs:sequence	
ReferenceID	<p>Occurrence 1 .. 1 Type ds:GuaranteeReferenceIDType WhiteSpace collapse Format an..35 eTIR name Reference Status R</p>
schemeID	<p>Type xs:token Use optional WhiteSpace collapse</p>

└─ <i>schemeAgencyID</i>	Type	clm63055:AgencyIdentificationCodeContentType
	Length	1 .. 3
	Use	optional
	WhiteSpace	collapse
└─ LPCOExpirationDateTime	Occurrence	1 .. 1
	Type	ds:GuaranteeLPCOExpirationDateTimeType
	WhiteSpace	collapse
	Format	n8
	eTIR name	Validity
	Status	R
└─ <i>formatCode</i>	Type	clm62379:DateTimePeriodFormatCode
	Length	1 .. 3
	Use	required
	WhiteSpace	collapse
	Name	Date or time or period format code
	Description	Code specifying the representation of a date, time or period.
	Applicable Codes	
	102	CCYYMMDD Calendar date: C = Century ; Y = Year ; M = Month ; D = Day.
	304	CCYYMMDDHHMMSSZZ See 204 plus Z=Time zone.
	602	CCYY Calendar year including century: C = Century; Y = Year.
└─ SecurityDetailsCode	Occurrence	1 .. 1
	Type	ds:GuaranteeSecurityDetailsCodeType
	WhiteSpace	collapse
	Format	an..3
	eTIR name	Guarantee type
	Code List	CL12 Guarantee type code
	Status	R
└─ <i>listID</i>	Type	xs:token
	Use	optional
	WhiteSpace	collapse
└─ <i>listAgencyID</i>	Type	clm63055:AgencyIdentificationCodeContentType
	Length	1 .. 3
	Use	optional
	WhiteSpace	collapse
└─ IssueDateTime	Occurrence	1 .. 1
	Type	ds:GuaranteeIssueDateTimeType
	WhiteSpace	collapse
	Format	n..17
	eTIR name	Issuing date
	Status	R
└─ <i>formatCode</i>	Type	clm62379:DateTimePeriodFormatCode
	Length	1 .. 3
	Use	required
	WhiteSpace	collapse
	Name	Date or time or period format code
	Description	Code specifying the representation of a date, time or period.
	Applicable Codes	
	102	CCYYMMDD Calendar date: C = Century ; Y = Year ; M = Month ; D = Day.
	304	CCYYMMDDHHMMSSZZ See 204 plus Z=Time zone.
	602	CCYY Calendar year including century: C = Century; Y = Year.
└─ Surety	Occurrence	1 .. 1
	eTIR name	GuaranteeChain
	Status	R
└─ xs:sequence	Occurrence	1 .. 1

<ul style="list-style-type: none"> └ ID 	<p>Occurrence 1 .. 1 Type ds:SuretyIdentificationIDType WhiteSpace collapse Format an..17 eTIR name Code Status R</p>
<ul style="list-style-type: none"> └ schemeID 	<p>Type xs:token Use optional WhiteSpace collapse</p>
<ul style="list-style-type: none"> └ schemeAgencyID 	<p>Type clm63055:AgencyIdentificationCodeContentType Length 1 .. 3 Use optional WhiteSpace collapse</p>
<ul style="list-style-type: none"> └ TransitPrincipal 	<p>Occurrence 1 .. 1 eTIR name Holder Status R</p>
<ul style="list-style-type: none"> └ xs:sequence 	<p>Occurrence 1 .. 1</p>
<ul style="list-style-type: none"> └ ID 	<p>Occurrence 1 .. 1 Type ds:TransitPrincipalIdentificationIDType WhiteSpace collapse Format an..17 eTIR name Code Code List CL15 International TIR database Status R</p>
<ul style="list-style-type: none"> └ schemeID 	<p>Type xs:token Use optional WhiteSpace collapse</p>
<ul style="list-style-type: none"> └ schemeAgencyID 	<p>Type clm63055:AgencyIdentificationCodeContentType Length 1 .. 3 Use optional WhiteSpace collapse</p>

4.2.3.1.1.2 E2 – Register results

a. Structure

Occurance	Element/Attribute
1 .. 1	Message
1 .. 1	└ xs:sequence
optional	└ TypeCode
optional	└ listID
optional	└ listAgencyID
1 .. 1	└ ReferenceNumberID
optional	└ schemeID
optional	└ schemeAgencyID
1 .. 1	└ FunctionCode
optional	└ listID
optional	└ listAgencyID
1 .. 1	└ FunctionalReferenceID
optional	└ schemeID
optional	└ schemeAgencyID
1 .. 1	└ Guarantee
1 .. 1	└ xs:sequence
1 .. 1	└ ReferenceID
optional	└ schemeID
optional	└ schemeAgencyID
0 .. unbounded	└ Error
1 .. 1	└ xs:sequence
1 .. 1	└ ValidationCode
optional	└ listID
optional	└ listAgencyID

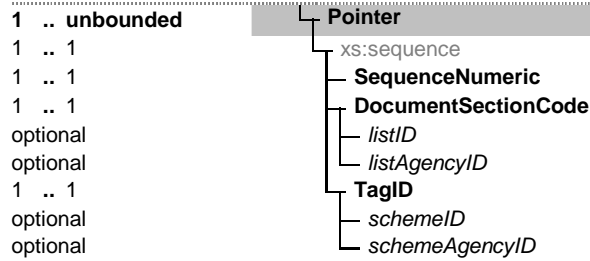

b. Guidelines

Element/Attribute	Annotation
Message	eTIR name Message Occurrence 1 .. 1
xs:sequence	
TypeCode	Occurrence 1 .. 1 Type ds:MessageTypeCodeType WhiteSpace collapse Format an..3 eTIR name Type, coded Status R Code List CL26 Message types Restricted code(s) E2 Register results
listID	Type xs:token Use optional WhiteSpace collapse
listAgencyID	Type clm63055:AgencyIdentificationCodeContentType Length 1 .. 3 Use optional WhiteSpace collapse
ReferenceNumberID	Occurrence 1 .. 1 Type ds:MessageReferenceNumberIDType WhiteSpace collapse Format an..14 eTIR name Message reference number Status R
schemeID	Type xs:token Use optional WhiteSpace collapse
schemeAgencyID	Type clm63055:AgencyIdentificationCodeContentType Length 1 .. 3 Use optional WhiteSpace collapse
FunctionCode	Occurrence 1 .. 1 Type ds:MessageFunctionCodeType WhiteSpace collapse Format n..2 eTIR name Message function, coded Code List CL16 Message function code Status R Restricted code(s) 44 Accepted without reserves Restricted code(s) 27 Not accepted
listID	Type xs:token Use optional WhiteSpace collapse
listAgencyID	Type clm63055:AgencyIdentificationCodeContentType Length 1 .. 3 Use optional WhiteSpace collapse

FunctionalReferenceID	Occurrence	1 .. 1
	Type	ds:MessageFunctionalReferenceIDType
	WhiteSpace	collapse
	Format	an..35
	eTIR name	Functional reference
	Status	R
<i>schemeID</i>	Type	xs:token
	Use	optional
	WhiteSpace	collapse
<i>schemeAgencyID</i>	Type	clm63055:AgencyIdentificationCodeContentType
	Length	1 .. 3
	Use	optional
	WhiteSpace	collapse
Guarantee	Occurrence	1 .. 1
	eTIR name	Guarantee
	Status	R
xs:sequence	Occurrence	1 .. 1
ReferenceID	Occurrence	1 .. 1
	Type	ds:GuaranteeReferenceIDType
	WhiteSpace	collapse
	Format	an..35
	eTIR name	Reference
	Status	R
<i>schemeID</i>	Type	xs:token
	Use	optional
	WhiteSpace	collapse
<i>schemeAgencyID</i>	Type	clm63055:AgencyIdentificationCodeContentType
	Length	1 .. 3
	Use	optional
	WhiteSpace	collapse
Error	Occurrence	0 .. unbounded
	eTIR name	Error
	Status	D
	Condition	C006
xs:sequence	Occurrence	1 .. 1
ValidationCode	Occurrence	1 .. 1
	Type	ds:ErrorValidationCodeType
	WhiteSpace	collapse
	Format	an..8
	eTIR name	Error, coded
	Code List	CL99 Error code (to be developed)
	Status	R
<i>listID</i>	Type	xs:token
	Use	optional
	WhiteSpace	collapse
<i>listAgencyID</i>	Type	clm63055:AgencyIdentificationCodeContentType
	Length	1 .. 3
	Use	optional
	WhiteSpace	collapse
Pointer	Occurrence	1 .. unbounded
	eTIR name	Pointer
	Status	R
xs:sequence	Occurrence	1 .. 1
SequenceNumeric	Occurrence	1 .. 1
	Type	ds:PointerSequenceNumericType
	Format	n..5
	eTIR name	Sequence number
	Status	R
DocumentSectionCode	Occurrence	1 .. 1
	Type	ds:PointerDocumentSectionCodeType
	WhiteSpace	collapse
	Format	an..3
	eTIR name	Document/message section, coded
	Code List	CL18 Message section code (codes to be defined)

<i>listID</i>	Status	R
	Type	xs:token
	Use	optional
	WhiteSpace	collapse
<i>listAgencyID</i>	Type	clm63055:AgencyIdentificationCodeContentType
	Length	1 .. 3
	Use	optional
	WhiteSpace	collapse
TagID	Occurrence	1 .. 1
	Type	ds:PointerTagIDType
	WhiteSpace	collapse
	Format	an..4
	eTIR name	Tag identifier
	Code List	CL19 Pointer code (codes to be defined)
	Status	R
<i>schemeID</i>	Type	xs:token
	Use	optional
	WhiteSpace	collapse
<i>schemeAgencyID</i>	Type	clm63055:AgencyIdentificationCodeContentType
	Length	1 .. 3
	Use	optional
	WhiteSpace	collapse

4.2.3.1.1.3. E3 – Cancel guarantee

a. Structure

Occurance	Element/Attribute
1 .. 1	Message
1 .. 1	xs:sequence
optional	TypeCode
optional	<i>listID</i>
optional	<i>listAgencyID</i>
1 .. 1	ReferenceNumberID
optional	<i>schemeID</i>
optional	<i>schemeAgencyID</i>
1 .. 1	FunctionCode
optional	<i>listID</i>
optional	<i>listAgencyID</i>
1 .. 1	Guarantee
1 .. 1	xs:sequence
1 .. 1	ReferenceID
optional	<i>schemeID</i>
optional	<i>schemeAgencyID</i>
1 .. 1	SecurityDetailsCode
optional	<i>listID</i>
optional	<i>listAgencyID</i>
1 .. 1	CancellationDateTime
required	<i>formatCode</i>
1 .. 1	Surety
1 .. 1	xs:sequence
1 .. 1	ID
optional	<i>schemeID</i>
optional	<i>schemeAgencyID</i>
1 .. 1	TransitPrincipal
1 .. 1	xs:sequence
1 .. 1	ID
optional	<i>schemeID</i>
optional	<i>schemeAgencyID</i>

b. Guidelines

Element/Attribute	Annotation
Message	eTIR name Message
xs:sequence	Occurrence 1 .. 1
TypeCode	Occurrence 1 .. 1
	Type ds:MessageTypeCodeType
	WhiteSpace collapse
	Format an..3
	eTIR name Type, coded
	Status R
	Code List CL26 Message types
	Restricted code(s) E3 Cancel guarantee
listID	Type xs:token
	Use optional
	WhiteSpace collapse
listAgencyID	Type clm63055:AgencyIdentificationCodeContentType
	Length 1 .. 3
	Use optional
	WhiteSpace collapse
ReferenceNumberID	Occurrence 1 .. 1
	Type ds:MessageReferenceNumberIDType
	WhiteSpace collapse
	Format an..14
	eTIR name Message reference number
	Status R
schemeID	Type xs:token
	Use optional
	WhiteSpace collapse
schemeAgencyID	Type clm63055:AgencyIdentificationCodeContentType
	Length 1 .. 3
	Use optional
	WhiteSpace collapse
FunctionCode	Occurrence 1 .. 1
	Type ds:MessageFunctionCodeType
	WhiteSpace collapse
	Format n..2
	eTIR name Message function, coded
	Code List CL16 Message function code
	Status R
	Restricted code(s) 9 Original
listID	Type xs:token
	Use optional
	WhiteSpace collapse
listAgencyID	Type clm63055:AgencyIdentificationCodeContentType
	Length 1 .. 3
	Use optional
	WhiteSpace collapse
Guarantee	Occurrence 1 .. 1
	eTIR name Guarantee
	Status R
xs:sequence	Occurrence 1 .. 1
ReferenceID	Occurrence 1 .. 1
	Type ds:GuaranteeReferenceIDType
	WhiteSpace collapse
	Format an..35
	eTIR name Reference
	Status R
schemeID	Type xs:token
	Use optional
	WhiteSpace collapse

<ul style="list-style-type: none"> └─ <i>schemeAgencyID</i> 	<p>Type ctm63055:AgencyIdentificationCodeContentType Length 1 .. 3 Use optional WhiteSpace collapse</p>
<ul style="list-style-type: none"> └─ SecurityDetailsCode 	<p>Occurrence 1 .. 1 Type ds:GuaranteeSecurityDetailsCodeType WhiteSpace collapse Format an..3 eTIR name Guarantee type Code List CL12 Guarantee type code Status R</p>
<ul style="list-style-type: none"> └─ <i>listID</i> 	<p>Type xs:token Use optional WhiteSpace collapse</p>
<ul style="list-style-type: none"> └─ <i>listAgencyID</i> 	<p>Type ctm63055:AgencyIdentificationCodeContentType Length 1 .. 3 Use optional WhiteSpace collapse</p>
<ul style="list-style-type: none"> └─ CancellationDateTime 	<p>Occurrence 1 .. 1 Type ds:GuaranteeCancellationDateTimeType WhiteSpace collapse Format n..17 eTIR name Cancellation date Status R</p>
<ul style="list-style-type: none"> └─ <i>formatCode</i> 	<p>Type ctm62379:DateTimePeriodFormatCode Length 1 .. 3 Use required WhiteSpace collapse Name Date or time or period format code Description Code specifying the representation of a date, time or period.</p> <p>Applicable Codes</p> <p>102 CCYYMMDD Calendar date: C = Century ; Y = Year ; M = Month ; D = Day.</p> <p>304 CCYYMMDDHHMMSSZZZ See 204 plus Z=Time zone.</p> <p>602 CCYY Calendar year including century: C = Century; Y = Year.</p>
<ul style="list-style-type: none"> └─ Surety 	<p>Occurrence 1 .. 1 eTIR name GuaranteeChain Status R</p>
<ul style="list-style-type: none"> └─ xs:sequence 	
<ul style="list-style-type: none"> └─ ID 	<p>Occurrence 1 .. 1 Type ds:SuretyIdentificationIDType WhiteSpace collapse Format an..17 eTIR name Code Status R</p>
<ul style="list-style-type: none"> └─ <i>schemeID</i> 	<p>Type xs:token Use optional WhiteSpace collapse</p>
<ul style="list-style-type: none"> └─ <i>schemeAgencyID</i> 	<p>Type ctm63055:AgencyIdentificationCodeContentType Length 1 .. 3 Use optional WhiteSpace collapse</p>
<ul style="list-style-type: none"> └─ TransitPrincipal 	<p>Occurrence 1 .. 1 eTIR name Holder Status R</p>
<ul style="list-style-type: none"> └─ xs:sequence 	
<ul style="list-style-type: none"> └─ ID 	<p>Occurrence 1 .. 1 Type ds:TransitPrincipalIdentificationIDType WhiteSpace collapse Format an..17 eTIR name Code Code List CL15 International TIR database</p>

	Status	R	
	Code List	CL26	Message types
	Restricted code(s)	E4	Cancellation results
<i>listID</i>	Type	xs:token	
	Use	optional	
	WhiteSpace	collapse	
<i>listAgencyID</i>	Type	clm63055:AgencyIdentificationCodeContentType	
	Length	1 .. 3	
	Use	optional	
	WhiteSpace	collapse	
ReferenceNumberID	Occurrence	1 .. 1	
	Type	ds:MessageReferenceNumberIDType	
	WhiteSpace	collapse	
	Format	an..14	
	eTIR name	Message reference number	
	Status	R	
<i>schemeID</i>	Type	xs:token	
	Use	optional	
	WhiteSpace	collapse	
<i>schemeAgencyID</i>	Type	clm63055:AgencyIdentificationCodeContentType	
	Length	1 .. 3	
	Use	optional	
	WhiteSpace	collapse	
FunctionCode	Occurrence	1 .. 1	
	Type	ds:MessageFunctionCodeType	
	WhiteSpace	collapse	
	Format	n..2	
	eTIR name	Message function, coded	
	Code List	CL16	Message function code
	Status	R	
	Restricted code(s)	27	Not accepted
	Restricted code(s)	44	Accepted without reserves
	Restricted code(s)	45	Accepted with reserves (pending the termination of the current TIR operation).
<i>listID</i>	Type	xs:token	
	Use	optional	
	WhiteSpace	collapse	
<i>listAgencyID</i>	Type	clm63055:AgencyIdentificationCodeContentType	
	Length	1 .. 3	
	Use	optional	
	WhiteSpace	collapse	
FunctionalReferenceID	Occurrence	1 .. 1	
	Type	ds:MessageFunctionalReferenceIDType	
	WhiteSpace	collapse	
	Format	an..35	
	eTIR name	Functional reference	
	Status	R	
<i>schemeID</i>	Type	xs:token	
	Use	optional	
	WhiteSpace	collapse	
<i>schemeAgencyID</i>	Type	clm63055:AgencyIdentificationCodeContentType	
	Length	1 .. 3	
	Use	optional	
	WhiteSpace	collapse	
Guarantee	Occurrence	1 .. 1	
	eTIR name	Guarantee	
	Status	R	
<i>xs:sequence</i>	Occurrence	1 .. 1	
ReferenceID	Occurrence	1 .. 1	
	Type	ds:GuaranteeReferenceIDType	
	WhiteSpace	collapse	
	Format	an..35	

	eTIR name	Reference
	Status	R
	Type	xs:token
	Use	optional
	WhiteSpace	collapse
<i>schemeID</i>	Type	clm63055:AgencyIdentificationCodeContentType
	Length	1 .. 3
	Use	optional
	WhiteSpace	collapse
Error	Occurrence	0 .. unbounded
	eTIR name	Error
	Status	D
	Condition	C006
	Occurrence	1 .. 1
<i>xs:sequence</i>	Occurrence	1 .. 1
ValidationCode	Type	ds:ErrorValidationCodeType
	WhiteSpace	collapse
	Format	an..8
	eTIR name	Error, coded
	Code List	CL99 Error code (to be developed)
	Status	R
<i>listID</i>	Type	xs:token
	Use	optional
	WhiteSpace	collapse
<i>listAgencyID</i>	Type	clm63055:AgencyIdentificationCodeContentType
	Length	1 .. 3
	Use	optional
	WhiteSpace	collapse
Pointer	Occurrence	1 .. unbounded
	eTIR name	Pointer
	Status	R
	Occurrence	1 .. 1
<i>xs:sequence</i>	Occurrence	1 .. 1
SequenceNumeric	Type	ds:PointerSequenceNumericType
	Format	n..5
	eTIR name	Sequence number
	Status	R
DocumentSectionCode	Occurrence	1 .. 1
	Type	ds:PointerDocumentSectionCodeType
	WhiteSpace	collapse
	Format	an..3
	eTIR name	Document/message section, coded
	Code List	CL18 Message section code (codes to be defined)
	Status	R
<i>listID</i>	Type	xs:token
	Use	optional
	WhiteSpace	collapse
<i>listAgencyID</i>	Type	clm63055:AgencyIdentificationCodeContentType
	Length	1 .. 3
	Use	optional
	WhiteSpace	collapse
TagID	Occurrence	1 .. 1
	Type	ds:PointerTagIDType
	WhiteSpace	collapse
	Format	an..4
	eTIR name	Tag identifier
	Code List	CL19 Pointer code (codes to be defined)
	Status	R
<i>schemeID</i>	Type	xs:token
	Use	optional
	WhiteSpace	collapse

└ <i>schemeAgencyID</i>	Type	clm63055:AgencyIdentificationCodeContentType
	Length	1 .. 3
	Use	optional
	WhiteSpace	collapse

4.2.3.1.1.5. E5 – Query guarantee

a. Structure

Occurance	Element/Attribute
1 .. 1	Message
1 .. 1	└ xs:sequence
optional	└ TypeCode
optional	└ <i>listID</i>
optional	└ <i>listAgencyID</i>
1 .. 1	└ SubTypeCode
optional	└ <i>listID</i>
optional	└ <i>listAgencyID</i>
1 .. 1	└ ReferenceNumberID
optional	└ <i>schemeID</i>
optional	└ <i>schemeAgencyID</i>
1 .. 1	└ FunctionCode
optional	└ <i>listID</i>
optional	└ <i>listAgencyID</i>
1 .. 1	└ Guarantee
1 .. 1	└ xs:sequence
1 .. 1	└ ReferenceID
optional	└ <i>schemeID</i>
optional	└ <i>schemeAgencyID</i>

b. Guidelines

Element/Attribute	Annotation
Message	eTIR name Message
└ xs:sequence	Occurance 1 .. 1
└ TypeCode	Occurance 1 .. 1
	Type ds:MessageTypeCodeType
	WhiteSpace collapse
	Format an..3
	eTIR name Type, coded
	Status R
	Code List CL26 Message types
	Restricted E5 Query guarantee
	code(s)
└ <i>listID</i>	Type xs:token
	Use optional
	WhiteSpace collapse
└ <i>listAgencyID</i>	Type clm63055:AgencyIdentificationCodeContentType
	Length 1 .. 3
	Use optional
	WhiteSpace collapse
└ SubTypeCode	Occurance 1 .. 1
	Type ds:MessageSubTypeCodeType
	WhiteSpace collapse
	Format an..6
	eTIR name Sub type, coded
	Code List CL09 Message sub type
	Restricted 00 Return all information regarding guarantee (default)
	code(s)

	Restricted code(s)	01	Return only guarantee information
	Restricted code(s)	02	Return only declaration information
	Restricted code(s)	03	Return only TIR transport information
	Status	R	
listID	Type	xs:token	
	Use	optional	
	WhiteSpace	collapse	
listAgencyID	Type	clm63055:AgencyIdentificationCodeContentType	
	Length	1 .. 3	
	Use	optional	
	WhiteSpace	collapse	
ReferenceNumberID	Occurrence	1 .. 1	
	Type	ds:MessageReferenceNumberIDType	
	WhiteSpace	collapse	
	Format	an..14	
	eTIR name	Message reference number	
	Status	R	
schemeID	Type	xs:token	
	Use	optional	
	WhiteSpace	collapse	
schemeAgencyID	Type	clm63055:AgencyIdentificationCodeContentType	
	Length	1 .. 3	
	Use	optional	
	WhiteSpace	collapse	
FunctionCode	Occurrence	1 .. 1	
	Type	ds:MessageFunctionCodeType	
	WhiteSpace	collapse	
	Format	n..2	
	eTIR name	Message function, coded	
	Code List	CL16	Message function code
	Status	R	
	Restricted code(s)	9	Original
listID	Type	xs:token	
	Use	optional	
	WhiteSpace	collapse	
listAgencyID	Type	clm63055:AgencyIdentificationCodeContentType	
	Length	1 .. 3	
	Use	optional	
	WhiteSpace	collapse	
Guarantee	Occurrence	1 .. 1	
	eTIR name	Guarantee	
	Status	R	
xs:sequence	Occurrence	1 .. 1	
ReferenceID	Occurrence	1 .. 1	
	Type	ds:GuaranteeReferenceIDType	
	WhiteSpace	collapse	
	Format	an..35	
	eTIR name	Reference	
	Status	R	
schemeID	Type	xs:token	
	Use	optional	
	WhiteSpace	collapse	
schemeAgencyID	Type	clm63055:AgencyIdentificationCodeContentType	
	Length	1 .. 3	
	Use	optional	
	WhiteSpace	collapse	

4.2.3.1.1.6. E6 – Query results

a. Structure

Occurance	Element/Attribute
	Messages
1 .. 1	xs:sequence
1 .. 1	TypeCode
optional	listID
optional	listAgencyID
1 .. 1	ReferenceNumberID
optional	schemeID
optional	schemeAgencyID
1 .. 1	FunctionCode
optional	listID
optional	listAgencyID
1 .. 1	FunctionalReferenceID
optional	schemeID
optional	schemeAgencyID
1 .. 1	Guarantee
1 .. 1	xs:sequence
1 .. 1	ReferenceID
optional	schemeID
optional	schemeAgencyID
1 .. 1	LPCOExpirationDateTime
required	formatCode
1 .. 1	SecurityDetailsCode
optional	listID
optional	listAgencyID
1 .. 1	GuaranteeStatusCode
optional	listID
optional	listAgencyID
1 .. 1	Surety
1 .. 1	xs:sequence
1 .. 1	ID
optional	schemeID
optional	schemeAgencyID
0 .. unbounded	TIROperation
1 .. 1	xs:sequence
1 .. 1	SequenceNumeric
1 .. 1	RegistrationNumberID
optional	schemeID
optional	schemeAgencyID
0 .. 1	Start
1 .. 1	xs:sequence
1 .. 1	DateDateTime
required	formatCode
0 .. 1	TimeLimitDateTime
required	formatCode
0 .. 1	Remarks
optional	languageID
1 .. 1	CustomsOffice
1 .. 1	xs:sequence
1 .. 1	ID
optional	schemeID
optional	schemeAgencyID
0 .. unbounded	NationalItinerary
1 .. 1	xs:sequence

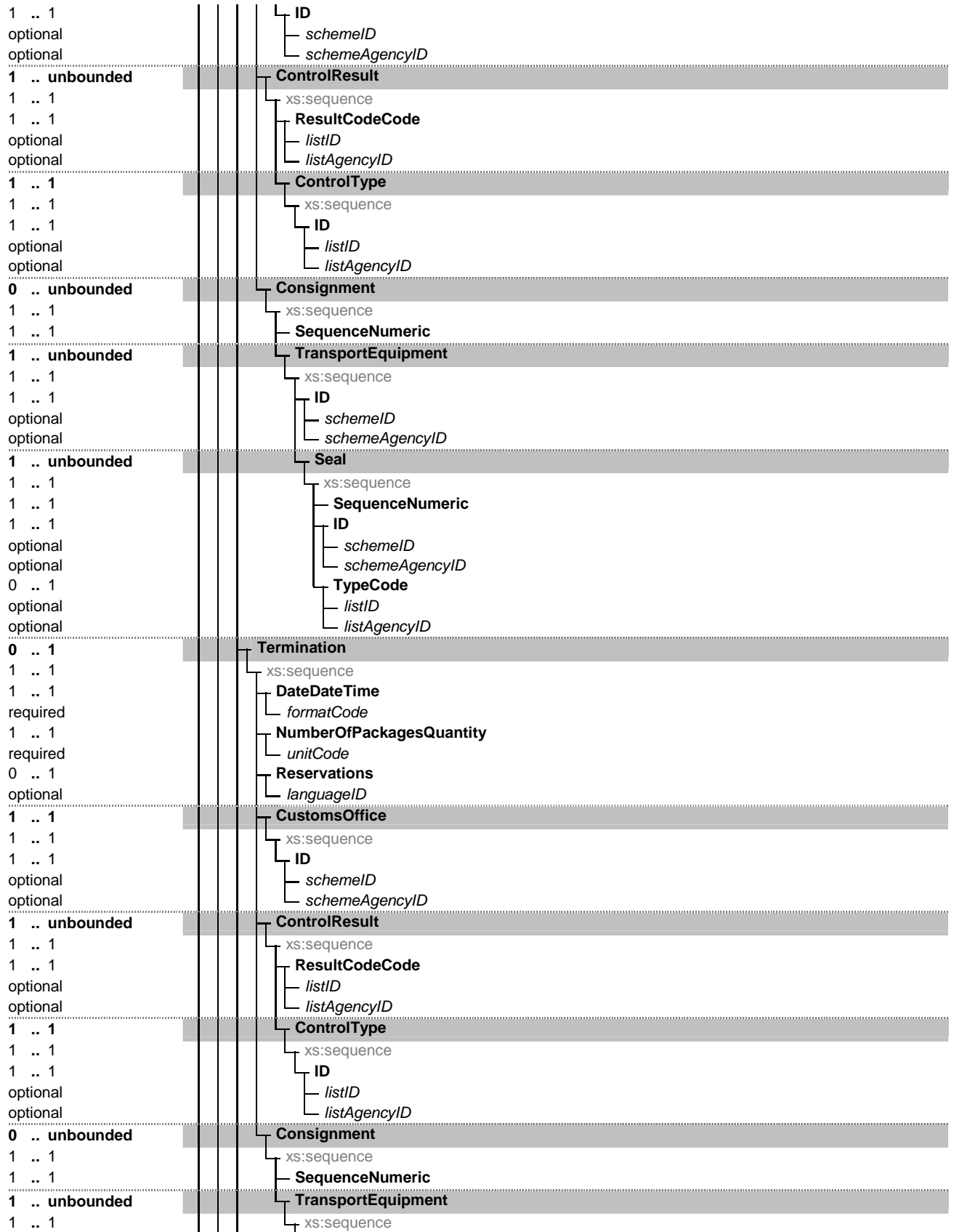

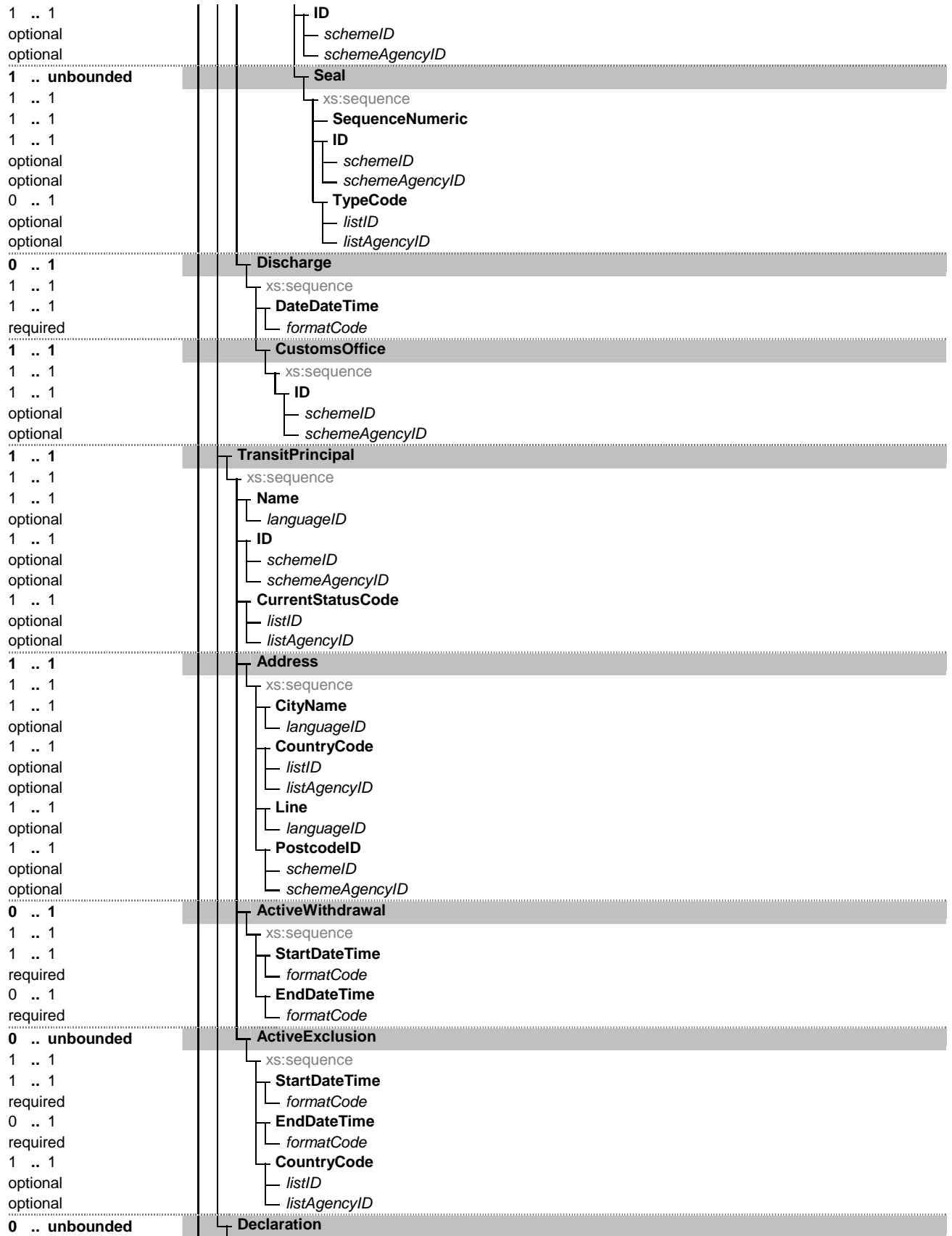

1 .. 1	xs:sequence
1 .. 1	IssueDateTime
required	<i>formatCode</i>
1 .. 1	ID
optional	<i>schemeID</i>
optional	<i>schemeAgencyID</i>
1 .. 1	TypeCode
optional	<i>listID</i>
optional	<i>listAgencyID</i>
0 .. 1	TotalGrossMassMeasure
required	<i>unitCode</i>
1 .. 1	AdditionalInformation
1 .. 1	xs:sequence
0 .. 1	Content
optional	<i>languageID</i>
0 .. 1	StatementCode
optional	<i>listID</i>
optional	<i>listAgencyID</i>
0 .. unbounded	Agent
1 .. 1	xs:sequence
1 .. 1	ID
optional	<i>schemeID</i>
optional	<i>schemeAgencyID</i>
1 .. 1	RoleCode
optional	<i>listID</i>
optional	<i>listAgencyID</i>
0 .. unbounded	Amendment
1 .. 1	xs:sequence
1 .. 1	ChangeReasonCode
optional	<i>listID</i>
optional	<i>listAgencyID</i>
1 .. unbounded	Pointer
1 .. 1	xs:sequence
1 .. 1	SequenceNumeric
1 .. 1	DocumentSectionCode
optional	<i>listID</i>
optional	<i>listAgencyID</i>
1 .. 1	TagID
optional	<i>schemeID</i>
optional	<i>schemeAgencyID</i>
0 .. 1	Carrier
1 .. 1	xs:sequence
0 .. 1	Name
optional	<i>languageID</i>
0 .. 1	ID
optional	<i>schemeID</i>
optional	<i>schemeAgencyID</i>
0 .. unbounded	Address
1 .. 1	xs:sequence
1 .. 1	CityName
optional	<i>languageID</i>
1 .. 1	CountryCode
optional	<i>listID</i>
optional	<i>listAgencyID</i>
1 .. 1	Line
optional	<i>languageID</i>
1 .. 1	PostcodeID
optional	<i>schemeID</i>
optional	<i>schemeAgencyID</i>

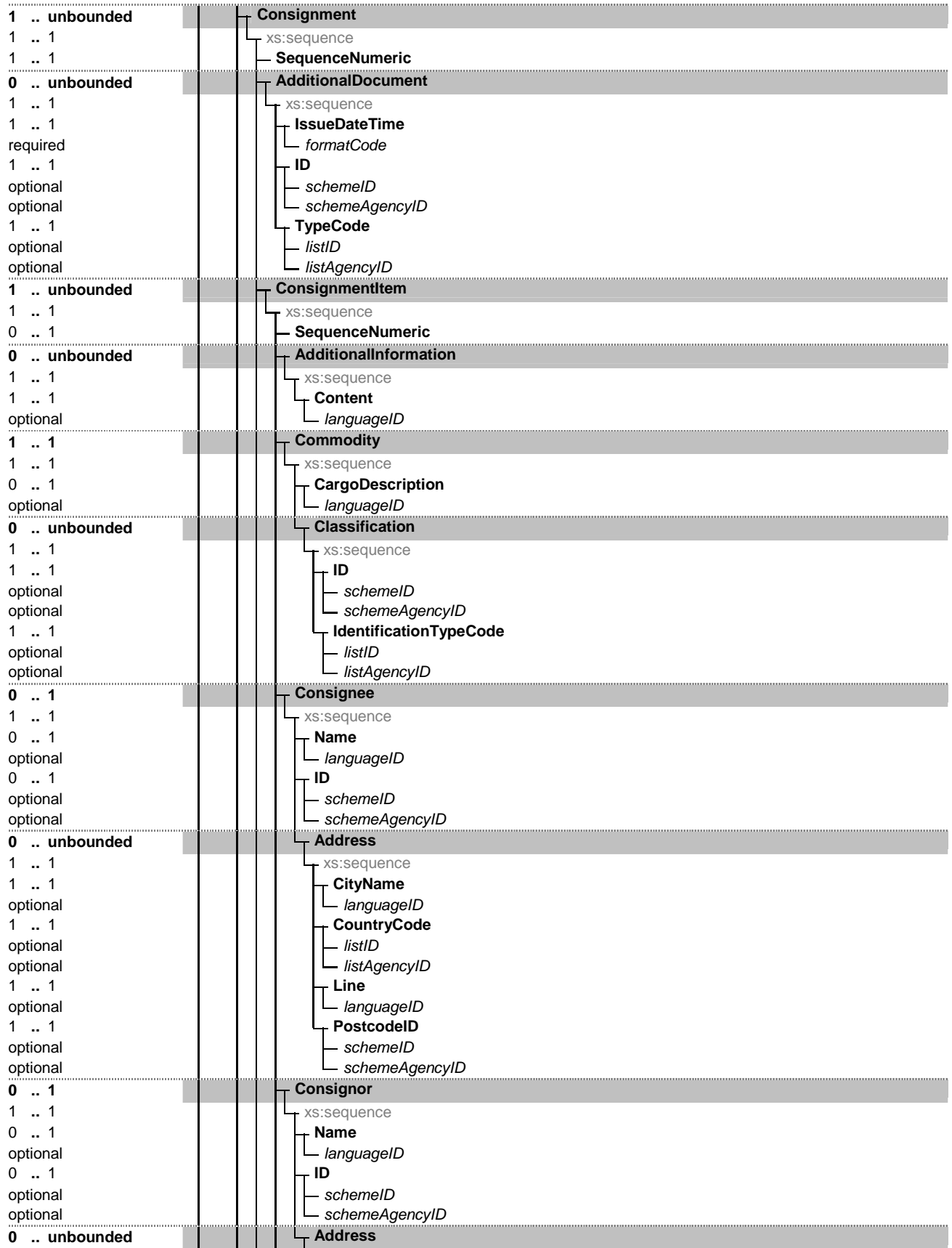

1 .. 1		xs:sequence
1 .. 1		CityName
optional		<i>languageID</i>
1 .. 1		CountryCode
optional		<i>listID</i>
optional		<i>listAgencyID</i>
1 .. 1		Line
optional		<i>languageID</i>
1 .. 1		PostcodeID
optional		<i>schemeID</i>
optional		<i>schemeAgencyID</i>
0 .. 1		DeliveryDestination
1 .. 1		xs:sequence
1 .. 1		Name
optional		<i>languageID</i>
1 .. 1		Address
1 .. 1		xs:sequence
1 .. 1		CityName
optional		<i>languageID</i>
1 .. 1		CountryCode
optional		<i>listID</i>
optional		<i>listAgencyID</i>
1 .. 1		Line
optional		<i>languageID</i>
1 .. 1		PostcodeID
optional		<i>schemeID</i>
optional		<i>schemeAgencyID</i>
1 .. 1		GoodsMeasure
1 .. 1		xs:sequence
1 .. 1		GrossMassMeasure
required		<i>unitCode</i>
1 .. 1		Packaging
1 .. 1		xs:sequence
1 .. 1		MarksNumbersID
optional		<i>schemeID</i>
optional		<i>schemeAgencyID</i>
1 .. 1		QuantityQuantity
required		<i>unitCode</i>
1 .. 1		TypeCode
optional		<i>listID</i>
optional		<i>listAgencyID</i>
0 .. 1		TransportEquipment
1 .. 1		xs:sequence
1 .. 1		ID
optional		<i>schemeID</i>
optional		<i>schemeAgencyID</i>
0 .. unbounded		UCR
1 .. 1		xs:sequence
1 .. 1		ID
optional		<i>schemeID</i>
optional		<i>schemeAgencyID</i>
0 .. 1		LoadingLocation
1 .. 1		xs:sequence
1 .. 1		Name
optional		<i>languageID</i>
0 .. 1		NotifyParty
1 .. 1		xs:sequence
0 .. 1		Name
optional		<i>languageID</i>

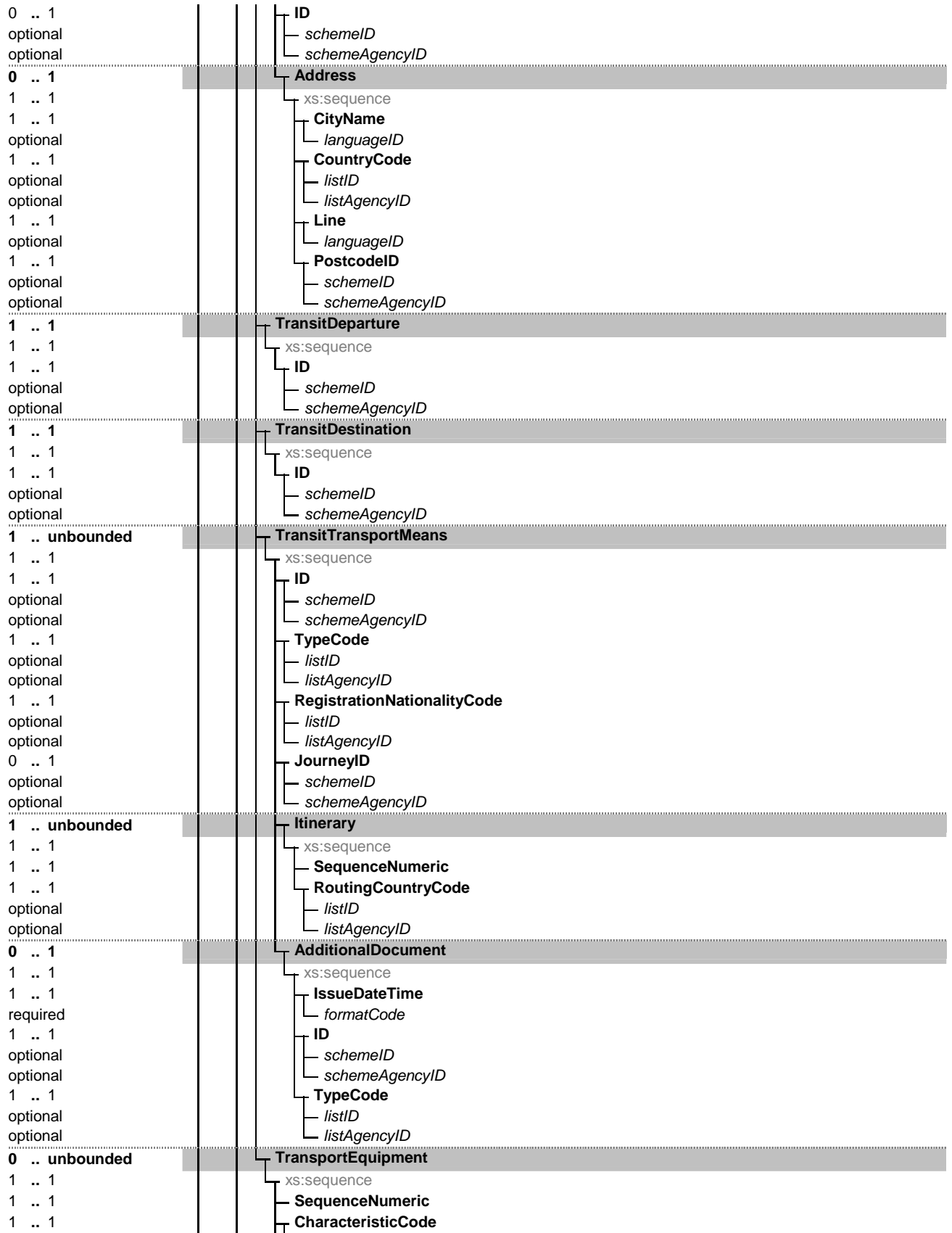

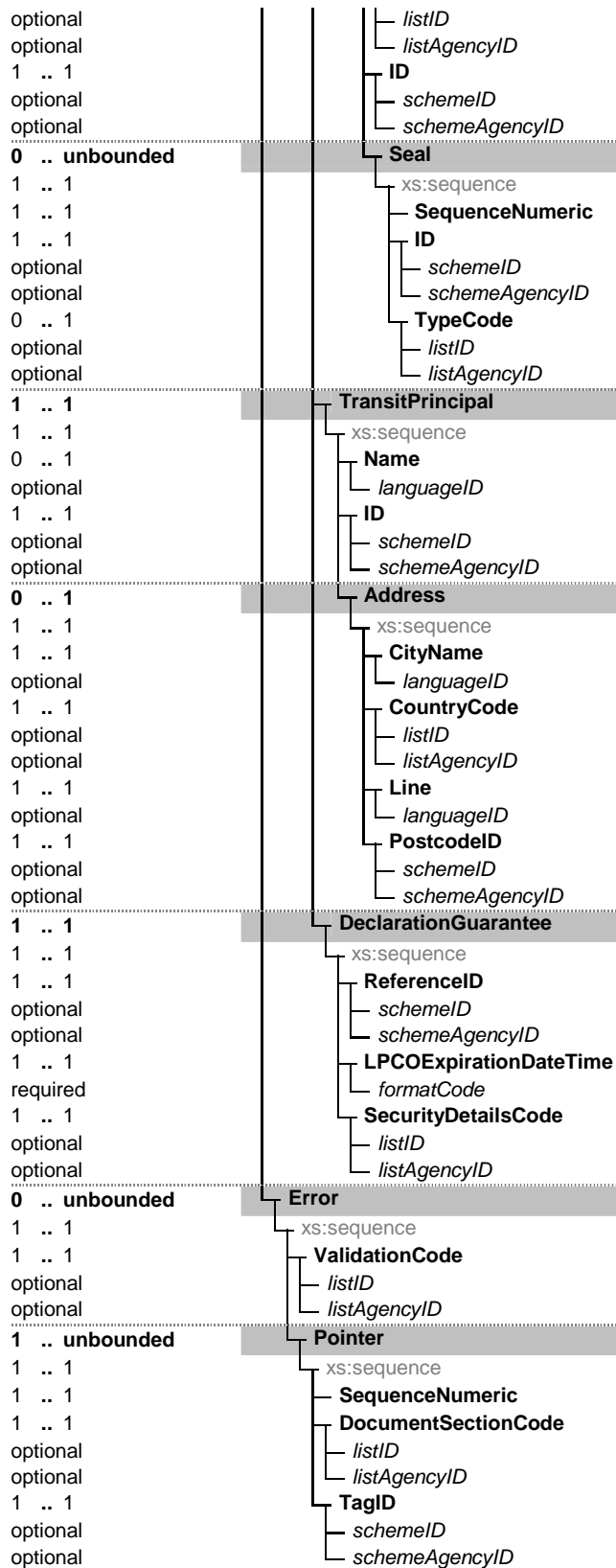

b. Guidelines

Element/Attribute	Annotation
Messages	eTIR name Message
xs:sequence	Occurrence 1 .. 1
TypeCode	Occurrence 1 .. 1
	Type ds:MessageTypeCodeType
	WhiteSpace collapse
	Format an..3
	eTIR name Type, coded
	Status R
	Code List CL26 Message types
	Restricted code(s) E6 Query results
<i>listID</i>	Type xs:token
	Use optional
	WhiteSpace collapse
<i>listAgencyID</i>	Type clm63055:AgencyIdentificationCodeContentType
	Length 1 .. 3
	Use optional
	WhiteSpace collapse
ReferenceNumberID	Occurrence 1 .. 1
	Type ds:MessageReferenceNumberIDType
	WhiteSpace collapse
	Format an..14
	eTIR name Message reference number
	Status R
<i>schemeID</i>	Type xs:token
	Use optional
	WhiteSpace collapse
<i>schemeAgencyID</i>	Type clm63055:AgencyIdentificationCodeContentType
	Length 1 .. 3
	Use optional
	WhiteSpace collapse
FunctionCode	Occurrence 1 .. 1
	Type ds:MessageFunctionCodeType
	WhiteSpace collapse
	Format n..2
	eTIR name Message function, coded
	Code List CL16 Message function code
	Status R
	Restricted code(s) 10 Not found
	Restricted code(s) 11 Response
<i>listID</i>	Type xs:token
	Use optional
	WhiteSpace collapse
<i>listAgencyID</i>	Type clm63055:AgencyIdentificationCodeContentType
	Length 1 .. 3
	Use optional
	WhiteSpace collapse
FunctionalReferenceID	Occurrence 1 .. 1
	Type ds:MessageReferenceNumberIDType
	WhiteSpace collapse
	Format an..35
	eTIR name Functional reference
	Status R
<i>schemeID</i>	Type xs:token
	Use optional
	WhiteSpace collapse

└─ <i>schemaAgencyID</i>	Type	clm63055:AgencyIdentificationCodeContentType
	Length	1 .. 3
	Use	optional
	WhiteSpace	collapse
Guarantee	Occurrence	1 .. 1
	eTIR name	Guarantee
	Status	R
└─ xs:sequence	Occurrence	1 .. 1
└─ ReferenceID	Occurrence	1 .. 1
	Type	ds:GuaranteeReferenceIDType
	WhiteSpace	collapse
	Format	an..35
	eTIR name	Reference
	Status	R
└─ <i>schemeID</i>	Type	xs:token
	Use	optional
	WhiteSpace	collapse
└─ <i>schemaAgencyID</i>	Type	clm63055:AgencyIdentificationCodeContentType
	Length	1 .. 3
	Use	optional
	WhiteSpace	collapse
LPCOExpirationDateTime	Occurrence	1 .. 1
	Type	ds:GuaranteeLPCOExpirationDateTimeType
	WhiteSpace	collapse
	Format	n8
	eTIR name	Validity
	Status	R
└─ <i>formatCode</i>	Type	clm62379:DateTimePeriodFormatCode
	Length	1 .. 3
	Use	required
	WhiteSpace	collapse
	Name	Date or time or period format code
	Description	Code specifying the representation of a date, time or period.
	Applicable Codes	
	102	CCYYMMDD Calendar date: C = Century ; Y = Year ; M = Month ; D = Day.
	304	CCYYMMDDHHMMSSZZZ See 204 plus Z=Time zone.
	602	CCYY Calendar year including century: C = Century; Y = Year.
SecurityDetailsCode	Occurrence	1 .. 1
	Type	ds:GuaranteeSecurityDetailsCodeType
	WhiteSpace	collapse
	Format	an..3
	eTIR name	Guarantee type
	Code List	CL12 Guarantee type code
	Status	R
└─ <i>listID</i>	Type	xs:token
	Use	optional
	WhiteSpace	collapse
└─ <i>listAgencyID</i>	Type	clm63055:AgencyIdentificationCodeContentType
	Length	1 .. 3
	Use	optional
	WhiteSpace	collapse
GuaranteeStatusCode	Occurrence	1 .. 1
	Type	ds:GuaranteeGuaranteeStatusCodeType
	WhiteSpace	collapse
	Format	an..3
	Code List	CL22 Guarantee status
	eTIR name	Guarantee status
	Status	R
└─ <i>listID</i>	Type	xs:token
	Use	optional
	WhiteSpace	collapse

listAgencyID	Type	clm63055:AgencyIdentificationCodeContentType
	Length	1 .. 3
	Use	optional
	WhiteSpace	collapse
Surety	Occurrence	1 .. 1
	eTIR name	GuaranteeChain
	Status	R
xs:sequence	Occurrence	1 .. 1
ID	Occurrence	1 .. 1
	Type	ds:SuretyIdentificationIDType
	WhiteSpace	collapse
	Format	an..17
	eTIR name	Code
	Status	R
schemeID	Type	xs:token
	Use	optional
	WhiteSpace	collapse
schemeAgencyID	Type	clm63055:AgencyIdentificationCodeContentType
	Length	1 .. 3
	Use	optional
	WhiteSpace	collapse
TIROperation	Occurrence	0 .. unbounded
	eTIR name	TIROperation
	Status	O
xs:sequence	Occurrence	1 .. 1
SequenceNumeric	Occurrence	1 .. 1
	Type	ds:TIROperationSequenceNumericType
	Format	n..5
	eTIR name	Sequence number
	Status	R
RegistrationNumberID	Occurrence	1 .. 1
	Type	ds:TIROperationRegistrationNumberIDType
	WhiteSpace	collapse
	eTIR name	Registration number
	Format	an..35
	Status	R
schemeID	Type	xs:token
	Use	optional
	WhiteSpace	collapse
schemeAgencyID	Type	clm63055:AgencyIdentificationCodeContentType
	Length	1 .. 3
	Use	optional
	WhiteSpace	collapse
Start	Occurrence	0 .. 1
	eTIR name	Start
	Status	O
xs:sequence	Occurrence	1 .. 1
DateDateTime	Occurrence	1 .. 1
	Type	ds:StartDateDateTimeType
	WhiteSpace	collapse
	eTIR name	Date
	Format	n..17
	Status	R
formatCode	Type	clm62379:DateTimePeriodFormatCode
	Length	1 .. 3
	Use	required
	WhiteSpace	collapse
	Name	Date or time or period format code
	Description	Code specifying the representation of a date, time or period.
	Applicable Codes	
	102	CCYYMMDD Calendar date: C = Century ; Y = Year ; M = Month ; D = Day.

	304	CCYYMMDDHHMMSSZZZ See 204 plus Z=Time zone.
	602	CCYY Calendar year including century: C = Century; Y = Year.
TimeLimitDateTime	Occurrence	0 .. 1
	Type	ds:StartTimeLimitDateTimeType
	WhiteSpace	collapse
	eTIR name	Time limit
	Format	n..17
	Status	O
formatCode	Type	clm62379:DatePeriodFormatCode
	Length	1 .. 3
	Use	required
	WhiteSpace	collapse
	Name	Date or time or period format code
	Description	Code specifying the representation of a date, time or period.
	Applicable Codes	
	102	CCYYMMDD Calendar date: C = Century ; Y = Year ; M = Month ; D = Day.
	304	CCYYMMDDHHMMSSZZZ See 204 plus Z=Time zone.
	602	CCYY Calendar year including century: C = Century; Y = Year.
Remarks	Occurrence	0 .. 1
	Type	ds:StartRemarksTextType
	eTIR name	Remarks
	Format	an..512
	Status	O
languageID	Type	xs:language
	Use	optional
	Pattern	([a-zA-Z]{2}) [iI]-[a-zA-Z]+ [xX]-[a-zA-Z]{1,8})-([a-zA-Z]{1,8})*
	WhiteSpace	collapse
CustomsOffice	Occurrence	1 .. 1
	eTIR name	CustomsOffice
	Status	R
xs:sequence	Occurrence	1 .. 1
ID	Occurrence	1 .. 1
	Type	ds:CustomsOfficeIdentificationIDType
	WhiteSpace	collapse
	Format	an..17
	eTIR name	Customs office, coded
	Code List	CL13 Customs offices database (to be developed)
	Status	R
schemeID	Type	xs:token
	Use	optional
	WhiteSpace	collapse
schemeAgencyID	Type	clm63055:AgencyIdentificationCodeContentType
	Length	1 .. 3
	Use	optional
	WhiteSpace	collapse
NationalItinerary	Occurrence	0 .. unbounded
	eTIR name	NationalItinerary
	Status	O
xs:sequence	Occurrence	1 .. 1
ID	Occurrence	1 .. 1
	Type	ds:NationalItineraryIdentificationIDType
	WhiteSpace	collapse
	Format	an..17
	eTIR name	Customs office, coded
	Code List	CL13 Customs offices database (to be developed)
	Status	R

<i>schemeID</i>	Type Use WhiteSpace	xs:token optional collapse
<i>schemeAgencyID</i>	Type Length Use WhiteSpace	clm63055:AgencyIdentificationCodeContentType 1 .. 3 optional collapse
ControlResult	Occurrence eTIR name Status	1 .. unbounded ControlResult R
xs:sequence	Occurrence	1 .. 1
ResultCodeCode	Occurrence Type WhiteSpace eTIR name Code List Format Status	1 .. 1 ds:ControlResultResultCodeCodeType collapse Code CL24 an..3 R
		Control result code
<i>listID</i>	Type Use WhiteSpace	xs:token optional collapse
<i>listAgencyID</i>	Type Length Use WhiteSpace	clm63055:AgencyIdentificationCodeContentType 1 .. 3 optional collapse
ControlType	Occurrence eTIR name Status	1 .. 1 ControlType R
xs:sequence	Occurrence	1 .. 1
ID	Occurrence Type WhiteSpace eTIR name Format Code List Status	1 .. 1 ds:ControlTypeIdentificationCodeType collapse Identification an..3 CL25 R
		Control type code
<i>listID</i>	Type Use WhiteSpace	xs:token optional collapse
<i>listAgencyID</i>	Type Length Use WhiteSpace	clm63055:AgencyIdentificationCodeContentType 1 .. 3 optional collapse
Consignment	Occurrence Status Rule Rule eTIR name	0 .. unbounded O R007 R006 Consignment
xs:sequence	Occurrence	1 .. 1
SequenceNumeric	Occurrence Type Format Status eTIR name	1 .. 1 ds:ConsignmentSequenceNumericType n..5 R Sequence number
TransportEquipment	Occurrence Status eTIR name	1 .. unbounded R TransportEquipment
xs:sequence	Occurrence	1 .. 1
ID	Occurrence Type WhiteSpace Format Status eTIR name	1 .. 1 ds:TransportEquipmentIdentificationIDType collapse an..17 R Identification

<i>schemeID</i>	Type Use WhiteSpace	xs:token optional collapse
<i>schemeAgencyID</i>	Type Length Use WhiteSpace	clm63055:AgencyIdentificationCodeContentType 1 .. 3 optional collapse
Seal	Occurrence Status eTIR name	1 .. unbounded R Seal
xs:sequence	Occurrence	1 .. 1
SequenceNumeric	Occurrence Type Format Status Rule Rule eTIR name	1 .. 1 ds:SealSequenceNumericType n..5 R R003 R004 Sequence number
ID	Occurrence Type WhiteSpace Format Status Rule eTIR name	1 .. 1 ds:SealIdentificationIDType collapse an..35 R R005 Seal number
<i>schemeID</i>	Type Use WhiteSpace	xs:token optional collapse
<i>schemeAgencyID</i>	Type Length Use WhiteSpace	clm63055:AgencyIdentificationCodeContentType 1 .. 3 optional collapse
TypeCode	Occurrence Type WhiteSpace Format Status eTIR name Code List	0 .. 1 ds:SealTypeCodeType collapse an..3 O Seal type code CL08 Seal type code
<i>listID</i>	Type Use WhiteSpace	xs:token optional collapse
<i>listAgencyID</i>	Type Length Use WhiteSpace	clm63055:AgencyIdentificationCodeContentType 1 .. 3 optional collapse
Termination	Occurrence eTIR name Status	0 .. 1 Termination O
xs:sequence	Occurrence	1 .. 1
DateDateTime	Occurrence Type WhiteSpace eTIR name Format Status	1 .. 1 ds:TerminationDateDateTimeType collapse Date n..17 R
<i>formatCode</i>	Type Length Use WhiteSpace Name Description	clm62379:DateTimePeriodFormatCode 1 .. 3 required collapse Date or time or period format code Code specifying the representation of a date, time or period.
Applicable Codes		

		102	CCYYMMDD Calendar date: C = Century ; Y = Year ; M = Month ; D = Day.
		304	CCYYMMDDHHMMSSZZ See 204 plus Z=Time zone.
		602	CCYY Calendar year including century: C = Century; Y = Year.
	NumberOfPackagesQuantity	Occurrence	1 .. 1
		Type	ds:TerminationNumberOfPackagesQuantityType
		Format	n..8
		eTIR name	Number of packages
		Status	R
	<i>unitCode</i>	Type	clm6Recommendation20: MeasurementUnitCommonCodeContentType
		Length	1 .. 3
		Use	required
		WhiteSpace	collapse
	Reservations	Occurrence	0 .. 1
		Type	ds:TerminationReservationsTextType
		eTIR name	Reservations
		Format	an..512
		Status	O
	<i>languageID</i>	Type	xs:language
		Use	optional
		Pattern	([a-zA-Z]{2})[iI]-[a-zA-Z]+[xX]-[a-zA-Z]{1,8})(-[a-zA-Z]{1,8})*
		WhiteSpace	collapse
	CustomsOffice	Occurrence	1 .. 1
		eTIR name	CustomsOffice
		Status	R
	xs:sequence	Occurrence	1 .. 1
	ID	Occurrence	1 .. 1
		Type	ds:CustomsOfficeIdentificationIDType
		WhiteSpace	collapse
		Format	an..17
		eTIR name	Customs office, coded
		Code List	CL13 Customs offices database (to be developed)
		Status	R
	<i>schemeID</i>	Type	xs:token
		Use	optional
		WhiteSpace	collapse
	<i>schemeAgencyID</i>	Type	clm63055:AgencyIdentificationCodeContentType
		Length	1 .. 3
		Use	optional
		WhiteSpace	collapse
	ControlResult	Occurrence	1 .. unbounded
		eTIR name	ControlResult
		Status	R
	xs:sequence	Occurrence	1 .. 1
	ResultCodeCode	Occurrence	1 .. 1
		Type	ds:ControlResultResultCodeCodeType
		WhiteSpace	collapse
		eTIR name	Code
		Code List	CL24 Control result code
		Format	an..3
		Status	R
	<i>listID</i>	Type	xs:token
		Use	optional
		WhiteSpace	collapse
	<i>listAgencyID</i>	Type	clm63055:AgencyIdentificationCodeContentType
		Length	1 .. 3
		Use	optional
		WhiteSpace	collapse
	ControlType	Occurrence	1 .. 1
		eTIR name	ControlType

xs:sequence	Status	R
ID	Occurrence	1 .. 1
	Occurrence	1 .. 1
	Type	ds:ControlTypeIdentificationCodeType
	WhiteSpace	collapse
	eTIR name	Identification
	Format	an..3
	Code List	CL25 Control type code
	Status	R
listID	Type	xs:token
	Use	optional
	WhiteSpace	collapse
listAgencyID	Type	clm63055:AgencyIdentificationCodeContentType
	Length	1 .. 3
	Use	optional
	WhiteSpace	collapse
Consignment	Occurrence	0 .. unbounded
	Status	O
	Rule	R006
	Rule	R007
	eTIR name	Consignment
xs:sequence	Occurrence	1 .. 1
SequenceNumeric	Occurrence	1 .. 1
	Type	ds:ConsignmentSequenceNumericType
	Format	n..5
	Status	R
	eTIR name	Sequence number
TransportEquipment	Occurrence	1 .. unbounded
	Status	R
	eTIR name	TransportEquipment
xs:sequence	Occurrence	1 .. 1
ID	Occurrence	1 .. 1
	Type	ds:TransportEquipmentIdentificationIDType
	WhiteSpace	collapse
	Format	an..17
	Status	R
	eTIR name	Identification
schemeID	Type	xs:token
	Use	optional
	WhiteSpace	collapse
schemeAgencyID	Type	clm63055:AgencyIdentificationCodeContentType
	Length	1 .. 3
	Use	optional
	WhiteSpace	collapse
Seal	Occurrence	1 .. unbounded
	Status	R
	eTIR name	Seal
xs:sequence	Occurrence	1 .. 1
SequenceNumeric	Occurrence	1 .. 1
	Type	ds:SealSequenceNumericType
	Format	n..5
	Status	R
	Rule	R003
	Rule	R004
	eTIR name	Sequence number
ID	Occurrence	1 .. 1
	Type	ds:SealIdentificationIDType
	WhiteSpace	collapse
	Format	an..35
	Status	R
	Rule	R006
	eTIR name	Seal number
schemeID	Type	xs:token
	Use	optional
	WhiteSpace	collapse

<i>schemaAgencyID</i>	Type	clm63055:AgencyIdentificationCodeContentType
	Length	1 .. 3
	Use	optional
	WhiteSpace	collapse
TypeCode	Occurrence	0 .. 1
	Type	ds:SealTypeCodeType
	WhiteSpace	collapse
	Format	an..3
	Status	O
	eTIR name	Seal type code
	Code List	CL08 Seal type code
<i>listID</i>	Type	xs:token
	Use	optional
	WhiteSpace	collapse
<i>listAgencyID</i>	Type	clm63055:AgencyIdentificationCodeContentType
	Length	1 .. 3
	Use	optional
	WhiteSpace	collapse
Discharge	Occurrence	0 .. 1
	eTIR name	Discharge
	Status	O
xs:sequence	Occurrence	1 .. 1
DateDateTime	Occurrence	1 .. 1
	Type	ds:DischargeDateDateTimeType
	WhiteSpace	collapse
	eTIR name	Date
	Format	n..17
	Status	R
<i>formatCode</i>	Type	clm62379:DateTimePeriodFormatCode
	Length	1 .. 3
	Use	required
	WhiteSpace	collapse
	Name	Date or time or period format code
	Description	Code specifying the representation of a date, time or period.
	Applicable Codes	
	102	CCYYMMDD Calendar date: C = Century ; Y = Year ; M = Month ; D = Day.
	304	CCYYMMDDHHMMSSZZ See 204 plus Z=Time zone.
	602	CCYY Calendar year including century: C = Century; Y = Year.
CustomsOffice	Occurrence	1 .. 1
	eTIR name	CustomsOffice
	Status	R
xs:sequence	Occurrence	1 .. 1
ID	Occurrence	1 .. 1
	Type	ds:CustomsOfficeIdentificationIDType
	WhiteSpace	collapse
	Format	an..17
	eTIR name	Customs office, coded
	Code List	CL13 Customs offices database (to be developed)
	Status	R
<i>schemeID</i>	Type	xs:token
	Use	optional
	WhiteSpace	collapse
<i>schemaAgencyID</i>	Type	clm63055:AgencyIdentificationCodeContentType
	Length	1 .. 3
	Use	optional
	WhiteSpace	collapse
TransitPrincipal	Occurrence	1 .. 1
	eTIR name	Holder
	Status	R
xs:sequence	Occurrence	1 .. 1

Name	Occurrence	1 .. 1	
	Type		ds:TransitPrincipalNameTextType
	Format		an..70
	eTIR name		Name
	Status		R
<i>languageID</i>	Type		xs:language
	Use		optional
	Pattern		([a-zA-Z]{2} [iI]-[a-zA-Z]+ [xX]-[a-zA-Z]{1,8})-[a-zA-Z]{1,8})*
	WhiteSpace		collapse
ID	Occurrence	1 .. 1	
	Type		ds:TransitPrincipalIdentificationIDType
	WhiteSpace		collapse
	Format		an..17
	eTIR name		Code
	Code List		CL15 International TIR database
	Status		R
<i>schemeID</i>	Type		xs:token
	Use		optional
	WhiteSpace		collapse
<i>schemeAgencyID</i>	Type		clm63055:AgencyIdentificationCodeContentType
	Length		1 .. 3
	Use		optional
	WhiteSpace		collapse
CurrentStatusCode	Occurrence	1 .. 1	
	Type		ds:TransitPrincipalCurrentStatusCodeType
	WhiteSpace		collapse
	Code List		CL23 Holder status
	eTIR name		Current status
	Format		an..3
	Status		R
<i>listID</i>	Type		xs:token
	Use		optional
	WhiteSpace		collapse
<i>listAgencyID</i>	Type		clm63055:AgencyIdentificationCodeContentType
	Length		1 .. 3
	Use		optional
	WhiteSpace		collapse
Address	Occurrence	1 .. 1	
	eTIR name		Address
	Status		R
<i>xs:sequence</i>	Occurrence	1 .. 1	
CityName	Occurrence	1 .. 1	
	Type		ds:AddressCityNameTextType
	Format		an..35
	eTIR name		City name
	Status		R
<i>languageID</i>	Type		xs:language
	Use		optional
	Pattern		([a-zA-Z]{2} [iI]-[a-zA-Z]+ [xX]-[a-zA-Z]{1,8})-[a-zA-Z]{1,8})*
	WhiteSpace		collapse
CountryCode	Occurrence	1 .. 1	
	Type		ds:AddressCountryCodeType
	WhiteSpace		collapse
	Format		a2
	Code List		CL04 Country name code
	eTIR name		Country, coded
	Status		R
<i>listID</i>	Type		xs:token
	Use		optional
	WhiteSpace		collapse

<i>listAgencyID</i>	Type Length Use WhiteSpace	clm63055:AgencyIdentificationCodeContentType 1 .. 3 optional collapse
Line	Occurrence Type Format eTIR name Status	1 .. 1 ds:AddressLineTextType an..70 Street and number/P.O. Box R
<i>languageID</i>	Type Use Pattern WhiteSpace	xs:language optional ([a-zA-Z]{2} [il]-[a-zA-Z]+ [xX]-[a-zA-Z]{1,8}){1,8})+ collapse
PostcodeID	Occurrence Type WhiteSpace Format eTIR name Status	1 .. 1 ds:AddressPostcodeIDType collapse an..9 Postcode identification R
<i>schemeID</i>	Type Use WhiteSpace	xs:token optional collapse
<i>schemeAgencyID</i>	Type Length Use WhiteSpace	clm63055:AgencyIdentificationCodeContentType 1 .. 3 optional collapse
ActiveWithdrawal	Occurrence eTIR name Status	0 .. 1 ActiveWithdrawal O
xs:sequence	Occurrence	1 .. 1
StartDateTime	Occurrence Type WhiteSpace eTIR name Format Status	1 .. 1 ds:ActiveWithdrawalStartDateTimeType collapse Start n..17 R
<i>formatCode</i>	Type Length Use WhiteSpace Name Description	clm62379:DateTimePeriodFormatCode 1 .. 3 required collapse Date or time or period format code Code specifying the representation of a date, time or period.
Applicable Codes		
102	CCYYMMDD	Calendar date: C = Century ; Y = Year ; M = Month ; D = Day.
304	CCYYMMDDHHMMSSZZZ	See 204 plus Z=Time zone.
602	CCYY	Calendar year including century: C = Century; Y = Year.
EndDateTime	Occurrence Type WhiteSpace eTIR name Format Status	0 .. 1 ds:ActiveWithdrawalEndDateTimeType collapse End n..17 O
<i>formatCode</i>	Type Length Use WhiteSpace Name Description	clm62379:DateTimePeriodFormatCode 1 .. 3 required collapse Date or time or period format code Code specifying the representation of a date, time or period.
Applicable Codes		

	102	CCYYMMDD Calendar date: C = Century ; Y = Year ; M = Month ; D = Day.
	304	CCYYMMDDHHMMSSZZ See 204 plus Z=Time zone.
	602	CCYY Calendar year including century: C = Century; Y = Year.
ActiveExclusion	Occurrence	0 .. unbounded
	eTIR name	ActiveExclusion
	Status	O
xs:sequence	Occurrence	1 .. 1
StartDateTime	Occurrence	1 .. 1
	Type	ds:ActiveExclusionStartDateTimeType
	WhiteSpace	collapse
	eTIR name	Start
	Format	n..17
	Status	R
formatCode	Type	clm62379:DateTimePeriodFormatCode
	Length	1 .. 3
	Use	required
	WhiteSpace	collapse
	Name	Date or time or period format code
	Description	Code specifying the representation of a date, time or period.
	Applicable Codes	
	102	CCYYMMDD Calendar date: C = Century ; Y = Year ; M = Month ; D = Day.
	304	CCYYMMDDHHMMSSZZ See 204 plus Z=Time zone.
	602	CCYY Calendar year including century: C = Century; Y = Year.
EndDateTime	Occurrence	0 .. 1
	Type	ds:ActiveExclusionEndDateTimeType
	WhiteSpace	collapse
	eTIR name	End
	Format	n..17
	Status	O
formatCode	Type	clm62379:DateTimePeriodFormatCode
	Length	1 .. 3
	Use	required
	WhiteSpace	collapse
	Name	Date or time or period format code
	Description	Code specifying the representation of a date, time or period.
	Applicable Codes	
	102	CCYYMMDD Calendar date: C = Century ; Y = Year ; M = Month ; D = Day.
	304	CCYYMMDDHHMMSSZZ See 204 plus Z=Time zone.
	602	CCYY Calendar year including century: C = Century; Y = Year.
CountryCode	Occurrence	1 .. 1
	Type	ds:ActiveExclusionCountryCodeType
	WhiteSpace	collapse
	Code List	CL04 Country name code
	eTIR name	Country, coded
	Format	a2
	Status	R
listID	Type	xs:token
	Use	optional
	WhiteSpace	collapse

listAgencyID	Type Length Use WhiteSpace	clm63055:AgencyIdentificationCodeContentType 1 .. 3 optional collapse
Declaration	Occurrence eTIR name Status	0 .. unbounded AdvancedCargoInformation O
xs:sequence	Occurrence	1 .. 1
IssueDateTime	Occurrence Type WhiteSpace Format eTIR name Status	1 .. 1 ds:DeclarationIssueDateTimeType collapse an..17 Date R
formatCode	Type Length Use WhiteSpace Name Description	clm62379:DateTimePeriodFormatCode 1 .. 3 required collapse Date or time or period format code Code specifying the representation of a date, time or period.
Applicable Codes		
	102	CCYYMMDD Calendar date: C = Century ; Y = Year ; M = Month ; D = Day.
	304	CCYYMMDDHHMMSSZZ See 204 plus Z=Time zone.
	602	CCYY Calendar year including century: C = Century; Y = Year.
ID	Occurrence Type WhiteSpace Format eTIR name Status	1 .. 1 ds:DeclarationIdentificationIDType collapse an..35 Reference R
schemeID	Type Use WhiteSpace	xs:token optional collapse
schemeAgencyID	Type Length Use WhiteSpace	clm63055:AgencyIdentificationCodeContentType 1 .. 3 optional collapse
TypeCode	Occurrence Type WhiteSpace Format eTIR name Code List Status	1 .. 1 ds:DeclarationTypeCodeType collapse an..3 Type, coded CL06 Document name code R
listID	Type Use WhiteSpace	xs:token optional collapse
listAgencyID	Type Length Use WhiteSpace	clm63055:AgencyIdentificationCodeContentType 1 .. 3 optional collapse
TotalGrossMassMeasure	Occurrence Type Format eTIR name Status	0 .. 1 ds:DeclarationTotalGrossMassMeasureType n..16,6 Total gross weight O
unitCode	Type Length Use WhiteSpace	clm6Recommendation20: MeasurementUnitCommonCodeContentType 1 .. 3 required collapse

AdditionalInformation	Occurrence	1 .. 1
	eTIR name	AdditionalInformation
	Status	R
xs:sequence	Occurrence	1 .. 1
Content	Occurrence	0 .. 1
	Type	ds:AdditionalInformationContentTextType
	Format	an..512
	eTIR name	Remarks
	Status	R
<i>languageID</i>	Type	xs:language
	Use	optional
	Pattern	([a-zA-Z]{2} [il]-[a-zA-Z]+[xX]-[a-zA-Z]{1,8})-(a-zA-Z){1,8)*
	WhiteSpace	collapse
StatementCode	Occurrence	0 .. 1
	Type	ds:AdditionalInformationStatementCodeType
	WhiteSpace	collapse
	Format	an..17
	eTIR name	Heavy and bulky goods indicator
	Code List	CL14 Indicator
	Status	R
<i>listID</i>	Type	xs:token
	Use	optional
	WhiteSpace	collapse
<i>listAgencyID</i>	Type	clm63055:AgencyIdentificationCodeContentType
	Length	1 .. 3
	Use	optional
	WhiteSpace	collapse
Agent	Occurrence	0 .. unbounded
	eTIR name	Agent
	Status	O
xs:sequence	Occurrence	1 .. 1
ID	Occurrence	1 .. 1
	Type	ds:AgentIdentificationIDType
	WhiteSpace	collapse
	Format	an..17
	eTIR name	Code
	Status	R
<i>schemeID</i>	Type	xs:token
	Use	optional
	WhiteSpace	collapse
<i>schemeAgencyID</i>	Type	clm63055:AgencyIdentificationCodeContentType
	Length	1 .. 3
	Use	optional
	WhiteSpace	collapse
RoleCode	Occurrence	1 .. 1
	Type	ds:AgentRoleCodeType
	WhiteSpace	collapse
	Format	an..3
	Code List	CL02 Party role codes
	eTIR name	Role, coded
	Status	R
<i>listID</i>	Type	xs:token
	Use	optional
	WhiteSpace	collapse
<i>listAgencyID</i>	Type	clm63055:AgencyIdentificationCodeContentType
	Length	1 .. 3
	Use	optional
	WhiteSpace	collapse
Amendment	Occurrence	0 .. unbounded
	eTIR name	Amendment
	Status	O
xs:sequence	Occurrence	1 .. 1

ChangeReasonCode	Occurrence	1 .. 1
	Type	ds:AmendmentChangeReasonCodeType
	WhiteSpace	collapse
	Format	an..3
	eTIR name	Amendment code
	Code List	CL17 Amendment code
	Status	R
listID	Type	xs:token
	Use	optional
	WhiteSpace	collapse
listAgencyID	Type	clm63055:AgencyIdentificationCodeContentType
	Length	1 .. 3
	Use	optional
	WhiteSpace	collapse
Pointer	Occurrence	1 .. unbounded
	eTIR name	Pointer
	Status	R
xs:sequence	Occurrence	1 .. 1
SequenceNumeric	Occurrence	1 .. 1
	Type	ds:PointerSequenceNumericType
	Format	n..5
	eTIR name	Sequence number
	Status	R
DocumentSectionCode	Occurrence	1 .. 1
	Type	ds:PointerDocumentSectionCodeType
	WhiteSpace	collapse
	Format	an..3
	eTIR name	Document/message section, coded
	Code List	CL18 Message section code (codes to be defined)
	Status	R
listID	Type	xs:token
	Use	optional
	WhiteSpace	collapse
listAgencyID	Type	clm63055:AgencyIdentificationCodeContentType
	Length	1 .. 3
	Use	optional
	WhiteSpace	collapse
TagID	Occurrence	1 .. 1
	Type	ds:PointerTagIDType
	WhiteSpace	collapse
	Format	an..4
	eTIR name	Tag identifier
	Code List	CL19 Pointer code (codes to be defined)
	Status	R
schemeID	Type	xs:token
	Use	optional
	WhiteSpace	collapse
schemeAgencyID	Type	clm63055:AgencyIdentificationCodeContentType
	Length	1 .. 3
	Use	optional
	WhiteSpace	collapse
Carrier	Occurrence	0 .. 1
	eTIR name	SubContractor
	Status	O
xs:sequence	Occurrence	1 .. 1
Name	Occurrence	0 .. 1
	Type	ds:CarrierNameTextType
	Format	an..70
	eTIR name	Name
	Status	D
	Condition	C001

<i>languageID</i>	Type Use Pattern WhiteSpace	xs:language optional ([a-zA-Z]{2} [iI]-[a-zA-Z]+ [xX]-[a-zA-Z]{1,8})-[a-zA-Z]{1,8})*	
ID	Occurrence Type WhiteSpace Format eTIR name Code List Status Condition	0 .. 1 ds:CarrierIdentificationIDType collapse an..17 Code CL15 D C001	International TIR database
<i>schemeID</i>	Type Use WhiteSpace	xs:token optional collapse	
<i>schemeAgencyID</i>	Type Length Use WhiteSpace	clm63055:AgencyIdentificationCodeContentType 1 .. 3 optional collapse	
Address	Occurrence eTIR name Status Condition	0 .. unbounded Address D C001	
<i>xs:sequence</i>	Occurrence	1 .. 1	
CityName	Occurrence Type Format eTIR name Status	1 .. 1 ds:AddressCityNameTextType an..35 City name R	
<i>languageID</i>	Type Use Pattern WhiteSpace	xs:language optional ([a-zA-Z]{2} [iI]-[a-zA-Z]+ [xX]-[a-zA-Z]{1,8})-[a-zA-Z]{1,8})*	
CountryCode	Occurrence Type WhiteSpace Format Code List eTIR name Status	1 .. 1 ds:AddressCountryCodeType collapse a2 CL04 Country, coded R	Country name code
<i>listID</i>	Type Use WhiteSpace	xs:token optional collapse	
<i>listAgencyID</i>	Type Length Use WhiteSpace	clm63055:AgencyIdentificationCodeContentType 1 .. 3 optional collapse	
Line	Occurrence Type Format eTIR name Status	1 .. 1 ds:AddressLineTextType an..70 Street and number/P.O. Box R	
<i>languageID</i>	Type Use Pattern WhiteSpace	xs:language optional ([a-zA-Z]{2} [iI]-[a-zA-Z]+ [xX]-[a-zA-Z]{1,8})-[a-zA-Z]{1,8})*	
PostcodeID	Occurrence Type WhiteSpace Format eTIR name Status	1 .. 1 ds:AddressPostcodeIDType collapse an..9 Postcode identification R	

<ul style="list-style-type: none"> └ <i>schemeID</i> 	<p>Type xs:token Use optional WhiteSpace collapse</p>
<ul style="list-style-type: none"> └ <i>schemeAgencyID</i> 	<p>Type clm63055:AgencyIdentificationCodeContentType Length 1 .. 3 Use optional WhiteSpace collapse</p>
<p>Consignment</p>	<p>Occurrence 1 .. unbounded Status R Rule R007 eTIR name Consignment</p>
<ul style="list-style-type: none"> └ xs:sequence └ SequenceNumeric 	<p>Occurrence 1 .. 1 Occurrence 1 .. 1 Type ds:ConsignmentSequenceNumericType Format n..5 eTIR name Sequence number Status R</p>
<ul style="list-style-type: none"> └ AdditionalDocument 	<p>Occurrence 0 .. unbounded Remark Also needed for EX1, not in Objectteering eTIR name AttachedDocuments Status O</p>
<ul style="list-style-type: none"> └ xs:sequence └ IssueDateTime 	<p>Occurrence 1 .. 1 Occurrence 1 .. 1 Type ds:AdditionalDocumentIssueDateTimeType WhiteSpace collapse Format an..17 eTIR name Issuing date Status R</p>
<ul style="list-style-type: none"> └ <i>formatCode</i> 	<p>Type clm62379:DateTimePeriodFormatCode Length 1 .. 3 Use required WhiteSpace collapse Name Date or time or period format code Description Code specifying the representation of a date, time or period.</p>
	<p>Applicable Codes</p>
	<p>102 CCYYMMDD Calendar date: C = Century ; Y = Year ; M = Month ; D = Day.</p>
	<p>304 CCYYMMDDHHMMSSZZ See 204 plus Z=Time zone.</p>
	<p>602 CCYY Calendar year including century: C = Century; Y = Year.</p>
<ul style="list-style-type: none"> └ ID 	<p>Occurrence 1 .. 1 Type ds:AdditionalDocumentIdentificationIDType WhiteSpace collapse Format an..35 eTIR name Number Status R</p>
<ul style="list-style-type: none"> └ <i>schemeID</i> 	<p>Type xs:token Use optional WhiteSpace collapse</p>
<ul style="list-style-type: none"> └ <i>schemeAgencyID</i> 	<p>Type clm63055:AgencyIdentificationCodeContentType Length 1 .. 3 Use optional WhiteSpace collapse</p>
<ul style="list-style-type: none"> └ TypeCode 	<p>Occurrence 1 .. 1 Type ds:AdditionalDocumentTypeCodeType WhiteSpace collapse Format an..3 eTIR name Type, coded Code List 06 Document name code Status R</p>
<ul style="list-style-type: none"> └ <i>listID</i> 	<p>Type xs:token Use optional WhiteSpace collapse</p>

<i>listAgencyID</i>	Type	clm63055:AgencyIdentificationCodeContentType
	Length	1 .. 3
	Use	optional
	WhiteSpace	collapse
ConsignmentItem	Occurrence	1 .. unbounded
	eTIR name	ConsignmentItem
	Status	R
<i>xs:sequence</i>	Occurrence	1 .. 1
SequenceNumeric	Occurrence	0 .. 1
	Type	ds:ConsignmentItemSequenceNumericType
	Format	n..5
	eTIR name	Sequence number
	Status	R
AdditionalInformation	Occurrence	0 .. unbounded
	eTIR name	AdditionalInformation
	Status	O
<i>xs:sequence</i>	Occurrence	1 .. 1
Content	Occurrence	1 .. 1
	Type	ds:AdditionalInformationContentTextType
	Format	an..512
	eTIR name	Remarks
	Status	R
<i>languageID</i>	Type	xs:language
	Use	optional
	Pattern	([a-zA-Z]{2} [iI]-[a-zA-Z]+ [xX]-[a-zA-Z]{1,8})-[a-zA-Z]{1,8})*
	WhiteSpace	collapse
Commodity	Occurrence	1 .. 1
	eTIR name	Goods
	Status	R
<i>xs:sequence</i>	Occurrence	1 .. 1
CargoDescription	Occurrence	0 .. 1
	Type	ds:CommodityCargoDescriptionTextType
	Format	an..256
	eTIR name	Description
	Status	D
	Condition	C004
<i>languageID</i>	Type	xs:language
	Use	optional
	Pattern	([a-zA-Z]{2} [iI]-[a-zA-Z]+ [xX]-[a-zA-Z]{1,8})-[a-zA-Z]{1,8})*
	WhiteSpace	collapse
Classification	Occurrence	0 .. unbounded
	eTIR name	Classification
	Status	O
<i>xs:sequence</i>	Occurrence	1 .. 1
ID	Occurrence	1 .. 1
	Type	ds:ClassificationIdentificationIDType
	WhiteSpace	collapse
	Format	an..18
	eTIR name	Code
	Status	R
<i>schemeID</i>	Type	xs:token
	Use	optional
	WhiteSpace	collapse
<i>schemeAgencyID</i>	Type	clm63055:AgencyIdentificationCodeContentType
	Length	1 .. 3
	Use	optional
	WhiteSpace	collapse
IdentificationTypeCode	Occurrence	1 .. 1
	Type	ds:ClassificationIdentificationTypeCodeType
	WhiteSpace	collapse
	Format	an..3
	eTIR name	Type
	Code List	CL03 Item type identification code

		Status	R
		Type	xs:token
		Use	optional
		WhiteSpace	collapse
	<i>listID</i>		
		Type	clm63055:AgencyIdentificationCodeContentType
		Length	1 .. 3
		Use	optional
		WhiteSpace	collapse
	Consignee	Occurrence	0 .. 1
		eTIR name	Consignee
		Status	O
		Occurrence	1 .. 1
	xs:sequence	Occurrence	0 .. 1
	Name	Type	ds:ConsigneeNameTextType
		Format	an..70
		eTIR name	Name
		Status	D
		Condition	C001
		Type	xs:language
		Use	optional
		Pattern	([a-zA-Z]{2})[iI]-[a-zA-Z]+[xX]-[a-zA-Z]{1,8})-([a-zA-Z]{1,8})*
		WhiteSpace	collapse
		Occurrence	0 .. 1
		Type	ds:ConsigneeIdentificationIDType
		WhiteSpace	collapse
		Format	an..17
		eTIR name	Code
		Status	D
		Condition	C001
		Type	xs:token
		Use	optional
		WhiteSpace	collapse
	<i>schemeID</i>		
		Type	clm63055:AgencyIdentificationCodeContentType
		Length	1 .. 3
		Use	optional
		WhiteSpace	collapse
	<i>schemeAgencyID</i>		
		Occurrence	0 .. unbounded
		eTIR name	Address
		Status	D
		Condition	C001
		Occurrence	1 .. 1
	xs:sequence	Occurrence	1 .. 1
	CityName	Type	ds:AddressCityNameTextType
		Format	an..35
		eTIR name	City name
		Status	R
		Type	xs:language
		Use	optional
		Pattern	([a-zA-Z]{2})[iI]-[a-zA-Z]+[xX]-[a-zA-Z]{1,8})-([a-zA-Z]{1,8})*
		WhiteSpace	collapse
		Occurrence	1 .. 1
		Type	ds:AddressCountryCodeType
		WhiteSpace	collapse
		Format	a2
		Code List	CL04 Country name code
		eTIR name	Country, coded
		Status	R
		Type	xs:token
		Use	optional
		WhiteSpace	collapse
	<i>listID</i>		

<i>listAgencyID</i>	Type	clm63055:AgencyIdentificationCodeContentType
	Length	1 .. 3
	Use	optional
	WhiteSpace	collapse
Line	Occurrence	1 .. 1
	Type	ds:AddressLineTextType
	Format	an..70
	eTIR name	Street and number/P.O. Box
	Status	R
<i>languageID</i>	Type	xs:language
	Use	optional
	Pattern	([a-zA-Z]{2} [iI]-[a-zA-Z]+ [xX]-[a-zA-Z]{1,8})-[a-zA-Z]{1,8})*
	WhiteSpace	collapse
PostcodeID	Occurrence	1 .. 1
	Type	ds:AddressPostcodeIDType
	WhiteSpace	collapse
	Format	an..9
	eTIR name	Postcode identification
	Status	R
<i>schemeID</i>	Type	xs:token
	Use	optional
	WhiteSpace	collapse
<i>schemeAgencyID</i>	Type	clm63055:AgencyIdentificationCodeContentType
	Length	1 .. 3
	Use	optional
	WhiteSpace	collapse
Consignor	Occurrence	0 .. 1
	eTIR name	Consignor
	Status	O
<i>xs:sequence</i>	Occurrence	1 .. 1
Name	Occurrence	0 .. 1
	Type	ds:ConsignorNameTextType
	Format	an..70
	eTIR name	Name
	Status	D
	Condition	C001
<i>languageID</i>	Type	xs:language
	Use	optional
	Pattern	([a-zA-Z]{2} [iI]-[a-zA-Z]+ [xX]-[a-zA-Z]{1,8})-[a-zA-Z]{1,8})*
	WhiteSpace	collapse
ID	Occurrence	0 .. 1
	Type	ds:ConsignorIdentificationIDType
	WhiteSpace	collapse
	Format	an..17
	eTIR name	Code
	Status	D
	Condition	C001
<i>schemeID</i>	Type	xs:token
	Use	optional
	WhiteSpace	collapse
<i>schemeAgencyID</i>	Type	clm63055:AgencyIdentificationCodeContentType
	Length	1 .. 3
	Use	optional
	WhiteSpace	collapse
Address	Occurrence	0 .. unbounded
	eTIR name	Address
	Status	D
	Condition	C001
<i>xs:sequence</i>	Occurrence	1 .. 1
CityName	Occurrence	1 .. 1
	Type	ds:AddressCityNameTextType
	Format	an..35
	eTIR name	City name

	<i>languageID</i>	<p>Status R</p> <p>Type xs:language</p> <p>Use optional</p> <p>Pattern ([a-zA-Z]{2} [iI]-[a-zA-Z]+ [xX]-[a-zA-Z]{1,8})-[a-zA-Z]{1,8)*</p> <p>WhiteSpace collapse</p>
	CountryCode	<p>Occurrence 1 .. 1</p> <p>Type ds:AddressCountryCodeType</p> <p>WhiteSpace collapse</p> <p>Format a2</p> <p>Code List CL04 Country name code</p> <p>eTIR name Country, coded</p> <p>Status R</p>
	<i>listID</i>	<p>Type xs:token</p> <p>Use optional</p> <p>WhiteSpace collapse</p>
	<i>listAgencyID</i>	<p>Type clm63055:AgencyIdentificationCodeContentType</p> <p>Length 1 .. 3</p> <p>Use optional</p> <p>WhiteSpace collapse</p>
	Line	<p>Occurrence 1 .. 1</p> <p>Type ds:AddressLineTextType</p> <p>Format an..70</p> <p>eTIR name Street and number/P.O. Box</p> <p>Status R</p>
	<i>languageID</i>	<p>Type xs:language</p> <p>Use optional</p> <p>Pattern ([a-zA-Z]{2} [iI]-[a-zA-Z]+ [xX]-[a-zA-Z]{1,8})-[a-zA-Z]{1,8)*</p> <p>WhiteSpace collapse</p>
	PostcodeID	<p>Occurrence 1 .. 1</p> <p>Type ds:AddressPostcodeIDType</p> <p>WhiteSpace collapse</p> <p>Format an..9</p> <p>eTIR name Postcode identification</p> <p>Status R</p>
	<i>schemeID</i>	<p>Type xs:token</p> <p>Use optional</p> <p>WhiteSpace collapse</p>
	<i>schemeAgencyID</i>	<p>Type clm63055:AgencyIdentificationCodeContentType</p> <p>Length 1 .. 3</p> <p>Use optional</p> <p>WhiteSpace collapse</p>
	DeliveryDestination	<p>Occurrence 0 .. 1</p> <p>eTIR name DeliveryDestination</p> <p>Status O</p>
	xs:sequence	
	Name	<p>Occurrence 1 .. 1</p> <p>Type ds:DeliveryDestinationNameTextType</p> <p>Format an..70</p> <p>eTIR name Name</p> <p>Status R</p>
	<i>languageID</i>	<p>Type xs:language</p> <p>Use optional</p> <p>Pattern ([a-zA-Z]{2} [iI]-[a-zA-Z]+ [xX]-[a-zA-Z]{1,8})-[a-zA-Z]{1,8)*</p> <p>WhiteSpace collapse</p>
	Address	<p>Occurrence 1 .. 1</p> <p>eTIR name Address</p> <p>Status R</p>
	xs:sequence	
	CityName	<p>Occurrence 1 .. 1</p> <p>Type ds:AddressCityNameTextType</p> <p>Format an..35</p> <p>eTIR name City name</p>

					Status	R
					Type	xs:language
					Use	optional
					Pattern	([a-zA-Z]{2} [il]-[a-zA-Z]+ [xX]-[a-zA-Z]{1,8})-[a-zA-Z]{1,8)*
					WhiteSpace	collapse
				CountryCode	Occurrence	1 .. 1
					Type	ds:AddressCountryCodeType
					WhiteSpace	collapse
					Format	a2
					Code List	CL04 Country name code
					eTIR name	Country, coded
					Status	R
				listID	Type	xs:token
					Use	optional
					WhiteSpace	collapse
				listAgencyID	Type	clm63055:AgencyIdentificationCodeContentType
					Length	1 .. 3
					Use	optional
					WhiteSpace	collapse
				Line	Occurrence	1 .. 1
					Type	ds:AddressLineTextType
					Format	an..70
					eTIR name	Street and number/P.O. Box
					Status	R
				languageID	Type	xs:language
					Use	optional
					Pattern	([a-zA-Z]{2} [il]-[a-zA-Z]+ [xX]-[a-zA-Z]{1,8})-[a-zA-Z]{1,8)*
					WhiteSpace	collapse
				PostcodeID	Occurrence	1 .. 1
					Type	ds:AddressPostcodeIDType
					WhiteSpace	collapse
					Format	an..9
					eTIR name	Postcode identification
					Status	R
				schemeID	Type	xs:token
					Use	optional
					WhiteSpace	collapse
				schemeAgencyID	Type	clm63055:AgencyIdentificationCodeContentType
					Length	1 .. 3
					Use	optional
					WhiteSpace	collapse
				GoodsMeasure	Occurrence	1 .. 1
					eTIR name	GoodsMeasure
					Status	R
				xs:sequence	Occurrence	1 .. 1
				GrossMassMeasure	Occurrence	1 .. 1
					Type	ds:GoodsMeasureGrossMassMeasureType
					Format	n..16,6
					eTIR name	Gross weight
					Status	R
				unitCode	Type	clm6Recommendation20:MeasurementUnitCommonCodeContentType
					Length	1 .. 3
					Use	required
					WhiteSpace	collapse
				Packaging	Occurrence	1 .. 1
					eTIR name	Packaging
					Status	R
				xs:sequence	Occurrence	1 .. 1
				MarksNumbersID	Occurrence	1 .. 1
					Type	ds:PackagingMarksNumbersIDType
					WhiteSpace	collapse
					Format	an..512

		eTIR name	Marks and numbers
		Status	R
		Type	xs:token
		Use	optional
		WhiteSpace	collapse
	<i>schemeID</i>		
		Type	clm63055:AgencyIdentificationCodeContentType
		Length	1 .. 3
		Use	optional
		WhiteSpace	collapse
	QuantityQuantity	Occurrence	1 .. 1
		Type	ds:PackagingQuantityQuantityType
		Format	n..8
		eTIR name	Number of packages
		Status	R
		Type	clm6Recommendation20:MeasurementUnitCommonCodeContentType
		Length	1 .. 3
		Use	required
		WhiteSpace	collapse
	<i>unitCode</i>		
		Occurrence	1 .. 1
		Type	ds:PackagingTypeCodeType
		WhiteSpace	collapse
		Format	an..2
		eTIR name	Type, coded
		Code List	CL07 Package type description code
		Status	R
		Type	xs:token
		Use	optional
		WhiteSpace	collapse
	<i>listID</i>		
		Type	clm63055:AgencyIdentificationCodeContentType
		Length	1 .. 3
		Use	optional
		WhiteSpace	collapse
	<i>listAgencyID</i>		
		Occurrence	0 .. 1
		eTIR name	TransportEquipment
		Status	D
		Condition	C003
	TransportEquipment	Occurrence	1 .. 1
		Occurrence	1 .. 1
		Type	ds:TransportEquipmentIdentificationIDType
		WhiteSpace	collapse
		Format	an..17
		eTIR name	Identification
		Status	R
		Type	xs:token
		Use	optional
		WhiteSpace	collapse
	<i>xs:sequence</i>		
		Type	clm63055:AgencyIdentificationCodeContentType
		Length	1 .. 3
		Use	optional
		WhiteSpace	collapse
	<i>ID</i>		
		Occurrence	0 .. unbounded
		eTIR name	UCR
		Status	O
		Occurrence	1 .. 1
		Occurrence	1 .. 1
		Type	ds:UCRIdentificationIDType
		WhiteSpace	collapse
		Format	an..35
		eTIR name	Identifier
		Status	R
		Type	xs:token
		Use	optional
		WhiteSpace	collapse
	<i>schemeID</i>		

└─ <i>schemeAgencyID</i>	Type	clm63055:AgencyIdentificationCodeContentType
	Length	1 .. 3
	Use	optional
	WhiteSpace	collapse
LoadingLocation	Occurrence	0 .. 1
	eTIR name	LoadingLocation
	Status	O
└─ xs:sequence	Occurrence	1 .. 1
└─ Name	Occurrence	1 .. 1
	Type	ds>LoadingLocationNameTextType
	Format	an..256
	eTIR name	Name
	Status	R
└─ <i>languageID</i>	Type	xs:language
	Use	optional
	Pattern	([a-zA-Z]{2} [iI]-[a-zA-Z]+ [xX]-[a-zA-Z]{1,8})-[a-zA-Z]{1,8})*
	WhiteSpace	collapse
NotifyParty	Occurrence	0 .. 1
	eTIR name	NotifyParty
	Status	O
└─ xs:sequence	Occurrence	1 .. 1
└─ Name	Occurrence	0 .. 1
	Type	ds>NotifyPartyNameTextType
	Format	an..70
	eTIR name	Name
	Status	D
	Condition	C001
└─ <i>languageID</i>	Type	xs:language
	Use	optional
	Pattern	([a-zA-Z]{2} [iI]-[a-zA-Z]+ [xX]-[a-zA-Z]{1,8})-[a-zA-Z]{1,8})*
	WhiteSpace	collapse
ID	Occurrence	0 .. 1
	Type	ds>NotifyPartyIdentificationIDType
	WhiteSpace	collapse
	Format	an..17
	eTIR name	Code
	Status	D
	Condition	C001
└─ <i>schemeID</i>	Type	xs:token
	Use	optional
	WhiteSpace	collapse
└─ <i>schemeAgencyID</i>	Type	clm63055:AgencyIdentificationCodeContentType
	Length	1 .. 3
	Use	optional
	WhiteSpace	collapse
Address	Occurrence	0 .. 1
	eTIR name	Address
	Status	D
	Condition	C001
└─ xs:sequence	Occurrence	1 .. 1
└─ CityName	Occurrence	1 .. 1
	Type	ds>AddressCityNameTextType
	Format	an..35
	eTIR name	City name
	Status	R
└─ <i>languageID</i>	Type	xs:language
	Use	optional
	Pattern	([a-zA-Z]{2} [iI]-[a-zA-Z]+ [xX]-[a-zA-Z]{1,8})-[a-zA-Z]{1,8})*
	WhiteSpace	collapse
CountryCode	Occurrence	1 .. 1
	Type	ds>AddressCountryCodeType
	WhiteSpace	collapse

		Format	a2	
		Code List	CL04	Country name code
		eTIR name	Country, coded	
		Status	R	
	<i>listID</i>	Type	xs:token	
		Use	optional	
		WhiteSpace	collapse	
	<i>listAgencyID</i>	Type	clm63055:AgencyIdentificationCodeContentType	
		Length	1 .. 3	
		Use	optional	
		WhiteSpace	collapse	
	Line	Occurrence	1 .. 1	
		Type	ds:AddressLineTextType	
		Format	an..70	
		eTIR name	Street and number/P.O. Box	
		Status	R	
	<i>languageID</i>	Type	xs:language	
		Use	optional	
		Pattern	([a-zA-Z]{2} [iI]-[a-zA-Z]+ [xX]-[a-zA-Z]{1,8})-([a-zA-Z]{1,8})*	
		WhiteSpace	collapse	
	PostcodeID	Occurrence	1 .. 1	
		Type	ds:AddressPostcodeIDType	
		WhiteSpace	collapse	
		Format	an..9	
		eTIR name	Postcode identification	
		Status	R	
	<i>schemeID</i>	Type	xs:token	
		Use	optional	
		WhiteSpace	collapse	
	<i>schemeAgencyID</i>	Type	clm63055:AgencyIdentificationCodeContentType	
		Length	1 .. 3	
		Use	optional	
		WhiteSpace	collapse	
	TransitDeparture	Occurrence	1 .. 1	
		eTIR name	CustomsOfficeOfDeparture	
		Status	R	
	<i>xs:sequence</i>	Occurrence	1 .. 1	
	ID	Occurrence	1 .. 1	
		Type	ds:TransitDepartureIdentificationIDType	
		WhiteSpace	collapse	
		Format	an..17	
		eTIR name	Code	
		Code List	CL13	Customs offices database (to be developed)
		Status	R	
	<i>schemeID</i>	Type	xs:token	
		Use	optional	
		WhiteSpace	collapse	
	<i>schemeAgencyID</i>	Type	clm63055:AgencyIdentificationCodeContentType	
		Length	1 .. 3	
		Use	optional	
		WhiteSpace	collapse	
	TransitDestination	Occurrence	1 .. 1	
		eTIR name	CustomsOfficeOfDestination	
		Status	R	
	<i>xs:sequence</i>	Occurrence	1 .. 1	
	ID	Occurrence	1 .. 1	
		Type	ds:TransitDestinationIdentificationIDType	
		WhiteSpace	collapse	
		Format	an..17	
		eTIR name	Code	
		Code List	CL13	Customs offices database (to be developed)
		Status	R	

<i>schemeID</i>	Type Use WhiteSpace	xs:token optional collapse
<i>schemeAgencyID</i>	Type Length Use WhiteSpace	clm63055:AgencyIdentificationCodeContentType 1 .. 3 optional collapse
TransitTransportMeans	Occurrence eTIR name Status	1 .. unbounded TransportMeans R
xs:sequence	Occurrence	1 .. 1
ID	Occurrence Type WhiteSpace Format eTIR name Status	1 .. 1 ds:TransitTransportMeansIdentificationIDType collapse an..25 Identification R
<i>schemeID</i>	Type Use WhiteSpace	xs:token optional collapse
<i>schemeAgencyID</i>	Type Length Use WhiteSpace	clm63055:AgencyIdentificationCodeContentType 1 .. 3 optional collapse
TypeCode	Occurrence Type WhiteSpace Format eTIR name Code List Status	1 .. 1 ds:TransitTransportMeansTypeCodeType collapse an..4 Type, coded CL05 Transport means description code R
<i>listID</i>	Type Use WhiteSpace	xs:token optional collapse
<i>listAgencyID</i>	Type Length Use WhiteSpace	clm63055:AgencyIdentificationCodeContentType 1 .. 3 optional collapse
RegistrationNationalityCode	Occurrence Type WhiteSpace Format eTIR name Code List Status	1 .. 1 ds: TransitTransportMeansRegistrationNationalityCodeType collapse a2 Nationality CL04 Country name code R
<i>listID</i>	Type Use WhiteSpace	xs:token optional collapse
<i>listAgencyID</i>	Type Length Use WhiteSpace	clm63055:AgencyIdentificationCodeContentType 1 .. 3 optional collapse
JourneyID	Occurrence Type WhiteSpace Format eTIR name Status	0 .. 1 ds:TransitTransportMeansJourneyIDType collapse an..17 Conveyance reference number O
<i>schemeID</i>	Type Use WhiteSpace	xs:token optional collapse

<ul style="list-style-type: none"> └─ <i>schemeAgencyID</i> 	<p>Type clm63055:AgencyIdentificationCodeContentType Length 1 .. 3 Use optional WhiteSpace collapse</p>
<ul style="list-style-type: none"> └─ Itinerary 	<p>Occurrence 1 .. unbounded eTIR name CountryOfRouting Rule R001 Status R</p>
<ul style="list-style-type: none"> └─ xs:sequence <ul style="list-style-type: none"> └─ SequenceNumeric 	<p>Occurrence 1 .. 1 Occurrence 1 .. 1 Type ds:ItinerarySequenceNumericType Format n..5 Status R</p>
<ul style="list-style-type: none"> └─ RoutingCountryCode 	<p>Occurrence 1 .. 1 Type ds:ItineraryRoutingCountryCodeType WhiteSpace collapse Format a2 eTIR name Country, coded Code List CL04 Country name code Status R</p>
<ul style="list-style-type: none"> └─ <i>listID</i> 	<p>Type xs:token Use optional WhiteSpace collapse</p>
<ul style="list-style-type: none"> └─ <i>listAgencyID</i> 	<p>Type clm63055:AgencyIdentificationCodeContentType Length 1 .. 3 Use optional WhiteSpace collapse</p>
<ul style="list-style-type: none"> └─ AdditionalDocument 	<p>Occurrence 0 .. 1 eTIR name CertificateOfApproval Status O</p>
<ul style="list-style-type: none"> └─ xs:sequence <ul style="list-style-type: none"> └─ IssueDateTime 	<p>Occurrence 1 .. 1 Type ds:AdditionalDocumentIssueDateTimeType WhiteSpace collapse Format an..17 eTIR name Date Status R</p>
<ul style="list-style-type: none"> └─ <i>formatCode</i> 	<p>Type clm62379:DateTimePeriodFormatCode Length 1 .. 3 Use required WhiteSpace collapse Name Date or time or period format code Description Code specifying the representation of a date, time or period.</p>
Applicable Codes	
	<p>102 CCYYMMDD Calendar date: C = Century ; Y = Year ; M = Month ; D = Day.</p>
	<p>304 CCYYMMDDHHMMSSZZ See 204 plus Z=Time zone.</p>
	<p>602 CCYY Calendar year including century: C = Century; Y = Year.</p>
<ul style="list-style-type: none"> └─ ID 	<p>Occurrence 1 .. 1 Type ds:AdditionalDocumentIdentificationIDType WhiteSpace collapse Format an..35 eTIR name Number Status R</p>
<ul style="list-style-type: none"> └─ <i>schemeID</i> 	<p>Type xs:token Use optional WhiteSpace collapse</p>
<ul style="list-style-type: none"> └─ <i>schemeAgencyID</i> 	<p>Type clm63055:AgencyIdentificationCodeContentType Length 1 .. 3 Use optional WhiteSpace collapse</p>

TypeCode	Occurrence 1 .. 1 Type ds:AdditionalDocumentTypeCodeType WhiteSpace collapse Format an..3 eTIR name Type, coded Code List CL06 Document name code Status R
<i>listID</i>	Type xs:token Use optional WhiteSpace collapse
<i>listAgencyID</i>	Type clm63055:AgencyIdentificationCodeContentType Length 1 .. 3 Use optional WhiteSpace collapse
TransportEquipment	Occurrence 0 .. unbounded eTIR name TransportEquipment Status D Condition C003
xs:sequence	Occurrence 1 .. 1
SequenceNumeric	Occurrence 1 .. 1 Type ds:TransportEquipmentSequenceNumericType Format n..5 eTIR name Sequence number Status R
CharacteristicCode	Occurrence 1 .. 1 Type ds:TransportEquipmentCharacteristicCodeType WhiteSpace collapse Format an..4 eTIR name Size and type identification Code List CL01 Equipment size and type description code Status R
<i>listID</i>	Type xs:token Use optional WhiteSpace collapse
<i>listAgencyID</i>	Type clm63055:AgencyIdentificationCodeContentType Length 1 .. 3 Use optional WhiteSpace collapse
ID	Occurrence 1 .. 1 Type ds:TransportEquipmentIdentificationIDType WhiteSpace collapse Format an..17 eTIR name Identification Status R
<i>schemeID</i>	Type xs:token Use optional WhiteSpace collapse
<i>schemeAgencyID</i>	Type clm63055:AgencyIdentificationCodeContentType Length 1 .. 3 Use optional WhiteSpace collapse
Seal	Occurrence 0 .. unbounded eTIR name Seal Status O
xs:sequence	Occurrence 1 .. 1
SequenceNumeric	Occurrence 1 .. 1 Type ds:SealSequenceNumericType Format n..5 eTIR name Sequence number Status R Rule R003 Rule R004
ID	Occurrence 1 .. 1 Type ds:SealIdentificationIDType WhiteSpace collapse

		Format	an..35
		eTIR name	Seal number
		Status	R
		Rule	R005
	<i>schemeID</i>	Type	xs:token
		Use	optional
		WhiteSpace	collapse
	<i>schemeAgencyID</i>	Type	clm63055:AgencyIdentificationCodeContentType
		Length	1 .. 3
		Use	optional
		WhiteSpace	collapse
	TypeCode	Occurrence	0 .. 1
		Type	ds:SealTypeCodeType
		WhiteSpace	collapse
		Format	an..3
		eTIR name	Seal type code
		Status	O
	<i>listID</i>	Type	xs:token
		Use	optional
		WhiteSpace	collapse
	<i>listAgencyID</i>	Type	clm63055:AgencyIdentificationCodeContentType
		Length	1 .. 3
		Use	optional
		WhiteSpace	collapse
	TransitPrincipal	Occurrence	1 .. 1
		eTIR name	Holder
		Status	R
	<i>xs:sequence</i>	Occurrence	1 .. 1
	Name	Occurrence	0 .. 1
		Type	ds:TransitPrincipalNameTextType
		Format	an..70
		eTIR name	Name
		Status	O
	<i>languageID</i>	Type	xs:language
		Use	optional
		Pattern	([a-zA-Z]{2} [iI]-[a-zA-Z]+ [xX]-[a-zA-Z]{1,8})-[a-zA-Z]{1,8)*
		WhiteSpace	collapse
	ID	Occurrence	1 .. 1
		Type	ds:TransitPrincipalIdentificationIDType
		WhiteSpace	collapse
		Format	an..17
		eTIR name	Code
		Code List	CL15 International TIR database
		Status	R
	<i>schemeID</i>	Type	xs:token
		Use	optional
		WhiteSpace	collapse
	<i>schemeAgencyID</i>	Type	clm63055:AgencyIdentificationCodeContentType
		Length	1 .. 3
		Use	optional
		WhiteSpace	collapse
	Address	Occurrence	0 .. 1
		eTIR name	Address
		Status	O
	<i>xs:sequence</i>	Occurrence	1 .. 1
	CityName	Occurrence	1 .. 1
		Type	ds:AddressCityNameTextType
		Format	an..35
		eTIR name	City name
		Status	R

<i>languageID</i>	Type Use Pattern WhiteSpace	xs:language optional ([a-zA-Z]{2} [iI]-[a-zA-Z]+ [xX]-[a-zA-Z]{1,8})-([a-zA-Z]{1,8})* collapse
CountryCode	Occurrence Type WhiteSpace Format Code List eTIR name Status	1 .. 1 ds:AddressCountryCodeType collapse a2 CL04 Country name code Country, coded R
<i>listID</i>	Type Use WhiteSpace	xs:token optional collapse
<i>listAgencyID</i>	Type Length Use WhiteSpace	clm63055:AgencyIdentificationCodeContentType 1 .. 3 optional collapse
Line	Occurrence Type Format eTIR name Status	1 .. 1 ds:AddressLineTextType an..70 Street and number/P.O. Box R
<i>languageID</i>	Type Use Pattern WhiteSpace	xs:language optional ([a-zA-Z]{2} [iI]-[a-zA-Z]+ [xX]-[a-zA-Z]{1,8})-([a-zA-Z]{1,8})* collapse
PostcodeID	Occurrence Type WhiteSpace Format eTIR name Status	1 .. 1 ds:AddressPostcodeIDType collapse an..9 Postcode identification R
<i>schemeID</i>	Type Use WhiteSpace	xs:token optional collapse
<i>schemeAgencyID</i>	Type Length Use WhiteSpace	clm63055:AgencyIdentificationCodeContentType 1 .. 3 optional collapse
DeclarationGuarantee	Occurrence eTIR name Status	1 .. 1 Guarantee R
xs:sequence	Occurrence	1 .. 1
ReferenceID	Occurrence Type WhiteSpace Format eTIR name Status	1 .. 1 ds:DeclarationGuaranteeReferenceIDType collapse an..35 Reference R
<i>schemeID</i>	Type Use WhiteSpace	xs:token optional collapse
<i>schemeAgencyID</i>	Type Length Use WhiteSpace	clm63055:AgencyIdentificationCodeContentType 1 .. 3 optional collapse
LPCOExpirationDateTime	Occurrence Type WhiteSpace Format eTIR name Status	1 .. 1 ds:DeclarationGuaranteeLPCOExpirationDateTimeType collapse n..17 Validity R

<i>formatCode</i>	<p>Type clm62379:DateTimePeriodFormatCode Length 1 .. 3 Use required WhiteSpace collapse Name Date or time or period format code Description Code specifying the representation of a date, time or period.</p> <p>Applicable Codes</p> <p>102 CCYYMMDD Calendar date: C = Century ; Y = Year ; M = Month ; D = Day. 304 CCYYMMDDHHMMSSZZZ See 204 plus Z=Time zone. 602 CCYY Calendar year including century: C = Century; Y = Year.</p>
SecurityDetailsCode	<p>Occurrence 1 .. 1 Type ds:DeclarationGuaranteeSecurityDetailsCodeType WhiteSpace collapse Format an..3 eTIR name Guarantee type, coded Code List CL12 Guarantee type code Status R</p>
<i>listID</i>	<p>Type xs:token Use optional WhiteSpace collapse</p>
<i>listAgencyID</i>	<p>Type clm63055:AgencyIdentificationCodeContentType Length 1 .. 3 Use optional WhiteSpace collapse</p>
Error	<p>Occurrence 0 .. unbounded eTIR name Error Status D Condition C006</p>
xs:sequence	<p>Occurrence 1 .. 1</p>
ValidationCode	<p>Occurrence 1 .. 1 Type ds:ErrorValidationCodeType WhiteSpace collapse Format an..8 eTIR name Error, coded Code List CL99 Error code (to be developed) Status R</p>
<i>listID</i>	<p>Type xs:token Use optional WhiteSpace collapse</p>
<i>listAgencyID</i>	<p>Type clm63055:AgencyIdentificationCodeContentType Length 1 .. 3 Use optional WhiteSpace collapse</p>
Pointer	<p>Occurrence 1 .. unbounded eTIR name Pointer Status R</p>
xs:sequence	<p>Occurrence 1 .. 1</p>
SequenceNumeric	<p>Occurrence 1 .. 1 Type ds:PointerSequenceNumericType Format n..5 eTIR name Sequence number Status R</p>
DocumentSectionCode	<p>Occurrence 1 .. 1 Type ds:PointerDocumentSectionCodeType WhiteSpace collapse Format an..3 eTIR name Document/message section, coded Code List CL18 Message section code (codes to be defined) Status R</p>

<i>listID</i>	Type Use WhiteSpace	xs:token optional collapse
<i>listAgencyID</i>	Type Length Use WhiteSpace	clm63055:AgencyIdentificationCodeContentType 1 .. 3 optional collapse
TagID	Occurrence Type WhiteSpace Format eTIR name Code List Status	1 .. 1 ds:PointerTagIDType collapse an..4 Tag identifier CL19 Pointer code (codes to be defined) R
<i>schemeID</i>	Type Use WhiteSpace	xs:token optional collapse
<i>schemeAgencyID</i>	Type Length Use WhiteSpace	clm63055:AgencyIdentificationCodeContentType 1 .. 3 optional collapse

4.2.3.1.1.7. E7 – Notify guarantee chain

a. Structure

Occurance	Element/Attribute
1 .. 1	Message
1 .. 1	xs:sequence
optional	TypeCode
optional	<i>listID</i>
optional	<i>listAgencyID</i>
1 .. 1	SubTypeCode
optional	<i>listID</i>
optional	<i>listAgencyID</i>
1 .. 1	ReferenceNumberID
optional	<i>schemeID</i>
optional	<i>schemeAgencyID</i>
1 .. 1	FunctionCode
optional	<i>listID</i>
optional	<i>listAgencyID</i>
1 .. 1	Guarantee
1 .. 1	xs:sequence
1 .. 1	ReferenceID
optional	<i>schemeID</i>
optional	<i>schemeAgencyID</i>

b. Guidelines

Element/Attribute	Annotation
Message	eTIR name Message
xs:sequence	Occurrence 1 .. 1
TypeCode	Occurrence 1 .. 1
	Type ds:MessageTypeCodeType
	WhiteSpace collapse
	Format an..3
	eTIR name Type, coded
	Status R
	Code List CL26 Message types

	Restricted code(s)	E7	Notify guarantee chain
<i>listID</i>	Type	xs:token	
	Use	optional	
	WhiteSpace	collapse	
<i>listAgencyID</i>	Type	clm63055:AgencyIdentificationCodeContentType	
	Length	1 .. 3	
	Use	optional	
	WhiteSpace	collapse	
SubTypeCode	Occurrence	1 .. 1	
	Type	ds:MessageSubTypeCodeType	
	WhiteSpace	collapse	
	Format	an..6	
	eTIR name	Sub type, coded	
	Code List	CL09	Message sub type
	Status	R	
	Restricted code(s)	04	New Advanced Cargo Information
	Restricted code(s)	05	Updated Advanced Cargo Information
	Restricted code(s)	06	New start of operation
	Restricted code(s)	07	New termination of operation
	Restricted code(s)	08	New discharge of operation
<i>listID</i>	Type	xs:token	
	Use	optional	
	WhiteSpace	collapse	
<i>listAgencyID</i>	Type	clm63055:AgencyIdentificationCodeContentType	
	Length	1 .. 3	
	Use	optional	
	WhiteSpace	collapse	
ReferenceNumberID	Occurrence	1 .. 1	
	Type	ds:MessageReferenceNumberIDType	
	WhiteSpace	collapse	
	Format	an..14	
	eTIR name	Message reference number	
	Status	R	
<i>schemeID</i>	Type	xs:token	
	Use	optional	
	WhiteSpace	collapse	
<i>schemaAgencyID</i>	Type	clm63055:AgencyIdentificationCodeContentType	
	Length	1 .. 3	
	Use	optional	
	WhiteSpace	collapse	
FunctionCode	Occurrence	1 .. 1	
	Type	ds:MessageFunctionCodeType	
	WhiteSpace	collapse	
	Format	n..2	
	eTIR name	Message function, coded	
	Code List	CL16	Message function code
	Status	R	
	Restricted code(s)	9	Original
<i>listID</i>	Type	xs:token	
	Use	optional	
	WhiteSpace	collapse	
<i>listAgencyID</i>	Type	clm63055:AgencyIdentificationCodeContentType	
	Length	1 .. 3	
	Use	optional	
	WhiteSpace	collapse	
Guarantee	Occurrence	1 .. 1	
	eTIR name	Guarantee	
	Status	R	
xs:sequence	Occurrence	1 .. 1	

ReferenceID	Occurrence 1 .. 1
	Type ds:GuaranteeReferenceIDType
	WhiteSpace collapse
	Format an..35
	eTIR name Reference
	Status R
<i>schemeID</i>	Type xs:token
	Use optional
	WhiteSpace collapse
<i>schemeAgencyID</i>	Type clm63055:AgencyIdentificationCodeContentType
	Length 1 .. 3
	Use optional
	WhiteSpace collapse

4.2.3.1.1.8. E8 – Notification confirmation

a. Structure

Occurance	Element/Attribute
1 .. 1	Message
1 .. 1	xs:sequence
1 .. 1	TypeCode
optional	listID
optional	listAgencyID
1 .. 1	ReferenceNumberID
optional	schemeID
optional	schemeAgencyID
1 .. 1	FunctionCode
optional	listID
optional	listAgencyID
1 .. 1	FunctionalReferenceID
optional	schemeID
optional	schemeAgencyID
1 .. 1	Guarantee
1 .. 1	xs:sequence
1 .. 1	ReferenceID
optional	schemeID
optional	schemeAgencyID
0 .. unbounded	Error
1 .. 1	xs:sequence
1 .. 1	ValidationCode
optional	listID
optional	listAgencyID
1 .. unbounded	Pointer
1 .. 1	xs:sequence
1 .. 1	SequenceNumeric
1 .. 1	DocumentSectionCode
optional	listID
optional	listAgencyID
1 .. 1	TagID
optional	schemeID
optional	schemeAgencyID

b. Guidelines

Element/Attribute	Annotation
Message	
xs:sequence	eTIR name Message
	Occurrence 1 .. 1

TypeCode	Occurrence 1 .. 1 Type ds:MessageTypeCodeType WhiteSpace collapse Format an..3 eTIR name Type, coded Status R Code List CL26 Message types Restricted code(s) E8 Notification confirmation
listID	Type xs:token Use optional WhiteSpace collapse
listAgencyID	Type clm63055:AgencyIdentificationCodeContentType Length 1 .. 3 Use optional WhiteSpace collapse
ReferenceNumberID	Occurrence 1 .. 1 Type ds:MessageReferenceNumberIDType WhiteSpace collapse Format an..14 eTIR name Message reference number Status R
schemeID	Type xs:token Use optional WhiteSpace collapse
schemeAgencyID	Type clm63055:AgencyIdentificationCodeContentType Length 1 .. 3 Use optional WhiteSpace collapse
FunctionCode	Occurrence 1 .. 1 Type ds:MessageFunctionCodeType WhiteSpace collapse Restricted code(s) 11 Response Format n..2 eTIR name Message function, coded Code List CL16 Message function code Status R
listID	Type xs:token Use optional WhiteSpace collapse
listAgencyID	Type clm63055:AgencyIdentificationCodeContentType Length 1 .. 3 Use optional WhiteSpace collapse
FunctionalReferenceID	Occurrence 1 .. 1 Type ds:MessageFunctionalReferenceIDType WhiteSpace collapse Format an..35 eTIR name Functional reference Status R
schemeID	Type xs:token Use optional WhiteSpace collapse
schemeAgencyID	Type clm63055:AgencyIdentificationCodeContentType Length 1 .. 3 Use optional WhiteSpace collapse
Guarantee	Occurrence 1 .. 1 eTIR name Guarantee Status R
xs:sequence	Occurrence 1 .. 1
ReferenceID	Occurrence 1 .. 1 Type ds:GuaranteeReferenceIDType WhiteSpace collapse

	Format	an..35
	eTIR name	Reference
	Status	R
<i>schemeID</i>	Type	xs:token
	Use	optional
	WhiteSpace	collapse
<i>schemeAgencyID</i>	Type	clm63055:AgencyIdentificationCodeContentType
	Length	1 .. 3
	Use	optional
	WhiteSpace	collapse
Error	Occurrence	0 .. unbounded
	eTIR name	Error
	Status	D
	Condition	C006
<i>xs:sequence</i>	Occurrence	1 .. 1
ValidationCode	Occurrence	1 .. 1
	Type	ds:ErrorValidationCodeType
	WhiteSpace	collapse
	Format	an..8
	eTIR name	Error, coded
	Code List	CL99 Error code (to be developed)
	Status	R
<i>listID</i>	Type	xs:token
	Use	optional
	WhiteSpace	collapse
<i>listAgencyID</i>	Type	clm63055:AgencyIdentificationCodeContentType
	Length	1 .. 3
	Use	optional
	WhiteSpace	collapse
Pointer	Occurrence	1 .. unbounded
	eTIR name	Pointer
	Status	R
<i>xs:sequence</i>	Occurrence	1 .. 1
SequenceNumeric	Occurrence	1 .. 1
	Type	ds:PointerSequenceNumericType
	Format	n..5
	eTIR name	Sequence number
	Status	R
DocumentSectionCode	Occurrence	1 .. 1
	Type	ds:PointerDocumentSectionCodeType
	WhiteSpace	collapse
	Format	an..3
	eTIR name	Document/message section, coded
	Code List	CL18 Message section code (codes to be defined)
	Status	R
<i>listID</i>	Type	xs:token
	Use	optional
	WhiteSpace	collapse
<i>listAgencyID</i>	Type	clm63055:AgencyIdentificationCodeContentType
	Length	1 .. 3
	Use	optional
	WhiteSpace	collapse
TagID	Occurrence	1 .. 1
	Type	ds:PointerTagIDType
	WhiteSpace	collapse
	Format	an..4
	eTIR name	Tag identifier
	Code List	CL19 Pointer code (codes to be defined)
	Status	R
<i>schemeID</i>	Type	xs:token
	Use	optional
	WhiteSpace	collapse

└─ <i>schemeAgencyID</i>	Type	clm63055:AgencyIdentificationCodeContentType
	Length	1 .. 3
	Use	optional
	WhiteSpace	collapse

4.2.3.1.1.9. E9 – Advanced cargo information

a. Structure

Occurance	Element/Attribute
	Declaration
1 .. 1	└─ xs:sequence
1 .. 1	└─ IssueDateTime
required	└─ <i>formatCode</i>
1 .. 1	└─ ID
optional	└─ <i>schemeID</i>
optional	└─ <i>schemeAgencyID</i>
0 .. 1	└─ TypeCode
optional	└─ <i>listID</i>
optional	└─ <i>listAgencyID</i>
0 .. 1	└─ FunctionCode
optional	└─ <i>listID</i>
optional	└─ <i>listAgencyID</i>
0 .. 1	└─ TotalGrossMassMeasure
required	└─ <i>unitCode</i>
1 .. 1	AdditionalInformation
1 .. 1	└─ xs:sequence
0 .. 1	└─ Content
optional	└─ <i>languageID</i>
1 .. 1	└─ StatementCode
optional	└─ <i>listID</i>
optional	└─ <i>listAgencyID</i>
0 .. 1	Agent
1 .. 1	└─ xs:sequence
1 .. 1	└─ ID
optional	└─ <i>schemeID</i>
optional	└─ <i>schemeAgencyID</i>
1 .. 1	└─ RoleCode
optional	└─ <i>listID</i>
optional	└─ <i>listAgencyID</i>
0 .. unbounded	Amendment
1 .. 1	└─ xs:sequence
1 .. 1	└─ ChangeReasonCode
optional	└─ <i>listID</i>
optional	└─ <i>listAgencyID</i>
1 .. unbounded	Pointer
1 .. 1	└─ xs:sequence
1 .. 1	└─ SequenceNumeric
1 .. 1	└─ DocumentSectionCode
optional	└─ <i>listID</i>
optional	└─ <i>listAgencyID</i>
1 .. 1	└─ TagID
optional	└─ <i>schemeID</i>
optional	└─ <i>schemeAgencyID</i>
0 .. 1	Carrier
1 .. 1	└─ xs:sequence
0 .. 1	└─ Name
optional	└─ <i>languageID</i>
0 .. 1	└─ ID

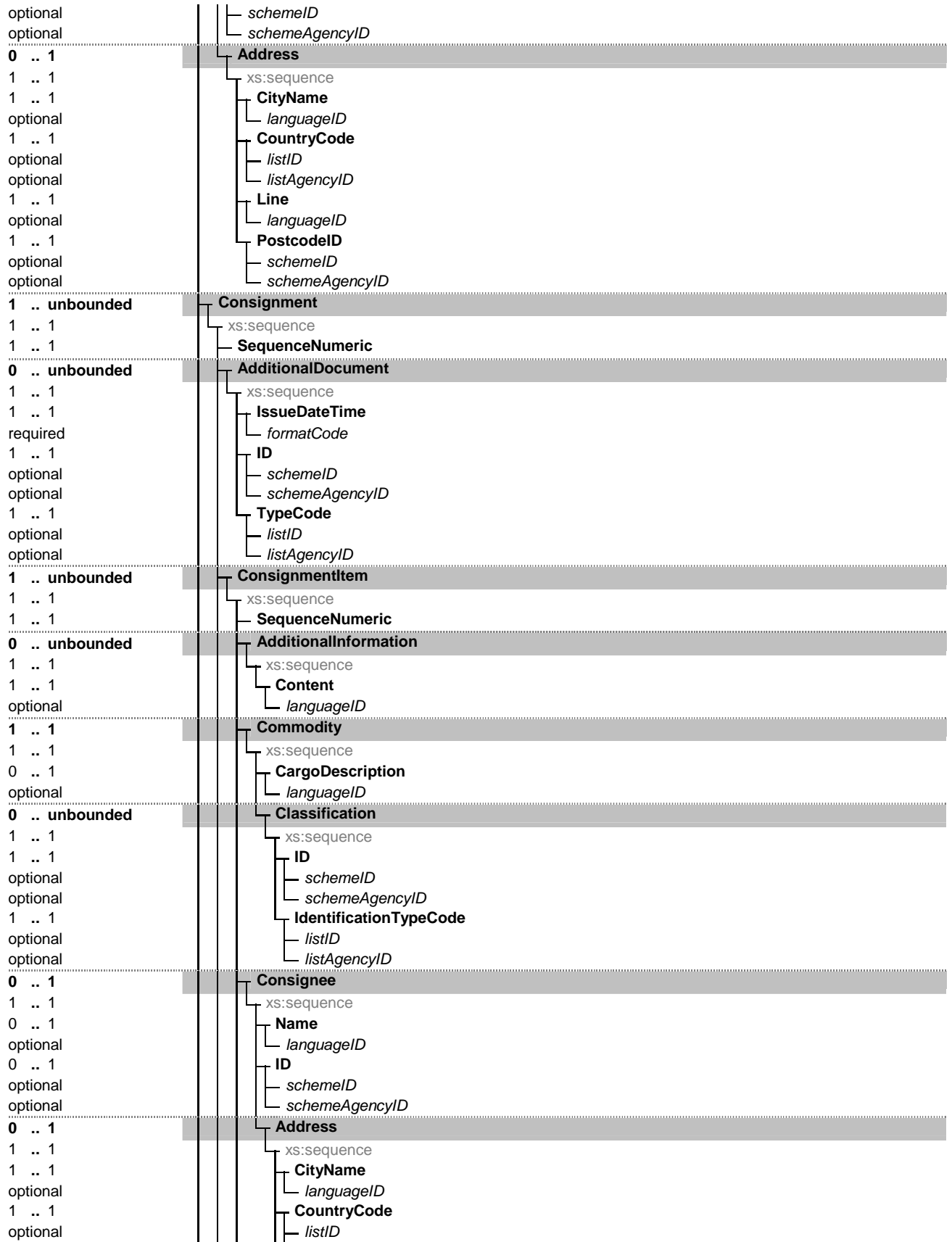

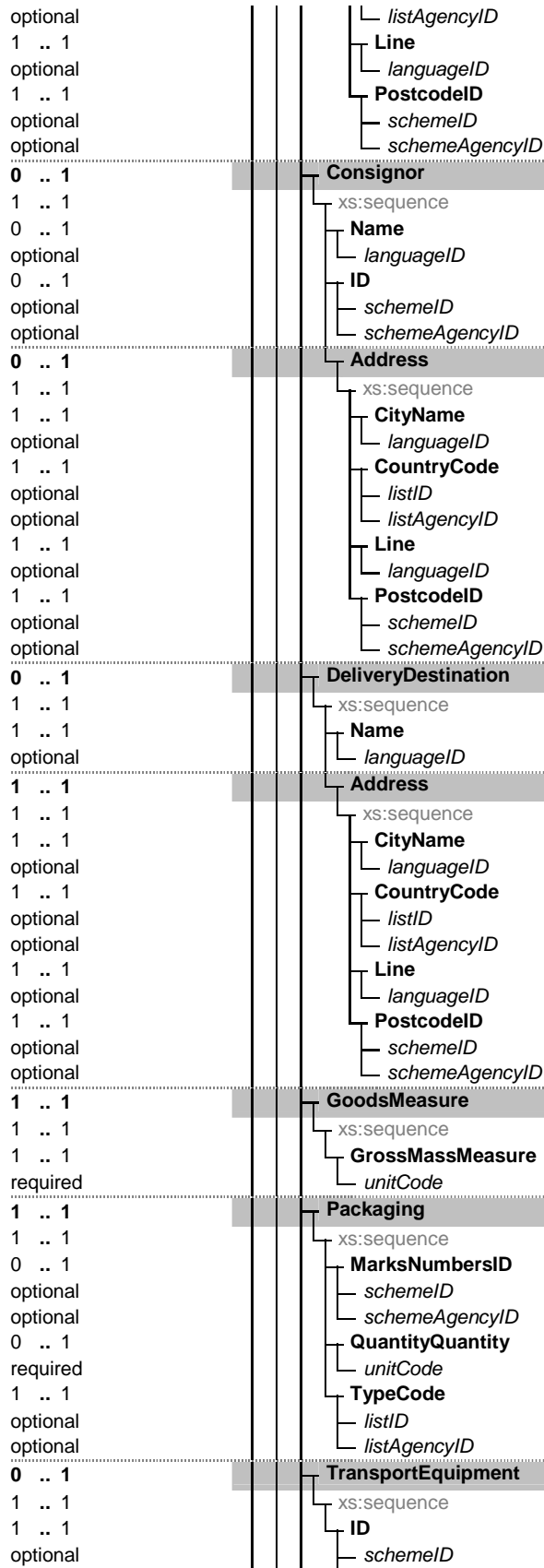

optional		└─ <i>schemeAgencyID</i>
0 .. 1		UCR
1 .. 1		└─ xs:sequence
0 .. 1		└─ ID
optional		└─ <i>schemeID</i>
optional		└─ <i>schemeAgencyID</i>
0 .. 1		LoadingLocation
1 .. 1		└─ xs:sequence
0 .. 1		└─ Name
optional		└─ <i>languageID</i>
0 .. 1		NotifyParty
1 .. 1		└─ xs:sequence
0 .. 1		└─ Name
optional		└─ <i>languageID</i>
0 .. 1		└─ ID
optional		└─ <i>schemeID</i>
optional		└─ <i>schemeAgencyID</i>
0 .. 1		Address
1 .. 1		└─ xs:sequence
1 .. 1		└─ CityName
optional		└─ <i>languageID</i>
1 .. 1		└─ CountryCode
optional		└─ <i>listID</i>
optional		└─ <i>listAgencyID</i>
1 .. 1		└─ Line
optional		└─ <i>languageID</i>
1 .. 1		└─ PostcodeID
optional		└─ <i>schemeID</i>
optional		└─ <i>schemeAgencyID</i>
1 .. 1		TransitDeparture
1 .. 1		└─ xs:sequence
1 .. 1		└─ ID
optional		└─ <i>schemeID</i>
optional		└─ <i>schemeAgencyID</i>
1 .. 1		TransitDestination
1 .. 1		└─ xs:sequence
1 .. 1		└─ ID
optional		└─ <i>schemeID</i>
optional		└─ <i>schemeAgencyID</i>
1 .. unbounded		TransitTransportMeans
1 .. 1		└─ xs:sequence
1 .. 1		└─ ID
optional		└─ <i>schemeID</i>
optional		└─ <i>schemeAgencyID</i>
1 .. 1		└─ TypeCode
optional		└─ <i>listID</i>
optional		└─ <i>listAgencyID</i>
1 .. 1		└─ RegistrationNationalityCode
optional		└─ <i>listID</i>
optional		└─ <i>listAgencyID</i>
0 .. 1		└─ JourneyID
optional		└─ <i>schemeID</i>
optional		└─ <i>schemeAgencyID</i>
1 .. unbounded		Itinerary
1 .. 1		└─ xs:sequence
1 .. 1		└─ SequenceNumeric
1 .. 1		└─ RoutingCountryCode
optional		└─ <i>listID</i>
optional		└─ <i>listAgencyID</i>

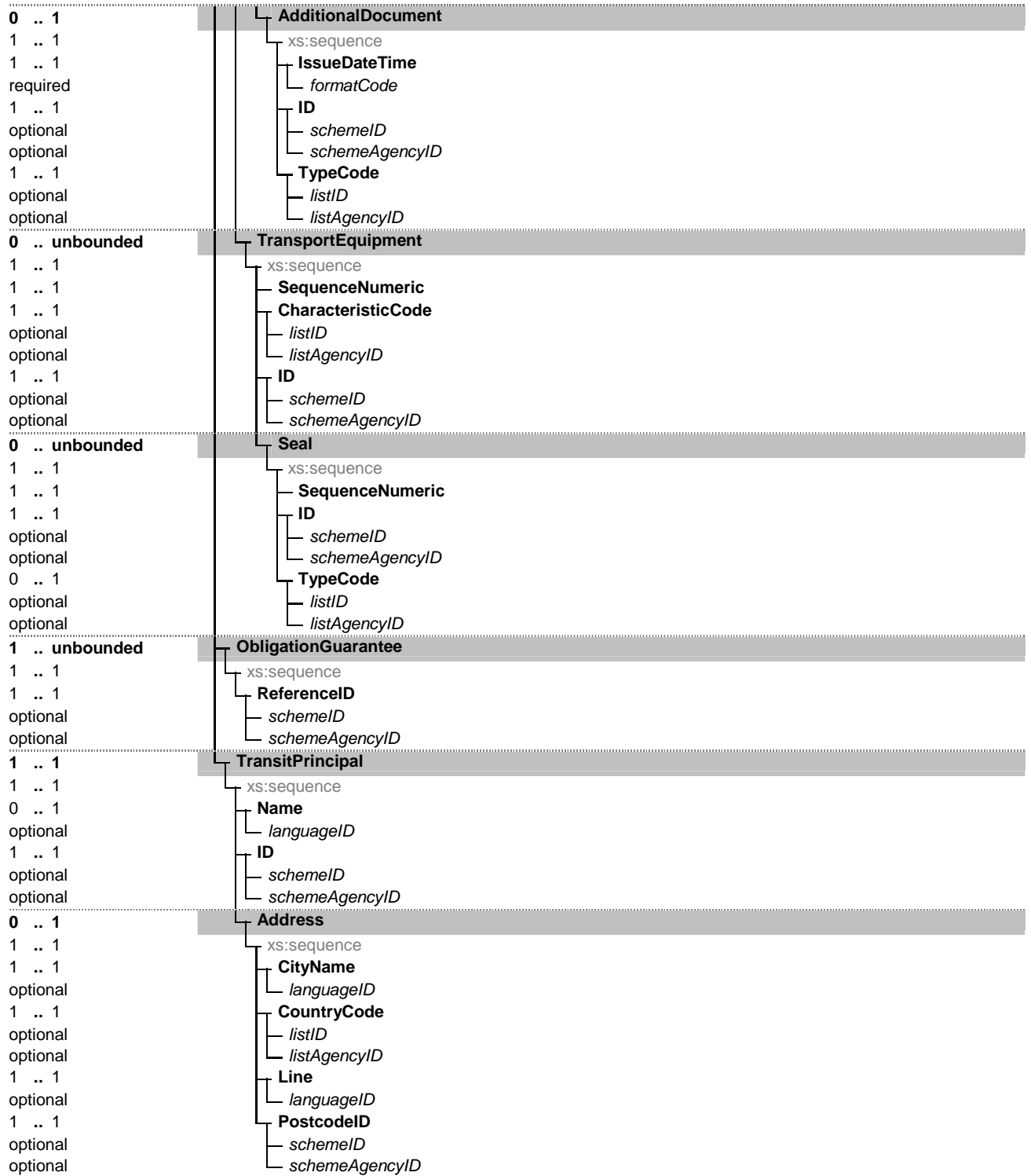

b. Guidelines

Element/Attribute	Annotation
Declaration	eTIR name Status AdvancedCargoInformation R

xs:sequence	Occurrence	1 .. 1	
IssueDateTime	Occurrence	1 .. 1	
	Type	ds:DeclarationIssueDateTimeType	
	WhiteSpace	collapse	
	Format	an..17	
	eTIR name	Date	
	Status	R	
<i>formatCode</i>	Type	clm62379:DateTimePeriodFormatCode	
	Length	1 .. 3	
	Use	required	
	WhiteSpace	collapse	
	Name	Date or time or period format code	
	Description	Code specifying the representation of a date, time or period.	
	Applicable Codes		
	102	CCYYMMDD Calendar date: C = Century ; Y = Year ; M = Month ; D = Day.	
	304	CCYYMMDDHHMMSSZZ See 204 plus Z=Time zone.	
	602	CCYY Calendar year including century: C = Century; Y = Year.	
ID	Occurrence	1 .. 1	
	Type	ds:DeclarationIdentificationIDType	
	WhiteSpace	collapse	
	Format	an..35	
	eTIR name	Reference	
	Status	R	
<i>schemeID</i>	Type	xs:token	
	Use	optional	
	WhiteSpace	collapse	
<i>schemeAgencyID</i>	Type	clm63055:AgencyIdentificationCodeContentType	
	Length	1 .. 3	
	Use	optional	
	WhiteSpace	collapse	
TypeCode	Occurrence	0 .. 1	
	Type	ds:DeclarationTypeCodeType	
	WhiteSpace	collapse	
	Format	an..3	
	eTIR name	Type, coded	
	Code List	CL26	Message sub types
	Status	R	
	Restricted code(s)	E9	Advanced cargo information
<i>listID</i>	Type	xs:token	
	Use	optional	
	WhiteSpace	collapse	
<i>listAgencyID</i>	Type	clm63055:AgencyIdentificationCodeContentType	
	Length	1 .. 3	
	Use	optional	
	WhiteSpace	collapse	
FunctionCode	Occurrence	0 .. 1	
	Type	ds:DeclarationFunctionCodeType	
	WhiteSpace	collapse	
	Format	n..2	
	eTIR name	Message function, coded	
	Code List	CL16	Message function code
	Status	R	
	Restricted code(s)	4	Change
	Restricted code(s)	9	Original
<i>listID</i>	Type	xs:token	
	Use	optional	
	WhiteSpace	collapse	

listAgencyID	Type	clm63055:AgencyIdentificationCodeContentType
	Length	1 .. 3
	Use	optional
	WhiteSpace	collapse
TotalGrossMassMeasure	Occurrence	0 .. 1
	Type	ds:DeclarationTotalGrossMassMeasureType
	Format	n..16,6
	eTIR name	Total gross weight
	Status	O
unitCode	Type	clm6Recommendation20:MeasurementUnitCommonCodeContentType
	Length	1 .. 3
	Use	required
	WhiteSpace	collapse
AdditionalInformation	Occurrence	1 .. 1
	eTIR name	AdditionalInformation
	Status	R
xs:sequence	Occurrence	1 .. 1
Content	Occurrence	0 .. 1
	Type	ds:AdditionalInformationContentTextType
	Format	an..512
	eTIR name	Remarks
	Status	O
languageID	Type	xs:language
	Use	optional
	Pattern	([a-zA-Z]{2}) [iI]-[a-zA-Z]+ [xX]-[a-zA-Z]{1,8})-([a-zA-Z]{1,8})*
	WhiteSpace	collapse
StatementCode	Occurrence	1 .. 1
	Type	ds:AdditionalInformationStatementCodeType
	WhiteSpace	collapse
	Format	an..17
	eTIR name	Heavy and bulky goods indicator
	Code List	CL14 Indicator
	Status	R
	Restricted code(s)	0 No
	Restricted code(s)	1 Yes
listID	Type	xs:token
	Use	optional
	WhiteSpace	collapse
listAgencyID	Type	clm63055:AgencyIdentificationCodeContentType
	Length	1 .. 3
	Use	optional
	WhiteSpace	collapse
Agent	Occurrence	0 .. 1
	eTIR name	Agent
	Status	O
xs:sequence	Occurrence	1 .. 1
ID	Occurrence	1 .. 1
	Type	ds:AgentIdentificationIDType
	WhiteSpace	collapse
	Format	an..17
	eTIR name	Code
	Status	R
schemeID	Type	xs:token
	Use	optional
	WhiteSpace	collapse
schemeAgencyID	Type	clm63055:AgencyIdentificationCodeContentType
	Length	1 .. 3
	Use	optional
	WhiteSpace	collapse

RoleCode	Occurrence	1 .. 1
	Type	ds:AgentRoleCodeType
	WhiteSpace	collapse
	Format	an..3
	Code List	CL02 Party role codes
	eTIR name	Role, coded
	Status	R
	Restricted code(s)	AE Declarant's agent/representative
	Restricted code(s)	AG Agent
	Restricted code(s)	CB Customs broker
	Restricted code(s)	FW Freight forwarder
<i>listID</i>	Type	xs:token
	Use	optional
	WhiteSpace	collapse
<i>listAgencyID</i>	Type	clm63055:AgencyIdentificationCodeContentType
	Length	1 .. 3
	Use	optional
	WhiteSpace	collapse
Amendment	Occurrence	0 .. unbounded
	eTIR name	Amendment
	Status	D
	Condition	C008
xs:sequence	Occurrence	1 .. 1
ChangeReasonCode	Occurrence	1 .. 1
	Type	ds:AmendmentChangeReasonCodeType
	WhiteSpace	collapse
	Format	an..3
	eTIR name	Amendment code
	Code List	CL17 Amendment code
	Status	R
<i>listID</i>	Type	xs:token
	Use	optional
	WhiteSpace	collapse
<i>listAgencyID</i>	Type	clm63055:AgencyIdentificationCodeContentType
	Length	1 .. 3
	Use	optional
	WhiteSpace	collapse
Pointer	Occurrence	1 .. unbounded
	eTIR name	Pointer
	Status	R
xs:sequence	Occurrence	1 .. 1
SequenceNumeric	Occurrence	1 .. 1
	Type	ds:PointerSequenceNumericType
	Format	n..5
	eTIR name	Sequence number
	Status	R
DocumentSectionCode	Occurrence	1 .. 1
	Type	ds:PointerDocumentSectionCodeType
	WhiteSpace	collapse
	Format	an..3
	eTIR name	Document/message section, coded
	Code List	CL18 Message section code (codes to be defined)
	Status	R
<i>listID</i>	Type	xs:token
	Use	optional
	WhiteSpace	collapse
<i>listAgencyID</i>	Type	clm63055:AgencyIdentificationCodeContentType
	Length	1 .. 3
	Use	optional
	WhiteSpace	collapse

TagID	<p>Occurrence 1 .. 1</p> <p>Type ds:PointerTagIDType</p> <p>WhiteSpace collapse</p> <p>Format an..4</p> <p>eTIR name Tag identifier</p> <p>Code List CL19 Pointer code (codes to be defined)</p> <p>Status R</p>
<i>schemeID</i>	<p>Type xs:token</p> <p>Use optional</p> <p>WhiteSpace collapse</p>
<i>schemeAgencyID</i>	<p>Type clm63055:AgencyIdentificationCodeContentType</p> <p>Length 1 .. 3</p> <p>Use optional</p> <p>WhiteSpace collapse</p>
Carrier	<p>Occurrence 0 .. 1</p> <p>eTIR name SubContractor</p> <p>Status O</p>
xs:sequence	<p>Occurrence 1 .. 1</p>
Name	<p>Occurrence 0 .. 1</p> <p>Type ds:CarrierNameTextType</p> <p>Format an..70</p> <p>eTIR name Name</p> <p>Status D</p> <p>Condition C001</p>
<i>languageID</i>	<p>Type xs:language</p> <p>Use optional</p> <p>Pattern ([a-zA-Z]{2} [iI]-[a-zA-Z]+ [xX]-[a-zA-Z]{1,8})-[a-zA-Z]{1,8})*</p> <p>WhiteSpace collapse</p>
ID	<p>Occurrence 0 .. 1</p> <p>Type ds:CarrierIdentificationIDType</p> <p>WhiteSpace collapse</p> <p>Format an..17</p> <p>eTIR name Code</p> <p>Code List CL15 International TIR database</p> <p>Status D</p> <p>Condition C001</p>
<i>schemeID</i>	<p>Type xs:token</p> <p>Use optional</p> <p>WhiteSpace collapse</p>
<i>schemeAgencyID</i>	<p>Type clm63055:AgencyIdentificationCodeContentType</p> <p>Length 1 .. 3</p> <p>Use optional</p> <p>WhiteSpace collapse</p>
Address	<p>Occurrence 0 .. 1</p> <p>eTIR name Address</p> <p>Status D</p> <p>Condition C001</p>
xs:sequence	<p>Occurrence 1 .. 1</p>
CityName	<p>Occurrence 1 .. 1</p> <p>Type ds:AddressCityNameTextType</p> <p>Format an..35</p> <p>eTIR name City name</p> <p>Status R</p>
<i>languageID</i>	<p>Type xs:language</p> <p>Use optional</p> <p>Pattern ([a-zA-Z]{2} [iI]-[a-zA-Z]+ [xX]-[a-zA-Z]{1,8})-[a-zA-Z]{1,8})*</p> <p>WhiteSpace collapse</p>
CountryCode	<p>Occurrence 1 .. 1</p> <p>Type ds:AddressCountryCodeType</p> <p>WhiteSpace collapse</p> <p>Format a2</p> <p>Code List CL04 Country name code</p> <p>eTIR name Country, coded</p>

	Status	R
listID	Type	xs:token
	Use	optional
	WhiteSpace	collapse
listAgencyID	Type	clm63055:AgencyIdentificationCodeContentType
	Length	1 .. 3
	Use	optional
	WhiteSpace	collapse
Line	Occurrence	1 .. 1
	Type	ds:AddressLineTextType
	Format	an..70
	eTIR name	Street and number/P.O. Box
	Status	R
languageID	Type	xs:language
	Use	optional
	Pattern	([a-zA-Z]{2} [iI]-[a-zA-Z]+ [xX]-[a-zA-Z]{1,8}){1,8})*
	WhiteSpace	collapse
PostcodeID	Occurrence	1 .. 1
	Type	ds:AddressPostcodeIDType
	WhiteSpace	collapse
	Format	an..9
	eTIR name	Postcode identification
	Status	R
schemeID	Type	xs:token
	Use	optional
	WhiteSpace	collapse
schemeAgencyID	Type	clm63055:AgencyIdentificationCodeContentType
	Length	1 .. 3
	Use	optional
	WhiteSpace	collapse
Consignment	Occurrence	1 .. unbounded
	eTIR name	Consignment
	Status	R
xs:sequence	Occurrence	1 .. 1
SequenceNumeric	Occurrence	1 .. 1
	Type	ds:ConsignmentSequenceNumericType
	Format	n..5
	eTIR name	Sequence number
	Status	R
AdditionalDocument	Occurrence	0 .. unbounded
	Remark	Also needed for EX1, not in Objectteering
	eTIR name	AttachedDocuments
	Status	O
xs:sequence	Occurrence	1 .. 1
IssueDateTime	Occurrence	1 .. 1
	Type	ds:AdditionalDocumentIssueDateTimeType
	WhiteSpace	collapse
	Format	an..17
	eTIR name	Issuing date
	Status	R
formatCode	Type	clm62379:DateTimePeriodFormatCode
	Length	1 .. 3
	Use	required
	WhiteSpace	collapse
	Name	Date or time or period format code
	Description	Code specifying the representation of a date, time or period.
	Applicable Codes	
	102	CCYYMMDD Calendar date: C = Century ; Y = Year ; M = Month ; D = Day.
	304	CCYYMMDDHHMMSSZZ See 204 plus Z=Time zone.
	602	CCYY Calendar year including century: C = Century; Y = Year.

ID	Occurrence 1 .. 1 Type ds:AdditionalDocumentIdentificationIDType WhiteSpace collapse Format an..35 eTIR name Number Status R
<i>schemeID</i>	Type xs:token Use optional WhiteSpace collapse
<i>schemeAgencyID</i>	Type clm63055:AgencyIdentificationCodeContentType Length 1 .. 3 Use optional WhiteSpace collapse
TypeCode	Occurrence 1 .. 1 Type ds:AdditionalDocumentTypeCodeType WhiteSpace collapse Format an..3 eTIR name Type, coded Code List CL06 Document name code Status R
<i>listID</i>	Type xs:token Use optional WhiteSpace collapse
<i>listAgencyID</i>	Type clm63055:AgencyIdentificationCodeContentType Length 1 .. 3 Use optional WhiteSpace collapse
ConsignmentItem	Occurrence 1 .. unbounded eTIR name ConsignmentItem Status R
xs:sequence	
SequenceNumeric	Occurrence 1 .. 1 Type ds:ConsignmentItemSequenceNumericType Format n..5 eTIR name Sequence number Status R
AdditionalInformation	Occurrence 0 .. unbounded eTIR name AdditionalInformation Status O
xs:sequence	
Content	Occurrence 1 .. 1 Type ds:AdditionalInformationContentTextType Format an..512 eTIR name Remarks Status R
<i>languageID</i>	Type xs:language Use optional Pattern ([a-zA-Z]{2} [iI]-[a-zA-Z]+ [xX]-[a-zA-Z]{1,8})-[a-zA-Z]{1,8}) WhiteSpace collapse
Commodity	Occurrence 1 .. 1 eTIR name Goods Status R
xs:sequence	
CargoDescription	Occurrence 0 .. 1 Type ds:CommodityCargoDescriptionTextType Format an..256 eTIR name Description Status D Condition C004
<i>languageID</i>	Type xs:language Use optional Pattern ([a-zA-Z]{2} [iI]-[a-zA-Z]+ [xX]-[a-zA-Z]{1,8})-[a-zA-Z]{1,8}) WhiteSpace collapse

Classification	Occurrence 0 .. unbounded eTIR name Classification Status O
xs:sequence	Occurrence 1 .. 1
ID	Occurrence 1 .. 1 Type ds:ClassificationIdentificationIDType WhiteSpace collapse Format an..18 eTIR name Code Status R
<i>schemeID</i>	Type xs:token Use optional WhiteSpace collapse
<i>schemeAgencyID</i>	Type clm63055:AgencyIdentificationCodeContentType Length 1 .. 3 Use optional WhiteSpace collapse
IdentificationTypeCode	Occurrence 1 .. 1 Type ds:ClassificationIdentificationTypeCodeType WhiteSpace collapse Format an..3 eTIR name Type Code List CL03 Item type identification code Status R Restricted code(s) HS Harmonised system Remark Add code UN Dangerous Goods to code list 7143
<i>listID</i>	Type xs:token Use optional WhiteSpace collapse
<i>listAgencyID</i>	Type clm63055:AgencyIdentificationCodeContentType Length 1 .. 3 Use optional WhiteSpace collapse
Consignee	Occurrence 0 .. 1 eTIR name Consignee Status O
xs:sequence	Occurrence 1 .. 1
Name	Occurrence 0 .. 1 Type ds:ConsigneeNameTextType Format an..70 eTIR name Name Status D Condition C001
<i>languageID</i>	Type xs:language Use optional Pattern ([a-zA-Z]{2} [iI]-[a-zA-Z]+ [xX]-[a-zA-Z]{1,8}){1,8})*
ID	Occurrence 0 .. 1 Type ds:ConsigneeIdentificationIDType WhiteSpace collapse Format an..17 eTIR name Code Status D Condition C001 Remark Code list to be defined
<i>schemeID</i>	Type xs:token Use optional WhiteSpace collapse
<i>schemeAgencyID</i>	Type clm63055:AgencyIdentificationCodeContentType Length 1 .. 3 Use optional WhiteSpace collapse
Address	Occurrence 0 .. 1

	eTIR name	Address
	Status	D
	Condition	C001
xs:sequence	Occurrence	1 .. 1
CityName	Occurrence	1 .. 1
	Type	ds:AddressCityNameTextType
	Format	an..35
	eTIR name	City name
	Status	R
languageID	Type	xs:language
	Use	optional
	Pattern	([a-zA-Z]{2})[il]-[a-zA-Z]+[[xX]-[a-zA-Z]{1,8})-[a-zA-Z]{1,8)*
	WhiteSpace	collapse
CountryCode	Occurrence	1 .. 1
	Type	ds:AddressCountryCodeType
	WhiteSpace	collapse
	Format	a2
	Code List	CL04 Country name code
	eTIR name	Country, coded
	Status	R
listID	Type	xs:token
	Use	optional
	WhiteSpace	collapse
listAgencyID	Type	clm63055:AgencyIdentificationCodeContentType
	Length	1 .. 3
	Use	optional
	WhiteSpace	collapse
Line	Occurrence	1 .. 1
	Type	ds:AddressLineTextType
	Format	an..70
	eTIR name	Street and number/P.O. Box
	Status	R
languageID	Type	xs:language
	Use	optional
	Pattern	([a-zA-Z]{2})[il]-[a-zA-Z]+[[xX]-[a-zA-Z]{1,8})-[a-zA-Z]{1,8)*
	WhiteSpace	collapse
PostcodeID	Occurrence	1 .. 1
	Type	ds:AddressPostcodeIDType
	WhiteSpace	collapse
	Format	an..9
	eTIR name	Postcode identification
	Status	R
schemeID	Type	xs:token
	Use	optional
	WhiteSpace	collapse
schemeAgencyID	Type	clm63055:AgencyIdentificationCodeContentType
	Length	1 .. 3
	Use	optional
	WhiteSpace	collapse
Consignor	Occurrence	0 .. 1
	eTIR name	Consignor
	Status	O
xs:sequence	Occurrence	1 .. 1
Name	Occurrence	0 .. 1
	Type	ds:ConsignorNameTextType
	Format	an..70
	eTIR name	Name
	Status	D
	Condition	C001

<i>languageID</i>	Type Use Pattern WhiteSpace	xs:language optional ([a-zA-Z]{2} [iI]-[a-zA-Z]+ [xX]-[a-zA-Z]{1,8})-([a-zA-Z]{1,8})* collapse
ID	Occurrence Type WhiteSpace Format eTIR name Status Condition Remark	0 .. 1 ds:ConsignorIdentificationIDType collapse an..17 Code D C001 Code list to be defined
<i>schemeID</i>	Type Use WhiteSpace	xs:token optional collapse
<i>schemeAgencyID</i>	Type Length Use WhiteSpace	clm63055:AgencyIdentificationCodeContentType 1 .. 3 optional collapse
Address	Occurrence eTIR name Status Condition	0 .. 1 Address D C001
xs:sequence	Occurrence	1 .. 1
CityName	Occurrence Type Format eTIR name Status	1 .. 1 ds:AddressCityNameTextType an..35 City name R
<i>languageID</i>	Type Use Pattern WhiteSpace	xs:language optional ([a-zA-Z]{2} [iI]-[a-zA-Z]+ [xX]-[a-zA-Z]{1,8})-([a-zA-Z]{1,8})* collapse
CountryCode	Occurrence Type WhiteSpace Format Code List eTIR name Status	1 .. 1 ds:AddressCountryCodeType collapse a2 CL04 Country name code Country, coded R
<i>listID</i>	Type Use WhiteSpace	xs:token optional collapse
<i>listAgencyID</i>	Type Length Use WhiteSpace	clm63055:AgencyIdentificationCodeContentType 1 .. 3 optional collapse
Line	Occurrence Type Format eTIR name Status	1 .. 1 ds:AddressLineTextType an..70 Street and number/P.O. Box R
<i>languageID</i>	Type Use Pattern WhiteSpace	xs:language optional ([a-zA-Z]{2} [iI]-[a-zA-Z]+ [xX]-[a-zA-Z]{1,8})-([a-zA-Z]{1,8})* collapse
PostcodeID	Occurrence Type WhiteSpace Format eTIR name Status	1 .. 1 ds:AddressPostcodeIDType collapse an..9 Postcode identification R

<i>schemeID</i>	Type Use WhiteSpace	xs:token optional collapse
<i>schemeAgencyID</i>	Type Length Use WhiteSpace	clm63055:AgencyIdentificationCodeContentType 1 .. 3 optional collapse
DeliveryDestination	Occurrence eTIR name Status	0 .. 1 DeliveryDestination O
xs:sequence	Occurrence	1 .. 1
Name	Occurrence Type Format eTIR name Status	1 .. 1 ds:DeliveryDestinationNameTextType an..70 Name R
<i>languageID</i>	Type Use Pattern WhiteSpace	xs:language optional ([a-zA-Z]{2} [iI]-[a-zA-Z]+ [xX]-[a-zA-Z]{1,8})-([a-zA-Z]{1,8})* collapse
Address	Occurrence eTIR name Status	1 .. 1 Address R
xs:sequence	Occurrence	1 .. 1
CityName	Occurrence Type Format eTIR name Status	1 .. 1 ds:AddressCityNameTextType an..35 City name R
<i>languageID</i>	Type Use Pattern WhiteSpace	xs:language optional ([a-zA-Z]{2} [iI]-[a-zA-Z]+ [xX]-[a-zA-Z]{1,8})-([a-zA-Z]{1,8})* collapse
CountryCode	Occurrence Type WhiteSpace Format Code List eTIR name Status	1 .. 1 ds:AddressCountryCodeType collapse a2 CL04 Country name code Country, coded R
<i>listID</i>	Type Use WhiteSpace	xs:token optional collapse
<i>listAgencyID</i>	Type Length Use WhiteSpace	clm63055:AgencyIdentificationCodeContentType 1 .. 3 optional collapse
Line	Occurrence Type Format eTIR name Status	1 .. 1 ds:AddressLineTextType an..70 Street and number/P.O. Box R
<i>languageID</i>	Type Use Pattern WhiteSpace	xs:language optional ([a-zA-Z]{2} [iI]-[a-zA-Z]+ [xX]-[a-zA-Z]{1,8})-([a-zA-Z]{1,8})* collapse
PostcodeID	Occurrence Type WhiteSpace Format eTIR name Status	1 .. 1 ds:AddressPostcodeIDType collapse an..9 Postcode identification R

<i>schemeID</i>	Type Use WhiteSpace	xs:token optional collapse
<i>schemeAgencyID</i>	Type Length Use WhiteSpace	clm63055:AgencyIdentificationCodeContentType 1 .. 3 optional collapse
GoodsMeasure	Occurrence eTIR name Status	1 .. 1 GoodsMeasure R
xs:sequence	Occurrence	1 .. 1
GrossMassMeasure	Occurrence Type Format eTIR name Status	1 .. 1 ds:GoodsMeasureGrossMassMeasureType n..16,6 Gross weight R
<i>unitCode</i>	Type Length Use WhiteSpace	clm6Recommendation20: MeasurementUnitCommonCodeContentType 1 .. 3 required collapse
Packaging	Occurrence eTIR name Status	1 .. 1 Packaging R
xs:sequence	Occurrence	1 .. 1
MarksNumbersID	Occurrence Type WhiteSpace Format eTIR name Status	0 .. 1 ds:PackagingMarksNumbersIDType collapse an..512 Marks and numbers O
<i>schemeID</i>	Type Use WhiteSpace	xs:token optional collapse
<i>schemeAgencyID</i>	Type Length Use WhiteSpace	clm63055:AgencyIdentificationCodeContentType 1 .. 3 optional collapse
QuantityQuantity	Occurrence Type Format eTIR name Status Condition	0 .. 1 ds:PackagingQuantityQuantityType n..8 Number of packages D C002
<i>unitCode</i>	Type Length Use WhiteSpace	clm6Recommendation20: MeasurementUnitCommonCodeContentType 1 .. 3 required collapse
TypeCode	Occurrence Type WhiteSpace Format eTIR name Code List Status	1 .. 1 ds:PackagingTypeCodeType collapse an..2 Type, coded CL07 Package type description code R
<i>listID</i>	Type Use WhiteSpace	xs:token optional collapse
<i>listAgencyID</i>	Type Length Use WhiteSpace	clm63055:AgencyIdentificationCodeContentType 1 .. 3 optional collapse
TransportEquipment	Occurrence eTIR name	0 .. 1 TransportEquipment

	Status	D
	Condition	C003
	Occurrence	1 .. 1
xs:sequence	Occurrence	1 .. 1
ID	Type	ds:TransportEquipmentIdentificationIDType
	WhiteSpace	collapse
	Format	an..17
	eTIR name	Identification
	Status	R
schemeID	Type	xs:token
	Use	optional
	WhiteSpace	collapse
schemeAgencyID	Type	clm63055:AgencyIdentificationCodeContentType
	Length	1 .. 3
	Use	optional
	WhiteSpace	collapse
UCR	Occurrence	0 .. 1
	eTIR name	UCR
	Status	O
xs:sequence	Occurrence	1 .. 1
ID	Occurrence	0 .. 1
	Type	ds:UCRIdentificationIDType
	WhiteSpace	collapse
	Format	an..35
	eTIR name	Identifier
	Status	O
schemeID	Type	xs:token
	Use	optional
	WhiteSpace	collapse
schemeAgencyID	Type	clm63055:AgencyIdentificationCodeContentType
	Length	1 .. 3
	Use	optional
	WhiteSpace	collapse
LoadingLocation	Occurrence	0 .. 1
	eTIR name	LoadingLocation
	Status	O
xs:sequence	Occurrence	1 .. 1
Name	Occurrence	0 .. 1
	Type	ds>LoadingLocationNameTextType
	Format	an..256
	eTIR name	Name
	Status	O
languageID	Type	xs:language
	Use	optional
	Pattern	([a-zA-Z]{2} [iI]-[a-zA-Z]+ [xX]-[a-zA-Z]{1,8})-([a-zA-Z]{1,8})*
	WhiteSpace	collapse
NotifyParty	Occurrence	0 .. 1
	eTIR name	NotifyParty
	Status	O
xs:sequence	Occurrence	1 .. 1
Name	Occurrence	0 .. 1
	Type	ds:NotifyPartyNameTextType
	Format	an..70
	eTIR name	Name
	Status	D
	Condition	C001
languageID	Type	xs:language
	Use	optional
	Pattern	([a-zA-Z]{2} [iI]-[a-zA-Z]+ [xX]-[a-zA-Z]{1,8})-([a-zA-Z]{1,8})*
	WhiteSpace	collapse
ID	Occurrence	0 .. 1
	Type	ds:NotifyPartyIdentificationIDType
	WhiteSpace	collapse

	Format	an..17
	eTIR name	Code
	Status	D
	Condition	C001
<i>schemeID</i>	Type	xs:token
	Use	optional
	WhiteSpace	collapse
<i>schemeAgencyID</i>	Type	clm63055:AgencyIdentificationCodeContentType
	Length	1 .. 3
	Use	optional
	WhiteSpace	collapse
Address	Occurrence	0 .. 1
	eTIR name	Address
	Status	D
	Condition	C001
<i>xs:sequence</i>	Occurrence	1 .. 1
CityName	Occurrence	1 .. 1
	Type	ds:AddressCityNameTextType
	Format	an..35
	eTIR name	City name
	Status	R
<i>languageID</i>	Type	xs:language
	Use	optional
	Pattern	([a-zA-Z]{2} [iI]-[a-zA-Z]+ [xX]-[a-zA-Z]{1,8})-[a-zA-Z]{1,8})*
	WhiteSpace	collapse
CountryCode	Occurrence	1 .. 1
	Type	ds:AddressCountryCodeType
	WhiteSpace	collapse
	Format	a2
	Code List	CL04 Country name code
	eTIR name	Country, coded
	Status	R
<i>listID</i>	Type	xs:token
	Use	optional
	WhiteSpace	collapse
<i>listAgencyID</i>	Type	clm63055:AgencyIdentificationCodeContentType
	Length	1 .. 3
	Use	optional
	WhiteSpace	collapse
Line	Occurrence	1 .. 1
	Type	ds:AddressLineTextType
	Format	an..70
	eTIR name	Street and number/P.O. Box
	Status	R
<i>languageID</i>	Type	xs:language
	Use	optional
	Pattern	([a-zA-Z]{2} [iI]-[a-zA-Z]+ [xX]-[a-zA-Z]{1,8})-[a-zA-Z]{1,8})*
	WhiteSpace	collapse
PostcodeID	Occurrence	1 .. 1
	Type	ds:AddressPostcodeIDType
	WhiteSpace	collapse
	Format	an..9
	eTIR name	Postcode identification
	Status	R
<i>schemeID</i>	Type	xs:token
	Use	optional
	WhiteSpace	collapse
<i>schemeAgencyID</i>	Type	clm63055:AgencyIdentificationCodeContentType
	Length	1 .. 3
	Use	optional
	WhiteSpace	collapse
TransitDeparture	Occurrence	1 .. 1
	eTIR name	CustomsOfficeOfDeparture

		Status	R	
	xs:sequence	Occurrence	1 .. 1	
	ID	Occurrence	1 .. 1	
		Type	ds:TransitDepartureIdentificationIDType	
		WhiteSpace	collapse	
		Format	an..17	
		eTIR name	Code	
		Code List	CL13	Customs offices database (to be developed)
		Status	R	
	schemeID	Type	xs:token	
		Use	optional	
		WhiteSpace	collapse	
	schemeAgencyID	Type	clm63055:AgencyIdentificationCodeContentType	
		Length	1 .. 3	
		Use	optional	
		WhiteSpace	collapse	
	TransitDestination	Occurrence	1 .. 1	
		eTIR name	CustomsOfficeOfDestination	
		Status	R	
	xs:sequence	Occurrence	1 .. 1	
	ID	Occurrence	1 .. 1	
		Type	ds:TransitDestinationIdentificationIDType	
		WhiteSpace	collapse	
		Format	an..17	
		eTIR name	Code	
		Code List	CL13	Customs offices database (to be developed)
		Status	R	
	schemeID	Type	xs:token	
		Use	optional	
		WhiteSpace	collapse	
	schemeAgencyID	Type	clm63055:AgencyIdentificationCodeContentType	
		Length	1 .. 3	
		Use	optional	
		WhiteSpace	collapse	
	TransitTransportMeans	Occurrence	1 .. unbounded	
		eTIR name	TransportMean	
		Status	R	
	xs:sequence	Occurrence	1 .. 1	
	ID	Occurrence	1 .. 1	
		Type	ds:TransitTransportMeansIdentificationIDType	
		WhiteSpace	collapse	
		Format	an..25	
		eTIR name	Identification	
		Status	R	
	schemeID	Type	xs:token	
		Use	optional	
		WhiteSpace	collapse	
	schemeAgencyID	Type	clm63055:AgencyIdentificationCodeContentType	
		Length	1 .. 3	
		Use	optional	
		WhiteSpace	collapse	
	TypeCode	Occurrence	1 .. 1	
		Type	ds:TransitTransportMeansTypeCodeType	
		WhiteSpace	collapse	
		Format	an..4	
		eTIR name	Type, coded	
		Code List	CL05	Transport means description code
		Status	R	
	listID	Type	xs:token	
		Use	optional	
		WhiteSpace	collapse	

<i>listAgencyID</i>	Type	clm63055:AgencyIdentificationCodeContentType
	Length	1 .. 3
	Use	optional
	WhiteSpace	collapse
RegistrationNationalityCode	Occurrence	1 .. 1
	Type	ds:TransitTransportMeansRegistrationNationalityCodeType
	WhiteSpace	collapse
	Format	a2
	eTIR name	Nationality
	Code List	CL04 Country name code
	Status	R
<i>listID</i>	Type	xs:token
	Use	optional
	WhiteSpace	collapse
<i>listAgencyID</i>	Type	clm63055:AgencyIdentificationCodeContentType
	Length	1 .. 3
	Use	optional
	WhiteSpace	collapse
JourneyID	Occurrence	0 .. 1
	Type	ds:TransitTransportMeansJourneyIDType
	WhiteSpace	collapse
	Format	an..17
	eTIR name	Conveyance reference number
	Status	O
<i>schemeID</i>	Type	xs:token
	Use	optional
	WhiteSpace	collapse
<i>schemeAgencyID</i>	Type	clm63055:AgencyIdentificationCodeContentType
	Length	1 .. 3
	Use	optional
	WhiteSpace	collapse
Itinerary	Occurrence	1 .. unbounded
	eTIR name	CountryOfRouting
	Status	R
<i>xs:sequence</i>	Occurrence	1 .. 1
SequenceNumeric	Occurrence	1 .. 1
	Type	ds:ItinerarySequenceNumericType
	Format	n..5
	eTIR name	Sequence number
	Status	R
RoutingCountryCode	Occurrence	1 .. 1
	Type	ds:ItineraryRoutingCountryCodeType
	WhiteSpace	collapse
	Format	a2
	eTIR name	Country, coded
	Code List	CL04 Country name code
	Status	R
<i>listID</i>	Type	xs:token
	Use	optional
	WhiteSpace	collapse
<i>listAgencyID</i>	Type	clm63055:AgencyIdentificationCodeContentType
	Length	1 .. 3
	Use	optional
	WhiteSpace	collapse
AdditionalDocument	Occurrence	0 .. 1
	eTIR name	CertificateOfApproval
	Status	D
	Condition	C005
<i>xs:sequence</i>	Occurrence	1 .. 1
IssueDateTime	Occurrence	1 .. 1
	Type	ds:AdditionalDocumentIssueDateTimeType
	WhiteSpace	collapse
	Format	an..17
	eTIR name	Date

<i>formatCode</i>	<p>Status R</p> <p>Type clm62379:DateTimePeriodFormatCode</p> <p>Length 1 .. 3</p> <p>Use required</p> <p>WhiteSpace collapse</p> <p>Name Date or time or period format code</p> <p>Description Code specifying the representation of a date, time or period.</p> <p>Applicable Codes</p> <p>102 CCYYMMDD Calendar date: C = Century ; Y = Year ; M = Month ; D = Day.</p> <p>304 CCYYMMDDHHMMSSZZ See 204 plus Z=Time zone.</p> <p>602 CCYY Calendar year including century: C = Century; Y = Year.</p>
ID	<p>Occurrence 1 .. 1</p> <p>Type ds:AdditionalDocumentIdentificationIDType</p> <p>WhiteSpace collapse</p> <p>Format an..35</p> <p>eTIR name Number</p> <p>Status R</p>
<i>schemeID</i>	<p>Type xs:token</p> <p>Use optional</p> <p>WhiteSpace collapse</p>
<i>schemeAgencyID</i>	<p>Type clm63055:AgencyIdentificationCodeContentType</p> <p>Length 1 .. 3</p> <p>Use optional</p> <p>WhiteSpace collapse</p>
TypeCode	<p>Occurrence 1 .. 1</p> <p>Type ds:AdditionalDocumentTypeCodeType</p> <p>WhiteSpace collapse</p> <p>Format an..3</p> <p>eTIR name Type, coded</p> <p>Code List CL06 Document name code</p> <p>Status R</p> <p>Remark Pending addition of a code, for TIR certificate of approval, against Edifact 1001 code list.</p>
<i>listID</i>	<p>Type xs:token</p> <p>Use optional</p> <p>WhiteSpace collapse</p>
<i>listAgencyID</i>	<p>Type clm63055:AgencyIdentificationCodeContentType</p> <p>Length 1 .. 3</p> <p>Use optional</p> <p>WhiteSpace collapse</p>
TransportEquipment	<p>Occurrence 0 .. unbounded</p> <p>eTIR name TransportEquipment</p> <p>Status D</p> <p>Condition C003</p>
<i>xs:sequence</i>	<p>Occurrence 1 .. 1</p>
SequenceNumeric	<p>Occurrence 1 .. 1</p> <p>Type ds:TransportEquipmentSequenceNumericType</p> <p>Format n..5</p> <p>eTIR name Sequence number</p> <p>Status R</p>
CharacteristicCode	<p>Occurrence 1 .. 1</p> <p>Type ds:TransportEquipmentCharacteristicCodeType</p> <p>WhiteSpace collapse</p> <p>Format an..4</p> <p>eTIR name Size and type identification</p> <p>Code List CL01 Equipment size and type description code</p> <p>Status R</p>
<i>listID</i>	<p>Type xs:token</p> <p>Use optional</p> <p>WhiteSpace collapse</p>

<i>listAgencyID</i>	Type Length Use WhiteSpace	clm63055:AgencyIdentificationCodeContentType 1 .. 3 optional collapse
ID	Occurrence Type WhiteSpace Format eTIR name Status	1 .. 1 ds:TransportEquipmentIdentificationIDType collapse an..17 Identification R
<i>schemeID</i>	Type Use WhiteSpace	xs:token optional collapse
<i>schemeAgencyID</i>	Type Length Use WhiteSpace	clm63055:AgencyIdentificationCodeContentType 1 .. 3 optional collapse
Seal	Occurrence eTIR name Status	0 .. unbounded Seal O
xs:sequence	Occurrence	1 .. 1
SequenceNumeric	Occurrence Type Format eTIR name Status	1 .. 1 ds:SealSequenceNumericType n..5 Sequence number R
ID	Occurrence Type WhiteSpace Format eTIR name Status	1 .. 1 ds:SealIdentificationIDType collapse an..35 Seal number R
<i>schemeID</i>	Type Use WhiteSpace	xs:token optional collapse
<i>schemeAgencyID</i>	Type Length Use WhiteSpace	clm63055:AgencyIdentificationCodeContentType 1 .. 3 optional collapse
TypeCode	Occurrence Type WhiteSpace Format eTIR name Status Code List	0 .. 1 ds:SealTypeCodeType collapse an..3 Seal type code O CL08 Seal type code
<i>listID</i>	Type Use WhiteSpace	xs:token optional collapse
<i>listAgencyID</i>	Type Length Use WhiteSpace	clm63055:AgencyIdentificationCodeContentType 1 .. 3 optional collapse
ObligationGuarantee	Occurrence eTIR name Status	1 .. unbounded Guarantee R
xs:sequence	Occurrence	1 .. 1
ReferenceID	Occurrence Type WhiteSpace Format eTIR name Status	1 .. 1 ds:ObligationGuaranteeReferenceIDType collapse an..35 Reference R

<ul style="list-style-type: none"> — <i>schemeID</i> 	<p>Type xs:token Use optional WhiteSpace collapse</p>
<ul style="list-style-type: none"> — <i>schemeAgencyID</i> 	<p>Type clm63055:AgencyIdentificationCodeContentType Length 1 .. 3 Use optional WhiteSpace collapse</p>
TransitPrincipal	<p>Occurrence 1 .. 1 eTIR name Holder Status R</p>
<ul style="list-style-type: none"> — xs:sequence Name 	<p>Occurrence 1 .. 1 Occurrence 0 .. 1 Type ds:TransitPrincipalNameTextType Format an..70 eTIR name Name Status O</p>
<ul style="list-style-type: none"> — <i>languageID</i> 	<p>Type xs:language Use optional Pattern ([a-zA-Z]{2} [iI]-[a-zA-Z]+ [xX]-[a-zA-Z]{1,8})-[a-zA-Z]{1,8})[*] WhiteSpace collapse</p>
ID	<p>Occurrence 1 .. 1 Type ds:TransitPrincipalIdentificationIDType WhiteSpace collapse Format an..17 eTIR name Code Code List CL15 International TIR database Status R</p>
<ul style="list-style-type: none"> — <i>schemeID</i> 	<p>Type xs:token Use optional WhiteSpace collapse</p>
<ul style="list-style-type: none"> — <i>schemeAgencyID</i> 	<p>Type clm63055:AgencyIdentificationCodeContentType Length 1 .. 3 Use optional WhiteSpace collapse</p>
Address	<p>Occurrence 0 .. 1 eTIR name Address Status O</p>
<ul style="list-style-type: none"> — xs:sequence CityName 	<p>Occurrence 1 .. 1 Occurrence 1 .. 1 Type ds:AddressCityNameTextType Format an..35 eTIR name City name Status R</p>
<ul style="list-style-type: none"> — <i>languageID</i> 	<p>Type xs:language Use optional Pattern ([a-zA-Z]{2} [iI]-[a-zA-Z]+ [xX]-[a-zA-Z]{1,8})-[a-zA-Z]{1,8})[*] WhiteSpace collapse</p>
CountryCode	<p>Occurrence 1 .. 1 Type ds:AddressCountryCodeType WhiteSpace collapse Format a2 Code List CL04 Country name code eTIR name Country, coded Status R</p>
<ul style="list-style-type: none"> — <i>listID</i> 	<p>Type xs:token Use optional WhiteSpace collapse</p>
<ul style="list-style-type: none"> — <i>listAgencyID</i> 	<p>Type clm63055:AgencyIdentificationCodeContentType Length 1 .. 3 Use optional WhiteSpace collapse</p>
Line	<p>Occurrence 1 .. 1 Type ds:AddressLineTextType</p>

<i>languageID</i>	<p>Format an..70 eTIR name Street and number/P.O. Box Status R Type xs:language Use optional Pattern ([a-zA-Z]{2}[iI]-[a-zA-Z]+[xX]-[a-zA-Z]{1,8})-([a-zA-Z]{1,8})* WhiteSpace collapse</p>
PostcodeID	<p>Occurrence 1 .. 1 Type ds:AddressPostcodeIDType WhiteSpace collapse Format an..9 eTIR name Postcode identification Status R</p>
<i>schemeID</i>	<p>Type xs:token Use optional WhiteSpace collapse</p>
<i>schemeAgencyID</i>	<p>Type clm63055:AgencyIdentificationCodeContentType Length 1 .. 3 Use optional WhiteSpace collapse</p>

4.2.3.1.1.10. E10 – Advanced cargo information results

a. Structure

Occurance	Element/Attribute
1 .. 1	Response
1 .. 1	xs:sequence
1 .. 1	FunctionalReferenceID
optional	<i>schemeID</i>
optional	<i>schemeAgencyID</i>
1 .. 1	OverallDeclaration
1 .. 1	xs:sequence
1 .. 1	Declaration
1 .. 1	xs:sequence
1 .. 1	ID
optional	<i>schemeID</i>
optional	<i>schemeAgencyID</i>
1 .. 1	TypeCode
optional	<i>listID</i>
optional	<i>listAgencyID</i>
0 .. 1	AcceptanceDateTime
required	<i>formatCode</i>
1 .. 1	FunctionCode
optional	<i>listID</i>
optional	<i>listAgencyID</i>
0 .. 1	RejectionDateTime
required	<i>formatCode</i>
0 .. unbounded	Error
1 .. 1	xs:sequence
1 .. 1	ValidationCode
optional	<i>listID</i>
optional	<i>listAgencyID</i>
1 .. unbounded	Pointer
1 .. 1	xs:sequence
1 .. 1	SequenceNumeric
1 .. 1	DocumentSectionCode
optional	<i>listID</i>
optional	<i>listAgencyID</i>

1 .. 1
optional
optional

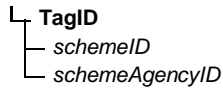

b. Guidelines

Element/Attribute	Annotation
Response	eTIR name Response Status R Occurrence 1 .. 1
FunctionalReferenceID	Occurrence 1 .. 1 Type ds:ResponseFunctionalReferenceIDType WhiteSpace collapse Format an..35 eTIR name Functional Reference Remark REFERENCE TO THE PREVIOUS MESSAGE Status R
<i>schemeID</i>	Type xs:token Use optional WhiteSpace collapse
<i>schemeAgencyID</i>	Type clm63055:AgencyIdentificationCodeContentType Length 1 .. 3 Use optional WhiteSpace collapse
OverallDeclaration	Occurrence 1 .. 1 eTIR name Overall Declaration
Declaration	Occurrence 1 .. 1 eTIR name AdvancedCargoInformation Status R
ID	Occurrence 1 .. 1 Type ds:DeclarationIdentificationIDType WhiteSpace collapse Format an..35 eTIR name Reference Status R
<i>schemeID</i>	Type xs:token Use optional WhiteSpace collapse
<i>schemeAgencyID</i>	Type clm63055:AgencyIdentificationCodeContentType Length 1 .. 3 Use optional WhiteSpace collapse
TypeCode	Occurrence 1 .. 1 Type ds:DeclarationTypeCodeType WhiteSpace collapse Format an..3 eTIR name Type, coded Code List CL26 Message sub types Status R Restricted code(s) E10 Advanced cargo information results
<i>listID</i>	Type xs:token Use optional WhiteSpace collapse
<i>listAgencyID</i>	Type clm63055:AgencyIdentificationCodeContentType Length 1 .. 3 Use optional WhiteSpace collapse

AcceptanceDateTime	<p>Occurrence 0 .. 1 Type ds:DeclarationAcceptanceDateTimeType WhiteSpace collapse Format an..17 eTIR name Acceptance date Status D Condition C007</p>
<i>formatCode</i>	<p>Type clm62379:DateTimePeriodFormatCode Length 1 .. 3 Use required WhiteSpace collapse Name Date or time or period format code Description Code specifying the representation of a date, time or period.</p> <p>Applicable Codes</p> <p>102 CCYYMMDD Calendar date: C = Century ; Y = Year ; M = Month ; D = Day. 304 CCYYMMDDHHMMSSZZ See 204 plus Z=Time zone. 602 CCYY Calendar year including century: C = Century; Y = Year.</p>
FunctionCode	<p>Occurrence 1 .. 1 Type ds:DeclarationFunctionCodeType WhiteSpace collapse Format n..2 eTIR name Message function, coded Code List CL16 Message function code Status R Restricted code(s) 27 Not accepted Restricted code(s) 44 Accepted without reserves</p>
<i>listID</i>	<p>Type xs:token Use optional WhiteSpace collapse</p>
<i>listAgencyID</i>	<p>Type clm63055:AgencyIdentificationCodeContentType Length 1 .. 3 Use optional WhiteSpace collapse</p>
RejectionDateTime	<p>Occurrence 0 .. 1 Type ds:DeclarationRejectionDateTimeType WhiteSpace collapse Format an..17 eTIR name Rejection date Status D Condition C007</p>
<i>formatCode</i>	<p>Type clm62379:DateTimePeriodFormatCode Length 1 .. 3 Use required WhiteSpace collapse Name Date or time or period format code Description Code specifying the representation of a date, time or period.</p> <p>Applicable Codes</p> <p>102 CCYYMMDD Calendar date: C = Century ; Y = Year ; M = Month ; D = Day. 304 CCYYMMDDHHMMSSZZ See 204 plus Z=Time zone. 602 CCYY Calendar year including century: C = Century; Y = Year.</p>
Error	<p>Occurrence 0 .. unbounded eTIR name Error Status D Condition C006</p>

xs:sequence	Occurrence	1 .. 1
ValidationCode	Occurrence	1 .. 1
	Type	ds:ErrorValidationCodeType
	WhiteSpace	collapse
	Format	an..8
	eTIR name	Error, coded
	Code List	CL99 Error code (to be developed)
	Status	R
<i>listID</i>	Type	xs:token
	Use	optional
	WhiteSpace	collapse
<i>listAgencyID</i>	Type	clm63055:AgencyIdentificationCodeContentType
	Length	1 .. 3
	Use	optional
	WhiteSpace	collapse
Pointer	Occurrence	1 .. unbounded
	eTIR name	Pointer
	Status	R
xs:sequence	Occurrence	1 .. 1
SequenceNumeric	Occurrence	1 .. 1
	Type	ds:PointerSequenceNumericType
	Format	n..5
	eTIR name	Sequence number
	Status	R
DocumentSectionCode	Occurrence	1 .. 1
	Type	ds:PointerDocumentSectionCodeType
	WhiteSpace	collapse
	Format	an..3
	eTIR name	Document/message section, coded
	Code List	CL18 Message section code (codes to be defined)
	Status	R
<i>listID</i>	Type	xs:token
	Use	optional
	WhiteSpace	collapse
<i>listAgencyID</i>	Type	clm63055:AgencyIdentificationCodeContentType
	Length	1 .. 3
	Use	optional
	WhiteSpace	collapse
TagID	Occurrence	1 .. 1
	Type	ds:PointerTagIDType
	WhiteSpace	collapse
	Format	an..4
	eTIR name	Tag identifier
	Code List	CL19 Pointer code (codes to be defined)
	Status	R
<i>schemeID</i>	Type	xs:token
	Use	optional
	WhiteSpace	collapse
<i>schemeAgencyID</i>	Type	clm63055:AgencyIdentificationCodeContentType
	Length	1 .. 3
	Use	optional
	WhiteSpace	collapse

4.2.3.1.2. Internal messages

4.2.3.1.2.1. I1 – Accept guarantee

a. Structure

Occurance	Element/Attribute
1 .. 1	Message └ xs:sequence

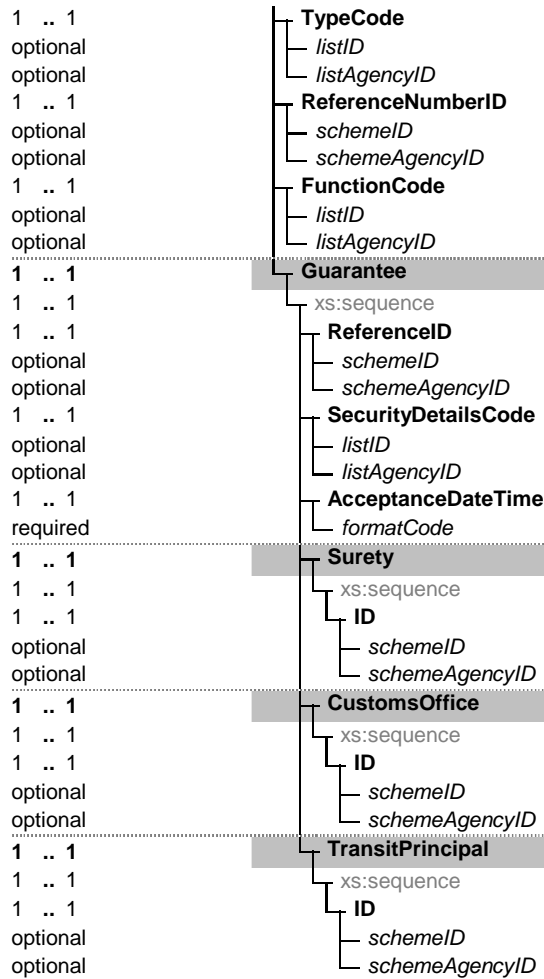

b. Guidelines

Element/Attribute	Annotation
Message	
xs:sequence	eTIR name Message
TypeCode	Occurrence 1 .. 1
	Type ds:MessageTypeCodeType
	WhiteSpace collapse
	Format an..3
	eTIR name Type, coded
	Status R
	Code List CL26 Message types
	Restricted l1 Accept guarantee
listID	Type xs:token
	Use optional
	WhiteSpace collapse
listAgencyID	Type clm63055:AgencyIdentificationCodeContentType
	Length 1 .. 3
	Use optional
	WhiteSpace collapse

ReferenceNumberID	Occurrence 1 .. 1 Type ds:MessageReferenceNumberIDType WhiteSpace collapse Format an..14 eTIR name Message reference number Status R
<i>schemeID</i>	Type xs:token Use optional WhiteSpace collapse
<i>schemeAgencyID</i>	Type clm63055:AgencyIdentificationCodeContentType Length 1 .. 3 Use optional WhiteSpace collapse
FunctionCode	Occurrence 1 .. 1 Type ds:MessageFunctionCodeType WhiteSpace collapse Format n..2 eTIR name Message function, coded Code List CL16 Message function code Status R Restricted code(s) 9 Original
<i>listID</i>	Type xs:token Use optional WhiteSpace collapse
<i>listAgencyID</i>	Type clm63055:AgencyIdentificationCodeContentType Length 1 .. 3 Use optional WhiteSpace collapse
Guarantee	Occurrence 1 .. 1 eTIR name Guarantee Status R
xs:sequence	Occurrence 1 .. 1
ReferenceID	Occurrence 1 .. 1 Type ds:GuaranteeReferenceIDType WhiteSpace collapse Format an..35 eTIR name Reference Status R
<i>schemeID</i>	Type xs:token Use optional WhiteSpace collapse
<i>schemeAgencyID</i>	Type clm63055:AgencyIdentificationCodeContentType Length 1 .. 3 Use optional WhiteSpace collapse
SecurityDetailsCode	Occurrence 1 .. 1 Type ds:GuaranteeSecurityDetailsCodeType WhiteSpace collapse Format an..3 eTIR name Guarantee type Code List CL12 Guarantee type code Status R
<i>listID</i>	Type xs:token Use optional WhiteSpace collapse
<i>listAgencyID</i>	Type clm63055:AgencyIdentificationCodeContentType Length 1 .. 3 Use optional WhiteSpace collapse
AcceptanceDateTime	Occurrence 1 .. 1 Type ds:GuaranteeAcceptanceDateTimeType WhiteSpace collapse Format n..17 eTIR name Acceptance date

<i>formatCode</i>	<p>Status R</p> <p>Type clm62379:DateTimePeriodFormatCode</p> <p>Length 1 .. 3</p> <p>Use required</p> <p>WhiteSpace collapse</p> <p>Name Date or time or period format code</p> <p>Description Code specifying the representation of a date, time or period.</p> <p>Applicable Codes</p> <p>102 CCYYMMDD Calendar date: C = Century ; Y = Year ; M = Month ; D = Day.</p> <p>304 CCYYMMDDHHMMSSZZ See 204 plus Z=Time zone.</p> <p>602 CCYY Calendar year including century: C = Century; Y = Year.</p>
Surety	<p>Occurrence 1 .. 1</p> <p>eTIR name GuaranteeChain</p> <p>Status R</p>
<i>xs:sequence</i>	
ID	<p>Occurrence 1 .. 1</p> <p>Type ds:SuretyIdentificationIDType</p> <p>WhiteSpace collapse</p> <p>Format an..17</p> <p>eTIR name Code</p> <p>Status R</p>
<i>schemeID</i>	<p>Type xs:token</p> <p>Use optional</p> <p>WhiteSpace collapse</p>
<i>schemeAgencyID</i>	<p>Type clm63055:AgencyIdentificationCodeContentType</p> <p>Length 1 .. 3</p> <p>Use optional</p> <p>WhiteSpace collapse</p>
CustomsOffice	<p>Occurrence 1 .. 1</p> <p>eTIR name CustomsOffice</p> <p>Status R</p>
<i>xs:sequence</i>	
ID	<p>Occurrence 1 .. 1</p> <p>Type ds:CustomsOfficeIdentificationIDType</p> <p>WhiteSpace collapse</p> <p>Format an..17</p> <p>eTIR name Customs office, coded</p> <p>Code List CL13 Customs offices database (to be developed)</p> <p>Status R</p>
<i>schemeID</i>	<p>Type xs:token</p> <p>Use optional</p> <p>WhiteSpace collapse</p>
<i>schemeAgencyID</i>	<p>Type clm63055:AgencyIdentificationCodeContentType</p> <p>Length 1 .. 3</p> <p>Use optional</p> <p>WhiteSpace collapse</p>
TransitPrincipal	<p>Occurrence 1 .. 1</p> <p>eTIR name Holder</p> <p>Status R</p>
<i>xs:sequence</i>	
ID	<p>Occurrence 1 .. 1</p> <p>Type ds:TransitPrincipalIdentificationIDType</p> <p>WhiteSpace collapse</p> <p>Format an..17</p> <p>eTIR name Code</p> <p>Code List CL15 International TIR database</p> <p>Status R</p>
<i>schemeID</i>	<p>Type xs:token</p> <p>Use optional</p> <p>WhiteSpace collapse</p>

└ <i>schemeAgencyID</i>	Type	clm63055:AgencyIdentificationCodeContentType
	Length	1 .. 3
	Use	optional
	WhiteSpace	collapse

4.2.3.1.2.2. I2 – Acceptance results

a. Structure

Occurance	Element/Attribute
1 .. 1	Message
1 .. 1	└ xs:sequence
optional	└ TypeCode
optional	└ <i>listID</i>
optional	└ <i>listAgencyID</i>
1 .. 1	└ ReferenceNumberID
optional	└ <i>schemeID</i>
optional	└ <i>schemeAgencyID</i>
1 .. 1	└ FunctionCode
optional	└ <i>listID</i>
optional	└ <i>listAgencyID</i>
1 .. 1	└ Guarantee
1 .. 1	└ xs:sequence
1 .. 1	└ ReferenceID
optional	└ <i>schemeID</i>
optional	└ <i>schemeAgencyID</i>
0 .. unbounded	└ Error
1 .. 1	└ xs:sequence
1 .. 1	└ ValidationCode
optional	└ <i>listID</i>
optional	└ <i>listAgencyID</i>
1 .. unbounded	└ Pointer
1 .. 1	└ xs:sequence
1 .. 1	└ SequenceNumeric
1 .. 1	└ DocumentSectionCode
optional	└ <i>listID</i>
optional	└ <i>listAgencyID</i>
1 .. 1	└ TagID
optional	└ <i>schemeID</i>
optional	└ <i>schemeAgencyID</i>

b. Guidelines

Element/Attribute	Annotation
Message	
└ xs:sequence	eTIR name Message
└ TypeCode	Occurence 1 .. 1
	Occurence 1 .. 1
	Type ds:MessageTypeCodeType
	WhiteSpace collapse
	Format an..3
	eTIR name Type, coded
	Status R
	Code List CL26 Message types
	Restricted I2 Acceptance results
	code(s)

<i>listID</i>	Type	xs:token
	Use	optional
	WhiteSpace	collapse
<i>listAgencyID</i>	Type	clm63055:AgencyIdentificationCodeContentType
	Length	1 .. 3
	Use	optional
	WhiteSpace	collapse
ReferenceNumberID	Occurrence	1 .. 1
	Type	ds:MessageReferenceNumberIDType
	WhiteSpace	collapse
	Format	an..14
	eTIR name	Message reference number
	Status	R
<i>schemeID</i>	Type	xs:token
	Use	optional
	WhiteSpace	collapse
<i>schemeAgencyID</i>	Type	clm63055:AgencyIdentificationCodeContentType
	Length	1 .. 3
	Use	optional
	WhiteSpace	collapse
FunctionCode	Occurrence	1 .. 1
	Type	ds:MessageFunctionCodeType
	WhiteSpace	collapse
	Format	n..2
	eTIR name	Message function, coded
	Code List	CL16 Message function code
	Status	R
	Restricted code(s)	27 Not accepted
	Restricted code(s)	44 Accepted without reserves
<i>listID</i>	Type	xs:token
	Use	optional
	WhiteSpace	collapse
<i>listAgencyID</i>	Type	clm63055:AgencyIdentificationCodeContentType
	Length	1 .. 3
	Use	optional
	WhiteSpace	collapse
Guarantee	Occurrence	1 .. 1
	eTIR name	Guarantee
	Status	R
xs:sequence	Occurrence	1 .. 1
ReferenceID	Occurrence	1 .. 1
	Type	ds:GuaranteeReferenceIDType
	WhiteSpace	collapse
	Format	an..35
	eTIR name	Reference
	Status	R
<i>schemeID</i>	Type	xs:token
	Use	optional
	WhiteSpace	collapse
<i>schemeAgencyID</i>	Type	clm63055:AgencyIdentificationCodeContentType
	Length	1 .. 3
	Use	optional
	WhiteSpace	collapse
Error	Occurrence	0 .. unbounded
	eTIR name	Error
	Status	D
	Condition	C006
xs:sequence	Occurrence	1 .. 1
ValidationCode	Occurrence	1 .. 1
	Type	ds:ErrorValidationCodeType
	WhiteSpace	collapse
	Format	an..8
	eTIR name	Error, coded

	Code List	CL99	Error code (to be developed)
	Status	R	
<i>listID</i>	Type	xs:token	
	Use	optional	
	WhiteSpace	collapse	
<i>listAgencyID</i>	Type	clm63055:AgencyIdentificationCodeContentType	
	Length	1 .. 3	
	Use	optional	
	WhiteSpace	collapse	
Pointer	Occurrence	1 .. unbounded	
	eTIR name	Pointer	
	Status	R	
<i>xs:sequence</i>	Occurrence	1 .. 1	
SequenceNumeric	Occurrence	1 .. 1	
	Type	ds:PointerSequenceNumericType	
	Format	n..5	
	eTIR name	Sequence number	
	Status	R	
DocumentSectionCode	Occurrence	1 .. 1	
	Type	ds:PointerDocumentSectionCodeType	
	WhiteSpace	collapse	
	Format	an..3	
	eTIR name	Document/message section, coded	
	Code List	CL18	Message section code (codes to be defined)
	Status	R	
<i>listID</i>	Type	xs:token	
	Use	optional	
	WhiteSpace	collapse	
<i>listAgencyID</i>	Type	clm63055:AgencyIdentificationCodeContentType	
	Length	1 .. 3	
	Use	optional	
	WhiteSpace	collapse	
TagID	Occurrence	1 .. 1	
	Type	ds:PointerTagIDType	
	WhiteSpace	collapse	
	Format	an..4	
	eTIR name	Tag identifier	
	Code List	CL19	Pointer code (codes to be defined)
	Status	R	
<i>schemeID</i>	Type	xs:token	
	Use	optional	
	WhiteSpace	collapse	
<i>schemeAgencyID</i>	Type	clm63055:AgencyIdentificationCodeContentType	
	Length	1 .. 3	
	Use	optional	
	WhiteSpace	collapse	

4.2.3.1.2.3. I3 – Get Holder information

a. Structure

Occurance	Element/Attribute
1 .. 1	Message
1 .. 1	<i>xs:sequence</i>
optional	TypeCode
optional	<i>listID</i>
1 .. 1	<i>listAgencyID</i>
optional	ReferenceNumberID
optional	<i>schemeID</i>
optional	<i>schemeAgencyID</i>

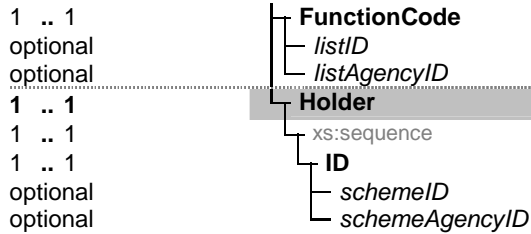

b. Guidelines

Element/Attribute	Annotation
Message	eTIR name Message
xs:sequence	Occurrence 1 .. 1
TypeCode	Occurrence 1 .. 1
	Type ds:MessageTypeCodeType
	WhiteSpace collapse
	Format an..3
	eTIR name Type, coded
	Status R
	Code List CL26 Message types
	Restricted code(s) I3 Get holder information
listID	Type xs:token
	Use optional
	WhiteSpace collapse
listAgencyID	Type cim63055:AgencyIdentificationCodeContentType
	Length 1 .. 3
	Use optional
	WhiteSpace collapse
ReferenceNumberID	Occurrence 1 .. 1
	Type ds:MessageReferenceNumberIDType
	WhiteSpace collapse
	Format an..14
	eTIR name Message reference number
	Status R
schemeID	Type xs:token
	Use optional
	WhiteSpace collapse
schemeAgencyID	Type cim63055:AgencyIdentificationCodeContentType
	Length 1 .. 3
	Use optional
	WhiteSpace collapse
FunctionCode	Occurrence 1 .. 1
	Type ds:MessageFunctionCodeType
	WhiteSpace collapse
	Format n..2
	eTIR name Message function, coded
	Code List CL16 Message function code
	Status R
	Restricted code(s) 9 Original
listID	Type xs:token
	Use optional
	WhiteSpace collapse
listAgencyID	Type cim63055:AgencyIdentificationCodeContentType
	Length 1 .. 3
	Use optional
	WhiteSpace collapse
Holder	Occurrence 1 .. 1
	eTIR name Holder
	Status R

xs:sequence	Occurrence	1 .. 1
ID	Occurrence	1 .. 1
	Type	ds:HolderIdentificationIDType
	WhiteSpace	collapse
	Format	an..17
	eTIR name	Code
	Code List	CL15 International TIR database
	Status	R
<i>schemeID</i>	Type	xs:token
	Use	optional
	WhiteSpace	collapse
<i>schemeAgencyID</i>	Type	clm63055:AgencyIdentificationCodeContentType
	Length	1 .. 3
	Use	optional
	WhiteSpace	collapse

4.2.3.1.2.4. I4 – Holder information

a. Structure

Occurance	Element/Attribute
	Message
1 .. 1	xs:sequence
1 .. 1	TypeCode
optional	<i>listID</i>
optional	<i>listAgencyID</i>
1 .. 1	ReferenceNumberID
optional	<i>schemeID</i>
optional	<i>schemeAgencyID</i>
1 .. 1	FunctionCode
optional	<i>listID</i>
optional	<i>listAgencyID</i>
1 .. 1	Holder
1 .. 1	xs:sequence
1 .. 1	Name
optional	<i>languageID</i>
1 .. 1	ID
optional	<i>schemeID</i>
optional	<i>schemeAgencyID</i>
1 .. 1	CurrentStatusCode
optional	<i>listID</i>
optional	<i>listAgencyID</i>
1 .. 1	Address
1 .. 1	xs:sequence
1 .. 1	CityName
optional	<i>languageID</i>
1 .. 1	CountryCode
optional	<i>listID</i>
optional	<i>listAgencyID</i>
1 .. 1	Line
optional	<i>languageID</i>
1 .. 1	PostcodeID
optional	<i>schemeID</i>
optional	<i>schemeAgencyID</i>
0 .. 1	ActiveWithdrawal
1 .. 1	xs:sequence
1 .. 1	StartDateTime
required	<i>formatCode</i>
0 .. 1	EndDateTime
required	<i>formatCode</i>

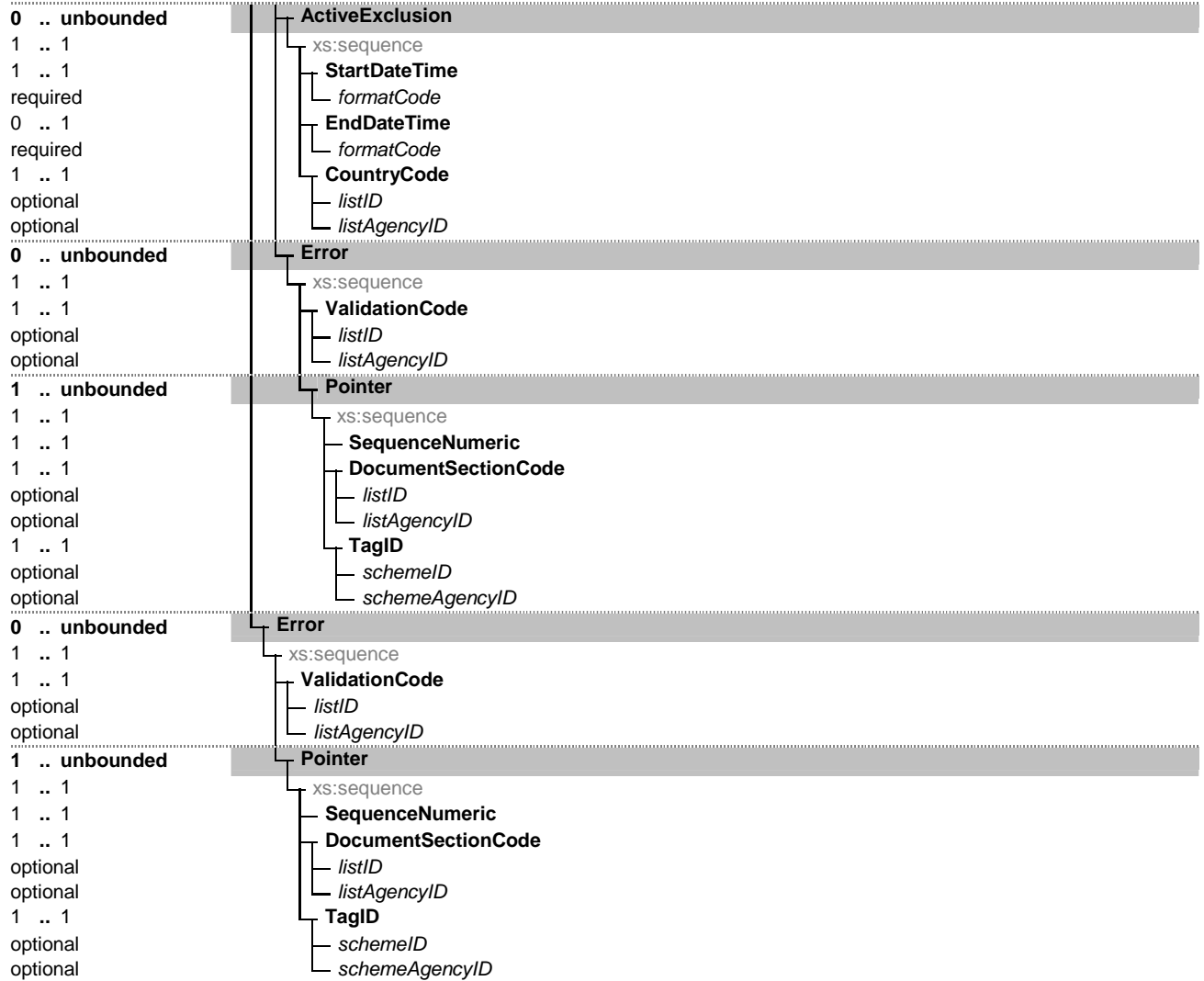

b. Guidelines

Element/Attribute	Annotation
Message	
xs:sequence	eTIR name Message
TypeCode	Occurrence 1 .. 1
	Occurrence 1 .. 1
	Type ds:MessageTypeCodeType
	WhiteSpace collapse
	Format an..3
	eTIR name Type, coded
	Status R
	Code List CL26 Message types
	Restricted I4 Holder information
	code(s)
listID	Type xs:token
	Use optional
	WhiteSpace collapse
listAgencyID	Type ctm63055:AgencyIdentificationCodeContentType
	Length 1 .. 3
	Use optional
	WhiteSpace collapse

ReferenceNumberID	<p>Occurrence 1 .. 1</p> <p>Type ds:MessageReferenceNumberIDType</p> <p>WhiteSpace collapse</p> <p>Format an..14</p> <p>eTIR name Message reference number</p> <p>Status R</p>
<i>schemeID</i>	<p>Type xs:token</p> <p>Use optional</p> <p>WhiteSpace collapse</p>
<i>schemeAgencyID</i>	<p>Type clm63055:AgencyIdentificationCodeContentType</p> <p>Length 1 .. 3</p> <p>Use optional</p> <p>WhiteSpace collapse</p>
FunctionCode	<p>Occurrence 1 .. 1</p> <p>Type ds:MessageFunctionCodeType</p> <p>WhiteSpace collapse</p> <p>Format n..2</p> <p>eTIR name Message function, coded</p> <p>Code List CL16 Message function code</p> <p>Status R</p> <p>Restricted code(s) 10 Not found</p> <p>Restricted code(s) 11 Response</p>
<i>listID</i>	<p>Type xs:token</p> <p>Use optional</p> <p>WhiteSpace collapse</p>
<i>listAgencyID</i>	<p>Type clm63055:AgencyIdentificationCodeContentType</p> <p>Length 1 .. 3</p> <p>Use optional</p> <p>WhiteSpace collapse</p>
Holder	<p>Occurrence 1 .. 1</p> <p>eTIR name Holder</p> <p>Status R</p>
xs:sequence	<p>Occurrence 1 .. 1</p>
Name	<p>Occurrence 1 .. 1</p> <p>Type ds:HolderNameTextType</p> <p>Format an..70</p> <p>eTIR name Name</p> <p>Status R</p>
<i>languageID</i>	<p>Type xs:language</p> <p>Use optional</p> <p>Pattern ([a-zA-Z]{2} [iI]-[a-zA-Z]+ [xX]-[a-zA-Z]{1,8}){1,8}</p> <p>WhiteSpace collapse</p>
ID	<p>Occurrence 1 .. 1</p> <p>Type ds:HolderIdentificationIDType</p> <p>WhiteSpace collapse</p> <p>Format an..17</p> <p>eTIR name Code</p> <p>Code List CL15 International TIR database</p> <p>Status R</p>
<i>schemeID</i>	<p>Type xs:token</p> <p>Use optional</p> <p>WhiteSpace collapse</p>
<i>schemeAgencyID</i>	<p>Type clm63055:AgencyIdentificationCodeContentType</p> <p>Length 1 .. 3</p> <p>Use optional</p> <p>WhiteSpace collapse</p>
CurrentStatusCode	<p>Occurrence 1 .. 1</p> <p>Type ds:HolderCurrentStatusCodeType</p> <p>WhiteSpace collapse</p> <p>Code List CL23 Holder status</p> <p>eTIR name Current status</p> <p>Format an..3</p>

	Status	R
listID	Type	xs:token
	Use	optional
	WhiteSpace	collapse
listAgencyID	Type	clm63055:AgencyIdentificationCodeContentType
	Length	1 .. 3
	Use	optional
	WhiteSpace	collapse
Address	Occurrence	1 .. 1
	eTIR name	Address
	Status	R
xs:sequence	Occurrence	1 .. 1
CityName	Occurrence	1 .. 1
	Type	ds:AddressCityNameTextType
	Format	an..35
	eTIR name	City name
	Status	R
languageID	Type	xs:language
	Use	optional
	Pattern	([a-zA-Z]{2} [iI]-[a-zA-Z]+[xX]-[a-zA-Z]{1,8})-[a-zA-Z]{1,8})*
	WhiteSpace	collapse
CountryCode	Occurrence	1 .. 1
	Type	ds:AddressCountryCodeType
	WhiteSpace	collapse
	Format	a2
	Code List	CL04 Country name code
	eTIR name	Country, coded
	Status	R
listID	Type	xs:token
	Use	optional
	WhiteSpace	collapse
listAgencyID	Type	clm63055:AgencyIdentificationCodeContentType
	Length	1 .. 3
	Use	optional
	WhiteSpace	collapse
Line	Occurrence	1 .. 1
	Type	ds:AddressLineTextType
	Format	an..70
	eTIR name	Street and number/P.O. Box
	Status	R
languageID	Type	xs:language
	Use	optional
	Pattern	([a-zA-Z]{2} [iI]-[a-zA-Z]+[xX]-[a-zA-Z]{1,8})-[a-zA-Z]{1,8})*
	WhiteSpace	collapse
PostcodeID	Occurrence	1 .. 1
	Type	ds:AddressPostcodeIDType
	WhiteSpace	collapse
	Format	an..9
	eTIR name	Postcode identification
	Status	R
schemeID	Type	xs:token
	Use	optional
	WhiteSpace	collapse
schemeAgencyID	Type	clm63055:AgencyIdentificationCodeContentType
	Length	1 .. 3
	Use	optional
	WhiteSpace	collapse
ActiveWithdrawal	Occurrence	0 .. 1
	eTIR name	ActiveWithdrawal
	Status	O
xs:sequence	Occurrence	1 .. 1

<p>StartDateTime</p>	<p>Occurrence 1 .. 1 Type ds:ActiveWithdrawalStartDateTimeType WhiteSpace collapse eTIR name Start Format n..17 Status R</p>
<p>└─ <i>formatCode</i></p>	<p>Type clm62379:DateTimePeriodFormatCode Length 1 .. 3 Use required WhiteSpace collapse Name Date or time or period format code Description Code specifying the representation of a date, time or period.</p> <p>Applicable Codes</p> <p>102 CCYYMMDD Calendar date: C = Century ; Y = Year ; M = Month ; D = Day. 304 CCYYMMDDHHMMSSZZ See 204 plus Z=Time zone. 602 CCYY Calendar year including century: C = Century; Y = Year.</p>
<p>EndDateTime</p>	<p>Occurrence 0 .. 1 Type ds:ActiveWithdrawalEndTimeType WhiteSpace collapse eTIR name End Format n..17 Status O</p>
<p>└─ <i>formatCode</i></p>	<p>Type clm62379:DateTimePeriodFormatCode Length 1 .. 3 Use required WhiteSpace collapse Name Date or time or period format code Description Code specifying the representation of a date, time or period.</p> <p>Applicable Codes</p> <p>102 CCYYMMDD Calendar date: C = Century ; Y = Year ; M = Month ; D = Day. 304 CCYYMMDDHHMMSSZZ See 204 plus Z=Time zone. 602 CCYY Calendar year including century: C = Century; Y = Year.</p>
<p>ActiveExclusion</p>	<p>Occurrence 0 .. unbounded eTIR name ActiveExclusion Status O</p>
<p>└─ xs:sequence</p>	<p>Occurrence 1 .. 1</p>
<p>StartDateTime</p>	<p>Occurrence 1 .. 1 Type ds:ActiveExclusionStartDateTimeType WhiteSpace collapse eTIR name Start Format n..17 Status R</p>
<p>└─ <i>formatCode</i></p>	<p>Type clm62379:DateTimePeriodFormatCode Length 1 .. 3 Use required WhiteSpace collapse Name Date or time or period format code Description Code specifying the representation of a date, time or period.</p> <p>Applicable Codes</p> <p>102 CCYYMMDD Calendar date: C = Century ; Y = Year ; M = Month ; D = Day. 304 CCYYMMDDHHMMSSZZ See 204 plus Z=Time zone.</p>

EndDateTime	<p>602 CCYY Calendar year including century: C = Century; Y = Year.</p> <p>Occurrence 0 .. 1 Type ds:ActiveExclusionEndDateType WhiteSpace collapse eTIR name End Format n..17 Status O</p>
- <i>formatCode</i>	<p>Type clm62379:DateTimePeriodFormatCode Length 1 .. 3 Use required WhiteSpace collapse Name Date or time or period format code Description Code specifying the representation of a date, time or period.</p>
Applicable Codes	
	<p>102 CCYYMMDD Calendar date: C = Century ; Y = Year ; M = Month ; D = Day.</p>
	<p>304 CCYYMMDDHHMMSSZZ See 204 plus Z=Time zone.</p>
CountryCode	<p>602 CCYY Calendar year including century: C = Century; Y = Year.</p> <p>Occurrence 1 .. 1 Type ds:ActiveExclusionCountryCodeType WhiteSpace collapse Code List CL04 Country name code eTIR name Country, coded Format a2 Status R</p>
- <i>listID</i>	<p>Type xs:token Use optional WhiteSpace collapse</p>
- <i>listAgencyID</i>	<p>Type clm63055:AgencyIdentificationCodeContentType Length 1 .. 3 Use optional WhiteSpace collapse</p>
Error	<p>Occurrence 0 .. unbounded eTIR name Error Status O</p>
- <i>xs:sequence</i>	<p>Occurrence 1 .. 1</p>
ValidationCode	<p>Occurrence 1 .. 1 Type ds:ErrorValidationCodeType WhiteSpace collapse Format an..8 eTIR name Error, coded Code List CL99 Error code (to be developed) Status R</p>
- <i>listID</i>	<p>Type xs:token Use optional WhiteSpace collapse</p>
- <i>listAgencyID</i>	<p>Type clm63055:AgencyIdentificationCodeContentType Length 1 .. 3 Use optional WhiteSpace collapse</p>
Pointer	<p>Occurrence 1 .. unbounded eTIR name Pointer Status R</p>
- <i>xs:sequence</i>	<p>Occurrence 1 .. 1</p>
SequenceNumeric	<p>Occurrence 1 .. 1 Type ds:PointerSequenceNumericType Format n..5 eTIR name Sequence number Status R</p>

DocumentSectionCode	<p>Occurrence 1 .. 1</p> <p>Type ds:PointerDocumentSectionCodeType</p> <p>WhiteSpace collapse</p> <p>Format an..3</p> <p>eTIR name Document/message section, coded</p> <p>Code List CL18 Message section code (codes to be defined)</p>
<i>listID</i>	<p>Status R</p> <p>Type xs:token</p> <p>Use optional</p> <p>WhiteSpace collapse</p>
<i>listAgencyID</i>	<p>Type clm63055:AgencyIdentificationCodeContentType</p> <p>Length 1 .. 3</p> <p>Use optional</p> <p>WhiteSpace collapse</p>
TagID	<p>Occurrence 1 .. 1</p> <p>Type ds:PointerTagIDType</p> <p>WhiteSpace collapse</p> <p>Format an..4</p> <p>eTIR name Tag identifier</p> <p>Code List CL19 Pointer code (codes to be defined)</p> <p>Status R</p>
<i>schemeID</i>	<p>Type xs:token</p> <p>Use optional</p> <p>WhiteSpace collapse</p>
<i>schemeAgencyID</i>	<p>Type clm63055:AgencyIdentificationCodeContentType</p> <p>Length 1 .. 3</p> <p>Use optional</p> <p>WhiteSpace collapse</p>
Error	<p>Occurrence 0 .. unbounded</p> <p>eTIR name Error</p> <p>Status D</p> <p>Condition C006</p>
xs:sequence	<p>Occurrence 1 .. 1</p>
ValidationCode	<p>Occurrence 1 .. 1</p> <p>Type ds:ErrorValidationCodeType</p> <p>WhiteSpace collapse</p> <p>Format an..8</p> <p>eTIR name Error, coded</p> <p>Code List CL99 Error code (to be developed)</p> <p>Status R</p>
<i>listID</i>	<p>Type xs:token</p> <p>Use optional</p> <p>WhiteSpace collapse</p>
<i>listAgencyID</i>	<p>Type clm63055:AgencyIdentificationCodeContentType</p> <p>Length 1 .. 3</p> <p>Use optional</p> <p>WhiteSpace collapse</p>
Pointer	<p>Occurrence 1 .. unbounded</p> <p>eTIR name Pointer</p> <p>Status R</p>
xs:sequence	<p>Occurrence 1 .. 1</p>
SequenceNumeric	<p>Occurrence 1 .. 1</p> <p>Type ds:PointerSequenceNumericType</p> <p>Format n..5</p> <p>eTIR name Sequence number</p> <p>Status R</p>
DocumentSectionCode	<p>Occurrence 1 .. 1</p> <p>Type ds:PointerDocumentSectionCodeType</p> <p>WhiteSpace collapse</p> <p>Format an..3</p> <p>eTIR name Document/message section, coded</p> <p>Code List CL18 Message section code (codes to be defined)</p> <p>Status R</p>

<i>listID</i>	Type Use WhiteSpace	xs:token optional collapse
<i>listAgencyID</i>	Type Length Use WhiteSpace	clm63055:AgencyIdentificationCodeContentType 1 .. 3 optional collapse
TagID	Occurrence Type WhiteSpace Format eTIR name Code List Status	1 .. 1 ds:PointerTagIDType collapse an..4 Tag identifier CL19 Pointer code (codes to be defined) R
<i>schemeID</i>	Type Use WhiteSpace	xs:token optional collapse
<i>schemeAgencyID</i>	Type Length Use WhiteSpace	clm63055:AgencyIdentificationCodeContentType 1 .. 3 optional collapse

4.2.3.1.2.5. I5 – Query guarantee

a. Structure

Occurance	Element/Attribute
1 .. 1	Message
1 .. 1	xs:sequence
optional	TypeCode
optional	<i>listID</i>
optional	<i>listAgencyID</i>
1 .. 1	SubTypeCode
optional	<i>listID</i>
optional	<i>listAgencyID</i>
1 .. 1	ReferenceNumberID
optional	<i>schemeID</i>
optional	<i>schemeAgencyID</i>
1 .. 1	FunctionCode
optional	<i>listID</i>
optional	<i>listAgencyID</i>
1 .. 1	Guarantee
1 .. 1	xs:sequence
1 .. 1	ReferenceID
optional	<i>schemeID</i>
optional	<i>schemeAgencyID</i>

b. Guidelines

Element/Attribute	Annotation
Message	eTIR name Message
xs:sequence	Occurrence 1 .. 1
TypeCode	Occurrence 1 .. 1
	Type ds:MessageTypeCodeType
	WhiteSpace collapse
	Format an..3
	eTIR name Type, coded
	Status R
	Code List CL26 Message types

	Restricted code(s)	I5	Query guarantee
listID	Type	xs:token	
	Use	optional	
	WhiteSpace	collapse	
listAgencyID	Type	clm63055:AgencyIdentificationCodeContentType	
	Length	1 .. 3	
	Use	optional	
	WhiteSpace	collapse	
SubTypeCode	Occurrence	1 .. 1	
	Type	ds:MessageSubTypeCodeType	
	WhiteSpace	collapse	
	Format	an..6	
	eTIR name	Sub type, coded	
	Code List	CL09	Message sub type
	Restricted code(s)	00	Return all information regarding guarantee (default)
	Restricted code(s)	01	Return only guarantee information
	Restricted code(s)	02	Return only declaration information
	Restricted code(s)	03	Return only TIR transport information
	Status	R	
listID	Type	xs:token	
	Use	optional	
	WhiteSpace	collapse	
listAgencyID	Type	clm63055:AgencyIdentificationCodeContentType	
	Length	1 .. 3	
	Use	optional	
	WhiteSpace	collapse	
ReferenceNumberID	Occurrence	1 .. 1	
	Type	ds:MessageReferenceNumberIDType	
	WhiteSpace	collapse	
	Format	an..14	
	eTIR name	Message reference number	
	Status	R	
schemeID	Type	xs:token	
	Use	optional	
	WhiteSpace	collapse	
schemeAgencyID	Type	clm63055:AgencyIdentificationCodeContentType	
	Length	1 .. 3	
	Use	optional	
	WhiteSpace	collapse	
FunctionCode	Occurrence	1 .. 1	
	Type	ds:MessageFunctionCodeType	
	WhiteSpace	collapse	
	Format	n..2	
	eTIR name	Message function, coded	
	Code List	CL16	Message function code
	Status	R	
	Restricted code(s)	9	Original
listID	Type	xs:token	
	Use	optional	
	WhiteSpace	collapse	
listAgencyID	Type	clm63055:AgencyIdentificationCodeContentType	
	Length	1 .. 3	
	Use	optional	
	WhiteSpace	collapse	
Guarantee	Occurrence	1 .. 1	
	eTIR name	Guarantee	
	Status	R	
xs:sequence	Occurrence	1 .. 1	

ReferenceID	Occurrence	1 .. 1
	Type	ds:GuaranteeReferenceIDType
	WhiteSpace	collapse
	Format	an..35
	eTIR name	Reference
	Status	R
schemeID	Type	xs:token
	Use	optional
	WhiteSpace	collapse
schemeAgencyID	Type	clm63055:AgencyIdentificationCodeContentType
	Length	1 .. 3
	Use	optional
	WhiteSpace	collapse

4.2.3.1.2.6. I6 – Query results

a. Structure

Occurance	Element/Attribute
	Message
1 .. 1	xs:sequence
1 .. 1	TypeCode
optional	listID
optional	listAgencyID
1 .. 1	ReferenceNumberID
optional	schemeID
optional	schemeAgencyID
1 .. 1	FunctionCode
optional	listID
optional	listAgencyID
1 .. 1	Guarantee
1 .. 1	xs:sequence
1 .. 1	ReferenceID
optional	schemeID
optional	schemeAgencyID
1 .. 1	LPCOExpirationDateTime
required	formatCode
1 .. 1	SecurityDetailsCode
optional	listID
optional	listAgencyID
1 .. 1	GuaranteeStatusCode
optional	listID
optional	listAgencyID
1 .. 1	Surety
1 .. 1	xs:sequence
1 .. 1	ID
optional	schemeID
optional	schemeAgencyID
0 .. unbounded	TIROperation
1 .. 1	xs:sequence
1 .. 1	SequenceNumeric
1 .. 1	RegistrationNumberID
optional	schemeID
optional	schemeAgencyID
0 .. 1	Start
1 .. 1	xs:sequence
1 .. 1	DateDateTime
required	formatCode
0 .. 1	TimeLimitDateTime

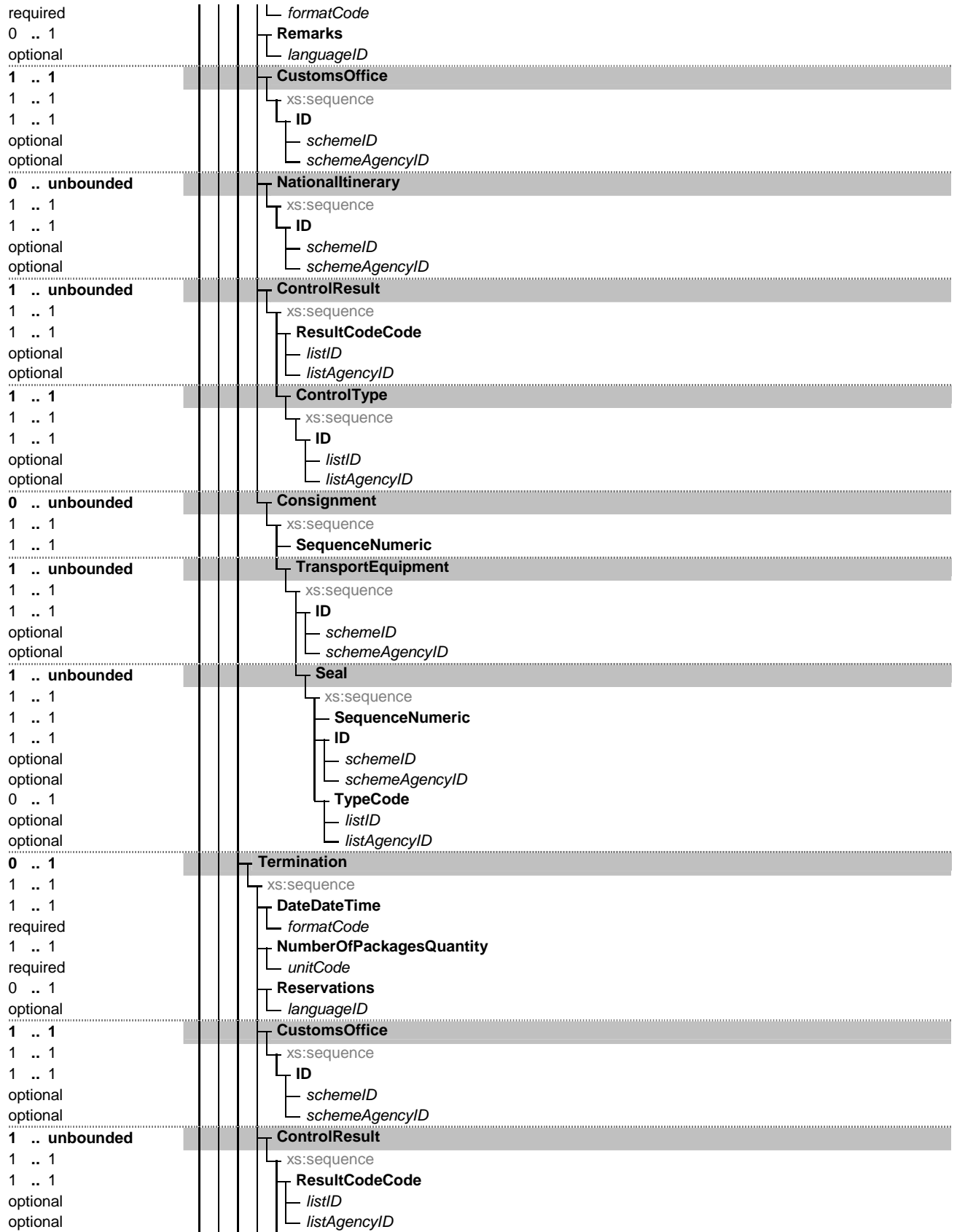

1 .. 1	ControlType	xs:sequence	ID	
1 .. 1				listID
optional				listAgencyID
optional				
0 .. unbounded	Consignment	xs:sequence	SequenceNumeric	
1 .. 1				
1 .. 1				
1 .. unbounded	TransportEquipment	xs:sequence	ID	
1 .. 1				schemeID
optional				schemeAgencyID
optional				
1 .. unbounded	Seal	xs:sequence	SequenceNumeric	
1 .. 1				ID
1 .. 1				
optional				schemeAgencyID
optional				TypeCode
0 .. 1				listID
optional	listAgencyID			
optional				
0 .. 1	Discharge	xs:sequence	DateDateTime	
1 .. 1				formatCode
required				
1 .. 1	CustomsOffice	xs:sequence	ID	
1 .. 1				schemeID
optional				schemeAgencyID
optional				
1 .. 1	TransitPrincipal	xs:sequence	Name	
1 .. 1				languageID
optional				ID
1 .. 1				
optional				schemeAgencyID
optional				CurrentStatusCode
1 .. 1	listID			
optional	listAgencyID			
optional				
1 .. 1	Address	xs:sequence	CityName	
1 .. 1				languageID
optional				CountryCode
1 .. 1				
optional				listAgencyID
optional				Line
1 .. 1				
optional				PostcodeID
1 .. 1	schemeID			
optional	schemeAgencyID			
optional				
0 .. 1	ActiveWithdrawal	xs:sequence	StartDateTime	
1 .. 1				formatCode
required				EndDateTime
0 .. 1				
required				

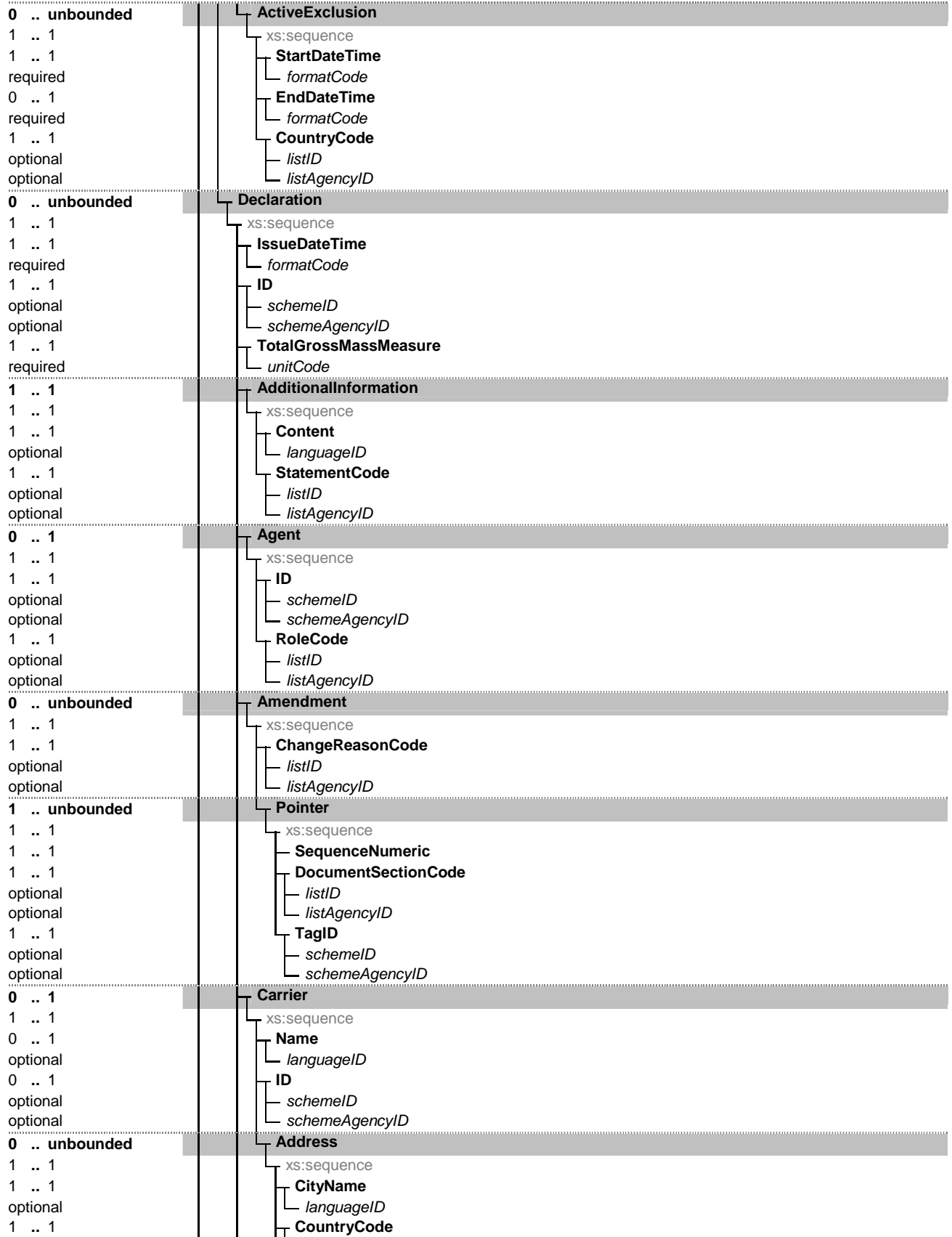

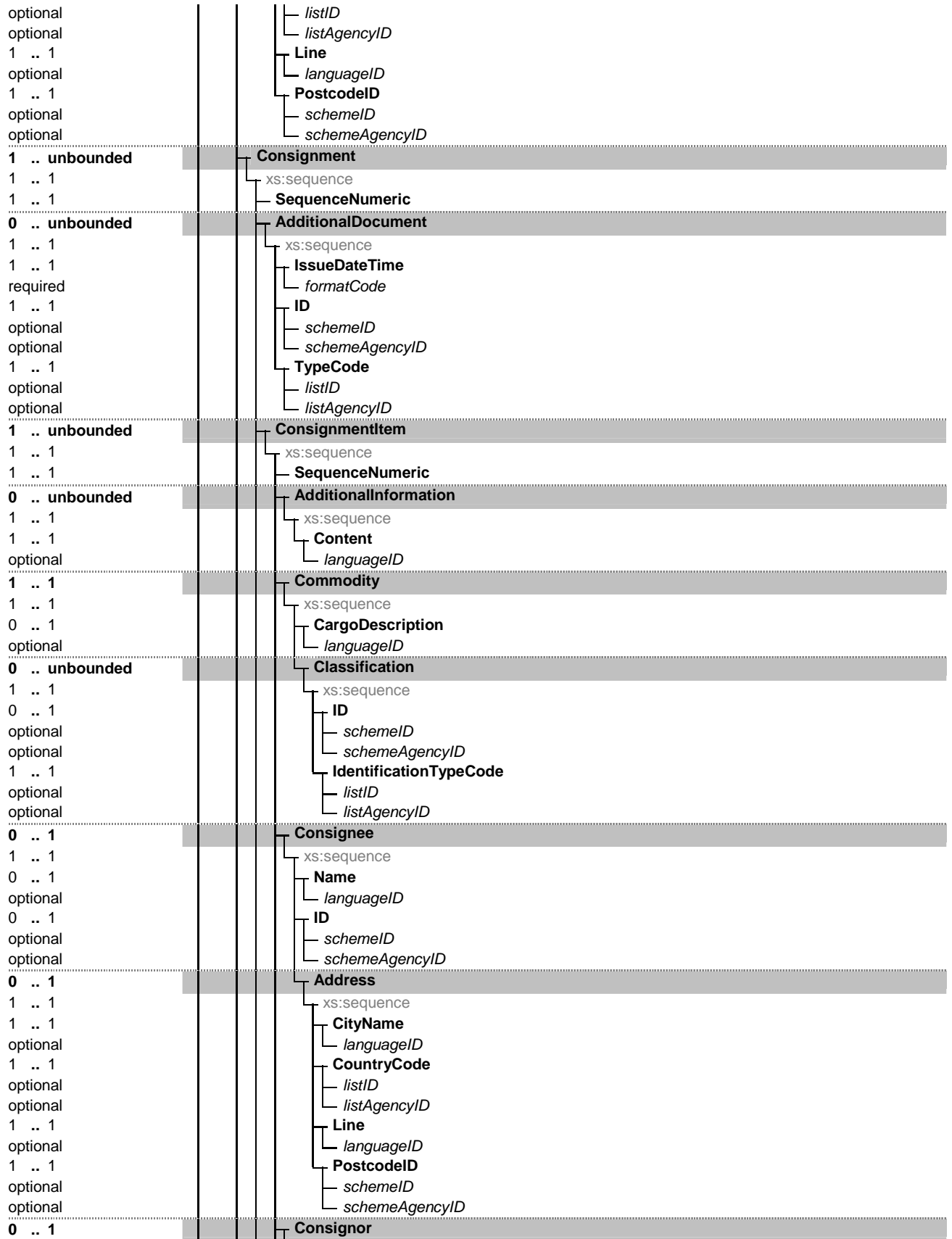

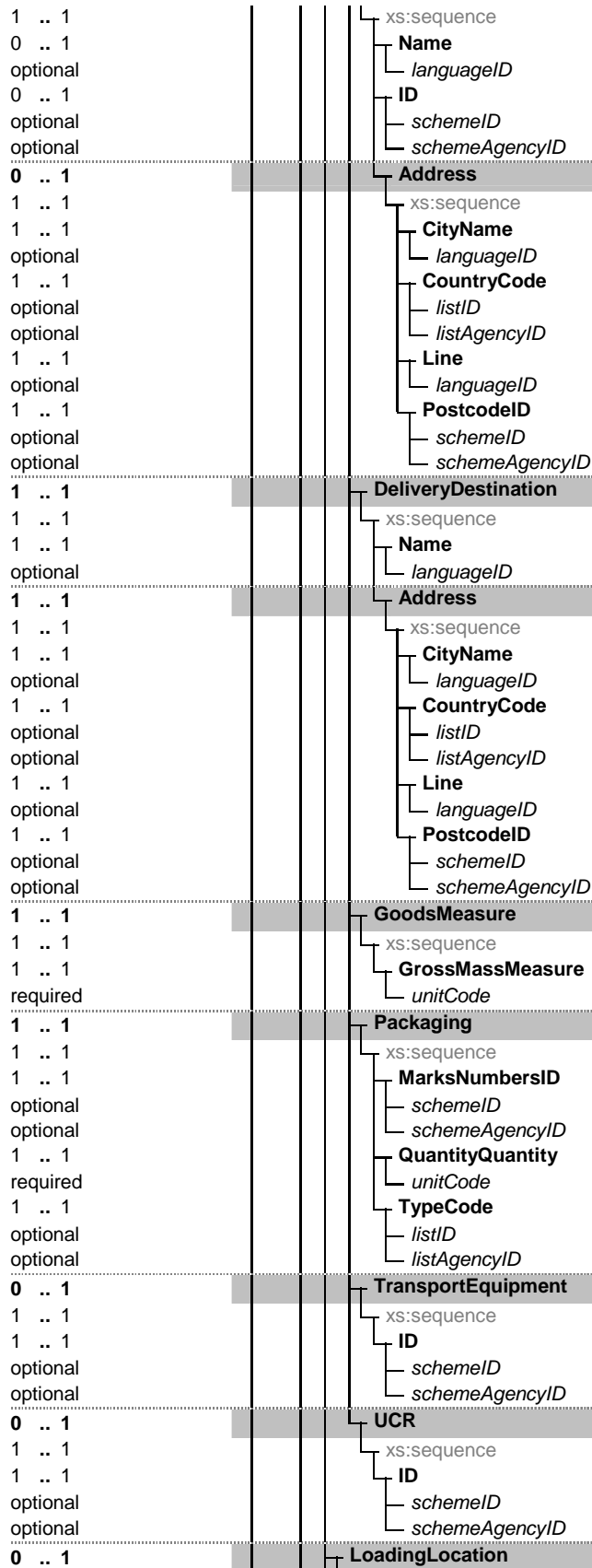

1 .. 1		xs:sequence
1 .. 1		Name
optional		<i>languageID</i>
0 .. 1		NotifyParty
1 .. 1		xs:sequence
0 .. 1		Name
optional		<i>languageID</i>
0 .. 1		ID
optional		<i>schemeID</i>
optional		<i>schemeAgencyID</i>
0 .. 1		Address
1 .. 1		xs:sequence
1 .. 1		CityName
optional		<i>languageID</i>
1 .. 1		CountryCode
optional		<i>listID</i>
optional		<i>listAgencyID</i>
1 .. 1		Line
optional		<i>languageID</i>
1 .. 1		PostcodeID
optional		<i>schemeID</i>
optional		<i>schemeAgencyID</i>
1 .. 1		TransitDeparture
1 .. 1		xs:sequence
1 .. 1		ID
optional		<i>schemeID</i>
optional		<i>schemeAgencyID</i>
1 .. 1		TransitDestination
1 .. 1		xs:sequence
1 .. 1		ID
optional		<i>schemeID</i>
optional		<i>schemeAgencyID</i>
1 .. unbounded		TransitTransportMeans
1 .. 1		xs:sequence
1 .. 1		ID
optional		<i>schemeID</i>
optional		<i>schemeAgencyID</i>
1 .. 1		TypeCode
optional		<i>listID</i>
optional		<i>listAgencyID</i>
1 .. 1		RegistrationNationalityCode
optional		<i>listID</i>
optional		<i>listAgencyID</i>
0 .. 1		JourneyID
optional		<i>schemeID</i>
optional		<i>schemeAgencyID</i>
1 .. unbounded		Itinerary
1 .. 1		xs:sequence
1 .. 1		SequenceNumeric
1 .. 1		RoutingCountryCode
optional		<i>listID</i>
optional		<i>listAgencyID</i>
0 .. unbounded		AdditionalDocument
1 .. 1		xs:sequence
1 .. 1		IssueDateTime
required		<i>formatCode</i>
1 .. 1		ID
optional		<i>schemeID</i>
optional		<i>schemeAgencyID</i>

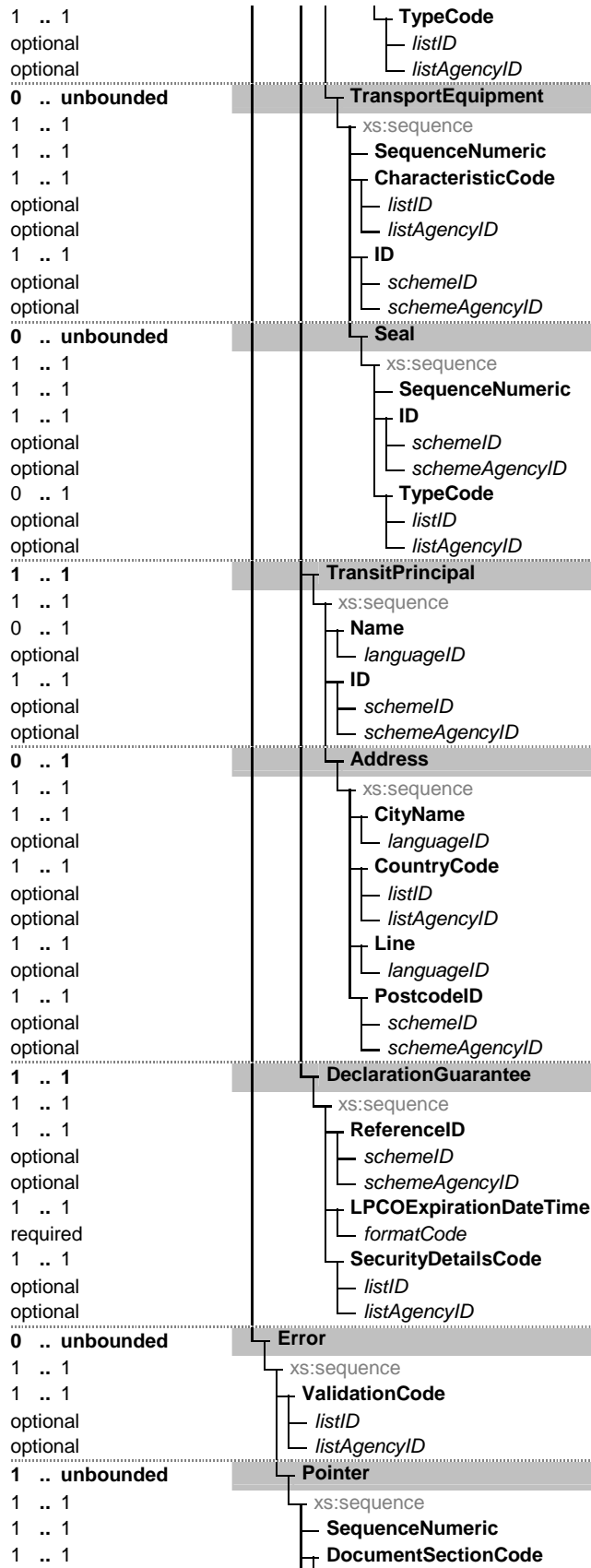

optional
 optional
 1 .. 1
 optional
 optional

- └ listID
- └ listAgencyID
- └ **TagID**
- └ schemeID
- └ schemeAgencyID

b. Guidelines

Element/Attribute	Annotation
Message	eTIR name Message Occurrence 1 .. 1
└ xs:sequence	
└ TypeCode	Occurrence 1 .. 1 Type ds:MessageTypeCodeType WhiteSpace collapse Format an..3 eTIR name Type, coded Status R Code List CL26 Message types Restricted code(s) l6 Query results
└ listID	Type xs:token Use optional WhiteSpace collapse
└ listAgencyID	Type clm63055:AgencyIdentificationCodeContentType Length 1 .. 3 Use optional WhiteSpace collapse
└ ReferenceNumberID	Occurrence 1 .. 1 Type ds:MessageReferenceNumberIDType WhiteSpace collapse Format an..14 eTIR name Message reference number Status R
└ schemeID	Type xs:token Use optional WhiteSpace collapse
└ schemeAgencyID	Type clm63055:AgencyIdentificationCodeContentType Length 1 .. 3 Use optional WhiteSpace collapse
└ FunctionCode	Occurrence 1 .. 1 Type ds:MessageFunctionCodeType WhiteSpace collapse Format n..2 eTIR name Message function, coded Code List CL16 Message function code Status R Restricted code(s) 10 Not found Restricted code(s) 11 Response
└ listID	Type xs:token Use optional WhiteSpace collapse
└ listAgencyID	Type clm63055:AgencyIdentificationCodeContentType Length 1 .. 3 Use optional WhiteSpace collapse
└ Guarantee	Occurrence 1 .. 1 eTIR name Guarantee Status R
└ xs:sequence	Occurrence 1 .. 1

ReferenceID	<p>Occurrence 1 .. 1 Type ds:GuaranteeReferenceIDType WhiteSpace collapse Format an..35 eTIR name Reference Status R</p>
<i>schemeID</i>	<p>Type xs:token Use optional WhiteSpace collapse</p>
<i>schemeAgencyID</i>	<p>Type clm63055:AgencyIdentificationCodeContentType Length 1 .. 3 Use optional WhiteSpace collapse</p>
LPCOExpirationDateTime	<p>Occurrence 1 .. 1 Type ds:GuaranteeLPCOExpirationDateTimeType WhiteSpace collapse Format n8 eTIR name Validity Status R</p>
<i>formatCode</i>	<p>Type clm62379:DateTimePeriodFormatCode Length 1 .. 3 Use required WhiteSpace collapse Name Date or time or period format code Description Code specifying the representation of a date, time or period.</p> <p>Applicable Codes</p> <p>102 CCYYMMDD Calendar date: C = Century ; Y = Year ; M = Month ; D = Day.</p> <p>304 CCYYMMDDHHMMSSZZ See 204 plus Z=Time zone.</p> <p>602 CCYY Calendar year including century: C = Century; Y = Year.</p>
SecurityDetailsCode	<p>Occurrence 1 .. 1 Type ds:GuaranteeSecurityDetailsCodeType WhiteSpace collapse Format an..3 eTIR name Guarantee type Code List CL12 Guarantee type code Status R</p>
<i>listID</i>	<p>Type xs:token Use optional WhiteSpace collapse</p>
<i>listAgencyID</i>	<p>Type clm63055:AgencyIdentificationCodeContentType Length 1 .. 3 Use optional WhiteSpace collapse</p>
GuaranteeStatusCode	<p>Occurrence 1 .. 1 Type ds:GuaranteeGuaranteeStatusCodeType WhiteSpace collapse Format an..3 Code List CL22 Guarantee status eTIR name Guarantee status Status R</p>
<i>listID</i>	<p>Type xs:token Use optional WhiteSpace collapse</p>
<i>listAgencyID</i>	<p>Type clm63055:AgencyIdentificationCodeContentType Length 1 .. 3 Use optional WhiteSpace collapse</p>
Surety	<p>Occurrence 1 .. 1 eTIR name GuaranteeChain Status R</p>
xs:sequence	<p>Occurrence 1 .. 1</p>

ID	<p>Occurrence 1 .. 1 Type ds:SuretyIdentificationIDType WhiteSpace collapse Format an..17 eTIR name Code Status R</p>
<i>schemeID</i>	<p>Type xs:token Use optional WhiteSpace collapse</p>
<i>schemeAgencyID</i>	<p>Type clm63055:AgencyIdentificationCodeContentType Length 1 .. 3 Use optional WhiteSpace collapse</p>
TIROperation	<p>Occurrence 0 .. unbounded eTIR name TIROperation Status O</p>
xs:sequence	<p>Occurrence 1 .. 1</p>
SequenceNumeric	<p>Occurrence 1 .. 1 Type ds:TIROperationSequenceNumericType Format n..5 eTIR name Sequence number Status R</p>
RegistrationNumberID	<p>Occurrence 1 .. 1 Type ds:TIROperationRegistrationNumberIDType WhiteSpace collapse eTIR name Registration number Format an..35 Status R</p>
<i>schemeID</i>	<p>Type xs:token Use optional WhiteSpace collapse</p>
<i>schemeAgencyID</i>	<p>Type clm63055:AgencyIdentificationCodeContentType Length 1 .. 3 Use optional WhiteSpace collapse</p>
Start	<p>Occurrence 0 .. 1 eTIR name Start Status O</p>
xs:sequence	<p>Occurrence 1 .. 1</p>
DateDateTime	<p>Occurrence 1 .. 1 Type ds:StartDateDateTimeType WhiteSpace collapse eTIR name Date Format n..17 Status R</p>
<i>formatCode</i>	<p>Type clm62379:DateTimePeriodFormatCode Length 1 .. 3 Use required WhiteSpace collapse Name Date or time or period format code Description Code specifying the representation of a date, time or period.</p> <p>Applicable Codes</p> <p>102 CCYYMMDD Calendar date: C = Century ; Y = Year ; M = Month ; D = Day.</p> <p>304 CCYYMMDDHHMMSSZZ See 204 plus Z=Time zone.</p> <p>602 CCYY Calendar year including century: C = Century; Y = Year.</p>
TimeLimitDateTime	<p>Occurrence 0 .. 1 Type ds:StartTimeLimitDateTimeType WhiteSpace collapse eTIR name Time limit Format n..17 Status O</p>

<i>formatCode</i>	<p>Type clm62379:DateTimePeriodFormatCode Length 1 .. 3 Use required WhiteSpace collapse Name Date or time or period format code Description Code specifying the representation of a date, time or period.</p> <p>Applicable Codes</p> <p>102 CCYYMMDD Calendar date: C = Century ; Y = Year ; M = Month ; D = Day. 304 CCYYMMDDHHMMSSZZZ See 204 plus Z=Time zone. 602 CCYY Calendar year including century: C = Century; Y = Year.</p>
Remarks	<p>Occurrence 0 .. 1 Type ds:StartRemarksTextType eTIR name Remarks Format an..512 Status O</p>
<i>languageID</i>	<p>Type xs:language Use optional Pattern ([a-zA-Z]{2} [iI]-[a-zA-Z]+ [xX]-[a-zA-Z]{1,8})-[a-zA-Z]{1,8})* WhiteSpace collapse</p>
CustomsOffice	<p>Occurrence 1 .. 1 eTIR name CustomsOffice Status R</p>
xs:sequence ID	<p>Occurrence 1 .. 1 Occurrence 1 .. 1 Type ds:CustomsOfficeIdentificationIDType WhiteSpace collapse Format an..17 eTIR name Customs office, coded Code List CL13 Customs offices database (to be developed)</p> <p>Status R</p>
<i>schemeID</i>	<p>Type xs:token Use optional WhiteSpace collapse</p>
<i>schemeAgencyID</i>	<p>Type clm63055:AgencyIdentificationCodeContentType Length 1 .. 3 Use optional WhiteSpace collapse</p>
NationalItinerary	<p>Occurrence 0 .. unbounded eTIR name NationalItinerary Status O</p>
xs:sequence ID	<p>Occurrence 1 .. 1 Occurrence 1 .. 1 Type ds:NationalItineraryIdentificationIDType WhiteSpace collapse Format an..17 eTIR name Customs office, coded Code List CL13 Customs offices database (to be developed)</p> <p>Status R</p>
<i>schemeID</i>	<p>Type xs:token Use optional WhiteSpace collapse</p>
<i>schemeAgencyID</i>	<p>Type clm63055:AgencyIdentificationCodeContentType Length 1 .. 3 Use optional WhiteSpace collapse</p>
ControlResult	<p>Occurrence 1 .. unbounded eTIR name ControlResult Status R</p>

xs:sequence	ResultCodeCode	Occurrence	1 .. 1
		Occurrence	1 .. 1
		Type	ds:ControlResultResultCodeCodeType
		WhiteSpace	collapse
		eTIR name	Code
		Code List	CL24 Control result code
		Format	an..3
		Status	R
	listID	Type	xs:token
		Use	optional
		WhiteSpace	collapse
	listAgencyID	Type	clm63055:AgencyIdentificationCodeContentType
		Length	1 .. 3
		Use	optional
		WhiteSpace	collapse
	ControlType	Occurrence	1 .. 1
		eTIR name	ControlType
		Status	R
	xs:sequence	Occurrence	1 .. 1
	ID	Occurrence	1 .. 1
		Type	ds:ControlTypeIdentificationCodeType
		WhiteSpace	collapse
		eTIR name	Identification
		Format	an..3
		Code List	CL25 Control type code
		Status	R
	listID	Type	xs:token
		Use	optional
		WhiteSpace	collapse
	listAgencyID	Type	clm63055:AgencyIdentificationCodeContentType
		Length	1 .. 3
		Use	optional
		WhiteSpace	collapse
	Consignment	Occurrence	0 .. unbounded
		Status	O
		eTIR name	Consignment
	xs:sequence	Occurrence	1 .. 1
	SequenceNumeric	Occurrence	1 .. 1
		Type	ds:ConsignmentSequenceNumericType
		Format	n..5
		Status	R
		eTIR name	Sequence number
		Status	R
	TransportEquipment	Occurrence	1 .. unbounded
		Status	R
		eTIR name	TransportEquipment
	xs:sequence	Occurrence	1 .. 1
	ID	Occurrence	1 .. 1
		Type	ds:TransportEquipmentIdentificationIDType
		WhiteSpace	collapse
		Format	an..17
		Status	R
		eTIR name	Identification
	schemeID	Type	xs:token
		Use	optional
		WhiteSpace	collapse
	schemeAgencyID	Type	clm63055:AgencyIdentificationCodeContentType
		Length	1 .. 3
		Use	optional
		WhiteSpace	collapse
	Seal	Occurrence	1 .. unbounded
		Status	R
		eTIR name	Seal
	xs:sequence	Occurrence	1 .. 1

SequenceNumeric	<p>Occurrence 1 .. 1 Type ds:SealSequenceNumericType Format n..5 Status R eTIR name Sequence number</p>
ID	<p>Occurrence 1 .. 1 Type ds:SealIdentificationIDType WhiteSpace collapse Format an..35 Status R eTIR name Seal number</p>
<i>schemeID</i>	<p>Type xs:token Use optional WhiteSpace collapse</p>
<i>schemeAgencyID</i>	<p>Type clm63055:AgencyIdentificationCodeContentType Length 1 .. 3 Use optional WhiteSpace collapse</p>
TypeCode	<p>Occurrence 0 .. 1 Type ds:SealTypeCodeType WhiteSpace collapse Format an..3 Status O eTIR name Seal type code Code List CL08 Seal type code</p>
<i>listID</i>	<p>Type xs:token Use optional WhiteSpace collapse</p>
<i>listAgencyID</i>	<p>Type clm63055:AgencyIdentificationCodeContentType Length 1 .. 3 Use optional WhiteSpace collapse</p>
Termination	<p>Occurrence 0 .. 1 eTIR name Termination Status O</p>
<i>xs:sequence</i>	<p>Occurrence 1 .. 1</p>
DateDateTime	<p>Occurrence 1 .. 1 Type ds:TerminationDateDateTimeType WhiteSpace collapse eTIR name Date Format n..17 Status R</p>
<i>formatCode</i>	<p>Type clm62379:DateTimePeriodFormatCode Length 1 .. 3 Use required WhiteSpace collapse Name Date or time or period format code Description Code specifying the representation of a date, time or period.</p>
Applicable Codes	
102	CCYYMMDD Calendar date: C = Century ; Y = Year ; M = Month ; D = Day.
304	CCYYMMDDHHMMSSZZZ See 204 plus Z=Time zone.
602	CCYY Calendar year including century: C = Century; Y = Year.
NumberOfPackagesQuantity	<p>Occurrence 1 .. 1 Type ds:TerminationNumberOfPackagesQuantityType Format n..8 eTIR name Number of packages Status R</p>

<i>unitCode</i>	Type	clm6Recommendation20: MeasurementUnitCommonCodeContentType
	Length	1 .. 3
	Use	required
	WhiteSpace	collapse
Reservations	Occurrence	0 .. 1
	Type	ds:TerminationReservationsTextType
	eTIR name	Reservations
	Format	an..512
	Status	O
<i>languageID</i>	Type	xs:language
	Use	optional
	Pattern	([a-zA-Z]{2} [iI]-[a-zA-Z]+ [xX]-[a-zA-Z]{1,8})-[a-zA-Z]{1,8})*
	WhiteSpace	collapse
CustomsOffice	Occurrence	1 .. 1
	eTIR name	CustomsOffice
	Status	R
xs:sequence	Occurrence	1 .. 1
ID	Occurrence	1 .. 1
	Type	ds:CustomsOfficeIdentificationIDType
	WhiteSpace	collapse
	Format	an..17
	eTIR name	Customs office, coded
	Code List	CL13 Customs offices database (to be developed)
	Status	R
<i>schemeID</i>	Type	xs:token
	Use	optional
	WhiteSpace	collapse
<i>schemeAgencyID</i>	Type	clm63055:AgencyIdentificationCodeContentType
	Length	1 .. 3
	Use	optional
	WhiteSpace	collapse
ControlResult	Occurrence	1 .. unbounded
	eTIR name	ControlResult
	Status	R
xs:sequence	Occurrence	1 .. 1
ResultCodeCode	Occurrence	1 .. 1
	Type	ds:ControlResultResultCodeCodeType
	WhiteSpace	collapse
	eTIR name	Code
	Code List	CL24 Control result code
	Format	an..3
	Status	R
<i>listID</i>	Type	xs:token
	Use	optional
	WhiteSpace	collapse
<i>listAgencyID</i>	Type	clm63055:AgencyIdentificationCodeContentType
	Length	1 .. 3
	Use	optional
	WhiteSpace	collapse
ControlType	Occurrence	1 .. 1
	eTIR name	ControlType
	Status	R
xs:sequence	Occurrence	1 .. 1
ID	Occurrence	1 .. 1
	Type	ds:ControlTypeIdentificationCodeType
	WhiteSpace	collapse
	eTIR name	Identification
	Format	an..3
	Code List	CL25 Control type code
	Status	R

<i>listID</i>	Type Use WhiteSpace	xs:token optional collapse
<i>listAgencyID</i>	Type Length Use WhiteSpace	clm63055:AgencyIdentificationCodeContentType 1 .. 3 optional collapse
Consignment	Occurrence Status eTIR name	0 .. unbounded O Consignment
xs:sequence	Occurrence	1 .. 1
SequenceNumeric	Occurrence Type Format Status eTIR name Status	1 .. 1 ds:ConsignmentSequenceNumericType n..5 R Sequence number R
TransportEquipment	Occurrence Status eTIR name	1 .. unbounded R TransportEquipment
xs:sequence	Occurrence	1 .. 1
ID	Occurrence Type WhiteSpace Format Status eTIR name	1 .. 1 ds:TransportEquipmentIdentificationIDType collapse an..17 R Identification
<i>schemeID</i>	Type Use WhiteSpace	xs:token optional collapse
<i>schemeAgencyID</i>	Type Length Use WhiteSpace	clm63055:AgencyIdentificationCodeContentType 1 .. 3 optional collapse
Seal	Occurrence Status eTIR name	1 .. unbounded R Seal
xs:sequence	Occurrence	1 .. 1
SequenceNumeric	Occurrence Type Format Status eTIR name	1 .. 1 ds:SealSequenceNumericType n..5 R Sequence number
ID	Occurrence Type WhiteSpace Format Status eTIR name	1 .. 1 ds:SealIdentificationIDType collapse an..35 R Seal number
<i>schemeID</i>	Type Use WhiteSpace	xs:token optional collapse
<i>schemeAgencyID</i>	Type Length Use WhiteSpace	clm63055:AgencyIdentificationCodeContentType 1 .. 3 optional collapse
TypeCode	Occurrence Type WhiteSpace Format Status eTIR name Code List	0 .. 1 ds:SealTypeCodeType collapse an..3 O Seal type code CL08 Seal type code

<i>listID</i>	Type Use WhiteSpace	xs:token optional collapse
<i>listAgencyID</i>	Type Length Use WhiteSpace	clm63055:AgencyIdentificationCodeContentType 1 .. 3 optional collapse
Discharge	Occurrence eTIR name Status	0 .. 1 Discharge O
xs:sequence	Occurrence	1 .. 1
DateDateTime	Occurrence Type WhiteSpace eTIR name Format Status	1 .. 1 ds:DischargeDateDateTimeType collapse Date n..17 R
<i>formatCode</i>	Type Length Use WhiteSpace Name Description	clm62379:DateTimePeriodFormatCode 1 .. 3 required collapse Date or time or period format code Code specifying the representation of a date, time or period.
Applicable Codes		
	102	CCYYMMDD Calendar date: C = Century ; Y = Year ; M = Month ; D = Day.
	304	CCYYMMDDHHMMSSZZ See 204 plus Z=Time zone.
	602	CCYY Calendar year including century: C = Century; Y = Year.
CustomsOffice	Occurrence eTIR name Status	1 .. 1 CustomsOffice R
xs:sequence	Occurrence	1 .. 1
ID	Occurrence Type WhiteSpace Format eTIR name Code List Status	1 .. 1 ds:CustomsOfficeIdentificationIDType collapse an..17 Customs office, coded CL13 Customs offices database (to be developed) R
<i>schemeID</i>	Type Use WhiteSpace	xs:token optional collapse
<i>schemeAgencyID</i>	Type Length Use WhiteSpace	clm63055:AgencyIdentificationCodeContentType 1 .. 3 optional collapse
TransitPrincipal	Occurrence eTIR name Status	1 .. 1 Holder R
xs:sequence	Occurrence	1 .. 1
Name	Occurrence Type Format eTIR name Status	1 .. 1 ds:TransitPrincipalNameTextType an..70 Name R
<i>languageID</i>	Type Use Pattern WhiteSpace	xs:language optional ([a-zA-Z]{2} [iI]-[a-zA-Z]+ [xX]-[a-zA-Z]{1,8})-[a-zA-Z]{1,8}) [*] collapse

ID	<p>Occurrence 1 .. 1</p> <p>Type ds:TransitPrincipalIdentificationIDType</p> <p>WhiteSpace collapse</p> <p>Format an..17</p> <p>eTIR name Code</p> <p>Code List CL15 International TIR database</p> <p>Status R</p>
<i>schemeID</i>	<p>Type xs:token</p> <p>Use optional</p> <p>WhiteSpace collapse</p>
<i>schemeAgencyID</i>	<p>Type clm63055:AgencyIdentificationCodeContentType</p> <p>Length 1 .. 3</p> <p>Use optional</p> <p>WhiteSpace collapse</p>
CurrentStatusCode	<p>Occurrence 1 .. 1</p> <p>Type ds:TransitPrincipalCurrentStatusCodeType</p> <p>WhiteSpace collapse</p> <p>Code List CL23 Holder status</p> <p>eTIR name Current status</p> <p>Format an..3</p> <p>Status R</p>
<i>listID</i>	<p>Type xs:token</p> <p>Use optional</p> <p>WhiteSpace collapse</p>
<i>listAgencyID</i>	<p>Type clm63055:AgencyIdentificationCodeContentType</p> <p>Length 1 .. 3</p> <p>Use optional</p> <p>WhiteSpace collapse</p>
Address	<p>Occurrence 1 .. 1</p> <p>eTIR name Address</p> <p>Status R</p>
xs:sequence	<p>Occurrence 1 .. 1</p>
CityName	<p>Occurrence 1 .. 1</p> <p>Type ds:AddressCityNameTextType</p> <p>Format an..35</p> <p>eTIR name City name</p> <p>Status R</p>
<i>languageID</i>	<p>Type xs:language</p> <p>Use optional</p> <p>Pattern ([a-zA-Z]{2} [iI]-[a-zA-Z]+ [xX]-[a-zA-Z]{1,8})-[a-zA-Z]{1,8})*</p> <p>WhiteSpace collapse</p>
CountryCode	<p>Occurrence 1 .. 1</p> <p>Type ds:AddressCountryCodeType</p> <p>WhiteSpace collapse</p> <p>Format a2</p> <p>Code List CL04 Country name code</p> <p>eTIR name Country, coded</p> <p>Status R</p>
<i>listID</i>	<p>Type xs:token</p> <p>Use optional</p> <p>WhiteSpace collapse</p>
<i>listAgencyID</i>	<p>Type clm63055:AgencyIdentificationCodeContentType</p> <p>Length 1 .. 3</p> <p>Use optional</p> <p>WhiteSpace collapse</p>
Line	<p>Occurrence 1 .. 1</p> <p>Type ds:AddressLineTextType</p> <p>Format an..70</p> <p>eTIR name Street and number/P.O. Box</p> <p>Status R</p>

<i>languageID</i>	Type Use Pattern WhiteSpace	xs:language optional ([a-zA-Z]{2}) [iI]-[a-zA-Z]+ [xX]-[a-zA-Z]{1,8})(-[a-zA-Z]{1,8})* collapse
PostcodeID	Occurrence Type WhiteSpace Format eTIR name Status	1 .. 1 ds:AddressPostcodeIDType collapse an..9 Postcode identification R
<i>schemeID</i>	Type Use WhiteSpace	xs:token optional collapse
<i>schemeAgencyID</i>	Type Length Use WhiteSpace	clm63055:AgencyIdentificationCodeContentType 1 .. 3 optional collapse
ActiveWithdrawal	Occurrence eTIR name Status	0 .. 1 ActiveWithdrawal O
xs:sequence	Occurrence	1 .. 1
StartDateTime	Occurrence Type WhiteSpace eTIR name Format Status	1 .. 1 ds:ActiveWithdrawalStartDateTimeType collapse Start n..17 R
<i>formatCode</i>	Type Length Use WhiteSpace Name Description	clm62379:DateTimePeriodFormatCode 1 .. 3 required collapse Date or time or period format code Code specifying the representation of a date, time or period.
Applicable Codes		
102	CCYYMMDD Calendar date: C = Century ; Y = Year ; M = Month ; D = Day.	
304	CCYYMMDDHHMMSSZZ See 204 plus Z=Time zone.	
602	CCYY Calendar year including century: C = Century; Y = Year.	
EndDateTime	Occurrence Type WhiteSpace eTIR name Format Status	0 .. 1 ds:ActiveWithdrawalEndDateTimeType collapse End n..17 O
<i>formatCode</i>	Type Length Use WhiteSpace Name Description	clm62379:DateTimePeriodFormatCode 1 .. 3 required collapse Date or time or period format code Code specifying the representation of a date, time or period.
Applicable Codes		
102	CCYYMMDD Calendar date: C = Century ; Y = Year ; M = Month ; D = Day.	
304	CCYYMMDDHHMMSSZZ See 204 plus Z=Time zone.	
602	CCYY Calendar year including century: C = Century; Y = Year.	
ActiveExclusion	Occurrence eTIR name	0 .. unbounded ActiveExclusion

	Status	O
xs:sequence	Occurrence	1 .. 1
StartDateTime	Occurrence	1 .. 1
	Type	ds:ActiveExclusionStartDateTimeType
	WhiteSpace	collapse
	eTIR name	Start
	Format	n..17
	Status	R
<i>formatCode</i>	Type	clm62379:DateTimePeriodFormatCode
	Length	1 .. 3
	Use	required
	WhiteSpace	collapse
	Name	Date or time or period format code
	Description	Code specifying the representation of a date, time or period.
	Applicable Codes	
	102	CCYYMMDD Calendar date: C = Century ; Y = Year ; M = Month ; D = Day.
	304	CCYYMMDDHHMMSSZZ See 204 plus Z=Time zone.
	602	CCYY Calendar year including century: C = Century; Y = Year.
EndDateTime	Occurrence	0 .. 1
	Type	ds:ActiveExclusionEndDateTimeType
	WhiteSpace	collapse
	eTIR name	End
	Format	n..17
	Status	O
<i>formatCode</i>	Type	clm62379:DateTimePeriodFormatCode
	Length	1 .. 3
	Use	required
	WhiteSpace	collapse
	Name	Date or time or period format code
	Description	Code specifying the representation of a date, time or period.
	Applicable Codes	
	102	CCYYMMDD Calendar date: C = Century ; Y = Year ; M = Month ; D = Day.
	304	CCYYMMDDHHMMSSZZ See 204 plus Z=Time zone.
	602	CCYY Calendar year including century: C = Century; Y = Year.
CountryCode	Occurrence	1 .. 1
	Type	ds:ActiveExclusionCountryCodeType
	WhiteSpace	collapse
	Code List	CL04 Country name code
	eTIR name	Country, coded
	Format	a2
	Status	R
<i>listID</i>	Type	xs:token
	Use	optional
	WhiteSpace	collapse
<i>listAgencyID</i>	Type	clm63055:AgencyIdentificationCodeContentType
	Length	1 .. 3
	Use	optional
	WhiteSpace	collapse
Declaration	Occurrence	0 .. unbounded
	eTIR name	AdvancedCargoInformation
	Status	O
xs:sequence	Occurrence	1 .. 1
IssueDateTime	Occurrence	1 .. 1
	Type	ds:DeclarationIssueDateTimeType
	WhiteSpace	collapse
	Format	an..17

	eTIR name	Date
	Status	R
	Type	clm62379:DateTimePeriodFormatCode
	Length	1 .. 3
	Use	required
	WhiteSpace	collapse
	Name	Date or time or period format code
	Description	Code specifying the representation of a date, time or period.
	Applicable Codes	
	102	CCYYMMDD Calendar date: C = Century ; Y = Year ; M = Month ; D = Day.
	304	CCYYMMDDHHMMSSZZ See 204 plus Z=Time zone.
	602	CCYY Calendar year including century: C = Century; Y = Year.
	Occurence	1 .. 1
	Type	ds:DeclarationIdentificationIDType
	WhiteSpace	collapse
	Format	an..35
	eTIR name	Reference
	Status	R
	Type	xs:token
	Use	optional
	WhiteSpace	collapse
	Type	clm63055:AgencyIdentificationCodeContentType
	Length	1 .. 3
	Use	optional
	WhiteSpace	collapse
	Occurence	1 .. 1
	Type	ds:DeclarationTotalGrossMassMeasureType
	Format	n..16,6
	eTIR name	Total gross weight
	Status	R
	Type	clm6Recommendation20: MeasurementUnitCommonCodeContentType
	Length	1 .. 3
	Use	required
	WhiteSpace	collapse
	Occurence	1 .. 1
	eTIR name	AdditionalInformation
	Status	R
	Occurence	1 .. 1
	Type	ds:AdditionalInformationContentTextType
	Format	an..512
	eTIR name	Remarks
	Status	R
	Type	xs:language
	Use	optional
	Pattern	([a-zA-Z]{2} [iI]-[a-zA-Z]+ [xX]-[a-zA-Z]{1,8}){1,8}
	WhiteSpace	collapse
	Occurence	1 .. 1
	Type	ds:AdditionalInformationStatementCodeType
	WhiteSpace	collapse
	Format	an..17
	eTIR name	Heavy and bulky goods indicator
	Code List	CL14 Indicator
	Status	R
	Type	xs:token
	Use	optional
	WhiteSpace	collapse

listAgencyID	Type	clm63055:AgencyIdentificationCodeContentType
	Length	1 .. 3
	Use	optional
	WhiteSpace	collapse
Agent	Occurrence	0 .. 1
	eTIR name	Agent
	Status	O
xs:sequence	Occurrence	1 .. 1
ID	Occurrence	1 .. 1
	Type	ds:AgentIdentificationIDType
	WhiteSpace	collapse
	Format	an..17
	eTIR name	Code
	Status	R
schemeID	Type	xs:token
	Use	optional
	WhiteSpace	collapse
schemeAgencyID	Type	clm63055:AgencyIdentificationCodeContentType
	Length	1 .. 3
	Use	optional
	WhiteSpace	collapse
RoleCode	Occurrence	1 .. 1
	Type	ds:AgentRoleCodeType
	WhiteSpace	collapse
	Format	an..3
	Code List	CL02 Party role codes
	eTIR name	Role, coded
	Status	R
listID	Type	xs:token
	Use	optional
	WhiteSpace	collapse
listAgencyID	Type	clm63055:AgencyIdentificationCodeContentType
	Length	1 .. 3
	Use	optional
	WhiteSpace	collapse
Amendment	Occurrence	0 .. unbounded
	eTIR name	Amendment
	Status	R
xs:sequence	Occurrence	1 .. 1
ChangeReasonCode	Occurrence	1 .. 1
	Type	ds:AmendmentChangeReasonCodeType
	WhiteSpace	collapse
	Format	an..3
	eTIR name	Amendment code
	Code List	CL17 Amendment code
	Status	R
listID	Type	xs:token
	Use	optional
	WhiteSpace	collapse
listAgencyID	Type	clm63055:AgencyIdentificationCodeContentType
	Length	1 .. 3
	Use	optional
	WhiteSpace	collapse
Pointer	Occurrence	1 .. unbounded
	eTIR name	Pointer
	Status	R
xs:sequence	Occurrence	1 .. 1
SequenceNumeric	Occurrence	1 .. 1
	Type	ds:PointerSequenceNumericType
	Format	n..5
	eTIR name	Sequence number
	Status	R
DocumentSectionCode	Occurrence	1 .. 1
	Type	ds:PointerDocumentSectionCodeType
	WhiteSpace	collapse

	Format	an..3
	eTIR name	Document/message section, coded
	Code List	CL18 Message section code (codes to be defined)
	Status	R
<i>listID</i>	Type	xs:token
	Use	optional
	WhiteSpace	collapse
<i>listAgencyID</i>	Type	clm63055:AgencyIdentificationCodeContentType
	Length	1 .. 3
	Use	optional
	WhiteSpace	collapse
TagID	Occurrence	1 .. 1
	Type	ds:PointerTagIDType
	WhiteSpace	collapse
	Format	an..4
	eTIR name	Tag identifier
	Code List	CL19 Pointer code (codes to be defined)
	Status	R
<i>schemeID</i>	Type	xs:token
	Use	optional
	WhiteSpace	collapse
<i>schemeAgencyID</i>	Type	clm63055:AgencyIdentificationCodeContentType
	Length	1 .. 3
	Use	optional
	WhiteSpace	collapse
Carrier	Occurrence	0 .. 1
	eTIR name	SubContractor
	Status	O
<i>xs:sequence</i>	Occurrence	1 .. 1
Name	Occurrence	0 .. 1
	Type	ds:CarrierNameTextType
	Format	an..70
	eTIR name	Name
	Condition	C001
	Status	D
<i>languageID</i>	Type	xs:language
	Use	optional
	Pattern	([a-zA-Z]{2})[il]-[a-zA-Z]+[xX]-[a-zA-Z]{1,8}){1,8}
	WhiteSpace	collapse
ID	Occurrence	0 .. 1
	Type	ds:CarrierIdentificationIDType
	WhiteSpace	collapse
	Format	an..17
	eTIR name	Code
	Code List	CL15 International TIR database
	Condition	C001
	Status	D
<i>schemeID</i>	Type	xs:token
	Use	optional
	WhiteSpace	collapse
<i>schemeAgencyID</i>	Type	clm63055:AgencyIdentificationCodeContentType
	Length	1 .. 3
	Use	optional
	WhiteSpace	collapse
Address	Occurrence	0 .. unbounded
	eTIR name	Address
	Condition	C001
	Status	D
<i>xs:sequence</i>	Occurrence	1 .. 1
CityName	Occurrence	1 .. 1
	Type	ds:AddressCityNameTextType
	Format	an..35
	eTIR name	City name

<i>languageID</i>	Status	R
	Type	xs:language
	Use	optional
	Pattern	([a-zA-Z]{2})[il]-[a-zA-Z]+[[xX]-[a-zA-Z]{1,8}){1,8})*
	WhiteSpace	collapse
CountryCode	Occurrence	1 .. 1
	Type	ds:AddressCountryCodeType
	WhiteSpace	collapse
	Format	a2
	Code List	CL04 Country name code
	eTIR name	Country, coded
	Status	R
<i>listID</i>	Type	xs:token
	Use	optional
	WhiteSpace	collapse
<i>listAgencyID</i>	Type	clm63055:AgencyIdentificationCodeContentType
	Length	1 .. 3
	Use	optional
	WhiteSpace	collapse
Line	Occurrence	1 .. 1
	Type	ds:AddressLineTextType
	Format	an..70
	eTIR name	Street and number/P.O. Box
	Status	R
<i>languageID</i>	Type	xs:language
	Use	optional
	Pattern	([a-zA-Z]{2})[il]-[a-zA-Z]+[[xX]-[a-zA-Z]{1,8}){1,8})*
	WhiteSpace	collapse
PostcodeID	Occurrence	1 .. 1
	Type	ds:AddressPostcodeIDType
	WhiteSpace	collapse
	Format	an..9
	eTIR name	Postcode identification
	Status	R
<i>schemeID</i>	Type	xs:token
	Use	optional
	WhiteSpace	collapse
<i>schemeAgencyID</i>	Type	clm63055:AgencyIdentificationCodeContentType
	Length	1 .. 3
	Use	optional
	WhiteSpace	collapse
Consignment	Occurrence	1 .. unbounded
	Status	R
	eTIR name	Consignment
<i>xs:sequence</i>	Occurrence	1 .. 1
SequenceNumeric	Occurrence	1 .. 1
	Type	ds:ConsignmentSequenceNumericType
	Format	n..5
	eTIR name	Sequence number
	Status	R
AdditionalDocument	Occurrence	0 .. unbounded
	Remark	Also needed for EX1, not in Objectteering
	eTIR name	AttachedDocuments
	Status	O
<i>xs:sequence</i>	Occurrence	1 .. 1
IssueDateTime	Occurrence	1 .. 1
	Type	ds:AdditionalDocumentIssueDateTimeType
	WhiteSpace	collapse
	Format	an..17
	eTIR name	Issuing date
	Status	R

<i>formatCode</i>	Type clm62379:DateTimePeriodFormatCode Length 1 .. 3 Use required WhiteSpace collapse Name Date or time or period format code Description Code specifying the representation of a date, time or period. Applicable Codes 102 CCYYMMDD Calendar date: C = Century ; Y = Year ; M = Month ; D = Day. 304 CCYYMMDDHHMMSSZZZ See 204 plus Z=Time zone. 602 CCYY Calendar year including century: C = Century; Y = Year.
ID	Occurrence 1 .. 1 Type ds:AdditionalDocumentIdentificationIDType WhiteSpace collapse Format an..35 eTIR name Number Status R
<i>schemeID</i>	Type xs:token Use optional WhiteSpace collapse
<i>schemeAgencyID</i>	Type clm63055:AgencyIdentificationCodeContentType Length 1 .. 3 Use optional WhiteSpace collapse
TypeCode	Occurrence 1 .. 1 Type ds:AdditionalDocumentTypeCodeType WhiteSpace collapse Format an..3 eTIR name Type, coded Code List 06 Document name code Status R
<i>listID</i>	Type xs:token Use optional WhiteSpace collapse
<i>listAgencyID</i>	Type clm63055:AgencyIdentificationCodeContentType Length 1 .. 3 Use optional WhiteSpace collapse
ConsignmentItem	Occurrence 1 .. unbounded eTIR name ConsignmentItem Status R
xs:sequence	
SequenceNumeric	Occurrence 1 .. 1 Type ds:ConsignmentItemSequenceNumericType Format n..5 eTIR name Sequence number Status R
AdditionalInformation	Occurrence 0 .. unbounded eTIR name AdditionalInformation Status O
xs:sequence	
Content	Occurrence 1 .. 1 Type ds:AdditionalInformationContentTextType Format an..512 eTIR name Remarks Status R
<i>languageID</i>	Type xs:language Use optional Pattern ([a-zA-Z]{2} [l]-[a-zA-Z]+ [xX]-[a-zA-Z]{1,8})-([a-zA-Z]{1,8})* WhiteSpace collapse
Commodity	Occurrence 1 .. 1

	eTIR name	Goods
	Status	R
	Occurrence	1 .. 1
xs:sequence	Occurrence	0 .. 1
CargoDescription	Type	ds:CommodityCargoDescriptionTextType
	Format	an..256
	eTIR name	Description
	Status	D
	Condition	C004
languageID	Type	xs:language
	Use	optional
	Pattern	([a-zA-Z]{2} [il]-[a-zA-Z]+ [xX]-[a-zA-Z]{1,8}){1,8}
	WhiteSpace	collapse
Classification	Occurrence	0 .. unbounded
	eTIR name	Classification
	Status	O
xs:sequence	Occurrence	1 .. 1
ID	Occurrence	0 .. 1
	Type	ds:ClassificationIdentificationIDType
	WhiteSpace	collapse
	Format	an..18
	eTIR name	Code
	Status	O
schemeID	Type	xs:token
	Use	optional
	WhiteSpace	collapse
schemeAgencyID	Type	clm63055:AgencyIdentificationCodeContentType
	Length	1 .. 3
	Use	optional
	WhiteSpace	collapse
IdentificationTypeCode	Occurrence	1 .. 1
	Type	ds:ClassificationIdentificationTypeCodeType
	WhiteSpace	collapse
	Format	an..3
	eTIR name	Type
	Code List	CL03 Item type identification code
	Status	R
listID	Type	xs:token
	Use	optional
	WhiteSpace	collapse
listAgencyID	Type	clm63055:AgencyIdentificationCodeContentType
	Length	1 .. 3
	Use	optional
	WhiteSpace	collapse
Consignee	Occurrence	0 .. 1
	eTIR name	Consignee
	Status	O
xs:sequence	Occurrence	1 .. 1
Name	Occurrence	0 .. 1
	Type	ds:ConsigneeNameTextType
	Format	an..70
	eTIR name	Name
	Status	D
	Condition	C001
languageID	Type	xs:language
	Use	optional
	Pattern	([a-zA-Z]{2} [il]-[a-zA-Z]+ [xX]-[a-zA-Z]{1,8}){1,8}
	WhiteSpace	collapse
ID	Occurrence	0 .. 1
	Type	ds:ConsigneeIdentificationIDType
	WhiteSpace	collapse
	Format	an..17
	eTIR name	Code

	Status	D
	Condition	C001
	Type	xs:token
	Use	optional
	WhiteSpace	collapse
schemeID	Type	clm63055:AgencyIdentificationCodeContentType
	Length	1 .. 3
	Use	optional
	WhiteSpace	collapse
schemeAgencyID	Occurrence	0 .. 1
	eTIR name	Address
	Status	D
	Condition	C001
Address	Occurrence	1 .. 1
	Type	ds:AddressCityNameTextType
	Format	an..35
	eTIR name	City name
	Status	R
xs:sequence	Type	xs:language
	Use	optional
	Pattern	([a-zA-Z]{2} [iI]-[a-zA-Z]+ [xX]-[a-zA-Z]{1,8})-[a-zA-Z]{1,8})*
CityName	WhiteSpace	collapse
	Occurrence	1 .. 1
	Type	ds:AddressCountryCodeType
	WhiteSpace	collapse
	Format	a2
	Code List	CL04 Country name code
	eTIR name	Country, coded
	Status	R
languageID	Type	xs:token
	Use	optional
	WhiteSpace	collapse
CountryCode	Type	clm63055:AgencyIdentificationCodeContentType
	Length	1 .. 3
	Use	optional
	WhiteSpace	collapse
listID	Occurrence	1 .. 1
	Type	ds:AddressLineTextType
	Format	an..70
	eTIR name	Street and number/P.O. Box
	Status	R
listAgencyID	Type	xs:language
	Use	optional
	Pattern	([a-zA-Z]{2} [iI]-[a-zA-Z]+ [xX]-[a-zA-Z]{1,8})-[a-zA-Z]{1,8})*
	WhiteSpace	collapse
Line	Occurrence	1 .. 1
	Type	ds:AddressPostcodeIDType
	WhiteSpace	collapse
	Format	an..9
	eTIR name	Postcode identification
	Status	R
languageID	Type	xs:token
	Use	optional
	WhiteSpace	collapse
PostcodeID	Type	clm63055:AgencyIdentificationCodeContentType
	Length	1 .. 3
	Use	optional
	WhiteSpace	collapse
schemeID	Occurrence	0 .. 1
	eTIR name	Consignor
	Status	O
schemeAgencyID	Occurrence	1 .. 1
	Type	ds:AddressLineTextType
	Format	an..70
	eTIR name	Street and number/P.O. Box
	Status	R
Consignor	Type	xs:language
	Use	optional
	Pattern	([a-zA-Z]{2} [iI]-[a-zA-Z]+ [xX]-[a-zA-Z]{1,8})-[a-zA-Z]{1,8})*
	WhiteSpace	collapse
xs:sequence	Occurrence	1 .. 1

Name		Occurrence	0 .. 1
		Type	ds:ConsignorNameTextType
		Format	an..70
		eTIR name	Name
		Status	D
		Condition	C001
- <i>languageID</i>		Type	xs:language
		Use	optional
		Pattern	([a-zA-Z]{2} [iI]-[a-zA-Z]+ [xX]-[a-zA-Z]{1,8})-[a-zA-Z]{1,8})*
		WhiteSpace	collapse
ID		Occurrence	0 .. 1
		Type	ds:ConsignorIdentificationIDType
		WhiteSpace	collapse
		Format	an..17
		eTIR name	Code
		Status	D
		Condition	C001
- <i>schemeID</i>		Type	xs:token
		Use	optional
		WhiteSpace	collapse
- <i>schemeAgencyID</i>		Type	clm63055:AgencyIdentificationCodeContentType
		Length	1 .. 3
		Use	optional
		WhiteSpace	collapse
Address		Occurrence	0 .. 1
		eTIR name	Address
		Status	D
		Condition	C001
- xs:sequence		Occurrence	1 .. 1
- CityName		Occurrence	1 .. 1
		Type	ds:AddressCityNameTextType
		Format	an..35
		eTIR name	City name
		Status	R
- <i>languageID</i>		Type	xs:language
		Use	optional
		Pattern	([a-zA-Z]{2} [iI]-[a-zA-Z]+ [xX]-[a-zA-Z]{1,8})-[a-zA-Z]{1,8})*
		WhiteSpace	collapse
- CountryCode		Occurrence	1 .. 1
		Type	ds:AddressCountryCodeType
		WhiteSpace	collapse
		Format	a2
		Code List	CL04 Country name code
		eTIR name	Country, coded
		Status	R
- <i>listID</i>		Type	xs:token
		Use	optional
		WhiteSpace	collapse
- <i>listAgencyID</i>		Type	clm63055:AgencyIdentificationCodeContentType
		Length	1 .. 3
		Use	optional
		WhiteSpace	collapse
Line		Occurrence	1 .. 1
		Type	ds:AddressLineTextType
		Format	an..70
		eTIR name	Street and number/P.O. Box
		Status	R
- <i>languageID</i>		Type	xs:language
		Use	optional
		Pattern	([a-zA-Z]{2} [iI]-[a-zA-Z]+ [xX]-[a-zA-Z]{1,8})-[a-zA-Z]{1,8})*
		WhiteSpace	collapse

	PostcodeID	Occurrence	1 .. 1
		Type	ds:AddressPostcodeIDType
		WhiteSpace	collapse
		Format	an..9
		eTIR name	Postcode identification
		Status	R
	<i>schemeID</i>	Type	xs:token
		Use	optional
		WhiteSpace	collapse
	<i>schemeAgencyID</i>	Type	clm63055:AgencyIdentificationCodeContentType
		Length	1 .. 3
		Use	optional
		WhiteSpace	collapse
	DeliveryDestination	Occurrence	1 .. 1
		eTIR name	DeliveryDestination
		Status	R
	xs:sequence	Occurrence	1 .. 1
	Name	Occurrence	1 .. 1
		Type	ds:DeliveryDestinationNameTextType
		Format	an..70
		eTIR name	Name
		Status	R
	<i>languageID</i>	Type	xs:language
		Use	optional
		Pattern	([a-zA-Z]{2} [iI]-[a-zA-Z]+ [xX]-[a-zA-Z]{1,8})-[a-zA-Z]{1,8})*
		WhiteSpace	collapse
	Address	Occurrence	1 .. 1
		eTIR name	Address
		Status	R
	xs:sequence	Occurrence	1 .. 1
	CityName	Occurrence	1 .. 1
		Type	ds:AddressCityNameTextType
		Format	an..35
		eTIR name	City name
		Status	R
	<i>languageID</i>	Type	xs:language
		Use	optional
		Pattern	([a-zA-Z]{2} [iI]-[a-zA-Z]+ [xX]-[a-zA-Z]{1,8})-[a-zA-Z]{1,8})*
		WhiteSpace	collapse
	CountryCode	Occurrence	1 .. 1
		Type	ds:AddressCountryCodeType
		WhiteSpace	collapse
		Format	a2
		Code List	CL04 Country name code
		eTIR name	Country, coded
		Status	R
	<i>listID</i>	Type	xs:token
		Use	optional
		WhiteSpace	collapse
	<i>listAgencyID</i>	Type	clm63055:AgencyIdentificationCodeContentType
		Length	1 .. 3
		Use	optional
		WhiteSpace	collapse
	Line	Occurrence	1 .. 1
		Type	ds:AddressLineTextType
		Format	an..70
		eTIR name	Street and number/P.O. Box
		Status	R
	<i>languageID</i>	Type	xs:language
		Use	optional
		Pattern	([a-zA-Z]{2} [iI]-[a-zA-Z]+ [xX]-[a-zA-Z]{1,8})-[a-zA-Z]{1,8})*
		WhiteSpace	collapse

PostcodeID	Occurrence	1 .. 1	Type	ds:AddressPostcodeIDType
	WhiteSpace	collapse	Format	an..9
	eTIR name	Postcode identification	Status	R
schemeID	Type	xs:token	Use	optional
	WhiteSpace	collapse	Type	clm63055:AgencyIdentificationCodeContentType
schemeAgencyID	Length	1 .. 3	Use	optional
	WhiteSpace	collapse	Type	clm63055:AgencyIdentificationCodeContentType
GoodsMeasure	Occurrence	1 .. 1	eTIR name	GoodsMeasure
	Status	R		
xs:sequence	Occurrence	1 .. 1		
GrossMassMeasure	Occurrence	1 .. 1	Type	ds:GoodsMeasureGrossMassMeasureType
	Format	n..16,6	eTIR name	Gross weight
	Status	R		
unitCode	Type	clm6Recommendation20: MeasurementUnitCommonCodeContentType	Length	1 .. 3
	Use	required	WhiteSpace	collapse
Packaging	Occurrence	1 .. 1	eTIR name	Packaging
	Status	R		
xs:sequence	Occurrence	1 .. 1		
MarksNumbersID	Occurrence	1 .. 1	Type	ds:PackagingMarksNumbersIDType
	WhiteSpace	collapse	Format	an..512
	eTIR name	Marks and numbers	Status	R
schemeID	Type	xs:token	Use	optional
	WhiteSpace	collapse	Type	clm63055:AgencyIdentificationCodeContentType
schemeAgencyID	Length	1 .. 3	Use	optional
	WhiteSpace	collapse	Type	clm63055:AgencyIdentificationCodeContentType
QuantityQuantity	Occurrence	1 .. 1	Type	ds:PackagingQuantityQuantityType
	Format	n..8	eTIR name	Number of packages
	Status	R		
unitCode	Type	clm6Recommendation20: MeasurementUnitCommonCodeContentType	Length	1 .. 3
	Use	required	WhiteSpace	collapse
TypeCode	Occurrence	1 .. 1	Type	ds:PackagingTypeCodeType
	WhiteSpace	collapse	Format	an..2
	eTIR name	Type, coded	Code List	CL07 Package type description code
	Status	R		
listID	Type	xs:token	Use	optional
	WhiteSpace	collapse		

<ul style="list-style-type: none"> └─ <i>listAgencyID</i> 	<p>Type clm63055:AgencyIdentificationCodeContentType Length 1 .. 3 Use optional WhiteSpace collapse</p>
<ul style="list-style-type: none"> └─ TransportEquipment 	<p>Occurrence 0 .. 1 eTIR name TransportEquipment Status D Condition C003</p>
<ul style="list-style-type: none"> └─ xs:sequence └─ ID 	<p>Occurrence 1 .. 1 Occurrence 1 .. 1 Type ds:TransportEquipmentIdentificationIDType WhiteSpace collapse Format an..17 eTIR name Identification Status R</p>
<ul style="list-style-type: none"> └─ <i>schemeID</i> 	<p>Type xs:token Use optional WhiteSpace collapse</p>
<ul style="list-style-type: none"> └─ <i>schemeAgencyID</i> 	<p>Type clm63055:AgencyIdentificationCodeContentType Length 1 .. 3 Use optional WhiteSpace collapse</p>
<ul style="list-style-type: none"> └─ UCR 	<p>Occurrence 0 .. 1 eTIR name UCR Status O</p>
<ul style="list-style-type: none"> └─ xs:sequence └─ ID 	<p>Occurrence 1 .. 1 Occurrence 1 .. 1 Type ds:UCRIdentificationIDType WhiteSpace collapse Format an..35 eTIR name Identifier Status R</p>
<ul style="list-style-type: none"> └─ <i>schemeID</i> 	<p>Type xs:token Use optional WhiteSpace collapse</p>
<ul style="list-style-type: none"> └─ <i>schemeAgencyID</i> 	<p>Type clm63055:AgencyIdentificationCodeContentType Length 1 .. 3 Use optional WhiteSpace collapse</p>
<ul style="list-style-type: none"> └─ LoadingLocation 	<p>Occurrence 0 .. 1 eTIR name LoadingLocation Status O</p>
<ul style="list-style-type: none"> └─ xs:sequence └─ Name 	<p>Occurrence 1 .. 1 Occurrence 1 .. 1 Type ds>LoadingLocationNameTextType Format an..256 eTIR name Name Status R</p>
<ul style="list-style-type: none"> └─ <i>languageID</i> 	<p>Type xs:language Use optional Pattern ([a-zA-Z]{2} [il]-[a-zA-Z]+ [xX]-[a-zA-Z]{1,8})-[a-zA-Z]{1,8})* WhiteSpace collapse</p>
<ul style="list-style-type: none"> └─ NotifyParty 	<p>Occurrence 0 .. 1 eTIR name NotifyParty Status O</p>
<ul style="list-style-type: none"> └─ xs:sequence └─ Name 	<p>Occurrence 1 .. 1 Occurrence 0 .. 1 Type ds:NotifyPartyNameTextType Format an..70 eTIR name Name Status D Condition C001</p>

<i>languageID</i>	Type Use Pattern WhiteSpace	xs:language optional ([a-zA-Z]{2} [iI]-[a-zA-Z]+ [xX]-[a-zA-Z]{1,8})-[a-zA-Z]{1,8})* collapse
ID	Occurrence Type WhiteSpace Format eTIR name Status Condition	0 .. 1 ds:NotifyPartyIdentificationIDType collapse an..17 Code D C001
<i>schemeID</i>	Type Use WhiteSpace	xs:token optional collapse
<i>schemeAgencyID</i>	Type Length Use WhiteSpace	clm63055:AgencyIdentificationCodeContentType 1 .. 3 optional collapse
Address	Occurrence eTIR name Status Condition	0 .. 1 Address D C001
xs:sequence	Occurrence	1 .. 1
CityName	Occurrence Type Format eTIR name Status	1 .. 1 ds:AddressCityNameTextType an..35 City name R
<i>languageID</i>	Type Use Pattern WhiteSpace	xs:language optional ([a-zA-Z]{2} [iI]-[a-zA-Z]+ [xX]-[a-zA-Z]{1,8})-[a-zA-Z]{1,8})* collapse
CountryCode	Occurrence Type WhiteSpace Format Code List eTIR name Status	1 .. 1 ds:AddressCountryCodeType collapse a2 CL04 Country name code Country, coded R
<i>listID</i>	Type Use WhiteSpace	xs:token optional collapse
<i>listAgencyID</i>	Type Length Use WhiteSpace	clm63055:AgencyIdentificationCodeContentType 1 .. 3 optional collapse
Line	Occurrence Type Format eTIR name Status	1 .. 1 ds:AddressLineTextType an..70 Street and number/P.O. Box R
<i>languageID</i>	Type Use Pattern WhiteSpace	xs:language optional ([a-zA-Z]{2} [iI]-[a-zA-Z]+ [xX]-[a-zA-Z]{1,8})-[a-zA-Z]{1,8})* collapse
PostcodeID	Occurrence Type WhiteSpace Format eTIR name Status	1 .. 1 ds:AddressPostcodeIDType collapse an..9 Postcode identification R

<i>schemeID</i>	Type Use WhiteSpace	xs:token optional collapse
<i>schemeAgencyID</i>	Type Length Use WhiteSpace	clm63055:AgencyIdentificationCodeContentType 1 .. 3 optional collapse
TransitDeparture	Occurrence eTIR name Status	1 .. 1 CustomsOfficeOfDeparture R
xs:sequence	Occurrence	1 .. 1
ID	Occurrence Type WhiteSpace Format eTIR name Code List Status	1 .. 1 ds:TransitDepartureIdentificationIDType collapse an..17 Code CL13 Customs offices database (to be developed) R
<i>schemeID</i>	Type Use WhiteSpace	xs:token optional collapse
<i>schemeAgencyID</i>	Type Length Use WhiteSpace	clm63055:AgencyIdentificationCodeContentType 1 .. 3 optional collapse
TransitDestination	Occurrence eTIR name Status	1 .. 1 CustomsOfficeOfDestination R
xs:sequence	Occurrence	1 .. 1
ID	Occurrence Type WhiteSpace Format eTIR name Code List Status	1 .. 1 ds:TransitDestinationIdentificationIDType collapse an..17 Code CL13 Customs offices database (to be developed) R
<i>schemeID</i>	Type Use WhiteSpace	xs:token optional collapse
<i>schemeAgencyID</i>	Type Length Use WhiteSpace	clm63055:AgencyIdentificationCodeContentType 1 .. 3 optional collapse
TransitTransportMeans	Occurrence eTIR name Status	1 .. unbounded TransportMeans R
xs:sequence	Occurrence	1 .. 1
ID	Occurrence Type WhiteSpace Format eTIR name Status	1 .. 1 ds:TransitTransportMeansIdentificationIDType collapse an..25 Identification R
<i>schemeID</i>	Type Use WhiteSpace	xs:token optional collapse
<i>schemeAgencyID</i>	Type Length Use WhiteSpace	clm63055:AgencyIdentificationCodeContentType 1 .. 3 optional collapse
TypeCode	Occurrence Type WhiteSpace	1 .. 1 ds:TransitTransportMeansTypeCodeType collapse

		Format	an..4
		eTIR name	Type, coded
		Code List	CL05 Transport means description code
		Status	R
	<i>listID</i>	Type	xs:token
		Use	optional
		WhiteSpace	collapse
	<i>listAgencyID</i>	Type	clm63055:AgencyIdentificationCodeContentType
		Length	1 .. 3
		Use	optional
		WhiteSpace	collapse
	RegistrationNationalityCode	Occurrence	1 .. 1
		Type	ds: TransitTransportMeansRegistrationNationalityCodeType
		WhiteSpace	collapse
		Format	a2
		eTIR name	Nationality
		Code List	CL04 Country name code
		Status	R
	<i>listID</i>	Type	xs:token
		Use	optional
		WhiteSpace	collapse
	<i>listAgencyID</i>	Type	clm63055:AgencyIdentificationCodeContentType
		Length	1 .. 3
		Use	optional
		WhiteSpace	collapse
	JourneyID	Occurrence	0 .. 1
		Type	ds:TransitTransportMeansJourneyIDType
		WhiteSpace	collapse
		Format	an..17
		eTIR name	Conveyance reference number
		Status	O
	<i>schemeID</i>	Type	xs:token
		Use	optional
		WhiteSpace	collapse
	<i>schemeAgencyID</i>	Type	clm63055:AgencyIdentificationCodeContentType
		Length	1 .. 3
		Use	optional
		WhiteSpace	collapse
	Itinerary	Occurrence	1 .. unbounded
		eTIR name	CountryOfRouting
		Status	R
	<i>xs:sequence</i>	Occurrence	1 .. 1
	SequenceNumeric	Occurrence	1 .. 1
		Type	ds:ItinerarySequenceNumericType
		Format	n..5
		Status	R
	RoutingCountryCode	Occurrence	1 .. 1
		Type	ds:ItineraryRoutingCountryCodeType
		WhiteSpace	collapse
		Format	a2
		eTIR name	Country, coded
		Code List	CL04 Country name code
		Status	R
	<i>listID</i>	Type	xs:token
		Use	optional
		WhiteSpace	collapse
	<i>listAgencyID</i>	Type	clm63055:AgencyIdentificationCodeContentType
		Length	1 .. 3
		Use	optional
		WhiteSpace	collapse
	AdditionalDocument	Occurrence	0 .. unbounded
		eTIR name	CertificateOfApproval
		Status	O
	<i>xs:sequence</i>	Occurrence	1 .. 1

IssueDateTime	<p>Occurrence 1 .. 1 Type ds:AdditionalDocumentIssueDateTimeType WhiteSpace collapse Format an..17 eTIR name Date Status R</p>
<i>formatCode</i>	<p>Type clm62379:DatePeriodFormatCode Length 1 .. 3 Use required WhiteSpace collapse Name Date or time or period format code Description Code specifying the representation of a date, time or period.</p> <p>Applicable Codes</p> <p>102 CCYYMMDD Calendar date: C = Century ; Y = Year ; M = Month ; D = Day. 304 CCYYMMDDHHMMSSZZ See 204 plus Z=Time zone. 602 CCYY Calendar year including century: C = Century; Y = Year.</p>
ID	<p>Occurrence 1 .. 1 Type ds:AdditionalDocumentIdentificationIDType WhiteSpace collapse Format an..35 eTIR name Number Status R</p>
<i>schemeID</i>	<p>Type xs:token Use optional WhiteSpace collapse</p>
<i>schemeAgencyID</i>	<p>Type clm63055:AgencyIdentificationCodeContentType Length 1 .. 3 Use optional WhiteSpace collapse</p>
TypeCode	<p>Occurrence 1 .. 1 Type ds:AdditionalDocumentTypeCodeType WhiteSpace collapse Format an..3 eTIR name Type, coded Code List CL06 Document name code Status R</p>
<i>listID</i>	<p>Type xs:token Use optional WhiteSpace collapse</p>
<i>listAgencyID</i>	<p>Type clm63055:AgencyIdentificationCodeContentType Length 1 .. 3 Use optional WhiteSpace collapse</p>
TransportEquipment	<p>Occurrence 0 .. unbounded eTIR name TransportEquipment Status D Condition C003</p>
<i>xs:sequence</i>	<p>Occurrence 1 .. 1</p>
SequenceNumeric	<p>Occurrence 1 .. 1 Type ds:TransportEquipmentSequenceNumericType Format n..5 eTIR name Sequence number Status R</p>
CharacteristicCode	<p>Occurrence 1 .. 1 Type ds:TransportEquipmentCharacteristicCodeType WhiteSpace collapse Format an..4 eTIR name Size and type identification Code List CL01 Equipment size and type description code Status R</p>

<i>listID</i>	Type Use WhiteSpace	xs:token optional collapse
<i>listAgencyID</i>	Type Length Use WhiteSpace	clm63055:AgencyIdentificationCodeContentType 1 .. 3 optional collapse
ID	Occurrence Type WhiteSpace Format eTIR name Status	1 .. 1 ds:TransportEquipmentIdentificationIDType collapse an..17 Identification R
<i>schemeID</i>	Type Use WhiteSpace	xs:token optional collapse
<i>schemeAgencyID</i>	Type Length Use WhiteSpace	clm63055:AgencyIdentificationCodeContentType 1 .. 3 optional collapse
Seal	Occurrence eTIR name Status	0 .. unbounded Seal O
xs:sequence	Occurrence	1 .. 1
SequenceNumeric	Occurrence Type Format eTIR name Status	1 .. 1 ds:SealSequenceNumericType n..5 Sequence number R
ID	Occurrence Type WhiteSpace Format eTIR name Status	1 .. 1 ds:SealIdentificationIDType collapse an..35 Seal number R
<i>schemeID</i>	Type Use WhiteSpace	xs:token optional collapse
<i>schemeAgencyID</i>	Type Length Use WhiteSpace	clm63055:AgencyIdentificationCodeContentType 1 .. 3 optional collapse
TypeCode	Occurrence Type WhiteSpace Format eTIR name Status	0 .. 1 ds:SealTypeCodeType collapse an..3 Seal type code O
<i>listID</i>	Type Use WhiteSpace	xs:token optional collapse
<i>listAgencyID</i>	Type Length Use WhiteSpace	clm63055:AgencyIdentificationCodeContentType 1 .. 3 optional collapse
TransitPrincipal	Occurrence eTIR name Status	1 .. 1 Holder R
xs:sequence	Occurrence	1 .. 1
Name	Occurrence Type Format eTIR name Status	0 .. 1 ds:TransitPrincipalNameTextType an..70 Name O

<i>languageID</i>	Type Use Pattern WhiteSpace	xs:language optional ([a-zA-Z]{2} [iI]-[a-zA-Z]+ [xX]-[a-zA-Z]{1,8})-[a-zA-Z]{1,8})*	
ID	Occurrence Type WhiteSpace Format eTIR name Code List Status	1 .. 1 ds:TransitPrincipalIdentificationIDType collapse an..17 Code CL15 R	International TIR database
<i>schemeID</i>	Type Use WhiteSpace	xs:token optional collapse	
<i>schemeAgencyID</i>	Type Length Use WhiteSpace	clm63055:AgencyIdentificationCodeContentType 1 .. 3 optional collapse	
Address	Occurrence eTIR name Status	0 .. 1 Address O	
xs:sequence	Occurrence	1 .. 1	
CityName	Occurrence Type Format eTIR name Status	1 .. 1 ds:AddressCityNameTextType an..35 City name R	
<i>languageID</i>	Type Use Pattern WhiteSpace	xs:language optional ([a-zA-Z]{2} [iI]-[a-zA-Z]+ [xX]-[a-zA-Z]{1,8})-[a-zA-Z]{1,8})*	
CountryCode	Occurrence Type WhiteSpace Format Code List eTIR name Status	1 .. 1 ds:AddressCountryCodeType collapse a2 CL04 Country, coded R	Country name code
<i>listID</i>	Type Use WhiteSpace	xs:token optional collapse	
<i>listAgencyID</i>	Type Length Use WhiteSpace	clm63055:AgencyIdentificationCodeContentType 1 .. 3 optional collapse	
Line	Occurrence Type Format eTIR name Status	1 .. 1 ds:AddressLineTextType an..70 Street and number/P.O. Box R	
<i>languageID</i>	Type Use Pattern WhiteSpace	xs:language optional ([a-zA-Z]{2} [iI]-[a-zA-Z]+ [xX]-[a-zA-Z]{1,8})-[a-zA-Z]{1,8})*	
PostcodeID	Occurrence Type WhiteSpace Format eTIR name Status	1 .. 1 ds:AddressPostcodeIDType collapse an..9 Postcode identification R	

<ul style="list-style-type: none"> — <i>schemeID</i> 	<p>Type xs:token Use optional WhiteSpace collapse</p>
<ul style="list-style-type: none"> — <i>schemeAgencyID</i> 	<p>Type clm63055:AgencyIdentificationCodeContentType Length 1 .. 3 Use optional WhiteSpace collapse</p>
<ul style="list-style-type: none"> — DeclarationGuarantee 	<p>Occurrence 1 .. 1 eTIR name Guarantee Status R</p>
<ul style="list-style-type: none"> — xs:sequence — ReferenceID 	<p>Occurrence 1 .. 1 Type ds:DeclarationGuaranteeReferenceIDType WhiteSpace collapse Format an..35 eTIR name Reference Status R</p>
<ul style="list-style-type: none"> — <i>schemeID</i> 	<p>Type xs:token Use optional WhiteSpace collapse</p>
<ul style="list-style-type: none"> — <i>schemeAgencyID</i> 	<p>Type clm63055:AgencyIdentificationCodeContentType Length 1 .. 3 Use optional WhiteSpace collapse</p>
<ul style="list-style-type: none"> — LPCOExpirationDateTime 	<p>Occurrence 1 .. 1 Type ds:DeclarationGuaranteeLPCOExpirationDateTimeType WhiteSpace collapse Format n..17 eTIR name Validity Status R</p>
<ul style="list-style-type: none"> — <i>formatCode</i> 	<p>Type clm62379:DateTimePeriodFormatCode Length 1 .. 3 Use required WhiteSpace collapse Name Date or time or period format code Description Code specifying the representation of a date, time or period.</p> <p>Applicable Codes</p> <p>102 CCYYMMDD Calendar date: C = Century ; Y = Year ; M = Month ; D = Day.</p> <p>304 CCYYMMDDHHMMSSZZZ See 204 plus Z=Time zone.</p> <p>602 CCYY Calendar year including century: C = Century; Y = Year.</p>
<ul style="list-style-type: none"> — SecurityDetailsCode 	<p>Occurrence 1 .. 1 Type ds:DeclarationGuaranteeSecurityDetailsCodeType WhiteSpace collapse Format an..3 eTIR name Guarantee type, coded Code List CL12 Guarantee type code Status R</p>
<ul style="list-style-type: none"> — <i>listID</i> 	<p>Type xs:token Use optional WhiteSpace collapse</p>
<ul style="list-style-type: none"> — <i>listAgencyID</i> 	<p>Type clm63055:AgencyIdentificationCodeContentType Length 1 .. 3 Use optional WhiteSpace collapse</p>
<ul style="list-style-type: none"> — Error 	<p>Occurrence 0 .. unbounded eTIR name Error Status D Condition C006</p>
<ul style="list-style-type: none"> — xs:sequence 	<p>Occurrence 1 .. 1</p>

ValidationCode	<p>Occurrence 1 .. 1</p> <p>Type ds:ErrorValidationCodeType</p> <p>WhiteSpace collapse</p> <p>Format an..8</p> <p>eTIR name Error, coded</p> <p>Code List CL99 Error code (to be developed)</p> <p>Status R</p>
<i>listID</i>	<p>Type xs:token</p> <p>Use optional</p> <p>WhiteSpace collapse</p>
<i>listAgencyID</i>	<p>Type clm63055:AgencyIdentificationCodeContentType</p> <p>Length 1 .. 3</p> <p>Use optional</p> <p>WhiteSpace collapse</p>
Pointer	<p>Occurrence 1 .. unbounded</p> <p>eTIR name Pointer</p> <p>Status R</p>
xs:sequence	
SequenceNumeric	<p>Occurrence 1 .. 1</p> <p>Type ds:PointerSequenceNumericType</p> <p>Format n..5</p> <p>eTIR name Sequence number</p> <p>Status R</p>
DocumentSectionCode	<p>Occurrence 1 .. 1</p> <p>Type ds:PointerDocumentSectionCodeType</p> <p>WhiteSpace collapse</p> <p>Format an..3</p> <p>eTIR name Document/message section, coded</p> <p>Code List CL18 Message section code (codes to be defined)</p> <p>Status R</p>
<i>listID</i>	<p>Type xs:token</p> <p>Use optional</p> <p>WhiteSpace collapse</p>
<i>listAgencyID</i>	<p>Type clm63055:AgencyIdentificationCodeContentType</p> <p>Length 1 .. 3</p> <p>Use optional</p> <p>WhiteSpace collapse</p>
TagID	<p>Occurrence 1 .. 1</p> <p>Type ds:PointerTagIDType</p> <p>WhiteSpace collapse</p> <p>Format an..4</p> <p>eTIR name Tag identifier</p> <p>Code List CL19 Pointer code (codes to be defined)</p> <p>Status R</p>
<i>schemeID</i>	<p>Type xs:token</p> <p>Use optional</p> <p>WhiteSpace collapse</p>
<i>schemeAgencyID</i>	<p>Type clm63055:AgencyIdentificationCodeContentType</p> <p>Length 1 .. 3</p> <p>Use optional</p> <p>WhiteSpace collapse</p>

4.2.3.1.2.7. I7 – Record advanced cargo information

a. Structure

Occurance	Element/Attribute
1 .. 1	Message
1 .. 1	xs:sequence
optional	TypeCode
optional	<i>listID</i>
	<i>listAgencyID</i>

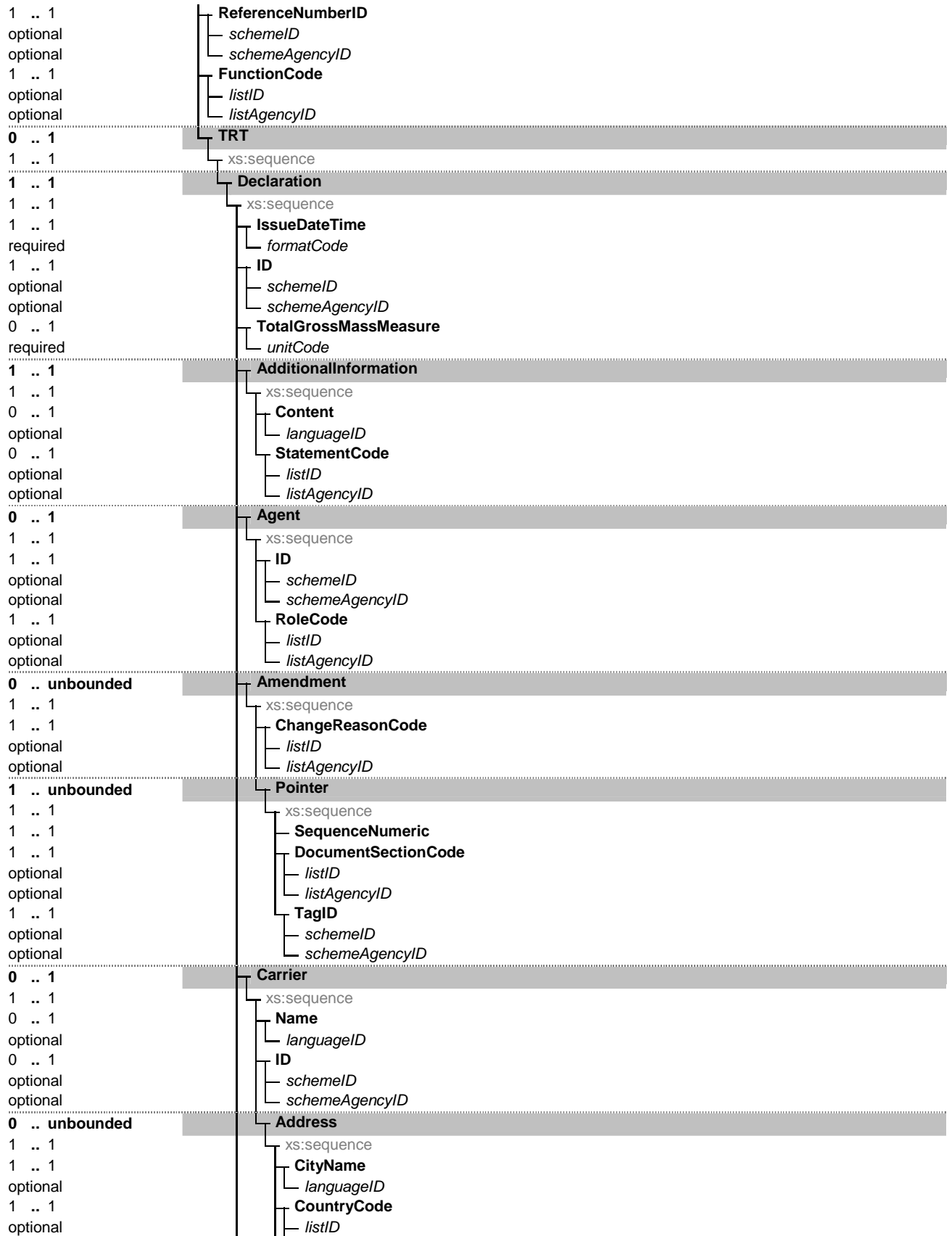

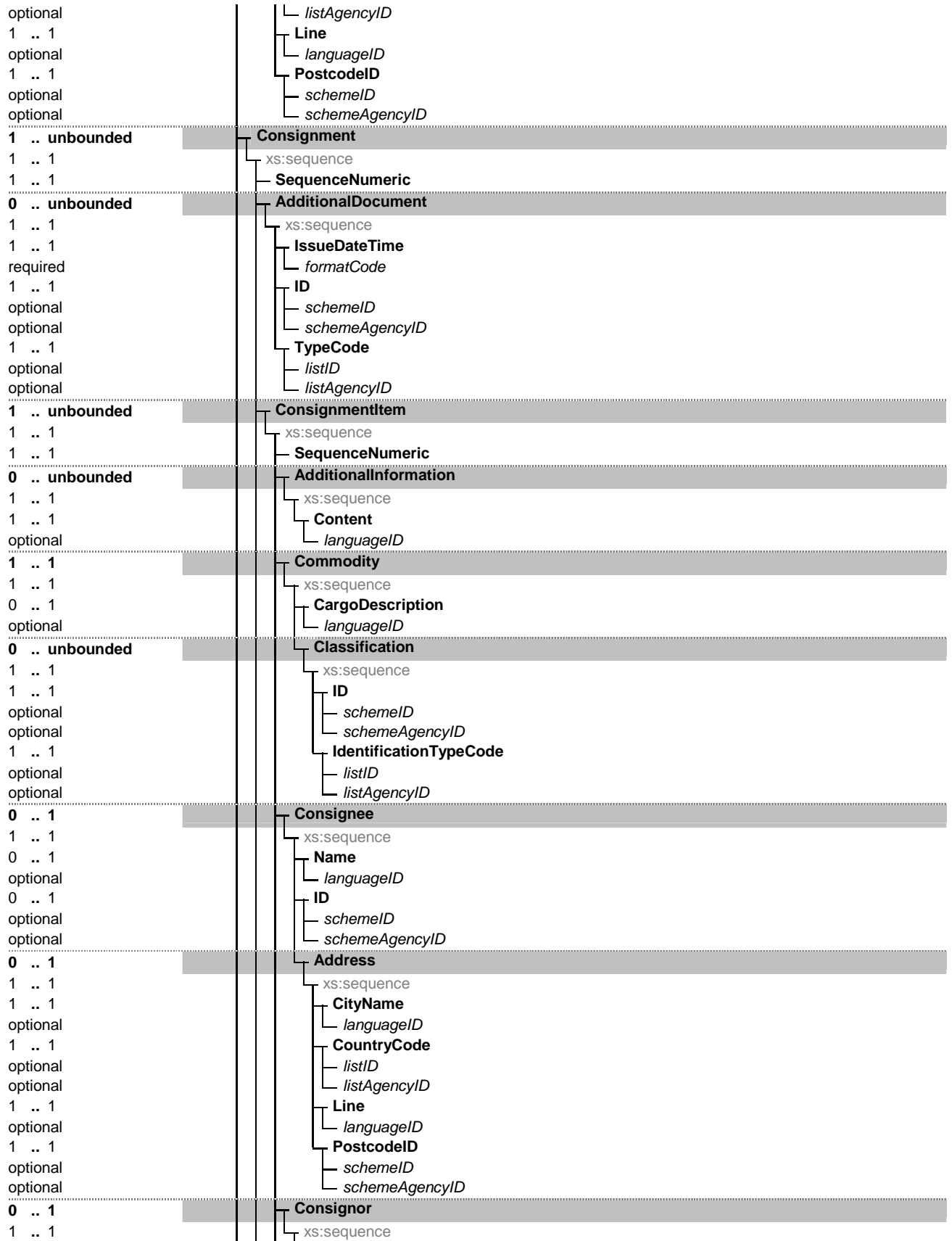

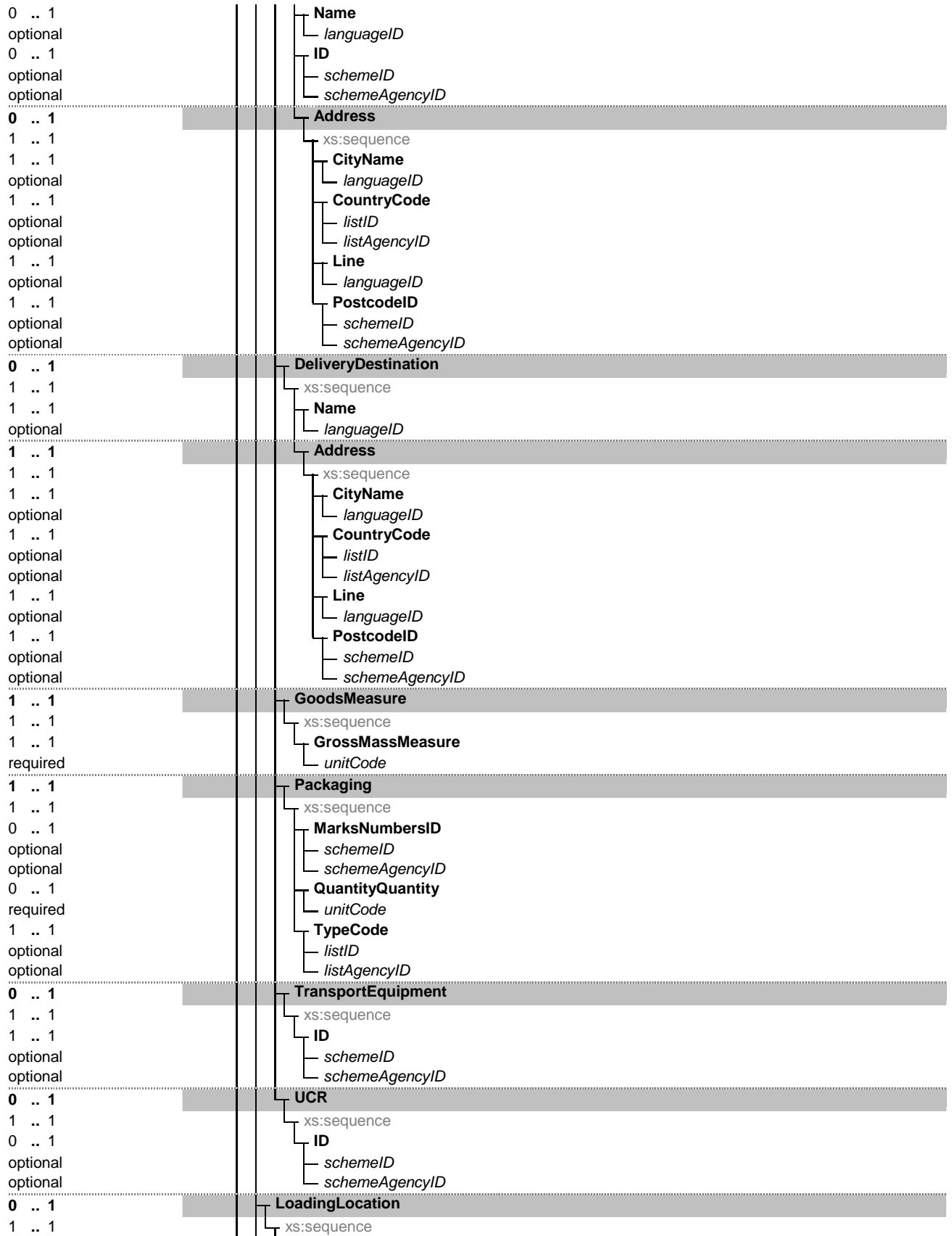

0 .. 1		L	Name
optional			languageID
0 .. 1			NotifyParty
1 .. 1			xs:sequence
0 .. 1			Name
optional			languageID
0 .. 1			ID
optional			schemeID
optional			schemeAgencyID
0 .. 1			Address
1 .. 1			xs:sequence
1 .. 1			CityName
optional			languageID
1 .. 1			CountryCode
optional			listID
optional			listAgencyID
1 .. 1			Line
optional			languageID
1 .. 1			PostcodeID
optional			schemeID
optional			schemeAgencyID
1 .. 1			TransitDeparture
1 .. 1			xs:sequence
1 .. 1			ID
optional			schemeID
optional			schemeAgencyID
1 .. 1			TransitDestination
1 .. 1			xs:sequence
1 .. 1			ID
optional			schemeID
optional			schemeAgencyID
1 .. unbounded			TransitTransportMeans
1 .. 1			xs:sequence
1 .. 1			ID
optional			schemeID
optional			schemeAgencyID
1 .. 1			TypeCode
optional			listID
optional			listAgencyID
1 .. 1			RegistrationNationalityCode
optional			listID
optional			listAgencyID
0 .. 1			JourneyID
optional			schemeID
optional			schemeAgencyID
1 .. unbounded			Itinerary
1 .. 1			xs:sequence
1 .. 1			SequenceNumeric
1 .. 1			RoutingCountryCode
optional			listID
optional			listAgencyID
0 .. 1			AdditionalDocument
1 .. 1			xs:sequence
1 .. 1			IssueDateTime
required			formatCode
1 .. 1			ID
optional			schemeID
optional			schemeAgencyID
1 .. 1			TypeCode

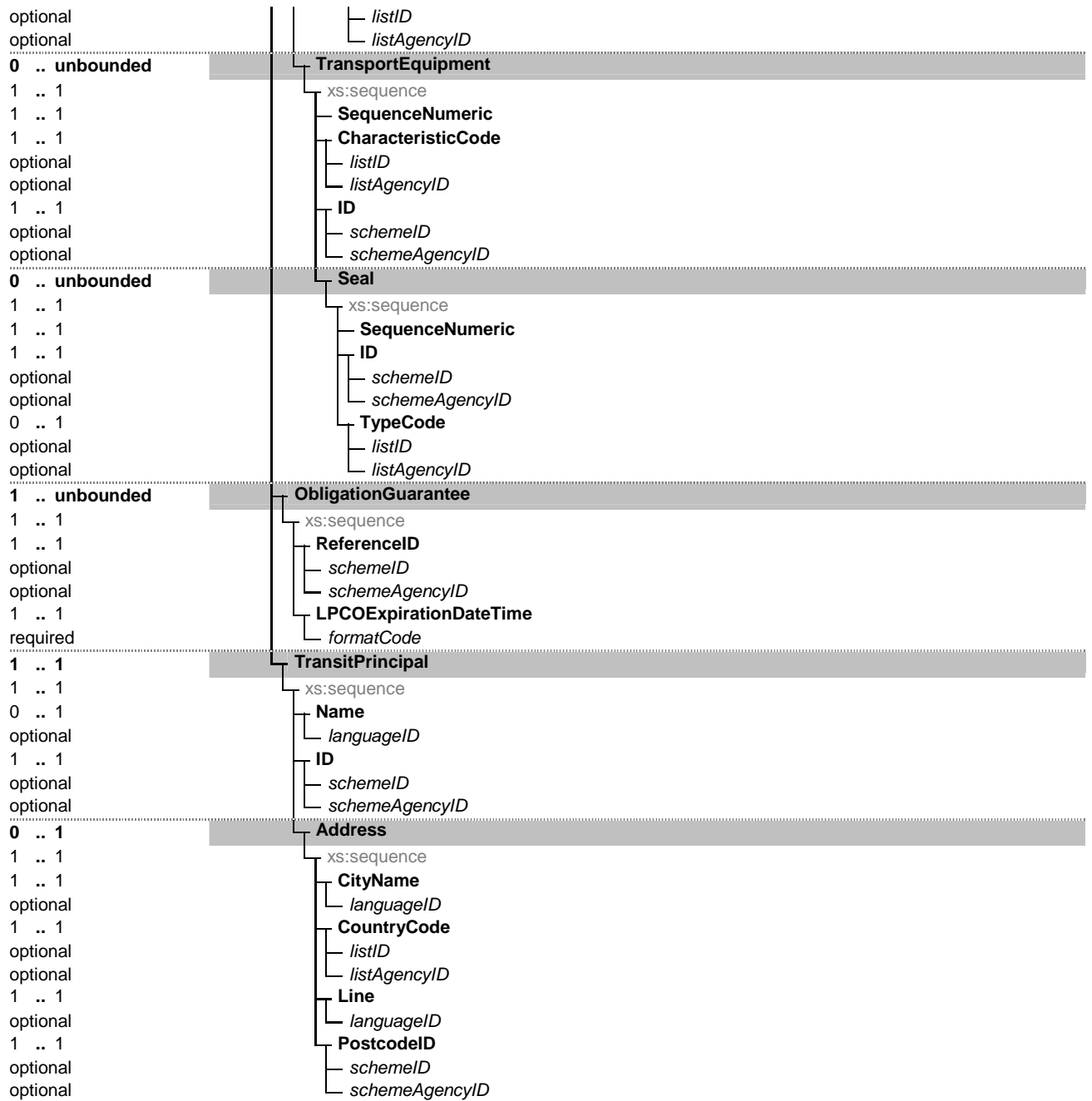

b. Guidelines

Element/Attribute	Annotation
Message	eTIR name Message
xs:sequence	Occurrence 1..1
TypeCode	Occurrence 1..1
	Type ds:MessageTypeCodeType
	WhiteSpace collapse
	Format an..3
	eTIR name Type, coded
	Status R

	Code List Restricted code(s)	CL26 17	Message types Record advanced cargo information
<i>listID</i>	Type	xs:token	
	Use	optional	
	WhiteSpace	collapse	
<i>listAgencyID</i>	Type	clm63055:AgencyIdentificationCodeContentType	
	Length	1 .. 3	
	Use	optional	
	WhiteSpace	collapse	
ReferenceNumberID	Occurrence	1 .. 1	
	Type	ds:MessageReferenceNumberIDType	
	WhiteSpace	collapse	
	Format	an..14	
	eTIR name	Message reference number	
	Status	R	
<i>schemeID</i>	Type	xs:token	
	Use	optional	
	WhiteSpace	collapse	
<i>schemeAgencyID</i>	Type	clm63055:AgencyIdentificationCodeContentType	
	Length	1 .. 3	
	Use	optional	
	WhiteSpace	collapse	
FunctionCode	Occurrence	1 .. 1	
	Type	ds:MessageFunctionCodeType	
	WhiteSpace	collapse	
	Format	n..2	
	eTIR name	Message function, coded	
	Code List	CL16	Message function code
	Status	R	
	Restricted code(s)	4	Change
	Restricted code(s)	9	Original
<i>listID</i>	Type	xs:token	
	Use	optional	
	WhiteSpace	collapse	
<i>listAgencyID</i>	Type	clm63055:AgencyIdentificationCodeContentType	
	Length	1 .. 3	
	Use	optional	
	WhiteSpace	collapse	
TRT	Occurrence	0 .. 1	
	eTIR name	Standard WCO Transit Data model version 3	
xs:sequence	Occurrence	1 .. 1	
Declaration	Occurrence	1 .. 1	
	eTIR name	AdvancedCargoInformation	
	Status	R	
xs:sequence	Occurrence	1 .. 1	
IssueDateTime	Occurrence	1 .. 1	
	Type	ds:DeclarationIssueDateTimeType	
	WhiteSpace	collapse	
	Format	an..17	
	eTIR name	Date	
	Status	R	
<i>formatCode</i>	Type	clm62379:DateTimePeriodFormatCode	
	Length	1 .. 3	
	Use	required	
	WhiteSpace	collapse	
	Name	Date or time or period format code	
	Description	Code specifying the representation of a date, time or period.	
	Applicable Codes		
	102	CCYYMMDD	Calendar date: C = Century ; Y = Year ; M = Month ; D = Day.

	304	CCYYMMDDHHMMSSZZ See 204 plus Z=Time zone.
	602	CCYY Calendar year including century: C = Century; Y = Year.
ID	Occurrence	1 .. 1
	Type	ds:DeclarationIdentificationIDType
	WhiteSpace	collapse
	Format	an..35
	eTIR name	Reference
	Status	R
<i>schemeID</i>	Type	xs:token
	Use	optional
	WhiteSpace	collapse
<i>schemeAgencyID</i>	Type	clm63055:AgencyIdentificationCodeContentType
	Length	1 .. 3
	Use	optional
	WhiteSpace	collapse
TotalGrossMassMeasure	Occurrence	0 .. 1
	Type	ds:DeclarationTotalGrossMassMeasureType
	Format	n..16,6
	eTIR name	Total gross weight
	Status	O
<i>unitCode</i>	Type	clm6Recommendation20: MeasurementUnitCommonCodeContentType
	Length	1 .. 3
	Use	required
	WhiteSpace	collapse
AdditionalInformation	Occurrence	1 .. 1
	eTIR name	AdditionalInformation
	Status	R
<i>xs:sequence</i>	Occurrence	1 .. 1
Content	Occurrence	0 .. 1
	Type	ds:AdditionalInformationContentTextType
	Format	an..512
	eTIR name	Remarks
	Status	O
<i>languageID</i>	Type	xs:language
	Use	optional
	Pattern	([a-zA-Z]{2} [iI]-[a-zA-Z]+ [xX]-[a-zA-Z]{1,8})-[a-zA-Z]{1,8)*
	WhiteSpace	collapse
StatementCode	Occurrence	0 .. 1
	Type	ds:AdditionalInformationStatementCodeType
	WhiteSpace	collapse
	Format	an..17
	eTIR name	Heavy and bulky goods indicator
	Code List	CL14 Indicator
	Status	R
	Restricted code(s)	0 No
	Restricted code(s)	1 Yes
<i>listID</i>	Type	xs:token
	Use	optional
	WhiteSpace	collapse
<i>listAgencyID</i>	Type	clm63055:AgencyIdentificationCodeContentType
	Length	1 .. 3
	Use	optional
	WhiteSpace	collapse
Agent	Occurrence	0 .. 1
	eTIR name	Agent
	Status	O
<i>xs:sequence</i>	Occurrence	1 .. 1

ID	Occurrence 1 .. 1 Type ds:AgentIdentificationIDType WhiteSpace collapse Format an..17 eTIR name Code Status R
<i>schemeID</i>	Type xs:token Use optional WhiteSpace collapse
<i>schemeAgencyID</i>	Type clm63055:AgencyIdentificationCodeContentType Length 1 .. 3 Use optional WhiteSpace collapse
RoleCode	Occurrence 1 .. 1 Type ds:AgentRoleCodeType WhiteSpace collapse Format an..3 Code List CL02 Party role codes eTIR name Role, coded Status R
<i>listID</i>	Type xs:token Use optional WhiteSpace collapse
<i>listAgencyID</i>	Type clm63055:AgencyIdentificationCodeContentType Length 1 .. 3 Use optional WhiteSpace collapse
Amendment	Occurrence 0 .. unbounded eTIR name Amendment Status D Condition C008
xs:sequence	Occurrence 1 .. 1
ChangeReasonCode	Occurrence 1 .. 1 Type ds:AmendmentChangeReasonCodeType WhiteSpace collapse Format an..3 eTIR name Amendment code Code List CL17 Amendment code Status R
<i>listID</i>	Type xs:token Use optional WhiteSpace collapse
<i>listAgencyID</i>	Type clm63055:AgencyIdentificationCodeContentType Length 1 .. 3 Use optional WhiteSpace collapse
Pointer	Occurrence 1 .. unbounded eTIR name Pointer Status R
xs:sequence	Occurrence 1 .. 1
SequenceNumeric	Occurrence 1 .. 1 Type ds:PointerSequenceNumericType Format n..5 eTIR name Sequence number Status R
DocumentSectionCode	Occurrence 1 .. 1 Type ds:PointerDocumentSectionCodeType WhiteSpace collapse Format an..3 eTIR name Document/message section, coded Code List CL18 Message section code (codes to be defined) Status R

<i>listID</i>	Type Use WhiteSpace	xs:token optional collapse
<i>listAgencyID</i>	Type Length Use WhiteSpace	clm63055:AgencyIdentificationCodeContentType 1 .. 3 optional collapse
TagID	Occurrence Type WhiteSpace Format eTIR name Code List Status	1 .. 1 ds:PointerTagIDType collapse an..4 Tag identifier CL19 R Pointer code (codes to be defined)
<i>schemeID</i>	Type Use WhiteSpace	xs:token optional collapse
<i>schemeAgencyID</i>	Type Length Use WhiteSpace	clm63055:AgencyIdentificationCodeContentType 1 .. 3 optional collapse
Carrier	Occurrence eTIR name Status	0 .. 1 SubContractor O
xs:sequence	Occurrence	1 .. 1
Name	Occurrence Type Format eTIR name Status Condition	0 .. 1 ds:CarrierNameTextType an..70 Name D C001
<i>languageID</i>	Type Use Pattern WhiteSpace	xs:language optional ([a-zA-Z]{2} [iI]-[a-zA-Z]+ [xX]-[a-zA-Z]{1,8})-[a-zA-Z]{1,8)* collapse
ID	Occurrence Type WhiteSpace Format eTIR name Code List Status Condition	0 .. 1 ds:CarrierIdentificationIDType collapse an..17 Code CL15 D C001 International TIR database
<i>schemeID</i>	Type Use WhiteSpace	xs:token optional collapse
<i>schemeAgencyID</i>	Type Length Use WhiteSpace	clm63055:AgencyIdentificationCodeContentType 1 .. 3 optional collapse
Address	Occurrence eTIR name Status Condition	0 .. unbounded Address D C001
xs:sequence	Occurrence	1 .. 1
CityName	Occurrence Type Format eTIR name Status	1 .. 1 ds:AddressCityNameTextType an..35 City name R

<i>languageID</i>	Type Use Pattern WhiteSpace	xs:language optional ([a-zA-Z]{2} [iI]-[a-zA-Z]+ [xX]-[a-zA-Z]{1,8})-([a-zA-Z]{1,8})* collapse
CountryCode	Occurrence Type WhiteSpace Format Code List eTIR name Status	1 .. 1 ds:AddressCountryCodeType collapse a2 CL04 Country name code Country, coded R
<i>listID</i>	Type Use WhiteSpace	xs:token optional collapse
<i>listAgencyID</i>	Type Length Use WhiteSpace	clm63055:AgencyIdentificationCodeContentType 1 .. 3 optional collapse
Line	Occurrence Type Format eTIR name Status	1 .. 1 ds:AddressLineTextType an..70 Street and number/P.O. Box R
<i>languageID</i>	Type Use Pattern WhiteSpace	xs:language optional ([a-zA-Z]{2} [iI]-[a-zA-Z]+ [xX]-[a-zA-Z]{1,8})-([a-zA-Z]{1,8})* collapse
PostcodeID	Occurrence Type WhiteSpace Format eTIR name Status	1 .. 1 ds:AddressPostcodeIDType collapse an..9 Postcode identification R
<i>schemeID</i>	Type Use WhiteSpace	xs:token optional collapse
<i>schemeAgencyID</i>	Type Length Use WhiteSpace	clm63055:AgencyIdentificationCodeContentType 1 .. 3 optional collapse
Consignment	Occurrence eTIR name Status	1 .. unbounded Consignment R
xs:sequence	Occurrence	1 .. 1
SequenceNumeric	Occurrence Type Format eTIR name Status	1 .. 1 ds:ConsignmentSequenceNumericType n..5 Sequence number R
AdditionalDocument	Occurrence Remark eTIR name Status	0 .. unbounded Also needed for EX1, not in Objectteering AttachedDocuments O
xs:sequence	Occurrence	1 .. 1
IssueDateTime	Occurrence Type WhiteSpace Format eTIR name Status	1 .. 1 ds:AdditionalDocumentIssueDateTimeType collapse an..17 Issuing date R

<i>formatCode</i>	<p>Type clm62379:DateTimePeriodFormatCode Length 1 .. 3 Use required WhiteSpace collapse Name Date or time or period format code Description Code specifying the representation of a date, time or period.</p> <p>Applicable Codes</p> <p>102 CCYYMMDD Calendar date: C = Century ; Y = Year ; M = Month ; D = Day. 304 CCYYMMDDHHMMSSZZZ See 204 plus Z=Time zone. 602 CCYY Calendar year including century: C = Century; Y = Year.</p>
ID	<p>Occurrence 1 .. 1 Type ds:AdditionalDocumentIdentificationIDType WhiteSpace collapse Format an..35 eTIR name Number Status R</p>
<i>schemeID</i>	<p>Type xs:token Use optional WhiteSpace collapse</p>
<i>schemeAgencyID</i>	<p>Type clm63055:AgencyIdentificationCodeContentType Length 1 .. 3 Use optional WhiteSpace collapse</p>
TypeCode	<p>Occurrence 1 .. 1 Type ds:AdditionalDocumentTypeCodeType WhiteSpace collapse Format an..3 eTIR name Type, coded Code List CL06 Document name code Status R</p>
<i>listID</i>	<p>Type xs:token Use optional WhiteSpace collapse</p>
<i>listAgencyID</i>	<p>Type clm63055:AgencyIdentificationCodeContentType Length 1 .. 3 Use optional WhiteSpace collapse</p>
ConsignmentItem	<p>Occurrence 1 .. unbounded eTIR name ConsignmentItem Status R</p>
<i>xs:sequence</i>	
SequenceNumeric	<p>Occurrence 1 .. 1 Type ds:ConsignmentItemSequenceNumericType Format n..5 eTIR name Sequence number Status R</p>
AdditionalInformation	<p>Occurrence 0 .. unbounded eTIR name AdditionalInformation Status O</p>
<i>xs:sequence</i>	
Content	<p>Occurrence 1 .. 1 Type ds:AdditionalInformationContentTextType Format an..512 eTIR name Remarks Status R</p>
<i>languageID</i>	<p>Type xs:language Use optional Pattern ([a-zA-Z]{2} [l]-[a-zA-Z]+ [xX]-[a-zA-Z]{1,8})-[a-zA-Z]{1,8}) WhiteSpace collapse</p>
Commodity	<p>Occurrence 1 .. 1</p>

	eTIR name	Goods	
	Status	R	
	Occurrence	1 .. 1	
xs:sequence	Occurrence	0 .. 1	
CargoDescription	Type	ds:CommodityCargoDescriptionTextType	
	Format	an..256	
	eTIR name	Description	
	Status	D	
	Condition	C004	
languageID	Type	xs:language	
	Use	optional	
	Pattern	([a-zA-Z]{2} [il]-[a-zA-Z]+ [xX]-[a-zA-Z]{1,8})-[a-zA-Z]{1,8})*	
	WhiteSpace	collapse	
Classification	Occurrence	0 .. unbounded	
	eTIR name	Classification	
	Status	O	
xs:sequence	Occurrence	1 .. 1	
ID	Occurrence	1 .. 1	
	Type	ds:ClassificationIdentificationIDType	
	WhiteSpace	collapse	
	Format	an..18	
	eTIR name	Code	
	Status	R	
schemeID	Type	xs:token	
	Use	optional	
	WhiteSpace	collapse	
schemeAgencyID	Type	clm63055:AgencyIdentificationCodeContentType	
	Length	1 .. 3	
	Use	optional	
	WhiteSpace	collapse	
IdentificationTypeCode	Occurrence	1 .. 1	
	Type	ds:ClassificationIdentificationTypeCodeType	
	WhiteSpace	collapse	
	Format	an..3	
	eTIR name	Type	
	Code List	CL03	Item type identification code
	Status	R	
	Restricted code(s)	HS	Harmonised system
listID	Type	xs:token	
	Use	optional	
	WhiteSpace	collapse	
listAgencyID	Type	clm63055:AgencyIdentificationCodeContentType	
	Length	1 .. 3	
	Use	optional	
	WhiteSpace	collapse	
Consignee	Occurrence	0 .. 1	
	eTIR name	Consignee	
	Status	O	
xs:sequence	Occurrence	1 .. 1	
Name	Occurrence	0 .. 1	
	Type	ds:ConsigneeNameTextType	
	Format	an..70	
	eTIR name	Name	
	Status	D	
	Condition	C001	
languageID	Type	xs:language	
	Use	optional	
	Pattern	([a-zA-Z]{2} [il]-[a-zA-Z]+ [xX]-[a-zA-Z]{1,8})-[a-zA-Z]{1,8})*	
	WhiteSpace	collapse	
ID	Occurrence	0 .. 1	
	Type	ds:ConsigneeIdentificationIDType	
	WhiteSpace	collapse	

	Format	an..17
	eTIR name	Code
	Status	D
	Condition	C001
<i>schemeID</i>	Type	xs:token
	Use	optional
	WhiteSpace	collapse
<i>schemeAgencyID</i>	Type	clm63055:AgencyIdentificationCodeContentType
	Length	1 .. 3
	Use	optional
	WhiteSpace	collapse
Address	Occurrence	0 .. 1
	eTIR name	Address
	Status	D
	Condition	C001
<i>xs:sequence</i>	Occurrence	1 .. 1
CityName	Occurrence	1 .. 1
	Type	ds:AddressCityNameTextType
	Format	an..35
	eTIR name	City name
	Status	R
<i>languageID</i>	Type	xs:language
	Use	optional
	Pattern	([a-zA-Z]{2} [iI]-[a-zA-Z]+ [xX]-[a-zA-Z]{1,8})-[a-zA-Z]{1,8})*
	WhiteSpace	collapse
CountryCode	Occurrence	1 .. 1
	Type	ds:AddressCountryCodeType
	WhiteSpace	collapse
	Format	a2
	Code List	CL04 Country name code
	eTIR name	Country, coded
	Status	R
<i>listID</i>	Type	xs:token
	Use	optional
	WhiteSpace	collapse
<i>listAgencyID</i>	Type	clm63055:AgencyIdentificationCodeContentType
	Length	1 .. 3
	Use	optional
	WhiteSpace	collapse
Line	Occurrence	1 .. 1
	Type	ds:AddressLineTextType
	Format	an..70
	eTIR name	Street and number/P.O. Box
	Status	R
<i>languageID</i>	Type	xs:language
	Use	optional
	Pattern	([a-zA-Z]{2} [iI]-[a-zA-Z]+ [xX]-[a-zA-Z]{1,8})-[a-zA-Z]{1,8})*
	WhiteSpace	collapse
PostcodeID	Occurrence	1 .. 1
	Type	ds:AddressPostcodeIDType
	WhiteSpace	collapse
	Format	an..9
	eTIR name	Postcode identification
	Status	R
<i>schemeID</i>	Type	xs:token
	Use	optional
	WhiteSpace	collapse
<i>schemeAgencyID</i>	Type	clm63055:AgencyIdentificationCodeContentType
	Length	1 .. 3
	Use	optional
	WhiteSpace	collapse
Consignor	Occurrence	0 .. 1
	eTIR name	Consignor

	Status	O
xs:sequence	Occurrence	1 .. 1
Name	Occurrence	0 .. 1
	Type	ds:ConsignorNameTextType
	Format	an..70
	eTIR name	Name
	Status	D
	Condition	C001
languageID	Type	xs:language
	Use	optional
	Pattern	([a-zA-Z]{2} [iI]-[a-zA-Z]+ [xX]-[a-zA-Z]{1,8})-([a-zA-Z]{1,8})*
	WhiteSpace	collapse
ID	Occurrence	0 .. 1
	Type	ds:ConsignorIdentificationIDType
	WhiteSpace	collapse
	Format	an..17
	eTIR name	Code
	Status	D
	Condition	C001
schemeID	Type	xs:token
	Use	optional
	WhiteSpace	collapse
schemeAgencyID	Type	clm63055:AgencyIdentificationCodeContentType
	Length	1 .. 3
	Use	optional
	WhiteSpace	collapse
Address	Occurrence	0 .. 1
	eTIR name	Address
	Status	D
	Condition	C001
xs:sequence	Occurrence	1 .. 1
CityName	Occurrence	1 .. 1
	Type	ds:AddressCityNameTextType
	Format	an..35
	eTIR name	City name
	Status	R
languageID	Type	xs:language
	Use	optional
	Pattern	([a-zA-Z]{2} [iI]-[a-zA-Z]+ [xX]-[a-zA-Z]{1,8})-([a-zA-Z]{1,8})*
	WhiteSpace	collapse
CountryCode	Occurrence	1 .. 1
	Type	ds:AddressCountryCodeType
	WhiteSpace	collapse
	Format	a2
	Code List	CL04 Country name code
	eTIR name	Country, coded
	Status	R
listID	Type	xs:token
	Use	optional
	WhiteSpace	collapse
listAgencyID	Type	clm63055:AgencyIdentificationCodeContentType
	Length	1 .. 3
	Use	optional
	WhiteSpace	collapse
Line	Occurrence	1 .. 1
	Type	ds:AddressLineTextType
	Format	an..70
	eTIR name	Street and number/P.O. Box
	Status	R

languageID	Type Use Pattern	xs:language optional ([a-zA-Z]{2} [iI]-[a-zA-Z]+ [xX]-[a-zA-Z]{1,8})-[a-zA-Z]{1,8})*
PostcodeID	WhiteSpace Occurrence Type WhiteSpace Format eTIR name Status	collapse 1 .. 1 ds:AddressPostcodeIDType collapse an..9 Postcode identification R
schemeID	Type Use WhiteSpace	xs:token optional collapse
schemeAgencyID	Type Length Use WhiteSpace	clm63055:AgencyIdentificationCodeContentType 1 .. 3 optional collapse
DeliveryDestination	Occurrence eTIR name Status	0 .. 1 DeliveryDestination O
xs:sequence	Occurrence	1 .. 1
Name	Occurrence Type Format eTIR name Status	1 .. 1 ds:DeliveryDestinationNameTextType an..70 Name R
languageID	Type Use Pattern	xs:language optional ([a-zA-Z]{2} [iI]-[a-zA-Z]+ [xX]-[a-zA-Z]{1,8})-[a-zA-Z]{1,8})*
Address	WhiteSpace Occurrence eTIR name Status	collapse 1 .. 1 Address R
xs:sequence	Occurrence	1 .. 1
CityName	Occurrence Type Format eTIR name Status	1 .. 1 ds:AddressCityNameTextType an..35 City name R
languageID	Type Use Pattern	xs:language optional ([a-zA-Z]{2} [iI]-[a-zA-Z]+ [xX]-[a-zA-Z]{1,8})-[a-zA-Z]{1,8})*
CountryCode	WhiteSpace Occurrence Type WhiteSpace Format Code List eTIR name Status	collapse 1 .. 1 ds:AddressCountryCodeType collapse a2 CL04 Country name code Country, coded R
listID	Type Use WhiteSpace	xs:token optional collapse
listAgencyID	Type Length Use WhiteSpace	clm63055:AgencyIdentificationCodeContentType 1 .. 3 optional collapse
Line	Occurrence Type Format eTIR name Status	1 .. 1 ds:AddressLineTextType an..70 Street and number/P.O. Box R

<i>languageID</i>	Type Use Pattern WhiteSpace	xs:language optional ([a-zA-Z]{2} [iI]-[a-zA-Z]+ [xX]-[a-zA-Z]{1,8})-([a-zA-Z]{1,8})* collapse
PostcodeID	Occurrence Type WhiteSpace Format eTIR name Status	1 .. 1 ds:AddressPostcodeIDType collapse an..9 Postcode identification R
<i>schemeID</i>	Type Use WhiteSpace	xs:token optional collapse
<i>schemeAgencyID</i>	Type Length Use WhiteSpace	clm63055:AgencyIdentificationCodeContentType 1 .. 3 optional collapse
GoodsMeasure	Occurrence eTIR name Status	1 .. 1 GoodsMeasure R
xs:sequence	Occurrence	1 .. 1
GrossMassMeasure	Occurrence Type Format eTIR name Status	1 .. 1 ds:GoodsMeasureGrossMassMeasureType n..16,6 Gross weight R
<i>unitCode</i>	Type Length Use WhiteSpace	clm6Recommendation20: MeasurementUnitCommonCodeContentType 1 .. 3 required collapse
Packaging	Occurrence eTIR name Status	1 .. 1 Packaging R
xs:sequence	Occurrence	1 .. 1
MarksNumbersID	Occurrence Type WhiteSpace Format eTIR name Status	0 .. 1 ds:PackagingMarksNumbersIDType collapse an..512 Marks and numbers O
<i>schemeID</i>	Type Use WhiteSpace	xs:token optional collapse
<i>schemeAgencyID</i>	Type Length Use WhiteSpace	clm63055:AgencyIdentificationCodeContentType 1 .. 3 optional collapse
QuantityQuantity	Occurrence Type Format eTIR name Status Condition	0 .. 1 ds:PackagingQuantityQuantityType n..8 Number of packages D C002
<i>unitCode</i>	Type Length Use WhiteSpace	clm6Recommendation20: MeasurementUnitCommonCodeContentType 1 .. 3 required collapse
TypeCode	Occurrence Type WhiteSpace Format eTIR name	1 .. 1 ds:PackagingTypeCodeType collapse an..2 Type, coded

	Code List	CL07	Package type description code
	Status	R	
	Type	xs:token	
	Use	optional	
	WhiteSpace	collapse	
<i>listID</i>	Type	clm63055:AgencyIdentificationCodeContentType	
	Length	1 .. 3	
	Use	optional	
	WhiteSpace	collapse	
TransportEquipment	Occurrence	0 .. 1	
	eTIR name	TransportEquipment	
	Status	D	
	Condition	C003	
<i>xs:sequence</i>	Occurrence	1 .. 1	
ID	Occurrence	1 .. 1	
	Type	ds:TransportEquipmentIdentificationIDType	
	WhiteSpace	collapse	
	Format	an..17	
	eTIR name	Identification	
	Status	R	
<i>schemeID</i>	Type	xs:token	
	Use	optional	
	WhiteSpace	collapse	
<i>schemeAgencyID</i>	Type	clm63055:AgencyIdentificationCodeContentType	
	Length	1 .. 3	
	Use	optional	
	WhiteSpace	collapse	
UCR	Occurrence	0 .. 1	
	eTIR name	UCR	
	Status	O	
<i>xs:sequence</i>	Occurrence	1 .. 1	
ID	Occurrence	0 .. 1	
	Type	ds:UCRIdentificationIDType	
	WhiteSpace	collapse	
	Format	an..35	
	eTIR name	Identifier	
	Status	O	
<i>schemeID</i>	Type	xs:token	
	Use	optional	
	WhiteSpace	collapse	
<i>schemeAgencyID</i>	Type	clm63055:AgencyIdentificationCodeContentType	
	Length	1 .. 3	
	Use	optional	
	WhiteSpace	collapse	
LoadingLocation	Occurrence	0 .. 1	
	eTIR name	LoadingLocation	
	Status	O	
<i>xs:sequence</i>	Occurrence	1 .. 1	
Name	Occurrence	0 .. 1	
	Type	ds>LoadingLocationNameTextType	
	Format	an..256	
	eTIR name	Name	
	Status	O	
<i>languageID</i>	Type	xs:language	
	Use	optional	
	Pattern	([a-zA-Z]{2})[il]-[a-zA-Z]+[xX]-[a-zA-Z]{1,8}-[a-zA-Z]{1,8)*	
	WhiteSpace	collapse	
NotifyParty	Occurrence	0 .. 1	
	eTIR name	NotifyParty	
	Status	O	
<i>xs:sequence</i>	Occurrence	1 .. 1	
Name	Occurrence	0 .. 1	
	Type	ds:NotifyPartyNameTextType	
	Format	an..70	

	eTIR name	Name
	Status	D
	Condition	C001
<i>languageID</i>	Type	xs:language
	Use	optional
	Pattern	([a-zA-Z]{2} [iI]-[a-zA-Z]+ [xX]-[a-zA-Z]{1,8})-([a-zA-Z]{1,8})*
	WhiteSpace	collapse
ID	Occurrence	0 .. 1
	Type	ds:NotifyPartyIdentificationIDType
	WhiteSpace	collapse
	Format	an..17
	eTIR name	Code
	Status	D
	Condition	C001
<i>schemeID</i>	Type	xs:token
	Use	optional
	WhiteSpace	collapse
<i>schemeAgencyID</i>	Type	clm63055:AgencyIdentificationCodeContentType
	Length	1 .. 3
	Use	optional
	WhiteSpace	collapse
Address	Occurrence	0 .. 1
	eTIR name	Address
	Status	D
	Condition	C001
<i>xs:sequence</i>	Occurrence	1 .. 1
CityName	Occurrence	1 .. 1
	Type	ds:AddressCityNameTextType
	Format	an..35
	eTIR name	City name
	Status	R
<i>languageID</i>	Type	xs:language
	Use	optional
	Pattern	([a-zA-Z]{2} [iI]-[a-zA-Z]+ [xX]-[a-zA-Z]{1,8})-([a-zA-Z]{1,8})*
	WhiteSpace	collapse
CountryCode	Occurrence	1 .. 1
	Type	ds:AddressCountryCodeType
	WhiteSpace	collapse
	Format	a2
	Code List	CL04 Country name code
	eTIR name	Country, coded
	Status	R
<i>listID</i>	Type	xs:token
	Use	optional
	WhiteSpace	collapse
<i>listAgencyID</i>	Type	clm63055:AgencyIdentificationCodeContentType
	Length	1 .. 3
	Use	optional
	WhiteSpace	collapse
Line	Occurrence	1 .. 1
	Type	ds:AddressLineTextType
	Format	an..70
	eTIR name	Street and number/P.O. Box
	Status	R
<i>languageID</i>	Type	xs:language
	Use	optional
	Pattern	([a-zA-Z]{2} [iI]-[a-zA-Z]+ [xX]-[a-zA-Z]{1,8})-([a-zA-Z]{1,8})*
	WhiteSpace	collapse
PostcodeID	Occurrence	1 .. 1
	Type	ds:AddressPostcodeIDType
	WhiteSpace	collapse
	Format	an..9

		eTIR name	Postcode identification
		Status	R
		Type	xs:token
		Use	optional
		WhiteSpace	collapse
	<i>schemeID</i>		
	<i>schemeAgencyID</i>	Type	clm63055:AgencyIdentificationCodeContentType
		Length	1 .. 3
		Use	optional
		WhiteSpace	collapse
	TransitDeparture	Occurrence	1 .. 1
		eTIR name	CustomsOfficeOfDeparture
		Status	R
	<i>xs:sequence</i>	Occurrence	1 .. 1
	ID	Occurrence	1 .. 1
		Type	ds:TransitDepartureIdentificationIDType
		WhiteSpace	collapse
		Format	an..17
		eTIR name	Code
		Code List	CL13 Customs offices database (to be developed)
		Status	R
	<i>schemeID</i>	Type	xs:token
		Use	optional
		WhiteSpace	collapse
	<i>schemeAgencyID</i>	Type	clm63055:AgencyIdentificationCodeContentType
		Length	1 .. 3
		Use	optional
		WhiteSpace	collapse
	TransitDestination	Occurrence	1 .. 1
		eTIR name	CustomsOfficeOfDestination
		Status	R
	<i>xs:sequence</i>	Occurrence	1 .. 1
	ID	Occurrence	1 .. 1
		Type	ds:TransitDestinationIdentificationIDType
		WhiteSpace	collapse
		Format	an..17
		eTIR name	Code
		Code List	CL13 Customs offices database (to be developed)
		Status	R
	<i>schemeID</i>	Type	xs:token
		Use	optional
		WhiteSpace	collapse
	<i>schemeAgencyID</i>	Type	clm63055:AgencyIdentificationCodeContentType
		Length	1 .. 3
		Use	optional
		WhiteSpace	collapse
	TransitTransportMeans	Occurrence	1 .. unbounded
		eTIR name	TransportMean
		Status	R
	<i>xs:sequence</i>	Occurrence	1 .. 1
	ID	Occurrence	1 .. 1
		Type	ds:TransitTransportMeansIdentificationIDType
		WhiteSpace	collapse
		Format	an..25
		eTIR name	Identification
		Status	R
	<i>schemeID</i>	Type	xs:token
		Use	optional
		WhiteSpace	collapse
	<i>schemeAgencyID</i>	Type	clm63055:AgencyIdentificationCodeContentType
		Length	1 .. 3
		Use	optional
		WhiteSpace	collapse

TypeCode	Occurrence 1 .. 1 Type ds:TransitTransportMeansTypeCodeType WhiteSpace collapse Format an..4 eTIR name Type, coded Code List CL05 Transport means description code Status R
<i>listID</i>	Type xs:token Use optional WhiteSpace collapse
<i>listAgencyID</i>	Type clm63055:AgencyIdentificationCodeContentType Length 1 .. 3 Use optional WhiteSpace collapse
RegistrationNationalityCode	Occurrence 1 .. 1 Type ds:TransitTransportMeansRegistrationNationalityCodeType WhiteSpace collapse Format a2 eTIR name Nationality Code List CL04 Country name code Status R
<i>listID</i>	Type xs:token Use optional WhiteSpace collapse
<i>listAgencyID</i>	Type clm63055:AgencyIdentificationCodeContentType Length 1 .. 3 Use optional WhiteSpace collapse
JourneyID	Occurrence 0 .. 1 Type ds:TransitTransportMeansJourneyIDType WhiteSpace collapse Format an..17 eTIR name Conveyance reference number Status O
<i>schemeID</i>	Type xs:token Use optional WhiteSpace collapse
<i>schemeAgencyID</i>	Type clm63055:AgencyIdentificationCodeContentType Length 1 .. 3 Use optional WhiteSpace collapse
Itinerary	Occurrence 1 .. unbounded eTIR name CountryOfRouting Status R
<i>xs:sequence</i>	Occurrence 1 .. 1
SequenceNumeric	Occurrence 1 .. 1 Type ds:ItinerarySequenceNumericType Format n..5 eTIR name Sequence number Status R
RoutingCountryCode	Occurrence 1 .. 1 Type ds:ItineraryRoutingCountryCodeType WhiteSpace collapse Format a2 eTIR name Country, coded Code List CL04 Country name code Status R
<i>listID</i>	Type xs:token Use optional WhiteSpace collapse
<i>listAgencyID</i>	Type clm63055:AgencyIdentificationCodeContentType Length 1 .. 3 Use optional WhiteSpace collapse

AdditionalDocument	Occurrence	0 .. 1
	eTIR name	CertificateOfApproval
	Status	D
	Condition	C005
xs:sequence	Occurrence	1 .. 1
IssueDateTime	Occurrence	1 .. 1
	Type	ds:AdditionalDocumentIssueDateTimeType
	WhiteSpace	collapse
	Format	an..17
	eTIR name	Date
	Status	R
formatCode	Type	clm62379:DateTimePeriodFormatCode
	Length	1 .. 3
	Use	required
	WhiteSpace	collapse
	Name	Date or time or period format code
	Description	Code specifying the representation of a date, time or period.
	Applicable Codes	
	102	CCYYMMDD Calendar date: C = Century ; Y = Year ; M = Month ; D = Day.
	304	CCYYMMDDHHMMSSZZ See 204 plus Z=Time zone.
	602	CCYY Calendar year including century: C = Century; Y = Year.
ID	Occurrence	1 .. 1
	Type	ds:AdditionalDocumentIdentificationIDType
	WhiteSpace	collapse
	Format	an..35
	eTIR name	Number
	Status	R
schemeID	Type	xs:token
	Use	optional
	WhiteSpace	collapse
schemeAgencyID	Type	clm63055:AgencyIdentificationCodeContentType
	Length	1 .. 3
	Use	optional
	WhiteSpace	collapse
TypeCode	Occurrence	1 .. 1
	Type	ds:AdditionalDocumentTypeCodeType
	WhiteSpace	collapse
	Format	an..3
	eTIR name	Type, coded
	Code List	CL06 Document name code
	Status	R
listID	Type	xs:token
	Use	optional
	WhiteSpace	collapse
listAgencyID	Type	clm63055:AgencyIdentificationCodeContentType
	Length	1 .. 3
	Use	optional
	WhiteSpace	collapse
TransportEquipment	Occurrence	0 .. unbounded
	eTIR name	TransportEquipment
	Status	D
	Condition	C003
xs:sequence	Occurrence	1 .. 1
SequenceNumeric	Occurrence	1 .. 1
	Type	ds:TransportEquipmentSequenceNumericType
	Format	n..5
	eTIR name	Sequence number
	Status	R
CharacteristicCode	Occurrence	1 .. 1
	Type	ds:TransportEquipmentCharacteristicCodeType
	WhiteSpace	collapse

	Format	an..4
	eTIR name	Size and type identification
	Code List	CL01 Equipment size and type description code
	Status	R
listID	Type	xs:token
	Use	optional
	WhiteSpace	collapse
listAgencyID	Type	clm63055:AgencyIdentificationCodeContentType
	Length	1 .. 3
	Use	optional
	WhiteSpace	collapse
ID	Occurrence	1 .. 1
	Type	ds:TransportEquipmentIdentificationIDType
	WhiteSpace	collapse
	Format	an..17
	eTIR name	Identification
	Status	R
schemeID	Type	xs:token
	Use	optional
	WhiteSpace	collapse
schemeAgencyID	Type	clm63055:AgencyIdentificationCodeContentType
	Length	1 .. 3
	Use	optional
	WhiteSpace	collapse
Seal	Occurrence	0 .. unbounded
	eTIR name	Seal
	Status	O
xs:sequence	Occurrence	1 .. 1
SequenceNumeric	Occurrence	1 .. 1
	Type	ds:SealSequenceNumericType
	Format	n..5
	eTIR name	Sequence number
	Status	R
ID	Occurrence	1 .. 1
	Type	ds:SealIdentificationIDType
	WhiteSpace	collapse
	Format	an..35
	eTIR name	Seal number
	Status	R
schemeID	Type	xs:token
	Use	optional
	WhiteSpace	collapse
schemeAgencyID	Type	clm63055:AgencyIdentificationCodeContentType
	Length	1 .. 3
	Use	optional
	WhiteSpace	collapse
TypeCode	Occurrence	0 .. 1
	Type	ds:SealTypeCodeType
	WhiteSpace	collapse
	Format	an..3
	eTIR name	Seal type code
	Status	O
	Code List	CL08 Seal type code
listID	Type	xs:token
	Use	optional
	WhiteSpace	collapse
listAgencyID	Type	clm63055:AgencyIdentificationCodeContentType
	Length	1 .. 3
	Use	optional
	WhiteSpace	collapse
ObligationGuarantee	Occurrence	1 .. unbounded
	eTIR name	Guarantee
	Status	R
xs:sequence	Occurrence	1 .. 1

ReferenceID	Occurrence 1 .. 1 Type ds:ObligationGuaranteeReferenceIDType WhiteSpace collapse Format an..35 eTIR name Reference Status R
<i>schemeID</i>	Type xs:token Use optional WhiteSpace collapse
<i>schemeAgencyID</i>	Type ctm63055:AgencyIdentificationCodeContentType Length 1 .. 3 Use optional WhiteSpace collapse
LPCOExpirationDateTime	Occurrence 1 .. 1 Type ds:ObligationGuaranteeLPCOExpirationDateTimeType WhiteSpace collapse Format n8 eTIR name Validity Status R
<i>formatCode</i>	Type ctm62379:DateTimePeriodFormatCode Length 1 .. 3 Use required WhiteSpace collapse Name Date or time or period format code Description Code specifying the representation of a date, time or period. Applicable Codes 102 CCYYMMDD Calendar date: C = Century ; Y = Year ; M = Month ; D = Day. 304 CCYYMMDDHHMMSSZZ See 204 plus Z=Time zone. 602 CCYY Calendar year including century: C = Century; Y = Year.
TransitPrincipal	Occurrence 1 .. 1 eTIR name Holder Status R
xs:sequence	Occurrence 1 .. 1
Name	Occurrence 0 .. 1 Type ds:TransitPrincipalNameTextType Format an..70 eTIR name Name Status O
<i>languageID</i>	Type xs:language Use optional Pattern ([a-zA-Z]{2})[iI]-[a-zA-Z]+ [xX]-[a-zA-Z]{1,8})-([a-zA-Z]{1,8})* WhiteSpace collapse
ID	Occurrence 1 .. 1 Type ds:TransitPrincipalIdentificationIDType WhiteSpace collapse Format an..17 eTIR name Code Code List CL15 International TIR database Status R
<i>schemeID</i>	Type xs:token Use optional WhiteSpace collapse
<i>schemeAgencyID</i>	Type ctm63055:AgencyIdentificationCodeContentType Length 1 .. 3 Use optional WhiteSpace collapse
Address	Occurrence 0 .. 1 eTIR name Address Status D Condition C001

xs:sequence	Occurrence	1 .. 1
CityName	Occurrence	1 .. 1
	Type	ds:AddressCityNameTextType
	Format	an..35
	eTIR name	City name
	Status	R
languageID	Type	xs:language
	Use	optional
	Pattern	([a-zA-Z]{2} [iI]-[a-zA-Z]+ [xX]-[a-zA-Z]{1,8})-[a-zA-Z]{1,8})*
	WhiteSpace	collapse
CountryCode	Occurrence	1 .. 1
	Type	ds:AddressCountryCodeType
	WhiteSpace	collapse
	Format	a2
	Code List	CL04 Country name code
	eTIR name	Country, coded
	Status	R
listID	Type	xs:token
	Use	optional
	WhiteSpace	collapse
listAgencyID	Type	clm63055:AgencyIdentificationCodeContentType
	Length	1 .. 3
	Use	optional
	WhiteSpace	collapse
Line	Occurrence	1 .. 1
	Type	ds:AddressLineTextType
	Format	an..70
	eTIR name	Street and number/P.O. Box
	Status	R
languageID	Type	xs:language
	Use	optional
	Pattern	([a-zA-Z]{2} [iI]-[a-zA-Z]+ [xX]-[a-zA-Z]{1,8})-[a-zA-Z]{1,8})*
	WhiteSpace	collapse
PostcodeID	Occurrence	1 .. 1
	Type	ds:AddressPostcodeIDType
	WhiteSpace	collapse
	Format	an..9
	eTIR name	Postcode identification
	Status	R
schemeID	Type	xs:token
	Use	optional
	WhiteSpace	collapse
schemeAgencyID	Type	clm63055:AgencyIdentificationCodeContentType
	Length	1 .. 3
	Use	optional
	WhiteSpace	collapse

4.2.3.1.2.8. I8 – Record advanced cargo information results

a. Structure

Occurance	Element/Attribute
1 .. 1	Message
1 .. 1	xs:sequence
optional	TypeCode
optional	listID
1 .. 1	listAgencyID
optional	ReferenceNumberID
optional	schemeID
optional	schemeAgencyID
1 .. 1	FunctionCode

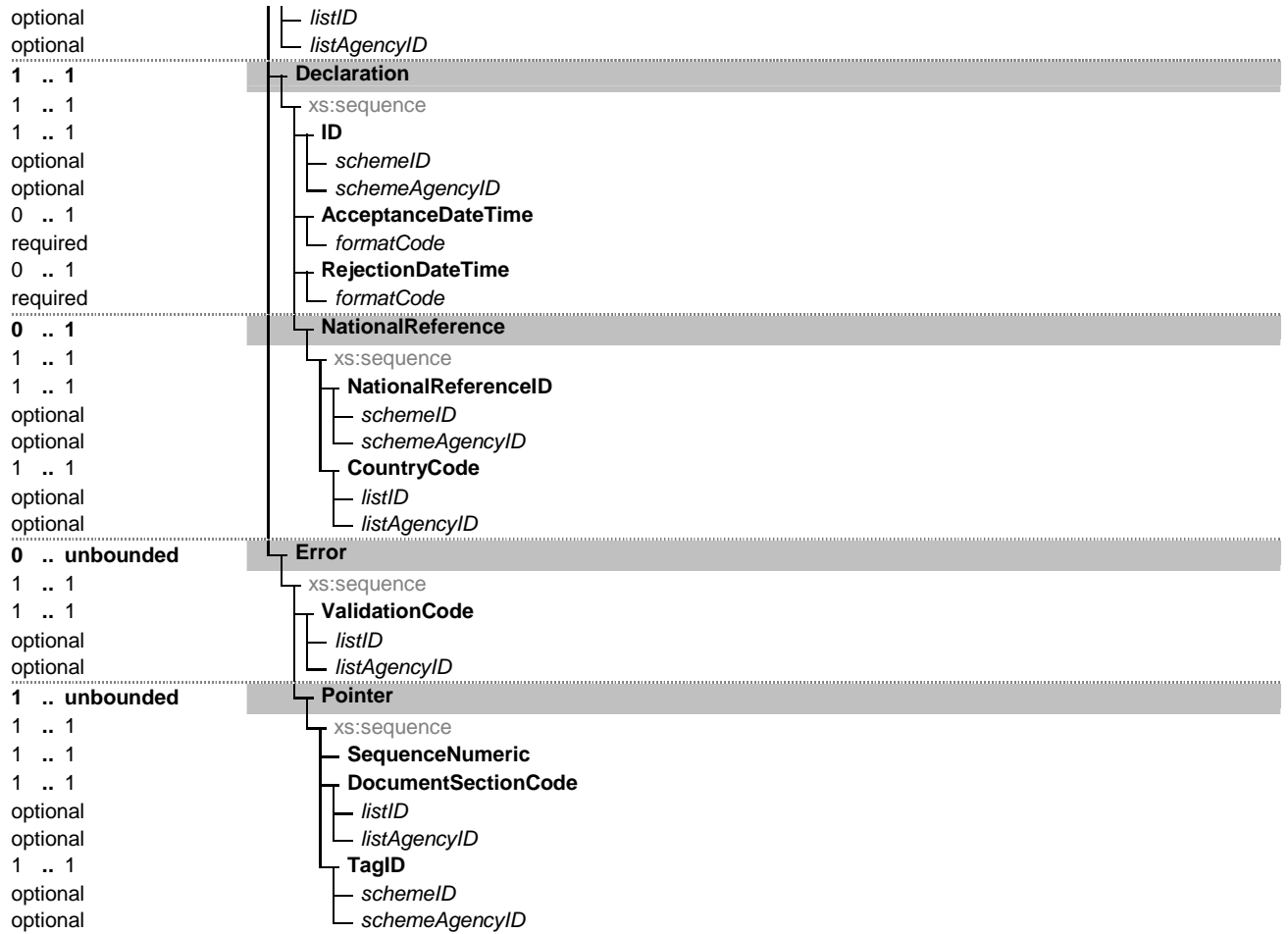

b. Guidelines

Element/Attribute	Annotation
Message	<ul style="list-style-type: none"> eTIR name: Message Occurrence: 1 .. 1 Occurrence Type: 1 .. 1 Type: ds:MessageTypeCodeType WhiteSpace: collapse Format: an..3 eTIR name: Type, coded Status: R Code List: CL26 Restricted code(s): I8 Message types: Recorded advanced cargo information results
<i>listID</i>	<ul style="list-style-type: none"> Type: xs:token Use: optional WhiteSpace: collapse
<i>listAgencyID</i>	<ul style="list-style-type: none"> Type: clm63055:AgencyIdentificationCodeContentType Length: 1 .. 3 Use: optional WhiteSpace: collapse
ReferenceNumberID	<ul style="list-style-type: none"> Occurrence: 1 .. 1 Type: ds:MessageReferenceNumberIDType WhiteSpace: collapse Format: an..14 eTIR name: Message reference number

<i>schemeID</i>	Status R Type xs:token Use optional WhiteSpace collapse
<i>schemeAgencyID</i>	Type clm63055:AgencyIdentificationCodeContentType Length 1 .. 3 Use optional WhiteSpace collapse
FunctionCode	Occurrence 1 .. 1 Type ds:MessageFunctionCodeType WhiteSpace collapse Format n..2 eTIR name Message function, coded Code List CL16 Message function code Status R Restricted code(s) 27 Not accepted Restricted code(s) 44 Accepted without reserves
<i>listID</i>	Type xs:token Use optional WhiteSpace collapse
<i>listAgencyID</i>	Type clm63055:AgencyIdentificationCodeContentType Length 1 .. 3 Use optional WhiteSpace collapse
Declaration	Occurrence 1 .. 1 eTIR name AdvancedCargoInformation Status R
<i>xs:sequence</i>	Occurrence 1 .. 1
ID	Occurrence 1 .. 1 Type ds:DeclarationIdentificationIDType WhiteSpace collapse Format an..35 eTIR name Reference Status R Remark REFERENCE TO THE PREVIOUS MESSAGE
<i>schemeID</i>	Type xs:token Use optional WhiteSpace collapse
<i>schemeAgencyID</i>	Type clm63055:AgencyIdentificationCodeContentType Length 1 .. 3 Use optional WhiteSpace collapse
AcceptanceDateTime	Occurrence 0 .. 1 Type ds:DeclarationAcceptanceDateTimeType WhiteSpace collapse Format an..17 eTIR name Acceptance date Status D Condition C007
<i>formatCode</i>	Type clm62379:DateTimePeriodFormatCode Length 1 .. 3 Use required WhiteSpace collapse Name Date or time or period format code Description Code specifying the representation of a date, time or period.
Applicable Codes	
102	CCYYMMDD Calendar date: C = Century ; Y = Year ; M = Month ; D = Day.
304	CCYYMMDDHHMMSSZZ See 204 plus Z=Time zone.
602	CCYY Calendar year including century: C = Century; Y = Year.

RejectionDateTime	Occurrence	0 .. 1	
	Type	ds:DeclarationRejectionDateTimeType	
	WhiteSpace	collapse	
	Format	an..17	
	eTIR name	Rejection date	
	Status	D	
	Condition	C007	
<i>formatCode</i>	Type	clm62379:DateTimePeriodFormatCode	
	Length	1 .. 3	
	Use	required	
	WhiteSpace	collapse	
	Name	Date or time or period format code	
	Description	Code specifying the representation of a date, time or period.	
	Applicable Codes		
	102	CCYYMMDD	Calendar date: C = Century ; Y = Year ; M = Month ; D = Day.
	304	CCYYMMDDHHMMSSZZ	See 204 plus Z=Time zone.
	602	CCYY	Calendar year including century: C = Century; Y = Year.
NationalReference	Occurrence	0 .. 1	
	eTIR name	NationalReference	
	Status	R	
<i>xs:sequence</i>	Occurrence	1 .. 1	
NationalReferenceID	Occurrence	1 .. 1	
	Type	ds:NationalReferenceNationalReferenceIDType	
	WhiteSpace	collapse	
	Format	an..35	
	eTIR name	Reference	
	Status	R	
<i>schemeID</i>	Type	xs:token	
	Use	optional	
	WhiteSpace	collapse	
<i>schemeAgencyID</i>	Type	clm63055:AgencyIdentificationCodeContentType	
	Length	1 .. 3	
	Use	optional	
	WhiteSpace	collapse	
CountryCode	Occurrence	1 .. 1	
	Type	ds:NationalReferenceCountryCodeType	
	WhiteSpace	collapse	
	Format	a2	
	Code List	CL04	Country name code
	eTIR name	Country, coded	
	Status	R	
<i>listID</i>	Type	xs:token	
	Use	optional	
	WhiteSpace	collapse	
<i>listAgencyID</i>	Type	clm63055:AgencyIdentificationCodeContentType	
	Length	1 .. 3	
	Use	optional	
	WhiteSpace	collapse	
Error	Occurrence	0 .. unbounded	
	eTIR name	Error	
	Status	D	
	Condition	C006	
<i>xs:sequence</i>	Occurrence	1 .. 1	
ValidationCode	Occurrence	1 .. 1	
	Type	ds:ErrorValidationCodeType	
	WhiteSpace	collapse	
	Format	an..8	
	eTIR name	Error, coded	
	Code List	CL99	Error code (to be developed)
	Status	R	

<i>listID</i>	Type Use WhiteSpace	xs:token optional collapse
<i>listAgencyID</i>	Type Length Use WhiteSpace	clm63055:AgencyIdentificationCodeContentType 1 .. 3 optional collapse
Pointer	Occurrence eTIR name Status	1 .. unbounded Pointer R
xs:sequence	Occurrence	1 .. 1
SequenceNumeric	Occurrence Type Format eTIR name Status	1 .. 1 ds:PointerSequenceNumericType n..5 Sequence number R
DocumentSectionCode	Occurrence Type WhiteSpace Format eTIR name Code List Status	1 .. 1 ds:PointerDocumentSectionCodeType collapse an..3 Document/message section, coded CL18 Message section code (codes to be defined) R
<i>listID</i>	Type Use WhiteSpace	xs:token optional collapse
<i>listAgencyID</i>	Type Length Use WhiteSpace	clm63055:AgencyIdentificationCodeContentType 1 .. 3 optional collapse
TagID	Occurrence Type WhiteSpace Format eTIR name Code List Status	1 .. 1 ds:PointerTagIDType collapse an..4 Tag identifier CL19 Pointer code (codes to be defined) R
<i>schemeID</i>	Type Use WhiteSpace	xs:token optional collapse
<i>schemeAgencyID</i>	Type Length Use WhiteSpace	clm63055:AgencyIdentificationCodeContentType 1 .. 3 optional collapse

4.2.3.1.2.9. I9 – Start TIR operation

a. Structure

Occurance	Element/Attribute
1 .. 1	Message
1 .. 1	xs:sequence
optional	TypeCode
optional	<i>listID</i>
optional	<i>listAgencyID</i>
1 .. 1	ReferenceNumberID
optional	<i>schemeID</i>
optional	<i>schemeAgencyID</i>
1 .. 1	FunctionCode
optional	<i>listID</i>
optional	<i>listAgencyID</i>

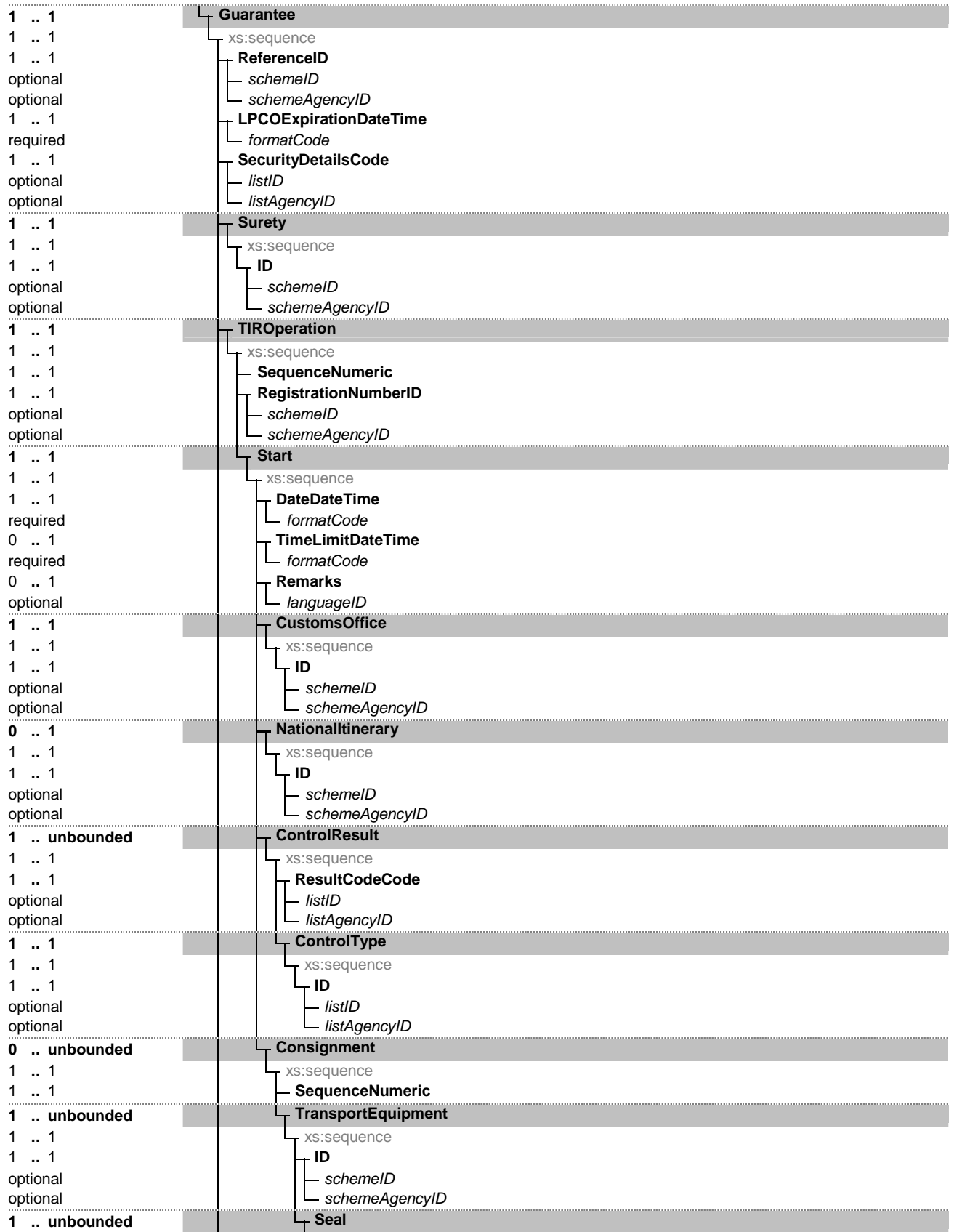

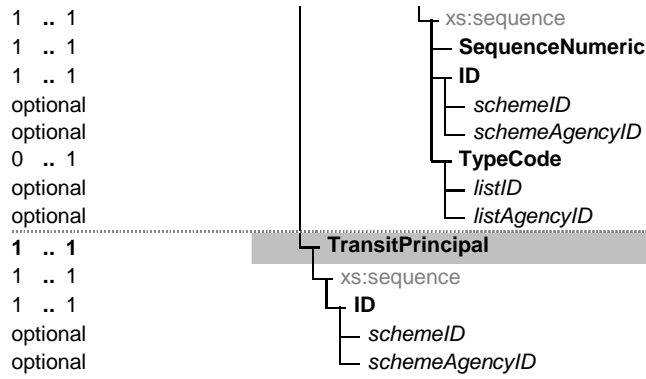

b. Guidelines

Element/Attribute	Annotation
Message	eTIR name Message
xs:sequence	Occurrence 1 .. 1
TypeCode	Occurrence 1 .. 1
	Type ds:MessageTypeCodeType
	WhiteSpace collapse
	Format an..3
	eTIR name Type, coded
	Status R
	Code List CL26 Message types
	Restricted code(s) I9 Start TIR operation
listID	Type xs:token
	Use optional
	WhiteSpace collapse
listAgencyID	Type clm63055:AgencyIdentificationCodeContentType
	Length 1 .. 3
	Use optional
	WhiteSpace collapse
ReferenceNumberID	Occurrence 1 .. 1
	Type ds:MessageReferenceNumberIDType
	WhiteSpace collapse
	Format an..14
	eTIR name Message reference number
	Status R
schemeID	Type xs:token
	Use optional
	WhiteSpace collapse
schemeAgencyID	Type clm63055:AgencyIdentificationCodeContentType
	Length 1 .. 3
	Use optional
	WhiteSpace collapse
FunctionCode	Occurrence 1 .. 1
	Type ds:MessageFunctionCodeType
	WhiteSpace collapse
	Format n..2
	eTIR name Message function, coded
	Code List CL16 Message function code
	Status R
	Restricted code(s) 9 Original
listID	Type xs:token
	Use optional
	WhiteSpace collapse

listAgencyID	Type	clm63055:AgencyIdentificationCodeContentType
	Length	1 .. 3
	Use	optional
	WhiteSpace	collapse
Guarantee	Occurrence	1 .. 1
	eTIR name	Guarantee
	Status	R
xs:sequence	Occurrence	1 .. 1
ReferenceID	Occurrence	1 .. 1
	Type	ds:GuaranteeReferenceIDType
	WhiteSpace	collapse
	Format	an..35
	eTIR name	Reference
	Status	R
schemeID	Type	xs:token
	Use	optional
	WhiteSpace	collapse
schemeAgencyID	Type	clm63055:AgencyIdentificationCodeContentType
	Length	1 .. 3
	Use	optional
	WhiteSpace	collapse
LPCOExpirationDateTime	Occurrence	1 .. 1
	Type	ds:GuaranteeLPCOExpirationDateTimeType
	WhiteSpace	collapse
	Format	n8
	eTIR name	Validity
	Status	R
formatCode	Type	clm62379:DateTimePeriodFormatCode
	Length	1 .. 3
	Use	required
	WhiteSpace	collapse
	Name	Date or time or period format code
	Description	Code specifying the representation of a date, time or period.
	Applicable Codes	
	102	CCYYMMDD Calendar date: C = Century ; Y = Year ; M = Month ; D = Day.
	304	CCYYMMDDHHMMSSZZZ See 204 plus Z=Time zone.
	602	CCYY Calendar year including century: C = Century; Y = Year.
SecurityDetailsCode	Occurrence	1 .. 1
	Type	ds:GuaranteeSecurityDetailsCodeType
	WhiteSpace	collapse
	Format	an..3
	eTIR name	Guarantee type
	Code List	CL12 Guarantee type code
	Status	R
listID	Type	xs:token
	Use	optional
	WhiteSpace	collapse
listAgencyID	Type	clm63055:AgencyIdentificationCodeContentType
	Length	1 .. 3
	Use	optional
	WhiteSpace	collapse
Surety	Occurrence	1 .. 1
	eTIR name	GuaranteeChain
	Status	R
xs:sequence	Occurrence	1 .. 1
ID	Occurrence	1 .. 1
	Type	ds:SuretyIdentificationIDType
	WhiteSpace	collapse
	Format	an..17
	eTIR name	Code
	Status	R

<ul style="list-style-type: none"> — <i>schemeID</i> 	Type xs:token Use optional WhiteSpace collapse
<ul style="list-style-type: none"> — <i>schemeAgencyID</i> 	Type clm63055:AgencyIdentificationCodeContentType Length 1 .. 3 Use optional WhiteSpace collapse
TIROperation	Occurrence 1 .. 1 eTIR name TIROperation Status R
<ul style="list-style-type: none"> — xs:sequence — SequenceNumeric 	Occurrence 1 .. 1 Occurrence 1 .. 1 Type ds:TIROperationSequenceNumericType Format n..5 eTIR name Sequence number Status R
<ul style="list-style-type: none"> — RegistrationNumberID 	Occurrence 1 .. 1 Type ds:TIROperationRegistrationNumberIDType WhiteSpace collapse eTIR name Registration number Format an..35 Status R
<ul style="list-style-type: none"> — <i>schemeID</i> 	Type xs:token Use optional WhiteSpace collapse
<ul style="list-style-type: none"> — <i>schemeAgencyID</i> 	Type clm63055:AgencyIdentificationCodeContentType Length 1 .. 3 Use optional WhiteSpace collapse
<ul style="list-style-type: none"> — Start 	Occurrence 1 .. 1 eTIR name Start Status R
<ul style="list-style-type: none"> — xs:sequence — DateDateTime 	Occurrence 1 .. 1 Occurrence 1 .. 1 Type ds:StartDateDateTimeType WhiteSpace collapse eTIR name Date Format n..17 Status R
<ul style="list-style-type: none"> — <i>formatCode</i> 	Type clm62379:DateTimePeriodFormatCode Length 1 .. 3 Use required WhiteSpace collapse Name Date or time or period format code Description Code specifying the representation of a date, time or period.
Applicable Codes	
	102 CCYYMMDD Calendar date: C = Century ; Y = Year ; M = Month ; D = Day.
	304 CCYYMMDDHHMMSSZZ See 204 plus Z=Time zone.
	602 CCYY Calendar year including century: C = Century; Y = Year.
<ul style="list-style-type: none"> — TimeLimitDateTime 	Occurrence 0 .. 1 Type ds:StartTimeLimitDateTimeType WhiteSpace collapse eTIR name Time limit Format n..17 Status O
<ul style="list-style-type: none"> — <i>formatCode</i> 	Type clm62379:DateTimePeriodFormatCode Length 1 .. 3 Use required WhiteSpace collapse Name Date or time or period format code

	Description	Code specifying the representation of a date, time or period.
	Applicable Codes	
	102	CCYYMMDD Calendar date: C = Century ; Y = Year ; M = Month ; D = Day.
	304	CCYYMMDDHHMMSSZZZ See 204 plus Z=Time zone.
	602	CCYY Calendar year including century: C = Century; Y = Year.
Remarks	Occurrence	0 .. 1
	Type	ds:StartRemarksTextType
	eTIR name	Remarks
	Format	an..512
	Status	O
languageID	Type	xs:language
	Use	optional
	Pattern	([a-zA-Z]{2})?([iI]-[a-zA-Z]+ [xX]-[a-zA-Z]{1,8})?(-[a-zA-Z]{1,8})*
	WhiteSpace	collapse
CustomsOffice	Occurrence	1 .. 1
	eTIR name	CustomsOffice
	Status	R
xs:sequence	Occurrence	1 .. 1
ID	Occurrence	1 .. 1
	Type	ds:CustomsOfficeIdentificationIDType
	WhiteSpace	collapse
	Format	an..17
	eTIR name	Customs office, coded
	Code List	CL13 Customs offices database (to be developed)
	Status	R
schemeID	Type	xs:token
	Use	optional
	WhiteSpace	collapse
schemeAgencyID	Type	clm63055:AgencyIdentificationCodeContentType
	Length	1 .. 3
	Use	optional
	WhiteSpace	collapse
NationalItinerary	Occurrence	0 .. 1
	eTIR name	NationalItinerary
	Status	O
xs:sequence	Occurrence	1 .. 1
ID	Occurrence	1 .. 1
	Type	ds:NationalItineraryIdentificationIDType
	WhiteSpace	collapse
	Format	an..17
	eTIR name	Customs office, coded
	Code List	CL13 Customs offices database (to be developed)
	Status	R
schemeID	Type	xs:token
	Use	optional
	WhiteSpace	collapse
schemeAgencyID	Type	clm63055:AgencyIdentificationCodeContentType
	Length	1 .. 3
	Use	optional
	WhiteSpace	collapse
ControlResult	Occurrence	1 .. unbounded
	eTIR name	ControlResult
	Status	R
xs:sequence	Occurrence	1 .. 1
ResultCodeCode	Occurrence	1 .. 1
	Type	ds:ControlResultResultCodeCodeType
	WhiteSpace	collapse
	eTIR name	Code

		Code List	CL24	Control result code
		Format	an..3	
		Status	R	
	<i>listID</i>	Type	xs:token	
		Use	optional	
		WhiteSpace	collapse	
	<i>listAgencyID</i>	Type	clm63055:AgencyIdentificationCodeContentType	
		Length	1 .. 3	
		Use	optional	
		WhiteSpace	collapse	
	ControlType	Occurrence	1 .. 1	
		eTIR name	ControlType	
		Status	R	
	xs:sequence	Occurrence	1 .. 1	
	ID	Occurrence	1 .. 1	
		Type	ds:ControlTypeIdentificationCodeType	
		WhiteSpace	collapse	
		eTIR name	Identification	
		Format	an..3	
		Code List	CL25	Control type code
		Status	R	
	<i>listID</i>	Type	xs:token	
		Use	optional	
		WhiteSpace	collapse	
	<i>listAgencyID</i>	Type	clm63055:AgencyIdentificationCodeContentType	
		Length	1 .. 3	
		Use	optional	
		WhiteSpace	collapse	
	Consignment	Occurrence	0 .. unbounded	
		Status	O	
		Rule	R007	
		Rule	R006	
		eTIR name	Consignment	
	xs:sequence	Occurrence	1 .. 1	
	SequenceNumeric	Occurrence	1 .. 1	
		Type	ds:ConsignmentSequenceNumericType	
		Format	n..5	
		Status	R	
		eTIR name	Sequence number	
		Status	R	
	TransportEquipment	Occurrence	1 .. unbounded	
		Status	R	
		eTIR name	TransportEquipment	
	xs:sequence	Occurrence	1 .. 1	
	ID	Occurrence	1 .. 1	
		Type	ds:TransportEquipmentIdentificationIDType	
		WhiteSpace	collapse	
		Format	an..17	
		Status	R	
		eTIR name	Identification	
	<i>schemeID</i>	Type	xs:token	
		Use	optional	
		WhiteSpace	collapse	
	<i>schemeAgencyID</i>	Type	clm63055:AgencyIdentificationCodeContentType	
		Length	1 .. 3	
		Use	optional	
		WhiteSpace	collapse	
	Seal	Occurrence	1 .. unbounded	
		Status	R	
		eTIR name	Seal	
	xs:sequence	Occurrence	1 .. 1	
	SequenceNumeric	Occurrence	1 .. 1	
		Type	ds:SealSequenceNumericType	
		Format	n..5	
		Status	R	

		Rule	R003
		Rule	R004
		eTIR name	Sequence number
		Occurrence	1 .. 1
		Type	ds:SealIdentificationIDType
		WhiteSpace	collapse
		Format	an..35
		Status	R
		Rule	R005
		eTIR name	Seal number
		Type	xs:token
		Use	optional
		WhiteSpace	collapse
		Type	clm63055:AgencyIdentificationCodeContentType
		Length	1 .. 3
		Use	optional
		WhiteSpace	collapse
		Occurrence	0 .. 1
		Type	ds:SealTypeCodeType
		WhiteSpace	collapse
		Format	an..3
		Status	O
		eTIR name	Seal type code
		Code List	CL08 Seal type code
		Type	xs:token
		Use	optional
		WhiteSpace	collapse
		Type	clm63055:AgencyIdentificationCodeContentType
		Length	1 .. 3
		Use	optional
		WhiteSpace	collapse
		Occurrence	1 .. 1
		eTIR name	Holder
		Status	R
		Occurrence	1 .. 1
		Occurrence	1 .. 1
		Type	ds:TransitPrincipalIdentificationIDType
		WhiteSpace	collapse
		Format	an..17
		eTIR name	Code
		Code List	CL15 International TIR database
		Status	R
		Type	xs:token
		Use	optional
		WhiteSpace	collapse
		Type	clm63055:AgencyIdentificationCodeContentType
		Length	1 .. 3
		Use	optional
		WhiteSpace	collapse

4.2.3.1.2.10. I10 – Start results

a. Structure

Occurance	Element/Attribute
1 .. 1	Message
1 .. 1	xs:sequence
optional	TypeCode
optional	listID
1 .. 1	listAgencyID
optional	ReferenceNumberID
optional	schemeID
optional	schemeAgencyID

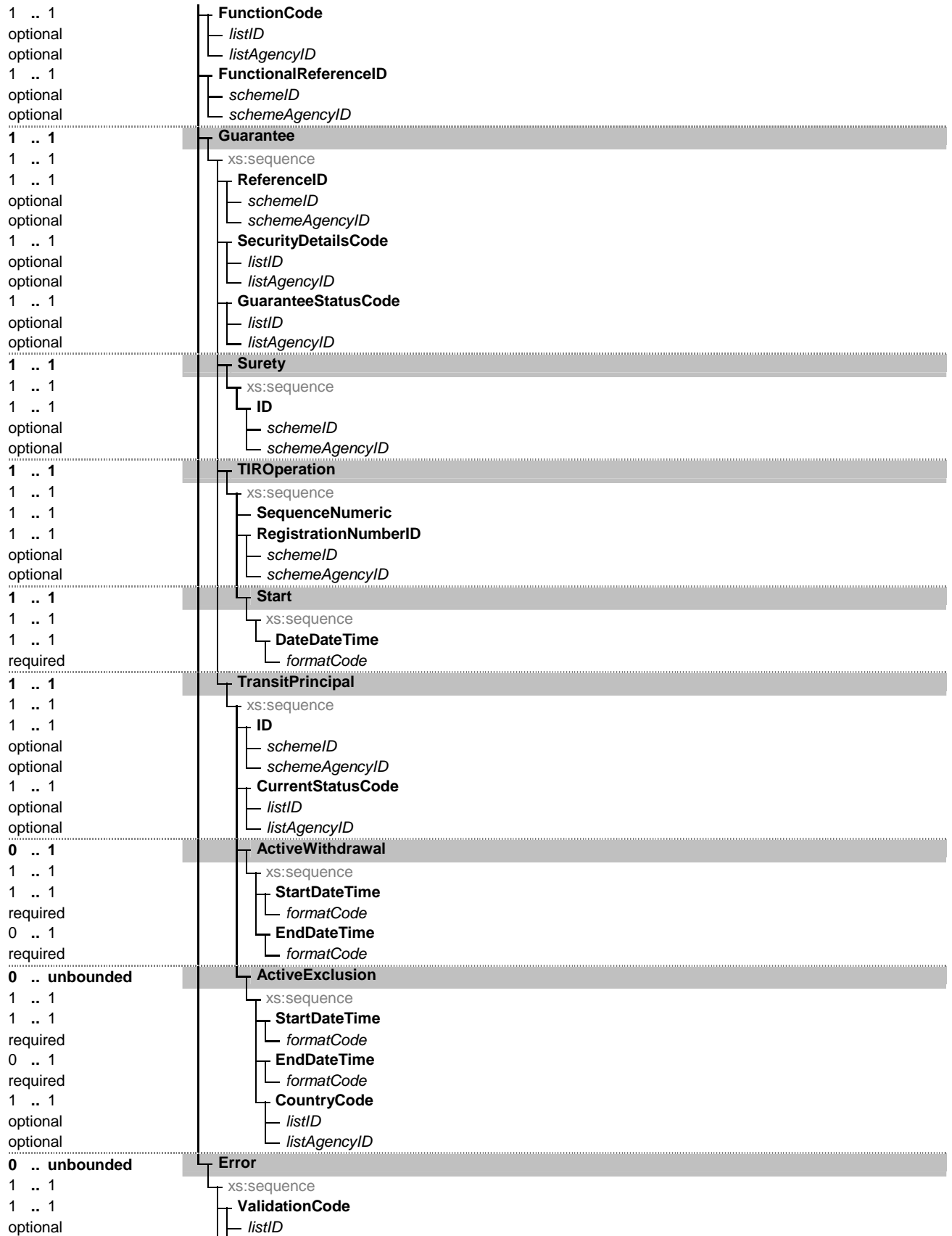

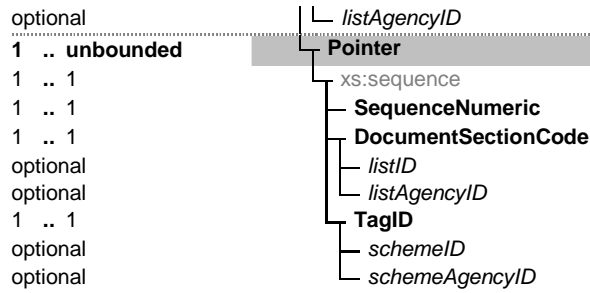

b. Guidelines

Element/Attribute	Annotation
Message	<p>eTIR name Message</p> <p>Occurrence 1 .. 1</p>
<ul style="list-style-type: none"> xs:sequence TypeCode listID listAgencyID ReferenceNumberID schemeID schemeAgencyID FunctionCode listID 	<p>Occurrence 1 .. 1</p> <p>Type ds:MessageTypeCodeType</p> <p>WhiteSpace collapse</p> <p>Format an..3</p> <p>eTIR name Type, coded</p> <p>Status R</p> <p>Code List CL26 Message types</p> <p>Restricted code(s) I10 Start results</p> <p>Type xs:token</p> <p>Use optional</p> <p>WhiteSpace collapse</p> <p>Type clm63055:AgencyIdentificationCodeContentType</p> <p>Length 1 .. 3</p> <p>Use optional</p> <p>WhiteSpace collapse</p> <p>Occurrence 1 .. 1</p> <p>Type ds:MessageReferenceNumberIDType</p> <p>WhiteSpace collapse</p> <p>Format an..14</p> <p>eTIR name Message reference number</p> <p>Status R</p> <p>Type xs:token</p> <p>Use optional</p> <p>WhiteSpace collapse</p> <p>Type clm63055:AgencyIdentificationCodeContentType</p> <p>Length 1 .. 3</p> <p>Use optional</p> <p>WhiteSpace collapse</p> <p>Occurrence 1 .. 1</p> <p>Type ds:MessageFunctionCodeType</p> <p>WhiteSpace collapse</p> <p>Format n..2</p> <p>eTIR name Message function, coded</p> <p>Code List CL16 Message function code</p> <p>Status R</p> <p>Restricted code(s) 27 Not accepted</p> <p>Restricted code(s) 44 Accepted without reserves</p> <p>Type xs:token</p> <p>Use optional</p> <p>WhiteSpace collapse</p>

<i>listAgencyID</i>	Type	clm63055:AgencyIdentificationCodeContentType
	Length	1 .. 3
	Use	optional
	WhiteSpace	collapse
FunctionalReferenceID	Occurrence	1 .. 1
	Type	ds:MessageFunctionalReferenceIDType
	WhiteSpace	collapse
	Format	an..35
	eTIR name	Functional reference
	Status	R
<i>schemeID</i>	Type	xs:token
	Use	optional
	WhiteSpace	collapse
<i>schemeAgencyID</i>	Type	clm63055:AgencyIdentificationCodeContentType
	Length	1 .. 3
	Use	optional
	WhiteSpace	collapse
Guarantee	Occurrence	1 .. 1
	eTIR name	Guarantee
	Status	R
<i>xs:sequence</i>	Occurrence	1 .. 1
ReferenceID	Occurrence	1 .. 1
	Type	ds:GuaranteeReferenceIDType
	WhiteSpace	collapse
	Format	an..35
	eTIR name	Reference
	Status	R
<i>schemeID</i>	Type	xs:token
	Use	optional
	WhiteSpace	collapse
<i>schemeAgencyID</i>	Type	clm63055:AgencyIdentificationCodeContentType
	Length	1 .. 3
	Use	optional
	WhiteSpace	collapse
SecurityDetailsCode	Occurrence	1 .. 1
	Type	ds:GuaranteeSecurityDetailsCodeType
	WhiteSpace	collapse
	Format	an..3
	eTIR name	Guarantee type
	Code List	CL12 Guarantee type code
	Status	R
<i>listID</i>	Type	xs:token
	Use	optional
	WhiteSpace	collapse
<i>listAgencyID</i>	Type	clm63055:AgencyIdentificationCodeContentType
	Length	1 .. 3
	Use	optional
	WhiteSpace	collapse
GuaranteeStatusCode	Occurrence	1 .. 1
	Type	ds:GuaranteeGuaranteeStatusCodeType
	WhiteSpace	collapse
	Format	an..3
	Code List	CL22 Guarantee status
	eTIR name	Guarantee status
	Status	R
<i>listID</i>	Type	xs:token
	Use	optional
	WhiteSpace	collapse
<i>listAgencyID</i>	Type	clm63055:AgencyIdentificationCodeContentType
	Length	1 .. 3
	Use	optional
	WhiteSpace	collapse
Surety	Occurrence	1 .. 1
	eTIR name	GuaranteeChain
	Status	R

xs:sequence	Occurrence	1 .. 1
ID	Occurrence	1 .. 1
	Type	ds:SuretyIdentificationIDType
	WhiteSpace	collapse
	Format	an..17
	eTIR name	Code
	Status	R
schemeID	Type	xs:token
	Use	optional
	WhiteSpace	collapse
schemeAgencyID	Type	clm63055:AgencyIdentificationCodeContentType
	Length	1 .. 3
	Use	optional
	WhiteSpace	collapse
TIROperation	Occurrence	1 .. 1
	eTIR name	TIROperation
	Status	R
xs:sequence	Occurrence	1 .. 1
SequenceNumeric	Occurrence	1 .. 1
	Type	ds:TIROperationSequenceNumericType
	Format	n..5
	eTIR name	Sequence number
	Status	R
RegistrationNumberID	Occurrence	1 .. 1
	Type	ds:TIROperationRegistrationNumberIDType
	WhiteSpace	collapse
	eTIR name	Registration number
	Format	an..35
	Status	R
schemeID	Type	xs:token
	Use	optional
	WhiteSpace	collapse
schemeAgencyID	Type	clm63055:AgencyIdentificationCodeContentType
	Length	1 .. 3
	Use	optional
	WhiteSpace	collapse
Start	Occurrence	1 .. 1
	eTIR name	Start
	Status	R
xs:sequence	Occurrence	1 .. 1
DateDateTime	Occurrence	1 .. 1
	Type	ds:StartDateDateTimeType
	WhiteSpace	collapse
	eTIR name	Date
	Format	n..17
	Status	R
formatCode	Type	clm62379:DateTimePeriodFormatCode
	Length	1 .. 3
	Use	required
	WhiteSpace	collapse
	Name	Date or time or period format code
	Description	Code specifying the representation of a date, time or period.
	Applicable Codes	
	102	CCYYMMDD Calendar date: C = Century ; Y = Year ; M = Month ; D = Day.
	304	CCYYMMDDHHMMSSZZ See 204 plus Z=Time zone.
	602	CCYY Calendar year including century: C = Century; Y = Year.
TransitPrincipal	Occurrence	1 .. 1
	eTIR name	Holder
	Status	R
xs:sequence	Occurrence	1 .. 1

ID	<p>Occurrence 1 .. 1 Type ds:TransitPrincipalIdentificationIDType WhiteSpace collapse Format an..17 eTIR name Code Code List CL15 International TIR database Status R</p>
<i>schemeID</i>	<p>Type xs:token Use optional WhiteSpace collapse</p>
<i>schemeAgencyID</i>	<p>Type clm63055:AgencyIdentificationCodeContentType Length 1 .. 3 Use optional WhiteSpace collapse</p>
CurrentStatusCode	<p>Occurrence 1 .. 1 Type ds:TransitPrincipalCurrentStatusCodeType WhiteSpace collapse Code List CL23 Holder status eTIR name Current status Format an..3 Status R</p>
<i>listID</i>	<p>Type xs:token Use optional WhiteSpace collapse</p>
<i>listAgencyID</i>	<p>Type clm63055:AgencyIdentificationCodeContentType Length 1 .. 3 Use optional WhiteSpace collapse</p>
ActiveWithdrawal	<p>Occurrence 0 .. 1 eTIR name ActiveWithdrawal Status O</p>
xs:sequence	<p>Occurrence 1 .. 1</p>
StartDateTime	<p>Occurrence 1 .. 1 Type ds:ActiveWithdrawalStartDateTimeType WhiteSpace collapse eTIR name Start Format n..17 Status R</p>
<i>formatCode</i>	<p>Type clm62379:DateTimePeriodFormatCode Length 1 .. 3 Use required WhiteSpace collapse Name Date or time or period format code Description Code specifying the representation of a date, time or period.</p> <p>Applicable Codes</p> <p>102 CCYYMMDD Calendar date: C = Century ; Y = Year ; M = Month ; D = Day.</p> <p>304 CCYYMMDDHHMMSSZZ See 204 plus Z=Time zone.</p> <p>602 CCYY Calendar year including century: C = Century; Y = Year.</p>
EndDateTime	<p>Occurrence 0 .. 1 Type ds:ActiveWithdrawalEndDateTimeType WhiteSpace collapse eTIR name End Format n..17 Status O</p>
<i>formatCode</i>	<p>Type clm62379:DateTimePeriodFormatCode Length 1 .. 3 Use required WhiteSpace collapse Name Date or time or period format code Description Code specifying the representation of a date, time or period.</p>

	Applicable Codes
	102 CCYYMMDD Calendar date: C = Century ; Y = Year ; M = Month ; D = Day.
	304 CCYYMMDDHHMMSSZZ See 204 plus Z=Time zone.
	602 CCYY Calendar year including century: C = Century; Y = Year.
ActiveExclusion	Occurrence 0 .. unbounded eTIR name ActiveExclusion Status O
xs:sequence	Occurrence 1 .. 1
StartDateTime	Occurrence 1 .. 1 Type ds:ActiveExclusionStartDateTimeType WhiteSpace collapse eTIR name Start Format n..17 Status R
formatCode	Type clm62379:DateTimePeriodFormatCode Length 1 .. 3 Use required WhiteSpace collapse Name Date or time or period format code Description Code specifying the representation of a date, time or period.
	Applicable Codes
	102 CCYYMMDD Calendar date: C = Century ; Y = Year ; M = Month ; D = Day.
	304 CCYYMMDDHHMMSSZZ See 204 plus Z=Time zone.
	602 CCYY Calendar year including century: C = Century; Y = Year.
EndDateTime	Occurrence 0 .. 1 Type ds:ActiveExclusionEndDateTimeType WhiteSpace collapse eTIR name End Format n..17 Status O
formatCode	Type clm62379:DateTimePeriodFormatCode Length 1 .. 3 Use required WhiteSpace collapse Name Date or time or period format code Description Code specifying the representation of a date, time or period.
	Applicable Codes
	102 CCYYMMDD Calendar date: C = Century ; Y = Year ; M = Month ; D = Day.
	304 CCYYMMDDHHMMSSZZ See 204 plus Z=Time zone.
	602 CCYY Calendar year including century: C = Century; Y = Year.
CountryCode	Occurrence 1 .. 1 Type ds:ActiveExclusionCountryCodeType WhiteSpace collapse Code List CL04 Country name code eTIR name Country, coded Format a2 Status R
listID	Type xs:token Use optional WhiteSpace collapse

<i>listAgencyID</i>	Type	clm63055:AgencyIdentificationCodeContentType
	Length	1 .. 3
	Use	optional
	WhiteSpace	collapse
Error	Occurrence	0 .. unbounded
	eTIR name	Error
	Status	D
	Condition	C006
xs:sequence	Occurrence	1 .. 1
ValidationCode	Occurrence	1 .. 1
	Type	ds:ErrorValidationCodeType
	WhiteSpace	collapse
	Format	an..8
	eTIR name	Error, coded
	Code List	CL99 Error code (to be developed)
	Status	R
<i>listID</i>	Type	xs:token
	Use	optional
	WhiteSpace	collapse
<i>listAgencyID</i>	Type	clm63055:AgencyIdentificationCodeContentType
	Length	1 .. 3
	Use	optional
	WhiteSpace	collapse
Pointer	Occurrence	1 .. unbounded
	eTIR name	Pointer
	Status	R
xs:sequence	Occurrence	1 .. 1
SequenceNumeric	Occurrence	1 .. 1
	Type	ds:PointerSequenceNumericType
	Format	n..5
	eTIR name	Sequence number
	Status	R
DocumentSectionCode	Occurrence	1 .. 1
	Type	ds:PointerDocumentSectionCodeType
	WhiteSpace	collapse
	Format	an..3
	eTIR name	Document/message section, coded
	Code List	CL18 Message section code (codes to be defined)
	Status	R
<i>listID</i>	Type	xs:token
	Use	optional
	WhiteSpace	collapse
<i>listAgencyID</i>	Type	clm63055:AgencyIdentificationCodeContentType
	Length	1 .. 3
	Use	optional
	WhiteSpace	collapse
TagID	Occurrence	1 .. 1
	Type	ds:PointerTagIDType
	WhiteSpace	collapse
	Format	an..4
	eTIR name	Tag identifier
	Code List	CL19 Pointer code (codes to be defined)
	Status	R
<i>schemeID</i>	Type	xs:token
	Use	optional
	WhiteSpace	collapse
<i>schemeAgencyID</i>	Type	clm63055:AgencyIdentificationCodeContentType
	Length	1 .. 3
	Use	optional
	WhiteSpace	collapse

4.2.3.1.2.11. I11 – Terminate TIR operation

a. Structure

Occurance	Element/Attribute
	Message
1 .. 1	xs:sequence
1 .. 1	TypeCode
optional	listID
optional	listAgencyID
1 .. 1	ReferenceNumberID
optional	schemeID
optional	schemeAgencyID
1 .. 1	FunctionCode
optional	listID
optional	listAgencyID
1 .. 1	Guarantee
	xs:sequence
1 .. 1	ReferenceID
optional	schemeID
optional	schemeAgencyID
1 .. 1	LPCOExpirationDateTime
required	formatCode
1 .. 1	SecurityDetailsCode
optional	listID
optional	listAgencyID
1 .. 1	Surety
	xs:sequence
1 .. 1	ID
optional	schemeID
optional	schemeAgencyID
1 .. 1	TIROperation
	xs:sequence
1 .. 1	SequenceNumeric
1 .. 1	RegistrationNumberID
optional	schemeID
optional	schemeAgencyID
1 .. 1	Termination
	xs:sequence
1 .. 1	DateDateTime
required	formatCode
1 .. 1	NumberOfPackagesQuantity
required	unitCode
0 .. 1	Reservations
optional	languageID
1 .. 1	CustomsOffice
	xs:sequence
1 .. 1	ID
optional	schemeID
optional	schemeAgencyID
1 .. unbounded	ControlResult
	xs:sequence
1 .. 1	ResultCodeCode
optional	listID
optional	listAgencyID
1 .. 1	ControlType
	xs:sequence
1 .. 1	ID

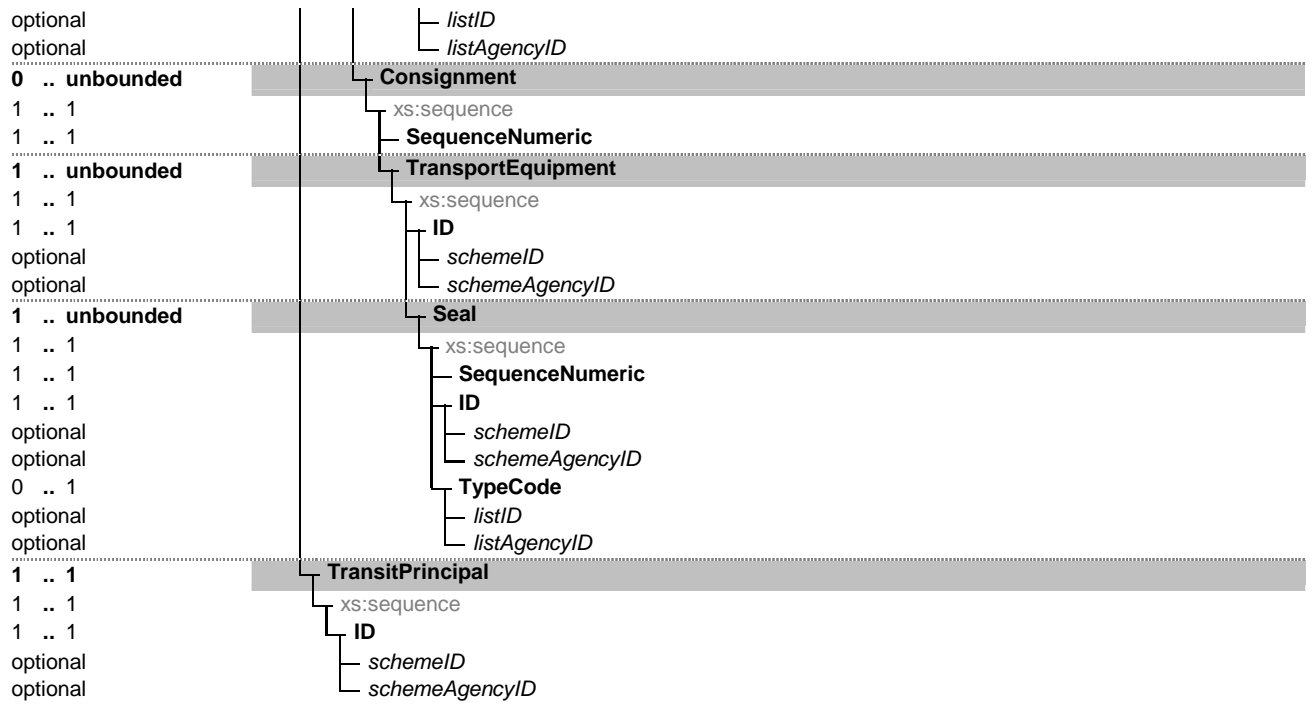

b. Guidelines

Element/Attribute	Annotation
Message	eTIR name Message
xs:sequence	Occurrence 1 .. 1
TypeCode	Occurrence 1 .. 1
	Type ds:MessageTypeCodeType
	WhiteSpace collapse
	Format an..3
	eTIR name Type, coded
	Status R
	Code List CL26 Message types
	Restricted I11 Terminate TIR operation
	code(s)
listID	Type xs:token
	Use optional
	WhiteSpace collapse
listAgencyID	Type ctm63055:AgencyIdentificationCodeContentType
	Length 1 .. 3
	Use optional
	WhiteSpace collapse
ReferenceNumberID	Occurrence 1 .. 1
	Type ds:MessageReferenceNumberIDType
	WhiteSpace collapse
	Format an..14
	eTIR name Message reference number
	Status R
schemeID	Type xs:token
	Use optional
	WhiteSpace collapse
schemeAgencyID	Type ctm63055:AgencyIdentificationCodeContentType
	Length 1 .. 3
	Use optional
	WhiteSpace collapse

FunctionCode	<p>Occurrence 1 .. 1 Type ds:MessageFunctionCodeType WhiteSpace collapse Format n..2 eTIR name Message function, coded Code List CL16 Message function code Status R Restricted code(s) 9 Original</p>						
listID	<p>Type xs:token Use optional WhiteSpace collapse</p>						
listAgencyID	<p>Type clm63055:AgencyIdentificationCodeContentType Length 1 .. 3 Use optional WhiteSpace collapse</p>						
Guarantee	<p>Occurrence 1 .. 1 eTIR name Guarantee Status R</p>						
xs:sequence	<p>Occurrence 1 .. 1</p>						
ReferenceID	<p>Occurrence 1 .. 1 Type ds:GuaranteeReferenceIDType WhiteSpace collapse Format an..35 eTIR name Reference Status R</p>						
schemeID	<p>Type xs:token Use optional WhiteSpace collapse</p>						
schemeAgencyID	<p>Type clm63055:AgencyIdentificationCodeContentType Length 1 .. 3 Use optional WhiteSpace collapse</p>						
LPCOExpirationDateTime	<p>Occurrence 1 .. 1 Type ds:GuaranteeLPCOExpirationDateTimeType WhiteSpace collapse Format n8 eTIR name Validity Status R</p>						
formatCode	<p>Type clm62379:DatePeriodFormatCode Length 1 .. 3 Use required WhiteSpace collapse Name Date or time or period format code Description Code specifying the representation of a date, time or period.</p> <p>Applicable Codes</p> <table border="1"> <tr> <td>102</td> <td>CCYYMMDD Calendar date: C = Century ; Y = Year ; M = Month ; D = Day.</td> </tr> <tr> <td>304</td> <td>CCYYMMDDHHMMSSZZ See 204 plus Z=Time zone.</td> </tr> <tr> <td>602</td> <td>CCYY Calendar year including century: C = Century; Y = Year.</td> </tr> </table>	102	CCYYMMDD Calendar date: C = Century ; Y = Year ; M = Month ; D = Day.	304	CCYYMMDDHHMMSSZZ See 204 plus Z=Time zone.	602	CCYY Calendar year including century: C = Century; Y = Year.
102	CCYYMMDD Calendar date: C = Century ; Y = Year ; M = Month ; D = Day.						
304	CCYYMMDDHHMMSSZZ See 204 plus Z=Time zone.						
602	CCYY Calendar year including century: C = Century; Y = Year.						
SecurityDetailsCode	<p>Occurrence 1 .. 1 Type ds:GuaranteeSecurityDetailsCodeType WhiteSpace collapse Format an..3 eTIR name Guarantee type Code List CL12 Guarantee type code Status R</p>						
listID	<p>Type xs:token Use optional WhiteSpace collapse</p>						

<i>listAgencyID</i>	Type	clm63055:AgencyIdentificationCodeContentType
	Length	1 .. 3
	Use	optional
	WhiteSpace	collapse
Surety	Occurrence	1 .. 1
	eTIR name	GuaranteeChain
	Status	R
xs:sequence	Occurrence	1 .. 1
ID	Occurrence	1 .. 1
	Type	ds:SuretyIdentificationIDType
	WhiteSpace	collapse
	Format	an..17
	eTIR name	Code
	Status	R
<i>schemeID</i>	Type	xs:token
	Use	optional
	WhiteSpace	collapse
<i>schemeAgencyID</i>	Type	clm63055:AgencyIdentificationCodeContentType
	Length	1 .. 3
	Use	optional
	WhiteSpace	collapse
TIROperation	Occurrence	1 .. 1
	eTIR name	TIROperation
	Status	R
xs:sequence	Occurrence	1 .. 1
SequenceNumeric	Occurrence	1 .. 1
	Type	ds:TIROperationSequenceNumericType
	Format	n..5
	eTIR name	Sequence number
	Status	R
RegistrationNumberID	Occurrence	1 .. 1
	Type	ds:TIROperationRegistrationNumberIDType
	WhiteSpace	collapse
	eTIR name	Registration number
	Format	an..35
	Status	R
<i>schemeID</i>	Type	xs:token
	Use	optional
	WhiteSpace	collapse
<i>schemeAgencyID</i>	Type	clm63055:AgencyIdentificationCodeContentType
	Length	1 .. 3
	Use	optional
	WhiteSpace	collapse
Termination	Occurrence	1 .. 1
	eTIR name	Termination
	Status	R
xs:sequence	Occurrence	1 .. 1
DateDateTime	Occurrence	1 .. 1
	Type	ds:TerminationDateDateTimeType
	WhiteSpace	collapse
	eTIR name	Date
	Format	n..17
	Status	R
<i>formatCode</i>	Type	clm62379:DateTimePeriodFormatCode
	Length	1 .. 3
	Use	required
	WhiteSpace	collapse
	Name	Date or time or period format code
	Description	Code specifying the representation of a date, time or period.
	Applicable Codes	
	102	CCYYMMDD Calendar date: C = Century ; Y = Year ; M = Month ; D = Day.

	304	CCYYMMDDHHMMSSZZ See 204 plus Z=Time zone.
	602	CCYY Calendar year including century: C = Century; Y = Year.
NumberOfPackagesQuantity	Occurrence	1 .. 1
	Type	ds:TerminationNumberOfPackagesQuantityType
	Format	n..8
	eTIR name	Number of packages
	Status	R
<i>unitCode</i>	Type	clm6Recommendation20: MeasurementUnitCommonCodeContentType
	Length	1 .. 3
	Use	required
	WhiteSpace	collapse
Reservations	Occurrence	0 .. 1
	Type	ds:TerminationReservationsTextType
	eTIR name	Reservations
	Format	an..512
	Status	O
<i>languageID</i>	Type	xs:language
	Use	optional
	Pattern	([a-zA-Z]{2} [il]-[a-zA-Z]+ [xX]-[a-zA-Z]{1,8})-(a-zA-Z){1,8)*
	WhiteSpace	collapse
CustomsOffice	Occurrence	1 .. 1
	eTIR name	CustomsOffice
	Status	R
<i>xs:sequence</i>	Occurrence	1 .. 1
ID	Occurrence	1 .. 1
	Type	ds:CustomsOfficeIdentificationIDType
	WhiteSpace	collapse
	Format	an..17
	eTIR name	Customs office, coded
	Code List	CL13 Customs offices database (to be developed)
	Status	R
<i>schemeID</i>	Type	xs:token
	Use	optional
	WhiteSpace	collapse
<i>schemeAgencyID</i>	Type	clm63055:AgencyIdentificationCodeContentType
	Length	1 .. 3
	Use	optional
	WhiteSpace	collapse
ControlResult	Occurrence	1 .. unbounded
	eTIR name	ControlResult
	Status	R
<i>xs:sequence</i>	Occurrence	1 .. 1
ResultCodeCode	Occurrence	1 .. 1
	Type	ds:ControlResultResultCodeCodeType
	WhiteSpace	collapse
	eTIR name	Code
	Code List	CL24 Control result code
	Format	an..3
	Status	R
<i>listID</i>	Type	xs:token
	Use	optional
	WhiteSpace	collapse
<i>listAgencyID</i>	Type	clm63055:AgencyIdentificationCodeContentType
	Length	1 .. 3
	Use	optional
	WhiteSpace	collapse
ControlType	Occurrence	1 .. 1
	eTIR name	ControlType
	Status	R
<i>xs:sequence</i>	Occurrence	1 .. 1

ID	Occurrence	1 .. 1
	Type	ds:ControlTypeIdentificationCodeType
	WhiteSpace	collapse
	eTIR name	Identification
	Format	an..3
	Code List	CL25 Control type code
	Status	R
<i>listID</i>	Type	xs:token
	Use	optional
	WhiteSpace	collapse
<i>listAgencyID</i>	Type	clm63055:AgencyIdentificationCodeContentType
	Length	1 .. 3
	Use	optional
	WhiteSpace	collapse
Consignment	Occurrence	0 .. unbounded
	Status	O
	Rule	R006
	Rule	R007
	eTIR name	Consignment
xs:sequence	Occurrence	1 .. 1
SequenceNumeric	Occurrence	1 .. 1
	Type	ds:ConsignmentSequenceNumericType
	Format	n..5
	Status	R
	eTIR name	Sequence number
	Status	R
TransportEquipment	Occurrence	1 .. unbounded
	Status	R
	eTIR name	TransportEquipment
xs:sequence	Occurrence	1 .. 1
ID	Occurrence	1 .. 1
	Type	ds:TransportEquipmentIdentificationIDType
	WhiteSpace	collapse
	Format	an..17
	Status	R
	eTIR name	Identification
<i>schemeID</i>	Type	xs:token
	Use	optional
	WhiteSpace	collapse
<i>schemeAgencyID</i>	Type	clm63055:AgencyIdentificationCodeContentType
	Length	1 .. 3
	Use	optional
	WhiteSpace	collapse
Seal	Occurrence	1 .. unbounded
	Status	R
	eTIR name	Seal
xs:sequence	Occurrence	1 .. 1
SequenceNumeric	Occurrence	1 .. 1
	Type	ds:SealSequenceNumericType
	Format	n..5
	Status	R
	Rule	R003
	Rule	R004
	eTIR name	Sequence number
ID	Occurrence	1 .. 1
	Type	ds:SealIdentificationIDType
	WhiteSpace	collapse
	Format	an..35
	Status	R
	Rule	R006
	eTIR name	Seal number
<i>schemeID</i>	Type	xs:token
	Use	optional
	WhiteSpace	collapse

<i>schemaAgencyID</i>	Type Length Use WhiteSpace	clm63055:AgencyIdentificationCodeContentType 1 .. 3 optional collapse
TypeCode	Occurrence Type WhiteSpace Format Status eTIR name Code List	0 .. 1 ds:SealTypeCodeType collapse an..3 O Seal type code CL08 Seal type code
<i>listID</i>	Type Use WhiteSpace	xs:token optional collapse
<i>listAgencyID</i>	Type Length Use WhiteSpace	clm63055:AgencyIdentificationCodeContentType 1 .. 3 optional collapse
TransitPrincipal	Occurrence eTIR name Status	1 .. 1 Holder R
xs:sequence	Occurrence	1 .. 1
ID	Occurrence Type WhiteSpace Format eTIR name Code List Status	1 .. 1 ds:TransitPrincipalIdentificationIDType collapse an..17 Code CL15 International TIR database R
<i>schemeID</i>	Type Use WhiteSpace	xs:token optional collapse
<i>schemaAgencyID</i>	Type Length Use WhiteSpace	clm63055:AgencyIdentificationCodeContentType 1 .. 3 optional collapse

4.2.3.1.2.12. I12 – Termination results

a. Structure

Occurance	Element/Attribute
1 .. 1	Message
1 .. 1	xs:sequence
optional	TypeCode
optional	<i>listID</i>
optional	<i>listAgencyID</i>
1 .. 1	ReferenceNumberID
optional	<i>schemeID</i>
optional	<i>schemaAgencyID</i>
1 .. 1	FunctionCode
optional	<i>listID</i>
optional	<i>listAgencyID</i>
1 .. 1	FunctionalReferenceID
optional	<i>schemeID</i>
optional	<i>schemaAgencyID</i>
1 .. 1	Guarantee
1 .. 1	xs:sequence
1 .. 1	ReferenceID
optional	<i>schemeID</i>
optional	<i>schemaAgencyID</i>
1 .. 1	SecurityDetailsCode

optional	<i>listID</i>
optional	<i>listAgencyID</i>
1 .. 1	GuaranteeStatusCode
optional	<i>listID</i>
optional	<i>listAgencyID</i>
1 .. 1	Surety
1 .. 1	xs:sequence
1 .. 1	ID
optional	<i>schemeID</i>
optional	<i>schemeAgencyID</i>
1 .. 1	TIROperation
1 .. 1	xs:sequence
1 .. 1	SequenceNumeric
1 .. 1	RegistrationNumberID
optional	<i>schemeID</i>
optional	<i>schemeAgencyID</i>
1 .. 1	Termination
1 .. 1	xs:sequence
1 .. 1	DateDateTime
required	<i>formatCode</i>
1 .. 1	TransitPrincipal
1 .. 1	xs:sequence
1 .. 1	ID
optional	<i>schemeID</i>
optional	<i>schemeAgencyID</i>
1 .. 1	CurrentStatusCode
optional	<i>listID</i>
optional	<i>listAgencyID</i>
0 .. 1	ActiveWithdrawal
1 .. 1	xs:sequence
1 .. 1	StartDateTime
required	<i>formatCode</i>
0 .. 1	EndDateTime
required	<i>formatCode</i>
0 .. unbounded	ActiveExclusion
1 .. 1	xs:sequence
1 .. 1	StartDateTime
required	<i>formatCode</i>
0 .. 1	EndDateTime
required	<i>formatCode</i>
1 .. 1	CountryCode
optional	<i>listID</i>
optional	<i>listAgencyID</i>
0 .. unbounded	Error
1 .. 1	xs:sequence
1 .. 1	ValidationCode
optional	<i>listID</i>
optional	<i>listAgencyID</i>
1 .. unbounded	Pointer
1 .. 1	xs:sequence
1 .. 1	SequenceNumeric
1 .. 1	DocumentSectionCode
optional	<i>listID</i>
optional	<i>listAgencyID</i>
1 .. 1	TagID
optional	<i>schemeID</i>
optional	<i>schemeAgencyID</i>

b. Guidelines

Element/Attribute	Annotation
Message	eTIR name Message Occurrence 1 .. 1
xs:sequence	
TypeCode	Occurrence 1 .. 1 Type ds:MessageTypeCodeType WhiteSpace collapse Format an..3 eTIR name Type, coded Status R Code List CL26 Message types Restricted code(s) I12 Termination results
<i>listID</i>	Type xs:token Use optional WhiteSpace collapse
<i>listAgencyID</i>	Type clm63055:AgencyIdentificationCodeContentType Length 1 .. 3 Use optional WhiteSpace collapse
ReferenceNumberID	Occurrence 1 .. 1 Type ds:MessageReferenceNumberIDType WhiteSpace collapse Format an..14 eTIR name Message reference number Status R
<i>schemeID</i>	Type xs:token Use optional WhiteSpace collapse
<i>schemeAgencyID</i>	Type clm63055:AgencyIdentificationCodeContentType Length 1 .. 3 Use optional WhiteSpace collapse
FunctionCode	Occurrence 1 .. 1 Type ds:MessageFunctionCodeType WhiteSpace collapse Format n..2 eTIR name Message function, coded Code List CL16 Message function code Status R Restricted code(s) 27 Not accepted Restricted code(s) 44 Accepted without reserves
<i>listID</i>	Type xs:token Use optional WhiteSpace collapse
<i>listAgencyID</i>	Type clm63055:AgencyIdentificationCodeContentType Length 1 .. 3 Use optional WhiteSpace collapse
FunctionalReferenceID	Occurrence 1 .. 1 Type ds:MessageFunctionalReferenceIDType WhiteSpace collapse Format an..35 eTIR name Functional reference Status R
<i>schemeID</i>	Type xs:token Use optional WhiteSpace collapse

<ul style="list-style-type: none"> └─ <i>schemaAgencyID</i> 	<p>Type clm63055:AgencyIdentificationCodeContentType Length 1 .. 3 Use optional WhiteSpace collapse</p>
<ul style="list-style-type: none"> └─ Guarantee 	<p>Occurrence 1 .. 1 eTIR name Guarantee Status R</p>
<ul style="list-style-type: none"> └─ xs:sequence <ul style="list-style-type: none"> └─ ReferenceID 	<p>Occurrence 1 .. 1 Occurrence 1 .. 1 Type ds:GuaranteeReferenceIDType WhiteSpace collapse Format an..35 eTIR name Reference Status R</p>
<ul style="list-style-type: none"> └─ <i>schemeID</i> 	<p>Type xs:token Use optional WhiteSpace collapse</p>
<ul style="list-style-type: none"> └─ <i>schemaAgencyID</i> 	<p>Type clm63055:AgencyIdentificationCodeContentType Length 1 .. 3 Use optional WhiteSpace collapse</p>
<ul style="list-style-type: none"> └─ SecurityDetailsCode 	<p>Occurrence 1 .. 1 Type ds:GuaranteeSecurityDetailsCodeType WhiteSpace collapse Format an..3 eTIR name Guarantee type Code List CL12 Guarantee type code Status R</p>
<ul style="list-style-type: none"> └─ <i>listID</i> 	<p>Type xs:token Use optional WhiteSpace collapse</p>
<ul style="list-style-type: none"> └─ <i>listAgencyID</i> 	<p>Type clm63055:AgencyIdentificationCodeContentType Length 1 .. 3 Use optional WhiteSpace collapse</p>
<ul style="list-style-type: none"> └─ GuaranteeStatusCode 	<p>Occurrence 1 .. 1 Type ds:GuaranteeGuaranteeStatusCodeType WhiteSpace collapse Format an..3 Code List CL22 Guarantee status eTIR name Guarantee status Status R</p>
<ul style="list-style-type: none"> └─ <i>listID</i> 	<p>Type xs:token Use optional WhiteSpace collapse</p>
<ul style="list-style-type: none"> └─ <i>listAgencyID</i> 	<p>Type clm63055:AgencyIdentificationCodeContentType Length 1 .. 3 Use optional WhiteSpace collapse</p>
<ul style="list-style-type: none"> └─ Surety 	<p>Occurrence 1 .. 1 eTIR name GuaranteeChain Status R</p>
<ul style="list-style-type: none"> └─ xs:sequence <ul style="list-style-type: none"> └─ ID 	<p>Occurrence 1 .. 1 Occurrence 1 .. 1 Type ds:SuretyIdentificationIDType WhiteSpace collapse Format an..17 eTIR name Code Status R</p>
<ul style="list-style-type: none"> └─ <i>schemeID</i> 	<p>Type xs:token Use optional WhiteSpace collapse</p>

<ul style="list-style-type: none"> └─ <i>schemeAgencyID</i> 	<p>Type ctm63055:AgencyIdentificationCodeContentType Length 1 .. 3 Use optional WhiteSpace collapse</p>
<ul style="list-style-type: none"> └─ TIROperation 	<p>Occurrence 1 .. 1 eTIR name TIROperation Status R</p>
<ul style="list-style-type: none"> └─ xs:sequence <ul style="list-style-type: none"> └─ SequenceNumeric 	<p>Occurrence 1 .. 1 Occurrence 1 .. 1 Type ds:TIROperationSequenceNumericType Format n..5 eTIR name Sequence number Status R</p>
<ul style="list-style-type: none"> └─ RegistrationNumberID 	<p>Occurrence 1 .. 1 Type ds:TIROperationRegistrationNumberIDType WhiteSpace collapse eTIR name Registration number Format an..35 Status R</p>
<ul style="list-style-type: none"> └─ <i>schemeID</i> 	<p>Type xs:token Use optional WhiteSpace collapse</p>
<ul style="list-style-type: none"> └─ <i>schemeAgencyID</i> 	<p>Type ctm63055:AgencyIdentificationCodeContentType Length 1 .. 3 Use optional WhiteSpace collapse</p>
<ul style="list-style-type: none"> └─ Termination 	<p>Occurrence 1 .. 1 eTIR name Termination Status R</p>
<ul style="list-style-type: none"> └─ xs:sequence <ul style="list-style-type: none"> └─ DateDateTime 	<p>Occurrence 1 .. 1 Occurrence 1 .. 1 Type ds:TerminationDateDateTimeType WhiteSpace collapse eTIR name Date Format n..17 Status R</p>
<ul style="list-style-type: none"> └─ <i>formatCode</i> 	<p>Type ctm62379:DateTimePeriodFormatCode Length 1 .. 3 Use required WhiteSpace collapse Name Date or time or period format code Description Code specifying the representation of a date, time or period.</p> <p>Applicable Codes</p> <p>102 CCYYMMDD Calendar date: C = Century ; Y = Year ; M = Month ; D = Day.</p> <p>304 CCYYMMDDHHMMSSZZ See 204 plus Z=Time zone.</p> <p>602 CCYY Calendar year including century: C = Century; Y = Year.</p>
<ul style="list-style-type: none"> └─ TransitPrincipal 	<p>Occurrence 1 .. 1 eTIR name Holder Status R</p>
<ul style="list-style-type: none"> └─ xs:sequence <ul style="list-style-type: none"> └─ ID 	<p>Occurrence 1 .. 1 Occurrence 1 .. 1 Type ds:TransitPrincipalIdentificationIDType WhiteSpace collapse Format an..17 eTIR name Code Code List CL15 International TIR database Status R</p>
<ul style="list-style-type: none"> └─ <i>schemeID</i> 	<p>Type xs:token Use optional WhiteSpace collapse</p>

<ul style="list-style-type: none"> └─ <i>schemeAgencyID</i> 	Type clm63055:AgencyIdentificationCodeContentType Length 1 .. 3 Use optional WhiteSpace collapse
<ul style="list-style-type: none"> └─ CurrentStatusCode 	Occurrence 1 .. 1 Type ds:TransitPrincipalCurrentStatusCodeType WhiteSpace collapse Code List CL23 Holder status eTIR name Current status Format an..3 Status R
<ul style="list-style-type: none"> └─ <i>listID</i> 	Type xs:token Use optional WhiteSpace collapse
<ul style="list-style-type: none"> └─ <i>listAgencyID</i> 	Type clm63055:AgencyIdentificationCodeContentType Length 1 .. 3 Use optional WhiteSpace collapse
<ul style="list-style-type: none"> └─ ActiveWithdrawal 	Occurrence 0 .. 1 eTIR name ActiveWithdrawal Status O
<ul style="list-style-type: none"> └─ xs:sequence └─ StartDateTime 	Occurrence 1 .. 1 Occurrence 1 .. 1 Type ds:ActiveWithdrawalStartDateTimeType WhiteSpace collapse eTIR name Start Format n..17 Status R
<ul style="list-style-type: none"> └─ <i>formatCode</i> 	Type clm62379:DateTimePeriodFormatCode Length 1 .. 3 Use required WhiteSpace collapse Name Date or time or period format code Description Code specifying the representation of a date, time or period. Applicable Codes 102 CCYYMMDD Calendar date: C = Century ; Y = Year ; M = Month ; D = Day. 304 CCYYMMDDHHMMSSZZ See 204 plus Z=Time zone. 602 CCYY Calendar year including century: C = Century; Y = Year.
<ul style="list-style-type: none"> └─ EndDateTime 	Occurrence 0 .. 1 Type ds:ActiveWithdrawalEndDateTimeType WhiteSpace collapse eTIR name End Format n..17 Status O
<ul style="list-style-type: none"> └─ <i>formatCode</i> 	Type clm62379:DateTimePeriodFormatCode Length 1 .. 3 Use required WhiteSpace collapse Name Date or time or period format code Description Code specifying the representation of a date, time or period. Applicable Codes 102 CCYYMMDD Calendar date: C = Century ; Y = Year ; M = Month ; D = Day. 304 CCYYMMDDHHMMSSZZ See 204 plus Z=Time zone. 602 CCYY Calendar year including century: C = Century; Y = Year.
<ul style="list-style-type: none"> └─ ActiveExclusion 	Occurrence 0 .. unbounded eTIR name ActiveExclusion

xs:sequence	Status	O
StartDateTime	Occurrence	1 .. 1
	Type	ds:ActiveExclusionStartDateTimeType
	WhiteSpace	collapse
	eTIR name	Start
	Format	n..17
	Status	R
<i>formatCode</i>	Type	clm62379:DateTimePeriodFormatCode
	Length	1 .. 3
	Use	required
	WhiteSpace	collapse
	Name	Date or time or period format code
	Description	Code specifying the representation of a date, time or period.
	Applicable Codes	
	102	CCYYMMDD Calendar date: C = Century ; Y = Year ; M = Month ; D = Day.
	304	CCYYMMDDHHMMSSZZ See 204 plus Z=Time zone.
	602	CCYY Calendar year including century: C = Century; Y = Year.
EndTime	Occurrence	0 .. 1
	Type	ds:ActiveExclusionEndTimeType
	WhiteSpace	collapse
	eTIR name	End
	Format	n..17
	Status	O
<i>formatCode</i>	Type	clm62379:DateTimePeriodFormatCode
	Length	1 .. 3
	Use	required
	WhiteSpace	collapse
	Name	Date or time or period format code
	Description	Code specifying the representation of a date, time or period.
	Applicable Codes	
	102	CCYYMMDD Calendar date: C = Century ; Y = Year ; M = Month ; D = Day.
	304	CCYYMMDDHHMMSSZZ See 204 plus Z=Time zone.
	602	CCYY Calendar year including century: C = Century; Y = Year.
CountryCode	Occurrence	1 .. 1
	Type	ds:ActiveExclusionCountryCodeType
	WhiteSpace	collapse
	Code List	CL04 Country name code
	eTIR name	Country, coded
	Format	a2
	Status	R
<i>listID</i>	Type	xs:token
	Use	optional
	WhiteSpace	collapse
<i>listAgencyID</i>	Type	clm63055:AgencyIdentificationCodeContentType
	Length	1 .. 3
	Use	optional
	WhiteSpace	collapse
Error	Occurrence	0 .. unbounded
	eTIR name	Error
	Status	D
	Condition	C006
xs:sequence	Occurrence	1 .. 1
ValidationCode	Occurrence	1 .. 1
	Type	ds:ErrorValidationCodeType
	WhiteSpace	collapse

	Format	an..8
	eTIR name	Error, coded
	Code List	CL99 Error code (to be developed)
	Status	R
<i>listID</i>	Type	xs:token
	Use	optional
	WhiteSpace	collapse
<i>listAgencyID</i>	Type	clm63055:AgencyIdentificationCodeContentType
	Length	1 .. 3
	Use	optional
	WhiteSpace	collapse
Pointer	Occurrence	1 .. unbounded
	eTIR name	Pointer
	Status	R
<i>xs:sequence</i>	Occurrence	1 .. 1
SequenceNumeric	Occurrence	1 .. 1
	Type	ds:PointerSequenceNumericType
	Format	n..5
	eTIR name	Sequence number
	Status	R
DocumentSectionCode	Occurrence	1 .. 1
	Type	ds:PointerDocumentSectionCodeType
	WhiteSpace	collapse
	Format	an..3
	eTIR name	Document/message section, coded
	Code List	CL18 Message section code (codes to be defined)
	Status	R
<i>listID</i>	Type	xs:token
	Use	optional
	WhiteSpace	collapse
<i>listAgencyID</i>	Type	clm63055:AgencyIdentificationCodeContentType
	Length	1 .. 3
	Use	optional
	WhiteSpace	collapse
TagID	Occurrence	1 .. 1
	Type	ds:PointerTagIDType
	WhiteSpace	collapse
	Format	an..4
	eTIR name	Tag identifier
	Code List	CL19 Pointer code (codes to be defined)
	Status	R
<i>schemeID</i>	Type	xs:token
	Use	optional
	WhiteSpace	collapse
<i>schemeAgencyID</i>	Type	clm63055:AgencyIdentificationCodeContentType
	Length	1 .. 3
	Use	optional
	WhiteSpace	collapse

4.2.3.1.2.13. I13 – Discharge TIR operation

a. Structure

Occurance	Element/Attribute
1 .. 1	Message
1 .. 1	<i>xs:sequence</i>
optional	TypeCode
optional	<i>listID</i>
1 .. 1	<i>listAgencyID</i>
optional	ReferenceNumberID
optional	<i>schemeID</i>
optional	<i>schemeAgencyID</i>

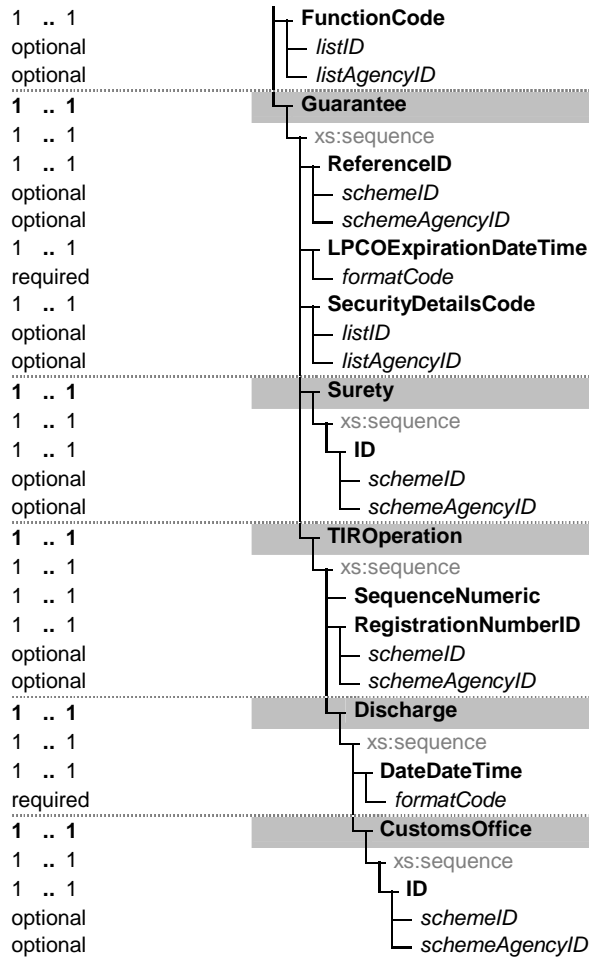

b. Guidelines

Element/Attribute	Annotation
Message	eTIR name Message
<i>xs:sequence</i>	Occurrence 1 .. 1
TypeCode	Occurrence 1 .. 1
	Type ds:MessageTypeCodeType
	WhiteSpace collapse
	Format an..3
	eTIR name Type, coded
	Status R
	Code List CL26 Message types
	Restricted code(s) I13 Discharge TIR operation
<i>listID</i>	Type xs:token
	Use optional
	WhiteSpace collapse
<i>listAgencyID</i>	Type cim63055:AgencyIdentificationCodeContentType
	Length 1 .. 3
	Use optional
	WhiteSpace collapse
ReferenceNumberID	Occurrence 1 .. 1
	Type ds:MessageReferenceNumberIDType
	WhiteSpace collapse
	Format an..14

	eTIR name	Message reference number
	Status	R
<i>schemeID</i>	Type	xs:token
	Use	optional
	WhiteSpace	collapse
<i>schemeAgencyID</i>	Type	clm63055:AgencyIdentificationCodeContentType
	Length	1 .. 3
	Use	optional
	WhiteSpace	collapse
FunctionCode	Occurrence	1 .. 1
	Type	ds:MessageFunctionCodeType
	WhiteSpace	collapse
	Format	n..2
	eTIR name	Message function, coded
	Code List	CL16 Message function code
	Status	R
	Restricted code(s)	9 Original
<i>listID</i>	Type	xs:token
	Use	optional
	WhiteSpace	collapse
<i>listAgencyID</i>	Type	clm63055:AgencyIdentificationCodeContentType
	Length	1 .. 3
	Use	optional
	WhiteSpace	collapse
Guarantee	Occurrence	1 .. 1
	eTIR name	Guarantee
	Status	R
xs:sequence	Occurrence	1 .. 1
ReferenceID	Occurrence	1 .. 1
	Type	ds:GuaranteeReferenceIDType
	WhiteSpace	collapse
	Format	an..35
	eTIR name	Reference
	Status	R
<i>schemeID</i>	Type	xs:token
	Use	optional
	WhiteSpace	collapse
<i>schemeAgencyID</i>	Type	clm63055:AgencyIdentificationCodeContentType
	Length	1 .. 3
	Use	optional
	WhiteSpace	collapse
LPCOExpirationDateTime	Occurrence	1 .. 1
	Type	ds:GuaranteeLPCOExpirationDateTimeType
	WhiteSpace	collapse
	Format	n8
	eTIR name	Validity
	Status	R
<i>formatCode</i>	Type	clm62379:DateTimePeriodFormatCode
	Length	1 .. 3
	Use	required
	WhiteSpace	collapse
	Name	Date or time or period format code
	Description	Code specifying the representation of a date, time or period.
	Applicable Codes	
	102	CCYYMMDD Calendar date: C = Century ; Y = Year ; M = Month ; D = Day.
	304	CCYYMMDDHHMMSSZZ See 204 plus Z=Time zone.
	602	CCYY Calendar year including century: C = Century; Y = Year.
SecurityDetailsCode	Occurrence	1 .. 1
	Type	ds:GuaranteeSecurityDetailsCodeType
	WhiteSpace	collapse

	Format	an..3
	eTIR name	Guarantee type
	Code List	CL12 Guarantee type code
	Status	R
<i>listID</i>	Type	xs:token
	Use	optional
	WhiteSpace	collapse
<i>listAgencyID</i>	Type	clm63055:AgencyIdentificationCodeContentType
	Length	1 .. 3
	Use	optional
	WhiteSpace	collapse
Surety	Occurrence	1 .. 1
	eTIR name	GuaranteeChain
	Status	R
<i>xs:sequence</i>	Occurrence	1 .. 1
ID	Occurrence	1 .. 1
	Type	ds:SuretyIdentificationIDType
	WhiteSpace	collapse
	Format	an..17
	eTIR name	Code
	Status	R
<i>schemeID</i>	Type	xs:token
	Use	optional
	WhiteSpace	collapse
<i>schemeAgencyID</i>	Type	clm63055:AgencyIdentificationCodeContentType
	Length	1 .. 3
	Use	optional
	WhiteSpace	collapse
TIROperation	Occurrence	1 .. 1
	eTIR name	TIROperation
	Status	R
<i>xs:sequence</i>	Occurrence	1 .. 1
SequenceNumeric	Occurrence	1 .. 1
	Type	ds:TIROperationSequenceNumericType
	Format	n..5
	eTIR name	Sequence number
	Status	R
RegistrationNumberID	Occurrence	1 .. 1
	Type	ds:TIROperationRegistrationNumberIDType
	WhiteSpace	collapse
	eTIR name	Registration number
	Format	an..35
	Status	R
<i>schemeID</i>	Type	xs:token
	Use	optional
	WhiteSpace	collapse
<i>schemeAgencyID</i>	Type	clm63055:AgencyIdentificationCodeContentType
	Length	1 .. 3
	Use	optional
	WhiteSpace	collapse
Discharge	Occurrence	1 .. 1
	eTIR name	Discharge
	Status	R
<i>xs:sequence</i>	Occurrence	1 .. 1
DateDateTime	Occurrence	1 .. 1
	Type	ds:DischargeDateDateTimeType
	WhiteSpace	collapse
	eTIR name	Date
	Format	n..17
	Status	R
<i>formatCode</i>	Type	clm62379:DatePeriodFormatCode
	Length	1 .. 3
	Use	required
	WhiteSpace	collapse
	Name	Date or time or period format code

<pre> CustomsOffice ├── xs:sequence │ └── ID ├── schemeID └── schemeAgencyID </pre>	<p>Description Code specifying the representation of a date, time or period.</p> <p>Applicable Codes</p> <p>102 CCYYMMDD Calendar date: C = Century ; Y = Year ; M = Month ; D = Day.</p> <p>304 CCYYMMDDHHMMSSZZZ See 204 plus Z=Time zone.</p> <p>602 CCYY Calendar year including century: C = Century; Y = Year.</p> <p>Occurrence 1 .. 1</p> <p>eTIR name CustomsOffice</p> <p>Status R</p> <p>Occurrence 1 .. 1</p> <p>Occurrence 1 .. 1</p> <p>Type ds:CustomsOfficeIdentificationIDType</p> <p>WhiteSpace collapse</p> <p>Format an..17</p> <p>eTIR name Customs office, coded</p> <p>Code List CL13 Customs offices database (to be developed)</p> <p>Status R</p> <p>Type xs:token</p> <p>Use optional</p> <p>WhiteSpace collapse</p> <p>Type clm63055:AgencyIdentificationCodeContentType</p> <p>Length 1 .. 3</p> <p>Use optional</p> <p>WhiteSpace collapse</p>
---	---

4.2.3.1.2.14. I14 – Discharge results

a. Structure

Occurance	Element/Attribute
1 .. 1	Message
1 .. 1	xs:sequence
optional	TypeCode
optional	<i>listID</i>
optional	<i>listAgencyID</i>
1 .. 1	ReferenceNumberID
optional	<i>schemeID</i>
optional	<i>schemeAgencyID</i>
1 .. 1	FunctionCode
optional	<i>listID</i>
optional	<i>listAgencyID</i>
1 .. 1	FunctionalReferenceID
optional	<i>schemeID</i>
optional	<i>schemeAgencyID</i>
1 .. 1	Guarantee
1 .. 1	xs:sequence
1 .. 1	ReferenceID
optional	<i>schemeID</i>
optional	<i>schemeAgencyID</i>
1 .. 1	SecurityDetailsCode
optional	<i>listID</i>
optional	<i>listAgencyID</i>
1 .. 1	GuaranteeStatusCode
optional	<i>listID</i>
optional	<i>listAgencyID</i>
1 .. 1	Surety

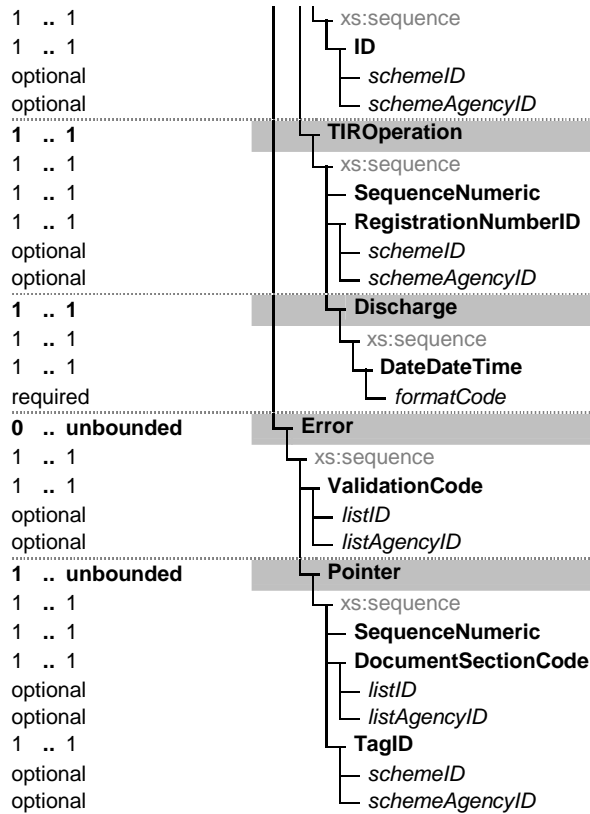

b. Guidelines

Element/Attribute	Annotation
Message	eTIR name Message
xs:sequence	Occurrence 1 .. 1
TypeCode	Occurrence 1 .. 1
	Type ds:MessageTypeCodeType
	WhiteSpace collapse
	Format an..3
	eTIR name Type, coded
	Status R
	Code List CL26 Message types
	Restricted code(s) I14 Discharge results
<i>listID</i>	Type xs:token
	Use optional
	WhiteSpace collapse
<i>listAgencyID</i>	Type ctm63055:AgencyIdentificationCodeContentType
	Length 1 .. 3
	Use optional
	WhiteSpace collapse
ReferenceNumberID	Occurrence 1 .. 1
	Type ds:MessageReferenceNumberIDType
	WhiteSpace collapse
	Format an..14
	eTIR name Message reference number
	Status R
<i>schemeID</i>	Type xs:token
	Use optional
	WhiteSpace collapse

— <i>schemaAgencyID</i>	Type	clm63055:AgencyIdentificationCodeContentType
	Length	1 .. 3
	Use	optional
	WhiteSpace	collapse
FunctionCode	Occurrence	1 .. 1
	Type	ds:MessageFunctionCodeType
	WhiteSpace	collapse
	Format	n..2
	eTIR name	Message function, coded
	Code List	CL16 Message function code
	Status	R
	Restricted code(s)	27 Not accepted
	Restricted code(s)	44 Accepted without reserves
— <i>listID</i>	Type	xs:token
	Use	optional
	WhiteSpace	collapse
— <i>listAgencyID</i>	Type	clm63055:AgencyIdentificationCodeContentType
	Length	1 .. 3
	Use	optional
	WhiteSpace	collapse
FunctionalReferenceID	Occurrence	1 .. 1
	Type	ds:MessageFunctionalReferenceIDType
	WhiteSpace	collapse
	Format	an..35
	eTIR name	Functional reference
	Status	R
— <i>schemaID</i>	Type	xs:token
	Use	optional
	WhiteSpace	collapse
— <i>schemaAgencyID</i>	Type	clm63055:AgencyIdentificationCodeContentType
	Length	1 .. 3
	Use	optional
	WhiteSpace	collapse
Guarantee	Occurrence	1 .. 1
	eTIR name	Guarantee
	Status	R
— <i>xs:sequence</i>	Occurrence	1 .. 1
— ReferenceID	Occurrence	1 .. 1
	Type	ds:GuaranteeReferenceIDType
	WhiteSpace	collapse
	Format	an..35
	eTIR name	Reference
	Status	R
— <i>schemaID</i>	Type	xs:token
	Use	optional
	WhiteSpace	collapse
— <i>schemaAgencyID</i>	Type	clm63055:AgencyIdentificationCodeContentType
	Length	1 .. 3
	Use	optional
	WhiteSpace	collapse
SecurityDetailsCode	Occurrence	1 .. 1
	Type	ds:GuaranteeSecurityDetailsCodeType
	WhiteSpace	collapse
	Format	an..3
	eTIR name	Guarantee type
	Code List	CL12 Guarantee type code
	Status	R
— <i>listID</i>	Type	xs:token
	Use	optional
	WhiteSpace	collapse

<i>listAgencyID</i>	Type	clm63055:AgencyIdentificationCodeContentType
	Length	1 .. 3
	Use	optional
	WhiteSpace	collapse
GuaranteeStatusCode	Occurrence	1 .. 1
	Type	ds:GuaranteeGuaranteeStatusCodeType
	WhiteSpace	collapse
	Format	an..3
	Code List	CL22 Guarantee status
	eTIR name	Guarantee status
	Status	R
<i>listID</i>	Type	xs:token
	Use	optional
	WhiteSpace	collapse
<i>listAgencyID</i>	Type	clm63055:AgencyIdentificationCodeContentType
	Length	1 .. 3
	Use	optional
	WhiteSpace	collapse
Surety	Occurrence	1 .. 1
	eTIR name	GuaranteeChain
	Status	R
xs:sequence	Occurrence	1 .. 1
ID	Occurrence	1 .. 1
	Type	ds:SuretyIdentificationIDType
	WhiteSpace	collapse
	Format	an..17
	eTIR name	Code
	Status	R
<i>schemeID</i>	Type	xs:token
	Use	optional
	WhiteSpace	collapse
<i>schemeAgencyID</i>	Type	clm63055:AgencyIdentificationCodeContentType
	Length	1 .. 3
	Use	optional
	WhiteSpace	collapse
TIROperation	Occurrence	1 .. 1
	eTIR name	TIROperation
	Status	R
xs:sequence	Occurrence	1 .. 1
SequenceNumeric	Occurrence	1 .. 1
	Type	ds:TIROperationSequenceNumericType
	Format	n..5
	eTIR name	Sequence number
	Status	R
RegistrationNumberID	Occurrence	1 .. 1
	Type	ds:TIROperationRegistrationNumberIDType
	WhiteSpace	collapse
	eTIR name	Registration number
	Format	an..35
	Status	R
<i>schemeID</i>	Type	xs:token
	Use	optional
	WhiteSpace	collapse
<i>schemeAgencyID</i>	Type	clm63055:AgencyIdentificationCodeContentType
	Length	1 .. 3
	Use	optional
	WhiteSpace	collapse
Discharge	Occurrence	1 .. 1
	eTIR name	Discharge
	Status	R
xs:sequence	Occurrence	1 .. 1
DateDateTime	Occurrence	1 .. 1
	Type	ds:DischargeDateDateTimeType
	WhiteSpace	collapse
	eTIR name	Date

	formatCode	Format n..17 Status R Type clm62379:DateTimePeriodFormatCode Length 1 .. 3 Use required WhiteSpace collapse Name Date or time or period format code Description Code specifying the representation of a date, time or period. Applicable Codes 102 CCYYMMDD Calendar date: C = Century ; Y = Year ; M = Month ; D = Day. 304 CCYYMMDDHHMMSSZZ See 204 plus Z=Time zone. 602 CCYY Calendar year including century: C = Century; Y = Year.
	Error	Occurrence 0 .. unbounded eTIR name Error Status D Condition C006
	xs:sequence	
	ValidationCode	Occurrence 1 .. 1 Type ds:ErrorValidationCodeType WhiteSpace collapse Format an..8 eTIR name Error, coded Code List CL99 Error code (to be developed) Status R
	<i>listID</i>	Type xs:token Use optional WhiteSpace collapse
	<i>listAgencyID</i>	Type clm63055:AgencyIdentificationCodeContentType Length 1 .. 3 Use optional WhiteSpace collapse
	Pointer	Occurrence 1 .. unbounded eTIR name Pointer Status R
	xs:sequence	
	SequenceNumeric	Occurrence 1 .. 1 Type ds:PointerSequenceNumericType Format n..5 eTIR name Sequence number Status R
	DocumentSectionCode	Occurrence 1 .. 1 Type ds:PointerDocumentSectionCodeType WhiteSpace collapse Format an..3 eTIR name Document/message section, coded Code List CL18 Message section code (codes to be defined) Status R
	<i>listID</i>	Type xs:token Use optional WhiteSpace collapse
	<i>listAgencyID</i>	Type clm63055:AgencyIdentificationCodeContentType Length 1 .. 3 Use optional WhiteSpace collapse
	TagID	Occurrence 1 .. 1 Type ds:PointerTagIDType WhiteSpace collapse Format an..4 eTIR name Tag identifier Code List CL19 Pointer code (codes to be defined)

<ul style="list-style-type: none"> — <i>schemeID</i> — <i>schemeAgencyID</i> 	Status	R
	Type	xs:token
	Use	optional
	WhiteSpace	collapse
	Type	clm63055:AgencyIdentificationCodeContentType
	Length	1 .. 3
	Use	optional
	WhiteSpace	collapse

4.2.3.1.2.15. I15 – Notify Customs

a. Structure

Occurance	Element/Attribute
	Message
1 .. 1	xs:sequence
1 .. 1	TypeCode
optional	— <i>listID</i>
optional	— <i>listAgencyID</i>
1 .. 1	ReferenceNumberID
optional	— <i>schemeID</i>
optional	— <i>schemeAgencyID</i>
1 .. 1	FunctionCode
optional	— <i>listID</i>
optional	— <i>listAgencyID</i>
1 .. 1	Guarantee
1 .. 1	xs:sequence
1 .. 1	ReferenceID
optional	— <i>schemeID</i>
optional	— <i>schemeAgencyID</i>
1 .. 1	LPCOExpirationDateTime
required	— <i>formatCode</i>
1 .. 1	SecurityDetailsCode
optional	— <i>listID</i>
optional	— <i>listAgencyID</i>
1 .. 1	GuaranteeStatusCode
optional	— <i>listID</i>
optional	— <i>listAgencyID</i>
1 .. 1	Surety
1 .. 1	xs:sequence
1 .. 1	ID
optional	— <i>schemeID</i>
optional	— <i>schemeAgencyID</i>
0 .. unbounded	TIROperation
1 .. 1	xs:sequence
1 .. 1	SequenceNumeric
1 .. 1	RegistrationNumberID
optional	— <i>schemeID</i>
optional	— <i>schemeAgencyID</i>
0 .. 1	Start
1 .. 1	xs:sequence
1 .. 1	DateDateTime
required	— <i>formatCode</i>
0 .. 1	TimeLimitDateTime
required	— <i>formatCode</i>
0 .. 1	Remarks
optional	— <i>languageID</i>
1 .. 1	CustomsOffice
1 .. 1	xs:sequence

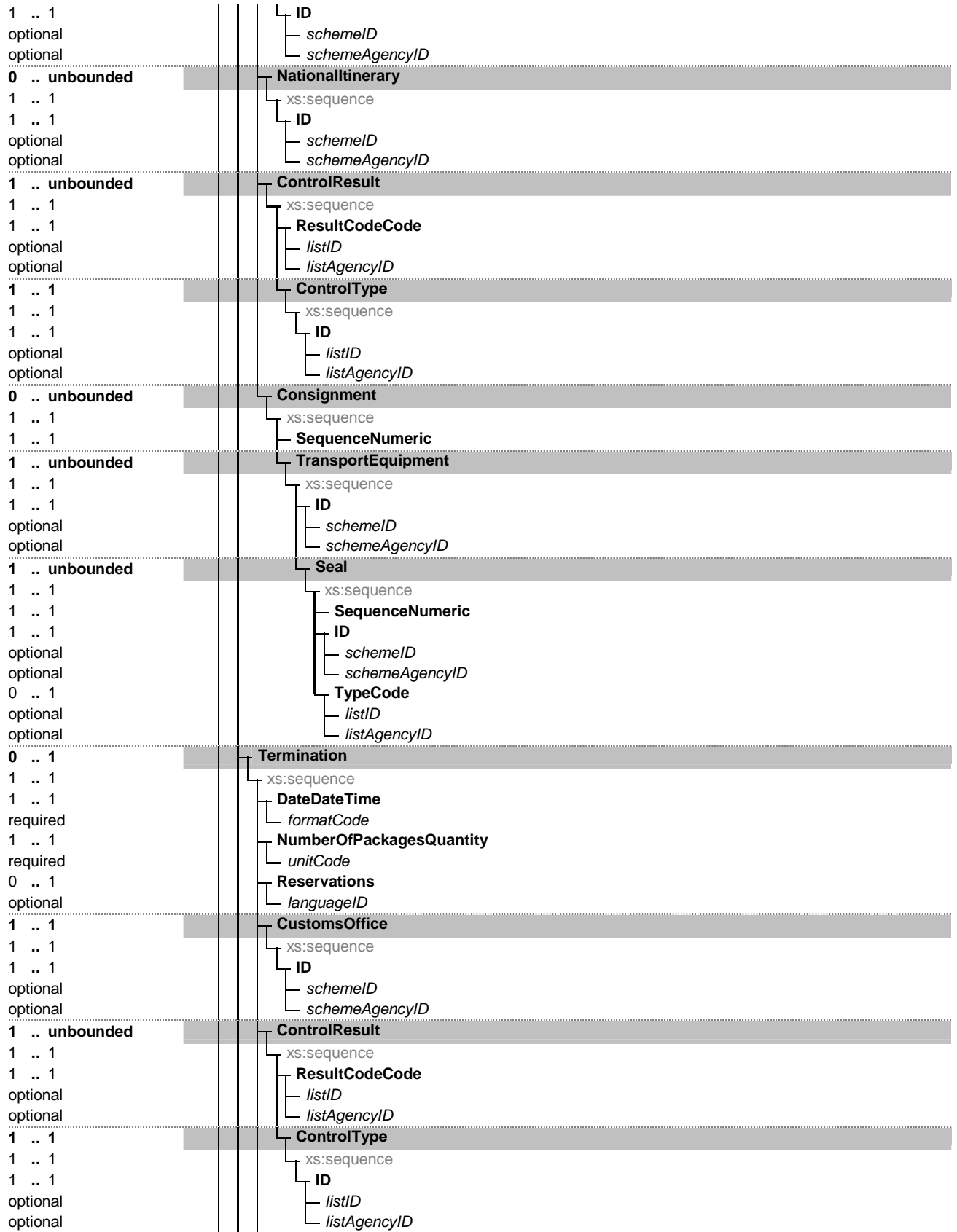

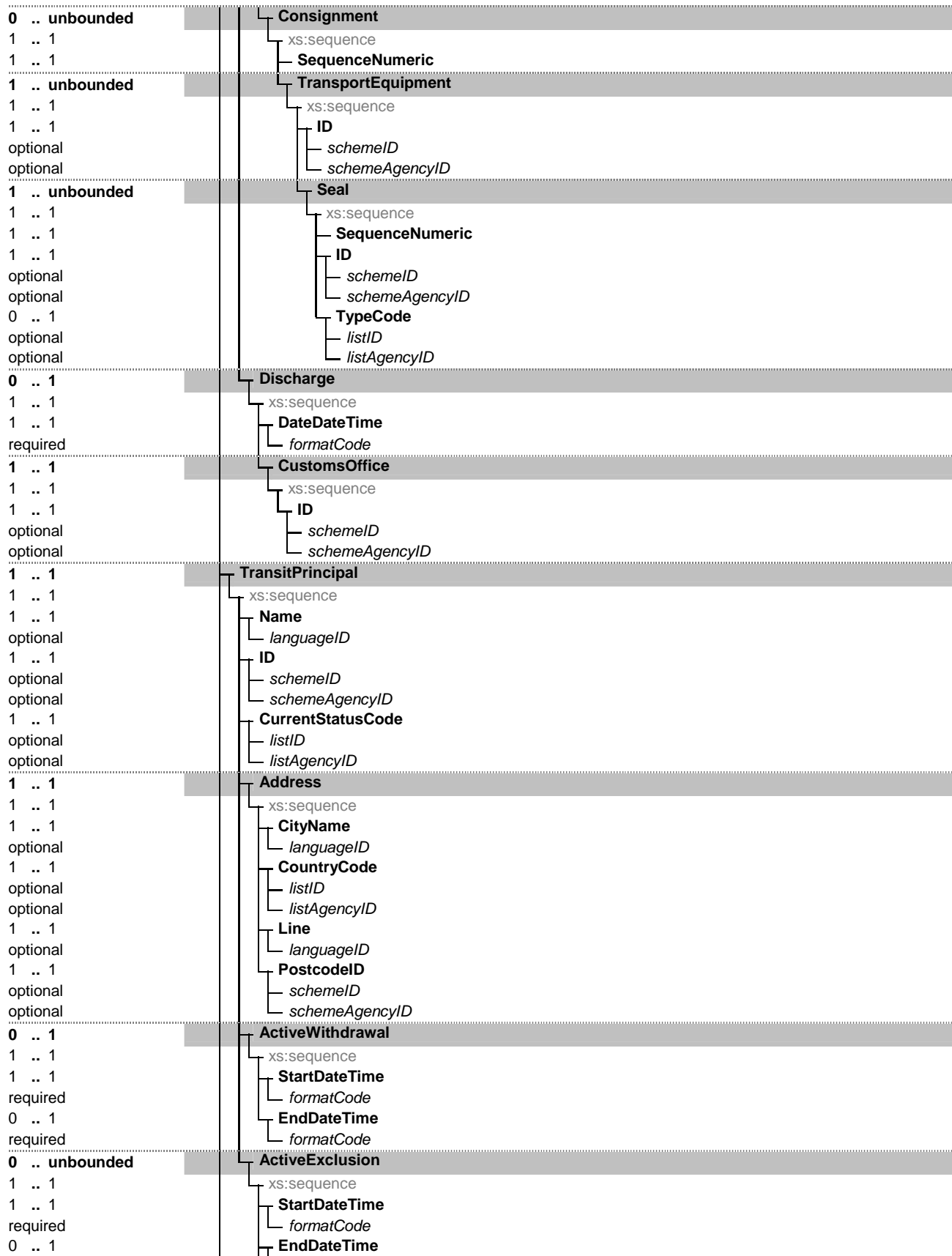

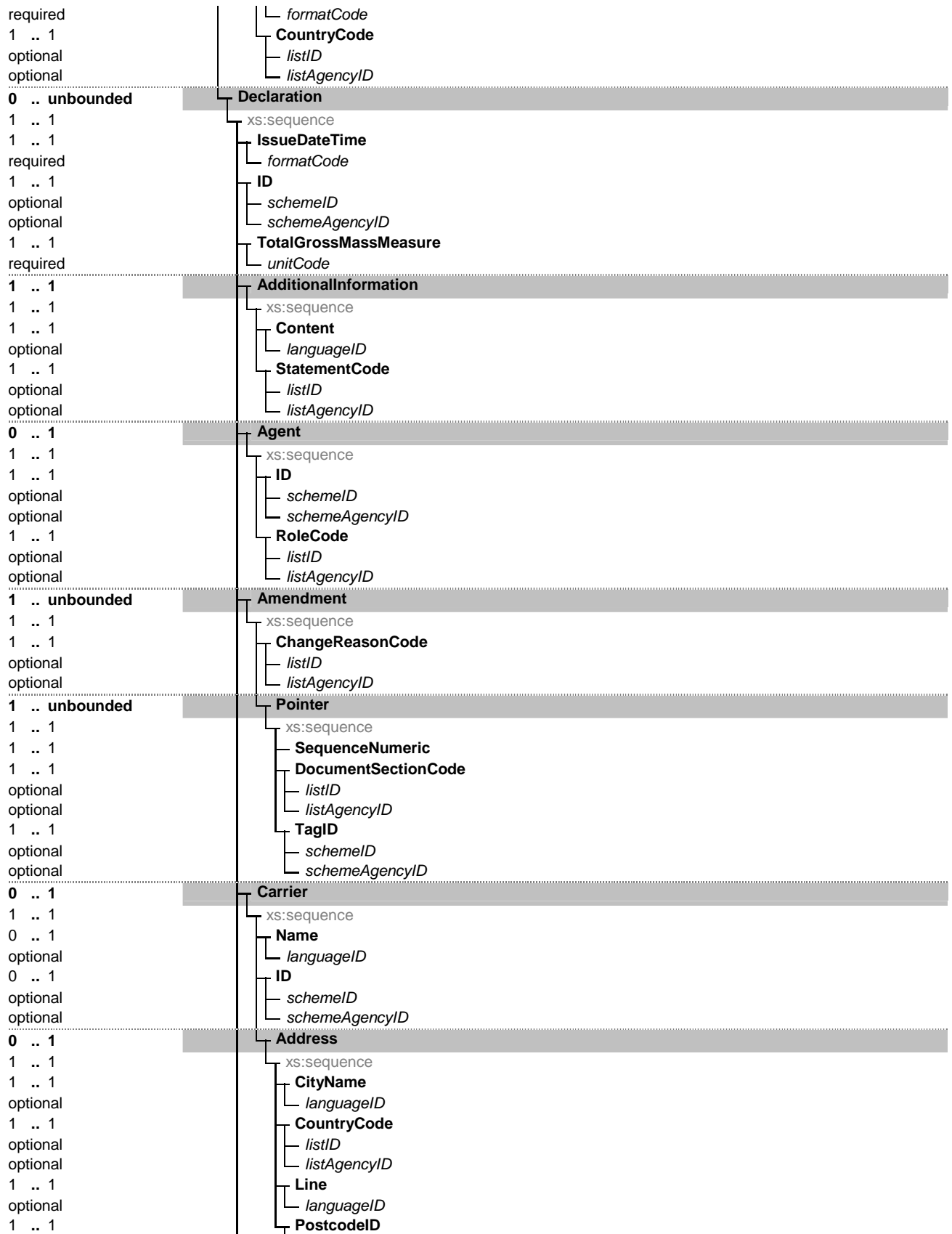

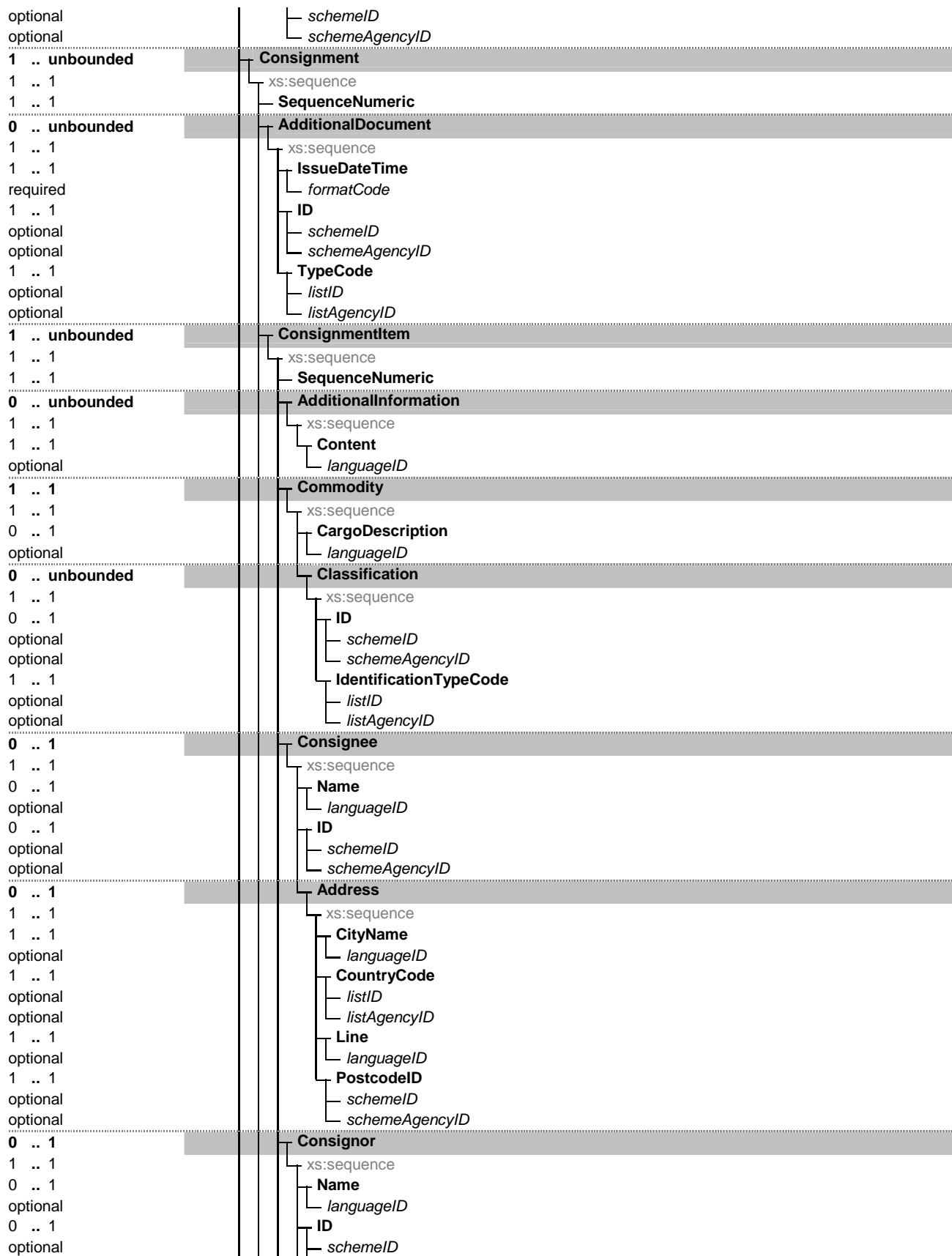

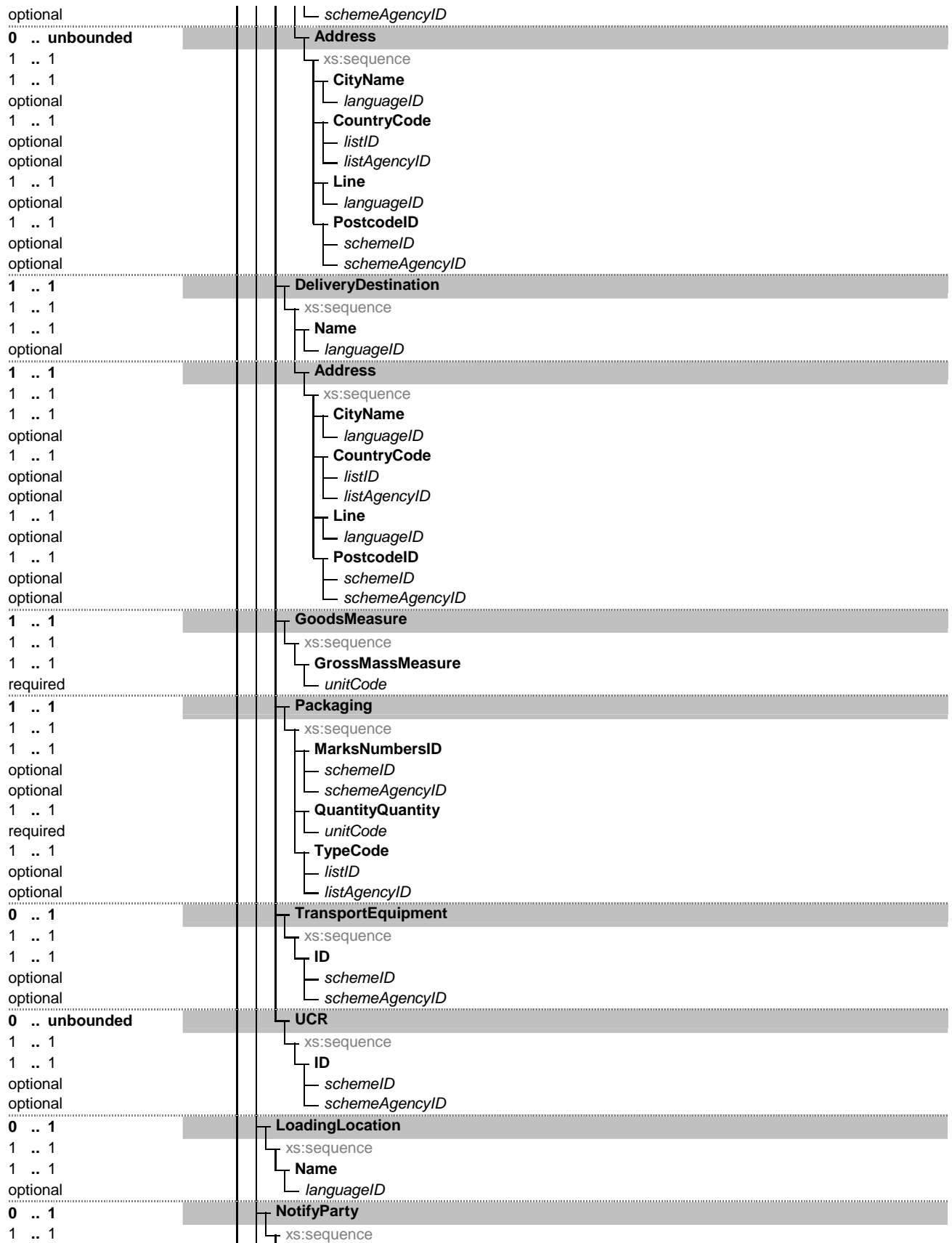

0 .. 1			Name
optional			languageID
0 .. 1			ID
optional			schemeID
optional			schemeAgencyID
0 .. 1			Address
1 .. 1			xs:sequence
1 .. 1			CityName
optional			languageID
1 .. 1			CountryCode
optional			listID
optional			listAgencyID
1 .. 1			Line
optional			languageID
1 .. 1			PostcodeID
optional			schemeID
optional			schemeAgencyID
1 .. 1			TransitDeparture
1 .. 1			xs:sequence
1 .. 1			ID
optional			schemeID
optional			schemeAgencyID
1 .. 1			TransitDestination
1 .. 1			xs:sequence
1 .. 1			ID
optional			schemeID
optional			schemeAgencyID
1 .. unbounded			TransitTransportMeans
1 .. 1			xs:sequence
1 .. 1			ID
optional			schemeID
optional			schemeAgencyID
1 .. 1			TypeCode
optional			listID
optional			listAgencyID
1 .. 1			RegistrationNationalityCode
optional			listID
optional			listAgencyID
0 .. 1			JourneyID
optional			schemeID
optional			schemeAgencyID
1 .. unbounded			Itinerary
1 .. 1			xs:sequence
1 .. 1			SequenceNumeric
1 .. 1			RoutingCountryCode
optional			listID
optional			listAgencyID
0 .. 1			AdditionalDocument
1 .. 1			xs:sequence
1 .. 1			IssueDateTime
required			formatCode
1 .. 1			ID
optional			schemeID
optional			schemeAgencyID
1 .. 1			TypeCode
optional			listID
optional			listAgencyID
0 .. unbounded			TransportEquipment
1 .. 1			xs:sequence

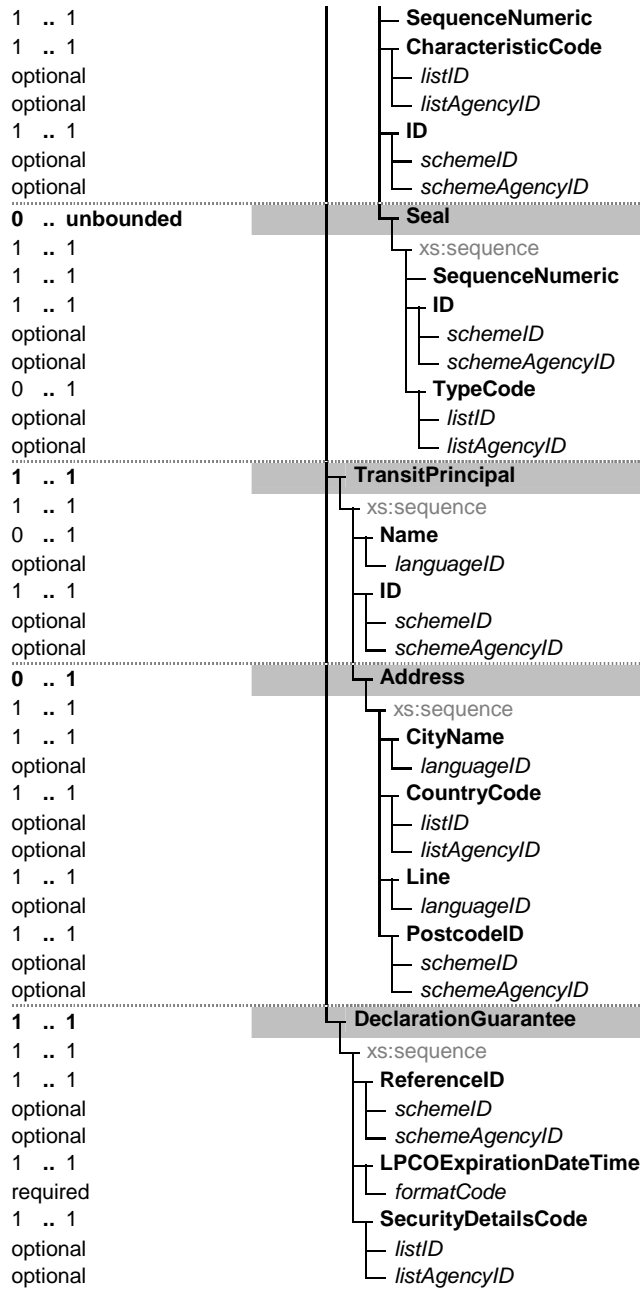

b. Guidelines

Element/Attribute	Annotation
Message	eTIR name Message
<i>xs:sequence</i>	Occurrence 1 .. 1
TypeCode	Occurrence 1 .. 1
	Type ds:MessageTypeCodeType
	WhiteSpace collapse
	Format an..3
	eTIR name Type, coded
	Status R
	Code List CL26 Message types

	Restricted code(s)	115	Notify Customs
listID	Type	xs:token	
	Use	optional	
	WhiteSpace	collapse	
listAgencyID	Type	clm63055:AgencyIdentificationCodeContentType	
	Length	1 .. 3	
	Use	optional	
	WhiteSpace	collapse	
ReferenceNumberID	Occurrence	1 .. 1	
	Type	ds:MessageReferenceNumberIDType	
	WhiteSpace	collapse	
	Format	an..14	
	eTIR name	Message reference number	
	Status	R	
schemeID	Type	xs:token	
	Use	optional	
	WhiteSpace	collapse	
schemeAgencyID	Type	clm63055:AgencyIdentificationCodeContentType	
	Length	1 .. 3	
	Use	optional	
	WhiteSpace	collapse	
FunctionCode	Occurrence	1 .. 1	
	Type	ds:MessageFunctionCodeType	
	WhiteSpace	collapse	
	Format	n..2	
	eTIR name	Message function, coded	
	Code List	CL16	Message function code
	Status	R	
	Restricted code(s)	9	Original
listID	Type	xs:token	
	Use	optional	
	WhiteSpace	collapse	
listAgencyID	Type	clm63055:AgencyIdentificationCodeContentType	
	Length	1 .. 3	
	Use	optional	
	WhiteSpace	collapse	
Guarantee	Occurrence	1 .. 1	
	eTIR name	Guarantee	
	Status	R	
xs:sequence	Occurrence	1 .. 1	
ReferenceID	Occurrence	1 .. 1	
	Type	ds:GuaranteeReferenceIDType	
	WhiteSpace	collapse	
	Format	an..35	
	eTIR name	Reference	
	Status	R	
schemeID	Type	xs:token	
	Use	optional	
	WhiteSpace	collapse	
schemeAgencyID	Type	clm63055:AgencyIdentificationCodeContentType	
	Length	1 .. 3	
	Use	optional	
	WhiteSpace	collapse	
LPCOExpirationDateTime	Occurrence	1 .. 1	
	Type	ds:GuaranteeLPCOExpirationDateTimeType	
	WhiteSpace	collapse	
	Format	n8	
	eTIR name	Validity	
	Status	R	
formatCode	Type	clm62379:DateTimePeriodFormatCode	
	Length	1 .. 3	
	Use	required	
	WhiteSpace	collapse	

	Name	Date or time or period format code
	Description	Code specifying the representation of a date, time or period.
	Applicable Codes	
	102	CCYYMMDD Calendar date: C = Century ; Y = Year ; M = Month ; D = Day.
	304	CCYYMMDDHHMMSSZZ See 204 plus Z=Time zone.
	602	CCYY Calendar year including century: C = Century; Y = Year.
SecurityDetailsCode	Occurrence	1 .. 1
	Type	ds:GuaranteeSecurityDetailsCodeType
	WhiteSpace	collapse
	Format	an..3
	eTIR name	Guarantee type
	Code List	CL12 Guarantee type code
	Status	R
<i>listID</i>	Type	xs:token
	Use	optional
	WhiteSpace	collapse
<i>listAgencyID</i>	Type	clm63055:AgencyIdentificationCodeContentType
	Length	1 .. 3
	Use	optional
	WhiteSpace	collapse
GuaranteeStatusCode	Occurrence	1 .. 1
	Type	ds:GuaranteeGuaranteeStatusCodeType
	WhiteSpace	collapse
	Format	an..3
	Code List	CL22 Guarantee status
	eTIR name	Guarantee status
	Status	R
<i>listID</i>	Type	xs:token
	Use	optional
	WhiteSpace	collapse
<i>listAgencyID</i>	Type	clm63055:AgencyIdentificationCodeContentType
	Length	1 .. 3
	Use	optional
	WhiteSpace	collapse
Surety	Occurrence	1 .. 1
	eTIR name	GuaranteeChain
	Status	R
<i>xs:sequence</i>	Occurrence	1 .. 1
ID	Occurrence	1 .. 1
	Type	ds:SuretyIdentificationIDType
	WhiteSpace	collapse
	Format	an..17
	eTIR name	Code
	Status	R
<i>schemeID</i>	Type	xs:token
	Use	optional
	WhiteSpace	collapse
<i>schemeAgencyID</i>	Type	clm63055:AgencyIdentificationCodeContentType
	Length	1 .. 3
	Use	optional
	WhiteSpace	collapse
TIROperation	Occurrence	0 .. unbounded
	eTIR name	TIROperation
	Status	O
<i>xs:sequence</i>	Occurrence	1 .. 1
SequenceNumeric	Occurrence	1 .. 1
	Type	ds:TIROperationSequenceNumericType
	Format	n..5
	eTIR name	Sequence number
	Status	R

RegistrationNumberID	<p>Occurrence 1 .. 1 Type ds:TIROperationRegistrationNumberIDType WhiteSpace collapse eTIR name Registration number Format an..35 Status R</p>
<i>schemeID</i>	<p>Type xs:token Use optional WhiteSpace collapse</p>
<i>schemeAgencyID</i>	<p>Type clm63055:AgencyIdentificationCodeContentType Length 1 .. 3 Use optional WhiteSpace collapse</p>
Start	<p>Occurrence 0 .. 1 eTIR name Start Status O</p>
xs:sequence	<p>Occurrence 1 .. 1</p>
DateDateTime	<p>Occurrence 1 .. 1 Type ds:StartDateDateTimeType WhiteSpace collapse eTIR name Date Format n..17 Status R</p>
<i>formatCode</i>	<p>Type clm62379:DateTimePeriodFormatCode Length 1 .. 3 Use required WhiteSpace collapse Name Date or time or period format code Description Code specifying the representation of a date, time or period.</p> <p>Applicable Codes</p> <p>102 CCYYMMDD Calendar date: C = Century ; Y = Year ; M = Month ; D = Day.</p> <p>304 CCYYMMDDHHMMSSZZ See 204 plus Z=Time zone.</p> <p>602 CCYY Calendar year including century: C = Century; Y = Year.</p>
TimeLimitDateTime	<p>Occurrence 0 .. 1 Type ds:StartTimeLimitDateTimeType WhiteSpace collapse eTIR name Time limit Format n..17 Status O</p>
<i>formatCode</i>	<p>Type clm62379:DateTimePeriodFormatCode Length 1 .. 3 Use required WhiteSpace collapse Name Date or time or period format code Description Code specifying the representation of a date, time or period.</p> <p>Applicable Codes</p> <p>102 CCYYMMDD Calendar date: C = Century ; Y = Year ; M = Month ; D = Day.</p> <p>304 CCYYMMDDHHMMSSZZ See 204 plus Z=Time zone.</p> <p>602 CCYY Calendar year including century: C = Century; Y = Year.</p>
Remarks	<p>Occurrence 0 .. 1 Type ds:StartRemarksTextType eTIR name Remarks Format an..512 Status O</p>

<i>languageID</i>	Type Use Pattern WhiteSpace	xs:language optional ([a-zA-Z]{2} [iI]-[a-zA-Z]+ [xX]-[a-zA-Z]{1,8})-[a-zA-Z]{1,8})* collapse
CustomsOffice	Occurrence eTIR name Status	1 .. 1 CustomsOffice R
xs:sequence	Occurrence	1 .. 1
ID	Occurrence Type WhiteSpace Format eTIR name Code List Status	1 .. 1 ds:CustomsOfficeIdentificationIDType collapse an..17 Customs office, coded CL13 R Customs offices database (to be developed)
<i>schemeID</i>	Type Use WhiteSpace	xs:token optional collapse
<i>schemeAgencyID</i>	Type Length Use WhiteSpace	clm63055:AgencyIdentificationCodeContentType 1 .. 3 optional collapse
NationalItinerary	Occurrence eTIR name Status	0 .. unbounded NationalItinerary O
xs:sequence	Occurrence	1 .. 1
ID	Occurrence Type WhiteSpace Format eTIR name Code List Status	1 .. 1 ds:NationalItineraryIdentificationIDType collapse an..17 Customs office, coded CL13 R Customs offices database (to be developed)
<i>schemeID</i>	Type Use WhiteSpace	xs:token optional collapse
<i>schemeAgencyID</i>	Type Length Use WhiteSpace	clm63055:AgencyIdentificationCodeContentType 1 .. 3 optional collapse
ControlResult	Occurrence eTIR name Status	1 .. unbounded ControlResult R
xs:sequence	Occurrence	1 .. 1
ResultCodeCode	Occurrence Type WhiteSpace eTIR name Code List Format Status	1 .. 1 ds:ControlResultResultCodeCodeType collapse Code CL24 an..3 R Control result code
<i>listID</i>	Type Use WhiteSpace	xs:token optional collapse
<i>listAgencyID</i>	Type Length Use WhiteSpace	clm63055:AgencyIdentificationCodeContentType 1 .. 3 optional collapse
ControlType	Occurrence eTIR name Status	1 .. 1 ControlType R
xs:sequence	Occurrence	1 .. 1

<ul style="list-style-type: none"> └ ID 	<p>Occurrence 1 .. 1 Type ds:ControlTypeIdentificationCodeType WhiteSpace collapse eTIR name Identification Format an..3 Code List CL25 Control type code Status R</p>
<ul style="list-style-type: none"> └ listID 	<p>Type xs:token Use optional WhiteSpace collapse</p>
<ul style="list-style-type: none"> └ listAgencyID 	<p>Type clm63055:AgencyIdentificationCodeContentType Length 1 .. 3 Use optional WhiteSpace collapse</p>
<ul style="list-style-type: none"> └ Consignment 	<p>Occurrence 0 .. unbounded Status O Rule R007 Rule R006 eTIR name Consignment</p>
<ul style="list-style-type: none"> └ xs:sequence └ SequenceNumeric 	<p>Occurrence 1 .. 1 Type ds:ConsignmentSequenceNumericType Format n..5 Status R eTIR name Sequence number Status R</p>
<ul style="list-style-type: none"> └ TransportEquipment 	<p>Occurrence 1 .. unbounded Status R eTIR name TransportEquipment</p>
<ul style="list-style-type: none"> └ xs:sequence └ ID 	<p>Occurrence 1 .. 1 Type ds:TransportEquipmentIdentificationIDType WhiteSpace collapse Format an..17 Status R eTIR name Identification</p>
<ul style="list-style-type: none"> └ schemeID 	<p>Type xs:token Use optional WhiteSpace collapse</p>
<ul style="list-style-type: none"> └ schemeAgencyID 	<p>Type clm63055:AgencyIdentificationCodeContentType Length 1 .. 3 Use optional WhiteSpace collapse</p>
<ul style="list-style-type: none"> └ Seal 	<p>Occurrence 1 .. unbounded Status R eTIR name Seal</p>
<ul style="list-style-type: none"> └ xs:sequence └ SequenceNumeric 	<p>Occurrence 1 .. 1 Type ds:SealSequenceNumericType Format n..5 Status R Rule R003 Rule R004 eTIR name Sequence number</p>
<ul style="list-style-type: none"> └ ID 	<p>Occurrence 1 .. 1 Type ds:SealIdentificationIDType WhiteSpace collapse Format an..35 Status R Rule R005 eTIR name Seal number</p>
<ul style="list-style-type: none"> └ schemeID 	<p>Type xs:token Use optional WhiteSpace collapse</p>

<i>schemaAgencyID</i>	Type Length Use WhiteSpace	clm63055:AgencyIdentificationCodeContentType 1 .. 3 optional collapse
TypeCode	Occurrence Type WhiteSpace Format Status eTIR name Code List	0 .. 1 ds:SealTypeCodeType collapse an..3 O Seal type code CL08 Seal type code
<i>listID</i>	Type Use WhiteSpace	xs:token optional collapse
<i>listAgencyID</i>	Type Length Use WhiteSpace	clm63055:AgencyIdentificationCodeContentType 1 .. 3 optional collapse
Termination	Occurrence eTIR name Status	0 .. 1 Termination O
xs:sequence	Occurrence	1 .. 1
DateDateTime	Occurrence Type WhiteSpace eTIR name Format Status	1 .. 1 ds:TerminationDateDateTimeType collapse Date n..17 R
<i>formatCode</i>	Type Length Use WhiteSpace Name Description	clm62379:DateTimePeriodFormatCode 1 .. 3 required collapse Date or time or period format code Code specifying the representation of a date, time or period.
Applicable Codes		
	102	CCYYMMDD Calendar date: C = Century ; Y = Year ; M = Month ; D = Day.
	304	CCYYMMDDHHMMSSZZ See 204 plus Z=Time zone.
	602	CCYY Calendar year including century: C = Century; Y = Year.
NumberOfPackagesQuantity	Occurrence Type Format eTIR name Status	1 .. 1 ds:TerminationNumberOfPackagesQuantityType n..8 Number of packages R
<i>unitCode</i>	Type Length Use WhiteSpace	clm6Recommendation20: MeasurementUnitCommonCodeContentType 1 .. 3 required collapse
Reservations	Occurrence Type eTIR name Format Status	0 .. 1 ds:TerminationReservationsTextType Reservations an..512 O
<i>languageID</i>	Type Use Pattern	xs:language optional ([a-zA-Z]{2} [iI]-[a-zA-Z]+ [xX]-[a-zA-Z]{1,8})-[a-zA-Z]{1,8})*
CustomsOffice	WhiteSpace Occurrence eTIR name Status	collapse 1 .. 1 CustomsOffice R

<ul style="list-style-type: none"> xs:sequence <ul style="list-style-type: none"> ID 	Occurrence 1 .. 1 Occurrence 1 .. 1 Type ds:CustomsOfficeIdentificationIDType WhiteSpace collapse Format an..17 eTIR name Customs office, coded Code List CL13 Customs offices database (to be developed) Status R
<ul style="list-style-type: none"> <ul style="list-style-type: none"> <i>schemeID</i> 	Type xs:token Use optional WhiteSpace collapse
<ul style="list-style-type: none"> <ul style="list-style-type: none"> <i>schemeAgencyID</i> 	Type clm63055:AgencyIdentificationCodeContentType Length 1 .. 3 Use optional WhiteSpace collapse
<ul style="list-style-type: none"> ControlResult 	Occurrence 1 .. unbounded eTIR name ControlResult Status R
<ul style="list-style-type: none"> xs:sequence <ul style="list-style-type: none"> ResultCodeCode 	Occurrence 1 .. 1 Occurrence 1 .. 1 Type ds:ControlResultResultCodeCodeType WhiteSpace collapse eTIR name Code Code List CL24 Control result code Format an..3 Status R
<ul style="list-style-type: none"> <ul style="list-style-type: none"> <i>listID</i> 	Type xs:token Use optional WhiteSpace collapse
<ul style="list-style-type: none"> <ul style="list-style-type: none"> <i>listAgencyID</i> 	Type clm63055:AgencyIdentificationCodeContentType Length 1 .. 3 Use optional WhiteSpace collapse
<ul style="list-style-type: none"> ControlType 	Occurrence 1 .. 1 eTIR name ControlType Status R
<ul style="list-style-type: none"> xs:sequence <ul style="list-style-type: none"> ID 	Occurrence 1 .. 1 Occurrence 1 .. 1 Type ds:ControlTypeIdentificationCodeType WhiteSpace collapse eTIR name Identification Format an..3 Code List CL25 Control type code Status R
<ul style="list-style-type: none"> <ul style="list-style-type: none"> <i>listID</i> 	Type xs:token Use optional WhiteSpace collapse
<ul style="list-style-type: none"> <ul style="list-style-type: none"> <i>listAgencyID</i> 	Type clm63055:AgencyIdentificationCodeContentType Length 1 .. 3 Use optional WhiteSpace collapse
<ul style="list-style-type: none"> Consignment 	Occurrence 0 .. unbounded Status O Rule R006 Rule R007 eTIR name Consignment
<ul style="list-style-type: none"> xs:sequence <ul style="list-style-type: none"> SequenceNumeric 	Occurrence 1 .. 1 Occurrence 1 .. 1 Type ds:ConsignmentSequenceNumericType Format n..5 Status R eTIR name Sequence number Status R
<ul style="list-style-type: none"> TransportEquipment 	Occurrence 1 .. unbounded

	Status	R
	eTIR name	TransportEquipment
	Occurrence	1 .. 1
xs:sequence	Occurrence	1 .. 1
ID	Type	ds:TransportEquipmentIdentificationIDType
	WhiteSpace	collapse
	Format	an..17
	Status	R
	eTIR name	Identification
<i>schemeID</i>	Type	xs:token
	Use	optional
	WhiteSpace	collapse
<i>schemeAgencyID</i>	Type	clm63055:AgencyIdentificationCodeContentType
	Length	1 .. 3
	Use	optional
	WhiteSpace	collapse
Seal	Occurrence	1 .. unbounded
	Status	R
	eTIR name	Seal
xs:sequence	Occurrence	1 .. 1
SequenceNumeric	Occurrence	1 .. 1
	Type	ds:SealSequenceNumericType
	Format	n..5
	Status	R
	Rule	R003
	Rule	R004
	eTIR name	Sequence number
ID	Occurrence	1 .. 1
	Type	ds:SealIdentificationIDType
	WhiteSpace	collapse
	Format	an..35
	Status	R
	Rule	R006
<i>schemeID</i>	eTIR name	Seal number
	Type	xs:token
	Use	optional
	WhiteSpace	collapse
<i>schemeAgencyID</i>	Type	clm63055:AgencyIdentificationCodeContentType
	Length	1 .. 3
	Use	optional
	WhiteSpace	collapse
TypeCode	Occurrence	0 .. 1
	Type	ds:SealTypeCodeType
	WhiteSpace	collapse
	Format	an..3
	Status	O
	eTIR name	Seal type code
	Code List	CL08 Seal type code
<i>listID</i>	Type	xs:token
	Use	optional
	WhiteSpace	collapse
<i>listAgencyID</i>	Type	clm63055:AgencyIdentificationCodeContentType
	Length	1 .. 3
	Use	optional
	WhiteSpace	collapse
Discharge	Occurrence	0 .. 1
	eTIR name	Discharge
	Status	O
xs:sequence	Occurrence	1 .. 1
DateDateTime	Occurrence	1 .. 1
	Type	ds:DischargeDateDateTimeType
	WhiteSpace	collapse
	eTIR name	Date
	Format	n..17
	Status	R

<i>formatCode</i>	<p>Type clm62379:DateTimePeriodFormatCode Length 1 .. 3 Use required WhiteSpace collapse Name Date or time or period format code Description Code specifying the representation of a date, time or period.</p> <p>Applicable Codes</p> <p>102 CCYYMMDD Calendar date: C = Century ; Y = Year ; M = Month ; D = Day. 304 CCYYMMDDHHMMSSZZZ See 204 plus Z=Time zone. 602 CCYY Calendar year including century: C = Century; Y = Year.</p>
CustomsOffice	<p>Occurrence 1 .. 1 eTIR name CustomsOffice Status R</p>
xs:sequence	
ID	<p>Occurrence 1 .. 1 Type ds:CustomsOfficeIdentificationIDType WhiteSpace collapse Format an..17 eTIR name Customs office, coded Code List CL13 Customs offices database (to be developed)</p> <p>Status R</p>
<i>schemeID</i>	<p>Type xs:token Use optional WhiteSpace collapse</p>
<i>schemeAgencyID</i>	<p>Type clm63055:AgencyIdentificationCodeContentType Length 1 .. 3 Use optional WhiteSpace collapse</p>
TransitPrincipal	<p>Occurrence 1 .. 1 eTIR name Holder Status R</p>
xs:sequence	
Name	<p>Occurrence 1 .. 1 Type ds:TransitPrincipalNameTextType Format an..70 eTIR name Name Status R</p>
<i>languageID</i>	<p>Type xs:language Use optional Pattern ([a-zA-Z]{2} [iI]-[a-zA-Z]+ [xX]-[a-zA-Z]{1,8})-([a-zA-Z]{1,8})* WhiteSpace collapse</p>
ID	<p>Occurrence 1 .. 1 Type ds:TransitPrincipalIdentificationIDType WhiteSpace collapse Format an..17 eTIR name Code Code List CL15 International TIR database Status R</p>
<i>schemeID</i>	<p>Type xs:token Use optional WhiteSpace collapse</p>
<i>schemeAgencyID</i>	<p>Type clm63055:AgencyIdentificationCodeContentType Length 1 .. 3 Use optional WhiteSpace collapse</p>
CurrentStatusCode	<p>Occurrence 1 .. 1 Type ds:TransitPrincipalCurrentStatusCodeType WhiteSpace collapse Code List CL23 Holder status</p>

	eTIR name	Current status
	Format	an..3
	Status	R
<i>listID</i>	Type	xs:token
	Use	optional
	WhiteSpace	collapse
<i>listAgencyID</i>	Type	clm63055:AgencyIdentificationCodeContentType
	Length	1 .. 3
	Use	optional
	WhiteSpace	collapse
Address	Occurrence	1 .. 1
	eTIR name	Address
	Status	R
<i>xs:sequence</i>	Occurrence	1 .. 1
CityName	Occurrence	1 .. 1
	Type	ds:AddressCityNameTextType
	Format	an..35
	eTIR name	City name
	Status	R
<i>languageID</i>	Type	xs:language
	Use	optional
	Pattern	([a-zA-Z]{2} [i!]-[a-zA-Z]+[xX]-[a-zA-Z]{1,8})-([a-zA-Z]{1,8})*
	WhiteSpace	collapse
CountryCode	Occurrence	1 .. 1
	Type	ds:AddressCountryCodeType
	WhiteSpace	collapse
	Format	a2
	Code List	CL04 Country name code
	eTIR name	Country, coded
	Status	R
<i>listID</i>	Type	xs:token
	Use	optional
	WhiteSpace	collapse
<i>listAgencyID</i>	Type	clm63055:AgencyIdentificationCodeContentType
	Length	1 .. 3
	Use	optional
	WhiteSpace	collapse
Line	Occurrence	1 .. 1
	Type	ds:AddressLineTextType
	Format	an..70
	eTIR name	Street and number/P.O. Box
	Status	R
<i>languageID</i>	Type	xs:language
	Use	optional
	Pattern	([a-zA-Z]{2} [i!]-[a-zA-Z]+[xX]-[a-zA-Z]{1,8})-([a-zA-Z]{1,8})*
	WhiteSpace	collapse
PostcodeID	Occurrence	1 .. 1
	Type	ds:AddressPostcodeIDType
	WhiteSpace	collapse
	Format	an..9
	eTIR name	Postcode identification
	Status	R
<i>schemeID</i>	Type	xs:token
	Use	optional
	WhiteSpace	collapse
<i>schemeAgencyID</i>	Type	clm63055:AgencyIdentificationCodeContentType
	Length	1 .. 3
	Use	optional
	WhiteSpace	collapse
ActiveWithdrawal	Occurrence	0 .. 1
	eTIR name	ActiveWithdrawal
	Status	O
<i>xs:sequence</i>	Occurrence	1 .. 1

StartDateTime	<p>Occurrence 1 .. 1 Type ds:ActiveWithdrawalStartDateTimeType WhiteSpace collapse eTIR name Start Format n..17 Status R</p>
formatCode	<p>Type clm62379:DateTimePeriodFormatCode Length 1 .. 3 Use required WhiteSpace collapse Name Date or time or period format code Description Code specifying the representation of a date, time or period.</p> <p>Applicable Codes</p> <p>102 CCYYMMDD Calendar date: C = Century ; Y = Year ; M = Month ; D = Day.</p> <p>304 CCYYMMDDHHMMSSZZ See 204 plus Z=Time zone.</p> <p>602 CCYY Calendar year including century: C = Century; Y = Year.</p>
EndDateTime	<p>Occurrence 0 .. 1 Type ds:ActiveWithdrawalEndTimeType WhiteSpace collapse eTIR name End Format n..17 Status O</p>
formatCode	<p>Type clm62379:DateTimePeriodFormatCode Length 1 .. 3 Use required WhiteSpace collapse Name Date or time or period format code Description Code specifying the representation of a date, time or period.</p> <p>Applicable Codes</p> <p>102 CCYYMMDD Calendar date: C = Century ; Y = Year ; M = Month ; D = Day.</p> <p>304 CCYYMMDDHHMMSSZZ See 204 plus Z=Time zone.</p> <p>602 CCYY Calendar year including century: C = Century; Y = Year.</p>
ActiveExclusion	<p>Occurrence 0 .. unbounded eTIR name ActiveExclusion Status O</p>
xs:sequence	Occurrence 1 .. 1
StartDateTime	<p>Occurrence 1 .. 1 Type ds:ActiveExclusionStartDateTimeType WhiteSpace collapse eTIR name Start Format n..17 Status R</p>
formatCode	<p>Type clm62379:DateTimePeriodFormatCode Length 1 .. 3 Use required WhiteSpace collapse Name Date or time or period format code Description Code specifying the representation of a date, time or period.</p> <p>Applicable Codes</p> <p>102 CCYYMMDD Calendar date: C = Century ; Y = Year ; M = Month ; D = Day.</p> <p>304 CCYYMMDDHHMMSSZZ See 204 plus Z=Time zone.</p>

EndDateTime	602 CCYY Calendar year including century: C = Century; Y = Year. Occurrence 0 .. 1 Type ds:ActiveExclusionEndDateTimeType WhiteSpace collapse eTIR name End Format n..17 Status O
formatCode	Type clm62379:DateTimePeriodFormatCode Length 1 .. 3 Use required WhiteSpace collapse Name Date or time or period format code Description Code specifying the representation of a date, time or period.
CountryCode	Applicable Codes 102 CCYYMMDD Calendar date: C = Century ; Y = Year ; M = Month ; D = Day. 304 CCYYMMDDHHMMSSZZ See 204 plus Z=Time zone. 602 CCYY Calendar year including century: C = Century; Y = Year.
listID	Occurrence 1 .. 1 Type ds:ActiveExclusionCountryCodeType WhiteSpace collapse Code List CL04 Country name code eTIR name Country, coded Format a2 Status R
listAgencyID	Type xs:token Use optional WhiteSpace collapse Type clm63055:AgencyIdentificationCodeContentType Length 1 .. 3 Use optional WhiteSpace collapse
Declaration	Occurrence 0 .. unbounded eTIR name AdvancedCargoInformation Status O
xs:sequence	Occurrence 1 .. 1
IssueDateTime	Occurrence 1 .. 1 Type ds:DeclarationIssueDateTimeType WhiteSpace collapse Format an..17 eTIR name Date Status R
formatCode	Type clm62379:DateTimePeriodFormatCode Length 1 .. 3 Use required WhiteSpace collapse Name Date or time or period format code Description Code specifying the representation of a date, time or period.
ID	Applicable Codes 102 CCYYMMDD Calendar date: C = Century ; Y = Year ; M = Month ; D = Day. 304 CCYYMMDDHHMMSSZZ See 204 plus Z=Time zone. 602 CCYY Calendar year including century: C = Century; Y = Year. Occurrence 1 .. 1 Type ds:DeclarationIdentificationIDType WhiteSpace collapse Format an..35

	eTIR name	Reference
	Status	R
— <i>schemeID</i>	Type	xs:token
	Use	optional
	WhiteSpace	collapse
— <i>schemeAgencyID</i>	Type	clm63055:AgencyIdentificationCodeContentType
	Length	1 .. 3
	Use	optional
	WhiteSpace	collapse
TotalGrossMassMeasure	Occurrence	1 .. 1
	Type	ds:DeclarationTotalGrossMassMeasureType
	Format	n..16,6
	eTIR name	Total gross weight
	Status	R
— <i>unitCode</i>	Type	clm6Recommendation20:MeasurementUnitCommonCodeContentType
	Length	1 .. 3
	Use	required
	WhiteSpace	collapse
AdditionalInformation	Occurrence	1 .. 1
	eTIR name	AdditionalInformation
	Status	R
— xs:sequence	Occurrence	1 .. 1
— Content	Occurrence	1 .. 1
	Type	ds:AdditionalInformationContentTextType
	Format	an..512
	eTIR name	Remarks
	Status	R
— <i>languageID</i>	Type	xs:language
	Use	optional
	Pattern	([a-zA-Z]{2} [iI]-[a-zA-Z]+ [xX]-[a-zA-Z]{1,8})-([a-zA-Z]{1,8})*
	WhiteSpace	collapse
— StatementCode	Occurrence	1 .. 1
	Type	ds:AdditionalInformationStatementCodeType
	WhiteSpace	collapse
	Format	an..17
	eTIR name	Heavy and bulky goods indicator
	Code List	CL14 Indicator
	Status	R
— <i>listID</i>	Type	xs:token
	Use	optional
	WhiteSpace	collapse
— <i>listAgencyID</i>	Type	clm63055:AgencyIdentificationCodeContentType
	Length	1 .. 3
	Use	optional
	WhiteSpace	collapse
Agent	Occurrence	0 .. 1
	eTIR name	Agent
	Status	O
— xs:sequence	Occurrence	1 .. 1
— ID	Occurrence	1 .. 1
	Type	ds:AgentIdentificationIDType
	WhiteSpace	collapse
	Format	an..17
	eTIR name	Code
	Status	R
— <i>schemeID</i>	Type	xs:token
	Use	optional
	WhiteSpace	collapse
— <i>schemeAgencyID</i>	Type	clm63055:AgencyIdentificationCodeContentType
	Length	1 .. 3
	Use	optional
	WhiteSpace	collapse

RoleCode	Occurrence 1 .. 1 Type ds:AgentRoleCodeType WhiteSpace collapse Format an..3 Code List CL02 Party role codes eTIR name Role, coded Status R
<i>listID</i>	Type xs:token Use optional WhiteSpace collapse
<i>listAgencyID</i>	Type clm63055:AgencyIdentificationCodeContentType Length 1 .. 3 Use optional WhiteSpace collapse
Amendment	Occurrence 1 .. unbounded eTIR name Amendment Status R
xs:sequence	Occurrence 1 .. 1
ChangeReasonCode	Occurrence 1 .. 1 Type ds:AmendmentChangeReasonCodeType WhiteSpace collapse Format an..3 eTIR name Amendment code Code List CL17 Amendment code Status R
<i>listID</i>	Type xs:token Use optional WhiteSpace collapse
<i>listAgencyID</i>	Type clm63055:AgencyIdentificationCodeContentType Length 1 .. 3 Use optional WhiteSpace collapse
Pointer	Occurrence 1 .. unbounded eTIR name Pointer Status R
xs:sequence	Occurrence 1 .. 1
SequenceNumeric	Occurrence 1 .. 1 Type ds:PointerSequenceNumericType Format n..5 eTIR name Sequence number Status R
DocumentSectionCode	Occurrence 1 .. 1 Type ds:PointerDocumentSectionCodeType WhiteSpace collapse Format an..3 eTIR name Document/message section, coded Code List CL18 Message section code (codes to be defined) Status R
<i>listID</i>	Type xs:token Use optional WhiteSpace collapse
<i>listAgencyID</i>	Type clm63055:AgencyIdentificationCodeContentType Length 1 .. 3 Use optional WhiteSpace collapse
TagID	Occurrence 1 .. 1 Type ds:PointerTagIDType WhiteSpace collapse Format an..4 eTIR name Tag identifier Code List CL19 Pointer code (codes to be defined) Status R

<i>schemeID</i>	Type Use WhiteSpace	xs:token optional collapse
<i>schemeAgencyID</i>	Type Length Use WhiteSpace	clm63055:AgencyIdentificationCodeContentType 1 .. 3 optional collapse
Carrier	Occurrence eTIR name Status	0 .. 1 SubContractor O
xs:sequence	Occurrence	1 .. 1
Name	Occurrence Type Format eTIR name Condition Status	0 .. 1 ds:CarrierNameTextType an..70 Name C001 D
<i>languageID</i>	Type Use Pattern WhiteSpace	xs:language optional ([a-zA-Z]{2} [iI]-[a-zA-Z]+ [xX]-[a-zA-Z]{1,8})-[a-zA-Z]{1,8)* collapse
ID	Occurrence Type WhiteSpace Format eTIR name Code List Condition Status	0 .. 1 ds:CarrierIdentificationIDType collapse an..17 Code CL15 International TIR database C001 D
<i>schemeID</i>	Type Use WhiteSpace	xs:token optional collapse
<i>schemeAgencyID</i>	Type Length Use WhiteSpace	clm63055:AgencyIdentificationCodeContentType 1 .. 3 optional collapse
Address	Occurrence eTIR name Condition Status	0 .. 1 Address C001 D
xs:sequence	Occurrence	1 .. 1
CityName	Occurrence Type Format eTIR name Status	1 .. 1 ds:AddressCityNameTextType an..35 City name R
<i>languageID</i>	Type Use Pattern WhiteSpace	xs:language optional ([a-zA-Z]{2} [iI]-[a-zA-Z]+ [xX]-[a-zA-Z]{1,8})-[a-zA-Z]{1,8)* collapse
CountryCode	Occurrence Type WhiteSpace Format Code List eTIR name Status	1 .. 1 ds:AddressCountryCodeType collapse a2 CL04 Country name code Country, coded R
<i>listID</i>	Type Use WhiteSpace	xs:token optional collapse

<i>listAgencyID</i>	Type Length Use WhiteSpace	clm63055:AgencyIdentificationCodeContentType 1 .. 3 optional collapse
Line	Occurrence Type Format eTIR name Status	1 .. 1 ds:AddressLineTextType an..70 Street and number/P.O. Box R
<i>languageID</i>	Type Use Pattern	xs:language optional ([a-zA-Z]{2} [il]-[a-zA-Z]+ [xX]-[a-zA-Z]{1,8}){1,8}
PostcodeID	WhiteSpace Occurrence Type WhiteSpace Format eTIR name Status	collapse 1 .. 1 ds:AddressPostcodeIDType collapse an..9 Postcode identification R
<i>schemeID</i>	Type Use WhiteSpace	xs:token optional collapse
<i>schemeAgencyID</i>	Type Length Use WhiteSpace	clm63055:AgencyIdentificationCodeContentType 1 .. 3 optional collapse
Consignment	Occurrence Status Rule eTIR name	1 .. unbounded R R007 Consignment
xs:sequence	Occurrence	1 .. 1
SequenceNumeric	Occurrence Type Format eTIR name Status	1 .. 1 ds:ConsignmentSequenceNumericType n..5 Sequence number R
AdditionalDocument	Occurrence Remark eTIR name Status	0 .. unbounded Also needed for EX1, not in Objectteering AttachedDocuments O
xs:sequence	Occurrence	1 .. 1
IssueDateTime	Occurrence Type WhiteSpace Format eTIR name Status	1 .. 1 ds:AdditionalDocumentIssueDateTimeType collapse an..17 Issuing date R
<i>formatCode</i>	Type Length Use WhiteSpace Name Description	clm62379:DateTimePeriodFormatCode 1 .. 3 required collapse Date or time or period format code Code specifying the representation of a date, time or period.
Applicable Codes		
102	CCYYMMDD	Calendar date: C = Century ; Y = Year ; M = Month ; D = Day.
304	CCYYMMDDHHMMSSZZ	See 204 plus Z=Time zone.
602	CCYY	Calendar year including century: C = Century; Y = Year.
ID	Occurrence Type WhiteSpace	1 .. 1 ds:AdditionalDocumentIdentificationIDType collapse

	Format	an..35
	eTIR name	Number
	Status	R
<i>schemeID</i>	Type	xs:token
	Use	optional
	WhiteSpace	collapse
<i>schemeAgencyID</i>	Type	clm63055:AgencyIdentificationCodeContentType
	Length	1 .. 3
	Use	optional
	WhiteSpace	collapse
TypeCode	Occurrence	1 .. 1
	Type	ds:AdditionalDocumentTypeCodeType
	WhiteSpace	collapse
	Format	an..3
	eTIR name	Type, coded
	Code List	06 Document name code
	Status	R
<i>listID</i>	Type	xs:token
	Use	optional
	WhiteSpace	collapse
<i>listAgencyID</i>	Type	clm63055:AgencyIdentificationCodeContentType
	Length	1 .. 3
	Use	optional
	WhiteSpace	collapse
ConsignmentItem	Occurrence	1 .. unbounded
	eTIR name	ConsignmentItem
	Status	R
<i>xs:sequence</i>	Occurrence	1 .. 1
SequenceNumeric	Occurrence	1 .. 1
	Type	ds:ConsignmentItemSequenceNumericType
	Format	n..5
	eTIR name	Sequence number
	Status	R
AdditionalInformation	Occurrence	0 .. unbounded
	eTIR name	AdditionalInformation
	Status	O
<i>xs:sequence</i>	Occurrence	1 .. 1
Content	Occurrence	1 .. 1
	Type	ds:AdditionalInformationContentTextType
	Format	an..512
	eTIR name	Remarks
	Status	R
<i>languageID</i>	Type	xs:language
	Use	optional
	Pattern	([a-zA-Z]{2} [il]-[a-zA-Z]+ [xX]-[a-zA-Z]{1,8})-([a-zA-Z]{1,8})*
	WhiteSpace	collapse
Commodity	Occurrence	1 .. 1
	eTIR name	Goods
	Status	R
<i>xs:sequence</i>	Occurrence	1 .. 1
CargoDescription	Occurrence	0 .. 1
	Type	ds:CommodityCargoDescriptionTextType
	Format	an..256
	eTIR name	Description
	Status	D
	Condition	C004
<i>languageID</i>	Type	xs:language
	Use	optional
	Pattern	([a-zA-Z]{2} [il]-[a-zA-Z]+ [xX]-[a-zA-Z]{1,8})-([a-zA-Z]{1,8})*
	WhiteSpace	collapse
Classification	Occurrence	0 .. unbounded
	eTIR name	Classification
	Status	O

xs:sequence	Occurrence	1 .. 1
ID	Occurrence	0 .. 1
	Type	ds:ClassificationIdentificationIDType
	WhiteSpace	collapse
	Format	an..18
	eTIR name	Code
	Status	O
schemeID	Type	xs:token
	Use	optional
	WhiteSpace	collapse
schemeAgencyID	Type	clm63055:AgencyIdentificationCodeContentType
	Length	1 .. 3
	Use	optional
	WhiteSpace	collapse
IdentificationTypeCode	Occurrence	1 .. 1
	Type	ds:ClassificationIdentificationTypeCodeType
	WhiteSpace	collapse
	Format	an..3
	eTIR name	Type
	Code List	CL03 Item type identification code
	Status	R
listID	Type	xs:token
	Use	optional
	WhiteSpace	collapse
listAgencyID	Type	clm63055:AgencyIdentificationCodeContentType
	Length	1 .. 3
	Use	optional
	WhiteSpace	collapse
Consignee	Occurrence	0 .. 1
	eTIR name	Consignee
	Status	O
xs:sequence	Occurrence	1 .. 1
Name	Occurrence	0 .. 1
	Type	ds:ConsigneeNameTextType
	Format	an..70
	eTIR name	Name
	Status	D
	Condition	C001
languageID	Type	xs:language
	Use	optional
	Pattern	([a-zA-Z]{2} [iI]-[a-zA-Z]+ [xX]-[a-zA-Z]{1,8})-([a-zA-Z]{1,8})*
	WhiteSpace	collapse
ID	Occurrence	0 .. 1
	Type	ds:ConsigneeIdentificationIDType
	WhiteSpace	collapse
	Format	an..17
	eTIR name	Code
	Status	D
	Condition	C001
schemeID	Type	xs:token
	Use	optional
	WhiteSpace	collapse
schemeAgencyID	Type	clm63055:AgencyIdentificationCodeContentType
	Length	1 .. 3
	Use	optional
	WhiteSpace	collapse
Address	Occurrence	0 .. 1
	eTIR name	Address
	Status	D
	Condition	C001
xs:sequence	Occurrence	1 .. 1
CityName	Occurrence	1 .. 1
	Type	ds:AddressCityNameTextType
	Format	an..35

		eTIR name	City name
		Status	R
		Type	xs:language
		Use	optional
		Pattern	([a-zA-Z]{2} [iI]-[a-zA-Z]+ [xX]-[a-zA-Z]{1,8})-[a-zA-Z]{1,8})*
		WhiteSpace	collapse
	CountryCode	Occurrence	1 .. 1
		Type	ds:AddressCountryCodeType
		WhiteSpace	collapse
		Format	a2
		Code List	CL04 Country name code
		eTIR name	Country, coded
		Status	R
	listID	Type	xs:token
		Use	optional
		WhiteSpace	collapse
	listAgencyID	Type	clm63055:AgencyIdentificationCodeContentType
		Length	1 .. 3
		Use	optional
		WhiteSpace	collapse
	Line	Occurrence	1 .. 1
		Type	ds:AddressLineTextType
		Format	an..70
		eTIR name	Street and number/P.O. Box
		Status	R
	languageID	Type	xs:language
		Use	optional
		Pattern	([a-zA-Z]{2} [iI]-[a-zA-Z]+ [xX]-[a-zA-Z]{1,8})-[a-zA-Z]{1,8})*
		WhiteSpace	collapse
	PostcodeID	Occurrence	1 .. 1
		Type	ds:AddressPostcodeIDType
		WhiteSpace	collapse
		Format	an..9
		eTIR name	Postcode identification
		Status	R
	schemeID	Type	xs:token
		Use	optional
		WhiteSpace	collapse
	schemeAgencyID	Type	clm63055:AgencyIdentificationCodeContentType
		Length	1 .. 3
		Use	optional
		WhiteSpace	collapse
	Consignor	Occurrence	0 .. 1
		eTIR name	Consignor
		Status	O
	xs:sequence	Occurrence	1 .. 1
	Name	Occurrence	0 .. 1
		Type	ds:ConsignorNameTextType
		Format	an..70
		eTIR name	Name
		Status	D
		Condition	C001
	languageID	Type	xs:language
		Use	optional
		Pattern	([a-zA-Z]{2} [iI]-[a-zA-Z]+ [xX]-[a-zA-Z]{1,8})-[a-zA-Z]{1,8})*
		WhiteSpace	collapse
	ID	Occurrence	0 .. 1
		Type	ds:ConsignorIdentificationIDType
		WhiteSpace	collapse
		Format	an..17
		eTIR name	Code
		Status	D

	<i>Condition</i>	C001
	<i>Type</i>	xs:token
	<i>Use</i>	optional
	<i>WhiteSpace</i>	collapse
	<i>Condition</i>	C001
	<i>Type</i>	clm63055:AgencyIdentificationCodeContentType
	<i>Length</i>	1 .. 3
	<i>Use</i>	optional
	<i>WhiteSpace</i>	collapse
Address	<i>Occurrence</i>	0 .. unbounded
	<i>eTIR name</i>	Address
	<i>Status</i>	D
	<i>Condition</i>	C001
	<i>Occurrence</i>	1 .. 1
<i>xs:sequence</i>	<i>Occurrence</i>	1 .. 1
CityName	<i>Type</i>	ds:AddressCityNameTextType
	<i>Format</i>	an..35
	<i>eTIR name</i>	City name
	<i>Status</i>	R
	<i>Type</i>	xs:language
	<i>Use</i>	optional
	<i>Pattern</i>	([a-zA-Z]{2})[iI]-[a-zA-Z]+ [xX]-[a-zA-Z]{1,8}){1,8})*
	<i>WhiteSpace</i>	collapse
	<i>Occurrence</i>	1 .. 1
	<i>Type</i>	ds:AddressCountryCodeType
	<i>WhiteSpace</i>	collapse
	<i>Format</i>	a2
	<i>Code List</i>	CL04 Country name code
	<i>eTIR name</i>	Country, coded
	<i>Status</i>	R
	<i>Type</i>	xs:token
	<i>Use</i>	optional
	<i>WhiteSpace</i>	collapse
	<i>Type</i>	clm63055:AgencyIdentificationCodeContentType
	<i>Length</i>	1 .. 3
	<i>Use</i>	optional
	<i>WhiteSpace</i>	collapse
Line	<i>Occurrence</i>	1 .. 1
	<i>Type</i>	ds:AddressLineTextType
	<i>Format</i>	an..70
	<i>eTIR name</i>	Street and number/P.O. Box
	<i>Status</i>	R
	<i>Type</i>	xs:language
	<i>Use</i>	optional
	<i>Pattern</i>	([a-zA-Z]{2})[iI]-[a-zA-Z]+ [xX]-[a-zA-Z]{1,8}){1,8})*
	<i>WhiteSpace</i>	collapse
	<i>Occurrence</i>	1 .. 1
	<i>Type</i>	ds:AddressPostcodeIDType
	<i>WhiteSpace</i>	collapse
	<i>Format</i>	an..9
	<i>eTIR name</i>	Postcode identification
	<i>Status</i>	R
	<i>Type</i>	xs:token
	<i>Use</i>	optional
	<i>WhiteSpace</i>	collapse
	<i>Type</i>	clm63055:AgencyIdentificationCodeContentType
	<i>Length</i>	1 .. 3
	<i>Use</i>	optional
	<i>WhiteSpace</i>	collapse
DeliveryDestination	<i>Occurrence</i>	1 .. 1
	<i>eTIR name</i>	DeliveryDestination
	<i>Status</i>	R
	<i>Occurrence</i>	1 .. 1

Name	Occurrence 1 .. 1 Type ds:DeliveryDestinationNameTextType Format an..70 eTIR name Name Status R
<i>languageID</i>	Type xs:language Use optional Pattern ([a-zA-Z]{2} [iI]-[a-zA-Z]+ [xX]-[a-zA-Z]{1,8})-[a-zA-Z]{1,8})* WhiteSpace collapse
Address	Occurrence 1 .. 1 eTIR name Address Status R
xs:sequence	Occurrence 1 .. 1
CityName	Occurrence 1 .. 1 Type ds:AddressCityNameTextType Format an..35 eTIR name City name Status R
<i>languageID</i>	Type xs:language Use optional Pattern ([a-zA-Z]{2} [iI]-[a-zA-Z]+ [xX]-[a-zA-Z]{1,8})-[a-zA-Z]{1,8})* WhiteSpace collapse
CountryCode	Occurrence 1 .. 1 Type ds:AddressCountryCodeType WhiteSpace collapse Format a2 Code List CL04 Country name code eTIR name Country, coded Status R
<i>listID</i>	Type xs:token Use optional WhiteSpace collapse
<i>listAgencyID</i>	Type clm63055:AgencyIdentificationCodeContentType Length 1 .. 3 Use optional WhiteSpace collapse
Line	Occurrence 1 .. 1 Type ds:AddressLineTextType Format an..70 eTIR name Street and number/P.O. Box Status R
<i>languageID</i>	Type xs:language Use optional Pattern ([a-zA-Z]{2} [iI]-[a-zA-Z]+ [xX]-[a-zA-Z]{1,8})-[a-zA-Z]{1,8})* WhiteSpace collapse
PostcodeID	Occurrence 1 .. 1 Type ds:AddressPostcodeIDType WhiteSpace collapse Format an..9 eTIR name Postcode identification Status R
<i>schemeID</i>	Type xs:token Use optional WhiteSpace collapse
<i>schemeAgencyID</i>	Type clm63055:AgencyIdentificationCodeContentType Length 1 .. 3 Use optional WhiteSpace collapse
GoodsMeasure	Occurrence 1 .. 1 eTIR name GoodsMeasure Status R
xs:sequence	Occurrence 1 .. 1

GrossMassMeasure	Occurrence	1 .. 1	
	Type	ds:GoodsMeasureGrossMassMeasureType	
	Format	n..16,6	
	eTIR name	Gross weight	
	Status	R	
<i>unitCode</i>	Type	clm6Recommendation20: MeasurementUnitCommonCodeContentType	
	Length	1 .. 3	
	Use	required	
	WhiteSpace	collapse	
Packaging	Occurrence	1 .. 1	
	eTIR name	Packaging	
	Status	R	
<i>xs:sequence</i>	Occurrence	1 .. 1	
MarksNumbersID	Occurrence	1 .. 1	
	Type	ds:PackagingMarksNumbersIDType	
	WhiteSpace	collapse	
	Format	an..512	
	eTIR name	Marks and numbers	
	Status	R	
<i>schemeID</i>	Type	xs:token	
	Use	optional	
	WhiteSpace	collapse	
<i>schemeAgencyID</i>	Type	clm63055:AgencyIdentificationCodeContentType	
	Length	1 .. 3	
	Use	optional	
	WhiteSpace	collapse	
QuantityQuantity	Occurrence	1 .. 1	
	Type	ds:PackagingQuantityQuantityType	
	Format	n..8	
	eTIR name	Number of packages	
	Status	R	
<i>unitCode</i>	Type	clm6Recommendation20: MeasurementUnitCommonCodeContentType	
	Length	1 .. 3	
	Use	required	
	WhiteSpace	collapse	
TypeCode	Occurrence	1 .. 1	
	Type	ds:PackagingTypeCodeType	
	WhiteSpace	collapse	
	Format	an..2	
	eTIR name	Type, coded	
	Code List	CL07	Package type description code
	Status	R	
<i>listID</i>	Type	xs:token	
	Use	optional	
	WhiteSpace	collapse	
<i>listAgencyID</i>	Type	clm63055:AgencyIdentificationCodeContentType	
	Length	1 .. 3	
	Use	optional	
	WhiteSpace	collapse	
TransportEquipment	Occurrence	0 .. 1	
	eTIR name	TransportEquipment	
	Status	D	
	Condition	C003	
<i>xs:sequence</i>	Occurrence	1 .. 1	
ID	Occurrence	1 .. 1	
	Type	ds:TransportEquipmentIdentificationIDType	
	WhiteSpace	collapse	
	Format	an..17	
	eTIR name	Identification	
	Status	R	
<i>schemeID</i>	Type	xs:token	
	Use	optional	
	WhiteSpace	collapse	

<ul style="list-style-type: none"> └─ <i>schemeAgencyID</i> 	<p>Type cim63055:AgencyIdentificationCodeContentType Length 1 .. 3 Use optional WhiteSpace collapse</p>
<ul style="list-style-type: none"> └─ UCR 	<p>Occurrence 0 .. unbounded eTIR name UCR Status O</p>
<ul style="list-style-type: none"> └─ xs:sequence <ul style="list-style-type: none"> └─ ID 	<p>Occurrence 1 .. 1 Occurrence 1 .. 1 Type ds:UCRIdentificationIDType WhiteSpace collapse Format an..35 eTIR name Identifier Status R</p>
<ul style="list-style-type: none"> └─ <i>schemeID</i> 	<p>Type xs:token Use optional WhiteSpace collapse</p>
<ul style="list-style-type: none"> └─ <i>schemeAgencyID</i> 	<p>Type cim63055:AgencyIdentificationCodeContentType Length 1 .. 3 Use optional WhiteSpace collapse</p>
<ul style="list-style-type: none"> └─ LoadingLocation 	<p>Occurrence 0 .. 1 eTIR name LoadingLocation Status O</p>
<ul style="list-style-type: none"> └─ xs:sequence <ul style="list-style-type: none"> └─ Name 	<p>Occurrence 1 .. 1 Occurrence 1 .. 1 Type ds>LoadingLocationNameTextType Format an..256 eTIR name Name Status R</p>
<ul style="list-style-type: none"> └─ <i>languageID</i> 	<p>Type xs:language Use optional Pattern ([a-zA-Z]{2} [iI]-[a-zA-Z]+ [xX]-[a-zA-Z]{1,8}){1,8}) WhiteSpace collapse</p>
<ul style="list-style-type: none"> └─ NotifyParty 	<p>Occurrence 0 .. 1 eTIR name NotifyParty Status O</p>
<ul style="list-style-type: none"> └─ xs:sequence <ul style="list-style-type: none"> └─ Name 	<p>Occurrence 1 .. 1 Occurrence 0 .. 1 Type ds>NotifyPartyNameTextType Format an..70 eTIR name Name Status D Condition C001</p>
<ul style="list-style-type: none"> └─ <i>languageID</i> 	<p>Type xs:language Use optional Pattern ([a-zA-Z]{2} [iI]-[a-zA-Z]+ [xX]-[a-zA-Z]{1,8}){1,8}) WhiteSpace collapse</p>
<ul style="list-style-type: none"> └─ ID 	<p>Occurrence 0 .. 1 Type ds>NotifyPartyIdentificationIDType WhiteSpace collapse Format an..17 eTIR name Code Status D Condition C001</p>
<ul style="list-style-type: none"> └─ <i>schemeID</i> 	<p>Type xs:token Use optional WhiteSpace collapse</p>
<ul style="list-style-type: none"> └─ <i>schemeAgencyID</i> 	<p>Type cim63055:AgencyIdentificationCodeContentType Length 1 .. 3 Use optional WhiteSpace collapse</p>
<ul style="list-style-type: none"> └─ Address 	<p>Occurrence 0 .. 1</p>

	eTIR name	Address
	Status	D
	Condition	C001
xs:sequence	Occurrence	1 .. 1
CityName	Occurrence	1 .. 1
	Type	ds:AddressCityNameTextType
	Format	an..35
	eTIR name	City name
	Status	R
languageID	Type	xs:language
	Use	optional
	Pattern	([a-zA-Z]{2} [il]-[a-zA-Z]+ [xX]-[a-zA-Z]{1,8}){1,8}
	WhiteSpace	collapse
CountryCode	Occurrence	1 .. 1
	Type	ds:AddressCountryCodeType
	WhiteSpace	collapse
	Format	a2
	Code List	CL04 Country name code
	eTIR name	Country, coded
	Status	R
listID	Type	xs:token
	Use	optional
	WhiteSpace	collapse
listAgencyID	Type	clm63055:AgencyIdentificationCodeContentType
	Length	1 .. 3
	Use	optional
	WhiteSpace	collapse
Line	Occurrence	1 .. 1
	Type	ds:AddressLineTextType
	Format	an..70
	eTIR name	Street and number/P.O. Box
	Status	R
languageID	Type	xs:language
	Use	optional
	Pattern	([a-zA-Z]{2} [il]-[a-zA-Z]+ [xX]-[a-zA-Z]{1,8}){1,8}
	WhiteSpace	collapse
PostcodeID	Occurrence	1 .. 1
	Type	ds:AddressPostcodeIDType
	WhiteSpace	collapse
	Format	an..9
	eTIR name	Postcode identification
	Status	R
schemeID	Type	xs:token
	Use	optional
	WhiteSpace	collapse
schemeAgencyID	Type	clm63055:AgencyIdentificationCodeContentType
	Length	1 .. 3
	Use	optional
	WhiteSpace	collapse
TransitDeparture	Occurrence	1 .. 1
	eTIR name	CustomsOfficeOfDeparture
	Status	R
xs:sequence	Occurrence	1 .. 1
ID	Occurrence	1 .. 1
	Type	ds:TransitDepartureIdentificationIDType
	WhiteSpace	collapse
	Format	an..17
	eTIR name	Code
	Code List	CL13 Customs offices database (to be developed)
	Status	R

<i>schemeID</i>	Type Use WhiteSpace	xs:token optional collapse
<i>schemeAgencyID</i>	Type Length Use WhiteSpace	clm63055:AgencyIdentificationCodeContentType 1 .. 3 optional collapse
TransitDestination	Occurrence eTIR name Status	1 .. 1 CustomsOfficeOfDestination R
xs:sequence	Occurrence	1 .. 1
ID	Occurrence Type WhiteSpace Format eTIR name Code List Status	1 .. 1 ds:TransitDestinationIdentificationIDType collapse an..17 Code CL13 Customs offices database (to be developed) R
<i>schemeID</i>	Type Use WhiteSpace	xs:token optional collapse
<i>schemeAgencyID</i>	Type Length Use WhiteSpace	clm63055:AgencyIdentificationCodeContentType 1 .. 3 optional collapse
TransitTransportMeans	Occurrence eTIR name Status	1 .. unbounded TransportMeans R
xs:sequence	Occurrence	1 .. 1
ID	Occurrence Type WhiteSpace Format eTIR name Status	1 .. 1 ds:TransitTransportMeansIdentificationIDType collapse an..25 Identification R
<i>schemeID</i>	Type Use WhiteSpace	xs:token optional collapse
<i>schemeAgencyID</i>	Type Length Use WhiteSpace	clm63055:AgencyIdentificationCodeContentType 1 .. 3 optional collapse
TypeCode	Occurrence Type WhiteSpace Format eTIR name Code List Status	1 .. 1 ds:TransitTransportMeansTypeCodeType collapse an..4 Type, coded CL05 Transport means description code R
<i>listID</i>	Type Use WhiteSpace	xs:token optional collapse
<i>listAgencyID</i>	Type Length Use WhiteSpace	clm63055:AgencyIdentificationCodeContentType 1 .. 3 optional collapse
RegistrationNationalityCode	Occurrence Type WhiteSpace Format eTIR name Code List Status	1 .. 1 ds: TransitTransportMeansRegistrationNationalityCodeType collapse a2 Nationality CL04 Country name code R

<i>listID</i>	Type Use WhiteSpace	xs:token optional collapse
<i>listAgencyID</i>	Type Length Use WhiteSpace	clm63055:AgencyIdentificationCodeContentType 1 .. 3 optional collapse
JourneyID	Occurrence Type WhiteSpace Format eTIR name Status	0 .. 1 ds:TransitTransportMeansJourneyIDType collapse an..17 Conveyance reference number O
<i>schemeID</i>	Type Use WhiteSpace	xs:token optional collapse
<i>schemeAgencyID</i>	Type Length Use WhiteSpace	clm63055:AgencyIdentificationCodeContentType 1 .. 3 optional collapse
Itinerary	Occurrence eTIR name Rule Status	1 .. unbounded CountryOfRouting R001 R
xs:sequence	Occurrence	1 .. 1
SequenceNumeric	Occurrence Type Format Status	1 .. 1 ds:ItinerarySequenceNumericType n..5 R
RoutingCountryCode	Occurrence Type WhiteSpace Format eTIR name Code List Status	1 .. 1 ds:ItineraryRoutingCountryCodeType collapse a2 Country, coded CL04 Country name code R
<i>listID</i>	Type Use WhiteSpace	xs:token optional collapse
<i>listAgencyID</i>	Type Length Use WhiteSpace	clm63055:AgencyIdentificationCodeContentType 1 .. 3 optional collapse
AdditionalDocument	Occurrence eTIR name Status	0 .. 1 CertificateOfApproval O
xs:sequence	Occurrence	1 .. 1
IssueDateTime	Occurrence Type WhiteSpace Format eTIR name Status	1 .. 1 ds:AdditionalDocumentIssueDateTimeType collapse an..17 Date R
<i>formatCode</i>	Type Length Use WhiteSpace Name Description	clm62379:DateTimePeriodFormatCode 1 .. 3 required collapse Date or time or period format code Code specifying the representation of a date, time or period.
Applicable Codes		
102	CCYYMMDD	Calendar date: C = Century ; Y = Year ; M = Month ; D = Day.

	304	CCYYMMDDHHMMSSZZ See 204 plus Z=Time zone.
	602	CCYY Calendar year including century: C = Century; Y = Year.
ID	Occurrence	1 .. 1
	Type	ds:AdditionalDocumentIdentificationIDType
	WhiteSpace	collapse
	Format	an..35
	eTIR name	Number
	Status	R
<i>schemeID</i>	Type	xs:token
	Use	optional
	WhiteSpace	collapse
<i>schemeAgencyID</i>	Type	clm63055:AgencyIdentificationCodeContentType
	Length	1 .. 3
	Use	optional
	WhiteSpace	collapse
TypeCode	Occurrence	1 .. 1
	Type	ds:AdditionalDocumentTypeCodeType
	WhiteSpace	collapse
	Format	an..3
	eTIR name	Type, coded
	Code List	CL06 Document name code
	Status	R
<i>listID</i>	Type	xs:token
	Use	optional
	WhiteSpace	collapse
<i>listAgencyID</i>	Type	clm63055:AgencyIdentificationCodeContentType
	Length	1 .. 3
	Use	optional
	WhiteSpace	collapse
TransportEquipment	Occurrence	0 .. unbounded
	eTIR name	TransportEquipment
	Status	D
	Condition	C003
<i>xs:sequence</i>	Occurrence	1 .. 1
SequenceNumeric	Occurrence	1 .. 1
	Type	ds:TransportEquipmentSequenceNumericType
	Format	n..5
	eTIR name	Sequence number
	Status	R
CharacteristicCode	Occurrence	1 .. 1
	Type	ds:TransportEquipmentCharacteristicCodeType
	WhiteSpace	collapse
	Format	an..4
	eTIR name	Size and type identification
	Code List	CL01 Equipment size and type description code
	Status	R
<i>listID</i>	Type	xs:token
	Use	optional
	WhiteSpace	collapse
<i>listAgencyID</i>	Type	clm63055:AgencyIdentificationCodeContentType
	Length	1 .. 3
	Use	optional
	WhiteSpace	collapse
ID	Occurrence	1 .. 1
	Type	ds:TransportEquipmentIdentificationIDType
	WhiteSpace	collapse
	Format	an..17
	eTIR name	Identification
	Status	R
<i>schemeID</i>	Type	xs:token
	Use	optional
	WhiteSpace	collapse

<i>schemeAgencyID</i>	Type	clm63055:AgencyIdentificationCodeContentType
	Length	1 .. 3
	Use	optional
	WhiteSpace	collapse
Seal	Occurrence	0 .. unbounded
	eTIR name	Seal
	Status	O
xs:sequence	Occurrence	1 .. 1
SequenceNumeric	Occurrence	1 .. 1
	Type	ds:SealSequenceNumericType
	Format	n..5
	eTIR name	Sequence number
	Status	R
	Rule	R003
	Rule	R004
ID	Occurrence	1 .. 1
	Type	ds:SealIdentificationIDType
	WhiteSpace	collapse
	Format	an..35
	eTIR name	Seal number
	Status	R
	Rule	R005
<i>schemeID</i>	Type	xs:token
	Use	optional
	WhiteSpace	collapse
<i>schemeAgencyID</i>	Type	clm63055:AgencyIdentificationCodeContentType
	Length	1 .. 3
	Use	optional
	WhiteSpace	collapse
TypeCode	Occurrence	0 .. 1
	Type	ds:SealTypeCodeType
	WhiteSpace	collapse
	Format	an..3
	eTIR name	Seal type code
	Status	O
<i>listID</i>	Type	xs:token
	Use	optional
	WhiteSpace	collapse
<i>listAgencyID</i>	Type	clm63055:AgencyIdentificationCodeContentType
	Length	1 .. 3
	Use	optional
	WhiteSpace	collapse
TransitPrincipal	Occurrence	1 .. 1
	eTIR name	Holder
	Status	R
xs:sequence	Occurrence	1 .. 1
Name	Occurrence	0 .. 1
	Type	ds:TransitPrincipalNameTextType
	Format	an..70
	eTIR name	Name
	Status	O
<i>languageID</i>	Type	xs:language
	Use	optional
	Pattern	([a-zA-Z]{2} [iI]-[a-zA-Z]+ [xX]-[a-zA-Z]{1,8})-([a-zA-Z]{1,8})*
	WhiteSpace	collapse
ID	Occurrence	1 .. 1
	Type	ds:TransitPrincipalIdentificationIDType
	WhiteSpace	collapse
	Format	an..17
	eTIR name	Code
	Code List	CL15 International TIR database
	Status	R

<i>schemaID</i>	Type Use WhiteSpace	xs:token optional collapse
<i>schemaAgencyID</i>	Type Length Use WhiteSpace	clm63055:AgencyIdentificationCodeContentType 1 .. 3 optional collapse
Address	Occurrence eTIR name Status	0 .. 1 Address O
xs:sequence	Occurrence	1 .. 1
CityName	Occurrence Type Format eTIR name Status	1 .. 1 ds:AddressCityNameTextType an..35 City name R
<i>languageID</i>	Type Use Pattern WhiteSpace	xs:language optional ([a-zA-Z]{2} [lI]-[a-zA-Z]+ [xX]-[a-zA-Z]{1,8})-[a-zA-Z]{1,8}) [*] collapse
CountryCode	Occurrence Type WhiteSpace Format Code List eTIR name Status	1 .. 1 ds:AddressCountryCodeType collapse a2 CL04 Country name code Country, coded R
<i>listID</i>	Type Use WhiteSpace	xs:token optional collapse
<i>listAgencyID</i>	Type Length Use WhiteSpace	clm63055:AgencyIdentificationCodeContentType 1 .. 3 optional collapse
Line	Occurrence Type Format eTIR name Status	1 .. 1 ds:AddressLineTextType an..70 Street and number/P.O. Box R
<i>languageID</i>	Type Use Pattern WhiteSpace	xs:language optional ([a-zA-Z]{2} [lI]-[a-zA-Z]+ [xX]-[a-zA-Z]{1,8})-[a-zA-Z]{1,8}) [*] collapse
PostcodeID	Occurrence Type WhiteSpace Format eTIR name Status	1 .. 1 ds:AddressPostcodeIDType collapse an..9 Postcode identification R
<i>schemelD</i>	Type Use WhiteSpace	xs:token optional collapse
<i>schemaAgencyID</i>	Type Length Use WhiteSpace	clm63055:AgencyIdentificationCodeContentType 1 .. 3 optional collapse
DeclarationGuarantee	Occurrence eTIR name Status	1 .. 1 Guarantee R
xs:sequence	Occurrence	1 .. 1
ReferenceID	Occurrence Type WhiteSpace	1 .. 1 ds:DeclarationGuaranteeReferenceIDType collapse

<i>schemeID</i>	Format eTIR name Status Type Use WhiteSpace	an..35 Reference R xs:token optional collapse
<i>schemeAgencyID</i>	Type Length Use WhiteSpace	clm63055:AgencyIdentificationCodeContentType 1 .. 3 optional collapse
LPCOExpirationDateTime	Occurrence Type WhiteSpace Format eTIR name Status	1 .. 1 ds:DeclarationGuaranteeLPCOExpirationDateTimeType collapse n..17 Validity R
<i>formatCode</i>	Type Length Use WhiteSpace Name Description	clm62379:DateTimePeriodFormatCode 1 .. 3 required collapse Date or time or period format code Code specifying the representation of a date, time or period.
	Applicable Codes	
	102	CCYYMMDD Calendar date: C = Century ; Y = Year ; M = Month ; D = Day.
	304	CCYYMMDDHHMMSSZZZ See 204 plus Z=Time zone.
	602	CCYY Calendar year including century: C = Century; Y = Year.
SecurityDetailsCode	Occurrence Type WhiteSpace Format eTIR name Code List Status	1 .. 1 ds:DeclarationGuaranteeSecurityDetailsCodeType collapse an..3 Guarantee type, coded CL12 Guarantee type code R
<i>listID</i>	Type Use WhiteSpace	xs:token optional collapse
<i>listAgencyID</i>	Type Length Use WhiteSpace	clm63055:AgencyIdentificationCodeContentType 1 .. 3 optional collapse

4.2.3.1.2.16. I16 – Notification confirmation

a. Structure

Occurance	Element/Attribute
1 .. 1	Message
1 .. 1	xs:sequence
optional	TypeCode
optional	<i>listID</i>
optional	<i>listAgencyID</i>
1 .. 1	ReferenceNumberID
optional	<i>schemeID</i>
optional	<i>schemeAgencyID</i>
1 .. 1	FunctionCode
optional	<i>listID</i>
optional	<i>listAgencyID</i>
1 .. 1	FunctionalReferenceID

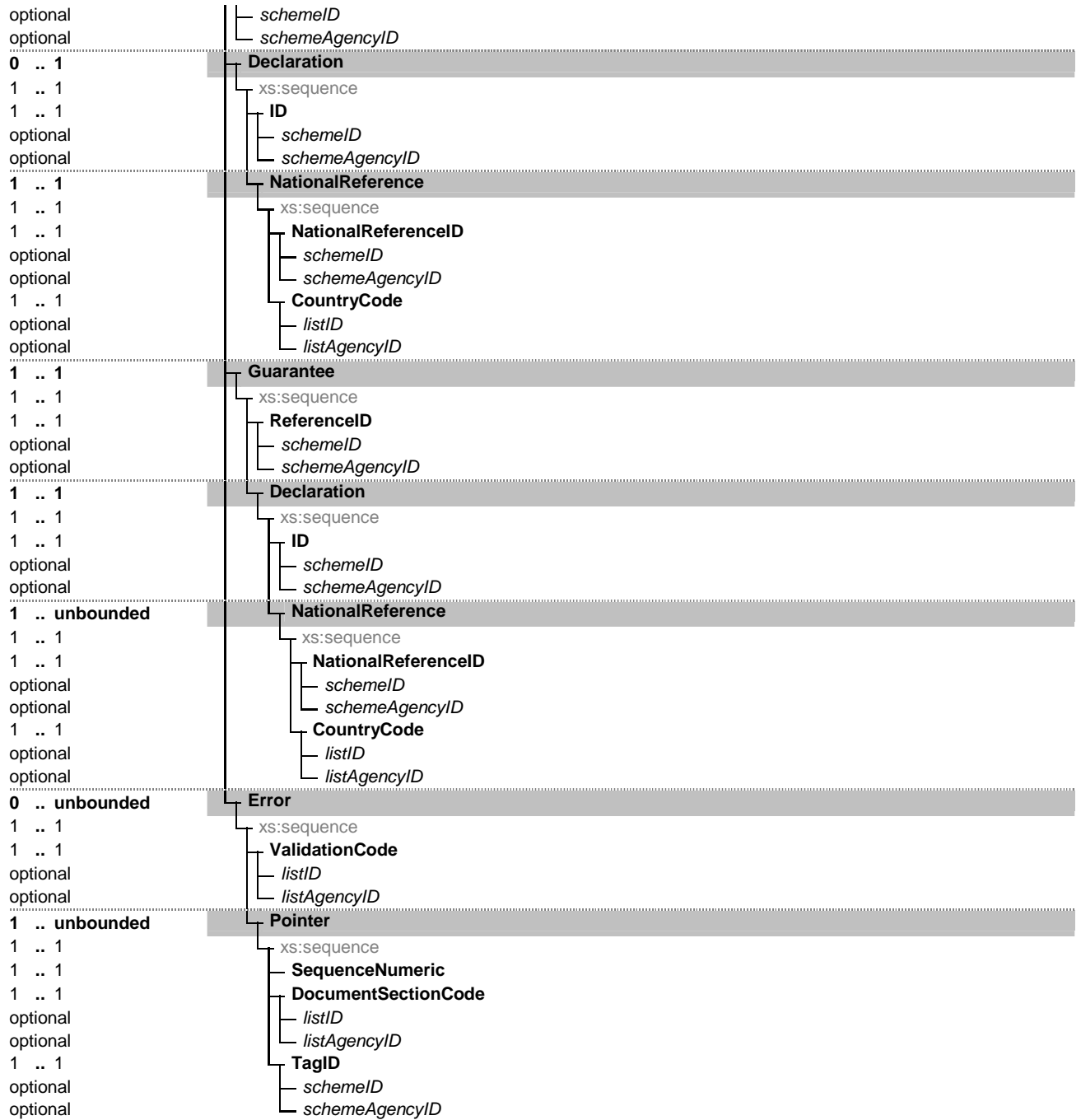

b. Guidelines

Element/Attribute	Annotation
Message	
<i>xs:sequence</i>	eTIR name Message
TypeCode	Occurrence 1..1
	Occurrence 1..1
	Type ds:MessageTypeCodeType
	WhiteSpace collapse
	Format an..3
	eTIR name Type, coded

	Status	R	
	Code List	CL26	Message types
	Restricted code(s)	I16	Notification confirmation
<i>listID</i>	Type	xs:token	
	Use	optional	
	WhiteSpace	collapse	
<i>listAgencyID</i>	Type	clm63055:AgencyIdentificationCodeContentType	
	Length	1 .. 3	
	Use	optional	
	WhiteSpace	collapse	
ReferenceNumberID	Occurrence	1 .. 1	
	Type	ds:MessageReferenceNumberIDType	
	WhiteSpace	collapse	
	Format	an..14	
	eTIR name	Message reference number	
	Status	R	
<i>schemeID</i>	Type	xs:token	
	Use	optional	
	WhiteSpace	collapse	
<i>schemeAgencyID</i>	Type	clm63055:AgencyIdentificationCodeContentType	
	Length	1 .. 3	
	Use	optional	
	WhiteSpace	collapse	
FunctionCode	Occurrence	1 .. 1	
	Type	ds:MessageFunctionCodeType	
	WhiteSpace	collapse	
	Format	n..2	
	eTIR name	Message function, coded	
	Code List	CL16	Message function code
	Status	R	
	Restricted code(s)	6	Confirmation
	Restricted code(s)	27	Not accepted
<i>listID</i>	Type	xs:token	
	Use	optional	
	WhiteSpace	collapse	
<i>listAgencyID</i>	Type	clm63055:AgencyIdentificationCodeContentType	
	Length	1 .. 3	
	Use	optional	
	WhiteSpace	collapse	
FunctionalReferenceID	Occurrence	1 .. 1	
	Type	ds:MessageFunctionalReferenceIDType	
	WhiteSpace	collapse	
	Format	an..35	
	eTIR name	Functional reference	
	Status	R	
<i>schemeID</i>	Type	xs:token	
	Use	optional	
	WhiteSpace	collapse	
<i>schemeAgencyID</i>	Type	clm63055:AgencyIdentificationCodeContentType	
	Length	1 .. 3	
	Use	optional	
	WhiteSpace	collapse	
Declaration	Occurrence	0 .. 1	
	eTIR name	AdvancedCargoInformation	
	Status	O	
	Rule	R002	
<i>xs:sequence</i>	Occurrence	1 .. 1	
ID	Occurrence	1 .. 1	
	Type	ds:DeclarationIdentificationIDType	
	WhiteSpace	collapse	
	Format	an..35	
	eTIR name	Reference	

	Status	R
<i>schemeID</i>	Type	xs:token
	Use	optional
	WhiteSpace	collapse
<i>schemeAgencyID</i>	Type	clm63055:AgencyIdentificationCodeContentType
	Length	1 .. 3
	Use	optional
	WhiteSpace	collapse
NationalReference	Occurrence	1 .. 1
	eTIR name	NationalReference
	Status	R
xs:sequence	Occurrence	1 .. 1
NationalReferenceID	Occurrence	1 .. 1
	Type	ds:NationalReferenceNationalReferenceIDType
	WhiteSpace	collapse
	Format	an..35
	eTIR name	Reference
	Status	R
<i>schemeID</i>	Type	xs:token
	Use	optional
	WhiteSpace	collapse
<i>schemeAgencyID</i>	Type	clm63055:AgencyIdentificationCodeContentType
	Length	1 .. 3
	Use	optional
	WhiteSpace	collapse
CountryCode	Occurrence	1 .. 1
	Type	ds:NationalReferenceCountryCodeType
	WhiteSpace	collapse
	Format	a2
	Code List	CL04 Country name code
	eTIR name	Country, coded
	Status	R
<i>listID</i>	Type	xs:token
	Use	optional
	WhiteSpace	collapse
<i>listAgencyID</i>	Type	clm63055:AgencyIdentificationCodeContentType
	Length	1 .. 3
	Use	optional
	WhiteSpace	collapse
Guarantee	Occurrence	1 .. 1
	eTIR name	Guarantee
	Status	R
xs:sequence	Occurrence	1 .. 1
ReferenceID	Occurrence	1 .. 1
	Type	ds:GuaranteeReferenceIDType
	WhiteSpace	collapse
	Format	an..35
	eTIR name	Reference
	Status	R
<i>schemeID</i>	Type	xs:token
	Use	optional
	WhiteSpace	collapse
<i>schemeAgencyID</i>	Type	clm63055:AgencyIdentificationCodeContentType
	Length	1 .. 3
	Use	optional
	WhiteSpace	collapse
Declaration	Occurrence	1 .. 1
	eTIR name	AdvancedCargoInformation
	Status	R
xs:sequence	Occurrence	1 .. 1
ID	Occurrence	1 .. 1
	Type	ds:DeclarationIdentificationIDType
	WhiteSpace	collapse
	Format	an..35
	eTIR name	Reference

<i>schemeID</i>	Status	R
	Type	xs:token
	Use	optional
	WhiteSpace	collapse
<i>schemeAgencyID</i>	Type	clm63055:AgencyIdentificationCodeContentType
	Length	1 .. 3
	Use	optional
	WhiteSpace	collapse
NationalReference	Occurrence	1 .. unbounded
	eTIR name	NationalReference
	Status	R
xs:sequence	Occurrence	1 .. 1
NationalReferenceID	Occurrence	1 .. 1
	Type	ds:NationalReferenceNationalReferenceIDType
	WhiteSpace	collapse
	Format	an..35
	eTIR name	Reference
	Status	R
<i>schemeID</i>	Type	xs:token
	Use	optional
	WhiteSpace	collapse
<i>schemeAgencyID</i>	Type	clm63055:AgencyIdentificationCodeContentType
	Length	1 .. 3
	Use	optional
	WhiteSpace	collapse
CountryCode	Occurrence	1 .. 1
	Type	ds:NationalReferenceCountryCodeType
	WhiteSpace	collapse
	Format	a2
	Code List	CL04 Country name code
	eTIR name	Country, coded
	Status	R
<i>listID</i>	Type	xs:token
	Use	optional
	WhiteSpace	collapse
<i>listAgencyID</i>	Type	clm63055:AgencyIdentificationCodeContentType
	Length	1 .. 3
	Use	optional
	WhiteSpace	collapse
Error	Occurrence	0 .. unbounded
	eTIR name	Error
	Status	D
	Condition	C006
xs:sequence	Occurrence	1 .. 1
ValidationCode	Occurrence	1 .. 1
	Type	ds:ErrorValidationCodeType
	WhiteSpace	collapse
	Format	an..8
	eTIR name	Error, coded
	Code List	CL99 Error code (to be developed)
	Status	R
<i>listID</i>	Type	xs:token
	Use	optional
	WhiteSpace	collapse
<i>listAgencyID</i>	Type	clm63055:AgencyIdentificationCodeContentType
	Length	1 .. 3
	Use	optional
	WhiteSpace	collapse
Pointer	Occurrence	1 .. unbounded
	eTIR name	Pointer
	Status	R
xs:sequence	Occurrence	1 .. 1
SequenceNumeric	Occurrence	1 .. 1
	Type	ds:PointerSequenceNumericType
	Format	n..5

DocumentSectionCode	eTIR name	Sequence number
	Status	R
	Occurrence	1 .. 1
	Type	ds:PointerDocumentSectionCodeType
	WhiteSpace	collapse
	Format	an..3
	eTIR name	Document/message section, coded
	Code List	CL18 Message section code (codes to be defined)
<i>listID</i>	Status	R
	Type	xs:token
	Use	optional
	WhiteSpace	collapse
<i>listAgencyID</i>	Type	clm63055:AgencyIdentificationCodeContentType
	Length	1 .. 3
	Use	optional
	WhiteSpace	collapse
TagID	Occurrence	1 .. 1
	Type	ds:PointerTagIDType
	WhiteSpace	collapse
	Format	an..4
	eTIR name	Tag identifier
	Code List	CL19 Pointer code (codes to be defined)
	Status	R
<i>schemeID</i>	Type	xs:token
	Use	optional
	WhiteSpace	collapse
<i>schemeAgencyID</i>	Type	clm63055:AgencyIdentificationCodeContentType
	Length	1 .. 3
	Use	optional
	WhiteSpace	collapse