



**Economic and Social
Council**

Distr.
GENERAL

TRANS/WP.30/GE.1/2005/1*
9 November 2005**

ENGLISH ONLY

ECONOMIC COMMISSION FOR EUROPE

INLAND TRANSPORT COMMITTEE

Working Party on Customs Questions affecting Transport

Informal Ad hoc Expert Group on Conceptual and
Technical aspects of Computerization of the TIR Procedure
(Eighth session, 14 and 15 November 2005, agenda item 3 (b))

ACTIVITIES OF THE INFORMAL AD HOC EXPERT GROUP

Reference Model of the TIR Procedure

Note by the secretariat

**REFERENCE MODEL FOR THE
TIR PROCEDURE COMPUTERIZATION PROJECT**

Note: This document presents the reference model for the TIR Procedure Computerization Project in accordance with the UN/CEFACT Modelling Methodology. The Reference Model will be expanded and refined as the work progresses and as feedback is received from modelling work carried out by the Informal ad hoc Expert Group on Conceptual and Technical Aspects of Computerization of the TIR Procedure.

SOURCE : *Informal ad hoc Expert Group on Conceptual and Technical Aspects of
Computerization of the TIR Procedure*
STATUS : *Working document*
VERSION : *1.5a*
ACTION : *For expansion and refinement*

* This document reference replaces reference ExG/COMP/2003/1, which was not in line with UN rules for referencing group of experts' documents.

** This document has already been circulated under the same quote number as a preliminary version but was dated 30 June 2005.

TABLE OF CONTENTS

0.	INTRODUCTION	4
0.1	Background to the document	4
0.2	Introduction to the reference model	8
0.2.1	Phases and Workflows	9
0.2.2	Step by step approach applied to the UMM	11
0.2.3	Structure and updating of the document	11
0.2.4	Stakeholders responsibility chart	13
0.2.5	Review and validation status	14
1.	BUSINESS DOMAIN MODELLING	15
1.1	Vision	16
1.1.1	Project title and abbreviation	16
1.1.2	Objectives	16
1.1.3	Boundary of the eTIR Project	17
Stakeholders	17	
Information	18	
1.1.4	Business Opportunity and Problem Statement	18
Technological developments in international transport, trade and Customs procedures	18	
Efficiency of the TIR Customs transit procedure	18	
The fight against fraudulent activities	20	
1.1.5	References	21
1.1.6	Scope of the project	21
1.1.7	Constraints	22
Technical constraints	22	
Political/legal constraints	23	
Financial / Economic constraints	23	
Other constraints	23	
1.1.8	Stakeholders' needs	23
Needs of Customs administrations	23	
EU: need of consignor data	24	
Needs of the transport industry	24	
1.2	TIR procedure domain	25
1.2.1	TIR Procedure package diagram	25
1.2.2	TIR Procedure package diagram description	26
1.3	TIR Carnet life cycle use cases	27
1.3.1	Actors of the TIR Carnet life cycle	27
International organizations and national associations	28	
Competent authorities	29	
TIR Carnet holder	30	
Administrative Committee of the TIR Convention (AC.2)	30	
1.3.2	TIR Carnet life cycle use case diagram	31
1.3.3	TIR Carnet life cycle use case description	31
1.3.4	High-level activity diagram of the TIR Carnet life cycle	32
1.4	Elaboration of use cases	33
1.4.1	Issuance and distribution use case	33
Issuance and distribution use case diagram	33	
Issuance and distribution use case description	34	
Activity diagram of the issuance and distribution use case	36	
1.4.2	TIR transport use case	37
TIR transport use case diagram	37	
TIR transport use case description	38	
Activity diagram of the TIR transport use case	40	

	Structured description of activity diagrams of the TIR transport use case	41
1.4.3	Return and repository use case	43
	Return and repository use case diagram	43
	Return and repository use case description.....	44
	Activity diagram of the return and repository use case	45
1.4.4	Discharge procedure use case	46
	Discharge procedure use case diagram	46
	Discharge procedure use case description	46
	Activity diagram of the discharge procedure use case.....	48
	Structured description of the activity diagram of the discharge use case	49
1.4.5	Start TIR operation use case	50
	Start TIR operation use case diagram	50
	Start TIR operation use case description	51
	Activity diagram of the start TIR operation use case.....	53
	Structured description of the activity diagram of the start TIR operation use case	54
1.4.6	Terminate TIR operation use case	55
	Terminate TIR operation use case diagram	55
	Terminate TIR operation use case description.....	56
	Activity diagram of the terminate TIR operation use case	59
1.5	Entity classes	62
1.6	High-level class diagram	63
1.6.1	High-level class diagram description.....	63
	International organization	63
	Association	64
	Road vehicle	65
	Sealed loading unit	66
	TIR transport.....	67
	TIR operation.....	69
	Goods Manifest Line Item	70
	Customs office	71
	Country	72
	TIR Carnet Holder	73
1.6.2	High-level class diagram	74
2.	E-BUSINESS REQUIREMENTS	75
3.	ANALYSIS WORKFLOW	76
4.	DESIGN WORKFLOW	77
	ANNEX 1 – REQUIREMENTS LIST	78
	ANNEX 2 – TIR GLOSSARY.....	81
	ANNEX 3 – UML.....	84
	UML symbols glossary.....	84
	Elaboration of a class diagram – TIR Operation example.....	86
	ANNEX 4 – UMM/UML GLOSSARY	89
	ANNEX 5 – LIST OF TABLES	98
	ANNEX 6 – LIST OF FIGURES	99
	ANNEX 7 – REFERENCES	100

0. Introduction

0.1 Background to the document

At its ninety-fifth session, the Working Party expressed the view that, following the conclusions of Phases I and II of the TIR revision process, the next logical step was to provide the TIR regime with the legal and administrative basis to allow for the use of modern information, management and control technology based on highly automated and secured electronic procedures. The Working Party recognized that computerization of the TIR procedure was inevitable (a) in the light of today's extremely rapid technological developments, based on Internet and Smart Card technologies, particularly affecting international transport and trade, (b) the ever increasing need for improved efficiency of Customs transit procedures and (c) the fight against fraudulent activities which must be conducted with the most appropriate and effective means (TRANS/WP.30/190, paragraph 26).

The Working Party felt that the existing and widely varying national Customs procedures, administrative practices and legal requirements in the Contracting parties to the Convention should be taken into account during this process. Computerization of the TIR procedure, based on the TIR regime as revised during Phases I and II of the TIR revision process, would therefore have to focus on the possibility of linking national Customs transit procedures via a standard electronic and/or paper-based data file containing all information of the TIR Carnet. The newly to be created electronic data file would need to be compatible with most if not all possible technical EDI solutions applied or yet to be applied in the Contracting Parties (TRANS/WP.30/190, paragraph 27).

The link between national Customs procedures and the transfer of data files should be possible via (a) international EDI systems, as is being done in the New Computerized Transit System (NCTS), (b) Smart Cards that could be filled-in and carried along by the transport operator as well as filled-in, read and validated by Customs authorities or (c) the present paper-based TIR Carnets, possibly supplemented by bar-code and TIR Carnet holder identification system (TRANS/WP.30/190, paragraph 28).

The Working Party was of the view that, whatever system is to be used, the approach taken in computerization of the TIR regime must be courageous and forward looking and should be able to accommodate all possible technological solutions likely to be implemented in the years ahead (TRANS/WP.30/190, paragraph 29).

In order to make solid progress in this complex field, the Working Party decided to follow established practice and to establish an ad hoc group of experts on the computerization of the TIR regime which should be composed of experts from interested countries and industry groups (TRANS/WP.30/190, paragraph 30).

The Working Party, at its ninety-sixth session, felt that the expert Group, after having highlighted weaknesses and limitations of the current system, should, in particular:

- identify the objectives, procedures and required resources for the computerization of the TIR procedure and determine the role of the various actors (secretariat, Governments, IRU, etc.) in this process;
- analyze all administrative and legal requirements relevant for the computerization of the TIR regime;
- study suitable technological solutions in this respect, and

- take account of experiences made with similar automated systems at the national as well as at subregional levels, such as the NCTS, with a view to preparing possible alternative solutions and scenarios, specifying the benefits as well as the disadvantages of the various approaches (TRANS/WP.30/192, paragraph 37).

The ad hoc Expert Group (hereafter referred to as “Ad hoc Group”) met twice in 2001, on 19 February and on 21 June.

With regard to the objectives of the computerization process, the Ad hoc Group decided that those identified by the Working Party at its ninety-fifth session had kept their validity (TRANS/WP.30/2001/13, paragraphs 13-14).

The Ad hoc Group reconsidered the fundamental approaches for computerization of the TIR procedure and agreed that, knowing that computerization of the TIR procedure was a continuing process, involving various stages of development, none of the options could be excluded for the time being. Efforts should be pursued at the national level to prepare the national Customs legislation for the acceptance of electronic data processing and interchange techniques and the electronic signature (TRANS/WP.30/2001/13, paragraphs 18-19).

The Ad hoc Group acknowledged that, regardless of the finally selected approach, from a legal point of view, the amount of changes to be made to the TIR Convention could be limited and that it would basically be sufficient to amend the Convention with either a definition of the TIR Carnet, that would include the use of portable electronic files or introduce one new article which would allow for the use of new technologies in general, including the acceptance of electronic signatures, leaving the existing text of the Convention as it stands. Special provisions dealing with the legal and technical specification of the accepted new technologies could be inserted into a separate, newly to be created Annex (TRANS/WP.30/2001/13, paragraph 23).

With regard to the role played by the various actors in the computerization process, the Ad hoc Group agreed that the computerization process would have consequences for the persons and organizations dealing with the issuance and organization and functioning of the guarantee system, as well as for Customs authorities, whose task it is to check and process the provided data and ensure the goods’ unaltered arrival at the Customs office of destination. In addition, the use of automated risk management would influence the work of Customs authorities and associations at the national level, as well as the work of the international organization, the insurers and the TIRExB. However, the Ad hoc Group felt that at that time it was not appropriate to pursue this subject, as it depended on a variety of, as yet unknown, factors (TRANS/WP.30/2001/13, paragraphs 26-27).

On the basis of the outcome of the work performed by the Ad hoc Group, the Working Party mandated the secretariat to convene meetings of special expert groups. These special groups should address the two major problems the Ad hoc Group had encountered in the pursuit of its work:

- To study the conceptual and technical aspects of the computerization process of the TIR Procedure, including the financial and administrative implications of its introduction, both at the national and at the international level, and prepare a draft of electronic messages to allow for an interchange of electronic data, nationally, between Contracting Parties and with international organizations;
- To study in detail the impact of the various approaches that had been identified by the Ad hoc Group on the existing legal text of the TIR Convention as well as the repercussions it could have on international private law, national administrative procedures and to draft a description of the role that the various actors (in particular: national associations, international organization, insurers and TIRExB) could play in the TIR Convention, once the paper-based system would be complemented and/or replaced by a system functioning

on the basis of the electronic interchange of information (TRANS/WP.30/2001/13, paragraph 31)

On the basis of this mandate, the Informal ad hoc Expert Group on Conceptual and Technical Aspects of Computerization of the TIR Procedure (hereafter referred to as "Expert Group"), at its first session, adopted its Terms of Reference, which stipulate that the Expert Group shall:

- List and analyse the data elements required for the operation of a TIR transport at the national and international level, as stipulated in the TIR Convention as well as in resolutions and recommendations, adopted by the Administrative Committee (in particular Annexes 1,4, and 9 of the TIR Convention) and make an inventory of possible new features which could be included into the electronic version of the TIR procedure. On that basis, the group shall draw up flow charts, reflecting the actual and future stages of the TIR procedure. Within the context of its work, the group shall also study the use of standardized codes, ensuring a uniform understanding and interpretation of the data elements in the TIR Carnet.
- List and analyse the existing information and telecommunication systems and study to what extent the experiences gained at the national and international level can be included in the development of a computerized TIR procedure.
- Prepare conclusions with regard to the computerization of the TIR procedure, reflecting the results of the work under (a) and (b) and taking account of the financial implications they might have on the national and international level (TRANS/WP.30/2002/11, Annex 1)

The Informal ad hoc Expert Group on the Legal Aspects of Computerization of the TIR Procedure shall:

- Study in detail the impact of the various approaches of the computerization process on the existing legal provisions of the TIR Convention as well as the repercussions it could have on national administrative procedures;
- Draft a description of the role the various actors (in particular: national association, international organization, insurers and TIRExB) could play in the TIR Convention, once the paper based system would be complemented and/or replaced by a system functioning on the basis of the electronic interchange of information (Terms of reference still to be adopted).

Both informal ad hoc Expert Groups shall report to the Working Party on the progress of their work. At the completion of its work, each ad hoc Expert Group shall draw up a working document containing concrete proposals for further action, to be discussed and approved by the Working Party.

At its second meeting, the informal ad hoc Expert Group on Conceptual and Technical Aspects of Computerization of the TIR Procedure discussed at length the conceptual and hierarchical data models, describing the information contained in the TIR Carnet, but felt it could not reach agreement on any of them. Some experts questioned the usefulness of such complex models, whereas others expressed the view that they were not in a position to judge to what extent the models actually represented the structure of information in the current TIR Carnet. For these reasons, the Expert Group decided to revert to this matter at a later stage and mandated the secretariat to organize a meeting with some IT specialists to study which model is best suited for the purposes of the Expert Group. The Expert Group further welcomed the secretariat's proposal to use in the future the Unified Modelling Language-standard (UML) (ExG/COMP/2002/10, paras. 11 and 12).

At their meeting, which took place on 3 July 2003, the IT specialists held an extensive exchange of views on the suitability of the, UML based, UN/CEFACT Modelling Methodology (UMM) as a methodology to model business processes like the TIR procedure. As such, UMM provides a procedure for specifying, in an implementation-independent manner, business processes involving information exchange. Although the IT specialists noted that it could be worthwhile to study other methodologies, they recognized that the process of selecting a methodology is very complex and time consuming. They agreed that this work has already been done by the UN/CEFACT team in the elaboration of UMM and that UMM offers the necessary tools to describe the TIR business process, a uniform approach for the work of the Expert Group and a valuable base for future improvements in the TIR procedure. Seeing that the activities, undertaken by the Expert Group so far, fitted well into UMM, and that the approach endorsed by the Expert Group in the project overview was in line with the UMM, they invited the secretariat to prepare a first draft document for discussion by the Expert Group at its forthcoming meeting. The scope of the first phase of the work of the Expert Group being the analysis of the current system - the 'as-is' description of the TIR procedure - the IT specialists decided to limit this first document to the Business Domain Modelling, the first step in UMM. Furthermore, the IT specialists recommended having a full implementation of the methodology, including a first descriptive part describing the so-called 'vision' of the project. Moreover, they emphasized the necessity to adapt UMM, as it would be necessary with any other methodology, to the particulars of the TIR business process (ExG/COMP/2003/2, paragraph 6).

At its one-hundred-and-fifth session, the Working Party was informed orally of the progress made by the Expert Group at its third meeting, which took place on 1 and 2 September 2003 in Budapest. The Working Party endorsed the work undertaken by the Expert Group and took particular note of three issues, where the Expert Group had expressed that it needed further guidance from the Working Party. These issues were:

- (a) the definition of the scope of the project, which had been formulated by the Working Party as being "the computerization of the TIR Procedure". The Expert Group felt that the Working Party should clarify in more detail what was meant exactly by this wording. Within this context, the Expert Group also noted that the term "TIR Procedure" was an undefined term, making it impossible to describe exactly the boundaries of the project;
- (b) The description of the approach on how to achieve the computerization of the TIR Procedure. In view of political and technical developments, having taken place over the last few years, the Working Party was requested to provide a more detailed guidance to the Expert Group on which approach the computerization project should pursue;
- (c) The title of the project. For practical reasons, the secretariat had proposed to refer in the future to the "eTIR Project" as a short name for the project to computerize the TIR Procedure. The Expert Group felt it was not in a position to decide on this issue and decided to refer the matter to the Working Party for further discussion (TRANS/WP.30/210, paras 27-31)

At its one-hundred-and-sixth session, the The Working Party confirmed that:

- (a) the final objective of the computerization of the TIR procedure encompasses the computerization of the whole TIR Carnet life cycle from distribution issuance and via the TIR transport to return and repository and that it should, ultimately be aimed at replacing the current paper TIR Carnet. The Working Party agreed that the process to achieve this objective may be challenging , requiring the input of considerable human and financial input, both at the international and the national level. Therefore, the Working Party agreed that a step-by-step approach seemed the only feasible alternative to achieve any tangible results in the near future. To that end, it mandated the secretariat, as a first step, in cooperation with

the Expert Group (a) to work out concrete proposals on how to exchange the so-called 'static' data-elements contained in the TIR Carnet (data elements which remain unchanged throughout the TIR Transport) between the competent authorities of Contracting Parties, possibly also including the data contained in the ITDBOnline as a preliminary step, (b) to conduct a feasibility study on the practicability of such proposals and, ultimately, (c) to propose a pilot along one of the major transit corridors to implement them.

The Working Party agreed that, as a next step, the integration of the so-called 'dynamic' data elements (data elements which may be amended or updated in the course of the TIR Transport) should be considered. Further steps should then address the issue of inclusion of additional features, such as security related information and advance cargo information.

Once these tangible steps had been achieved, the Expert Group could focus its attention on further, outstanding, issues in relation to the computerization of the TIR procedure.

- (b) The Working Party agreed that the approach of the computerization process should, until further notice, be focused on the establishment of an international, centralized database, whose aim it should be to facilitate the secure exchange of data between national Customs systems. At a later stage, the sharing and exchange of data with other bodies concerned (such as TIRExB, international organizations, national associations and the international guarantee), should not be excluded.
- (c) The Working Party agreed that the Project to Computerize the TIR Procedure could, in future, be referred to as "eTIR-project" (TRANS/WP.30/212, para. 26).

At its sixth session, the Expert Group established that, with the exception of Chapters 1.1.7 and 1.1.8, it had completed its work on Chapter 1 of the Reference Model and that it would dedicate its future work to the remaining Chapters, unless new, as yet unknown, information would require a re-assessment of Chapter 1 (ExG/COMP/2004/24, para. 15)

0.2 Introduction to the reference model

Just as it is not possible to build a decent and secure house without a proper plan, which has been drawn up by a qualified architect, it is not possible to computerize a system without first designing the necessary models, outlining all the elements and procedures of which it consists. And just as the construction of a small garden shed does not require the same planning as the construction of a hundred storey high commercial building, different systems will require different modelling techniques, in function of their aim and complexity.¹

This document contains the full description of the TIR Procedure Computerization Project.

The business process modelling methodology applied to draw up this document is based on the UN/CEFACT Modelling Methodology (UMM). UMM in its turn is based on the Unified Modelling Language (UML) from the Open Management Group (OMG) and is derived from the Rational Unified Process (RUP) developed by Rational Corporation. As such, UMM provides a procedure for specifying/modelling business processes in a protocol-neutral, implementation-independent way.

¹ See also IS architecture artistry. G. Gage, IDG Communication Publication, July 1991

Business Modelling provides a formalized way to describe how the TIR procedure operates and thus enables a common understanding of its key features and requirements. It can be used as a tool to provide a range of e-business solutions covering all or part of the TIR procedure and based on a variety of technologies. The models also facilitate the detection of opportunities for simplification and harmonization.

This document is first intended to facilitate the work of the Informal ad hoc Expert Group on Conceptual and Technical Aspects of Computerization of the TIR Procedure and to provide modelling support. In addition, it should facilitate the future work to be undertaken by the Informal ad hoc Expert Group on Legal Aspects of Computerization of the TIR Procedure. The final version of the Reference Model will be submitted to the Working Party on Customs Questions affecting Transport (WP.30) and the Administrative Committee for the TIR Convention (AC.2) for endorsement as well as being a reference for any future work in the eTIR Project. In addition, every single chapter of the Reference Model will, upon completion, be submitted for endorsement to the WP.30 (see Table 0.3).

0.2.1 Phases and Workflows

According to Rational Unified Process and UMM, every project passes through a series of standard phases. The phases are inception, elaboration, construction and transition. For each phase, a number of workflows is required. The workflows identified for computerization projects are: Business Domain Modelling, e-Business requirements, Analysis, Design, Implementation, Test and Deployment. The UMM focuses on the inception and elaboration phases and limits itself to the first four workflows, not encompassing the Implementation, Test and Deployment workflows. The description of the work during every phase, indication the main or 'high-level' activities, is shown in Table 0.1.

Phase	High-level activities
Inception	<ul style="list-style-type: none"> ○ Idea is conceived, and initially documented using the UMM. ○ Main workflows are: 1) Business Domain Modelling, and 2) e-Business requirements.
Elaboration	<ul style="list-style-type: none"> ○ Idea is further refined and expanded ○ Main workflows are: 1) Analysis, and 2) Design ○ The outcome – deliverables – is compared with the already defined models, requirements and references contained in the 'repository' ○ New models or enhancements to existing models are incorporated into the repository
Construction	<ul style="list-style-type: none"> ○ Messages are designed ○ Software development ○ Main workflows are: 1) Implementation, 2) Testing, and 3) Deployment
Transition	<ul style="list-style-type: none"> ○ Testing ○ Main workflow is Deployment

Table 0.1 Activities associated with each phase

In the Inception and Elaboration phases, the UMM concentrates on workflows needed to understand the business needs to produce business scenarios, business objects and areas of business collaboration. They are:

- Business Domain Modelling
- e-Business requirements
- Analysis
- Design

Within each of these workflows a set of deliverables is produced (see Table 0.2). The whole process is iterative so that additions and changes can be validated and incorporated into any of the workflows as they are discovered. Additions and changes should be a natural result of maintenance and enhancement.

Deliverables	Business Domain Modelling Workflow	e-Business requirements Workflow	Analysis Workflow	Design Workflow
Package diagram	X			
Class diagram	X	X	X	X
Use case description	X	X	X	
Use case diagram	X	X	X	X
Sequence diagram			X	X
Collaboration diagram			X	X
Statechart (state machine) diagram			X	X
Activity diagram	X	X	X	X
Component diagram				X
Deployment diagram				X
Requirements list	X	X	X	
Glossary	X	X	X	

Table 0.2 Deliverables

Every workflow focuses on specific aspects of the project. The Business Domain Modelling describes the scope of the project within the whole system, enabling a common understanding of the functioning of the current TIR procedure – the “as-is” situation – to all 'stakeholders' and defines the high-level business requirements. The e-Business requirements workflow captures the detailed user requirements in the computerized environment to be developed and further elaborates the use cases described in the previous phase of the work. The third workflow, the Analysis, translates the requirements identified in earlier phases into specifications that can be followed by software developers and message designers. Finally, in the Design workflow, the specification devised during the Analysis workflow will be used to develop the messages and the collaborations required to exchange these messages.

Each and every workflow will be terminated by a formal validation by the relevant bodies.

0.2.2 Step by step approach applied to the UMM

At its one-hundred-and-sixth session, the Working Party agreed that, in the light of the complexity of the project and in order to achieve tangible results in the near future, a step-by step approach was the only feasible way to address the eTIR Project.

As stated in the introduction to Chapter 0.2, the UMM methodology is mainly based upon the Rational Unified Process (RUP), which originally has been used in the field of software engineering. The eTIR Project, although not being a software engineering project, nevertheless is confronted with many similar problems with regard to the complexity of the issues at stake. In order to address complex problems, software engineers usually issue a first version of a software, tackling the main issues. With every new release, they add functionalities to the software with a view to advance towards reaching the final objectives of the project.

In the eTIR project, the various steps to be undertaken to achieve results in the project may be considered as being equivalent to the various releases of software. Therefore (and in accordance with the RUP), every single step, after it has been clearly defined, will be considered as a specific sub-project and will have to pass through all phases of a project lifecycle. All sub-projects share the same final objectives but each individual sub-project contains different elements to achieve them.

0.2.3 Structure and updating of the document

The underlying document follows the methodology and structure presented above. The four main chapters correspond to the four workflows of the Inception and Elaboration phases. In addition, a number of annexes also forms part of the present Reference Model.

The requirements list and the glossary (TIR glossary) are two key cross-reference documents which are used throughout the process to ensure that all business requirements, terms, and definitions are recorded. These two documents are maintained as and recorded in Annexes 1 and 2 respectively.

Annex 3 contains a UML Symbols Glossary, describing the specific terms and symbols of the language to allow non-UML literates to understand the numerous diagrams contained in this document.

Annex 4 contains a UMM/UML Glossary, describing the specific terms used by the UMM methodology.

Annexes 5 and 6 contain the lists of, respectively, figures and tables contained in underlying document.

In Annex 7 the reader can find all references to the documents used to elaborate this document.

The Reference Model will contain the results of each work phase, in line with the description in Chapter 0.2.1. and in accordance with the decisions by the Expert Group. In view of the step-by-step approach, described in Chapter 0.2.2., the Reference Model will be amended by means of an iterative process, as shown in Figure 0.1.

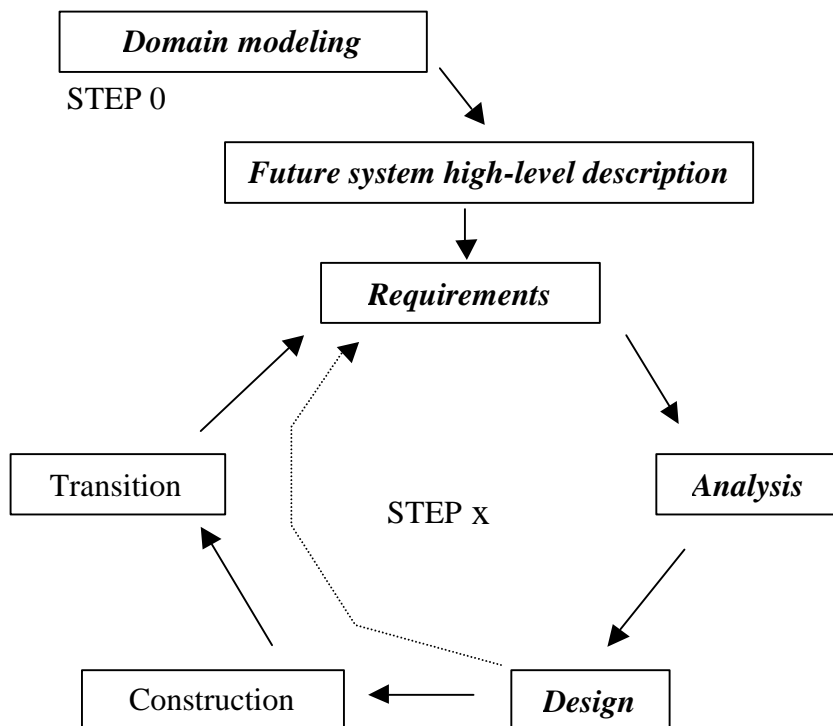

Figure 0.1 - Step-by-step iterative approach of UMM

Because UMM does not go beyond the design phase of projects, the actual construction and transition phases are beyond the scope of the eTIR Project. Thus, the Expert Group can already start drafting the requirements of the next step before the previous step will actually be in production (see dashed line in Figure 0.1.).

A step-by-step approach can only be successful if all steps, necessary to achieve the final goal, are well defined before starting the actual work. Therefore, the introduction to Chapter 2 contains the description of the different steps of the project and explains how these steps will complement each other in order to achieve the overall objectives of the eTIR Project.

In addition, some chapters or annexes may be added in the future to reflect the specificities of the TIR Procedure Computerization Project.

Moreover, the existing systems identified during the domain modelling phase will have to be taken into account during the Analysis and Design phases of every step to avoid superfluous or incompatible developments. It is important to recall that the eTIR project is not a so-called "Greenfield" project.

0.2.4 Stakeholders responsibility chart

The computerization of the TIR Procedure is a project involving numerous stakeholders. Most of them have specific roles to play in the project and they are interdependent. Figure 0.2 shows the roles of the stakeholders and dependencies between them; dependency arrows also indicate the reporting directions, in other words, who reports to whom.

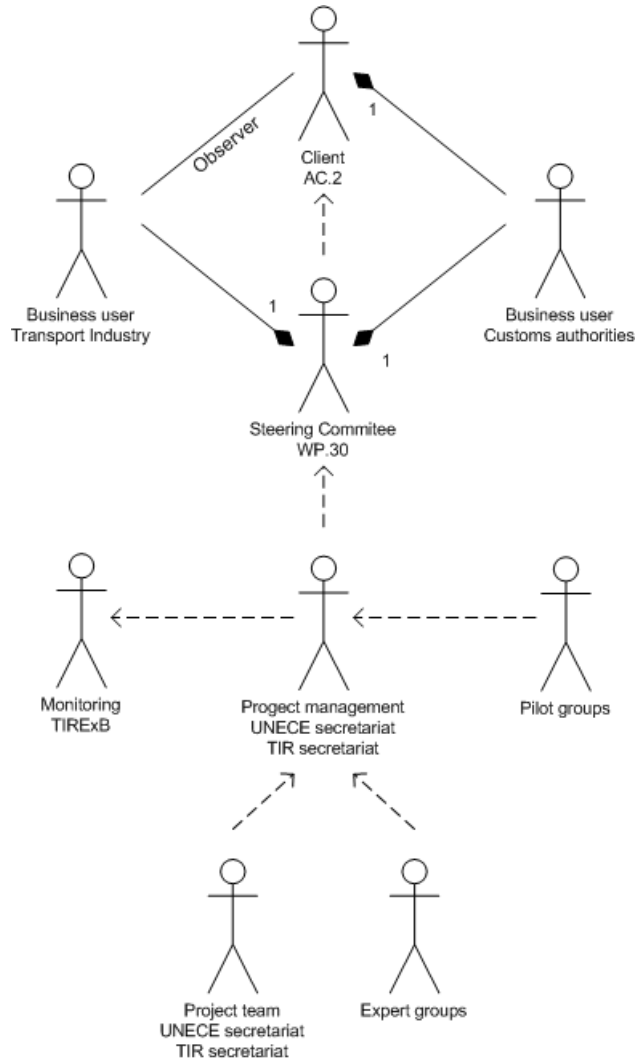

Figure 0.2 Stakeholders responsibility chart

0.2.5 Review and validation status

The table below presents the revisions and the validation dates for the various parts and versions of the reference model.

	Version	Validated by ... on ... ²			
		COMP ³	LEGAL ⁴	WP.30 ⁵	AC.2 ⁶
REFERENCE MODEL					
1. BUSINESS DOMAIN MODELLING	1.5a	27/5/2005			
1.1 Vision	1.2	2/3/2004			
	1.5a	27/5/2005			
1.2 TIR procedure domain	1.2	2/3/2004			
	1.4a	27/10/2004			
1.3 TIR Carnet life cycle use cases	1.2	2/3/2004			
	1.4a	27/10/2004			
1.4 Elaborate the use cases	1.4a	27/10/2004			
1.5 Entity classes	1.0	2/9/2003			
	1.4a	27/10/2004			
1.6 High-level class diagram	1.4a	27/10/2004			
2. E-BUSINESS REQUIREMENTS					
3. ANALYSIS WORKFLOW					
4. DESIGN WORKFLOW					
ANNEX 1 - REQUIREMENTS LIST					
ANNEX 2 - TIR GLOSSARY					

Table 0.3 Review and validation status

² This table contains the dates on which the various versions of parts of the reference model have been validated (endorsed) by the different groups. The cells in grey indicate that endorsement by that specific group is not required.

³ Informal ad hoc Expert Group on Conceptual and Technical Aspects of Computerization of the TIR Procedure

⁴ Informal ad hoc Expert Group on Legal Aspects of Computerization of the TIR Procedure

⁵ Working Party on Customs Questions affecting Transport

⁶ Administrative Committee for the TIR Convention, 1975

1. Business Domain Modelling

The purpose of the Business Domain Modelling workflow is:

- To present the scope of the project;
- To understand the structure and dynamics of processes within the current TIR procedure;
- To ensure that all stakeholders involved have a common understanding of the current TIR procedure;
- To understand the daily business in the TIR procedure, without reference to an electronic solution;
- To formulate the high-level business requirements which will serve as a basis for a subsequent detailed analysis.

In an international project such as the computerization of the TIR procedure, it is absolutely indispensable that every stakeholder involved has a common vision of the project. Therefore, the first part of the Business Domain Modelling describes this vision in light of the background and the mandates given to the various groups involved.

Once the vision is clearly defined, the high-level analysis of the TIR procedure domain can be undertaken, followed by a more detailed analysis enabling a deeper understanding of the functioning of the TIR procedure. To this end, the domain is divided into areas and a use case analysis is drawn up for each area of interest. Already at this level some areas will be left aside because they are not part of the scope of the project. The requirements list and the TIR glossary are also filled-in accordingly. The list of entity classes and the high-level class diagram, established during this workflow, contribute to the development of the TIR glossary.

Deliverables from the Business Domain Model workflow include:

- Scope of the Business Domain and the boundaries of the project;
- Business Domain use case diagram with its description and business domain activity diagram;
- Use case diagram, use case description and activity diagram for each area;
- TIR entity classes, definitions and a high-level class diagram;
- List of business requirements (including non-functional requirements);
- TIR glossary.

1.1 Vision

This first part of the work aims at reaching agreement on the objectives, the business needs and the scope of the business domain. This also involves identifying the business opportunities and specifying the boundaries of the business domain being modelled.

1.1.1 Project title and abbreviation

The title given by the WP.30 to the project is:

TIR Procedure Computerization Project

The abbreviation used for the project is:

eTIR

1.1.2 Objectives

This chapter gives a brief description of the purpose of the project.

The final objectives of the eTIR Project are:

- Integrating the computerized TIR procedure in the overall process of technological development in international transport, trade and Customs procedures:
 - Simple and cost effective data capture and data transmission;
 - Facilitation of global intermodal application of the TIR Procedure;
 - Real time exchange of information among actors.
- Improving the efficiency and quality of the TIR procedure:
 - Reduction of processing times at border crossings and final destination;
 - Increased efficiency of internal administrative and control procedures;
 - Increased accuracy and reduction of errors;
 - Reduction of costs;
 - Progressive replacement of paper TIR Carnet;
 - Full use of international standard codes in order to eliminate language barriers;
 - Availability of advance cargo information.
- Reducing the risk of fraud and improving security:
 - Automatic generation of data for risk assessment;
 - Facility to implement early-warning system;
 - Easy access to information for control and risk management purposes.

1.1.3 Boundary of the eTIR Project

The final objective of the eTIR project encompasses the computerization of the whole TIR Carnet life cycle (from issuance and distribution via the TIR transport to return and repository) and is ultimately aimed at replacing the current paper TIR Carnet. However, the eTIR Project will inevitably have repercussions on other parts of the TIR Procedure. Therefore, it is important to identify the boundaries of the project in order to realize the full impact the project may have and to ensure that the views of all stakeholders are taken into due account. The boundaries are defined along two axes: stakeholders and information

Stakeholders

A stakeholder is defined as someone (or something) who is materially affected by the outcome of the system but may or may not be an actor of the system. Actors are stakeholders who are involved in the specific project as users and are thus part of the Reference Model. Stakeholders inside the boundary of the system are involved in the project as active participants in the work and/or members of decision-making bodies; those outside the boundary may participate in meeting to ensure any future compatibility where necessary.

Figure 1.1 shows the stakeholders inside and outside the boundaries of the project and emphasises those who are also actors.

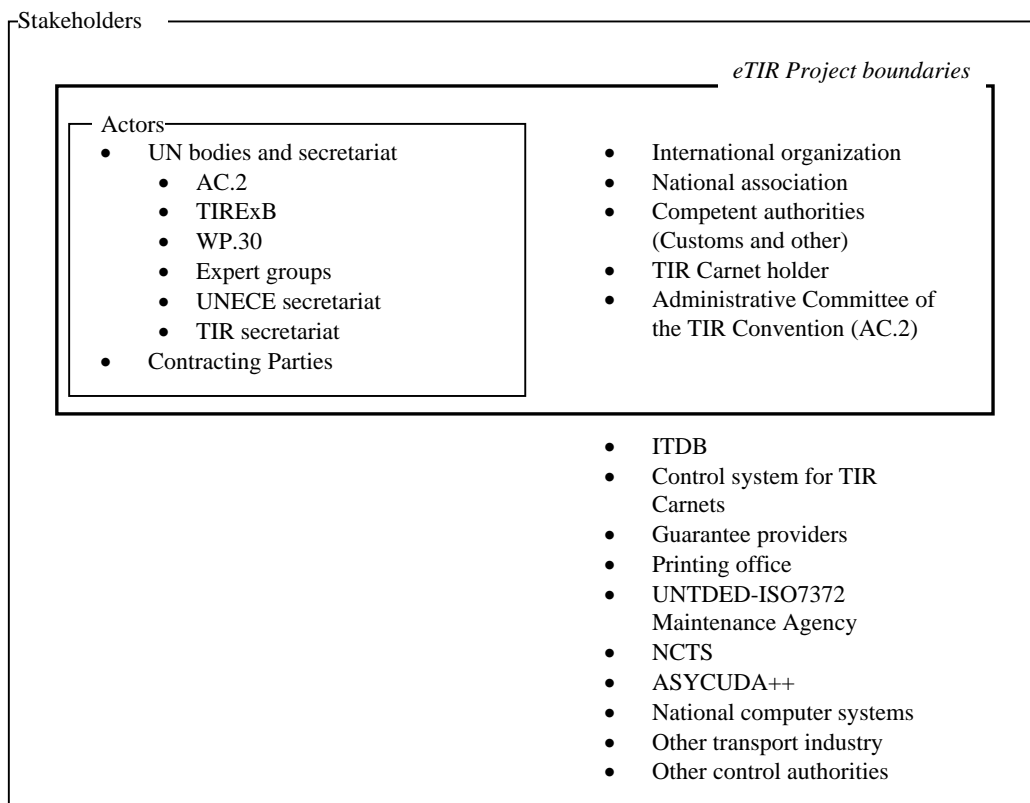

Figure 1.1 Stakeholders and actors

Information

The data elements inside the boundaries have already been identified and are listed in the report of the Second meeting of the Expert Group (ExG/COMP/2002/10, Annex 4). These data elements reflect the information contained in the current, paper-based, TIR carnet and provide the basis for the elaboration of a minimal set of data to be computerized. However, this set may need to be further amended in the course of the project, when the Group addresses other issues, such as, for example, security.

Before being annexed to underlying document, the data elements will be submitted to the Maintenance Agency (MA) of the UN Trade Data Elements Directory (UNTDDED) in order to ensure that they meet international standards.

1.1.4 Business Opportunity and Problem Statement

This section describes the initial considerations with regard to the development of the eTIR project. A full vision for the future will be defined in Chapter 2 of this document.

Technological developments in international transport, trade and Customs procedures

The extremely rapid technological developments in Internet applications, world-wide wireless communication systems and smart card technologies have led to simple and cost effective data transmission possibilities on a world-wide level with increasingly secure authentication procedures. These technologies have and increasingly will affect profoundly the way and means how international transport and trade operations as well as Customs procedures are carried out.

EDI technologies are today used by all major freight forwarding companies and by many road transport companies engaged in international transport. Also Customs authorities increasingly use these technologies to enhance efficiency of internal administrative and control mechanisms and to improve service quality at border crossing points.

The reasons for such rapid introduction of EDI technologies – unthinkable only five years ago – are cost benefits and the superior service quality in terms of accuracy, speed, tracing, controlling, billing and other value-added features which are associated with the use of these computer-based technologies. Traditional paper-based documents and procedures no longer fit into such an environment unless they are accompanied or supported by computer readable data files. Any modern international Customs transit system with the objective of facilitating international transport and trade simply cannot ignore these rapid developments.

Efficiency of the TIR Customs transit procedure

Freight forwarding and transport companies as well as Customs authorities constantly have to improve the efficiency of their operations and to increase service quality. This will become increasingly important since international goods transport, particular road transport, is forecast to increase considerably in the coming years, also along the East-West European transport corridors (European Union – Russian Federation, CIS countries and beyond) and on the Southeast-European axis (European Union – Turkey –Iran (Islamic Republic)/Middle East). These trends, together with the tremendous growth of smaller and time-sensitive shipments, will substantially increase the volume of international shipments and thus the workload of Customs authorities. At the same time the

resources allocated to Customs services, both in terms of manpower and installations, are decreasing in many countries.

Statistics show that there exist no alternatives to the TIR Customs transit procedure for international road transport. In 2000 more than 500,000 TIR operations were terminated in the Russian Federation. The CIS countries alone accounted for more than half a million of TIR Carnets issued. Bulgaria, Iran (Islamic Republic of), Romania and Turkey also issued more than 900,000 TIR Carnets to their transport operators in 2000. Even with the extension of the Community and Common Transit Systems to the EU accession countries in the coming years, the use of the TIR procedure will probably further increase, particularly once the countries in the Middle East, Northern Africa and Asia apply fully the TIR procedure and China accedes to the TIR Convention.

Thus, the TIR Customs transit regime will remain the backbone for efficient international road transport at the pan-European level and it seems thus indispensable to adapt it to the already existing and emerging needs of the transport industry and the Customs authorities involved.

In the 1970's, when the paper-based TIR Carnet was introduced in its present form, it not only provided proof of the required guarantee coverage, but it also constituted the administrative basis for further trade facilitation as well as effective Customs administration and control of transit operations. Today the TIR Carnet has lost this role to a large extent (apart from the fact that it is no longer in line with the format and layout of modern trade documents as recommended in the UN Layout key). In fact, there are even situations where the use of the TIR Carnet interferes with the concept of effective Customs transit administration and control, as the information contained in the TIR Carnets is often no longer used directly by Customs authorities, but has to be inserted manually into the various national computer systems which are increasingly used by Customs authorities. In some cases the white and green vouchers in the TIR Carnet are no longer used for Customs control, even though they still have to be filled-in by TIR Carnet holders. Apart from the risk of errors during repetitive data entry (ironically this had been one of the major advantages of the TIR Carnet replacing national Customs documents) these manual procedures are time-consuming and require resources which Customs authorities should use more effectively for other purposes.

The TIR Carnet also seems to become a burden for TIR Carnet holders as it is difficult, expensive and time-consuming to be filled-in and requires tailor-made software and hardware solutions, while multiple data entries in the TIR Carnet vouchers are often no longer needed for Customs control purposes (see above). Furthermore, the use of TIR Carnets results in millions of physical handling and shipment operations between a centralized printer and the IRU in Switzerland, between national associations and TIR transport operators in more than 40 countries and vice versa, until their final storage at the IRU premises in Switzerland. All these physical movements are a potential source for errors and fraud. They also are reflected in the costs of TIR Carnets, not to mention those incurred by the international EDI Carnet control system.

In terms of Customs efficiency, the paper-based TIR Carnet therefore has already and will increasingly become the weakest link in the TIR transport chain, unless it is complemented and ultimately replaced by electronic procedures. The introduction of new Customs procedures, such as the New Computerized Transit System (NCTS), client-oriented automated Customs declarations systems already available or being installed in virtually all major ports and airports or the electronic Customs procedures applicable for land transport in North America support this view.

Experience shows that automated Customs transit systems do not only reduce processing times at border crossing and final destination, but also allow Customs authorities to offer value-added services to transport operators and freight forwarders, such as on-line information on the status of transit operations. There is no reason why only the road transport industry should not be allowed to benefit from the possibilities of modern technologies in dealing with Customs authorities.

The fight against fraudulent activities

The fight against misuse of Customs transit systems is of utmost importance to all parties, as the facilities of these procedures can only be granted if Customs duties and taxes at risk are not jeopardized or can be easily recovered in case of misuse.

In contrast to its modest origins, Customs transit systems involve today thousands of operations every day. In such an environment, individual and manual processing and control of documentation by Customs officers, as in the past, has become ineffective and is no longer possible without causing long delays. The visual checking of paper-based documents, Customs stamps, ID-numbers, etc. must be complemented and/or replaced by automated systems which can verify authenticity of persons and data (documents) and automatically generate data for risk assessment of sensitive cargoes, destinations, etc. Effective risk management systems with the capability to act in anticipation of emerging problems are not only indispensable at the national level (Customs authorities and national associations), but, as a result of the centralized TIR guarantee system and the increase in international organized crime, also at the international level (international insurers, IRU, TIR Executive Board (TIRExB)). The revised TIR Convention (Phase I) has provided the legal and administrative means to establish such a coordinated approach and modern EDI technologies allow its efficient functioning.

The IRU, acting in accordance with Article 6 of the TIR Convention, maintains data banks with commercial information of their member associations and on the TIR Carnet users as well as information on stolen, misused or otherwise risk-prone TIR Carnets. By means of the SafeTIR system, the IRU also obtains from Customs authorities on-line information on terminated TIR Carnets covering more than 80 per cent of all TIR transports.

The international insurers certainly also have detailed information available on all Customs claims lodged in the framework of the TIR Convention which should comprise information on the reasons for such claims, countries, operators and types of goods involved as well as the amount of duties and taxes thereon.

The TIRExB, as a governmental organ, also has detailed information on all TIR Carnet holders as well as on their status (authorized, excluded or withdrawn). It also has detailed information on approved Customs seals and stamps as well as on the numerous legal arrangements made between national associations and Customs authorities in the Contracting Parties to the Convention.

Some of this information is already today available to Customs authorities or to the private sector, but no concerted efforts have yet been made to share or combine this information neither at the national and international levels nor between these levels. With a view to enhancing pro-active risk management capabilities by Customs authorities, private associations and the international guarantee providers of the TIR system, it seems therefore indispensable that Customs enforcement authorities, the TIRExB as well as the international TIR guarantee providers pool their knowledge and data. In line with national data protection laws, such information could, in the future, be made available on-line and on the basis of well-defined criteria. An integrated information system would not only provide for systematic information about trends in criminal activities, but could also allow automated risk assessment on a case by case basis, thus speeding-up border crossing and termination procedures for the very large majority of transport operators (TRANS/WP.30/2001/5, paras. 15-30).

The Expert Group, when validating the Business Opportunity and Problem Statement at its fourth session on 1-2 March 2004, fully recognized the fact that the statement as reflected in underlying Chapter should be judged and analyzed within the context of its historical setting. In 2001, when identifying the existing problems and formulating the challenges/opportunities ahead in the field

of computerization of the TIR Procedure, the Ad Hoc Expert Group on Computerization was not in a position to judge a number of developments which would take place in the course of time, which would put some of the issues raised in a different light. In particular, the Expert Group stressed that major achievements had already been obtained with regard to the implementation of a control system for TIR Carnets, where considerable concerted efforts had been undertaken by Customs authorities and the private sector to exchange and share information.

1.1.5 References

This item contains the references to documents that relate directly to the scope of the Business Domain, that is the computerization of the TIR procedure. Other references are contained in Annex 7 of the Reference Model:

- Customs Convention on the International Transport of Goods under Cover of TIR Carnets (TIR Convention, 1975);
- TIR Handbook (ECE/TRANS/TIR/6);
- Reports of the Working Party on Customs Questions affecting Transport (WP.30) (TRANS/WP.30/190; TRANS/WP.30/192; TRANS/WP.30/194; TRANS/WP.30/198; TRANS/WP.30/200; TRANS/WP.30/206; TRANS/WP.30/210; TRANS/WP.30/212);
- Reports of the Ad hoc Expert Group on Computerization: TRANS/WP.30/2001/5; TRANS/WP.30/2001/13;
- Terms of Reference of the Informal Ad hoc Expert Group on Conceptual and Technical Aspects of Computerization of the TIR Procedure and of the Informal Ad hoc Expert Group on the Legal Aspect of Computerization of the TIR Procedure: TRANS/WP.30/2002/7;
- Project Overview of the Informal Ad hoc Expert Group on Conceptual and Technical Aspects of Computerization of the TIR Procedure: ExG/cOMP/2002/5;
- Reports of the Informal Ad hoc Expert Group on Conceptual and Technical Aspects of Computerization of the TIR Procedure: ExG/COMP/2002/3; ExG/COMP/2002/10; ExG/COMP/2003/5; ExG/COMP/2004/10.

1.1.6 Scope of the project

The scope of the project is to allow for the use of electronic data interchange in the so-called “TIR Carnet life cycle” without changing its basic philosophy.

The following elements of the TIR procedure are inside the scope of the project:

- TIR Carnet life cycle:
 - Issuance and distribution of TIR Carnets;
 - TIR Transport;
 - Return and repository of the TIR Carnets;

The following elements of the TIR procedure are outside the scope of the project:

- Approval of the guarantee chain;
- Approval of the association;
- Approval of transport operators;
- Approval of vehicles;

- Management of a control system for TIR Carnets (Recommendation of 20 October 1995);
- Administration of the TIR Convention;
- Organization and functioning of the guarantee system.

When outlining the contents of the eTIR Project, the WP.30 and the Expert Group have already identified a number of tasks which shall be included. The key statements are reproduced here after:

- Analysis of the actual and future functioning of the TIR procedure (TRANS/WP.30/2002/5; ExG/COMP/2002/7);
- Development of a standard set of messages allowing for an effective communication between parties involved (ExG/COMP/2002/5);
- Preparation of the required amendments to the TIR Convention (TRANS/WP.30/2002/5; ExG/COMP/2002/7);
- Description of roles and responsibilities of all actors involved in an electronic environment (TRANS/WP.30/2002/7);
- Estimation of the costs generated by a computerized environment (cost/benefit analysis) (TRANS/WP.30/2002/5; ExG/COMP/2002/7);
- Inventory of impact on national administrative procedures and national infrastructure (TRANS/WP.30/2002/7);
- Step-by-step approach to achieve tangible results in the computerization of the TIR procedure (TRANS/WP.30/212);
- Establishment of an international centralized database (TRANS/WP.30/212).

1.1.7 Constraints

This Chapter describes which issues of a technical, political, economical or other nature have to be taken into account when designing and describing the eTIR Project. Some such issues may limit the possibilities for the project, whereas others may represent dependencies or even create opportunities.

The Requirement List of Annex I specifies how each of these constraints has to be addressed.

Technical constraints

- Data protection
- Security
- Compatibility, interoperability or interfacing with the following projects
 - NCTS
 - National Customs systems
 - SafeTIR/Cutewise
 - ITDB
 - ASYCUDA, ASYCUDA⁺⁺, ASYCUDA WORLD
 - UNTDED/ISO7372
 - UNeDocs (project)
 - WCO dataset (project)

- A complete migration overnight towards a computerized environment is not realistic (paper-based systems will have to be interoperable with computerised system).
- Use only future-proof systems and standards
- Character set and coding management

Political/legal constraints

- The TIR Convention should be changed as little as possible.
- Certain Contracting Parties may not want to directly exchange information with other Contracting Parties.
- The computerisation should not result in the exclusion of Contracting Parties from the TIR system.
- Data protection laws (e.g. business secrecy, privacy of physical persons law, governmental data protection)
- It may be a legal requirement that the national language of the country of departure is used.

Financial / Economic constraints

- Limited resources available at the national and international level, both at the private and the public sector.
- Budgeting procedure might take up to 50 months in certain countries. National investments should be planned long in advance.
- Financial support necessity

Other constraints

- Prioritisation and timing
- IT knowledge in countries (human constraints)

1.1.8 Stakeholders' needs

Needs of Customs administrations

The following needs of the Customs administrations reflect the conclusions by the ExG at its 7th session and are based on the preliminary results of the eTIR questionnaire. The ExG will revert to the issue when additional replies by countries have been received, which may require the Group to reconsider its initial assessment.

Functional needs of Customs

- Real time information

- Advance cargo information
- International Guarantee management for Customs
- International validation of the authorisation of the TIR Carnet holders against the ITDB (Authorisation, Withdrawal, ...)
- *Reports with statistical information*
- *Status of the TIR transport to be available*

Functional needs of guarantors (in the view of Customs)

- Termination notification
- Discharge notification
- *Status of the TIR transport to be available*

Functional needs of the private sector (in the view of Customs)

- *Status of the TIR transport to be available*

Additional data needs for Customs

- Consignee

EU: need of consignor data

Needs of the transport industry

- Keep the TIR System accessible for new Contracting Parties and small transporters meeting the requirements of Annex 9;
- Ensure the TIR system to be easy to use and competitive in comparison with another means of guaranteeing the delivery of goods to customs office of destination;
- Develop standardized instructions for all the participants of the TIR System with the aim to eliminate disconnected actions and human element causing mistakes while working with the system;
- Facilitate the movement of goods through faster and more standardized Customs procedures;
- Reduce the risk of providing the guarantee by rapidly securing termination and making data timely and available 100%;
- Quickly identify and eliminate from the system those who perpetrate fraud;
- Safeguard data from unauthorized access and occasional damage or loss;
- Increase the level of transparency and confidence between the industry and competent authorities.
- Standard declaration mechanism
- *Status of the TIR transport to be available*

1.2 TIR procedure domain

The TIR procedure is a very wide domain, composed of numerous interconnected systems. As seen under 1.1.5, the current project is limited in its scope to a part of the overall TIR procedure: the TIR Carnet.

1.2.1 TIR Procedure package diagram

The following package diagram is intended to show the division of the domain into systems and the dependencies among those systems.

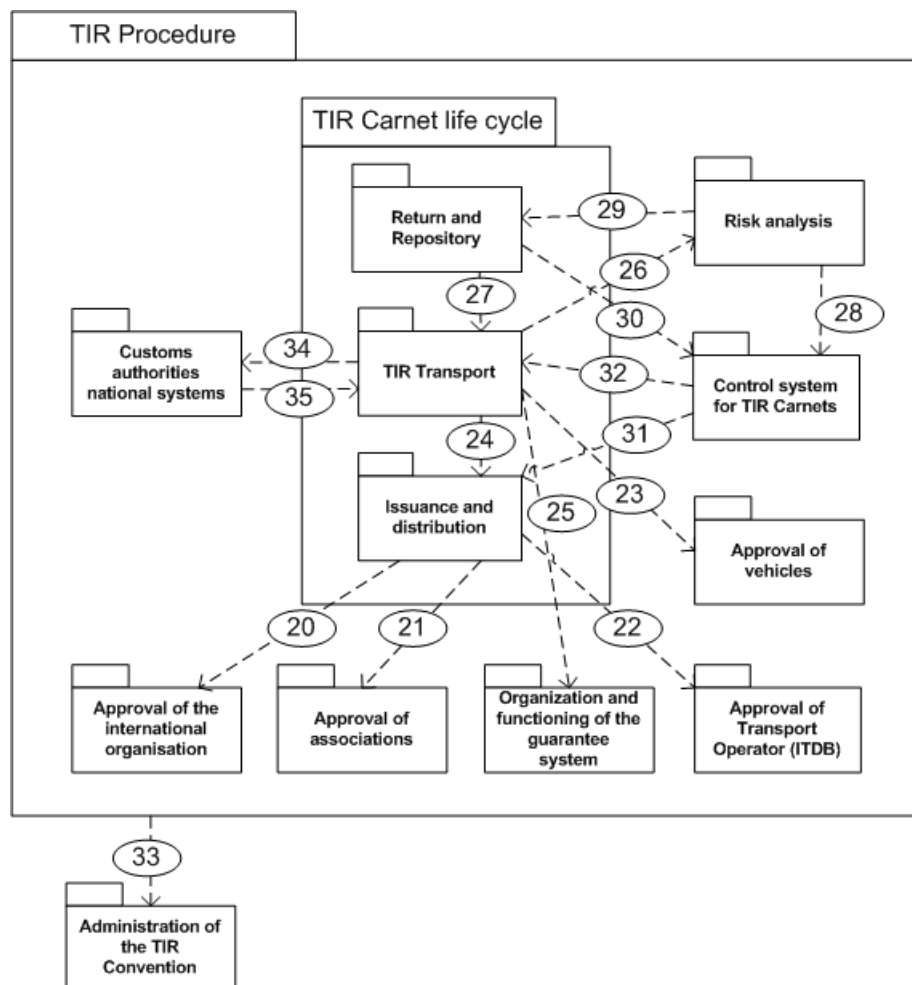

Figure 1.2 TIR procedure package diagram

1.2.2 TIR Procedure package diagram description

Name	TIR procedure package diagram
Description	<p>The TIR procedure is an International Customs Procedure governed by the TIR Convention, 1975. A detailed description of the procedure can be found in the introduction of the TIR Handbook distributed by the TIR Secretariat.</p> <p>The TIR procedure is composed of numerous interconnecting systems to allow for the functioning of the procedure. The system we are most interested in for the current project is the TIR Carnet system. It can be defined by listing all functions and uses of the TIR Carnet. It is composed of sub-systems, namely: the issuance and distribution system, the TIR transport system and the return and repository.</p> <ul style="list-style-type: none"> • The function of the issuance and distribution sub-system by the international organization and the national associations is to provide transport operators with TIR Carnets in order to allow them to perform TIR transports; • The TIR transport sub-system is the central system of the TIR procedure. It links the transport industry to the customs offices involved in a TIR transport and allows them to exchange the necessary information; • The transport operators, the associations and the international organization manage the return and repository sub-system. Its function is to centralize the storage of the used TIR Carnet and to check that no problems have occurred during the TIR transport; <p>Other systems outside the scope of the current project but of importance for the well functioning of the TIR procedure are:</p> <ul style="list-style-type: none"> • Customs authorities national systems; • Approval of the guarantee chain; • Approval of the association; • Approval of transport operators; • Approval of vehicles; • Control system for TIR Carnets; • Organization and functioning of the guarantee system; • Risk analysis system; • Administration of the TIR Convention. <p>In the package diagram, the dependencies between all systems are indicated with dashed arrows. The dependencies are numbered according to the Requirements 20 to 35 of which they are the consequences.</p>
Actors	Transport industry, Customs, Guarantee chain.
Performance Goals	Facilitate border crossing in international transport of goods.
Preconditions	Ratification of the TIR Convention by Contracting Parties and implementation of the TIR system.
Requirements Covered	20-35

Table 1.1 TIR procedure package diagram description

1.3 TIR Carnet life cycle use cases

Now that we have described the domain, we can concentrate on the scope of the eTIR Project, the TIR Carnet system.

1.3.1 Actors of the TIR Carnet life cycle

Before describing the use cases of the TIR Carnet life cycle, we will identify all the actors who play a role in the course of the TIR Carnet life cycle. By definition any person, entity or system playing a role in the TIR Carnet life cycle is an actor. The actors have already been identified when setting the boundaries of the project and they are:

- International organization,
- National association,
- Competent authorities (Customs and other),
- TIR Carnet holder,
- Administrative Committee of the TIR Convention (AC.2).

Each actor plays one or more roles in the course of the TIR Carnet life cycle. Therefore, the actors are often considered and defined according to one of the roles they play. For example, the actor “Customs authority” can play the role of Customs office of entry (en route) for incoming TIR transports but it can also play the role of Customs office of exit (en route) for outgoing TIR transports.

As a consequence, we will identify all aspects of each actor through the roles he performs within the context of the TIR Convention. The following description of the actors by means of the role they play is essential for understanding the rest of the chapter.

International organizations and national associations

International organizations and national associations can be described according to their two main roles in the TIR Carnet life cycle: the guaranteeing role and the issuing role. Figure 1.5 shows the relation between the international organizations and national associations, taking account of these roles.

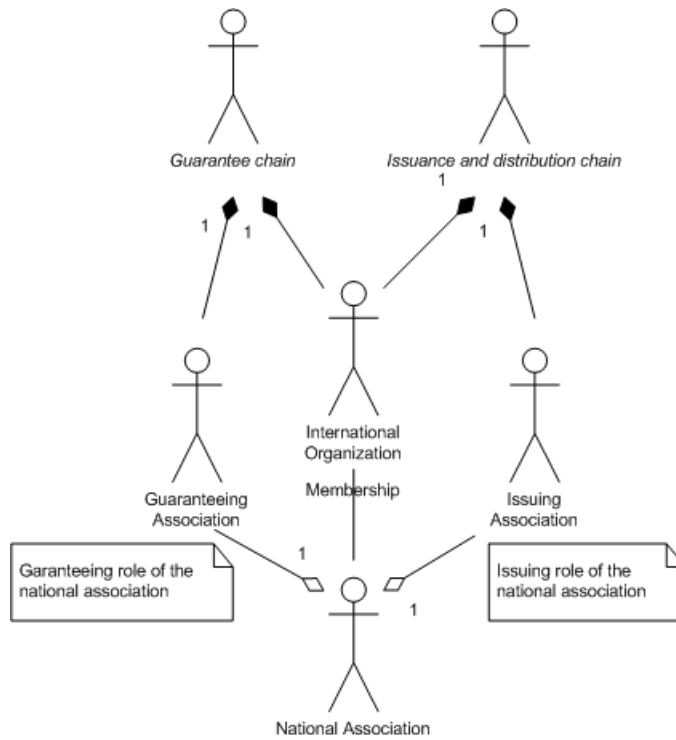

Figure 1.5 International organizations and national associations

Competent authorities

The various competent authorities (Customs and other) can be structured in such a way that they reflect the generalization of the roles they have in common. Figure 1.4 reflects the various aspects of the competent authorities (mainly Customs authorities) in the course of the TIR Carnet life cycle.

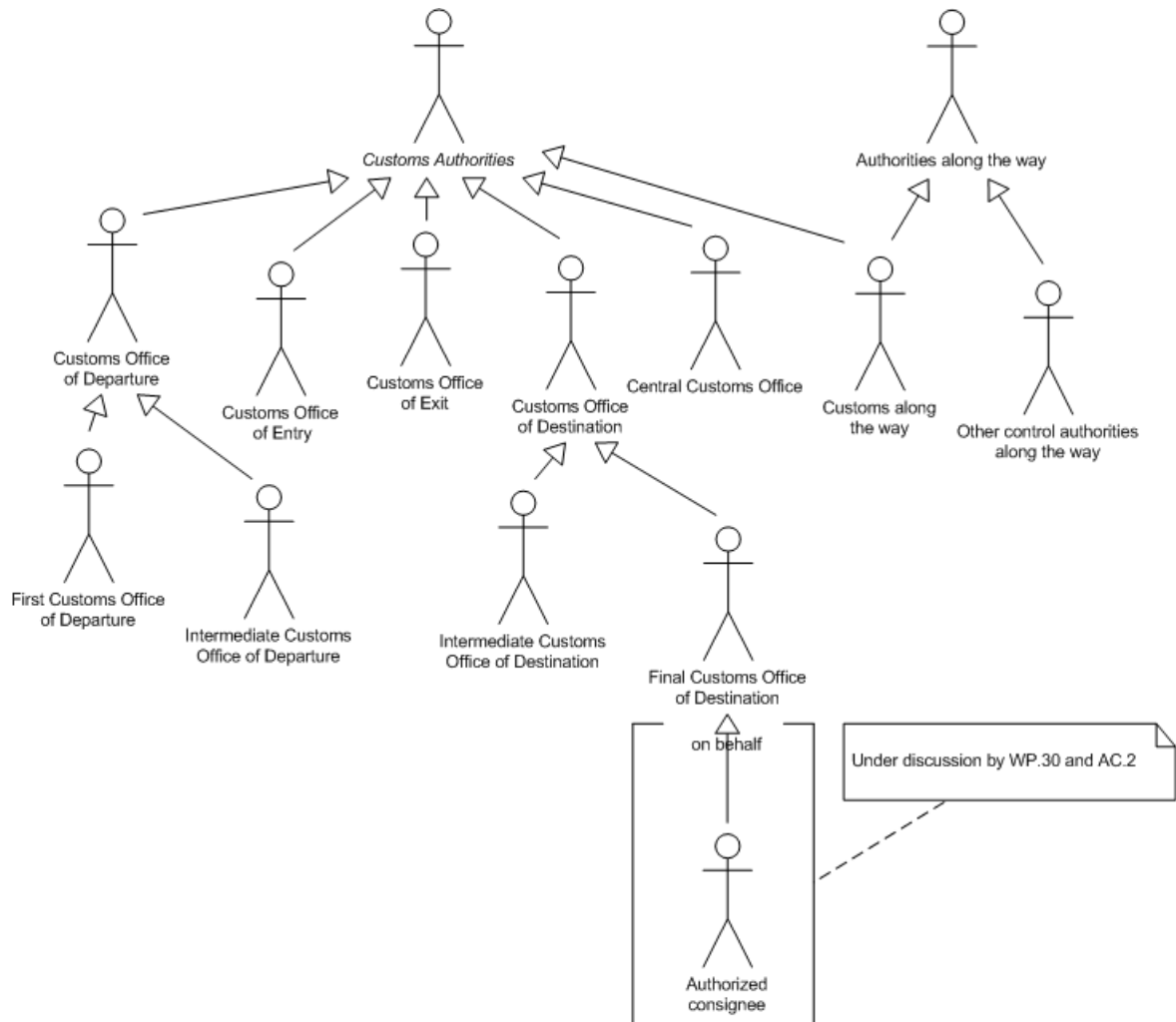

Figure 1.4 Customs authorities and other authorities

TIR Carnet holder

The TIR Carnet holder fulfils a central role in the TIR Carnet life cycle. This role is reflected in various use cases. Among these, the use case in which he provides data on the TIR transport and certifies them is certainly a crucial one. It can also happen that other persons, on his behalf, fill-in and certify the information that he must provide. Figure 1.6 shows the TIR Carnet holder and the agents who may provide data on his behalf.

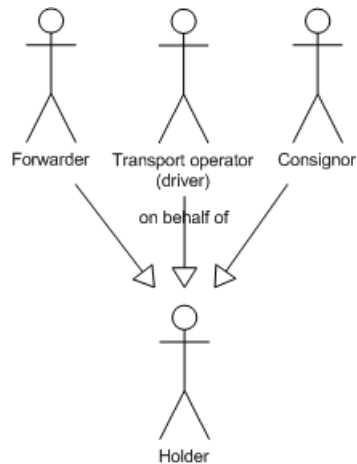

Figure 1.6 TIR Carnet holder and agents

Administrative Committee of the TIR Convention (AC.2)

The AC.2 has a supervisory role with regard to the TIR Carnet life cycle. We will see in the detailed analysis of the use cases that some use cases in connection with that role are performed by the TIRExB.

1.3.2 TIR Carnet life cycle use case diagram

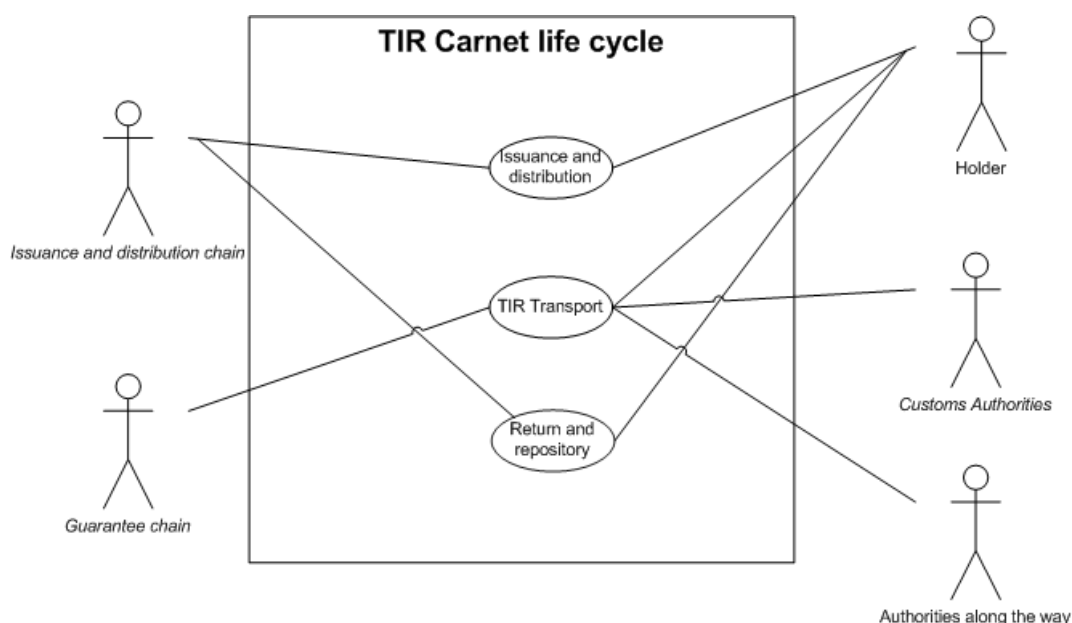

Figure 1.3 TIR Carnet life cycle use case diagram

1.3.3 TIR Carnet life cycle use case description

Name	TIR Carnet life cycle use case
Description	High-level view of all activities related to the paper TIR Carnet and the actors involved.
Actors	Guarantee chain, Customs authorities, Holder, Authorities along the way
Performance Goals	Allows the exchange of information between parties involved.
Preconditions	<ul style="list-style-type: none"> • Approval of the guarantee chain; • Approval of the association; • Approval of transport operators; • Approval of vehicles; • Management of the guarantee chain; • Administration of the TIR Convention.
Postconditions	-
Scenario	An international organization prints (organizes the printing) of TIR Carnets and distributes them to the authorized national associations. An authorized transport operator (TIR Carnet Holder) can then request a TIR Carnet from his national association. The national association issues the TIR Carnet to the TIR Carnet Holder. The national association may in certain cases return the TIR Carnet to the international organization instead of issuing it to a TIR Carnet holder.

	<p>The TIR Carnet is then presented to the Customs office of departure within the limits of its validity by the holder to perform a TIR Transport. The TIR Carnet does not only represent the international Customs document, but also the guarantee.</p> <p>Once the TIR Transport has ended, the TIR Carnet is returned to the holder, then to the association and finally to the international organization. In case the validity of a TIR Carnet has expired before it is presented to the Customs office of departure by the TIR Carnet holder, he must return it unused to the national association, which sends it back to the international organization.</p>
Alternative Scenario	In case of fraud, Customs authorities may keep the TIR Carnet until the case is solved.
Special requirements	-
Extension Points	-
Requirements Covered	-

Table 1.2 TIR Carnet life cycle use case description

1.3.4 High-level activity diagram of the TIR Carnet life cycle

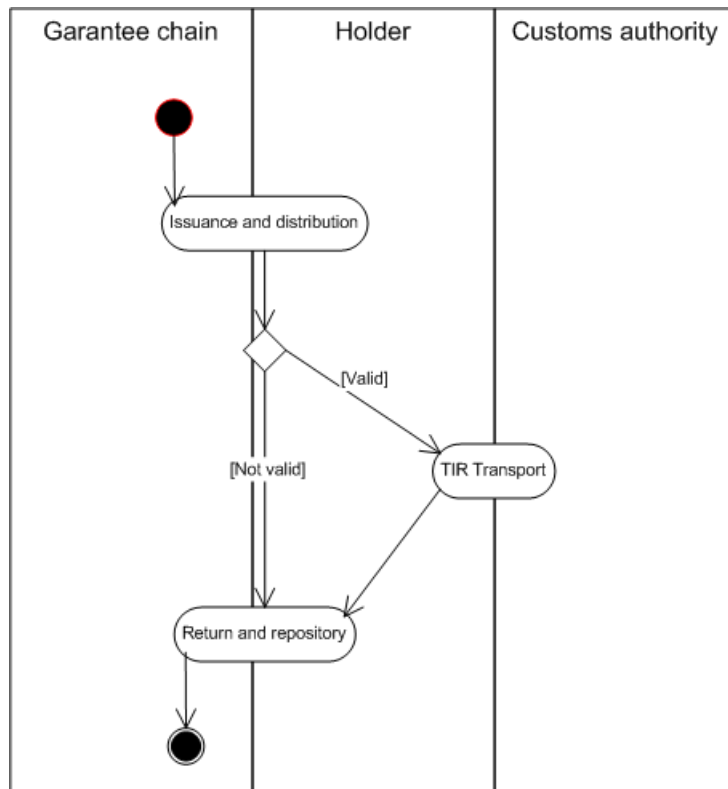

Figure 1.4 TIR Carnet life cycle activity diagram

1.4 Elaboration of use cases

This chapter aims at providing a detailed view of the procedural aspects of the TIR system. It focuses on the most common procedure and does not describe in details occasional procedures. These latter are only identified as alternative scenarios and not dealt with in more details.

1.4.1 Issuance and distribution use case

Issuance and distribution use case diagram

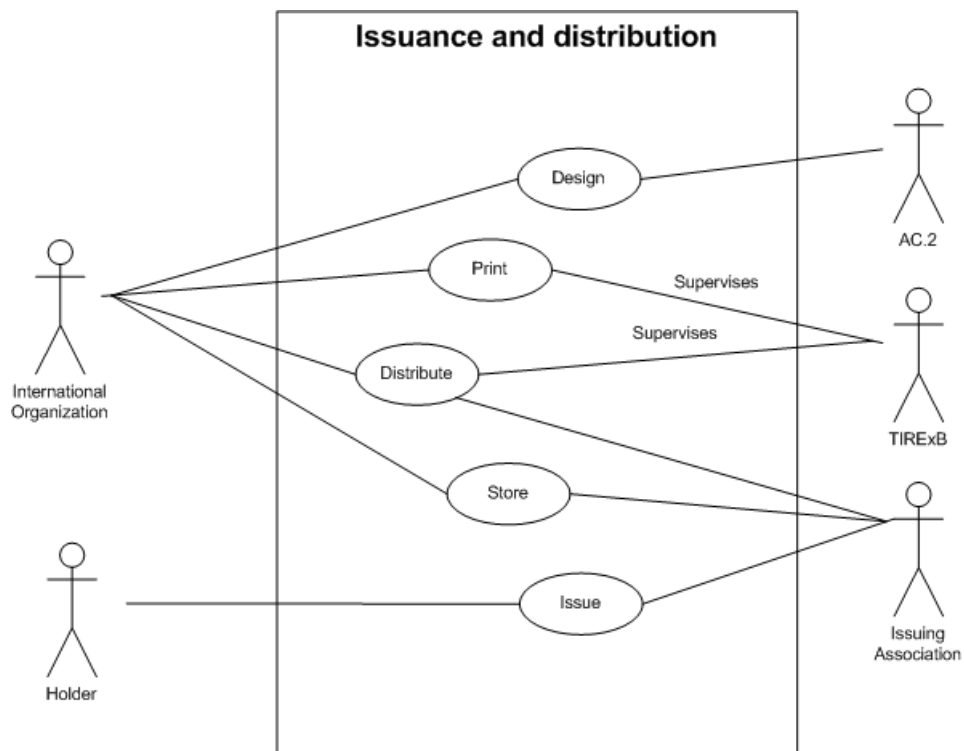

Figure 1.5 Issuance and distribution use case diagram

Issuance and distribution use case description

Name	Distribution and issuance use case
Description	In the course of this use case, the TIR Carnet is produced (printed, stored), distributed and issued to authorized transport operators.
Actors	AC.2, international organization, issuing association, holder of TIR Carnet, TIRExB
Performance Goals	To provide authorized TIR Carnet holders with TIR Carnets, the TIR Carnet being a Customs declaration to place goods under the TIR procedure (transit procedure) and representing an internationally recognized financial guarantee to Customs authorities of Contracting Parties with which a TIR operation can be established, in accordance with the provisions of the TIR Convention
Preconditions	<p>The international organization is authorized by AC.2 to centrally print and distribute TIR Carnets in accordance with Art. 6.2bis of the TIR Convention and Annex 8, Article 10 (b) of the TIR Convention under the supervision of the TIR Executive Board</p> <p>The national association is authorized by its national Customs authorities, according to Art. 6.1 of the TIR Convention and Annex 9, Part I of TIR Convention, to issue TIR Carnets and to act as guarantor. The national association should be affiliated to an international organization.</p> <p>Transport operators have to be authorized by competent Customs authorities, according to Art 6.4 and 6.5 of the TIR Convention and Annex 9, Part II of TIR Convention, in order to obtain TIR Carnets from their issuing association and to utilize TIR Carnets, according to Art. 6.3.</p>
Postconditions	<p>In accordance with the TIR Carnet life cycle use case, this use case can be followed by:</p> <ul style="list-style-type: none"> - the TIR transport use case; - the Return and repository use case.
Scenario	<p>While respecting the design, elaborated under the auspices of the United Nations Economic Commission for Europe and endorsed by AC.2, the international organization is responsible for printing TIR Carnets. The TIR Carnets are stored temporarily before being distributed by the international organization to its affiliated national issuing associations.</p> <p>The issuing association, possibly after another storage period, fills-in fields 1 to 4 of the TIR Carnet cover page and issues the TIR Carnet to authorized TIR Carnets holders, according to Art.6.3 of the TIR Convention (to national or, in some situations, to foreign TIR Carnet holders, respecting, in such case, special requirements) within the quota fixed by the association.</p> <p>The TIRExB supervises the centralized printing and distribution in accordance with Annex 8, Article 10 (b) of the TIR Convention.</p>

Alternative Scenario	<p>The main scenario does not take into account that the TIR Carnet may be stolen, lost or not valid. The following scenarios are possible:</p> <ol style="list-style-type: none"> 1. The TIR Carnet is lost/stolen/not valid after printing but before being stored at the premises of the international organization; 2. The TIR Carnet is lost/stolen/not valid while still stored at the premises of the international organization; 3. The TIR Carnet is lost/stolen/not valid during transport between the international organization and the national association; 4. The TIR Carnet is lost/stolen/not valid, while in possession of the national association, before being issued; 5. The TIR Carnet is lost/stolen/not valid after having been issued to the authorized TIR Carnet holder; 6. The TIR Carnet is returned by the national association to the international organization before being issued.
Special requirements	<p>Data on authorized TIR Carnet holders are stored in the International TIR Database (ITDB) maintained by the TIR Executive Board and TIR Secretariat.</p> <p>Data on lost/stolen TIR Carnets is maintained by the international organization in an electronic control system.</p>
Extension Points	<p>During the distribution and issuance, information will be sent to the electronic control system maintained by the international organization.</p>
Requirements Covered	<p>-</p>

Activity diagram of the issuance and distribution use case

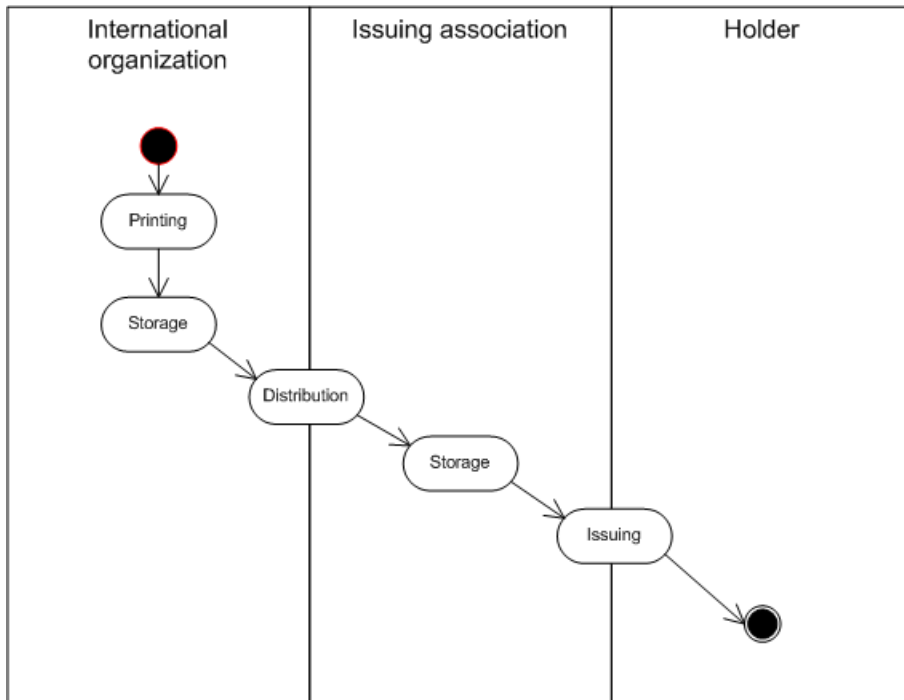

Figure 1.6 Issuance and distribution activity diagram

1.4.2 TIR transport use case

TIR transport use case diagram

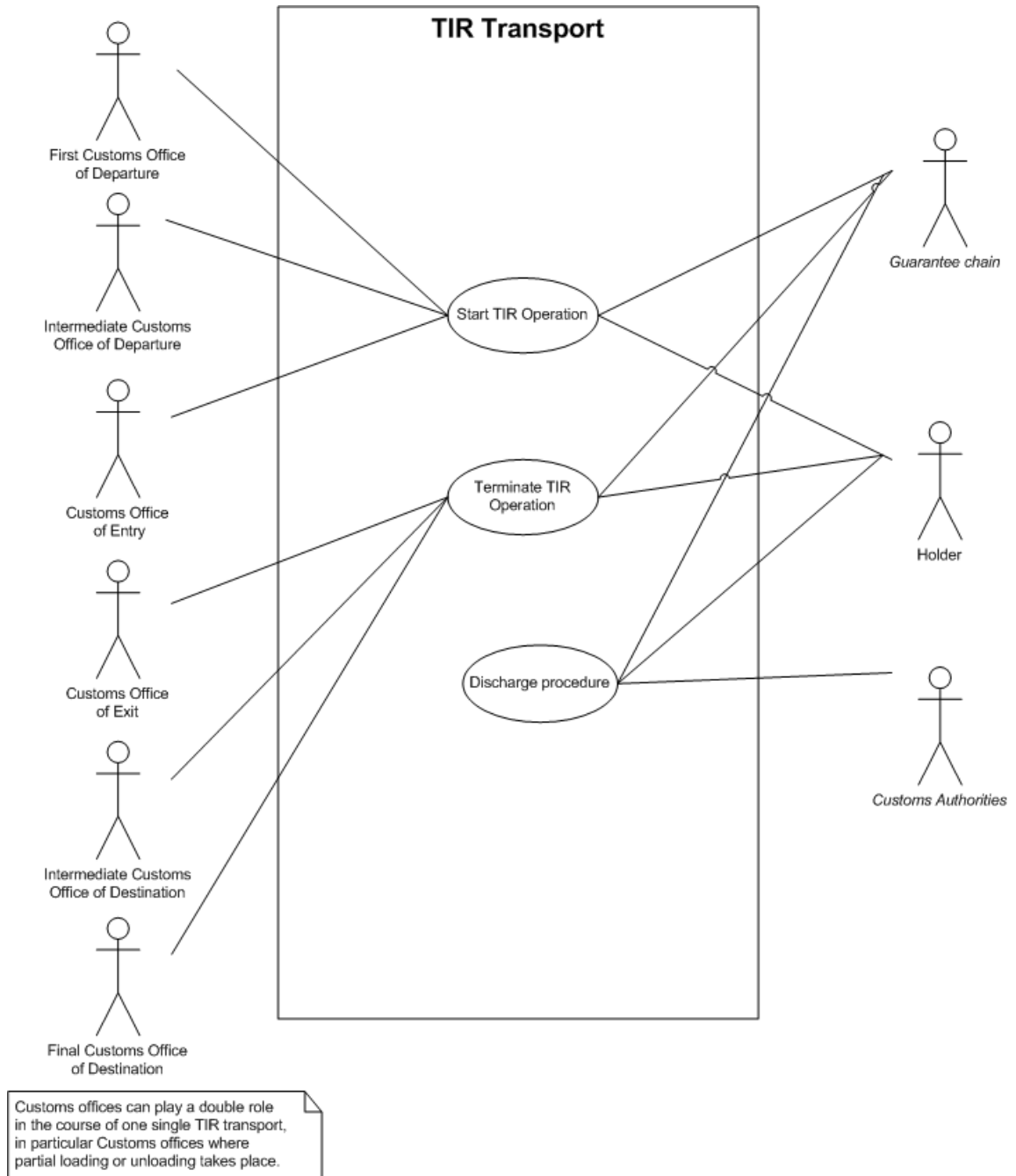

Figure 1.7 TIR transport use case diagram

TIR transport use case description

Name	TIR Transport Use Case
Description	This use case describes the transport of goods from the first Customs office of departure to the final Customs office of destination under the TIR procedure, where borders between countries (Customs territories) are crossed.
Actors	Customs authorities, Guarantee chain, TIR Carnet holder
Performance Goals	Reduce the time spent at all concerned Customs offices during international transport of goods performed under cover of a TIR Carnet in accordance with the provisions of the TIR Convention
Preconditions	<p>The authorized TIR Carnet holder must be issued with a valid TIR Carnet to begin the transport. The applicability of the TIR Carnet may depend on the type of the goods to be shipped (e.g. tobacco and alcohol require “Tobacco and Alcohol” TIR Carnets). For the transport of heavy or bulky goods, the TIR Carnet should bear the relevant inscription.</p> <p>The TIR transport has to be performed with an approved vehicle and/or container unless heavy or bulky goods are transported.</p> <p>The TIR transport must be guaranteed by associations approved in accordance with the provisions of Article 6 of the TIR Convention.</p>
Postconditions	<p>In accordance with the TIR Carnet life cycle use case, this use case shall be followed by:</p> <ul style="list-style-type: none"> - The Return and repository use case <p>After the TIR transport, the goods shall be placed under another Customs regime.</p>
Scenario	<p>Because the TIR transport is a sequence of TIR operations, the scenario of a TIR transport is represented here as a succession of TIR operations, each one being described in two steps. Each step 1-step 2 sequence constitutes a single TIR operation.</p> <p><u>Step 1:</u> Start of the TIR operation at the first Customs office of departure. The Customs officers check the conformity of the TIR Carnet, the goods, the loading compartment, as well as the approval certificates for vehicle and/or container and the commercial and transport documents. Seals are affixed to the loading compartment. The Customs officer fills-in and stamps all the relevant parts of the TIR Carnet pages including counterfoil No. 1. Upon acceptance of the TIR Carnet by the first Customs office of departure, the guarantee is activated (Art. 8, 4).</p> <p><u>Step 2:</u> Termination of the TIR operation at the Customs office of exit <u>en route</u>. The Customs officer stamps counterfoil No. 2, takes out voucher No. 2 and sends it to the Customs office of departure.</p> <p>Steps 1 and 2 are repeated if there are several Customs offices of departure (maximum 3 in one or several countries (Customs territories). In such</p>

	<p>case, in every consecutive Contracting Party <u>en route</u> transited by the TIR transport, steps 1 and 2 are repeated with the following differences: the Customs office which carries out step 1 is called Customs office of entry <u>en route</u>. It checks the seals, the loading compartment and fills-in the relevant fields of vouchers 1 and 2 and counterfoil No. 1.</p> <p>Step 2 is equal to the previous step 2 at the Customs office of exit <u>en route</u>.</p> <p>In the country (Customs territory) of destination, step 1 is identical to the previous step 1 at the Customs office of entry <u>en route</u>. The Customs office which carries out step 2 is called the Customs office of destination. In step 2, Customs officers take off the seals, stamp counterfoil No. 2, take out voucher No. 2 and send it to the Customs office of entry <u>en route</u>. Step 2 encompasses the termination of the TIR operation for this country (Customs territory) as well as the certification of termination for the goods arrived at the Customs office of destination.</p> <p>The validity of the TIR Carnet can be checked by any Customs office of departure, exit <u>en route</u>, entry <u>en route</u> and of destination, using, for example, CUTE-Wise. All Customs offices have the right to remove the seals and to check the goods (see Article 5). In such case, new seals have to be affixed and the appropriate fields of the TIR Carnet have to be filled-in accordingly (box 16, box 3 of counterfoil 1 or box 4 of counterfoil 2).</p>
Alternative Scenario	<p>The main scenario does not take account of the following scenarios:</p> <ol style="list-style-type: none"> 1. Falsified acceptance of a TIR Carnet: fraudsters may attempt to falsify the acceptance of a genuine TIR Carnet by using false Customs stamps and seals; 2. Incident or accident <u>en route</u>: in such case, the so-called “certified report” should be filled-in by the competent authorities. In case the vehicle can no longer be used, the goods may be reloaded on a different truck and a new TIR Carnet is opened. If the goods are destroyed, competent authorities should state this fact. In this case, the TIR transport cannot be terminated at the intended Customs office(s) of destination but has to be terminated at the nearest Customs office <u>en route</u>. The TIR Carnet may also be amended by competent authorities so that the TIR Transport can continue with the same TIR Carnet; 3. Under some conditions, the TIR Transport can be suspended (Art. 26).
Special requirements	-
Extension Points	-.
Requirements Covered	-

Activity diagram of the TIR transport use case

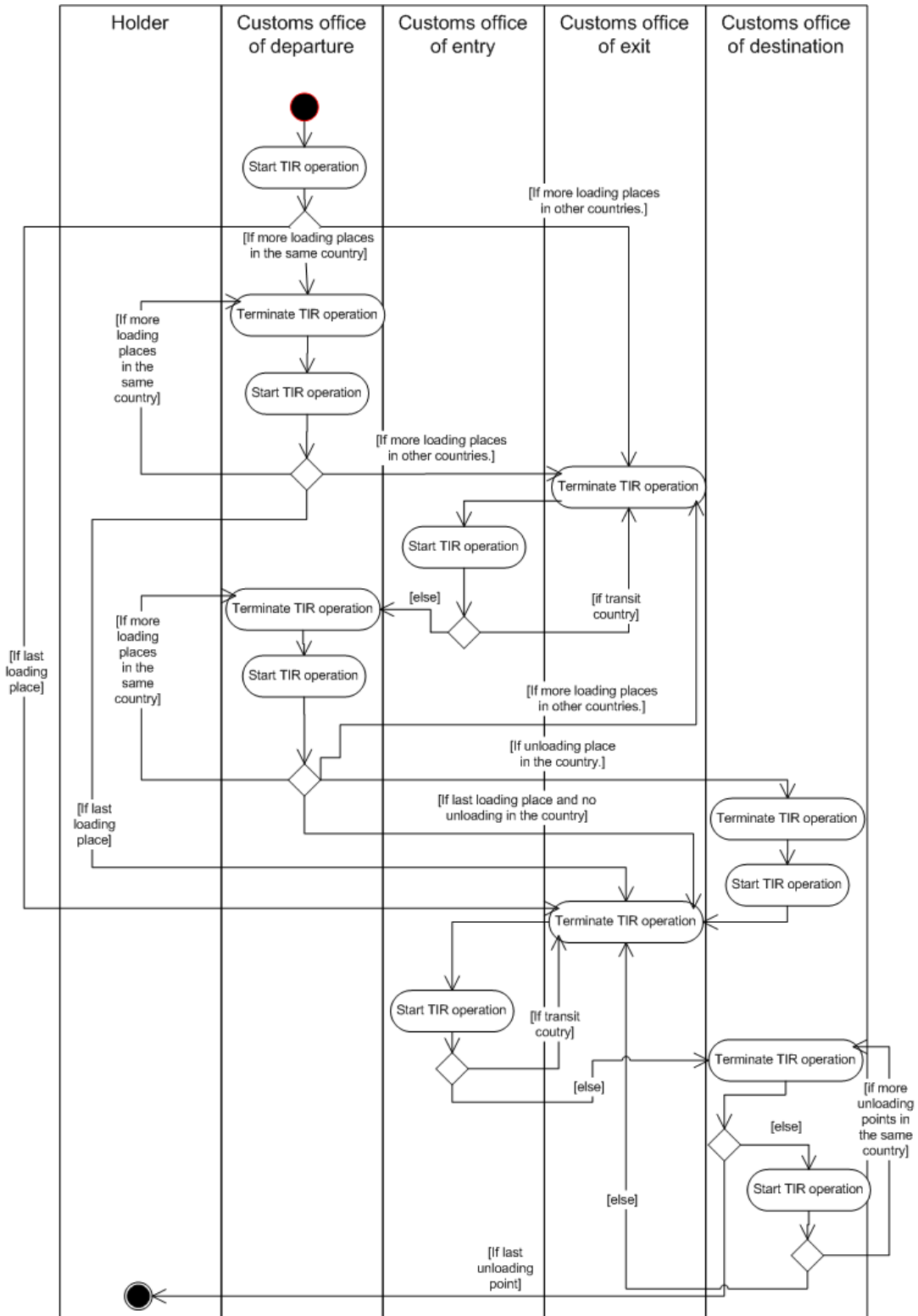

Figure 1.8 TIR transport activity diagram

Structured description of activity diagrams of the TIR transport use case

The TIR transport is a sequence of TIR operations that shall start at the first Customs office of departure and terminate at the final Customs office of destination.

The TIR Transport **BEGINS** when the first Customs office of departure starts the first TIR operation.

- If other loading point in the same country (Customs territory): **go to 1**;
 - If additional loading will take place in other countries (Customs territories): **go to 2**;
 - If the loading phase is terminated: **go to 3**;
1. At the next loading point, the intermediate Customs office of departure will terminate the current TIR operation (acting as Customs office of destination) before starting a new TIR operation.
 - If there is another loading point in the same country (Customs territory) and if the number of loading points is still inferior to 3: **repeat 1**;
 - If additional loading will take place in other countries (Customs territories) and if the number of loading points is still inferior to 3: **go to 2**.
 - If the loading phase is terminated: **go to 3**.
 2. The Customs office of exit (en route) of the country (Customs territory) will terminate the current TIR operation and the Customs office of entry (en route) of the following country (Customs territory) will start a new TIR operation.
 - If it is a transit country (Customs territory): **repeat 2**.
 - If it is a country (Customs territory) where a loading will take place if the number of loading points is still inferior to 3: **go to 2.1**.
 - 2.1. At the next loading point, the intermediate Customs office of departure will terminate the current TIR operation (acting as Customs office of destination) before starting a new TIR operation.
 - If there is another loading place in the same country (Customs territory) and if the number of loading points is still inferior to 3: **repeat 2.1**;
 - If additional loading will take place in other countries (Customs territories) and if the number of loading points is still inferior to 3: **go to 2**;
 - If the loading phase is terminated and there is no unloading in the current country (Customs territory): **go to 3**;
 - If the loading phase is terminated and there is an unloading point in the current country (Customs territory) and if the number of loading points is still inferior to 3: **go to 2.1.1**.
 - 2.1.1. At the first unloading point, the intermediate Customs office of destination will terminate the current TIR operation before starting a new TIR operation (acting as Customs office of departure).
 - The maximum number of loading and unloading places is limited to 4 and

when reaching 2.1.1 the number of loading and unloading is already 3. Thus, only one more unloading point is possible. The goods loaded in one country (Customs territory) cannot be unloaded in the same country (Customs territory). Therefore, the next step has to be the border: **go to 3.**

3. The Customs office of exit (en route) of the country (Customs territory) will terminate the current TIR operation and the Customs office of entry (en route) of the following country (Customs territory) will start a new TIR operation.

- If it is a transit country (Customs territory): **repeat 3.**
- If it is a country (Customs territory) where an unloading will take place if the number of loading + the number of unloading points is still inferior to 4: **go to 3.1.**

3.1. At the unloading point, the Customs office of destination will terminate the current TIR operation.

- If it is the last unloading point: **END.**
- If there are other unloading points: **go to 3.1.1.**

3.1.1. At the unloading point, the Intermediate Customs office of destination will start a new TIR operation (acting as Customs office of departure).

- If there are other unloading points in other countries (Customs territories) and if the number of loading + the number of unloading points is still inferior to 4: **go to 3.**
- If there are other unloading points in the same country (Customs territory) and if the number of loading + the number of unloading points is still inferior to 4: **go to 3.1.**

1.4.3 Return and repository use case

Return and repository use case diagram

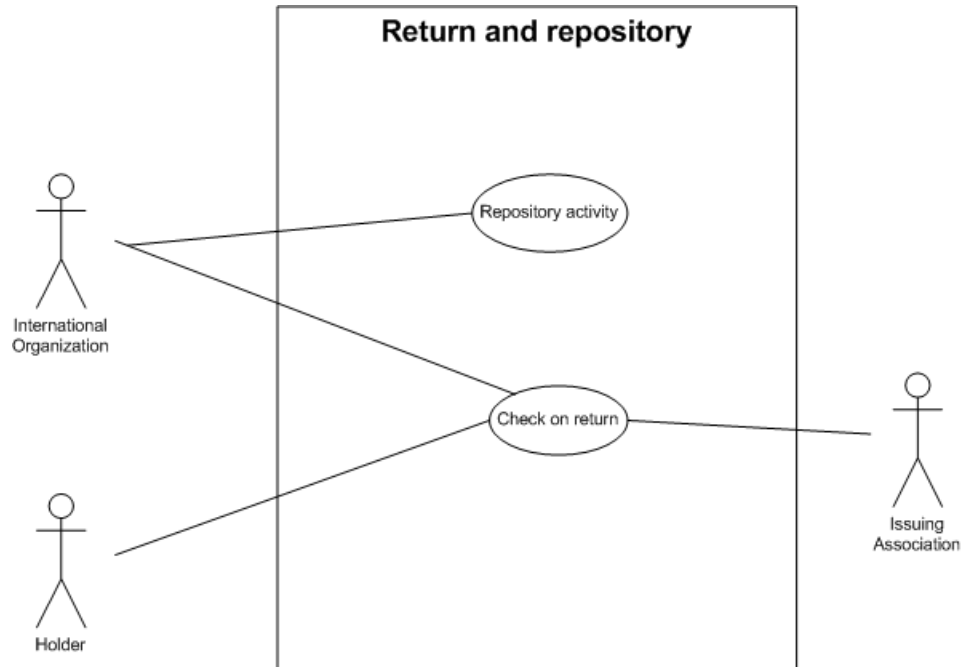

Figure 1.9 Return and repository use case diagram

Return and repository use case description

Name	Return and repository use case
Description	The TIR Carnet is sent back by the TIR Carnet holder to the international organization, via his national association, to centrally store the used or unused TIR Carnets.
Actors	TIR Carnet holder, national association, international organization.
Performance Goals	Store at a central point the evidence of the termination for the duration of the liability of the international guaranteeing chain.
Preconditions	In accordance with the TIR Carnet life cycle use case, this use case can be launched in two cases: <ul style="list-style-type: none"> - The TIR Carnet was issued to a TIR Carnet holder, who used it for a TIR Transport; - The TIR Carnet was issued to but not used by a TIR Carnet holder (usually because the TIR Carnet expired)
Postconditions	-
Scenario	<p>After having checked the TIR Carnet, the TIR Carnet holder returns it to the national association that issued him the TIR Carnet (within the deadline fixed by the association).</p> <p>The national association checks whether the TIR Carnet was used properly and whether it was terminated (check of stamps against the electronic control system maintained by the international organization). The national association returns the TIR Carnets to the international organization.</p> <p>The international organization checks the TIR Carnets and archives them. All returned TIR Carnets are physically stored at the international organization for at least the period during which its liability can be invoked according to the TIR Convention.</p>
Alternative Scenario	<p>The main scenario does not take account of the following scenarios:</p> <ol style="list-style-type: none"> 1. The TIR Carnet is lost/stolen after the TIR Transport has ended; at the premises of the holder, the national association or the international organization; 2. It may happen that the TIR Carnet is kept by Customs authorities and not returned to the TIR Carnet holder. In such case, Customs are encouraged to provide the TIR Carnet holder with the return slip which he should return to the national association.
Special requirements	-
Extension Points	-
Requirements Covered	-

Activity diagram of the return and repository use case

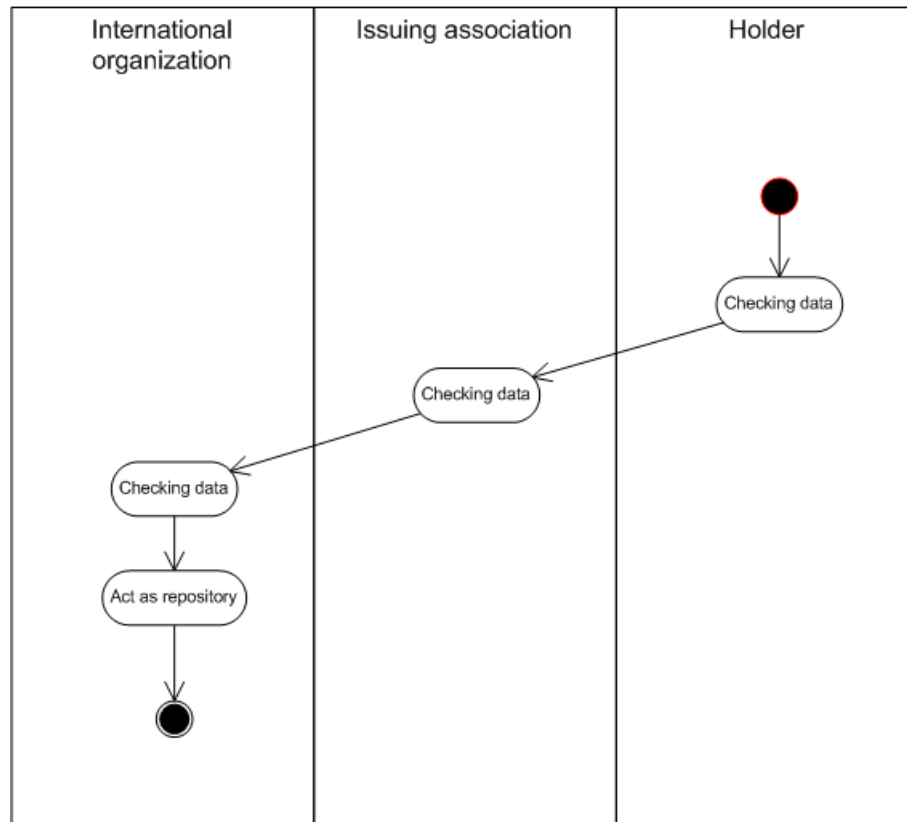

Figure 1.10 Return and repository activity diagram

1.4.4 Discharge procedure use case

Discharge procedure use case diagram

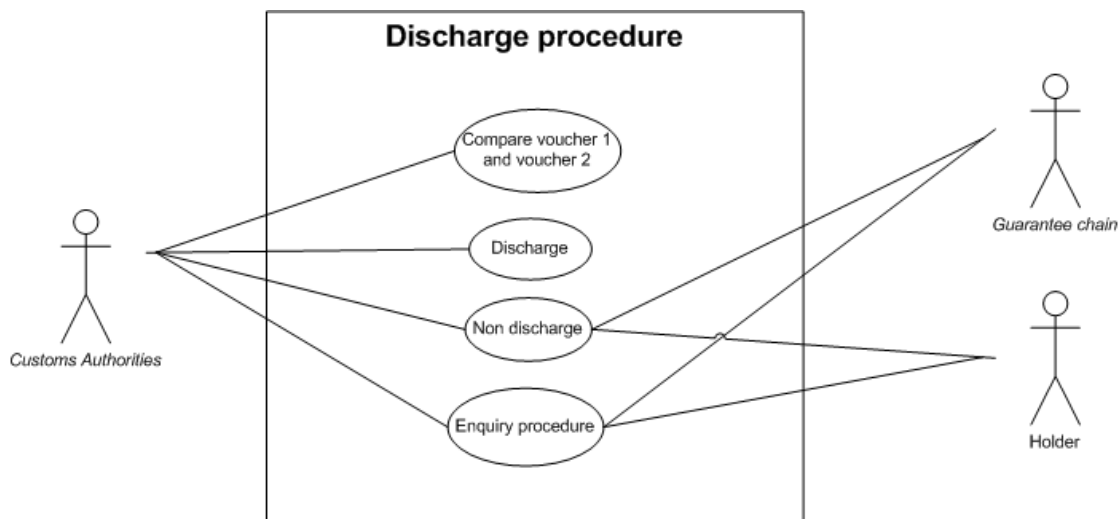

Figure 1.11 Discharge procedure use case diagram

Discharge procedure use case description

Name	The discharge procedure for a TIR operation
Description	Evaluation of the data or information available at the Customs office of destination or exit (<u>en route</u>) and those available at the Customs office of departure or entry (<u>en route</u>).
Actors	Customs authorities, Holder, Guarantee Chain
Performance Goals	Determine whether a TIR operation has been terminated correctly, in order to release the holder of his responsibilities and the national association of its guarantee.
Preconditions	This use case is launched after the start of a TIR operation.
Postconditions	-
Scenario	Once the TIR operation has been terminated, the Customs office of destination or exit (<u>en route</u>) sends back voucher No. 2 to the Customs office of departure or entry (<u>en route</u>) or to a centralized Customs office. Customs authorities compare vouchers No. 1 and No. 2 in order to establish the discharge.
Alternative Scenario	The main scenario does not take account of the following scenarios: 1. Instead of sending vouchers by post, an exchange of electronic messages between different Customs offices may take place;

	2. In case the certificate of termination of the TIR operation has been obtained in an improper or fraudulent manner or in case no termination has taken place, neither the holder would be released of his responsibilities nor the national association of its guarantee;
Special requirements	-
Extension Points	-
Requirements Covered	-

Activity diagram of the discharge procedure use case

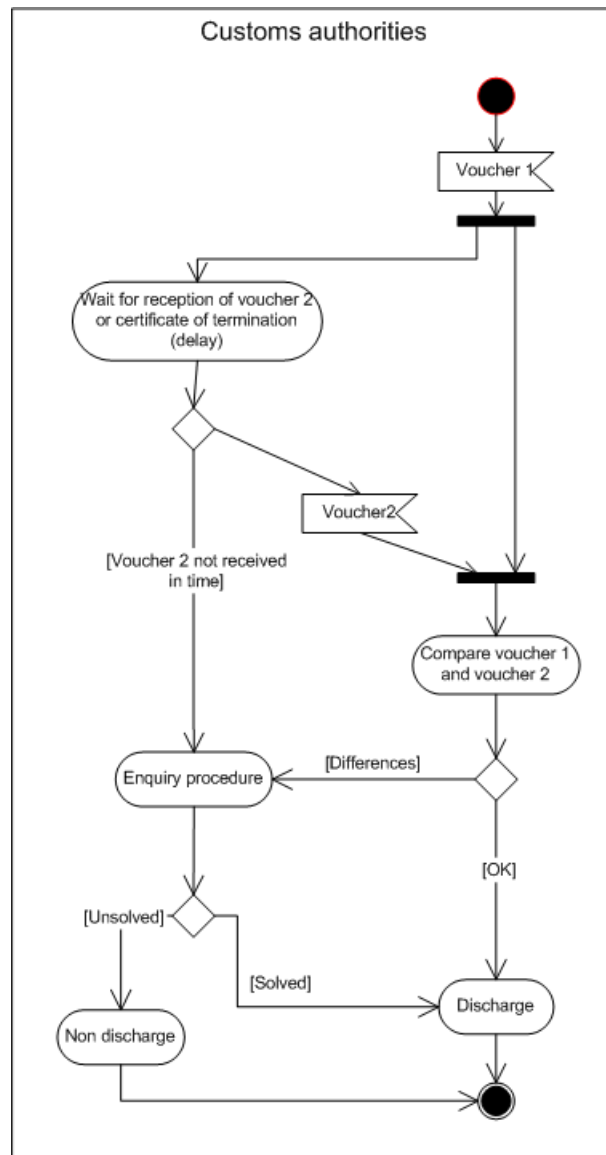

Figure 1.12 Discharge procedure activity diagram

Structured description of the activity diagram of the discharge use case

Two major scenarios can be envisaged depending on the national practice:

- a) The discharge procedure is performed by the Customs office that has started the TIR operation; in that case the Customs office that has terminated the TIR operation sends either voucher No. 2 or the certificate of termination to the Customs office having started the TIR operation.
- b) The discharge procedure is performed by a central Customs office; in that case both the Customs office that has started the TIR operation and the Customs office that has terminated the TIR operation send respectively voucher No. 1 and voucher No. 2 or the certificate of termination to a central Customs office.

Except from these differences all three scenarios are mainly similar.

1. The discharge procedure **BEGINS** when the Customs office responsible for the discharge receives voucher no. 1 duly filled-in. A deadline for the reception of voucher No. 2 is then fixed.

- If voucher No. 2 arrives before the deadline: **go to 2**
- If voucher No. 2 does not arrive before the deadline: **go to 3**

2. The information between voucher No. 1 and voucher No. 2 (or the certificate of termination) is compared.

- If the comparison leads Customs to the assumption that a Customs infringement has taken place and taxes and duties are due: **go to 3**
- If the comparison does not lead Customs to the conclusion that a Customs infringement has taken place and taxes and duties are due: **go to 4**

3. Inquiry procedures are launched:

- If the inquiry procedure concludes that a Customs infringement has not taken place and taxes and duties are not due: **go to 4**

4. The TIR operation is discharged: **END**

1.4.5 Start TIR operation use case

Start TIR operation use case diagram

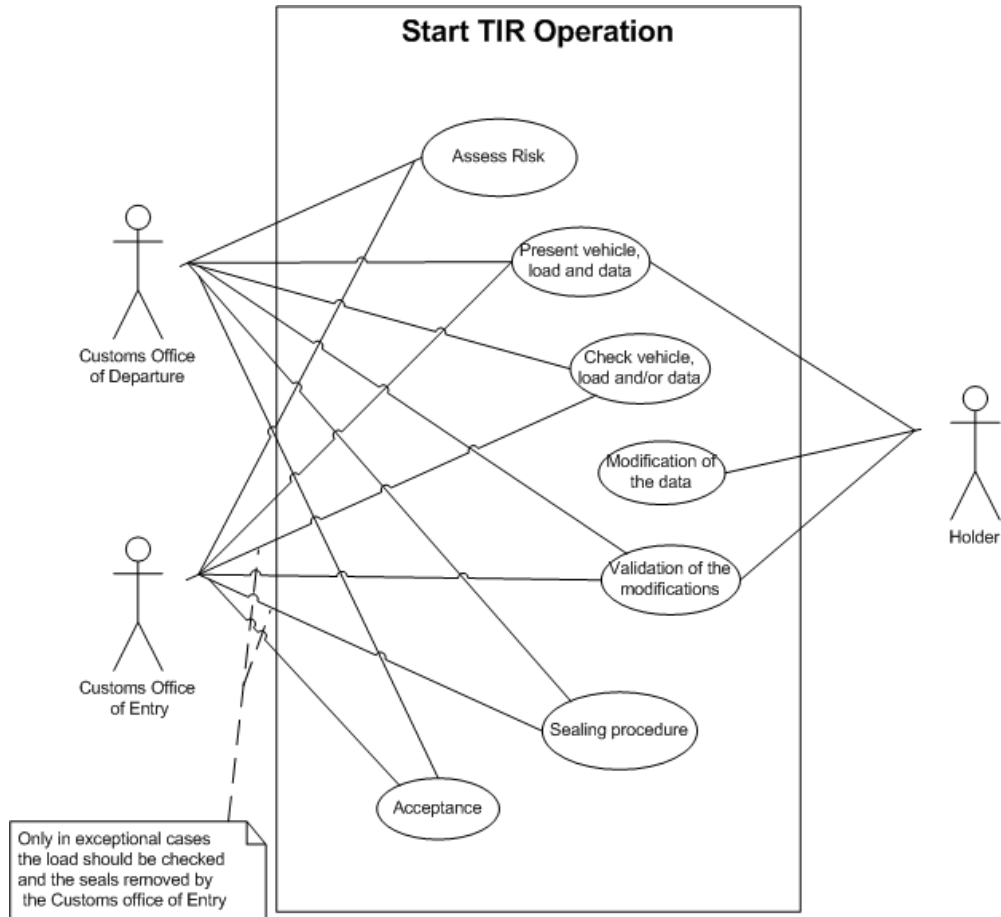

Figure 1.13 Start TIR operation use case diagram

Start TIR operation use case description

Use Case Name	Start TIR operation use case
Use Case Description	The TIR Carnet is filled-in by the TIR Carnet holder and presented with the vehicle and goods to the Customs office of departure; in continuation, TIR Carnet, vehicle and goods have to be presented at intermediate Customs offices of departure and/or Customs offices of entry (<u>en route</u>).
Actors	TIR Carnet holder, Customs authorities.
Performance Goals	Start a transit procedure in a given country (Customs territory) for a specific leg of the TIR Transport.
Preconditions	In accordance with the TIR Transport use case, this use case applies in one of the following situations: <ul style="list-style-type: none"> - At the beginning of the TIR transport: The TIR Carnet holder has provided and validated all information for the TIR transport; - In all other cases: The preceding TIR operation has been terminated.
Postconditions	In accordance with the TIR Carnet life cycle use case, this use case is followed by: <ul style="list-style-type: none"> - The termination of the TIR operation. In addition the discharge procedure is launched.
Scenario Customs office of Departure	An authorized TIR Carnet holder presents a valid and duly filled-in TIR Carnet, together with the goods and a TIR approved vehicle at the Customs office of departure. The Customs office of departure checks the data of the TIR Carnet and other accompanying documents with the load. The Customs office of departure seals the load compartment and validates the TIR Carnet by inserting the number and identification of the seals in field 16, and by applying the stamp, signature, date and name of the Customs office of departure in field 17 of all vouchers No. 1 and No. 2 of the TIR Carnet. The Customs officer completes fields 18 and 20 to 23 of the vouchers No. 1 and No. 2 corresponding to the TIR operation, completes counterfoil No. 1, removes voucher No. 1 and returns the TIR Carnet to the holder.
Scenario Customs office of entry	Upon presentation of the TIR Carnet by the holder, the Customs office of entry checks the seals and carries out a routine check of the truck and accompanying documents and may check the validity of the TIR Carnet in Cute-Wise. In exceptional cases, Customs authorities can require examination of road vehicle, combination of vehicles or containers and their load. The Customs officer validates the TIR Carnet by completing fields 18 to 23 of vouchers No. 1 and No. 2 corresponding to the TIR operation, completes counterfoil No. 1, removes voucher No. 1 and returns the TIR Carnet to the holder.
Scenario Intermediate Customs office	The holder presents the TIR Carnet, together with the goods, already loaded at a previous Customs office of departure, at the intermediate Customs office(s) of departure which acts in the same way as the Customs

of departure	office of departure: the Customs officer checks the data of the TIR Carnet and other accompanying documents with the load. He affixes new seals to the load compartment and validates the TIR Carnet by inscribing the number, identification of the seals in field 16, and by applying the stamp, signature, date and name of the intermediate Customs office of departure in field 17 of all vouchers No. 1 and No. 2 remaining in the TIR Carnet. He completes fields 18 and 20 to 23 of vouchers No. 1 and No. 2 corresponding to the TIR operation, completes counterfoil No. 1, removes voucher No. 1 and returns the TIR Carnet to the holder.
Alternative Scenario	The main scenarios do not take account of the following scenarios: a) Non validation of the TIR Carnet by Customs; b) Falsified acceptance of the TIR Carnet; c) Use of lost or stolen TIR Carnets.
Special requirements	In case of heavy and bulky goods with own identification marks, neither sealing nor a TIR approved vehicle is required. Specific identification marks will be mentioned in the TIR Carnet.
Extension Points	In the process of checking the validity of the TIR Carnet, Customs authorities may make use of information stored in the electronic control system maintained by the international organization.
Requirements Covered	

Activity diagram of the start TIR operation use case

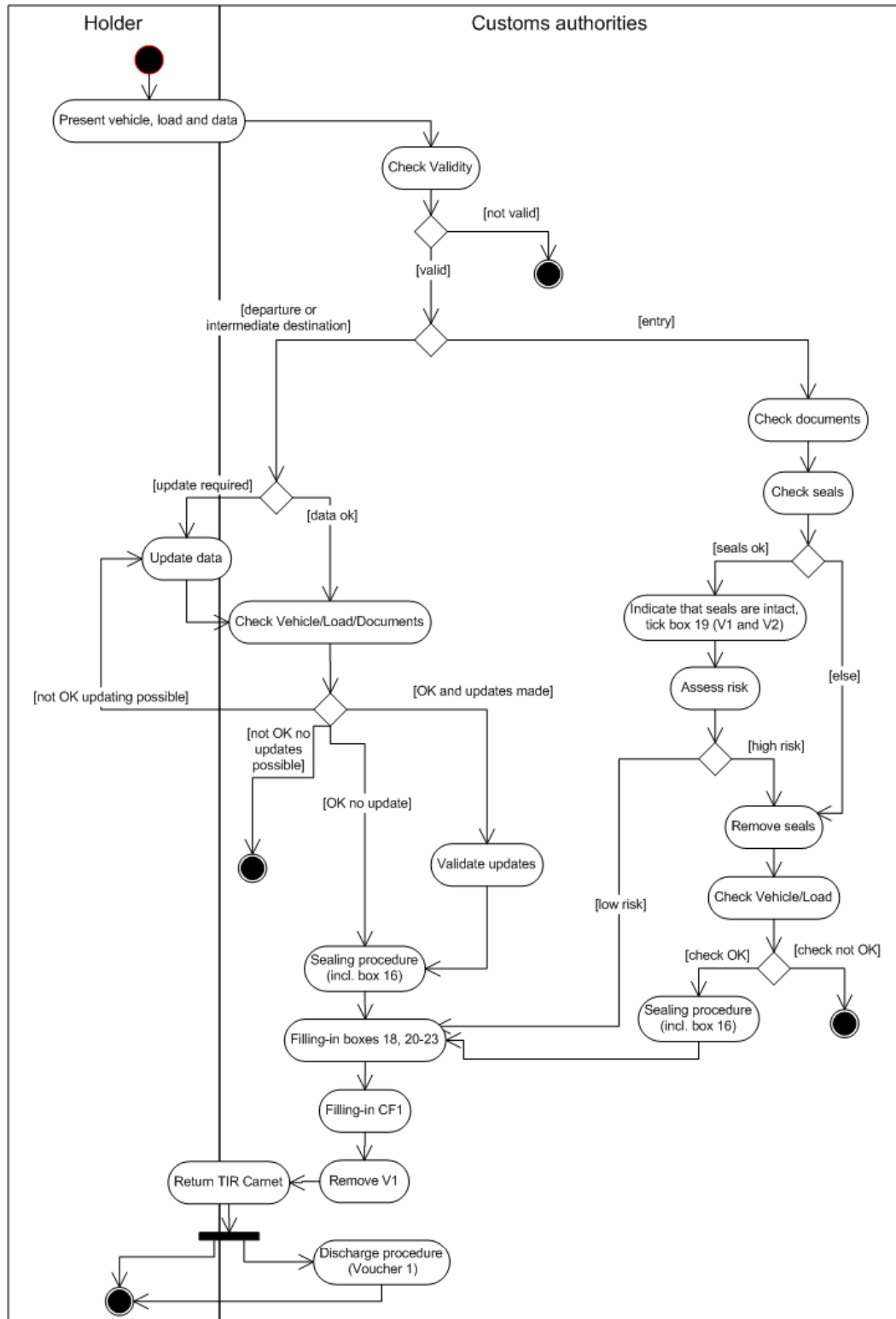

Figure 1.14 Start TIR operation activity diagram

Structured description of the activity diagram of the start TIR operation use case

1. The start of a TIR operation **BEGINS** when the TIR Carnet holder presents a valid and duly filled-in TIR Carnet, together with the goods and a TIR approved vehicle at a Customs office. The Customs officer first checks the validity of the TIR Carnet and **ENDS** the procedure if the TIR Carnet is not valid.
 - If the vehicle is at a Customs office of departure or at an intermediate Customs office of destination: **go to 1.1**;
 - If the vehicle at a Customs office of entry: **go to 1.2**.
- 1.1. If necessary, the TIR Carnet holder is requested to update the information in the TIR Carnet. The Customs office of departure checks the data of the TIR Carnet and other accompanying documents with the load.
 - If any problem is encountered: **go to 1.1.1**;
 - If checks are OK: **go to 1.1.2**.
- 1.1.1. Update the information on the TIR Carnet.
 - If updating is possible: **Go to 1.1.2**.
 - If no updating is possible: **END**.
- 1.1.2. In case any updating in the TIR Carnet has taken place (goods, itinerary,...) the Customs officer validates those changes by applying the stamp, signature, date and name of Customs office in field 17 of all vouchers No. 1 and No. 2 remaining in the TIR Carnet. **Go to 1.1.3**.
- 1.1.3. The Customs officer affixes (new) seals to the load compartment. He validates the TIR Carnet by inscribing the number and identification of the seals in field 16 of all vouchers No. 1 and No. 2 remaining in the TIR Carnet, **Go to 2**.
- 1.2. The Customs officer checks the data of the TIR Carnet and other accompanying documents, as well as the seals and carries out a routine check of the truck.
 - If checks are OK: **go to 1.2.1**;
 - If checks are not OK: **go to 1.2.2**
- 1.2.1. The Customs officer ticks box 19 on both vouchers 1 and 2 for the current operation and determines whether or not physical checking of the load is required.
 - If NO: **go to 2**;
 - If YES (exceptional cases): **go to 1.2.2**.
- 1.2.2. The Customs officer removes the seals and checks the load and compares it with the data of the TIR Carnet and other accompanying documents.
 - If everything is OK: **go to 1.1.3**;
 - If any problem is encountered: **END**.
2. - The Customs officer completes fields 18 and 20 to 23 of both vouchers No. 1 and No. 2 corresponding to the TIR operation,
 - he completes counterfoil No. 1,
 - he removes voucher No. 1,
 - he returns the TIR Carnet to the holder,
- he keeps or transmits the voucher number 1 for the discharge procedure: **END**.

1.4.6 Terminate TIR operation use case

Terminate TIR operation use case diagram

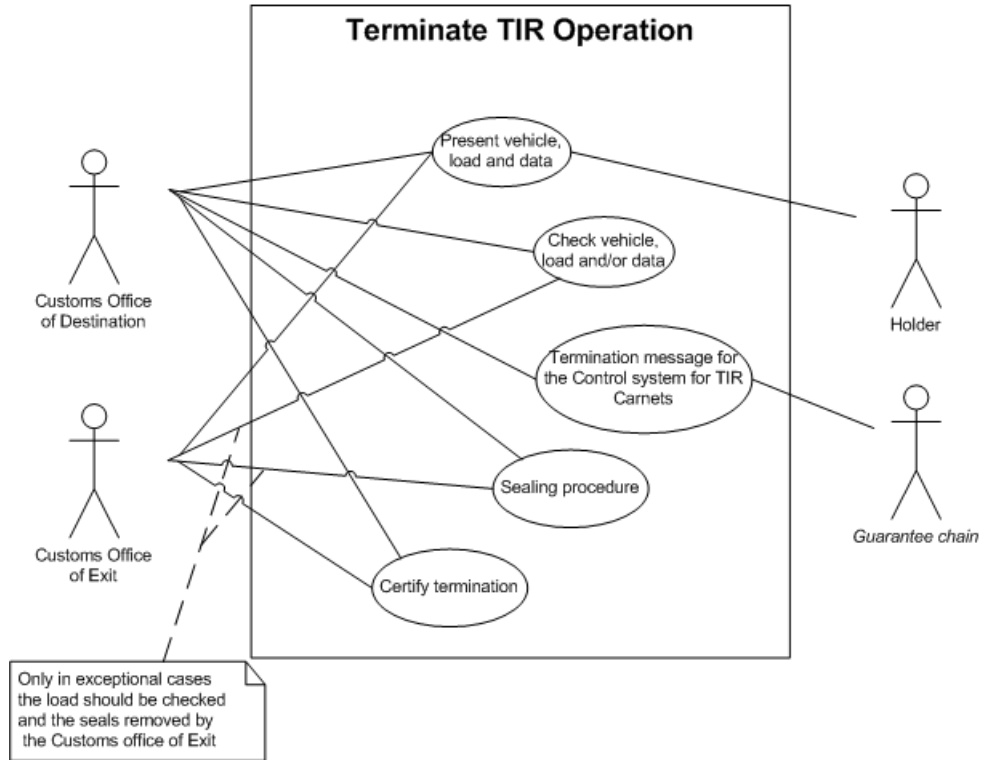

Figure 1.15 Terminate TIR operation use case diagram

Terminate TIR operation use case description

Name	Terminate TIR operation use case
Description	The road vehicle, the combination of vehicles or the container with the goods and the TIR Carnet are presented for purposes of control to the Customs office of exit, destination or to the intermediate Customs office of departure (playing the role of a Customs office of exit or destination ⁷).
Actors	TIR Carnet holder, Customs authorities, Guarantee chain.
Performance Goals	Terminate the transit procedure in a given country (Customs territory) for a specific leg of the TIR Transport.
Preconditions	In accordance with the TIR Transport use case, this use case can be launched only after the start of the TIR operation.
Postconditions	A termination message is sent to the control system for TIR Carnets Voucher N°2 or the certificate of termination is sent to the office in charge of the discharge of the TIR operation
Scenario 1	<p>Terminate TIR operation at the Customs office of exit en route:</p> <p>The holder presents the road vehicle, the goods and the TIR Carnet to the Customs Office of exit (<u>en route</u>) for purposes of control. The Customs officer checks the validity of the TIR Carnet, checks the integrity of the sealing devices, seals and their number against the seals' number mentioned in the TIR Carnet.</p> <p>The Customs officer may also examine all parts of the vehicle in addition to the sealed load compartment (Explanatory Note 0.21-1 to Article 21 of the TIR Convention).</p> <p>The Customs officer may exceptionally carry out an examination of the goods, particularly when an irregularity is suspected (Art. 5 par. 2 of the TIR Convention). In case of examination of the load of a road vehicle, combination of vehicles or the container, the Customs Officer affixes new seals and records on the TIR Carnet vouchers used in that Contracting Party, on the corresponding counterfoils, and on the vouchers remaining in the TIR Carnet, particulars of the new seals affixed and of the controls carried out (Art. 24 of the TIR Convention).</p> <p>If the checks are not satisfactory to the Customs officer, because he notices any irregularity in connection with the TIR operation itself, he may certify the termination of this TIR operation with reservation. In this case, the Customs officer completes field 24 of the appropriate detachable green sheet of voucher No. 2 by inscribing the name of the Customs office of exit (<u>en route</u>), crosses out box 25 (or does not cross out box 25, if the reason for the reservation is that seals or identification marks were indeed not found to be intact), completes field 27 by placing an "R" and fills-in field</p>

⁷ The procedure to terminate the TIR operation at an intermediate office of departure is slightly different than at Customs offices of exit or destination.

	<p>28 by putting a stamp, date and a signature. Then the Customs officer completes accordingly the corresponding green counterfoil namely by inscribing the name of the Customs office of exit (<u>en route</u>) in field 1, crossing out box 2 (or does not cross out box 2, if the reason for the reservation is that seals or identification marks were indeed not found to be intact), repeating “R” under item 5 inscribing the reason why the TIR operation is terminated with reservation, and completing field 6 by putting the Customs stamp, date and signature.</p> <p>If the checks are satisfactory to the Customs officer, he completes field 24 of the appropriate detachable green sheet of voucher No. 2 of the TIR Carnet by inscribing the name of the Customs office of exit (<u>en route</u>), crosses out box 25 and completes field 28 by putting a stamp, date and a signature. Then the Customs officer completes accordingly the corresponding green counterfoil namely by inscribing the name of the Customs office of exit (<u>en route</u>) in field 1, crossing out box 2 and completing field 6 by putting the Customs stamp, date and signature.</p> <p>After completing voucher and counterfoil number 2 with or without reservation, the Customs officer removes the green voucher number 2 of the TIR Carnet, and returns the TIR Carnet to the holder. The TIR operation is now terminated (Art. 1 lit. d of the TIR Convention). The Customs officer further tears off the detachable green sheet of voucher No. 2 of the TIR Carnet.</p>
Scenario 2	<p>Terminate TIR operation at the Customs office of destination:</p> <p>The holder presents the road vehicle, the goods and the TIR Carnet to the Customs Office of destination for purposes of control. The Customs officer checks the validity of the TIR Carnet, checks the integrity of the seals and their number against the seals’ number mentioned in the TIR Carnet.</p> <p>The Customs officer may also examine all parts of a vehicle in addition to the sealed load compartment (Explanatory Note 0.21-1 to Article 21 of the TIR Convention).</p> <p>The Customs officer takes the seals off and checks the goods.</p> <p>If the checks are not satisfactory to the Customs Officer because he noticed some irregularities connected with the TIR operation itself, he may certify the termination of this TIR operation with reservation. In this case, the Customs officer completes field 24 of the appropriate detachable green sheet of voucher No. 2 of the TIR Carnet by inscribing the name of the Customs office of destination, crosses out box 25 (or does not cross out box 25, if the reason for the reservation is that seals or identification marks were indeed not found to be intact), inscribes the number of packages for which the termination of the TIR operation is certified in field 26, completes field 27 by placing an “R” and fills-in field 28 by putting a stamp, date and a signature. Then the Customs officer completes accordingly the corresponding green counterfoil namely by inscribing the name of the Customs office of destination in field 1, crossing out box 2 (or does not cross out box 2, if the reason for the reservation is that seals or identification marks were indeed not found to be intact), inscribing the number of packages for which the termination of the TIR operation is</p>

	<p>certified in field number 3, repeating “R” under item 5 inscribing the reason why the TIR operation is terminated with Reservation, and completing field 6 by putting the Customs stamp, date and signature.</p> <p>If the checks are satisfactory to the Customs officer, he completes field 24 of the appropriate detachable green sheet of voucher No. 2 of the TIR Carnet by inscribing the name of the Customs office of destination, crosses out box 25, inscribes the number of packages for which the termination of the TIR operation is certified in field 26 and completes field 28 by putting a stamp, date and a signature. Then the Customs officer completes accordingly the corresponding green counterfoil namely by inscribing the name of the Customs office of destination in field 1, crossing out box 2, inscribing the number of packages for which the termination of the TIR operation is certified in field number 3, and completing field 6 by putting the Customs stamp, date and signature.</p> <p>After completing voucher and counterfoil No. 2 with or without reservation, the Customs officer removes the green voucher No. 2 of the TIR Carnet and returns the TIR Carnet to the holder. The Customs officer further tears off the detachable green sheet of voucher No. 2 of the TIR Carnet, keeps the upper part of the green voucher number 2 at the Customs office of destination.</p> <p>The TIR operation is now terminated (Art. 1(d) of the TIR Convention). The Customs office of destination sends the SafeTIR message confirming the correct termination of the TIR operation at the Customs office of destination to the competent national guaranteeing association.</p> <p>The Customs officer sends the detachable green sheet to the Customs office of entry (en route).</p>
Scenario 3	<p>Intermediate Customs office of destination</p> <p>In case a TIR transport consists of various part loads, one or two TIR operations will be terminated at intermediate Customs offices of destination. Such Customs office will play both the role of Customs office of destination (see scenario 2) as well as of Customs office of departure (see also: Use Case 1.4.5.)</p>
Alternative Scenario	<p>The main scenarios do not take account of the following scenarios:</p> <ol style="list-style-type: none"> 1. Non validation of the TIR Carnet by Customs; 2. Falsified acceptance of the TIR Carnet; 3. Use of lost or stolen TIR Carnets
Special requirements	<p>Goods which have arrived at their Customs office of destination are no longer under the TIR regime. Therefore, they are put under another Customs regime.</p>
Extension Points	<p>In the process of checking the validity of the TIR Carnet, Customs authorities may make use of information stored in the electronic control system maintained by the international organization.</p>
Requirements Covered	-

Activity diagram of the terminate TIR operation use case

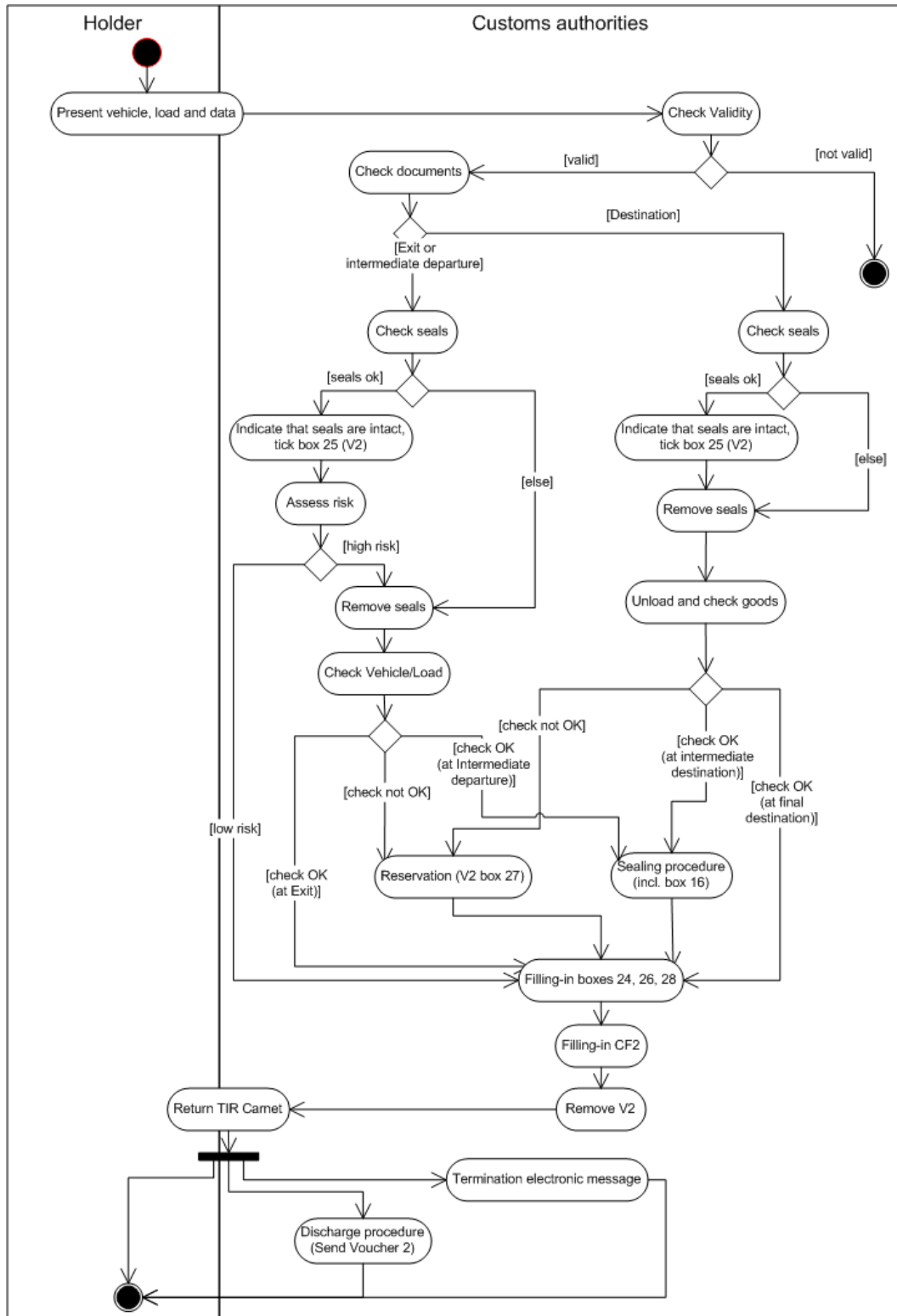

Figure 1.16 Terminate TIR operation activity diagram

Structured description of the activity diagram of the terminate TIR operation use case

1. The termination of a TIR operation **BEGINS** when the TIR Carnet holder presents a valid and duly filled-in TIR Carnet, together with the goods and a TIR approved vehicle at a Customs office (exit, destination or intermediate office of departure). The Customs officer may first check the validity of the TIR Carnet and **END** the procedure if the TIR Carnet is not valid.
The Customs officer may also examine all parts of the vehicle in addition to the sealed load compartment (Explanatory Note 0.21-1 to Article 21 of the TIR Convention).
 - Customs of destination: **go to 1.1;**
 - Customs of exit or intermediate departure: **go to 1.2;**
 - 1.1. The Customs officer checks the integrity of all seals and their number against the seals' number(s) mentioned in the TIR Carnet
 - If seals are OK: **go to 1.1.1;**
 - If seals are not OK: **go to 1.1.2.**
 - 1.1.1. Indicate that seals were intact by ticking box 25 in voucher N°2; **Go to 1.1.2.**
 - 1.1.2. The Customs officer takes the seals off and checks the goods
 - If checks are OK at intermediate Customs office of destination: **go to 1.2.2.1;**
 - If checks are OK at final Customs office of destination: **go to 3;**
 - If checks are not OK: **go to 2.**
 - 1.2. The Customs officer checks the integrity of all seals and their number against the seals' number(s) mentioned in the TIR Carnet
 - If seals are OK: **go to 1.2.1;**
 - If seals are not OK: **go to 1.2.2.**
 - 1.2.1. The Customs officer indicates that seals are intact by ticking box 25 in voucher N°2; he determines whether or not physical checking of the load is required:
 - If YES: **go to 1.2.2;**
 - If NO: **go to 3.**
 - 1.2.2. The Customs officer removes the seals and checks the load and vehicle.
 - If everything is OK at Customs office if exit: **go to 1.2.2.1;**
 - If everything is OK at intermediate Customs office of departure: **go to 3;**
 - If a problem is encountered: **go to 2.**
 - 1.2.2.1. The Customs officer affixes new seals and records on the TIR Carnet vouchers used in that Contracting Party, on the corresponding counterfoils, and on the vouchers remaining in the TIR Carnet, particulars of the new seals affixed and of the controls carried out (Art. 24 of the TIR Convention): **go to 3.**

2. The Customs certifies the termination of the TIR operation with reservation. In this case, the Customs officer completes field 27 by placing an "R": **go to 3.**
3. - The Customs officer completes fields 24, 26 and 28 of voucher No. 2 corresponding to the TIR operation;
 - he completes counterfoil No. 2;
 - he removes voucher No. 2;
 - he returns the TIR Carnet to the holder;
 - he also should send an electronic message to the control system for TIR Carnets;
 - and finally send a termination message to the discharge office (see discharge use case for details): **END.**

1.5 Entity classes

Entity classes describe “things” representing characteristics within the TIR procedure, which can take on a certain value or responsibility. Examples of entity classes are persons, places, concepts or situations.

In the TIR procedure, the following classes have been identified:

- International Organization
- Association
 - Issuing Association
 - Guaranteeing Association
- Road Vehicle
- Sealed loading unit
 - Load compartment
 - Container
- TIR transport
- TIR operation
- Goods Manifest Line Item
- Customs office
- Country
- TIR Carnet holder

1.6 High-level class diagram

1.6.1 High-level class diagram description

The following diagrams are sub parts of the complete high-level class diagram shown in Chapter 1.6.2. This subdivision aims at simplifying the explanation by focusing on a specific class at a time, describing its particularities and analyzing its relations with other classes.

*In order to fully understand its complexity, the following diagrams reflect the various parts of the high-level class diagram of **Figure ??**, as seen from the perspective of its main classes.*

International organization

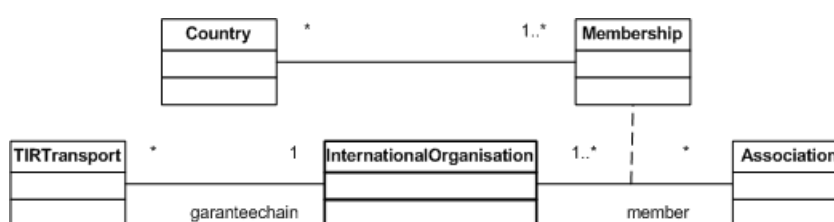

Figure 1.17 International organization class and its relationships

Name	International organization sub class diagram
Description	Sub part of the high-level class diagram presenting the international organization class and all relations with other classes.
Central Class	International organization
Example instance of the central class	<ul style="list-style-type: none"> ○ IRU ○ ...
Associated Classes	TIR transport, association
Associations and constraints	<p>The international organization organizes and ensures the proper functioning of the guarantee chain for a TIR transport. A TIR transport can be associated to one and only one international organization. The international organization can represent the guarantee chain for an unlimited number of transports. (Req. 1)</p> <p>The international organization has member associations. The membership is associated to at least one country. An association has to be member of at least one international organization. An international organization can have any number of member associations. A membership can be associated to various countries (e.g. FEBETRA –IRU has a membership valid for Belgium and Luxembourg) and one country can be covered by various memberships. (Req. 2)</p>
Requirements Covered	1 and 2

Table 1.3 International organization sub class diagram description

Association

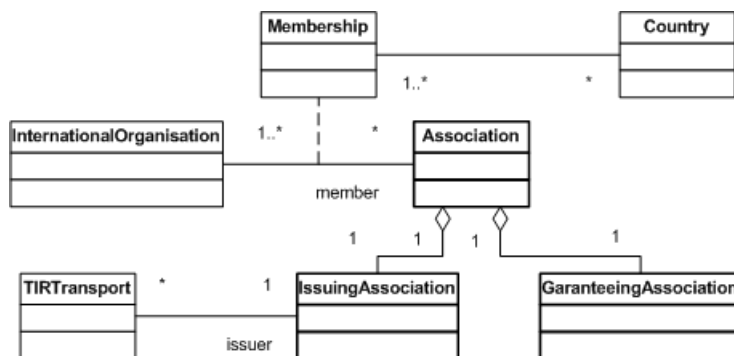

Figure 1.18 Association class and its relationships

Name	Association sub class diagram
Description	Sub part of the high-level class diagram presenting the association class and all relations with other classes.
Central Class	Association
Example instance of the central class	<ul style="list-style-type: none"> o FEBETRA o BGL o ...
Associated Classes	TIR transport, international organization
Associations and constraints	<p>An association has two roles represented by the subdivision of the association into its issuing role (the issuing association), responsible of the issuance of TIR Carnets to the TIR Carnet holders, and its guaranteeing role (the guaranteeing association), representing the guarantee chain in its national territory. The two roles cannot be disconnected. (Req. 3)</p> <p>The international organization has member associations. The membership is associated to at least one country. An association has to be member of at least one international organization. An international organization can have any number of member associations. A membership can be associated to various countries (e.g. FEBETRA –IRU has a membership valid for Belgium and Luxembourg) and one country can be covered by various memberships. (Req. 2)</p> <p>The issuing association issues TIR Carnets for TIR transports. One and only one issuing association is issuing the TIR Carnet for a TIR transport. The issuing association can issue TIR Carnets for numerous TIR transports. (Req. 4)</p>
Requirements Covered	2, 3 and 4

Table 1.4 Association sub class diagram description

Road vehicle

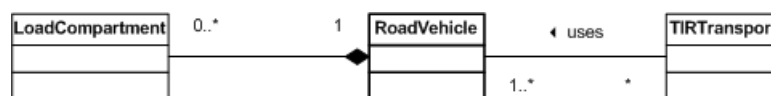

Figure 1.19 Road vehicle class and its relationships

Name	Road vehicle sub class diagram
Description	Sub part of the high-level road vehicle class diagram presenting the class and all relations with other classes.
Central Class	Road vehicle
Example instance of the central class	<ul style="list-style-type: none"> ○ Road tractor (Brand W, Model X, Chassis ref. Number Y, Plates ZZZZ) ○ Semi-Trailer (Brand M, Model N, Chassis ref. Number O, Plates PPPP) ○ ...
Associated Classes	Load compartment, TIR transport
Associations and constraints	<p>A road vehicle can serve in numerous TIR transports. A TIR transport is performed by means of one or many road vehicles. (Req. 6)</p> <p>A road vehicle is composed of zero or many load compartments. A load compartment is part of a single road vehicle. (Req. 7)</p>
Requirements Covered	6 and 7

Table 1.5 Road vehicle sub class diagram description

Sealed loading unit

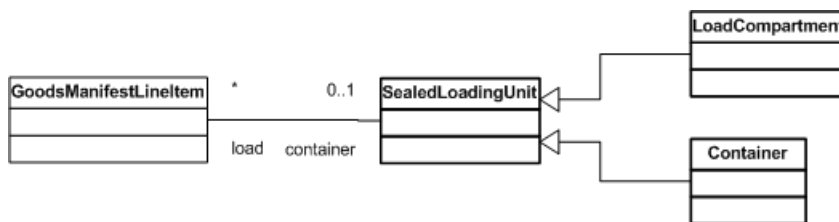

Figure 1.20 Sealed loading unit class and its relationships

Name	Sealed loading unit sub class diagram
Description	Sub part of the high-level class diagram presenting the sealed loading unit class and all relations with other classes.
Central Class	Sealed loading unit
Example instance of the central class	<ul style="list-style-type: none"> o Container n° xxxxxxxxx o Load compartment of road vehicle of brand W, model X, chassis ref. Number Y and Plates ZZZZ approved for transports under customs seals. o ...
Associated Classes	Goods Manifest Line Item
Associations and constraints	<p>A sealed loading unit is a generalization of a container and a load compartment of a road vehicle. (Req. 8)</p> <p>A sealed loading unit can contain numerous loads, mentioned in the TIR Carnet as Goods Manifest Line Items. The goods described in the Goods Manifest Line Item are contained in one and only one sealed loading unit. In case of heavy and bulky goods (HBG), the goods described in the Goods Manifest Line Item may not be contained in a sealed loading unit. (Req. 9)</p>
Requirements Covered	8 and 9

Table 1.6 Sealed loading unit sub class diagram description

TIR transport

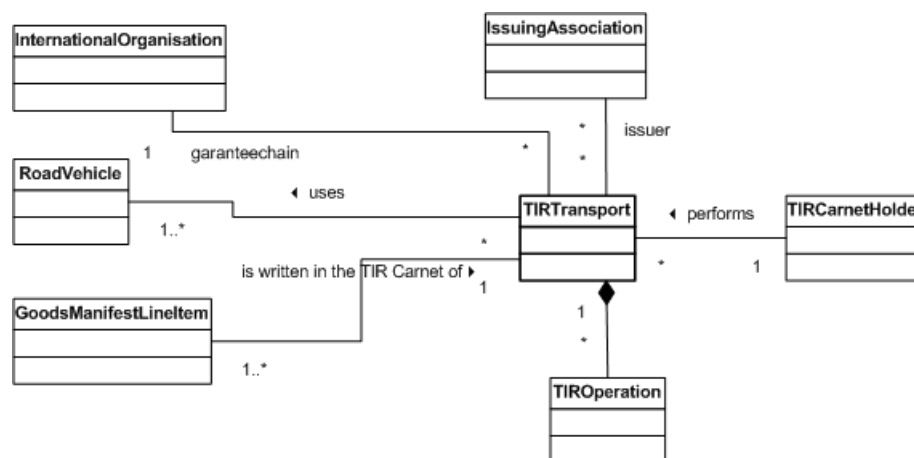

Figure 1.21 TIR transport class and its relationships

Name	TIR transport sub class diagram
Description	Sub part of the high-level class diagram presenting the TIR transport class and all relations with other classes.
Central Class	TIR transport
Example instance of the central class	<ul style="list-style-type: none"> ○ Transport of 2000kg of chocolate from Geneva to Moscow under cover of the TIR Carnet No. XC38000000. ○ Transport of 100 computers from Ankara to Madrid under cover of the TIR Carnet No. XC38999999. ○ ...
Associated Classes	International organization, issuing association, road vehicle, TIR operation, Goods Manifest Line Item, TIR Carnet holder.

Associations and constraints	<p>The international organization organizes and ensures the proper functioning of the guarantee chain for a TIR transport. A TIR transport can be associated to one and only one international organization. The international organization can represent the guarantee chain for an unlimited number of transports. (Req. 1)</p> <p>The issuing association issues TIR Carnets for TIR transports. One and only one issuing association is issuing the TIR Carnet for a TIR transport. The issuing association can issue TIR Carnets for numerous TIR transports. (Req. 4)</p> <p>A road vehicle can serve in numerous TIR transports. A TIR transport is performed by means of one or many road vehicles. (Req. 6)</p> <p>A TIR transport is composed of TIR operations. The number of TIR operations within a TIR transport is at the moment limited to ten with the current paper system and has a minimum of two (these limitations should be extensible; therefore, two to many is more advisable). A TIR operation is part of one and only one TIR transport. (Req.10)</p> <p>A Goods Manifest Line Item is associated to one and only one TIR transport. A TIR transport can have from one to many Goods Manifest Line Items. (Req.11)</p> <p>A TIR transport is performed by one and only one TIR Carnet holder. A TIR Carnet holder can perform any number of TIR transports. (Req. 12)</p>
Requirements Covered	1,4,6,10,11 and 12

Table 1.7 TIR transport sub class diagram description

TIR operation

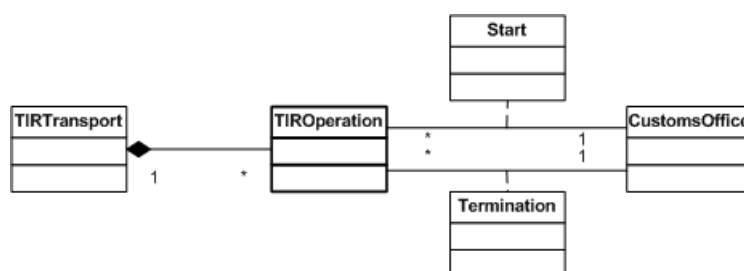

Figure 1.22 TIR operation class and its relationships

Name	TIR operation sub class diagram
Description	Sub part of the high-level class diagram presenting the TIR operation class and all relations with other classes.
Central Class	TIR operation
Example instance of the central class	<ul style="list-style-type: none"> o A transit operation through Switzerland under cover of TIR Carnet N° XC380000XX starting in Geneva and terminated in Basel. o The first operation of a TIR transport under cover of TIR Carnet N° XC380000YY, starting in Moscow and terminated at the border point with Finland in Vyborg. o ...
Associated Classes	TIR transport, Customs office
Associations and constraints	<p>A TIR transport is composed of TIR operations. The number of TIR operations within a TIR transport is at the moment limited to ten with the current paper system and has a minimum of two (these limitations should be extensible; therefore, two to many is more advisable). A TIR operation is part of one and only one TIR transport. (Req.10)</p> <p>The TIR operation is started at one and only one Customs office and terminated at one and only one Customs office. A Customs office can start and terminate any number of TIR operations. (Req. 13)</p>
Requirements Covered	10, 13

Table 1.8 TIR operation sub class diagram description

Goods Manifest Line Item

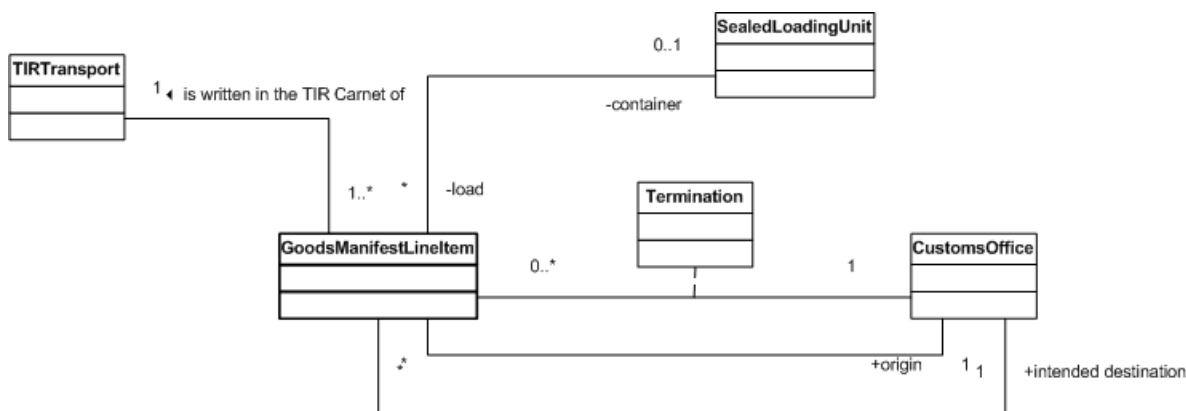

Figure 1.23 Goods Manifest Line Item class and its relationships

Name	Goods Manifest Line Item sub class diagram
Description	Sub part of the high-level class diagram presenting the Goods Manifest Line Item class and all relations with other classes.
Central Class	TIR consignment element
Example instance of the central class	<ul style="list-style-type: none"> ○ 200 kg of chocolate loaded in Geneva transported under cover of TIR Carnet N° XC380000ZZ with destination Budapest. ○ 10 cars loaded in Turin transported under cover of TIR Carnet N° XC380000VV with destination Budapest. ○ ...
Associated Classes	Sealed loading unit, Customs office, TIR Transport
Associations and constraints	<p>A sealed loading unit can contain numerous loads, mentioned in the TIR Carnet as Goods Manifest Line Items. The goods described in the Goods Manifest Line Item are contained in one and only one sealed loading unit. In case of heavy and bulky goods (HBG), the goods described in the Goods Manifest Line Item may not be contained in a sealed loading unit. (Req. 9)</p> <p>A Goods Manifest Line Item is associated to one and only one TIR transport. A TIR transport can have from one to many Goods Manifest Line Item. (Req. 11)</p> <p>The goods described in one single Goods Manifest Line Item arrive at and have their termination certified by one and only one Customs office. A Customs office can “terminate” any number of goods described in Goods Manifest Line Items. (Req.14)</p> <p>A Goods Manifest Line Item has one and only one intended Customs office of destination. A Customs office can be the intended destination of numerous Goods Manifest Line Items. (Req. 15)</p>

	The goods described in a Goods Manifest Line Item are loaded at a single Customs office of departure. A Customs office can be the departure for any number of goods described in Goods Manifest Line Items. (Req.17)
Requirements Covered	9, 11, 14,15 and 17

Table 1.9 Goods Manifest Line Item sub class diagram description

Customs office

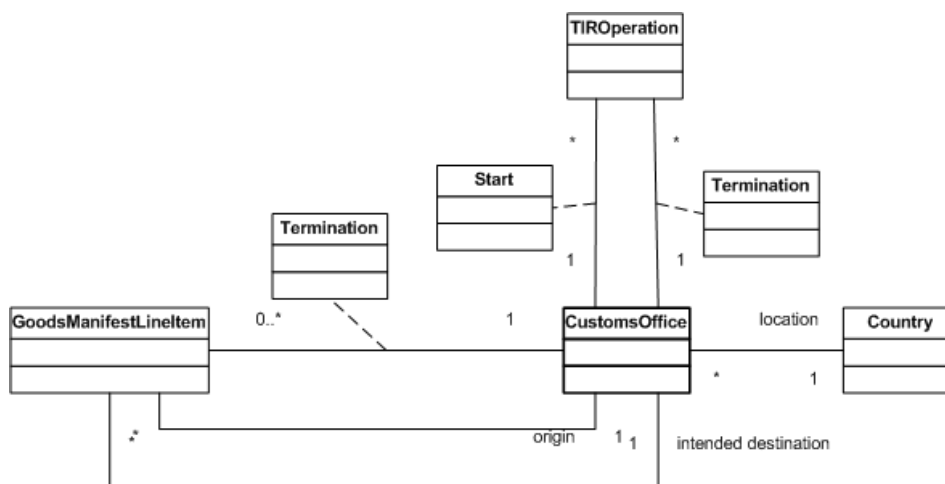

Figure 1.24 Customs office class and its relationships

Name	Customs office sub class diagram
Description	Sub part of the high-level class diagram presenting the Customs office class and all relations with other classes.
Central Class	Customs office
Example instance of the central class	o ??
Associated Classes	TIR operation, Goods Manifest Line Item, Country
Associations and constraints	<p>The TIR operation is started at one and only one Customs office and terminated at one and only one Customs office. A Customs office can start and terminate any number of TIR operations. (Req. 13)</p> <p>The goods described in one single Goods Manifest Line Item arrive at and have their termination certified by one and only one Customs office of destination. A Customs office can “terminate” any number of goods described in Goods Manifest Line Items. (Req.14)</p> <p>A Goods Manifest Line Item has one and only one intended Customs office of destination. A Customs office can be the intended destination of numerous goods described in Goods Manifest Line Items. (Req. 15)</p> <p>The goods described in a Goods Manifest Line Item are loaded at a</p>

	<p>single Customs office of departure. A Customs office can be the departure for any number of goods described in Goods Manifest Line Items. (Req.17)</p> <p>A Customs office is located in one and only one Contracting Party. A Contracting Party can have any number of Customs offices. (Req. 18)</p>
Requirements Covered	13,14, 15,17 and 18

Table 1.10 Customs office sub class diagram description

Country

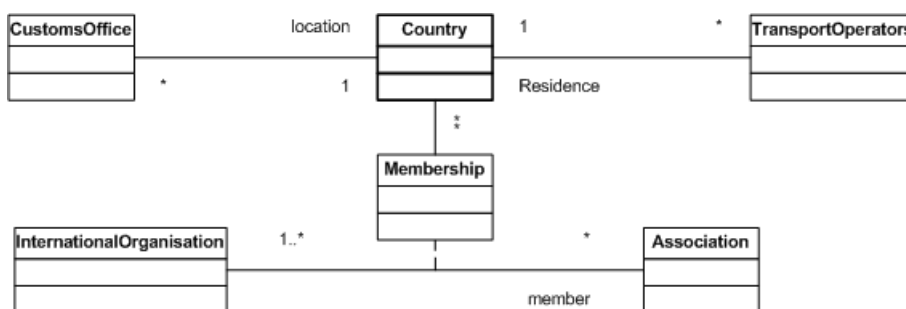

Figure 1.25 Country class and its relationships

Name	Country sub class diagram
Description	Sub part of the high-level class diagram presenting the country class and all relations with other classes.
Central Class	Country
Example instance of the central class	<ul style="list-style-type: none"> o Switzerland o Luxembourg o ...
Associated Classes	Membership (international organization and association), Customs office, transport operator
Associations and constraints	<p>The international organization has member associations. The membership is associated to at least one country. An association has to be member of at least one international organization. An international organization can have any number of member associations. A membership can be associated to various countries (e.g. FEBETRA –IRU has a membership valid for Belgium and Luxembourg) and one country can be covered by various memberships. (Req. 2)</p> <p>A Customs office is located in one and only one Contracting Party. A Contracting Party can have any number of Customs offices (Req. 18)</p> <p>A transport operator is established in one and only one Contracting</p>

	Party. A Contracting Party can be the residence of numerous transport operators. (Req. 19)
Requirements Covered	2, 18 and 19

Table 1.11 Country sub class diagram description

TIR Carnet Holder

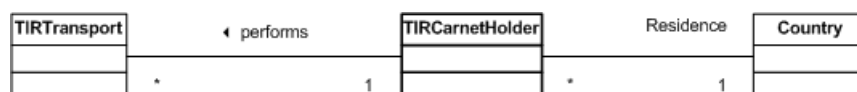

Figure 1.26 Transport operator class and its relationships

Name	TIR Carnet Holder sub class diagram
Description	Sub part of the high-level class diagram presenting the transport operator class and all relations with other classes.
Central Class	TIR Carnet Holder
Example instance of the central class	<ul style="list-style-type: none"> ○ THALMANN TRANSPORTE AG ○ RAB-TRANS - Sp.z o.o. ○ ...
Associated Classes	TIR transport, country
Associations and constraints	<p>A TIR transport is performed by one and only one TIR Carnet holder. A TIR Carnet holder can perform any number of TIR transports. (Req. 12)</p> <p>A transport operator is established in one and only one Contracting Party. A Contracting Party can be the residence of numerous transport operators. (Req. 19)</p>
Requirements Covered	12 and 19

Table 1.12 Transport operator sub class diagram description

1.6.2 High-level class diagram

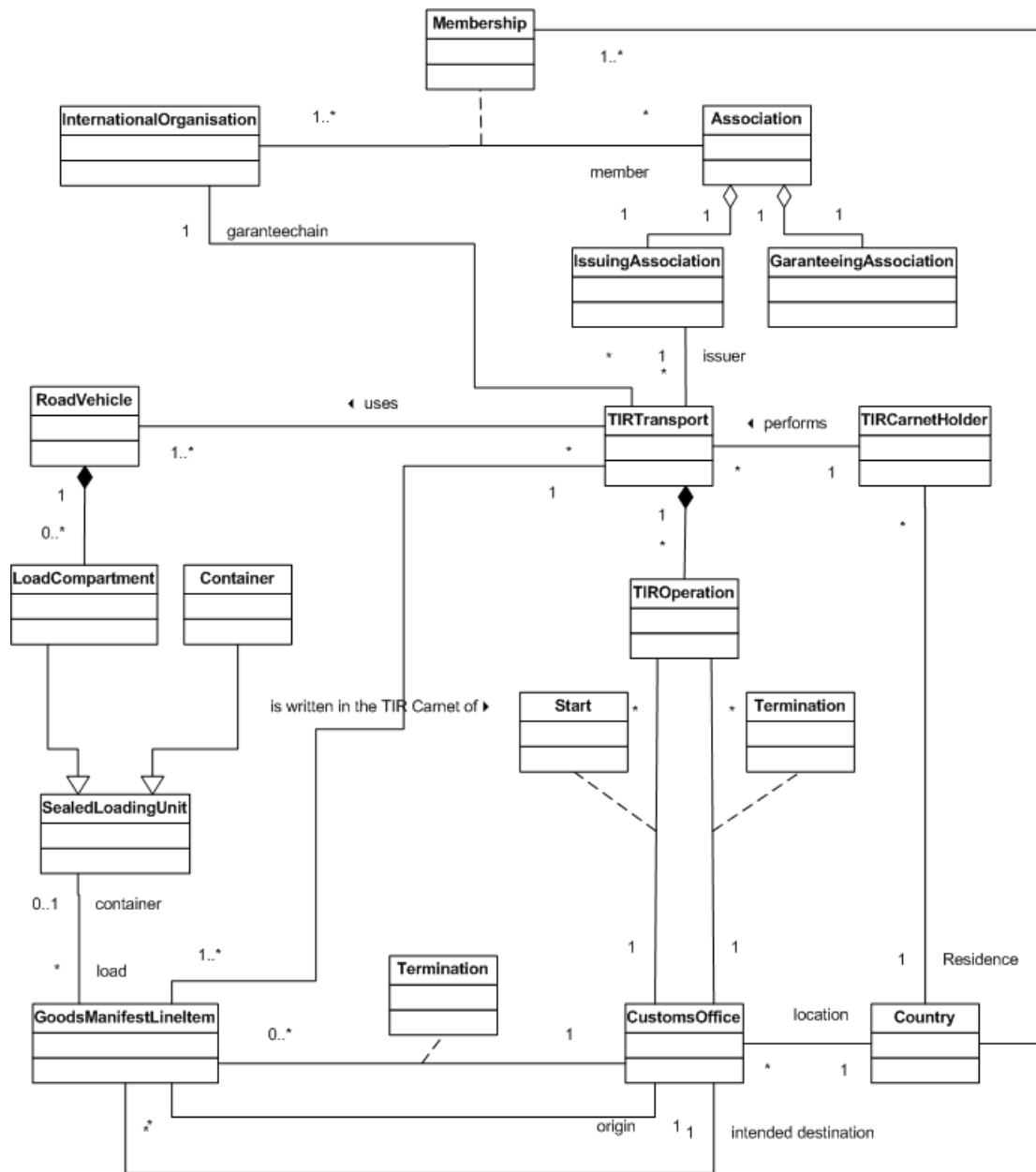

Figure 1.27 High-level class diagram

2. e-Business requirements

To be filled-in at a later stage.

3. Analysis workflow

To be filled-in at a later stage.

4. Design workflow

To be filled-in at a later stage.

Annex 1 – Requirements list

The requirements list provides an artefact for storing discrete, measurable business requirements and constraints. As requirements and constraints are discovered in performing the modelling steps they are added to this running list by the secretariat. Note: requirements shall be referenced in all modelling artefacts, and if necessary, each requirement should reference modelling artefact(s) that are based on it.

Req. #	Statement	Source	Date	Status
1	The international organization organizes and ensures the proper functioning of the guarantee chain for a TIR transport. A TIR transport can be associated to one and only one international organization. The international organization can represent the guarantee chain for an unlimited number of transports.	ExG Warsaw	28-29 June 2004	Used in 1.6
2	The international organization has member associations. The membership is associated to at least one country. An association has to be member of at least one international organization. An international organization can have any number of member associations. A membership can be associated to various countries (e.g. FEBETRA –IRU has a membership valid for Belgium but also for Luxembourg) and one country can be covered by various memberships.	ExG Warsaw	28-29 June 2004	Used in 1.6
3	An association has two roles represented by the subdivision of the association into its issuing role (issuing association), responsible for the issuance of TIR Carnets to the TIR Carnets holders, and its guaranteeing role (guaranteeing association), representing the guarantee chain in its national territory. The two roles cannot be disconnected	ExG Warsaw	28-29 June 2004	Used in 1.6
4	The issuing association issues TIR Carnets for TIR transports. One and only one issuing association is issuing the TIR Carnet for a TIR transport. The issuing association can issue TIR Carnets for numerous TIR transports.	ExG Warsaw	28-29 June 2004	Used in 1.6
5	Deleted			
6	A road vehicle can serve in numerous TIR transports. A TIR transport is performed by means of one or many road vehicles.	ExG Warsaw	28-29 June 2004	Used in 1.6
7	A road vehicle is composed of zero or many load compartments. A load compartment is part of a single road vehicle.	ExG Warsaw	28-29 June 2004	Used in 1.6
8	A sealed loading unit is a generalization of a container and a load compartment of a road vehicle.	ExG Warsaw	28-29 June 2004	Used in 1.6
9	A sealed loading unit can contain numerous loads, mentioned in the TIR Carnet as Goods Manifest Line Items. The goods described in the Goods Manifest Line Item are contained in one and only one sealed loading unit. In case of heavy and bulky goods (HBG), the goods described in the Goods Manifest Line Item may not be contained in a sealed loading unit.			Used in 1.6

10	A TIR transport is composed of TIR operations. The number of TIR operations within a TIR transport is at the moment limited to ten with the current paper system and has a minimum of two (these limitations should be extensible; therefore, two to many is more advisable). A TIR operation is part of one and only one TIR transport.	ExG Warsaw	28-29 June 2004	Used in 1.6
11	A Goods Manifest Line Item is associated to one and only one TIR transport. A TIR transport can have from one to many Goods Manifest Line Items.			Used in 1.6
12	A TIR transport is performed by one and only one TIR Carnet holder. A TIR Carnet holder can perform any number of TIR transports.	ExG Warsaw	28-29 June 2004	Used in 1.6
13	The TIR operation is started at one and only one Customs office and terminated at one and only one Customs office. A Customs office can start and terminate any number of TIR operations.	ExG Warsaw	28-29 June 2004	Used in 1.6
14	The goods described in one single Goods Manifest Line Item arrive at and have their termination certified by a one and only one Customs office of destination. A Customs office can "terminate" any number of goods described in Goods Manifest Line Items.			Used in 1.6
15	A Goods Manifest Line Item has one and only one intended Customs office of destination. A Customs office can be the intended destination of numerous Goods Manifest Line Items.			Used in 1.6
16	Deleted			
17	The goods described in a Goods Manifest Line Item are loaded at a single Customs office of departure. A Customs office can be the departure for any number of goods described in Goods Manifest Line Items.			Used in 1.6
18	A Customs office is located in one and only one Contracting Party. A Contracting Party can have any number of Customs offices.	ExG Warsaw	28-29 June 2004	Used in 1.6
19	A transport operator is established in one and only one Contracting Party. A Contracting Party can be the residence of numerous transport operators.	ExG Warsaw	28-29 June 2004	Used in 1.6
20	The printing and distribution of TIR Carnets can only be performed by an approved international organization.	ExG Geneva	26-27 October 2004	Used in 1.2.1
21	Only an approved association can issue TIR Carnets.	ExG Geneva	26-27 October 2004	Used in 1.2.1
22	TIR Carnets shall be issued only to authorized persons.	ExG Geneva	26-27 October 2004	Used in 1.2.1
23	A TIR transport can only be performed by means of road vehicles, combinations of vehicles or containers previously approved under the conditions set forth in Chapter III of the Convention.	ExG Geneva	26-27 October 2004	Used in 1.2.1
24	A TIR transport must be performed under cover of a TIR Carnet.	ExG Geneva	26-27 October 2004	Used in 1.2.1
25	A TIR transport must be guaranteed by associations approved in accordance with the provisions of Article 6 of	ExG Geneva	26-27 October	Used in 1.2.1

	the Convention.		2004	
26	Customs authorities can use national and international risk analysis data to assess risk in relation to the TIR transport.	ExG Geneva	26-27 October 2004	Used in 1.2.1
27	When the TIR transport has ended, the TIR Carnet is returned to the holder, then to the association and finally to the international organization.	ExG Geneva	26-27 October 2004	Used in 1.2.1
28	The international organization and the associations uses the control system for TIR Carnets to check TIR Carnets.	ExG Geneva	26-27 October 2004	Used in 1.2.1
29	The international organization can perform risk analysis with data stored in the repository.	ExG Geneva	26-27 October 2004	Used in 1.2.1
30	Risk analysis can be performed with data from the control system for TIR Carnets.	ExG Geneva	26-27 October 2004	Used in 1.2.1
31	The control system for TIR Carnets stores data regarding the distribution of TIR Carnets.	ExG Geneva	26-27 October 2004	Used in 1.2.1
32	The control system for TIR Carnets stores data on the termination of TIR operation at Customs offices of destination as transmitted by Customs authorities.	ExG Geneva	26-27 October 2004	Used in 1.2.1
33	The TIR procedure as laid down in the TIR Convention.	ExG Geneva	26-27 October 2004	Used in 1.2.1
34	All through the TIR transport, national Customs authorities need the information in the TIR Carnet to feed their national systems.	ExG Geneva	26-27 October 2004	Used in 1.2.1
35	All through the TIR transport, national Customs authorities need data from their national systems to feed the TIR Carnet.	ExG Geneva	26-27 October 2004	Used in 1.2.1

Annex 2 – TIR glossary

The TIR glossary captures any terms and acronyms the reader might need to understand about the TIR procedure domain. The glossary is maintained in a running list by the secretariat throughout the requirements gathering/modelling process. This document is used to define terminology associated with TIR procedure business process modelling as well as terminology specific to it, explaining terms (or groups of terms from a sub-business domain) that may be unfamiliar to the reader of the use-case descriptions or other project documents. Often, this document can be used as an informal data dictionary, capturing data definitions so that use-case descriptions and other project documents can focus on what the system shall do with the information. Reference may be made to external documents that give such details.



Term	Definition	Source	Date
Container	An article of transport equipment (liftvan, movable tank or similar structure): <ol style="list-style-type: none"> 1. fully or partially enclosed to constitute a compartment intended for containing goods; 2. of a permanent character and accordingly strong enough to be suitable for repeated use; 3. specially designed to facilitate the transport of goods by one or more modes of transport without intermediate unloading; 4. designed for ready handling, particularly when being transferred from one mode of transport to another; 5. designed to be easy to fill and to empty, and 6. having an internal volume of one cubic metre or more 	Art. 1 (j)	ExG 28-29 June 2004
Customs office	Any Customs office of a Contracting Party approved for accomplishing TIR operations	Art. 45	ExG 28-29 June 2004
Customs office of departure	Any Customs office of a Contracting Party where the TIR transport of a load or part load of goods begins	Art. 1 (k)	ExG 28-29 June 2004
Customs office of destination	Any Customs office of a Contracting Party where the TIR transport of a load or part load of goods ends	Art. 1 (l)	ExG 28-29 June 2004
Good	Commodity, merchandise	Webster	ExG 28-29 June 2004
Guarantee chain (International guarantee system)	System covering the liabilities of national associations, authorized to act as surety for TIR Carnets issued by them as well as for liabilities incurred by them in connection with operations under cover of TIR Carnets issued by foreign associations affiliated to the same international organization as that to which they are themselves affiliated	ExG Warsaw	ExG 28-29 June 2004





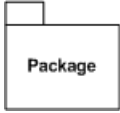

Guaranteeing Association	An association approved by the Customs authorities of a Contracting Party to act as surety for persons using the TIR procedure	Art. 1 (q)	ExG 28-29 June 2004
International Organization	International organization, which is authorized by the TIR Administrative Committee, as referred to in Annex 8, Article 10 (b) to take on responsibility for the effective organization and functioning of an international guarantee system provided that it accepts this responsibility, as referred to in Article 6, paragraph 2	Art. 6.2 bis Annex 8, Art. 10 (b)	ExG 28-29 June 2004
Issuing Association	An association approved by the Customs authorities of a Contracting Party to issue TIR Carnets	Secretariat	ExG 28-29 June 2004
Load compartment	Compartment intended for containing goods	Secretariat	ExG 28-29 June 2004
National Association	An association approved by the Customs authorities of a Contracting Party to issue TIR Carnets and to act as surety for persons using the TIR procedure	Secretariat	ExG 28-29 June 2004
Road Vehicle	Not only any power-driven road vehicle but also any trailer or semi-trailer designed to be coupled thereto	Art. 1 (g)	ExG 28-29 June 2004
Sealed loading unit	Any part of a container or load compartment suited for sealing under the conditions stipulated by the TIR Convention	Secretariat	ExG 28-29 June 2004
Good Manifest Line Item	Goods Manifest Line Item expresses the way goods are described and listed in the TIR carnet according to the points B.10.a), d), e) of the "Rules regarding the use of the TIR carnet". Specifically, these rules state that goods must be clearly separated by the combination of vehicle or container, Customs office of departure and the intended customs office of destination.	ExG	ExG 26-27 May 2005
TIR operation	The part of a TIR transport that is carried out in a Contracting Party from a Customs office of departure or entry (en route) to a Customs office of destination (en route)	Art. 1 (b)	ExG 28-29 June 2004
TIR transport	The transport of goods from a Customs office of departure to a Customs office of destination under the procedure, called the TIR procedure, laid down in the TIR Convention	Art. 1 (a)	ExG 28-29 June 2004
TIR Carnet holder	The person to whom a TIR Carnet has been issued in accordance with the relevant provisions of the TIR Convention and on whose behalf a Customs declaration has been made in the form of a TIR Carnet indicating a wish to place goods under the TIR procedure at the Customs office of departure.	Art. 1 (o)	ExG 28-29 June 2004



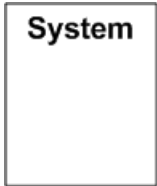



	He shall be responsible for the presentation of the road vehicle, combination of vehicles or the container together with the load and the TIR Carnet relating thereto at the Customs office of departure, the Customs office en route and the Customs office of destination and for due observance of the other relevant provisions of the TIR Convention.		
Transport operator	Person actually transporting the goods or in charge of or responsible for the operation of the means of transport on behalf of the TIR Carnet holder	ExG Warsaw	ExG 28-29 June 2004
Driver	Natural person operating the means of transport on behalf of the TIR Carnet holder	ExG Warsaw	ExG 28-29 June 2004
Forwarder	Person performing services (such as receiving, transshipping or delivering), designed to assure and facilitate the passage of goods to their destination on behalf of the TIR Carnet holder	ExG Warsaw	ExG 28-29 June 2004
Consignor	Person consigning goods on behalf of the TIR Carnet holder	ExG Warsaw	ExG 28-29 June 2004
Consignee	Person receiving goods	ExG Warsaw	ExG 28-29 June 2004
Start of a TIR operation	The road vehicle, the combination of vehicles or the container have been presented for purposes of control to the Customs office of departure or entry (en route) together with the load and the TIR Carnet relating thereto and the TIR Carnet has been accepted by the Customs office	Art. 1 (c)	ExG 26-27 October 2004
Termination of a TIR operation	The road vehicle, the combination of vehicles or the container have been presented for purposes of control to the Customs office of destination or of exit (en route) together with the load and the TIRE Carnet relating thereto.	Art. 1 (d)	ExG 26-27 October 2004
Discharge of a TIR operation	The recognition by Customs authorities that the TIR operation has been terminated correctly in a Contracting Party. This is established by the Customs authorities on the basis of a comparison of the data or information available at the Customs office of destination or exit (en route) and that available at the Customs office of departure or entry (en route)	Art. 1 (e)	ExG 26-27 October 2004
Import or export duties and taxes	Customs duties and all other duties, taxes, fees and other charges which are collected on, or in connection with, the import or export of goods, but not including fees and charges limited in amount to the approximate cost of services rendered	Art. 1 (f)	ExG 26-27 October 2004
Person	Both natural and legal persons	Art. 1 (n)	ExG 26-27 October 2004
Heavy or bulky goods	Any have or bulky object which because of its weight, size or nature is not normally carried in a closed road vehicle or closed container	Art. 1 (p)	ExG 26-27 October 2004



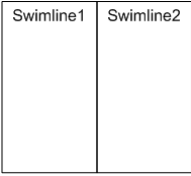
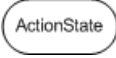



Annex 3 – UML

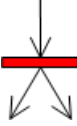
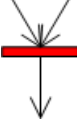
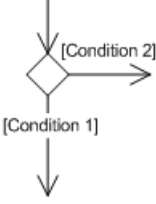

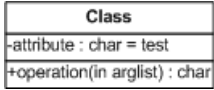
UML symbols glossary

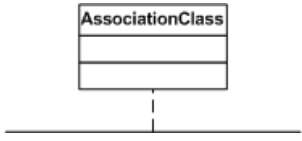
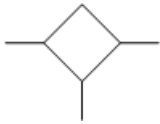

Package diagram	
Package	
Dependency	

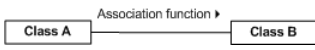
Use case diagram	
System	
Use case	
Actor	
Communication	
Uses	
Comment	

Activity diagram	
Swimlane	
Action state	
State	
Initial state	
Final state	
Control flow	
Object flow	
Transition (fork)	
Transition (join)	
Decision	

Class diagram	
Class	
Object	
Association	
Association class	
N-ary association	
Generalization	
Composition	
Aggregation	
Association roles	
Association function and reading direction	

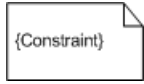
Multiplicities (cardinalities)	
Exactly one	
Many (zero or more)	
Optional	

General symbols	
Interface	
Constraint	
Comment	

Elaboration of a class diagram – TIR Operation example

On the basis of the requirements contained in Annex 1 of the Reference Model, we will construct the part of the class diagram depicting the TIR operation.

First, we draw the class:

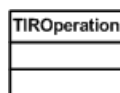

In the list of Requirements, only two requirements deal with the TIR operation:

Req.10 A TIR transport is composed of TIR operations. The number of TIR operations within a TIR transport is at the moment limited to 10 with the current paper system and has a minimum of 2 (these limitations should be extensible; therefore a two to many is more advisable). A TIR operation is part of one and only one TIR transport.

Req. 13 The TIR operation is started at one and only one Customs office and terminated at one and only one Customs office. A Customs office can start and terminate any number of TIR operations.

Requirement 10 first stipulates that *a TIR transport is composed of TIR operations*. UML uses a line terminated by a black diamond to indicate the composition (◆—):.

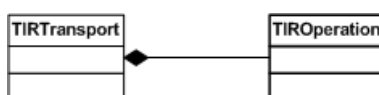

It also states that *the number of TIR operations within a TIR transport is at the moment limited to 10 with the current paper system and has a minimum of 2 (these limitations should be extensible; therefore a two to many is more advisable)*. This is translated in UML by indicating on the TIR operation side of the line “2..*” (multiplicity). The multiplicity indicates the number of objects participating in the relationship:

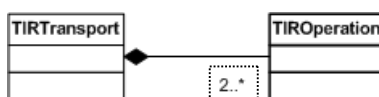

Finally, requirement 10 says that *a TIR operation is part of one and only one TIR transport*. This is translated by writing “1” on the TIR transport side of the relationship:

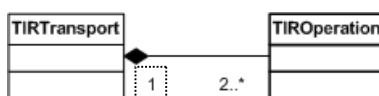

Requirement 13 contains information about two relationships between the classes *TIR Operation* and *Customs Office*. First, we will identify the two relationships, which are called “associations”. Requirement 13 stipulates that *the TIR operation is started at ... Customs office.... Start* is therefore the first association between the classes *TIR Operation* and *Customs Office*:



In case the association itself contains information, UML uses a different symbol called “association class”. This is the case for the *Start* association which contains information, such as the starting date of the TIR operation:.

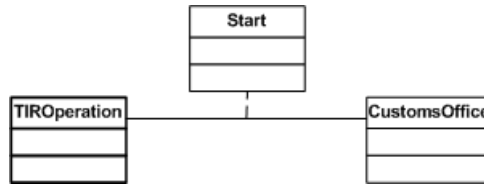

The second association, *Termination*, can be identified in Requirement 13: *the TIR operation is... and terminated at ... Customs office*. Following the logic of the previous association, the association is depicted as an association class:

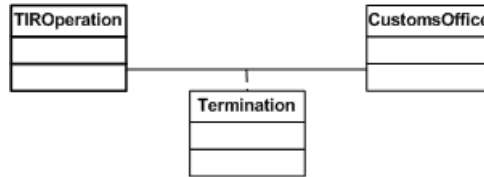

The multiplicities of these two associations are identical. The words *one and only one* indicate that a TIR operation has to start at a Customs office and can not start at more than one. This is translated in UML by inserting "1" on the *Customs Office* side of the association:

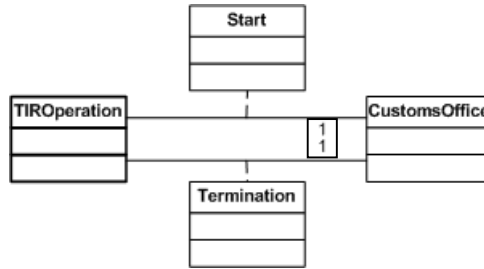

In addition, *a Customs office can start and terminate any number of TIR operations*. This is translated in UML by inserting "*" (meaning from zero to any number) on the *TIR operation* side of the association:

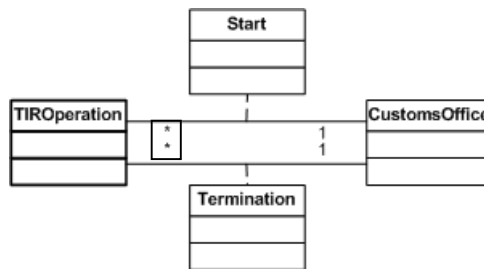

Finally, in order get the full picture of all relationships involving the *TIR operation* class, the sub part of the high level class diagram can be drawn:

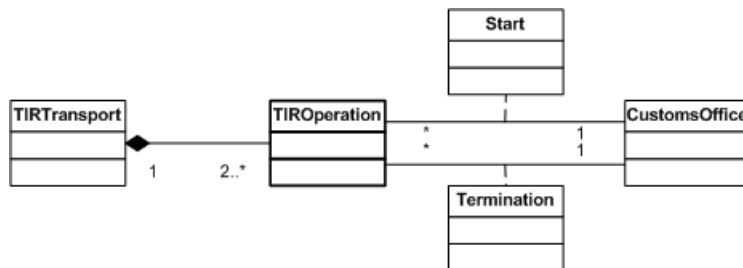

When looking at the complete high level diagram, one should not forget the fact that, although all relationships are depicted in one, single diagram, this does not change the way in which each single relationship should be read.

Annex 4 – UMM/UML glossary

Term	Definition	Source
abstract class	A class that cannot be directly instantiated.	<i>Unified Modelling User Guide</i>
abstraction	The essential characteristics of an entity that distinguish it from all other kinds of entities. An abstraction defines a boundary relative to the perspective of the viewer.	<i>Unified Modelling User Guide</i>
activity diagram	Shows behaviour with control structure. Can show many objects over many uses, many objects in single use case, or implementation of method. Encourages parallel behaviour.	<i>UML Distilled</i>
actor	Someone or something, outside the system or business that interacts with the system or business.	<i>Rational Unified Process</i>
aggregation	A special form of association that specifies a whole-part relationship between the aggregate (the whole) and a component (the part).	<i>Unified Modelling User Guide</i>
analysis classes	An abstraction of a <u>role</u> played by a design element in the system, typically within the context of a <u>use-case realization</u> . Analysis classes may provide an abstraction for several role, representing the common behaviour of those roles. Analysis classes typically evolve into one or more design elements (e.g. design <u>classes</u> and/or <u>capsules</u> , or design <u>subsystems</u>).	<i>Rational Unified Process</i>
analysis	The part of the software development process whose primary purpose is to formulate a model of the problem <u>domain</u> . Analysis focuses on what to do, design focuses on how to do it. See <u>design</u> .	<i>Rational Unified Process</i>
API	Application Protocol Interface.	
architecture	The organizational structure of a system. An architecture can be recursively decomposed into parts that interact through interfaces, relationships that connect parts, and constraints for assembling parts. Parts that interact through interfaces include <u>classes</u> , <u>components</u> and <u>subsystems</u> .	<i>Rational Unified Process</i>
artifact	(1) A piece of information that (1) is produced, modified, or used by a process, (2) defines an area of responsibility, and (3) is subject to version control. An artefact can be a <u>model</u> , a <u>model element</u> , or a <u>document</u> . A document can enclose other documents.	<i>Rational Unified Process</i>
association	A structural relationship that describes a set of links, in which a link is a connection among objects; the semantic relationship between two or more classifiers that involves the connections among their instances.	<i>Unified Modelling User Guide</i>
attributes	An attribute defined by a <u>class</u> represents a named property of the class or its objects. An attribute has a <u>type</u> that defines the type of its instances.	<i>Rational Unified Process</i>
binary association	An association between two classes.	<i>Unified Modelling User Guide</i>
BPAWG	UN/CEFACT Business Process Analysis Working Group. Responsible for analysing and understanding the key elements of international transactions and working for the elimination of constraints.	<i>UN/CEFACT</i>
Boolean	An enumeration whose values are true and false.	<i>Unified Modelling User Guide</i>
business domain model	The first stage in UN/CEFACT unified process.	<i>UMM</i>

business entity class	Group of Items which are structured in the same way: that serves the fundamental missions of the company, that has legal and/or commercial basis, which may participate in exchanges with partners, which will be implemented into objects (object technology) through a modelling process. For example: order is a business entity class.	<i>UMM</i>
business entity	Something that is accessed, inspected, manipulated, produced, and son on in the business.	<i>UMM</i>
business expert	A person who is knowledgeable about the business area being modelled.	<i>UMM</i>
Business Operational View (BOV)	A perspective of business transactions limited to those aspects regarding the making of business decisions and commitments among organizations, which are needed for the description of a business transaction.	<i>(Open-edi Reference Model - ISO/IEC 14662).</i>
business process	The means by which one or more activities are accomplished in operating business practices.	<i>UMM</i>
business rule	Rules, regulations and practices for business.	<i>UMM</i>
business	a series of processes, each having a clearly understood purpose, involving more than one organization, realized through the exchange of information and directed towards some mutually agreed upon goal, extending over a period of time.	<i>(Open-edi Reference Model - ISO/IEC 14662). (MoU)</i>
cardinality	The number of elements in a set.	<i>Unified Modelling User Guide</i>
class	A description of a set of objects that share the same <i>attributes, operations, methods, relationships</i> , and semantics. A class may use a set of interfaces to specify collections of operations it provides to its environment. See: <i>interface</i> .	<i>Rational Unified Process</i>
class diagram	shows static structure of concepts, types, and classes. Concepts show how users think about the world; types show interfaces of software components; classes show implementation of software components. (UML Distilled) A diagram that shows a collection of declarative (static) <i>model elements</i> , such as <i>classes, types</i> , and their contents and <i>relationships</i> . (Rational Unified Process).	<i>UML Distilled/ Rational Unified Process</i>
collaboration diagram	(1) A collaboration diagram describes a pattern of interaction among objects; it shows the objects participating in the interaction by their links to each other and the <i>messages</i> they send to each other. Unlike a sequence diagram, a collaboration diagram shows the relationships among the instances. Sequence diagrams and collaboration diagrams express similar information, but show it in different ways. See: <i>sequence diagram</i> .	<i>Rational Unified Process</i>
component	A physical, replaceable part of a system that packages implementation and conforms to and provides the realization of a set of interfaces. A component represents a physical piece of implementation of a system, including software code (source, binary or executable) or equivalents such as scripts or command files.	<i>Rational Unified Process</i>
component diagram	A diagram that shows the organizations and dependencies among <i>components</i> .	<i>Rational Unified Process</i>
component interface	A named set of operations that characterize the behaviour of a component.	<i>OMG</i>

composition	A form of aggregation with strong ownership and coincident lifetime of the parts by the whole; parts with nonfixed multiplicity may be created after composite itself, but once created they live and die with it; such parts can also be explicitly removed before the death of a composite.	<i>Unified Modelling User Guide</i>
constraint	A semantic condition or restriction. Certain constraints are predefined in the UML, others may be user defined. Constraints are one of three extensibility mechanisms in UML. See: <i>tagged value</i> , <i>stereotype</i> .	<i>Rational Unified Process</i>
construction	The third phase of the software development life cycle, in which the software is brought from an executable architectural baseline to the point at which it is ready to be transitioned to the user community.	<i>Unified Modelling User Guide</i>
control classes	A class used to model behaviour specific to one, or a several use cases.	<i>Rational Unified Process</i>
datatype	A descriptor of a set of values that lack identity and whose operations do not have side effects. Data types include primitive pre-defined types and user-definable types. Pre-defined types include numbers, string and time. User-definable types include enumerations.	<i>Rational Unified Process</i>
delegation	The ability of an object to issue a message to another object in response to a message.	<i>Unified Modelling User Guide</i>
deliverables	An output from a process that has a value, material or otherwise, to a <u>customer</u> or other <u>stakeholder</u> .	<i>Rational Unified Process</i>
dependency	A semantic relationship between two things in which a change to one thing (the independent thing) may affect the semantics of the other thing (the dependent thing).	<i>Unified Modelling User Guide</i>
deployment diagram	A diagram that shows the configuration of run-time processing nodes and the <i>components</i> , <i>processes</i> , and <i>objects</i> that live on them. Components represent run-time manifestations of code units. See: <i>component diagram</i> .	<i>Rational Unified Process</i>
design	The part of the software development process whose primary purpose is to decide how the system will be implemented. During design, strategic and tactical decisions are made to meet the required functional and quality <i>requirements</i> of a system. See <i>analysis</i> .	<i>Rational Unified Process</i>
design patterns	A specific solution to a particular problem in software design. Design patterns capture solutions that have developed and evolved over time, expressed in a succinct and easily applied form.	<i>Rational Unified Process</i>
design view	The view of a system's architecture that encompasses the classes, interfaces and collaborations that form the vocabulary of the problem and its solution; a design view addresses the functional requirements of a system.	<i>Unified Modelling User Guide</i>
diagram	A graphical depiction of all or part of a <i>model</i> .	<i>Rational Unified Process</i>
Document type definition	See DTD.	
domain	An area of knowledge or activity characterized by a family of related systems. An area of knowledge or activity characterized by a set of concepts and terminology understood by practitioners in that area.	<i>Rational Unified Process</i>
DTD	Document Type Definition.	
EDI message	An approved, published, and maintained formal description of how to structure the data required to perform a specific business function, in such a way as to allow for the transfer and handling of this data by electronic means.	(MoU)
EDIFACT messages	A electronic message formats based on UN/EDIFACT standard set developed and maintained by the UN/EDIFACT Working Group which are	UN/CEFACT

	in UN/TDID directories.	
edifact working group	To develop and maintain UN/EDIFACT, the support of harmonised implementations and the use of multi-lingual terminology.	
elaboration phase	The second <i>phase</i> of the process where the product <i>vision</i> and its <i>architecture</i> are defined.	<i>Rational Unified Process</i>
electronic business	a generic term covering information definition and exchange requirements within and between enterprises, including customers.	(MoU)
electronic commerce	Electronic Commerce is doing business electronically. This includes the sharing of standardised unstructured or structured business information by any electronic means (such as electronic mail or messaging, World Wide Web technology, electronic bulletin boards, smart cards, electronic funds transfers, electronic data interchange, and automatic data capture technology) among suppliers, customers, governmental bodies and other partners in order to conduct and execute transactions in business, administrative and consumer activities.	UN/CEFACT SIMAC
Electronic Data Interchange (EDI)	The automated exchange of any predefined and structured data for business among information systems of two or more organizations.	(Open-edi Reference Model Standard - ISO/IEC 14662). (MoU)
entity classes	A <i>class</i> used to model information that has been stored by the system, and the associated behaviour. A generic class, reused in many <i>use cases</i> , often with persistent characteristics. An entity class defines a set of entity objects, which participate in several use cases and typically survive those use cases.	<i>Rational Unified Process</i>
enumerations	A list of named values used as the range of a particular <i>attribute</i> type. For example, RGBColor = {red, green, blue}. Boolean is a predefined enumeration with values from the set {false, true}.	<i>Rational Unified Process</i>
EWG	UN/EDIFACT Working Group. To develop and maintain UN/EDIFACT, the support of harmonised implementations and the use of multi-lingual terminology.	
eXtensible Markup Language	See XML.	
Functional Service View (FSV)	A perspective of business transactions limited to those information technology interoperability aspects of IT Systems needed to support the execution of Open-edi transactions.	(MoU)
generalization	A taxonomic relationship between a more general element and a more specific element. The more specific element is fully consistent with the more general element and contains additional information. An instance of the more specific element may be used where the more general element is allowed. See: <i>inheritance</i> .	<i>Rational Unified Process</i>
implementation	A concrete realization of the contract declared by an interface; a definition of how something is constructed or computed.	
inception phase	The first <i>phase</i> of the Unified Process, in which the seed idea, request for proposal, for the previous generation is brought to the point of being (at least internally) funded to enter the <i>elaboration</i> phase.	<i>Rational Unified Process</i>
inheritance	The mechanism by which more specific elements incorporate structure and behaviour of more general elements related by behaviour. See <i>generalization</i> .	<i>Rational Unified Process</i>
instance	An individual entity satisfying the description of a <i>class</i> or <i>type</i> .	<i>Rational Unified Process</i>

interaction diagram	A diagram that shows an interaction, consisting of a set of objects and their relationships, including the messages that may be dispatched among them; interaction diagrams address the dynamic view of a system; a generic term that applies to several types of diagrams that emphasize object interactions, including collaboration diagrams, sequence diagrams and activity diagrams.	<i>Unified Modelling User Guide</i>
interface	A collection of <i>operations</i> that are used to specify a service of a <i>class</i> or a <i>component</i> . A named set of operations that characterize the behaviour of an element.	<i>Rational Unified Process</i>
ISO	The International Organization for Standardization.	
Messages	A specification of the conveyance of information from one instance to another, with the expectation that activity will ensue. A message may specify the raising of a signal or the call of an operation.	<i>Rational Unified Process</i>
messaging protocols	See Messages and Protocol.	
Metaclass	A class whose instances are classes. Metaclasses are typically used to construct <i>metamodels</i> .	
Metamodel	A model that defines the language for expressing a <i>model</i> .	<i>Rational Unified Process</i>
metaobjects	A generic term for all metaentities in a metamodeling language. For example, metatypes, metaclasses, metaattributes, and metaassociations.	<i>Rational Unified Process</i>
method	(1) A regular and systematic way of accomplishing something; the detailed, logically ordered plans or procedures followed to accomplish a task or attain a goal. (2) UML 1.1: The implementation of an operation, the algorithm or procedure that effects the results of an operation. The implementation of an operation. It specifies the algorithm or procedure associated with an operation.	<i>Rational Unified Process</i>
methodology	the science of method. A body of methods used in a particular branch of activity.	<i>COD</i>
model	A semantically closed abstraction of a system. In the Unified Process, a complete description of a system from a particular perspective ('complete' meaning you don't need any additional information to understand the system from that perspective); a set of model elements. Two models cannot overlap. A semantically closed abstraction of a subject system. See: <i>system</i> . Usage note: In the context of the MOF specification, which describes a <i>meta-metamodel</i> , for brevity the meta-metamodel is frequently referred to as simply the model.	<i>Rational Unified Process</i>
modelling tools	any device or implement used to carry out modeling whether manually or by a machine.	<i>COD</i>
naming	to give a string used to identify a <i>model element</i> .	<i>Rational Unified Process</i>
n-ary association	An association among three or more classes.	<i>Unified Modelling User Guide</i>
note	One of model elements which is a figure symbol to express an element in a diagram.	<i>UML Toolkit</i>
object diagram	A diagram that encompasses <i>objects</i> and their relationships at a point in time. An object diagram may be considered a special case of a class diagram or a collaboration diagram. See: <i>class diagram</i> , <i>collaboration diagram</i> .	<i>Rational Unified Process</i>
Object Oriented Approach	The development of classes of business objects may support and have an impact on the developments in the area of simplification of EDI and its standards. A business object is a true representation of a tangible concept stemming from real business usage.	

objects	An entity with a well-defined boundary and identity that encapsulates <i>state</i> and <i>behaviour</i> . State is represented by <i>attributes</i> and <i>relationships</i> , behavior is represented by <i>operations</i> , <i>methods</i> , and <i>state machines</i> . An object is an instance of a class. See: <i>class</i> , <i>instance</i> .	<i>Rational Unified Process</i>
OCL	Object Constraints Language; a formal language used to express side effect-free constraints.	<i>Unified Modelling User Guide</i>
OO-edi	Object Oriented edi.	
Open-edi	electronic data interchange among multiple autonomous organizations to accomplish an explicit shared business goal according to Open-edi standards (i.e. that complies with the Open-edi Reference Model Standard - ISO/IEC 14662).	<i>(MoU)</i>
operation signature	See Operation and Signature.	
operation	A service that can be requested from an object to effect behaviour. An operation has a <i>signature</i> , which may restrict the actual parameters that are possible.	<i>Rational Unified Process</i>
package	A general purpose mechanism for organizing elements into groups. Packages may be nested within other packages.	<i>Rational Unified Process</i>
package diagram	shows groups of classes and dependencies among them.	<i>UML Distilled</i>
parameter	The specification of a variable that can be changed, passed, or returned.	<i>Unified Modelling User Guide</i>
patterns	offers useful bits of analysis, design, and coding techniques. Good examples to learn from; starting point for designs.	<i>UML Distilled</i>
phases	The time between two major project milestones, during which a well-defined set of objectives is met, artefacts are completed, and decisions are made to move or not move into the next phase.	<i>Rational Unified Process</i>
process view	The view of a system's architecture that encompasses the threads and processes that form the system's concurrency and synchronization mechanisms; a process view addresses the performance, scalability and throughput of the system.	<i>Unified Modelling User Guide</i>
projects	a plan; a scheme. A planned undertaking. A long-term task undertaken by a student to be submitted for assessment.	<i>COD</i>
protocol	A specification of a compatible set of messages used to communicate between <i>capsules</i> . The protocol defines a set of incoming and outgoing messages types (e.g. operations, signals), and optionally a set of sequence diagrams which define the required ordering of messages and a state machine which specifies the abstract behaviour that the participants in a protocol must provide.	<i>Rational Unified Process</i>
prototype	A release that is not necessarily subject to <i>change management</i> and <i>configuration control</i> .	<i>Rational Unified Process</i>
register	an official list in which items are recorded for reference (list of elementary data in which the meaning –i.e. semantics- of these data is defined).	
Registry	a place where registers are kept.	
Relationship	A semantic connection among model elements. Examples of relationships include <i>associations</i> and <i>generalizations</i> .	<i>Rational Unified Process</i>
repository	Electronic store of structured information (such as EDIFACT messages, X12 messages, XML messages).	

requirement	A desired feature, property or behaviour of a system.	<i>Unified Modelling User Guide</i>
re-use	Further use or repeated use of an <i>artefact</i> .	<i>Rational Unified Process</i>
scenario	A formal specification of a class of business activities having the same business goal.	<i>(ISO 19735 part I)</i>
schema	In the context of the MOF (Metadata Object Facility), a schema is analogous to a <i>package</i> which is a container of <i>model elements</i> . Schema corresponds to an MOF package. Contrast: <i>metamodel</i> , package corresponds to an MOF package.	<i>Rational Unified Process</i>
scope	the extent to which it is possible to range; the opportunity for action etc.	<i>COD</i>
semantics	relating to meaning in language; relating to the connotations of words.	<i>COD</i>
sequence diagram	A diagram that shows object interactions arranged in time sequence. In particular, it shows the objects participating in the interaction and the sequence of messages exchanged. Unlike a collaboration diagram, a sequence diagram includes time sequences but does not include object relationships. A sequence diagram can exist in a generic form (describes all possible <i>scenarios</i>) and in an instance form (describes one actual scenario). Sequence diagrams and collaboration diagrams express similar information, but show it in different ways. See: <i>collaboration diagram</i> .	<i>Rational Unified Process</i>
signature	The name and parameters of a behavioural feature. A signature may include an optional returned parameter.	<i>Rational Unified Process</i>
Simpl-EDI	Subsets of UN/EDIFACT messages especially designed for SMEs. Simpl-EDI (Simple Electronic Business) defines simplest processes and their required core data allowing the exchange of the minimum data to effect a business transaction electronically.	<i>UN/CEFA CT SIMAC</i>
software developer	A person responsible for developing a software in accordance with project-adopted standards and procedures. This can include performing activities in any of the <i>requirements, analysis & design, implementation, and test</i> workflows.	<i>Rational Unified Process</i>
software solution	the act or a means of solving a problem or difficulty using a software.	<i>COD</i>
specification	A declarative description of what something is or does. Contrast: <i>implementation</i> .	<i>Rational Unified Process</i>
stakeholder	An individual who is materially affected by the outcome of the system.	<i>Rational Unified Process</i>
state diagram	shows how single object behaves across many use cases.	<i>UML Distilled</i>
state machine	A state machine specifies the behaviour of a <i>model element</i> , defining its response to events and the life cycle of the object. A behaviour that specifies the sequences of <i>states</i> that an object or an interaction goes through during its life in response to events, together with its responses and actions.	<i>Rational Unified Process</i>
statechart (state machine) diagram	A diagram that shows a state machine. See: <i>state machine</i> .	<i>Rational Unified Process</i>
states	A condition or situation during the life of an object during which it satisfies some condition, performs some activity, or waits for some event. Contrast: state [OMA].	<i>Rational Unified Process</i>

stereotype	A new type of modelling element that extends the semantics of the metamodel. Stereotypes must be based on certain existing types or classes in the metamodel. Stereotypes may extend the semantics, but not the structure of pre-existing types and classes. Certain stereotypes are predefined in the UML, others may be user defined. Stereotypes are one of three extensibility mechanisms in UML. See: <i>constraint</i> , <i>tagged value</i> .	<i>OMG</i>
sub-domain	An lower area of knowledge or activity characterized by a family of related systems contained by a domain.	
swimlane	A partition on an interaction diagram for organizing responsibilities for actions.	<i>Unified Modelling User Guide</i>
syntax rules	rules governing the structure of an interchange and its functional groups, messages, segments and data elements.	<i>(ISO 9735)</i>
system	As an instance, an executable configuration of a software application or software application family; the execution is done on a hardware platform. As a class, a particular software application or software application family that can be configured and installed on a hardware platform. In a general sense, an arbitrary system instance. 1. A collection of connected units that are organized to accomplish a specific purpose. A system can be described by one or more models, possibly from different viewpoints. <i>Synonym: physical system</i> . 2. A top-level subsystem.	<i>Rational Unified Process</i>
templates	A pre-defined structure for an <i>artefact</i> . <i>Synonym: parameterized element</i> .	<i>Rational Unified Process</i>
test	A <i>core process workflow</i> in the software-engineering process whose purpose is to integrate and test the system.	<i>Rational Unified Process</i>
TMWG	UN/CEFACT Techniques and Methodologies Group. To research and identify techniques and methodologies which could be utilised by CEFACT and its working groups to enhance the process by which its deliverables are produced and integrated.	
traceability	The ability to trace a project element to other related project elements, especially those related to <i>requirements</i> .	<i>Rational Unified Process</i>
transition phase	The fourth <i>phase</i> of the process in which the software is turned over to the user community; a relationship between two states indicating that an object in the first state will perform certain actions and enter the second state when a specified event occurs and conditions are satisfied.	<i>Unified Modelling User Guide</i>
type	Description of a set of entities which share common characteristics, relations, attributes, and semantics. A stereotype of class that is used to specify a domain of instances (objects) together with the operations applicable to the objects. A type may not contain any methods. See: <i>class</i> , <i>instance</i> . Contrast: <i>interface</i> .	<i>Rational Unified Process</i>
UML	See Unified Modelling Language.	
UN/EDIFACT	(United Nations Electronic Data Interchange for Administration, Commerce and transport): "User application protocol, for use within user application systems for data to be interchanged, compatible with the OSI model."	<i>(UN/EDIFACT syntax implementation guidelines, UNTDID 1990). (MoU)</i>
Unified Modeling Language (UML)	a set of diagrams that communicate requirements regarding a business process.	

use case	The specification of a sequence of actions, including variants, that a system (or other entity) can perform, interacting with <i>actors</i> of the system. See: <i>use-case instances</i> . A use-case class contains all main, alternate flows of events related to producing the 'observable result of value'. Technically, a use-case is a class whose instances are <i>scenarios</i> .	<i>Rational Unified Process</i>
use-case analysis	The part of the software development process using use case methodology whose primary purpose is to formulate a model of the problem <i>domain</i> . Analysis focuses on what to do, design focuses on how to do it.	
use-case diagram	A diagram that shows the relationships among <i>actors</i> and <i>use cases</i> within a system.	<i>Rational Unified Process</i>
use-case instance	A sequence of actions performed by a system that yields an observable result of value to a particular actor.	<i>Rational Unified Process</i>
use-case model	A model that describes a system's functional <i>requirements</i> in terms of <i>use cases</i> .	
use-case realization	A use-case realization describes how a particular use case is realized within the <i>design model</i> , in terms of collaborating objects.	<i>Rational Unified Process</i>
use-case view	An <i>architectural view</i> that describes how critical use cases are performed in the system, focusing mostly on architecturally significant components (objects, tasks, nodes). In the Unified Process, it is a view of the <i>use-case model</i> .	<i>Rational Unified Process</i>
view elements	A view element is a textual and/or graphical projection of a collection of <i>model elements</i> .	<i>Rational Unified Process</i>
view	A simplified description (an abstraction) of a model, which is seen from a given perspective or vantage point and omits entities that are not relevant to this perspective. See also <i>architectural view</i> .	<i>Rational Unified Process</i>
workflow	A sequence of activities in the Rational Unified Modelling Methodology.	
XML (eXtensible Markup Language)	XML is designed to enable the exchange of information (data) between different applications and data sources on the World Wide Web. XML is a simplified subset of the Standard Generalized Markup Language (SGML). XML allows construction of structured data (trees) which rely on composition relationships. XML schemas are used to define data models.	<i>UN/CEFACT SIMAC</i>

Annex 5 – List of tables

Table 0.1 Activities associated with each phase	9
Table 0.2 Deliverables	10
Table 0.3 Review and validation status	14
Table 1.1 TIR procedure package diagram description	26
Table 1.2 TIR Carnet life cycle use case description.....	32
Table 1.3 International organization sub class diagram description	63
Table 1.4 Association sub class diagram description.....	64
Table 1.5 Road vehicle sub class diagram description	65
Table 1.6 Sealed loading unit sub class diagram description.....	66
Table 1.7 TIR transport sub class diagram description.....	68
Table 1.8 TIR operation sub class diagram description	69
Table 1.9 Goods Manifest Line Item sub class diagram description	71
Table 1.10 Customs office sub class diagram description	72
Table 1.11 Country sub class diagram description	73
Table 1.12 Transport operator sub class diagram description.....	73

Annex 6 – List of figures

Figure 0.1 - Step-by-step iterative approach of UMM	12
Figure 0.2 Stakeholders responsibility chart.....	13
Figure 1.1 Stakeholders and actors	17
Figure 1.2 TIR procedure package diagram	25
Figure 1.3 TIR Carnet life cycle use case diagram.....	31
Figure 1.4 TIR Carnet life cycle activity diagram	32
Figure 1.5 Issuance and distribution use case diagram.....	33
Figure 1.6 Issuance and distribution activity diagram.....	36
Figure 1.7 TIR transport use case diagram	37
Figure 1.8 TIR transport activity diagram	40
Figure 1.9 Return and repository use case diagram.....	43
Figure 1.10 Return and repository activity diagram.....	45
Figure 1.11 Discharge procedure use case diagram.....	46
Figure 1.12 Discharge procedure activity diagram.....	48
Figure 1.13 Start TIR operation use case diagram.....	50
Figure 1.14 Start TIR operation activity diagram.....	53
Figure 1.15 Terminate TIR operation use case diagram.....	55
Figure 1.16 Terminate TIR operation activity diagram.....	59
Figure 1.17 International organization class and its relationships.....	63
Figure 1.18 Association class and its relationships	64
Figure 1.19 Road vehicle class and its relationships	65
Figure 1.20 Sealed loading unit class and its relationships	66
Figure 1.21 TIR transport class and its relationships.....	67
Figure 1.22 TIR operation class and its relationships.....	69
Figure 1.23 Goods Manifest Line Item class and its relationships.....	70
Figure 1.24 Customs office class and its relationships	71
Figure 1.25 Country class and its relationships	72
Figure 1.26 Transport operator class and its relationships	73
Figure 1.27 High-level class diagram	74

Annex 7 – References

To be filled-in at a later stage.
