

**European Agreement concerning
the International Carriage of Dangerous Goods
by Inland Waterways
(ADN)**

Annexed Regulations

- ANNEX A:** Provisions concerning dangerous substances and articles
- ANNEX B.1:** Provisions concerning the carriage of dangerous goods in packages or in bulk
- ANNEX B.2:** Provisions concerning the carriage of dangerous goods in tank vessels
- ANNEX C:** Requirements and procedures concerning inspections, the issue of certificates of approval, classification societies, derogations, special authorizations, checks, training and examination of experts
- ANNEX D.1:** General transitional provisions
- ANNEX D.2:** Supplementary transitional provisions applicable to specific inland waterways

(RESERVED)

TABLE OF CONTENTS

	Page
ANNEX A PROVISIONS CONCERNING DANGEROUS SUBSTANCES AND ARTICLES	1
Table of contents of Annex A	3
Part I Definitions and general provisions	5
Part II List of substances and special provisions for the various classes	13
 ANNEX B.1 PROVISIONS CONCERNING THE CARRIAGE OF DANGEROUS GOODS IN PACKAGES OR IN BULK	 17
Table of contents of Annex B.1	19
Part I Definitions and general provisions concerning the carriage of dangerous goods of all classes	23
Part II Special provisions concerning the carriage of dangerous goods of classes 1 to 9 supplementing or amending the provisions of part I	57
Part III Rules for construction	109
Part IV Rules for construction applicable to seagoing vessels which comply with the requirements of the SOLAS Convention, Chapter II-2, Regulation 54	121
Appendices	129
Appendix 1 Model 1: Model for a certificate of approval	131
Model 2: Model for a provisional certificate of approval	133
Model 3: Certificate of special knowledge of ADN	135
Appendix 2 Models of danger labels prescribed by international regulations	137

TABLE OF CONTENTS (cont'd)

	Page
ANNEX B.2 PROVISIONS CONCERNING THE CARRIAGE OF DANGEROUS GOODS IN TANK VESSELS	149
Table of contents of Annex B.2	151
Part I Definitions and general provisions concerning the carriage of dangerous goods of all classes	157
Part II Special provisions concerning the carriage of dangerous goods of classes 2, 3, 4.1, 6.1, 8 and 9 supplementing or amending the provisions of Part I	197
Part III Rules for construction of tank vessels	219
Chapter 1 Rules for construction of type G tank vessels	221
Chapter 2 Rules for construction of type C tank vessels	243
Chapter 3 Rules for construction of type N tank vessels	268
Appendices	291
Appendix 1 Model 1: Model for a certificate of approval	293
Model 2: Model for a provisional certificate of approval	297
Model 3: Certificate of special knowledge of ADN	301
Appendix 2 Checklist ADN	303
Appendix 3 Model 1: Device for the discharge of residual quantities	309
Model 2: Test of the stripping system	311
Model 3: Certificate for the test of the stripping system	313
Appendix 4 List of substances	315

TABLE OF CONTENTS (cont'd)

	Page
ANNEX C	
REQUIREMENTS AND PROCEDURES CONCERNING INSPECTIONS, THE ISSUE OF CERTIFICATES OF APPROVAL, CLASSIFICATION SOCIETIES, DEROGATIONS, SPECIAL AUTHORIZATIONS, CHECKS, TRAINING AND EXAMINATION OF EXPERTS	357
Table of contents of Annex C	359
Chapter 1	Procedure for the issue of the certificate of approval 361
Chapter 2	Recognized classification societies 366
Chapter 3	Procedure for equivalents and derogations 369
Chapter 4	Special authorizations concerning transport in tank-vessels 370
Chapter 5	Monitoring the carriage of dangerous goods by inland waterways 372
Chapter 6	Training and examination of experts 374
Chapter 7	Special bilateral and multilateral agreements 380
ANNEX D.1	
GENERAL TRANSITIONAL PROVISIONS	381
ANNEX D.2	
SUPPLEMENTARY TRANSITIONAL PROVISIONS APPLICABLE TO SPECIFIC INLAND WATERWAYS	399

(RESERVED)

ANNEX A

Provisions concerning dangerous substances and articles

(RESERVED)

ANNEX A

CONTENTS AND INSTRUCTIONS FOR APPLICATION OF ANNEX A

Part I - DEFINITIONS AND GENERAL PROVISIONS

This part contains the definitions and the general provisions which are required for the application of this Annex

Marginals

Definitions	6000 and 6001
General provisions	6002 to 6099

Part II - LIST OF SUBSTANCES AND SPECIAL PROVISIONS FOR THE VARIOUS CLASSES

Marginal 6002 in Part I of this Annex refers to the provisions of Part II of Annex A of the European Agreement concerning the international carriage of dangerous goods by road (ADR), as amended, which shall be applied.

These applicable provisions of ADR are supplemented by the special provisions of Part II of this annex, which shall be applied within the scope of ADN in addition to, or instead of, the provisions of Annex A of ADR.

The marginal numbers of Annex A of the Regulations annexed to ADN correspond to the marginal numbers of Annex A of ADR plus 4000.

Class 1	Explosive substances and articles	6100 and seq.
Class 2	Gases	6200 and seq.
Class 3	Flammable liquids	6300 and seq.
Class 4.1	Flammable solids	6400 and seq.
Class 4.2	Substances liable to spontaneous combustion	6430 and seq.
Class 4.3	Substances which, in contact with water, emit flammable gases	6470 and seq.
Class 5.1	Oxidizing substances	6500 and seq.
Class 5.2	Organic peroxides	6550 and seq.
Class 6.1	Toxic substances	6600 and seq.
Class 6.2	Infectious substances	6650 and seq.
Class 7	Radioactive material	6700 and seq.
Class 8	Corrosive substances	6800 and seq.
Class 9	Miscellaneous dangerous substances and articles	6900 and seq.

(RESERVED)

Annex A - Part 1

PART I

Definitions and general provisions

**1-
5999**

Definitions

6000 (1) For the purposes of this Annex:

ADR means the European Agreement concerning the International Carriage of Dangerous Goods by Road;

ICAO-TI means the Technical Instructions for the Safe Transport of Dangerous Goods by Air of the International Civil Aviation Organization (ICAO);

IMDG Code means the International Maritime Dangerous Goods Code of the International Maritime Organization (IMO);

RID means the Regulations concerning the International Carriage of Dangerous Goods by Rail which are Annex I of Appendix B - Uniform rules concerning the contract for international carriage of goods by rail (CIM) - of the Convention concerning international carriage by rail (COTIF);

International Regulations means RID, ADR, IMDG Code or ICAO-TI;

Miscellaneous

Competent authority means the authority designated or recognized as such in each country and in each specific case in connection with these provisions;

Dangerous goods means the substances, materials and articles (including wastes according to paragraph (5)) which are covered by the relevant definitions (list of substances) for the Classes 1 to 9 of ADR or as listed in Part II of this Annex.

Identification number means the number to identify a substance, material or article. As a rule, these numbers are taken from the United Nations Recommendations on the Transport of Dangerous Goods;

Gas means gases and vapours;

Carriage in bulk means the carriage of solid substances, materials or articles without packaging (unpacked);

(2) For the purposes of this Annex, tanks are not placed on the same footing as receptacles, the term "receptacle" being used in a restrictive sense. Provisions concerning receptacles are applicable to fixed tanks, demountable tanks, tank-containers and elements of battery-vehicles

Annex A - Part 1

or of multiple element tank-containers only if this is expressly stipulated.

**6000
(cont'd)**

(3) For the purposes of this Annex, the terms "package" and "packaging" also apply to intermediate bulk containers (IBCs), containers, including swap-bodies, tank-containers (including multiple element tank-containers), road vehicles (including battery-vehicles).

(4) For the purposes of ADR, a n.o.s. (not otherwise specified) entry means a collective heading to which substances, materials, mixtures, solutions or articles can be assigned if they:

- (a) are not mentioned by name in the lists of substances; and
- (b) exhibit chemical, physical and/or dangerous properties corresponding to the class, item, letter and the designation of the n.o.s. entry.

(5) Wastes are substances, materials, solutions, mixtures or articles for which no direct use is envisaged but which are transported for reprocessing, dumping, elimination by incineration or other methods of disposal.

6001

(1) Unless expressly stated otherwise, the sign "%" in this Annex and in Annexes B.1 and B.2 represents:

- (a) In the case of mixtures of solids or of liquids, and also in the case of solutions and of solids wetted by a liquid: a percentage by mass based on the total mass of the mixture, the solution or the wetted solid;
- (b) In the case of mixtures of compressed gases: the proportion of the volume indicated as a percentage of the total volume of the gaseous mixture; in the case of mixtures of liquefied gases and gases dissolved under pressure: the proportion of the mass indicated as a percentage of the total mass of the mixture.

(2) Whenever the word "weight" is used in this Annex and in Annexes B.1 and B.2 it means "mass".

(3) Whenever the weight of a package is mentioned, the gross mass is meant unless otherwise stated. The mass of containers, tanks or road vehicles used for the carriage of goods is not included in the gross mass.

(4) Pressures of all kinds relating to receptacles (such as test pressure, internal pressure, safety-valve opening pressure) are always indicated in gauge pressure (pressure in excess of atmospheric pressure); however, the vapour pressure of substances is always expressed in absolute pressure.

(5) Where this Annex or Annexes B.1 and B.2 specify a degree of filling for receptacles or tanks, that degree of filling is always referred to a temperature of the substance of 15 °C unless some other temperature is indicated.

Annex A - Part 1

General provisions

- 6002** (1) (a) Part II of Annex A to ADR and Part II of this Annex specify the dangerous goods to be excluded from carriage and the dangerous goods to be accepted for such carriage under certain conditions. These last goods are considered as goods of ADN.
- 6002 (cont'd)** The grouping of dangerous goods in restrictive and non restrictive classes is based on Part I of Annex A of ADR. Of the dangerous goods covered by the headings of the restrictive classes, those which are listed in the clauses concerning these classes are to be accepted for carriage only under the conditions specified in these clauses, and others are to be excluded from carriage.
- Some of the dangerous goods covered by the headings of the non-restrictive classes are, by notes inserted in the clauses concerning the various non-restrictive classes, excluded from carriage; of the other goods covered by the headings of the non-restrictive classes, those which are mentioned in the clauses concerning these classes or covered by one of the collective headings are to be accepted for carriage only under the conditions specified in these clauses; those which are not mentioned or covered by one of the collective headings are not deemed to be dangerous goods for the purposes of ADR and are not subject to ADN.
- (b) Solid substances shall only be carried in bulk if this is explicitly stated in Annex B.1, marginal XX 111 of each individual class.
- (c) Liquid, liquefied or gaseous substances may only be carried in tank vessels if they are listed in Appendix 4 of Annex B.2 (list of substances).
- (d) The provisions relating to the carriage of dangerous goods in dry-cargo vessels or tank vessels are contained exclusively in Annexes B.1 and B.2. These annexes also contain the rules for the construction of such vessels.
- (2) Dangerous goods which are accepted for carriage under the provisions of the IMDG Code but not under ADR, may be carried in:
- (a) packages - or packages in vehicles or containers - if the provisions of the IMDG Code concerning packing, mixed packing, labelling and marking are complied with;
- (b) tank-containers if they comply with the relevant provisions of the IMDG Code for portable tanks.

Annex A - Part 1

In the case of dangerous goods for which a transport temperature is given in accordance with the provisions of the IMDG Code, this transport temperature shall also be observed during transport in inland waterway vessels.

In each case, the most stringent provisions of Parts I and II of Annex B.1 shall be observed; however, prohibitions of mixed loading do not apply if the goods are loaded in containers in accordance with the segregation provisions of the IMDG Code.

A maximum mass of 60 000/120 000 kg (in total) for goods of Class 2 shall be observed as a limitation in accordance with marginal 10 401 (1).

(3) Unless otherwise specified in this Annex, the provisions of Part II of Annex A to ADR which are listed in the following table shall be applied:

Annex A - Part 1**6002
(cont'd)**

Class			Provisions of ADR concerning		
			Classification	Listing of substances	Particulars in the transport document
			Marginal	Marginal	Marginal
1	Explosive substances and articles	Restrictive	2100	2101	2110
2	Gases	Non-restrictive	2200	2201, 2201a	2226
3	Flammable liquids	Non-restrictive	2300	2301, 2301a	2314
4.1	Flammable solids	Non-restrictive	2400	2401, 2401a	2414
4.2	Substances liable to spontaneous combustion	Non-restrictive	2430	2431	2444
4.3	Substances which in contact with water, emit flammable gases	Non-restrictive	2470	2471, 2471a	2484
5.1	Oxidizing substances	Non-restrictive	2500	2501, 2501a	2514
5.2	Organic peroxides	Non-restrictive	2550	2551, 2551a	2561
6.1	Toxic substances	Non-restrictive	2600	2601, 2601a	2614
6.2	Infectious substances	Non-restrictive	2650	2651	2664
7	Radioactive material	Restrictive	2700	2701 to 2704	2704 Item 10 of each schedule
8	Corrosive substances	Non-restrictive	2800	2801, 2801a	2814
9	Miscellaneous dangerous substances and articles	Non-restrictive	2900	2901, 2901a	2914

For provisions concerning particulars in the transport document, information in accordance with the provisions of RID or in the case of paragraph (7) in accordance with the provisions of the IMDG Code is also permitted. Instead of the abbreviation "ADR" (or "RID") the abbreviation "ADN" may also be used.

(4) Dangerous goods used for the propulsion of vessels and vehicles, for the operation of their special equipment, for household purposes or for maintaining the safety, and which are carried on board in their usual containment are not subject to the provisions of ADN.

(5) For each transport of goods regulated in accordance with this Annex and Annex B.1, the following documents shall be carried on board:

Annex A - Part 1

- (a) A transport document containing at least the following particulars (for Class 7 see also marginal 2709 of Annex A of ADR):

**6002
(cont'd)**

- For dangerous goods not listed by name in this Annex, the particulars prescribed in the relevant marginal of Part II of Annex A of ADR, in accordance with paragraph (3) above, or when paragraph (7) below is applied, the particulars prescribed in Section 9 of the General Introduction to the IMDG Code;
- For dangerous goods listed by name in this Annex, or covered by a collective heading of this Annex (see marginals 6100 to 6199), the name of the substance or article underlined in this Annex or given in capital letters, together with the identification number (if it exists). If the substance is not listed by name in this Annex but is covered by a collective heading specifically mentioned in this Annex, the chemical or technical name shall be given. The name of the substance or article shall be followed by the class item number and if it exists, the letter as indicated in the list of substances, as well as by the acronym ADN;
- the number and a description of the packages or intermediate bulk containers (IBCs);
- the gross mass, as well as the net explosive quantity for explosive substances and articles of Class 1 in grammes or kilogrammes;
- the name and address of the consignor;
- the name and address of the consignee(s).

The document containing this information may be that already required by other regulations in force for transport by another mode of transport. The consignor shall, before loading, communicate this information to the carrier in writing.

The particulars to be entered in the transport document shall be drafted in an official language of the forwarding country and also, if that language is not English, French or German, in English, French or German unless international transport tariffs, if any, or agreements concluded between the countries concerned in the transport operation provide otherwise;

- (b) The written instructions for all dangerous goods carried as provided for in marginal 10 385 of Annex B.1. This does not apply if the dangerous goods are carried in quantities below the maximum quantities mentioned in marginal 10 011;

Annex A - Part 1

- (c) If required,
- the instructions to carriers referred to in marginal 71 002;
 - the certificates and information referred to in marginal 71 381;
and
 - the provisions and the approval certificates referred to in
marginal 71 403.

(6) For each transport of goods regulated in accordance with Annex B.2,
the
following documents shall be carried on board:

6002

(cont'd)

(a) A transport document containing at least the following
particulars:

- the name of the substance, which is indicated in capital
letters in the list of substances of Appendix 4 of Annex B.2,
and the corresponding identification number if it exists.

If the substance is not mentioned by name but is assigned to
an n.o.s. entry followed by (...) or to a collective entry
followed by (...), its description shall consist of the number
of the substance, the n.o.s. entry or the collective entry,
followed by the chemical or technical name in brackets. In
the case of a mixture the chemical or technical names of a
maximum of two components which predominantly
contribute to the danger or dangers of the mixture shall be
indicated.

The name of the substance shall be followed by particulars of
the class, the item number and, if applicable, the letter as
indicated in the list and the acronym "ADN".

For the carriage of wastes (see marginal 2002 (8) of ADR)
the name of the substance shall be preceded by the words
"wastes containing...", the descriptions being those of the
substances having the danger characteristics used for the
classification of the waste under marginal 2002 (8) of ADR.

For the carriage of solutions and mixtures (such as
preparations and wastes) containing several components
subject to ADN, it will in general be sufficient to refer to
two components which predominantly contribute to the
danger or dangers of the solutions and mixtures.

For the carriage of solutions and mixtures containing only
one
component subject to ADN, the words "solution" or
"mixture" shall be added as part of the name in the transport
document (see marginal 2002 (8) (a) of ADR);

Annex A - Part 1

- name and address of the consignor;
- mass in tonnes;
- name and address of the consignee(s).

The particulars to be entered in the transport document shall be in an official language of the forwarding country and also if that language is not English, French or German, in English, French or German unless international transport tariffs, if any, or agreements concluded between the countries concerned in the transport operation provide otherwise.

- (b) The written instructions for all dangerous goods carried as provided for in marginal 210 385 of Annex B.2;
- (c) If required, heating instructions issued by the consignor for the carriage of substances having a melting-point of 0 °C or above.

**6002
(cont'd)**

(7) If transport by sea follows or precedes transport by inland waterway, a transport document in accordance with the provisions of the IMDG Code (copy of EmS Schedules and MFAG Guide) may also be used.

(8) As evidence that the dangerous goods to be carried comply with the provisions of ADN, the following particulars shall be certified in the transport document or be confirmed otherwise in writing by the consignor:

- (a) general:
The nature of the goods conforms to the provisions of ADN (or of RID, of ADR, of the ICAO-TI or of the IMDG Code, as appropriate);
- (b) for packages:
The packages conform to the provisions of ADR (or of RID, of the ICAO-TI or of the IMDG Code, as appropriate);
- (c) for road vehicles:
The road vehicles conform to the provisions of ADR;
- (d) for tank-containers and containers:
The containers and/or tank-containers conform to the provisions of ADR (or of RID or of the IMDG Code, as appropriate).

(9) In case of mixed packing, the provisions of this Annex concerning the particulars in the transport document shall apply in respect of each of the different kinds of dangerous goods contained in the collective package.

(10) For substances, solutions and mixtures (such as preparations and wastes) not mentioned by name in the list of substances of the various classes, the provisions of marginal 2002 (8) of Annex A of ADR are applicable.

(11) For non-radioactive material (specific activity not exceeding 70 kBq/kg (2n(Ci/g))), the provisions of Annex A to ADR, marginal 2002, paragraphs (10) and (11), are applicable.

Annex A - Part 1

(12) If, by reason of the volume or weight of the load, a consignment cannot be loaded in its entirety on a single vessel, at least as many separate documents, or copies of the single document, shall be made out as the number of vessels to be loaded. Furthermore, in all cases, separate transport documents shall be made out for consignments or parts of consignments which may not be loaded together by reason of the prohibitions set forth in Annex B.1, Parts I and II.

6003

(1) Part II of this Annex contains the special provisions for the individual classes, which apply in addition to, or instead of, the provisions of ADR referred to in marginal 6002 (3) of this Annex. For Class 7, Appendix A.7 of Annex A to ADR is also applicable.

(2) The following provisions apply to packages:

(a) Packages shall comply with the provisions for packing, labelling and mixed packing of one of the International Regulations;

(b) Road vehicles (including battery-vehicles), as well as their contents, shall comply with the provisions of ADR;

**6003
(cont'd)**

(c) Tank-containers (including multiple elements tank-containers), containers and IBCs, as well as their contents, shall comply with the provisions of one of the International Regulations.

6004

As ADN does not contain any testing requirement for the classification of dangerous goods (e.g. flash-point, viscosity, sensitivity, etc.), the provisions of the other International Regulations shall apply in so far as they contain appropriate testing requirements.

**6005-
6099**

Annex A - Part II

PART II

**List of substances and special provisions
for the various classes**

CLASS 1. EXPLOSIVE SUBSTANCES AND ARTICLES

**6100-
6199**

CLASS 2. GASES

6200

List of substances

6201 The list of substances is supplemented by the entry:

"AMMONIA, ANHYDROUS, DEEPLY REFRIGERATED" to be included under "3° TC Toxic, corrosive gases".

**6202
6299**

CLASS 3. FLAMMABLE LIQUIDS

6300

List of substances

6301 This list of substances is supplemented as follows:

I. Other substances when carried in tank vessels

72° Substances having a flash-point above 61 °C which are handed over for carriage or which are carried heated within a limiting range of 15 K below their flash-point.

NOTE: Substances heated at or above their flash-point are substances of 61° (c).

73° Substances with an auto-ignition temperature of 200 °C and below which are not listed elsewhere.

**6302-
6399**

Annex A - Part II

CLASS 4.1. FLAMMABLE SOLIDS

6400

6401 **List of substances**

The list of substances is supplemented as follows:

H. Other substances

52° Oily meal, seed cakes, oil cakes containing vegetable oil and treated with solvent and which are not liable to spontaneous combustion.

NOTE: Substances of 52° are not subject to the provisions of Annex B.1 if they are prepared or treated in such a way that they do not release dangerous gases in dangerous quantities during transport (no risk of explosion) and if this is certified in the transport document.

6402-
6429

CLASS 4.2. SUBSTANCES LIABLE TO SPONTANEOUS COMBUSTION

6430-
6469

CLASS 4.3. SUBSTANCES WHICH, IN CONTACT WITH WATER, EMIT FLAMMABLE GASES

6470

6471 **List of substances**

Item 15° (c), the list of substances is supplemented with a Note as follows:

NOTE: By derogation from ADR, ferrosilicon with 25% or more (mass) of silicon is a dangerous substance of Class 4.3, item 15° (c) when carried in bulk or unpackaged on board inland navigation vessels.

6472-
6499

CLASS 5.1. OXIDIZING SUBSTANCES

6500
6501

List of substances

Item 21° (c), the list of substances is supplemented with a Note as follows:

NOTE: By derogation from ADR, type B ammonium nitrate fertilizers (identification number 2071, exempted from ADR by footnote 2/ to item 21° (c) of marginal 2501) are dangerous goods of Class 9 of ADN, see marginal 6901, item 50° (c).

6502-
6549

Annex A - Part II

CLASS 5.2. ORGANIC PEROXIDES

6550-
6599

CLASS 6.1. TOXIC SUBSTANCES

6600-
6649

CLASS 6.2. INFECTIOUS SUBSTANCES

6650-
6699

CLASS 7. RADIOACTIVE MATERIAL

6700-
6799

CLASS 8. CORROSIVE SUBSTANCES

6800
6899

CLASS 9. MISCELLANEOUS DANGEROUS SUBSTANCES AND ARTICLES

6900

6901 List of substances

The list of substances is supplemented as follows:

F. Environmentally hazardous substances

Item 11° (c), add the following substance to the end of the list: "bilge water".

G. Elevated temperature substances

Item 20°, end, add the following Note 3:

"NOTE 3: Substances having a flashpoint above 61° C which are handed over for carriage or which are carried at a temperature within a limiting range of 15 K below their flashpoint are substances of Class 3, item 72°."

H. Other substances presenting a hazard during carriage but not meeting the definition of another class

Item 39° (c), add:

"39° (c) 2216 Fishmeal, stabilized (humidity between 5% by mass and 12% by mass with a maximum of 15% fat by mass) or

Annex A - Part II

**6901
(cont'd)**

2216 Fishscrap, stabilized (humidity between 5% by mass and 12% by mass with a maximum 15% by mass)."

50° Substances subject to self-sustaining exothermic decomposition

(c) 2071 Ammonium nitrate fertilizers

Type B: uniform non-segregating mixtures of nitrogen/phosphate or nitrogen/potash types or complete fertilizers or nitrogen/phosphate/potash type with not more than 70% ammonium nitrate and with not more than 0.4% total added combustible material, or with not more than 45 % ammonium nitrate with unrestricted combustible material.

NOTE 1: In determining the ammonium nitrate content, all nitrate ions for which a molecular equivalent of ammonium ions is present in the mixture should be calculated as ammonium nitrate.

NOTE 2: Ammonium nitrate fertilizers of Class 9, item 50° (c) are not subject to ADN if

(a) *shown by a trough test (see United Nations Recommendations on the Transport of Dangerous Goods, Manual of Tests and Criteria, Section 38.2) not to be liable to self-sustaining decomposition; and*

(b) *provided that they do not contain an excess of nitrate greater than 10% by mass calculated as potassium nitrate.*

J. Miscellaneous substances when carried in tank-vessels

80° Substances with a flash-point above 61 °C and not more than 100 °C, which do not belong to another class or to Class 9, items 1° to 71°.

81° Diphenylmethane-4,4'-diisocyanate.

**6902-
6999**

ANNEX B.1

Provisions concerning the carriage of dangerous goods in packages or in bulk

(RESERVED)

ANNEX B.1**PROVISIONS CONCERNING THE CARRIAGE
OF DANGEROUS GOODS IN PACKAGES OR IN BULK****TABLE OF CONTENTS**

Part I	-	DEFINITIONS AND GENERAL PROVISIONS CONCERNING THE CARRIAGE OF DANGEROUS GOODS OF ALL CLASSES	
			Marginals
General		Plan of Annex B.1	10 000
		Applicability of other regulations	10 001
		Exempted quantities	10 011
		Definitions	10 014
SECTION 1.		Mode of carriage of goods	
		Carriage of packages	10 110
		Carriage in bulk	10 111
		Containers and intermediate bulk containers (IBCs)	10 118
		Road vehicles	10 119
		Carriage in cargo tanks	10 121
SECTION 2.		Requirements applicable to vessels	
		Construction	10 200
		Instructions for the use of devices and installations	10 205
		Classification	10 208
		Pushed convoys and side-by-side formations	10 219
		Fire-extinguishing arrangements	10 240
		Electrical installations	10 251
		Special equipment	10 260
		Checking and inspection of equipment	10 280
		Certificate of approval	10 282
		Provisional certificate of approval	10 283
SECTION 3.		General service requirements	
		Access to holds, double-hull spaces and double bottoms; inspections	10 301
		Repair and maintenance work	10 308
		Dangerous goods training	10 315
		Water ballast	10 320
		Opening of holds	10 322
		Persons authorized on board	10 327
		Engines	10 331
		Oil fuel tanks	10 332
		Fire-extinguishing arrangements	10 340
		Fire and naked light	10 341
		Heating of holds	10 342
		Cleaning operations	10 344
		Electrical installations	10 351

Table of contents of Annex B.1

Marginals

Portable lamps	10 354
Special equipment	10 360
Admittance on board	10 371
Prohibition of smoking	10 374
Checking of equipment	10 380
Documents	10 381
Instructions in writing	10 385
 SECTION 4. Additional requirements concerning loading, carriage, unloading and other handling of the cargo	
Limitation of the quantities carried	10 401
Prohibition of mixed loading (holds)	10 403
Prohibition of mixed loading (containers, road vehicles)	10 404
Prohibition of mixed loading (seagoing vessels)	10 405
Places of loading and unloading	10 407
Cargo transfer operations	10 409
Stowage plan	10 411
Ventilation	10 412
Measures to be taken before loading	10 413
Handling and stowage of the cargo	10 414
Measures to be taken after unloading	10 415
Measures to be taken during loading, carriage, unloading and handling	10 416
Lighting	10 453
Risk of sparking	10 475
Synthetic ropes	10 476
 SECTION 5. Additional requirements concerning the operation of vessels	
Marking	10 500
Mode of navigation	10 501
Mooring	10 503
Berthing	10 504
Reporting duty	10 508
 Part II - SPECIAL PROVISIONS CONCERNING THE CARRIAGE OF DANGEROUS GOODS OF CLASSES 1 TO 9 SUPPLEMENTING OR AMENDING THE PROVISIONS OF PART I	
Class 1 Explosive substances and articles	11 000 and seq.
Class 2 Gases	21 000 and seq.
Class 3 Flammable liquids	31 000 and seq.
Class 4.1 Flammable solids	41 000 and seq.
Class 4.2 Substances liable to spontaneous combustion	42 000 and seq.
Class 4.3 Substances which, in contact with water, emit flammable gases	43 000 and seq.

Table of Contents of Annex B.1

	Marginals
Class 5.1	Oxidizing substances 51 000 and seq.
Class 5.2	Organic peroxides 52 000 and seq.
Class 6.1	Toxic substances 61 000 and seq.
Class 6.2	Infectious substances 62 000 and seq.
Class 7	Radioactive material 71 000 and seq.
Class 8	Corrosive substances 80 000 and seq.
Class 9	Miscellaneous dangerous substances and articles 91 000 and seq.
Part III	- RULES FOR CONSTRUCTION
	Materials of construction 110 200
	Holds 110 211
	Ventilation 110 212
	Accommodation and service spaces 110 217
	Water ballast 110 220
	Engines 110 231
	Oil fuel tanks 110 232
	Exhaust pipes 110 234
	Stripping installation 110 235
	Fire-extinguishing arrangements 110 240
	Fire and naked light 110 241
	Type and location of electrical equipment 110 252
	Electric cables 110 256
	Metal wires, masts 110 270
	Admittance on board 110 271
	Prohibition of smoking, fire and naked light 110 274
	Additional rules applicable to double-hull vessels
	Classification 110 288
	Holds 110 291
	Emergency exit 110 292
	Stability (general) 110 293
	Stability (intact) 110 294
	Stability (damaged condition) 110 295
Part IV-	RULES FOR CONSTRUCTION APPLICABLE TO SEAGOING VESSELS WHICH COMPLY WITH THE REQUIREMENTS OF THE SOLAS CONVENTION, CHAPTER II-2, REGULATION 54
	General 120 100
	Materials of construction 120 200
	Water ballast 120 220
	Engines 120 231

Table of Contents of Annex B.1

	Marginals
Exhaust pipes	120 234
Fire and naked light	120 241
Admittance on board	120 271
Prohibition of smoking, fire and naked light	120 274
 Additional rules applicable to double-hull vessels	
Classification	120 288
Holds	120 291
Stability (general)	120 293
Stability (intact)	120 294
Stability (damaged condition)	120 295

Appendices

- Appendix 1** Model 1: Model for a certificate of approval
 Model 2: Model for a provisional certificate of approval
 Model 3: Certificate of special knowledge of ADN
- Appendix 2** Models of danger labels prescribed by international regulations
- A. Danger labels
 - B. Marking of transport units (placarding)

Part I

Definitions and general provisions concerning the carriage of dangerous goods of all classes

(RESERVED)

Annex B.1 - Part I

General

10 000 Plan of Annex B.1

(1) This Annex comprises provisions concerning the carriage of dangerous goods in packages or in bulk.

(2) The provisions of Annex B.1 are divided into parts as follows:

- Part I - Definitions and general provisions concerning the carriage of dangerous goods of all classes**
- Part II - Special provisions concerning the carriage of dangerous goods of Classes 1 to 9 supplementing or amending the provisions of Part I**
- Part III - Rules for construction**
- Part IV - Rules for construction applicable to seagoing vessels which comply with the requirements of the SOLAS Convention, Chapter II-2, regulation 54.**

10 001 Applicability of other regulations

(1) In accordance with Article 9 of the Agreement, transport operations shall remain subject to local, regional or international provisions applicable in general to the carriage of goods by inland waterway.

(2) Where provisions of Parts II, III or IV conflict with provisions of Part I or with the provisions referred to in paragraph (1) above, the provisions of Part I or those referred to in paragraph (1) above shall not apply.

The provisions of marginal 10 011, however, shall take precedence over those of Parts II, III and IV.

(3) The special provisions applicable to the individual classes as set out in Part II shall supplement the general provisions of Part I.

10 002- 10 010

10 011 Exempted quantities

(1) The following maximum quantities of dangerous goods in packages may be carried on one vessel without the provisions of this Annex having to be applied. For dangerous goods not mentioned in the table below and for the carriage of tanks (tank-containers, road tank vehicles, etc.) the provisions of this Annex shall be fully complied with.

Annex B.1 - Part I**10 011
(cont'd)**

Class	Item number	Maximum exempted quantity per class (gross mass)	Maximum total exempted quantity per vessel (gross mass)
(1)	(2)	(3)	(4)
2	2°A	3 000 kg */	3 000 kg */
	2°F	300 kg */	
3	3°(b), 4°(b), 5°(b), 5°(c)	300 kg */	3 000 kg */
	31°(c)	3 000 kg */	
4.1	1°(b), 6°(b), 7°(b), 8°(b), 11°(b), 12°(b), 13°(b), 14°(b), 16°(b), 17°(b)	3 000 kg */	30 000 kg */
	2°(c), 3°(c), 4°(c), 6°(c), 7°(c), 8°(c), 11°(c), 12°(c), 13°(c), 14°(c), 16°(c), 17°(c)	30 000 kg */	
5.1	41°	unlimited	unlimited
5.2	31°	30 000 kg */	30 000 kg */
6.1	any with letter (c)	3 000 kg */	3 000 kg */
7	Schedules 1 to 4 of Annex A (ADR)	unlimited	unlimited
8	any with letter (c)	30 000 kg */	30 000 kg */

*/ Including empty uncleaned packagings having previously contained these goods.

The total exempted quantity allowed in any one vessel shall be determined from the quantities given in:

column 3, where goods of any one line are carried;

or

column 4, where goods of more than one line are carried, however, subject to the maximum quantity given for each line in column 3. The maximum quantities per class shown in column 4 may be added.

(2) The carriage of exempted quantities shall, however, be subject to the following conditions:

(a) The following documents shall be carried on board:

- transport documents (see marginal 6002 (5)); the transport documents shall cover all dangerous goods carried;
- the stowage plan prescribed in marginal 10 411.

Annex B.1 - Part I

**10 011
(cont'd)**

- (b) The goods shall be stowed in the holds.

This shall not apply to goods loaded in:

- containers having sprayproof complete walls;
- road vehicles having sprayproof complete walls;
- tank-containers; and road tank vehicles.

- (c) Goods of different classes shall be separated by a minimum horizontal distance of 3.00 m. They shall not be stowed one on top of the other.

This shall not apply to:

- containers having complete metal walls; and
- road vehicles having complete metal walls.

For seagoing vessels and inland waterway vessels, where the latter are only carrying containers, the requirements in (b) and (c) above shall be deemed to have been met, if the stowage and segregation requirements of the IMDG Code have been complied with and a note to this effect has been entered in the transport document.

**10 012-
10 013**

10 014 Definitions

For the purposes of this Annex:

Electrical equipment

IEC means the International Electrotechnical Commission.

Classification of zones (see IEC publication 79-10)

Zone 1: areas in which dangerous explosive atmospheres of gases, vapours or sprays are likely to occur occasionally;

Zone 2: areas in which dangerous explosive atmospheres of gases, vapours or sprays are likely to occur rarely and if so for short periods only.

Certified safe type electrical apparatus

means an electrical apparatus which has been tested and approved by the competent authority regarding its safety of operation in an explosive atmosphere, e.g.

- intrinsically safe apparatus;
- flameproof enclosure apparatus;
- apparatus protected by pressurization;
- powder filling apparatus;
- apparatus protected by encapsulation;
- increased safety apparatus.

Annex B.1 - Part I

10 014
(cont'd)

NOTE: "Limited explosion risk" apparatus is not covered by this definition.

Explosion group (see IEC publication 79 and EN 50 014)

means a grouping of flammable gases and vapours according to their maximum experimental safe gaps and minimum ignition currents, and of electrical apparatus which may be used in the corresponding potentially explosive atmosphere.

Electrical apparatus protected against water jets

means an electrical apparatus so designed that water, projected by a nozzle on the enclosure from any direction, has no damaging effects. The test conditions are specified in the IEC publication 529, minimum degree of protection IP 55.

Limited explosion risk electrical apparatus

means an electrical apparatus which, during normal operation, does not cause sparks or exhibits surface temperatures which are above the required temperature class, including e.g.

- three-phase squirrel cage rotor motors;
- brushless generators with contactless excitation;
- fuses with an enclosed fuse element;
- contactless electronic apparatus;

or means an electrical apparatus with an enclosure protected against water jets (degree of protection IP 55) which during normal operation does not exhibit surface temperatures which are above the required temperature class.

Temperature class (see IEC publication 79 and EN 50 014)

means a grouping of flammable gases and vapours of flammable liquids according to their ignition temperature; and of the electrical apparatus intended to be used in the corresponding potentially explosive atmosphere according to their maximum surface temperature.

Types of protection (see IEC Publication 79 and EN 50 014)

EEx (d)	:	flameproof enclosure (EN 50 018);
EEx (e)	:	increased safety (EN 50 019);
EEx (ia) and EEx (ib)	:	intrinsic safety (EN 50 020);
EEx (m)	:	encapsulation (EN 50 028);
EEx (p)	:	pressurized apparatus (EN 50 016);
EEx (q)	:	powder filling (EN 50 017).

Division of space

Accommodation

means spaces intended for the use of persons normally living on board, including galleys, food stores, lavatories, washrooms, bathrooms, laundries, halls, alleyways, etc., but excluding the wheelhouse.

Annex B.1 - Part I

10 014 *Bulkhead* (cont'd)

means a metal wall or partition, generally vertical, both sides of which are inside the vessel and which is bounded by the bottom, the side plating, a deck, the hatchway covers or by another bulkhead.

Bulkhead (watertight)

A bulkhead shall be considered watertight if it has been constructed so that it can withstand water pressure with a head of 1 metre above the deck but at least to the top of the hatchway coaming whichever is the greater.

Cargo tank

means a tank which is permanently attached to the vessel and the boundaries of which are either formed by the hull itself or by walls separate from the hull and which is intended for the carriage of dangerous goods.

Hold (see also "zone 1")

means a part of the vessel which, whether covered by hatchway covers or not, is bounded fore and aft by bulkheads and which is intended to carry goods in packages or in bulk. The upper boundary of the hold is the upper edge of the hatchway coaming. Cargo extending above the hatchway coaming shall be considered as loaded on deck.

Protected area means

- (a) the hold or holds (see also zone 1);
- (b) the space situated above the deck (see also zone 2), bounded:
 - (i) athwartships, by vertical planes corresponding to the side plating;
 - (ii) fore and aft, by vertical planes corresponding to the end bulkheads of the hold; and
 - (iii) upwards, by a horizontal plane 2.00 m above the upper level of the load, but at least by a horizontal plane 3.00 m above the deck.

Service space

means a space which is accessible during the operation of the vessel and which is neither part of the accommodation nor of the holds, with the exception of the forepeak and afterpeak, provided no machinery has been installed in these latter spaces.

Regulations

ADR

means the European Agreement concerning the International Carriage of Dangerous Goods by Road.

Annex B.1 - Part I

10 014 *BC Code*
(cont'd)

means the Code of Safe Practice for Solid Bulk Cargoes of the International Maritime Organization (IMO).

ICAO-TI

means the Technical Instructions for the Safe Transport of Dangerous Goods by Air of the International Civil Aviation Organization (ICAO).

IMDG Code

means the International Maritime Dangerous Goods Code of the International Maritime Organization (IMO).

International regulations

means ADR, BC Code, ICAO-TI, IMDG Code or RID.

RID

means the Regulations concerning the International Carriage of Dangerous Goods by Rail.

SOLAS

means the International Convention for the Safety of Life at Sea, 1974, as amended.

Miscellaneous

Battery—vehicle

means a vehicle with an assembly of:

several cylinders according to marginal 2211 (1) of ADR; or
several tubes according to marginal 2211 (2) of ADR; or
several pressure drums according to marginal 2211 (3) of ADR; or
several bundles of cylinders according to marginal 2211 (5) of ADR; or
several tanks according to the definition of Annex B of ADR

interconnected by a manifold and permanently mounted on the transport unit.

Breathing apparatus (ambient air—dependent)

means an apparatus which protects the person wearing it when working in a dangerous atmosphere by means of a suitable filter.

Breathing apparatus (self-contained)

means an apparatus which supplies the person wearing it when working in a dangerous atmosphere with breathing air by means of pressurized air carried with him or by means of a tube.

Annex B.1 - Part I

10 014
(cont'd)

Carriage in bulk

means the carriage of solid substances, material or articles without packaging.

Classification society (recognized)

means a classification society which is recognized by the competent authorities in accordance with Annex C, Chapter 2.

Competent authority

means the authority designated or recognized as such in each country and in each specific case in connection with these provisions.

Container

means an article of transport equipment (lift van or other similar structure):

- of a permanent character and accordingly strong enough to be suitable for repeated use;
- specially designed to facilitate the carriage of goods, by one or more means of transport, without breakage of load;
- fitted with devices permitting its ready handling, particularly when being transloaded from one means of transport to another; and
- so designed as to be easy to fill and empty, and having an internal volume of not less than 1.00 m³.

The term "container" does not cover conventional packagings, intermediate bulk containers (IBCs), vehicles and tank-containers.

Containers for the carriage of materials of Class 7 shall, in addition, be of a permanent enclosed character, rigid and strong enough for repeated use. They may be used as packagings if the applicable requirements are met, and they may also be used to perform the functions of overpacks.

Damage control plan

The damage control plan shall indicate the water-tight subdivision serving as the basis for the stability calculations, the arrangements necessary to offset a list caused by water penetration and all closing appliances which are to be kept closed during the voyage.

Dangerous goods

means the substances and materials themselves and articles containing dangerous substances, including wastes as defined in marginal 6000 (5), and which are covered by the relevant definitions (see lists of substances) for Classes 1 to 9 of ADR or which are listed as such in Part II of Annex A to ADN.

10 014

NOTE: In accordance with marginal 6002 (4) of Annex A, dangerous goods used for the

Annex B.1 - Part I

(cont'd) *propulsion of the vessels or vehicles, the operation of their special equipment, for household purposes or for maintaining safety and which are carried on board in their usual containment are not subject to the provisions of this Agreement.*

Escape device (suitable)

means a respiratory protection device, designed to cover the wearer's mouth, nose and eyes, which can be easily put on and which serves to escape from a danger area.

Flammable gas detector

"Flammable gas detector" means a device allowing measuring of any significant concentration of flammable gases given off by the cargo below the lower explosive limit and which clearly indicates the presence of higher concentrations of such gases. Flammable gas detectors may be designed for measuring flammable gases only but also for measuring both flammable gases and oxygen.

This device shall be so designed that measurements are possible without the necessity of entering the spaces to be checked.

Gases

means gases or vapours.

Highest class may be assigned to a vessel when:

- the hull, inclusive of rudder and steering gear and equipment of anchors and chains, complies with the rules and regulations of a recognized classification society and has been built and tested under its supervision;
- the propulsion plant, together with the essential auxiliary engines, mechanical and electrical installation, have been made and tested in conformity with the rules and regulations of this classification society, and the installation has been carried out under its supervision and, was tested to its satisfaction on completion.

Hold (condition)

discharged: empty, but containing residual cargo

empty: without residual cargo (swept clean).

Identification number

means the number for identifying a substance, material or article. These numbers are taken from the United Nations "Recommendations on the Transport of Dangerous Goods".

Intermediate Bulk Container (IBC)

means a rigid, semi-rigid or flexible portable packaging, other than those specified in Appendix A.6 of Annex A to ADR, and which:

- has a capacity of not more than 3.00 m³ (3,000 litres);

Annex B.1 - Part I

**10 014
(cont'd)**

- is designed for mechanical handling;
- is resistant to the stresses produced in handling and transport, as determined by the tests specified in international regulations.

Naked light

means light produced by a flame which is not enclosed in a flameproof enclosure.

Oxygen meter

means a device allowing measuring of any significant reduction of the oxygen content of the air. Oxygen meters may be designed and constructed for measuring oxygen only or for measuring both flammable gas and oxygen.

This device shall be so designed that measurements are possible without the necessity of entering the spaces to be checked.

Package

The term package also includes road vehicles (including battery-vehicles), containers (including swap bodies), tank-containers (including multiple elements tank-containers), intermediate bulk containers (IBCs).

Packages (carriage in)

means the carriage of any packaged solid, liquid or gaseous substance, material or article, or any solid material which cannot be carried in bulk.

Road vehicle means any vehicle covered by the definition of the term "vehicle" in the ADR.

Steersman

means a person as defined in Article 1.02 of the European Code for Inland Waterways (CEVNI).

Tank-container

means an article of transport equipment (including swap body tanks) conforming to the definition of "container" given above and built to contain liquid, gaseous, powdery or granular substances or materials and having a capacity of more than 0.45 m³.

Toximeter

means a device allowing measuring of any significant concentration of toxic gases given off by the cargo.

This device shall be so designed so that such measurements shall be possible without the necessity of entering the spaces to be checked.

Vessel

means an inland navigation vessel or a seagoing vessel.

10 014 The following definitions refer only to the carriage of materials of Class 7:

Annex B.1 - Part I

(cont'd)

Conveyance

means, with respect to the carriage by inland waterway, any vessel, hold or defined deck area of any vessel.

Exclusive use

means the sole use, by a single consignor, of a conveyance or of a large container with a minimum length of 6.00 m, in respect of which all initial, intermediate, and final loading and unloading is carried out in accordance with the directions of the consignor or consignee.

**10 015-
10 099**

SECTION 1. Mode of carriage of goods

**10 100-
10 109**

10 110 Carriage of packages

Unless otherwise specified, the masses given for packages shall be the gross masses. Where packages are carried in containers or vehicles, the mass of the container or vehicle shall not be included in the gross mass of such packages.

10 111 Carriage in bulk

The carriage of dangerous goods in bulk is prohibited, except where this mode of carriage is explicitly authorized by the provisions of Part II.

**10 112-
10 117**

10 118 Containers and intermediate bulk containers (IBCs)

The carriage of containers, IBCs, tank-containers (including multiple-elements tank-containers) shall be in accordance with the provisions applicable to the carriage of packages.

10 119 Road vehicles

The carriage of road vehicles (including battery-vehicles) shall be in accordance with the provisions applicable to the carriage of packages.

10 120

10 121 Carriage in cargo tanks

The carriage of dangerous goods in cargo tanks in dry-cargo vessels is prohibited.

For carriage in tank vessels see Annex B.2.

10 122-

Annex B.1 - Part I

10 199

SECTION 2. Requirements applicable to vessels

10 200 Construction

(1) The vessels referred to in marginal 10 282 (1) shall comply with the rules for construction of Part III.

(2) For seagoing vessels, this requirement shall be deemed to have been met if, instead of the requirements of Part III, the requirements set out in Part IV are complied with.

**10 201-
10 204**

10 205 Instructions for the use of devices and installations

Where specific safety rules have to be complied with when using any device or installation, instructions for the use of the particular device or installation shall be readily available for consultation at appropriate places on board in the language normally spoken on board and also, if that language is not English, French or German, in English, French or German unless agreements concluded between the countries concerned in the transport operation provide otherwise.

**10 206-
10 207**

10 208 Classification

Double-hull vessels carrying dangerous goods of Classes 2, 3, 4.1, 5.2, 6.1, 8 or 9, except those of 31° (b), 32° (b), 41° (b) and 42° (b) of Class 4.1 and of 1° (b) and 2° (b), 11° (b) and 12° (b) of Class 5.2, in quantities larger than those indicated in marginal 10 401 (1) or carrying materials of Class 7, marginal 2704 schedules 5 to 13, of Annex A to ADR, shall comply with the requirements of marginals 110 288 or 120 288.

**10 209-
10 218**

10 219 Pushed convoys and side-by-side formations

(1) Where at least one vessel of a convoy or side-by-side formation is required to be in possession of a certificate of approval in accordance with marginal 10 282, all vessels of such convoy or side-by-side formation shall be provided with an appropriate certificate of approval.

Vessels not carrying dangerous goods shall comply with the following marginals:

10 205, 10 251, 10 260 (1) and (2), 10 280 (1) and (2), 10 282 (1) to (8), 10 283 (1) and (2), 110 200, 110 212 (3), 110 217 (2) and (3), 110 231 (1) to (3), 110 232 (1) and (2), 110 234 (1) and (2), 110 241 (1) to (3), 110 252 (2) and (3), 110 256 (1) to (3), 110 271 and 110 274 (1) to (3).

10 219 (2) For the purposes of the application of the provisions of Parts I and II, the entire pushed

Annex B.1 - Part I

(cont'd) convoy or the side-by-side formation shall be deemed to be a single vessel.

**10 220-
10 239**

10 240 Fire-extinguishing arrangements

(1) Each vessel shall be equipped, in addition to the fire-extinguishing appliances prescribed in marginal 10 001 (1), with at least two extinguishers having the same capacity. The fire-extinguishing agent contained in these additional hand fire-extinguishers shall be suitable for fighting fires involving the dangerous goods being carried.

(2) The fire-extinguishing agent contained in fixed fire-extinguishing systems shall be suitable and sufficient in quantity for fighting fires.

**10 241-
10 250**

10 251 Electrical installations

The insulation resistance of electrical installations, the earthing and the flameproof electrical equipment shall be inspected whenever the certificate of approval is renewed and, in addition, within the third year from the date of issue of the certificate of approval, by a person authorized for this purpose by the competent authority. An appropriate inspection certificate shall be kept on board.

**10 252-
10 259**

10 260 Special equipment

(1) When this is required in Part II, the following equipment shall be available on board:

- (a) for each member of the crew a pair of protective goggles, a pair of protective gloves, a protective suit and a suitable pair of protective shoes (if required, protective boots);
- (b) a suitable escape device for each person on board;
- (c) a flammable gas detector with the instructions for its use;
- (d) a toximeter with the instructions for its use;
- (e) breathing apparatus (ambient air-dependent).

Materials and additional protective equipment specified by the consignor in the written instructions shall be provided by the consignor and shall be available on board.

(2) For pushed convoys or side-by-side formations under way it shall be sufficient, however, if the pusher tug or the vessel propelling the side-by-side formation is equipped with the special equipment referred to in (1) above, when this is required in Part II.

**10 261-
10 279**

Annex B.1 - Part I

10 280 Checking and inspection of equipment

- (1) The fire-extinguishing appliances and hoses shall be inspected at least once every two years by persons authorized for this purpose by the competent authority.
- (2) The special equipment referred to in marginal 10 260 (1) shall be inspected in accordance with the instructions of the manufacturer concerned by persons authorized either by the manufacturer himself or by the competent authority.

10 281

10 282 Certificate of approval

- (1) Vessels carrying dangerous goods in excess of the limited quantities covered to in marginal 10 011 and vessels covered by marginal 10 219 (1) shall be in possession of an appropriate certificate of approval.
- (2) The certificate of approval shall attest that the vessel has been inspected and that its construction and equipment comply with the applicable provisions of this Annex.
- (3) The certificate of approval shall be issued in accordance with the requirements and procedures set out in Annex C.

It shall conform to model No. 1 of Appendix 1 to this Annex.

- (4) The certificate of approval shall be valid for not more than five years. The date on which the period of validity expires shall be shown on the certificate. The competent authority which issued the certificate may, without inspection of the vessel, extend the validity of the certificate by not more than one year. Such extension may be granted only once within two periods of validity (see also Annex C, Chapter 1, paragraph 1.10).
- (5) For double-hull vessels which comply with the additional rules for construction of Part III or IV, the competent authority shall enter in the certificate of approval the following endorsement:

"The vessel complies with the additional requirements of Annex B.1 of ADN applicable to double-hull vessels."

10 283 Provisional certificate of approval

- (1) For a vessel which is not provided with a certificate of approval, a provisional certificate of approval of limited duration may be issued in the following cases and subject to the following conditions:
 - (a) The vessel complies with the applicable requirements of this Annex, but the certificate of approval could not be issued in time. The provisional certificate of approval shall be valid for an appropriate period but not exceeding three months.
 - (b) The vessel does not comply with every applicable requirement of this Annex after sustaining damage. In this case the provisional certificate of approval shall be valid only for a single specified voyage and for a specified cargo. The competent authority may impose additional conditions.

- (2) The provisional certificate of approval shall conform to model No. 2 in Appendix 1 to this Annex or to a single certificate model for the provisional certificate of inspection and the

Annex B.1 - Part I

provisional certificate of approval provided that this single certificate model include the same particulars as Model No. 2 and is approved by the competent authority.

**10 284-
10 299**

SECTION 3. General service requirements

10 300

10 301 Access to holds, double-hull spaces and double bottoms; inspections

- (1) Access to the holds is not permitted except for the purpose of loading or unloading and carrying out inspections or cleaning work.
- (2) Access to the double-hull spaces and the double bottoms is not permitted while the vessel is under way.
- (3) If the concentration of gases or the oxygen content of the air in holds, double-wall spaces or double bottoms has to be measured before entry the results of these measurements shall be recorded in writing. The measurement may only be effected by persons equipped with suitable breathing apparatus for the substance carried.

Entry into the spaces is not permitted for the purpose of measuring.

**10 302-
10 307**

10 308 Repair and maintenance work

No repair or maintenance work liable to cause sparks, or requiring the use of an open flame or electric current, shall be undertaken in the protected area or on deck within 3 metres fore and aft of it, unless permission has been given by the competent authority, or a gas-free certificate has been issued for the protected area. The use of chromium vanadium steel screw drivers and wrenches is permitted.

**10 309-
10 314**

10 315 Dangerous goods training

- (1) An expert shall be on board the vessel. This person shall not be less than 18 years of age.
- (2) An expert is a person who has a special knowledge of the ADN. Proof of this knowledge shall be furnished by means of a certificate from a competent authority or from an agency recognized by the competent authority.

Annex B.1 - Part I

10 315 (cont'd) This certificate shall be issued to persons who, after training, have successfully passed a qualifying ADN examination. The certificate shall conform to the model No. 3 in Appendix 1 to this Annex. The training shall be approved by the competent authority.

(3) The training shall cover at least the subjects listed below and shall include practical exercises:

- (a) general provisions concerning the carriage of dangerous goods, e.g. with respect to the contents of ADN, temperature, mass, quantity, concentration, degree of filling, calculation of contents, liquid-level gauging, sampling, check list, overfilling, pumping, marking of vessels, labelling of packages, instructions in writing;
- (b) definitions of terms (e.g. liquids, solids, viscosity, gases or vapours), basic knowledge of products;
- (c) nature of risks such as combustion, explosion, sources of ignition, electrostatic charge, toxicity, radioactivity, corrosivity, danger to the aquatic environment;
- (d) measures to avoid accidents; prevention of explosion;
- (e) measures to be taken in the event of an accident or an incident (first aid, "keep-off" signal, emergency call, safety of traffic, use of appliances such as fire-extinguishers and personal protective equipment);
- (f) tasks of the crew and of the expert with respect to the carriage of dangerous goods;
- (g) equipment of vessels carrying dangerous goods, e.g. flammable gas detectors, oxygen meters and toximeters; tests to be carried out before entering spaces; certificates attesting a gas-free condition; and
- (h) practical exercises, in particular with respect to entry into spaces, use of fire-extinguishers, fire-fighting equipment and personal protection equipment as well as flammable gas detectors, oxygen meters and toximeters.

(4) Every competent authority or agency recognized by that competent authority may determine the procedures and syllabus of the qualifying examination according to (2) above on the basis of the items listed in (3) above, letters (a) to (g), and of Annex C, Chapter 6.

(5) The certificate referred to in (2) above shall be valid for a period of five years and may be extended if proof is furnished of participation in a refresher or advanced training course recognized by the competent authority, which is based on the programme referred to in (3) above and which comprises, in particular, current new developments. The refresher or advanced training course shall be taken in the last year prior to the expiry of the certificate. When the refresher or advanced training course is taken in the year preceding the date of expiry of the certificate, the new period of validity shall begin on the expiry date of the preceding certificate, but in other cases it shall begin on the date of certification of participation in the course.

**10 316-
10 319**

Annex B.1 - Part I

10 320 Water ballast

Double-hull spaces and double bottoms may be used for water ballast.

10 321

10 322 Opening of holds

(1) Dangerous goods shall be protected against the influences of weather and against spray water except during loading and unloading or during inspection.

This provision does not apply when dangerous goods are loaded in sprayproof containers, sprayproof IBCs, tank-containers or road vehicles.

(2) Where dangerous goods are carried in bulk, the holds shall be covered with hatch covers.

**10 323-
10 326**

10 327 Persons authorized on board

(1) The only persons authorized on board are:

- (a) members of the crew;
- (b) persons who, although not being members of the crew, normally live on board; and
- (c) persons who are on board for official reasons.

(2) The persons referred to in (1) (b) above are not authorized to remain in the protected area except for short periods.

**10 328-
10 330**

10 331 Engines

The use of engines running on fuels having a flash-point below 55 °C (e.g. petrol engines) is prohibited.

This requirement does not apply to the outboard motors of lifeboats.

10 332 Oil fuel tanks

Double bottoms with a height of at least 0.6 m may be used as oil fuel tanks provided that they have been constructed in accordance with Part III.

**10 333-
10 339**

10 340 Fire-extinguishing arrangements

The crew shall have been trained in the use of the fire-extinguishing systems and the fire-extinguishing appliances.

Annex B.1 - Part I

10 341 Fire and naked light

(1) The use of fire or naked light is prohibited. This provision does not apply to the accommodation and the wheelhouse.

(2) Heating, cooking and refrigerating appliances shall not be fuelled with liquid fuels, liquid gas or solid fuels.

Cooking and refrigerating appliances may only be used in the accommodation and in the wheelhouse.

(3) Heating appliances or boilers fuelled with liquid fuels having a flash–point above 55 °C which are installed in the engine room or in an other suitable space may, however, be used.

10 342 Heating of holds

The heating of holds or the operation of a heating system in the holds is prohibited.

10 343

10 344 Cleaning operations

The use of liquids having a flash-point below 55 °C for cleaning purposes is prohibited.

10 345-

10 350

10 351 Electrical installations

(1) The electrical installations shall be properly maintained in a faultless condition.

(2) The use of movable electric cables is prohibited in the protected area. This provision does not apply to:

- intrinsically safe electric circuits;
- electric cables for connecting signal lights or gangway lighting, provided the socket is permanently fitted to the vessel close to the signal mast or gangway;
- electric cables for connecting containers;
- electric cables for electrically operated hatch cover gantries;
- electric cables for connecting submerged pumps.

(3) The sockets for connecting the signal lights and gangway lighting and for connecting containers submerged pumps, or hatch cover gantries shall not be live except when the signal lights or the gangway lighting are switched on or when the containers or the submerged pumps or the hatch cover gantries are in operation. In the protected area, connecting or disconnecting shall not be possible except when the sockets are not live.

(4) The electrical installations in the holds shall be kept switched off and protected against unintentional connection.

Annex B.1 - Part I

10 351 (cont'd) This provision does not apply to permanently installed cables passing through the holds, to movable cables connecting containers, or to electrical apparatus of a "certified safe type".

**10 352-
10 353**

10 354 Portable lamps

The only portable lamps permitted in the protected area are electric lamps having their own source of power.

They shall at least be of the certified safe type.

**10 355-
10 359**

10 360 Special equipment

(1) The crew shall be familiar with the use of the special equipment referred to in marginal 10 260 (1).

(2) Persons who have to wear the breathing apparatus in accordance with marginals 21 301 (2), 31 301 (2), 41 301 (2), 43 301 (2), 52 301 (2), 61 301 (2), 81 301 (2) or 91 301 (2) of Part II of this Annex when entering the holds shall have been trained in the use of such apparatus and shall be capable of withstanding the additional physical strain.

**10 361-
10 370**

10 371 Admittance on board

No unauthorized persons shall be permitted on board. This prohibition shall be displayed on notice boards at appropriate places.

**10 372-
10 373**

10 374 Prohibition of smoking

Smoking on board the vessel is prohibited. This prohibition shall be displayed on notice boards at appropriate places.

This prohibition does not apply to the accommodation or the wheelhouse, provided its windows, doors, skylights and hatches are closed.

**10 375-
10 379**

10 380 Checking of equipment

The measuring instruments prescribed in this Annex shall be checked each time before use by the user in accordance with the instructions for use.

Annex B.1 - Part I

10 381 Documents

(1) In addition to the documents required by other regulations, the following documents shall be kept on board:

- (a) the vessel's certificate of approval;
- (b) transport documents (see marginal 6002 (5)). The transport documents shall cover all dangerous goods on board;
- (c) the instructions in writing referred to in marginal 10 385 for all dangerous goods on board;
- (d) the stowage plan required by marginal 10 411;
- (e) a copy of the ADN with its Annexes A, B.1 and B.2 (at least Annex A and Annex B.1) and Annexes C, D.1 and D.2;
- (f) the certificate required in marginal 10 315;
- (g) a book in which all required measurement results are recorded;
- (h) for double-hull vessels (see marginal 10 208), the damage control plan;
- (i) for double-hull vessels (see marginal 10 208) the documents concerning intact stability as well as all conditions of intact stability taken into account for the damaged stability calculations in a form the steersman understands.

(2) The transport documents and the instructions in writing shall be given to the steersman before loading.

(3) Where an inspection or examination is prescribed in this Annex, the following additional documents shall also be kept on board:

The valid inspection documents for the fire-extinguishing appliances, fire-hoses, electrical appliances and, if required, for the special equipment;

Particulars of the inspection shall be marked on the fire-extinguishing appliances as a proof of inspection.

(4) For pushed barges which are not carrying dangerous goods (marginal 10 219), the certificate of approval need not be kept on board, provided the following additional particulars are marked in identical characters on the metal plate required by the European Code for Inland Waterways:

Number of the certificate of approval: ...

Issued by: ...

Valid until: ...

The certificate of approval shall, in this case, be kept by the owner of the pushed barge.

Annex B.1 - Part I

10 381 A competent authority shall check whether the particulars shown on the plate are in conformity
(cont'd) with those on the certificate of approval and emboss the plate with its stamp.

10 382-
10 384

10 385 Instructions in writing

(1) Regarding the action to be taken in the event of an accident or incident, the steersman shall be supplied by the consignor with instructions in writing specifying concisely:

- (a) the nature of the danger presented by the dangerous goods carried and the safety measures that need to be taken to avert it;
- (b) the action to be taken and the treatment to be given in the event of any person coming into contact with the goods being carried or with any substances which might be expelled from them;
- (c) the measures to be taken in case of fire and the fire-extinguishing agents or groups of agents to be used or not to be used to fight the fire;
- (d) the measures to be taken in case of breakage or other deterioration of the packagings or of the dangerous goods being carried, in particular where such dangerous goods have spilled; and
- (e) the materials and protective special equipment if the protective special equipment referred to in marginal 10 260 (1) is not sufficient.

(2) These instructions in writing shall be supplied by the consignor and handed to the steersman before loading. The consignor is held responsible for the content of the instructions in writing. These instructions shall be drawn up in a language the steersman is able to read and understand and in at least each of the languages of the States concerned by the transport operation.

(3) The steersman shall bring these instructions to the attention of the persons on board to enable them to carry them out. They shall be kept readily at hand in the wheelhouse and clearly separated from those instructions which are not applicable.

10 386-
10 399

SECTION 4. Additional requirements concerning loading, carriage, unloading and other handling of the cargo

10 400

10 401 Limitation of the quantities carried

(1) The following gross masses shall not be exceeded on any vessel. No gross mass limitations apply to dangerous goods not mentioned in the table below.

Annex B.1 - Part I**10 401
(cont'd)**

Class	Item	Maximum permissible gross mass	
		In the case of one substance per vessel	
1		see marginal 11 401	
2	any classified under groups T, TF, TC, TO, TFC or TOC, total	60 000 kg	120 000 kg
	any classified under group F, total	120 000 kg	300 000 kg
3	1° to 5° and 21° to 26° with letter (a) or (b), total	120 000 kg	300 000 kg
	12°, 13°; 11° to 19°, 27°, 41° to 57° with letter (a) or (b), and 28°, 32° (c) and 33° (c), total	60 000 kg	120 000 kg
	however, maximum of 12° or 13°	15 000 kg	30 000 kg
	31° (c), total	300 000 kg	unlimited
4.1	7° and 16° (b), 21°, 22° and 25° (a), 26°, 33° to 40°, 44° and 46°, all substance of (b), total	60 000 kg	120 000 kg
4.2	7°, 8°, 18° and 19°, all substance of (b), total	120 000 kg	300 000 kg
4.3	15°, 18°, 22° and 23°, all substance of (a) or (b), total	120 000 kg	300 000 kg
5.2	1° (b), 2° (b), 11° (b), 12° (b), total	10 000 kg	15 000 kg
	other items, total	60 000 kg	120 000 kg
6.1	any without letter, total	15 000 kg	30 000 kg
	any with letter (a), total	60 000 kg	120 000 kg
	any with letter (b), total	120 000 kg	300 000 kg
7		see marginal 71 401	
8	any with letter (a) and 6°, 14°, 15°, total	120 000 kg	300 000 kg
	32°, 37°, 53°, 54°, total	300 000 kg	unlimited
9	any with letter (b), total	120 000 kg	300 000 kg

Annex B.1 - Part I

10 401 Example **(cont'd)**

120 000 kg of Class 3, 5° (a), 60 000 kg of Class 6.1, 11° (a) and 60 000 kg of Class 4.1, 33° (b), which is 240 000 kg of dangerous goods altogether, may be carried on any one vessel.

Where only one single dangerous substance, for example of Class 4.1, 33° (b) is carried on any one vessel, its mass shall not exceed 120 000 kg in the case of this example.

(2) The limitation, in accordance with (1) above, of the quantities of goods of Classes 2, 3, 4.1, 5.2, 6.1, 8 and 9 with the exception of 31° (b), 32° (b), 41° (b) and 42° (b) of Class 4.1 and 1° (b), 2° (b), 11° (b) and 12° (b) of Class 5.2, shall not apply to double-hull vessels complying with the additional rules for construction of Part III or Part IV.

10 402

10 403 Prohibition of mixed loading (holds)

(1) Goods of different classes shall be separated by a minimum horizontal distance of 3.00 m. They shall not be stowed one on top of the other.

(2) Irrespective of the quantity, dangerous goods for which marginal 10 500 prescribes marking of the vessel with two blue cones or blue lights, shall not be stowed in the same hold together with flammable goods for which marginal 10 500 prescribes marking with one blue cone or blue light.

(3) Goods of Class 3, 11° to 19°, 27°, 28°, 32° and 41° to 57° and Classes 6.1, 6.2, 7 and 9 shall not be stowed in the same hold together with foodstuffs, other articles of consumption or animal feeds.

10 404 Prohibition of mixed loading (containers, road vehicles)

(1) Marginal 10 403 shall not apply to packages stowed in containers or road vehicles in accordance with international regulations.

(2) Marginal 10 403 shall not apply to:

- closed containers with complete metal walls;
- road vehicles with closed body having complete metal walls.

(3) For containers other than those referred to in paragraphs (1) and (2) above the separation distance required by marginal 10 403 (1) may be reduced to 2.4 m (width of container).

10 405 Prohibition of mixed loading (seagoing vessels)

For seagoing vessels and inland waterway vessels, where the latter only carry containers, the prohibition of mixed loading shall be deemed to have been met if the stowage and segregation requirements of the IMDG Code have been complied with. Where stowage has been effected in accordance with the IMDG Code, a note to this effect shall be entered in the transport document.

10 406

10 407 Places of loading and unloading

Annex B.1 - Part I

The dangerous goods listed in marginal 10 500 shall be loaded or unloaded only at the places designated or approved for this purpose by the competent authority.

10 408

10 409 Cargo transfer operations

Partial or complete cargo transfer into another vessel without permission from the competent authority is prohibited outside a cargo transfer place approved for this purpose.

10 410

10 411 Stowage plan

(1) The steersman shall enter on a stowage plan the dangerous goods stowed in the individual holds or on deck. The goods shall be described as in the transport document (name of substance, class, item number, letter and, where applicable, identification number).

(2) Where the dangerous goods are transported in containers, the number of the container shall suffice. In this case, a list giving the identification numbers of all containers and a description of the goods contained therein (name of the goods, class, item number, where applicable the letter and, where available, the identification number) shall be annexed to the stowage plan.

10 412 Ventilation

(1) During loading or unloading of road vehicles into or from the holds of ro-ro-vessels, there shall be not less than five changes of air per hour based upon the total volume of the empty hold.

(2) On board vessels carrying dangerous goods only in containers placed in open holds, ventilators do not require to be incorporated but must be on board. Where damage is suspected, the holds shall be ventilated so as to reduce the concentration of gases given off by the cargo to less than 10% of the lower explosive limit or in the case of toxic gases to below any significant concentration.

(3) If tank-containers and road tank vehicles are carried in closed holds, such holds shall be permanently ventilated for ensuring five air changes per hour.

10 413 Measures to be taken before loading

The holds and cargo decks shall be cleaned prior to loading. The holds shall be ventilated.

10 414 Handling and stowage of the cargo

(1) The various components of the cargo shall be stowed such as to prevent them from shifting in relation to one another or to the vessel and such that no damage can be caused by other cargo.

(2) Dangerous goods shall be stowed at a distance of not less than 1 m from the accommodation, the engine rooms, the wheelhouse and any sources of heat.

10 414 When the accommodation or wheelhouse is situated above a hold, dangerous goods shall in

Annex B.1 - Part I

(cont'd) no case be stowed beneath such accommodation or wheelhouse.

(3) Nothing shall be stowed on top of fragile packages. However, fragile packages containing the same dangerous goods may be stowed one on top of the other, provided this does not present any risk of breakage of the receptacles they contain.

(4) Packages shall be protected against heat, sunlight and the effects of the weather. This provision does not apply to road vehicles, tank-containers and containers.

(5) The dangerous goods shall be stowed in the holds. However, dangerous goods packed or loaded in:

- containers having complete sprayproof walls;
- road vehicles having complete sprayproof walls;
- tank-containers; and
- road tank vehicles

may be carried on deck in the protected area.

(6) Packages containing goods of Classes 3, 4.1, 4.2, 5.1 or 8 may be stowed on deck in the protected area, provided they are contained in drums, containers with complete walls or road vehicles with complete walls. Goods of Class 2 may be stowed on deck in the protected area, provided they are contained in cylinders.

(7) Where goods, for which marginal 10 500 prescribes marking of the vessel with two blue cones or two blue lights, are stowed on deck, they shall be separated by not less than 2.00 m from the vessel's sides.

(8) For seagoing vessels, the stowage requirements set out in (1) to (7) above shall be deemed to have been met, if the relevant provisions of the IMDG Code and, in the case of carriage in bulk, those set out in sub-section 9.3 of the BC Code have been complied with.

10 415 Measures to be taken after unloading

After unloading the holds shall be inspected and cleaned if necessary. In the case of carriage in bulk, this requirement does not apply if the new cargo comprises the same goods as the previous cargo.

10 416 Measures to be taken during loading, carriage, unloading and handling

The filling or emptying of receptacles, road tank vehicles, IBCs or tank-containers on board the vessel is prohibited without special permission from the competent authority.

**10 417-
10 452**

10 453 Lighting

If loading or unloading is performed at night or in conditions of poor visibility, effective lighting shall be provided.

10 453 If provided from the deck, it shall be effected by properly secured electric lamps which shall be

Annex B.1 - Part I

(cont'd) positioned in such a way that they cannot be damaged.

Where these lamps are positioned on deck in the protected area, they shall be of a limited explosion risk type.

10 454-
10 474

10 475 Risk of sparking

All electrically continuous connections between the vessel and the shore as well as appliances used in the protected area shall be so designed that they do not present a source of ignition.

10 476 Synthetic ropes

During loading or unloading operations, the vessel may be moored by means of synthetic ropes only when steel cables are used to prevent the vessel from going adrift.

10 477-
10 499

SECTION 5. Additional requirements concerning the operation of vessels**10 500 Marking**

(1) Vessels carrying dangerous goods listed in the following table shall, in accordance with Chapter 3 of the European Code for Inland Waterways (CEVNI), display the marking prescribed. No marking is required for dangerous goods which are not listed below.

Empty uncleaned tank-containers and road tank-vehicles shall be regarded as being loaded to their maximum permissible capacity.

Class	Item Number	Gross mass	Cones/Lights ^{*/}
1	any except 1.4	> 60 kg	3
	1.4 except 1.4 S	> 500 kg	1
2	any classified under group T, TF, TC, TO, TFC or TOC	> 1 000 kg	2
	any classified under group F	> 3 000 kg	1
3	1° to 5°, any with letter (a) or (b), 6°, 7° (b)	> 3 000 kg	1
	27° and 28°	> 1 000 kg	2
	21° to 26°	> 3 000 kg	1
	11° to 19°, 32° (c) and 41°	> 1 000 kg	2
	5°, 31°, 33°, 34° and 61°, any with letter (c)	> 30 000 kg	1
4.1	7° and 16°, any with letter (b)	> 3 000 kg	2
	22° and 25°, any with letter (a)	> 1 000 kg	2

Annex B.1 - Part I**10 500
(cont'd)**

Class	Item Number	Gross mass	Cones/Lights <u>*/</u>
4.2	any with letter (b) except 7°, 8°, 18° and 19°	> 30 000 kg	1
	7°, 8°, 18° and 19°, any with letter (b)	> 3 000 kg	2
4.3	any except 15°, 18°, 22° and 23° with letter (a) or (b)	> 30 000 kg	1
	15°, 18°, 22° and 23°, any with letter (a) or (b)	> 3 000 kg	2
5.2	1° (b), 2° (b), 11° (b) and 12° (b)	> 60 kg	3
	other item numbers except 31°	> 1 000 kg	1
6.1	any without letter or with letter (a)	> 1 000 kg	2
	any with letter (b)	> 1 000 kg	2
7	schedules 5 to 13		2
8	any with letter (a) and 6°, 14° and 45° (b)2.	> 3 000 kg	2
	32° (b)2., 35° (b)2., 37°, 54°, 64° and 68°	> 30 000 kg	1
9	any with letter (b)	> 3 000 kg	2

*/ *The marking shall consist of:*

during the day: the given number of blue cones;

at night or in case of poor visibility: the given number of blue lights.

(2) For the transport of dangerous goods to and from seaports, for which transport documents have been prepared in accordance with the provisions of the IMDG Code, the marking of vessels may be derived from the danger labels on the containers, tank-containers or road vehicles, in accordance with the following table:

Annex B.1 - Part I

10 500 (cont'd)

Danger labels	Cones/Lights ^{*/}
	3
	1
	0
	0
	2

- *: indication of the appropriate compatibility group, except S
- ** : indication of the appropriate division
- xxxx: identification number of the substance and compatibility group.

The labels may bear a text.







^{*/} *The marking shall consist of:*

during the day: the given number of blue cones;

at night or in case of poor visibility: the given number of blue lights.

Annex B.1 - Part I

10 500
(cont'd)

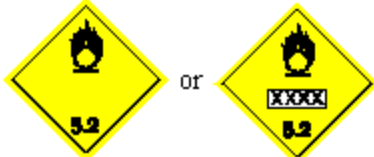
Danger labels	Cones/Lights*/
	1
	1
	0
	1
	1
	0
	1





*/ The marking shall consist of:

during the day: the given number of blue cones;

at night or in case of poor visibility: the given number of blue lights.

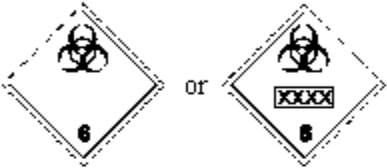
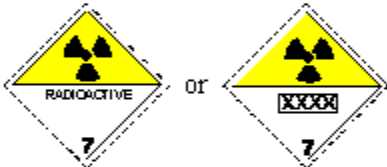
Annex B.1 - Part I

10 500
(cont'd)

Danger labels	Cones/Lights*/
	2
	0
	2
	2
	2
	2

*/ The marking shall consist of:
during the day: the given number of blue cones;
at night or in case of poor visibility: the given number of blue lights.

Annex B.1 - Part I

10 500 (cont'd) (3) Where more than one marking could apply to a vessel, only the marking which includes the greatest number of blue cones or blue lights shall apply, i.e. in the following order of precedence:

- three blue cones or three blue lights; or
- two blue cones or two blue lights; or
- one blue cone or one blue light.

(4) By derogation from paragraph (1), and in accordance with the footnotes to article 3.14 of the European Code for Inland Waterways (CEVNI), the competent authority of a Contracting Party may authorize seagoing vessels temporarily operating in an inland navigation area on the territory of this Contracting Party, the use of the day and night signals prescribed in the Recommendations on the Safe transport of Dangerous Cargoes and Related Activities in Port Areas adopted by the Maritime Safety Committee of the International Maritime Organization (by night and all-round fixed red light and by day flag "B" of the International Code of Signals), instead of the signals prescribed in paragraph (1). Contracting Parties which have taken the initiative with respect to the derogation granted shall notify the Executive Secretary of the United Nations Economic Commission for Europe, who shall bring this derogation to the attention of the Administrative Committee.

10 501 Mode of navigation

The competent authorities may impose restrictions on the inclusion of tank vessels in pushed convoys of large dimensions.

10 502

10 503 Mooring

Vessels shall be moored securely, but in such a way that they can be released quickly in an emergency.

10 504 Berthing

(1) The distances to be kept by vessels carrying dangerous goods at berth from other vessels shall be not less than the distance prescribed by the European Code for Inland Waterways.

(2) An expert in accordance with marginal 10 315 shall be permanently on board berthed vessels which are required to be marked according to marginal 10 500. The competent authority may, however, exempt from this obligation those vessels which are berthed in a harbour basin or in an accepted berthing position.

(3) Outside the berthing areas specifically designated by the competent authority, the distances to be kept by berthed vessels shall not be less than:

- 100 m from residential areas, civil engineering structures or storage tanks, if the vessel is required to be marked with one blue cone or one blue light in accordance with marginal 10 500;
- 100 m from civil engineering structures and storage tanks and
300 m from residential areas if the vessel is required to be marked with two blue cones or two blue lights in accordance with marginal 10 500;

Annex B.1 - Part I

10 504 - 500 m from residential areas, civil engineering structures and storage tanks if the
(cont'd) vessel is required to be marked with three blue cones or three blue lights
in accordance with marginal 10 500.

While waiting in front of locks or bridges, vessels are allowed to keep distances different from those given above. In no case shall the distance be less than 100 m.

(4) The competent authority may prescribe distances different from those given in (3) above, especially taking local conditions into account.

10 505-
10 507

10 508 Reporting duty

(1) In the States where the reporting duty is in force, the steersman of a vessel for which marking in accordance with marginal 10 500 is required shall, prior to the start of any voyage, report the following particulars to the competent authority of the State in which the voyage has started:

- name of the vessel;
- official number;
- dead-weight tonnage;
- description of the dangerous goods carried as given in the transport document (name of substance, class, item number and, where shown in the transport document, identification number) together with the quantity in each case;
- number of persons on board;
- port of destination; and
- planned shipping route.

This reporting duty shall apply in each state territory once to both passages upstream and downstream so far as the competent authorities so require. The information may be given orally (e.g. by radio-telephone, where appropriate by automatic wireless message service) or in writing.

(2) When passing the other traffic control stations designated by the competent authority, the following particulars shall be reported:

- name of the vessel;
- official number;
- dead-weight tonnage.

(3) Changes to any of the particulars referred to in (1) shall be reported to the competent authority without delay.

Annex B.1 - Part I

10 508 (4) The information is confidential and shall not be passed on to third parties by the
(cont'd) competent authority.

The competent authority may, however, in the event of an accident, inform the emergency services of the relevant particulars required for organizing emergency action.

10 509-
10 999

Part II

Special provisions concerning the carriage of dangerous goods of classes 1 to 9 supplementing or amending the provisions of part I

(RESERVED)

Annex B.1 - Part II

CLASS 1. EXPLOSIVE SUBSTANCES AND ARTICLES

General

11 000- *(Only the general provisions of Part I apply.)*
11 099

SECTION 1. Mode of carriage of goods

11 100- *(Only the general provisions of Part I apply.)*
11 199

SECTION 2. Requirements applicable to vessels

11 200- *(Only the general provisions of Part I apply.)*
11 299

SECTION 3. General service requirements

11 300-
11 350

11 351 Electrical installations

Electrical installations in the holds shall not be live.

11 352-
11 369

11 370 Aerials, lightning conductors, wire cables and masts

(1) No part of an aerial for electronic apparatus, no lightning conductor and no wire cable shall be situated above the holds.

(2) No part of aerials for radiotelephones shall be located within 2.00 m from goods of Class 1.

11 371-
11 399

SECTION 4. Additional requirements concerning loading, carriage, unloading and other handling of cargo

11 400
11 401

Limitation of quantities carried

(1) The maximum net mass of explosive substances, or, in the case of explosive articles, the maximum net mass of explosive substances contained in all the articles combined, which may be carried in any vessel shall be limited as indicated in the table below:

Annex B.1 - Part II**11 401
(cont'd)**

Class 1, division	Item number	Maximum net mass permissible	Remarks
1.1	01°	90 kg	In at least 3 batches of not more than 30 kg each, distance between batches not less than 10.00 m
1.1	1° to 12°	15 000 kg	In at least 3 batches of not more than 5 000 kg each; distance between batches not less than 10.00 m
1.2	13° to 25°	50 000 kg	
1.3	26° to 34°	300 000 kg	Not more than 100 000 kg in one hold */
1.4	35° to 47°	unlimited	
1.5	48°, 49°	15 000 kg	In at least 3 batches of not more than 5 000 kg each; distance between batches not less than 10.00 m
1.6	50°	300 000 kg	Not more than 100 000 kg in one hold */
	91°	unlimited	

*/ *A wooden bulkhead fitted for the purpose of subdividing a hold shall be acceptable.*

(2) Where substances and articles of different divisions of Class 1 are loaded in a single vessel in conformity with the provisions for prohibition of mixed loading of marginal 11 403, the entire load shall not exceed the smallest maximum net mass given in (1) above for the goods of the most dangerous division loaded, the order of precedence being 1.1, 1.5, 1.2, 1.3, 1.6, 1.4.

(3) Where the total net mass of the explosive substances and of the explosive substances contained in the article carried is not known, the table in (1) above shall apply to the gross mass of the cargo.

11 402**11 403 Prohibition of mixed loading (holds)**

(1) Substances and articles of Class 1 for which marginal 10 500 prescribes marking with three blue cones or three blue lights shall not be stowed in the same hold together with other dangerous goods.

When carried in adjacent holds they shall be separated by a distance of not less than 12.00 m.

(2) Substances and articles of Class 1 shall not be stowed in the same hold, except as indicated in the following table:

Annex B.1 - Part II**11 403
(cont'd)**

Compatibility group:	A	B	C	D	E	F	G	H	J	L	N	S
A	X	-	-	-	-	-	-	-	-	-	-	-
B	-	X	-	<u>1/</u>	-	-	-	-	-	-	-	X
C	-	-	X	X	X	-	X	-	-	-	<u>2/3/</u>	X
D	-	<u>1/</u>	X	X	X	-	X	-	-	-	<u>2/3/</u>	X
E	-	-	X	X	X	-	X	-	-	-	<u>2/3/</u>	X
F	-	-	-	-	-	X	-	-	-	-	-	X
G	-	-	X	X	X	-	X	-	-	-	-	X
H	-	-	-	-	-	-	-	X	-	-	-	X
J	-	-	-	-	-	-	-	-	X	-	-	X
L	-	-	-	-	-	-	-	-	-	<u>4/</u>	-	-
N	-	-	<u>2/3/</u>	<u>2/3/</u>	<u>2/3/</u>	-	-	-	-	-	<u>2/</u>	X
S	-	X	X	X	X	X	X	X	X	-	X	X

"X" indicates that explosive substances of corresponding compatibility groups in accordance with Annex A of ADR may be stowed in the same hold.

1/ Packages containing substances and articles assigned to compatibility groups B and D may be loaded together in the same hold provided that they are carried in containers or road vehicles with complete metal walls.

2/ Different categories of articles of Division 1.6, compatibility group N, may be carried together as articles of Division 1.6, compatibility group N, only when it is proven by testing or analogy that there is no additional risk of sympathetic detonation between the articles. Otherwise they should be treated as hazard Division 1.1.

3/ When articles of compatibility group N are carried with substances or articles of compatibility groups C, D or E, the articles of compatibility group N should be considered as having the characteristics of compatibility group D.

4/ Packages with substances and articles of compatibility group L may be stowed in the same hold with packages containing the same type of substances or articles of the same compatibility group.

**11 404-
11 406**

Annex B.1 - Part II

11 407 Places for loading and unloading

When goods of Class 1 are on board, no goods whatsoever shall be loaded or unloaded, except at the places designated or authorized for that purpose by the competent authority.

11 408 Time and duration of loading and unloading operations

(1) Loading and unloading operations shall not start without permission in writing from the competent authority. This provision also applies to loading or unloading of other goods when goods of Class 1 are on board. This permission is not required for goods of Division 1.4.

(2) The loading and unloading operations shall be suspended in the event of a thunderstorm.

11 409

11 410 Precautions with respect to foodstuffs, other articles of consumption and animal feeds

Goods of Class 1 with toxic properties shall not be stowed in the same hold together with foodstuffs, other articles of consumption and animal feeds.

**11 411-
11 412**

11 413 Measures to be taken before loading

No metallic part that is not an integral part of the vessel's structure shall protrude into the hold.

11 414 Handling and stowage of cargo

(1) Goods of Class 1 shall be stowed at a distance of not less than 3.00 m from the accommodation, engine rooms, the wheelhouse and from any sources of heat.

(2) Packages containing goods of Division 1.1 and packages containing goods of compatibility groups B and F of the other divisions shall be stowed at a distance of not less than 2.00 m from the sides of the vessel.

(3) Any friction, impact, jolting, overturning or dropping shall be prevented during handling of packages.

All packages loaded in the same hold shall be stowed and wedged as to prevent any jolting or friction during transport.

(4) Stacking of non-dangerous goods on top of packages containing substances or articles of Class 1 is prohibited.

(5) Substances and articles of Class 1 shall be loaded last and unloaded first.

Derogation from this provision is only permitted when the cargo is loaded, or unloaded, in more than one harbour and the substances and articles of Class 1 are not loaded in the last loading harbour or unloaded in the first unloading harbour.

**11 414
(cont'd)**

(6) Where substances or articles of Class 1 are loaded together with other goods into the same hold, the substances or articles of Class 1 shall be loaded after, and unloaded before, all

Annex B.1 - Part II

the other goods.

This provision does not apply if the substances or articles of Class 1 are contained in containers.

(7) While substances or articles of Class 1 are being loaded or unloaded, no loading or unloading operations shall take place in the other holds and no filling or emptying of fuel tanks shall be allowed. The competent authority may, however, permit exemptions from this provision.

(8) For seagoing vessels, the stowage requirements are deemed to be met if the provisions of the IMDG Code are complied with.

**11 415-
11 440**

11 441 Fire and naked light

The use of fire or naked light is prohibited while substances and articles of Divisions 1.1, 1.2, 1.3, 1.5 or 1.6 are on board and the holds are open or the goods to be loaded are located at a distance of less than 50 m from the vessel.

**11 442-
11 450**

11 451 Electrical equipment

The use of radiotelephone or radar transmitters is not permitted, while substances or articles of Divisions 1.1, 1.2, 1.3 1.5 or 1.6 are being loaded or unloaded.

This shall not apply to VHF-transmitters of the vessel, in cranes or in the vicinity of the vessel, provided the power of the VHF-transmitter does not exceed 25 W and no part of its aerial is located at a distance less than 2.00 m from the substances or articles mentioned above.

**11 452-
11 499**

SECTION 5. Additional requirements concerning the operation of vessels

11 500 General

The requirements of marginals 11 501 to 11 505 apply only to vessels carrying goods of Class 1 for which marginal 10 500 prescribes marking with three blue cones or three blue lights.

11 501 Mode of navigation

When the transport of goods of Class 1 is performed by vessels navigating in pushed convoys or side-by-side formations, the competent authority may impose restrictions on the dimensions of such convoys or formations. Nevertheless, the use of a motorized vessel giving temporary towing assistance is permitted.

11 502 Vessels under way

When under way, a vessel shall keep away from any other vessel not less than 50 m if possible.

**11 503-
11 504**

Annex B.1 - Part II

11 505 Stopping of vessels

If navigation of a vessel threatens to become dangerous owing either to:

- external factors (bad weather, unfavourable conditions of the waterway, etc.), or
- the condition of the vessel itself (accident or incident),

the vessel shall be stopped at a suitable berthing area as far away as possible from residential areas, harbours, civil engineering structures or storage tanks for gas or flammable liquids, regardless of the provisions set out in marginal 10 504.

The competent authority shall be notified without delay.

**11 506-
11 507**

11 508 Reporting duty

When transmitting the information referred to in marginal 10 508 (1), fourth indent, the gross mass of the packages containing substances and articles of Class 1 shall be declared in addition to the net mass of explosive substances and of explosive substances contained in the articles.

**11 509-
20 999**

Annex B.1 - Part II

CLASS 2. GASES

General

**21 000-
21 099** *(Only the general provisions of Part I apply.)*

SECTION 1. Mode of carriage of goods

**21 100-
21 199** *(Only the general provisions of Part I apply.)*

SECTION 2. Requirements applicable to vessels

**21 200-
21 259**

21 260 Special equipment

(1) When dangerous goods of Class 2 are carried on board the vessel, the protective equipment referred to in marginal 10 260 (1)(a) is required on board and shall be suitable for the goods carried.

(2) When dangerous goods of Class 2 are carried on board the vessel and marking is required in accordance with marginal 10 500, the escape devices referred to in marginal 10 260 (1) (b) are required on board and shall be kept available for immediate use.

(3) When dangerous goods of Class 2 are carried on board the vessel and marking is required in accordance with marginal 10 500, the flammable gas detector referred to in marginal 10 260 (1) (c) is required on board, together with instructions for its use.

(4) When dangerous goods of Class 2 are carried on board the vessel and marking with two blue cones or two blue lights is required in accordance with marginal 10 500, the toximeter referred to in marginal 10 260 (1)(d) is required on board, together with instructions for its use.

(5) When dangerous goods of Class 2 are carried on board the vessel and in accordance with paragraph (3) or paragraph (4) a flammable gas detector or a toximeter is required, the breathing apparatus referred to in marginal 10 260 (1) (e) is required on board.

**21 261-
21 299**

SECTION 3. General service requirements

21 300

21 301 Access to holds, double-hull spaces and double bottoms; inspections

(1) In case of suspected damage to packages, the gas concentration in the holds shall be measured by means of the device referred to in marginal 21 260 (3) or (4), before any person enters these holds.

Entry into holds is not permitted for the purpose of measuring.

21 301 (2) Entry into holds where damage is suspected as well as entry into double-hull spaces

Annex B.1 - Part II

(cont'd) and double bottoms is not permitted, except where:

- there is no lack of oxygen and no measurable amount of dangerous substances in a dangerous concentration, or
- the person entering the space wears a self-contained breathing apparatus and other necessary protective and rescue equipment and is secured by a line. Entry into these spaces is only permitted if this operation is supervised by a second person for whom the same equipment is readily at hand. Another two persons capable of giving assistance in an emergency shall be on the vessel within calling distance.

**21 302-
21 311**

21 312 Ventilation

The holds shall be ventilated. In the event of the carriage of dangerous goods in containers in open holds, ventilation is required only if damage to the container is suspected or if it is suspected that the contents have spilled inside the container.

**21 313-
21 399**

SECTION 4. Additional requirements concerning loading, carriage, unloading and other handling of cargo

**21 400-
21 402**

21 403 Prohibition of mixed loading (holds)

Goods of Class 2 shall not be stowed in the same hold together with goods of Classes 1, 4.1, or 5.2 for which marginal 10 500 prescribes marking with three blue cones or three blue lights.

**21 404-
21 411**

21 412 Ventilation

(1) Holds containing goods of Class 2 classified in group F under any item shall be ventilated with the ventilators operating at full power, where after measurement it has been established that the concentration of gases given off by the cargo exceeds 10% of the lower explosive limit.

(2) Holds containing substances of Class 2 listed in groups T, TF, TC, TO, TFC or TOC shall be ventilated with the ventilators operating at full power, where after measurement it has been established that the holds are not free of the gases given off by the cargo.

**21 412
(cont'd)**

(3) The measurement required in paragraphs (1) or (2) above shall be carried out immediately after loading. The measurement shall be repeated after one hour for monitoring

Annex B.1 - Part II

purposes. The results of the measurement shall be recorded in writing.

21 413-
21 499

SECTION 5. Additional requirements concerning the operation of vessels

21 500- (*Only the general provisions of Part I apply.*)
30 999

Annex B.1 - Part II

CLASS 3. FLAMMABLE LIQUIDS

General

**31 000-
31 099** *(Only the general provisions of Part I apply.)*

SECTION 1. Mode of carriage of goods

**31 100-
31 199** *(Only the general provisions of Part I apply.)*

SECTION 2. Requirements applicable to vessels

**31 200-
31 259** *(Only the general provisions of Part I apply.)*

31 260 Special equipment

(1) When dangerous goods of Class 3 are carried on board the vessel, the protective equipment referred to in marginal 10 260 (1) (a) is required on board and shall be suitable for the goods carried.

(2) When dangerous goods of Class 3 are carried on board the vessel and marking is required in accordance with marginal 10 500, the escape devices referred to in marginal 10 260 (1) (b) are required on board and shall be kept available for immediate use.

(3) When dangerous goods of Class 3 are carried on board the vessel and marking is required in accordance with marginal 10 500, the flammable gas detector referred to in marginal 10 260 (1) (c) is required on board, together with instructions for its use.

(4) When dangerous goods of Class 3 are carried on board the vessel and marking with two blue cones or two blue lights is required in accordance with marginal 10 500, the toximeter referred to in marginal 10 260 (1) (d) is required on board, together with instructions for its use.

(5) When dangerous goods of Class 3 are carried on board the vessel and a flammable gas detector or a toximeter is required in accordance with paragraphs (3) or (4), the breathing apparatus referred to in marginal 10 260 (1) (e) is required on board.

**31 261-
31 299**

SECTION 3. General service requirements

31 300

31 301 Access to holds, double-hull spaces and double bottoms; inspections

(1) In case of suspected damage to packages, the gas concentration in the holds shall be measured by means of the device referred to in marginal 31 260 (3) or (4) before any persons enter these holds.

Entry into holds is not permitted for the purpose of measuring.

31 301 (2) Entry into holds where damage is suspected as well as entry into double-wall spaces

Annex B.1 - Part II

(cont'd) and double bottoms is not permitted, except where:

- there is no lack of oxygen and no measurable amount of dangerous substances in a dangerous concentration, or
- the person entering the space wears a self-contained breathing apparatus and other necessary protective and rescue equipment and is secured by a line. Entry into these spaces is only permitted if this operation is supervised by a second person for whom the same equipment is readily at hand. Another two persons, capable of giving assistance in an emergency shall be on the vessel within calling distance.

**31 302-
31 311**

31 312 Ventilation

The holds shall be ventilated. When dangerous goods are carried in containers in open holds ventilation is required only if damage to the containers is suspected or if it is suspected that the contents have spilled inside the container.

**31 313-
31 399**

SECTION 4. Additional requirements concerning loading, carriage, unloading and other handling of cargo

**31 400-
31 402**

31 403 Prohibition of mixed loading (holds)

Goods of Class 3 shall not be stowed in the same hold together with goods of Classes 1, 4.1, or 5.2 for which marginal 10 500 prescribes marking with three blue cones or three blue lights.

**31 404-
31 409**

31 410 Precautions with respect to foodstuffs, other articles of consumption and animal feeds

Goods of Class 3, 11° to 19°, 27°, 28°, 32° and 41° shall not be stowed in the same hold together with foodstuffs, other articles of consumption and animal feeds.

31 411

31 412 Ventilation

(1) Holds containing substances of Class 3, 1° to 7° or 21° to 26° shall be ventilated with the ventilators operating at full power, where after measurement it has been established that the concentration of gases given off by the cargo exceeds 10% of the lower explosive limit.

**31 412
(cont'd)**

(2) Holds containing substances of Class 3, 11° to 19°, 27°, 28°, 32° or 41° shall be ventilated with the ventilators operating at full power, where after measurement it has been established that the holds are not free of gases given off by the cargo.

Annex B.1 - Part II

(3) The measurements required in paragraphs (1) or (2) above shall be carried out immediately following loading. The measurement shall be repeated after one hour for monitoring purposes. The results of the measurements shall be recorded in writing.

31 413-
31 499

SECTION 5. Additional requirements concerning the operation of vessels

31 500- (*Only the general provisions of Part I apply.*)
40 999

Annex B.1 - Part II

CLASS 4.1. FLAMMABLE SOLIDS

General

**41 000-
41 099** *(Only the general provisions of Part I apply.)*

SECTION 1. Mode of carriage of goods

**41 100-
41 110**

41 111 Carriage in bulk

Goods of Class 4.1, 4° (c), naphthalene of 6° (c), sulphur of 11° (c), and goods of Class 4.1, 52° (ADN) may be carried in bulk.

**41 112-
41 199**

SECTION 2. Requirements applicable to vessels

**41 200-
41 259**

41 260 Special equipment

(1) (Reserved).

(2) (Reserved).

(3) When goods of Class 4.1, 4° (c) or 52° (ADN), are carried in bulk or unpackaged on board the vessel, the flammable gas detector referred to in marginal 10 260 (1) (c) is required on board together with the instructions for its use.

(4) (Reserved).

(5) When dangerous goods of Class 4.1 are carried on board the vessel and a flammable gas detector is required in accordance with paragraph (3), the breathing apparatus referred to in marginal 10 260 (1) (e) is required on board.

**41 261-
41 299**

SECTION 3. General service requirements

41 300

41 301 Access to holds, double-hull spaces and double bottoms; inspections

(1) Before any person enters holds containing goods of Class 4.1, 4° (c) or 52° (ADN), in bulk or unpackaged, the gas concentration in these holds and in the adjacent holds shall be measured by means of the device referred to in marginal 41 260 (3).

41 301 Entry into holds is not permitted for the purpose of measuring.

Annex B.1 - Part II

(cont'd)

(2) Entry into holds containing goods of Class 4.1, 4° (c) or 52° (ADN), in bulk, as well as entry into double-hull spaces and double bottoms is not permitted, except where:

- there is no lack of oxygen and no measurable amount of dangerous substances in dangerous concentration; or
- the person entering the space wears a self-contained breathing apparatus and other necessary protective and rescue equipment and is secured by a line. Entry into the spaces is only permitted if this operation is supervised by a second person for whom the same equipment is readily at hand. Another two persons capable of giving assistance in an emergency shall be on the vessel within calling distance.

41 302-
41 310

41 311 Holds

The inner surfaces of holds intended for the carriage in bulk of naphthalene of Class 4.1, 6° (c) shall be coated or lined such that they are not readily flammable and not liable to impregnation by the cargo.

41 312 Ventilation

Holds containing goods of Class 4.1, 4° (c) or 52° (ADN) in bulk shall be ventilated.

41 313-
41 399

SECTION 4. Additional requirements concerning loading, carriage, unloading and other handling of cargo

41 400-
41 402

41 403 Prohibition of mixed loading (holds)

Goods of Class 4.1 for which marginal 10 500 prescribes marking with three blue cones or three blue lights shall not be stowed in the same hold together with dangerous goods of other classes.

41 404-
41 411

41 412 Ventilation

(1) Holds containing goods of Class 4.1, 4° (c) or 52° (ADN), shall be ventilated where after measurement it has been established that the concentration of gases given off by the cargo exceeds 10% of the lower explosive limit.

(2) The measurement required in (1) above shall be carried out immediately following loading. The measurement shall be repeated after one hour for monitoring purposes.

41 412
(cont'd)

The results of the measurements shall be recorded in writing.

Annex B.1 - Part II

41 413

41 414 Handling and stowage of cargo

- (1) Goods of Class 4.1, 4° (c) may be loaded in bulk in holds on ly if:
 - (a) these holds are separated from other spaces either by a watertight metal bulkhead or by another hold with metal bulkheads;
 - (b) it is ensured that no cargo can get under the ceiling.
- (2) For seagoing vessels, the stowage requirements in (1) above shall be deemed to have been met, if the stowage requirements set out in sub-section 9.3 of the BC Code have been complied with.

41 415

41 416 Measures to be taken during loading, carriage, unloading and handling

- (1) Before any person enters a hold containing goods of Class 4.1, 4° (c) and 52° (ADN) in bulk, and prior to unloading, the concentration of gases shall be measured by the consignee of the cargo.

The hold shall not be entered or unloading started until the concentration of gases in the airspace above the cargo is below 50% of the lower explosive limit.

- (2) After loading and unloading goods of Class 4.1, 4° (c) and 52° (ADN) in bulk and before leaving the cargo transfer site, the concentration of gases in the accommodation, engine rooms and adjacent holds shall be measured by the consignor or consignee using a flammable gas detector.

- (3) If significant concentrations of gases are found in the spaces referred to in (2) above, the necessary safety measures shall be taken immediately by the consignor or the consignee.

**41 417-
41 499**

SECTION 5. Additional requirements concerning the operation of vessels

41 500 General

The requirements of marginal 41 501 to 41 505 apply only to vessels carrying goods of Class 4.1 for which marginal 10 500 prescribes marking with three blue cones or three blue lights.

41 501 Mode of navigation

When the transport of dangerous goods of Class 4.1 is performed by vessels navigating in pushed convoys or side-by-side formations, the competent authority may impose restrictions on the dimensions of such convoys or formations. Nevertheless, the use of a motorized vessel giving temporary towing assistance is permitted.

41 502 Vessels under way

Annex B.1 - Part II

When under way, a vessel shall keep away from any other vessel not less than 50 m if possible.

**41 503-
41 504**

41 505 Stopping of vessels

If navigation of a vessel threatens to become dangerous owing either

- to external factors (bad weather, unfavourable conditions of the waterway, etc.),
or
- to the condition of the vessel itself (accident or incident),

the vessel shall be stopped at a suitable berthing area as far away as possible from residential areas, harbours, civil engineering structures or storage tanks for gas or flammable liquids, regardless of the provisions set out in marginal 10 504.

The competent authority shall be notified without delay.

**41 506-
41 999**

Annex B.1 - Part II

CLASS 4.2. SUBSTANCES LIABLE TO SPONTANEOUS COMBUSTION

General

**42 000-
42 099** *(Only the general provisions of Part I apply.)*

SECTION 1. Mode of carriage of goods

**42 100-
42 110**

42 111 Carriage in bulk

Goods of 2° (b), 2° (c) and 3° (c), ferrous metal borings, shavings, turnings or cuttings in spontaneously combustible form of 12° (c) and goods of 16° (c) of Class 4.2, may be carried in bulk.

**42 112-
42 199**

SECTION 2. Requirements applicable to vessels

**42 200-
42 259**

42 260 Special equipment

(1) (Reserved)

(2) (Reserved)

(3) When goods of Class 4.2 are carried in bulk or unpackaged on board the vessel and marking is required in accordance with marginal 10 500, the flammable gas detector referred to in marginal 10 260 (1) (c) is required on board together with instructions for its use.

(4) (Reserved)

(5) When dangerous goods of Class 4.2 are carried on board the vessel and a flammable gas detector is required in accordance with paragraph (3), the breathing apparatus referred to in marginal 10 260 (1) is required on board.

**42 261-
42 299**

SECTION 3. General service requirements

42 300

42 301 Access to holds, double-hull spaces and double bottoms; inspections

(1) Before any person enters holds containing goods of Class 4.2, 2° (c), in bulk, the gas concentration in these holds and in the adjacent holds shall be measured by means of the device referred to in marginal 42 260 (3).

Annex B.1 - Part II

42 301 Entry into holds is not permitted for the purpose of measuring.
(cont'd)

(2) Entry into holds containing goods of Class 4.2, 2° (c) or 12° (c), in bulk, as well as entry into double-hull spaces and double bottoms is not permitted, except where:

- there is no lack of oxygen and no measurable amount of dangerous substances in dangerous concentration; or
- the person entering the space wears a self-contained breathing apparatus and other necessary protective and rescue equipment and is secured by a line. Entry into the spaces is only permitted if this operation is supervised by a second person for whom the same equipment is readily at hand. Another two persons capable of giving assistance in an emergency shall be on the vessel within calling distance.

42 302-
42 311

42 312 **Ventilation**

Holds containing goods of Class 4.2, 2° (c), in bulk, shall be ventilated.

42 313-
42 399

SECTION 4. Additional requirements concerning loading, carriage, unloading and other handling of cargo

42 400-
42 402

42 403 **Prohibition of mixed loading (holds)**

Goods of Class 4.2 shall not be stowed in the same hold together with goods of Classes 1, 4.1, or 5.2 for which marginal 10 500 prescribes marking with three blue cones or three blue lights.

42 404-
42 411

42 412 **Ventilation**

(1) Holds containing goods of Class 4.2, 2° (c), in bulk, shall be ventilated where after measurement it has been established that the concentration of gases given off by the cargo exceeds 10% of the lower explosive limit.

(2) The measurement required in (1) above shall be carried out immediately following loading. Measurements shall be repeated after one hour then every eight hours for monitoring purposes. The results of the measurements shall be recorded in writing.

42 413 **Measures to be taken before loading**

Substances of Class 4.2, 12° (c) may be loaded only if their temperature is not above 55 °C.

42 414 **Handling and stowage of cargo**

Annex B.1 - Part II

Packages loaded on deck which are not stowed in road vehicles, tank-containers or containers, shall be covered with tarpaulins which will not readily ignite.

42 415

42 416 Measures to be taken during loading, carriage, unloading and handling

(1) Before any person enters a hold containing goods of Class 4.2, 2° (c), in bulk, and prior to unloading, the concentration of gases shall be measured by the consignee of the cargo.

The hold shall not be entered or unloading started until the concentration of gases in the airspace above the cargo is below 50% of the lower explosive limit.

(2) After loading and unloading goods of Class 4.2, 2° (c), in bulk, and before leaving the transshipment site, the concentration of gases in the accommodation, engine rooms and adjacent holds shall be measured by the consignor or consignee using a flammable gas detector.

(3) If significant concentrations of gases are found in the spaces referred to in (2) above, the necessary safety measures shall be taken immediately by the consignor or the consignee.

**42 417-
42 499**

SECTION 5. Additional requirements concerning the operation of vessels

**42 500-
42 999** *(Only the general provisions of Part I apply.)*

Annex B.1 - Part II

**CLASS 4.3. SUBSTANCES WHICH, IN CONTACT WITH WATER,
EMIT FLAMMABLE GASES**

General

**43 000-
43 099** *(Only the general provisions of Part I apply.)*

SECTION 1. Mode of carriage of goods

**43 100-
43 110**

43 111 Carriage in bulk

Aluminium silicon powder, uncoated, zinc ashes, aluminium smelting by-products and aluminium remelting by-products of 13° (c) and ferrosilicium of 15° (c) of Class 4.3 may be carried in bulk.

SECTION 2. Requirements applicable to vessels

**43 200-
43 259**

43 260 Special equipment

(1) When dangerous goods of Class 4.3 are carried in bulk or unpackaged on board the vessel, the protective equipment referred to in marginal 10 260 (1) (a) is required on board and shall be suitable for the goods carried.

(2) (Reserved)

(3) When dangerous goods of Class 4.3 are carried in bulk or unpackaged on the vessel and marking is required in accordance with marginal 10 500, the flammable gas detector referred to in marginal 10 260 (1) (c) is required on board, together with instructions for its use.

(4) When dangerous goods of Class 4.3 are carried in bulk or unpackaged on the vessel, the toximeter referred to in marginal 10 260 (1) (d) is required on board, together with instructions for its use.

(5) When dangerous goods of Class 4.3 are carried on board the vessel and a flammable gas detector or a toximeter is required in accordance with paragraphs (3) or (4) the breathing apparatus referred to in marginal 10 260 (1) (e) is required on board.

**43 261-
43 299**

SECTION 3. General service requirements

43 300

43 301 Access to holds, double-hull spaces and double bottoms; inspections

Annex B.1 - Part II

(1) Before any person enters holds containing goods of Class 4.3 in bulk or unpackaged, the gas concentration in those holds and in the adjacent holds shall be measured by means of the devices referred to in marginal 43 260 (3) or (4).

Entry into holds is not permitted for the purpose of measuring.

(2) Entry into holds containing goods of Class 4.3 in bulk or unpackaged as well as entry into double-hull spaces and double bottoms shall not be permitted except where:

- there is no lack of oxygen and no measurable amount of dangerous substances in a dangerous concentration; or
- the person entering the space wears a self-contained breathing apparatus and other necessary protective and rescue equipment and is secured by a line. Entry into these spaces is only permitted if this operation is supervised by a second person for whom the same equipment is readily at hand. Another two persons capable of giving assistance in an emergency shall be on the vessel within calling distance.

(3) If a hold contains goods of Class 4.3 in bulk or unpackaged, the gas concentration shall be measured in all other spaces of the vessel which are used by the crew at least once every 8 hours with the device mentioned in marginal 43 260 (4). The results of the measurements shall be recorded in writing.

(4) The steersman shall make sure every day by checking the bilge wells or pump ducts that no water has entered the bilges in the cargo area.

Water which has entered the bilges shall be removed immediately.

43 302-
43 311

43 312 Ventilation

(1) Holds containing goods of Class 4.3 in bulk or unpackaged shall be ventilated.

(2) Spaces adjacent to holds containing goods of Class 4.3 in bulk or unpackaged and accommodation shall be ventilated.

43 313-
43 399

SECTION 4. Additional requirements concerning loading, carriage, unloading and other handling of cargo

43 400-
43 402

43 403 Prohibition of mixed loading (holds)

Goods of Class 4.3 shall not be stowed in the same hold together with goods of Classes 1, 4.1, or 5.2 for which marginal 10 500 prescribes marking with three blue cones or three blue lights.

43 404-
43 409

Annex B.1 - Part II

43 410 Precautions with respect to foodstuffs, other articles of consumption and animal feeds

Goods of Class 4.3 carried in bulk or unpackaged shall not be stowed in the same hold together with foodstuffs, other articles of consumption and animal feeds.

43 411

43 412 Ventilation

(1) Holds containing goods of Class 4.3, in bulk or unpackaged, shall be ventilated with the ventilation equipment operating at full power, where after measurement it has been established that the concentration of gases given off by the cargo exceeds 10% of the lower explosive limit.

(2) The measurements required in (1) above shall be carried out immediately following loading. Measurements shall be repeated one hour then every eight hours to monitoring purposes. The results of the measurements shall be recorded in writing.

43 413 Measures to be taken before loading

Before loading goods of Class 4.3 in bulk or unpackaged, holds shall be made as dry as possible.

43 414 Handling and stowage of cargo

(1) It is prohibited to load or unload substances of Class 4.3 in bulk or unpackaged if there is a danger that they may get wet because of the prevailing weather conditions.

(2) Goods of Class 4.3 may be loaded in bulk or unpackaged only in holds which are separated from other spaces by a watertight metal bulkhead or by another hold with metal bulkheads.

(3) Packages shall be protected against moisture.

(4) No packages shall be stowed on top of packages containing goods of Class 4.3, unless they contain the same goods.

(5) If the packages are not contained in a container, they shall be placed on gratings and covered with water-proof tarpaulins arranged in such a way that the water drains off to the outside and the air circulation is not hindered.

(6) For seagoing vessels and inland waterway vessels, provided that the latter are only carrying containers, the stowage requirements shall be deemed to have been met, if the provisions of the IMDG Code and, for carriage in bulk, those sub-section 9.3 of the BC Code have been complied with.

43 415 Measures to be taken after unloading

(1) After unloading, holds which have contained goods of Class 4.3 in bulk or unpackaged, shall undergo forced ventilation.

43 415 (cont'd) After ventilation, the gas concentration in these holds shall be measured with the devices referred to in marginal 43 260 (3) or (4).

Entry into the holds is not permitted for the purpose of measuring.

Annex B.1 - Part II

(2) Holds which have contained goods of Class 4.3 in bulk or unpackaged shall be cleaned after unloading unless their next cargo is to be the same goods of Class 4.3 in bulk or unpackaged.

43 416-
43 499

SECTION 5. Additional requirements concerning the operation of vessels

43 500- (*Only the general provisions of Part I apply.*)
50 999

Annex B.1 - Part II

CLASS 5.1. OXIDIZING SUBSTANCES

General

**51 000-
51 099** *(Only the general provisions of Part I apply.)*

SECTION 1. Mode of carriage of goods

**51 100-
51 110**

51 111 Carriage in bulk

Ammonium nitrate fertilizers of Class 5.1, 21°(c) and solid substances of 22°(c) may be carried in bulk.

Ammonium nitrate fertilizers of 21°(c) shall have been stabilized in accordance with the requirements applicable to ammonium nitrate fertilizers set out in the BC Code. Stabilizing shall be certified by the consignor with an appropriate entry in the transport document.

In those States where this is required, ammonium nitrate fertilizers of 21°(c) may be carried in bulk only with the approval of the competent national authority.

**51 122-
51 199**

SECTION 2. Requirements applicable to vessels

**51 200-
51 299**

SECTION 3. General service requirements

51 300 *(Only the general provisions of Part I apply.)*

51 311 Holds

Any part of the holds and of the hatchway covers which may come into contact with goods of Class 5.1 shall consist of metal or of wood having a specific density of not less than 0.75 kg/dm³ (seasoned wood).

**51 312-
51 399**

SECTION 4. Additional requirements concerning loading, carriage, unloading and other handling of cargo

**51 400-
51 401**

51 402 Prohibition of mixed loading (general)

No other goods shall be loaded on vessels carrying goods of Class 5.1 in bulk.

Annex B.1 - Part II

51 403 Prohibition of mixed loading (holds)

Goods of Class 5.1 shall not be stowed in the same hold together with goods of Classes 1, 4.1, or 5.2 for which marginal 10 500 prescribes marking with three blue cones or three blue lights.

**51 404-
51 412**

51 413 Measures to be taken before loading

Any loose organic material shall be removed from the holds before loading goods of Class 5.1 in bulk.

**51 414-
51 499**

SECTION 5. Additional requirements concerning the operation of vessels

**51 500-
51 999** *(Only the general provisions of Part I apply.)*

Annex B.1 - Part II

CLASS 5.2. ORGANIC PEROXIDES

General

**52 000-
52 099** *(Only the general provisions of Part I apply.)*

SECTION 1. Mode of carriage of goods

**52 100-
52 199** *(Only the general provisions of Part I apply.)*

SECTION 2. Requirements applicable to vessels

**52 200-
52 259**

52 260 Special equipment

(1) (Reserved).

(2) (Reserved).

(3) When goods of Class 5.2 are carried on board the vessel and marking is required in accordance with marginal 10 500, the flammable gas detector referred to in marginal 10 260 (1) (c) is required on board together with the instructions for its use.

(4) (Reserved).

(5) When dangerous goods of Class 5.2 are carried on board the vessel and a flammable gas detector is required in accordance with paragraph (3), the breathing apparatus referred to in marginal 10 260 (1) (e) is required on board.

**52 261-
52 299**

SECTION 3. General service requirements

52 300

52 301 Access to holds, double-hull spaces and double-bottoms; inspections

(1) In case of suspected damage to packages, the gas concentration in the holds shall be measured by means of the device referred to in marginal 52 260 (3) before any persons enter these holds.

Entry into holds is not permitted for the purpose of measuring.

(2) Entry into holds where damage is suspected as well as entry into double-wall spaces and double bottoms is not permitted, except where:

- there is no lack of oxygen and no measurable amount of dangerous substances in a dangerous concentration, or

52 301 - the person entering the space wears a self-contained breathing apparatus and

Annex B.1 - Part II

(cont'd) other necessary protective and rescue equipment and is secured by a line. Entry into these spaces is only permitted if this operation is supervised by a second person for whom the same equipment is readily at hand. Another two persons, capable of giving assistance in an emergency shall be on the vessel within calling distance.

**52 302-
52 399**

SECTION 4. Additional requirements concerning loading, carriage, unloading and other handling of cargo

**52 400-
52 402**

52 403 Prohibition of mixed loading (holds)

Goods of Class 5.2 for which marginal 10 500 prescribes marking with three blue cones or three blue lights shall not be stowed in the same hold together with dangerous goods of other classes.

**52 404-
52 406**

52 407 Sites for loading and unloading

When substances of Class 5.2 are on board, no goods whatsoever shall be loaded or unloaded, except at the places designated or approved for this purpose by the competent authority.

52 408 Time and duration of loading or unloading operations

(1) Loading and unloading operations shall not be started without permission in writing from the competent authority.

(2) Loading and unloading operations shall be suspended in the event of a thunderstorm.

**52 409-
52 411**

52 412 Ventilation

(1) Holds containing goods of Class 5.2 shall be ventilated with the ventilators operating at full power, where after measurement it has been established that the concentration of gases given off by the cargo exceeds 10% of the lower explosive limit.

(2) It shall be established through measurements that the holds which contain goods of Class 5.2 are free from any significant concentration of gases which may have been given off by the cargo.

(3) The measurement required in (1) or (2) above shall be carried out immediately following loading. Measurements shall be repeated after one hour and then every eight hours for monitoring purposes. The results of the measurements shall be recorded in writing.

52 413

52 414 Handling and stowage of cargo

Annex B.1 - Part II

(1) Goods of Class 5.2, 1° (b), 2° (b), 11° (b) and 12° (b) shall be stowed on deck in the protected area. If the goods are not contained in road vehicles, tank-containers or containers, the packages shall be securely lashed and covered with tarpaulins that are not readily flammable and which allow efficient ventilation.

On deck, goods of Class 5.2 shall be stowed at a distance not less than 3 m from the accommodation, engine rooms, the wheelhouse and from any source of heat.

(2) Packages containing liquid organic peroxides shall be placed upright and secured in such a way that they cannot overturn or drop.

(3) No packages shall be stowed on top of packages containing goods of Class 5.2 unless they contain the same goods.

(4) For seagoing vessels, the stowage requirements other than those in (3) above, shall be deemed to have been met, if the stowage provisions of the IMDG Code have been complied with.

**52 415-
52 499**

SECTION 5. Additional requirements concerning the operation of vessels

52 500 General

The requirements of marginals 52 501 to 52 505 apply only to vessels carrying goods of Class 5.2 for which marginal 10 500 prescribes marking with three blue cones or three blue lights.

52 501 Mode of navigation

When the transport of dangerous goods of Class 5.2 is performed by vessels navigating in pushed convoys or side-by-side formations, the competent authority may impose restrictions on the dimensions of such convoys or formations. Nevertheless, the use of a motorized vessel giving temporary towing assistance is permitted.

52 502 Vessels under way

When under way, a vessel shall keep away from any other vessel not less than 50 m if possible.

**52 503-
52 504**

52 505 Stopping of vessels

If the navigation of a vessel threatens to become dangerous owing either to :

Annex B.1 - Part II

- external factors (bad weather, unfavourable conditions of the waterway, etc.), or
- circumstances involving the vessel itself (accident or incident),

the vessel shall be stopped in a suitable area as far away as possible from residential areas, harbours, civil engineering structures or storage tanks for gases or flammable liquids, regardless of the provisions of marginal 10 504.

The competent authority shall be notified without delay.

**52 506-
60 999**

Annex B.1 - Part II

CLASS 6.1. TOXIC SUBSTANCES

General

**61 000-
61 099** *(Only the general provisions of Part I apply.)*

SECTION 1. Mode of carriage of goods

**61 100-
61 110**

61 111 Carriage in bulk

Solid substances of Class 6.1, 63°(c) and solid wastes listed under (c) of the various items may be carried in bulk.

**61 112-
61 199**

SECTION 2. Requirements applicable to vessels

**61 200-
61 259**

61 260 Special equipment

(1) When dangerous goods of Class 6.1 are carried on board the vessel, the protective equipment referred to in marginal 10 260 (1)(a) is required on board and shall be suitable for the goods carried.

(2) When dangerous goods of Class 6.1 are carried on board the vessel and marking is required in accordance with marginal 10 500, the escape devices referred to in marginal 10 260 (1) (b) are required on board and shall be kept available for immediate use.

(3) When dangerous goods of Class 6.1 are carried on board the vessel and marking is required in accordance with marginal 10 500, the flammable gas detector referred to in marginal 10 260 (1) (c) is required on board, together with instructions for its use.

(4) When dangerous goods of Class 6.1 are carried on board the vessel and marking with two blue cones or two blue lights is required in accordance with marginal 10 500, the toximeter referred to in marginal 10 260 (1) (d) is required on board, together with instructions for its use.

(5) When dangerous goods of Class 6.1 are carried on board the vessel and a flammable gas detector or a toximeter is required in accordance with paragraphs (3) or (4), the breathing apparatus referred to in marginal 10 260 (1) (e) is required on board.

**61 261-
61 299**

Annex B.1 - Part II

SECTION 3. General service requirements

61 300

61 301 Access to holds, double-hull spaces and double bottoms; inspections

(1) In case of suspected damage to packages or where goods are being carried in bulk, the gas concentration in the holds and in the adjacent holds shall be measured by means of the devices referred to in marginal 61 260 (3) or (4), before any person enters these holds.

Entry into holds is not permitted for the purpose of measuring.

(2) Entry into holds where damage is suspected or where goods are carried in bulk as well as entry into double-hull spaces and double bottoms is not permitted except where:

- there is no lack of oxygen and no measurable amount of dangerous substances in a dangerous concentration; or
- the person entering the space wears a self-contained breathing apparatus and other necessary protective and rescue equipment and is secured by a line. Entry into these spaces is only permitted if this operation is supervised by a second person for whom the same equipment is readily at hand. Another two persons capable of giving assistance in an emergency shall be on the vessel within calling distance.

(3) If a hold contains goods of Class 6.1 in bulk the gas concentration in all other spaces of the vessel which are used by the crew shall be measured at least once every 8 hours by means of the device referred to in marginal 61 260 (4). The results of the measurement shall be recorded in writing.

61 302-

61 311

61 312 Ventilation

(1) The holds shall be ventilated. When dangerous goods are carried in containers in open holds ventilation is required only if damage to the containers is suspected or if it is suspected that the contents have spilled inside the container.

(2) Holds adjacent to holds containing goods of Class 6.1 in bulk and the accommodation shall be ventilated.

61 313-

61 399

Annex B.1 - Part II

SECTION 4. Additional requirements concerning loading, carriage, unloading and other handling of cargo

**61 400-
61 402**

61 403 Prohibition of mixed loading (holds)

Goods of Class 6.1 shall not be stowed in the same hold together with goods of Classes 1, 4.1, or 5.2 for which marginal 10 500 prescribes marking with three blue cones or three blue lights.

**61 404-
61 409**

61 410 Precautions with respect to foodstuffs, other articles of consumption and animal feeds

Goods of Class 6.1 shall not be stowed in the same hold together with foodstuffs, other articles of consumption and animal feeds.

61 411

61 412 Ventilation

(1) Holds containing goods of Class 6.1 in bulk shall be ventilated with the ventilators operating at full power.

(2) Holds containing goods of Class 6.1 listed under letters (a) or (b) of the item numbers shall be ventilated with the ventilators operating at full power, where after measurement it has been established that the holds are not free from gases given off by the cargo.

(3) The measurements required in paragraph (2) above shall be made immediately following loading. Measurements shall be repeated after one hour then every eight hours for monitoring purposes. The results of the measurements shall be recorded in writing.

61 413

61 414 Handling and stowage of cargo

(1) Goods of Class 6.1 may be loaded in bulk only in holds which are separated from other spaces either by a watertight metal bulkhead or by another hold with metal bulkheads.

(2) For seagoing vessels and inland waterway vessels, provided that the latter are only carrying containers, the stowage requirements shall be deemed to have been met, if the provisions of the IMDG Code and, for carriage in bulk, those of sub-section 9.3 of the BC Code have been complied with.

61 415 Measures to be taken after unloading

(1) After unloading, holds shall undergo forced ventilation.

After ventilation, the gas concentration in these holds shall be measured with the devices referred to in marginal 61 260 (3) and (4).

61 415 Entry into the holds is not permitted for the purpose of measuring.

Annex B.1 - Part II

(cont'd)

(2) Holds which have contained goods of Class 6.1 in bulk shall be cleaned after unloading, unless their next cargo is to be the same goods of Class 6.1 in bulk.

**61 416-
61 499**

SECTION 5. Additional requirements concerning the operation of vessels

**61 500-
61 599**

(Only the general provisions of Part I apply.)

Annex B.1 - Part II

CLASS 6.2. INFECTIOUS SUBSTANCES

General

**62 000-
62 099** *(Only the general provisions of Part I apply.)*

SECTION 1. Mode of carriage of goods

**62 100-
62 199** *(Only the general provisions of Part I apply.)*

SECTION 2. Requirements applicable to vessels

**62 200-
62 299** *(Only the general provisions of Part I apply.)*

SECTION 3. General service requirements

62 300 *(Only the general provisions of Part I apply.)*

SECTION 4. Additional requirements concerning loading, carriage, unloading and other handling of cargo

**62 400-
62 402**

62 403 Prohibition of mixed loading (holds)

Goods of Class 6.2 shall not be stowed in the same hold together with goods of Classes 1, 4.1, or 5.2 for which marginal 10 500 prescribes marking with three blue cones or three blue lights.

**62 404-
62 409**

62 410 Precautions with respect to foodstuffs, other articles of consumption and animal feeds

Goods of Class 6.2 shall not be stowed in the same hold together with foodstuffs, other articles of consumption and animal feeds.

**62 411-
62 499**

SECTION 5. Special requirements concerning the operation of vessels

**62 500-
70 999** *(Only the general provisions of Part I apply.)*

Annex B.1 - Part II

CLASS 7. RADIOACTIVE MATERIAL

General

**71 000-
71 001**

71 002 Instructions to carriers

(1) The consignor shall provide with the transport document information regarding action, if any, to be taken by the carrier. The information shall at least include the following particulars:

- (a) supplementary operational provisions for loading, stowage, transport, handling and unloading of the package, overpack, container or tank, including any special stowage provisions for the safe dissipation of heat or a statement that no such provisions are necessary;
- (b) any necessary routing instructions; and
- (c) instructions in writing on the action to be taken in the event of an accident.

(2) In all cases where approval of the shipment from, or prior notification to, the competent authorities is required, the carrier shall be informed accordingly 15 days in advance, if possible, and, in any case, not less than 5 days in advance, to enable him to take in good time any measures that are necessary for carriage.

(3) The consignor shall be in a position to provide the applicable competent authorities certificates to the carrier before loading, unloading and any transshipment.

**71 003-
71 099**

SECTION 1. Mode of carriage of goods

71 100 General provisions

For the transport of radioactive material additional national provisions, if any, shall be complied with.

71 101

71 102 Additional provisions

Where the total transport index of the consignment exceeds 0, a note to this effect shall be entered in the transport document.

71 103 Carriage in overpacks

Packages containing fissile material for which the transport index for nuclear criticality control exceeds 0 shall not be carried in an overpack.

**71 104-
71 110**

Annex B.1 - Part II

71 111 Carriage in bulk

(1) Low Specific Activity material of Class 7 (LSA-I, marginal 2704, schedule 5, of Annex A of ADR) may be carried in bulk provided that:

- (a) for materials other than natural ores, carriage is under exclusive use and there is no escape of contents out of the vessel and no loss of shielding under normal conditions of transport; or
- (b) for natural ores, carriage is under exclusive use.

(2) Surface Contaminated Objects (SCO-I) (marginal 2704, schedule 8 of Annex A of ADR) may be carried unpackaged, provided that:

- (a) they are carried in a vessel, road vehicle or container so that, under normal conditions of transport, there is no escape of contents or loss of shielding;
- (b) they are carried under exclusive use if the contamination on the accessible and inaccessible surfaces is greater than 4 Bq/cm² (10⁻⁴ µCi/cm²) for beta and gamma emitters and low toxicity alpha emitters or 0.4 Bq/cm² (10⁻⁵ µCi/cm²) for all other alpha emitters;
- (c) measures are taken to ensure that radioactive material is not released into the vessel, road vehicle or container, if it is suspected that non-fixed contamination exists on inaccessible surfaces of more than 4 Bq/cm² (10⁻⁴ µCi/cm²) for beta and gamma emitters and low toxicity alpha emitters or 0.4 Bq/cm² (10⁻⁵ µCi/cm²) for all other alpha emitters.

(3) Surface Contaminated Objects (SCO-II) (marginal 2704, schedule 8 of Annex A to ADR) shall not be carried unpackaged.

71 112 Special arrangement

For carriage under special arrangement (marginal 2704, schedule 13, of Annex A of ADR) the requirements specified by the competent authority shall be met.

SECTION 2. Requirements applicable to vessels

71 200 Construction

Vessels intended for the carriage of material of Class 7, marginal 2704, schedules 5 to 13 of Annex A of ADR shall comply with the additional rules for construction for double-hull vessels included in this Annex.

**71 201-
71 299**

SECTION 3. General service requirements

71 300 General requirements

Details are contained in the relevant schedules (see marginal 71 381 (3)).

71 301 Access to holds, double-hull spaces and double bottoms; inspections

Annex B.1 - Part II

The radiation level shall not exceed 0.02 mSv/h (2 mrem/h) at any normally occupied place on the vessel, unless the persons occupying such places are provided with personal monitoring devices.

**71 302-
71 380**

71 381 Documents

(1) In addition to the documents referred to in marginal 10 381, the consignor shall provide in the transport document information regarding actions, if any, to be taken by the steersman.

For details see marginal 71 002.

(2) In all cases where approval of the shipment from, or prior notification to, the competent authority is required, the carrier shall be informed accordingly by the consignor, if possible, 15 days in advance or in any case at least 5 days in advance, to enable him to take in good time any measures that are necessary for transport.

(3) The consignor shall provide the carrier before loading with all certificates from the competent authorities and the information required in accordance with marginals 2704 to 2713 of ADR.

**71 382-
71 399**

SECTION 4. Additional requirements concerning loading, carriage, unloading and other handling of cargo

71 400 General requirements

Details are contained in the relevant schedules (see marginal 71 381 (3)).

71 401 Limitation of quantities carried

(1) For the transport of radioactive material other than under exclusive use, the total transport index in a conveyance */ shall not exceed 50.

(2) For consignments under exclusive use, the total transport index for fissile material shall not exceed 100 for a conveyance */. For non-fissile material, there shall be no limit.

(3) Any package or overpack having a transport index in excess of 10 shall be carried only under exclusive use.

71 401 (cont'd) (4) For a conveyance */ carrying only Low Specific Activity (LSA-I) material (marginal 2704, schedule 5 of Annex A of ADR), there shall be no limit on the total transport index.

*/ See definition in marginal 10 014.

Annex B.1 - Part II

(5) For carriage of Surface Contaminated Objects (SCO-I and II) (marginal 2704, schedule 8 of Annex A of ADR) or Low Specific Activity (LSA-II and III) material (marginal 2704, schedules 6 and 7 of Annex A of ADR), the consignor shall indicate in the transport document the sum of the individual activities of the consignment in multiples of A_2 . For each separate consignment the activity in terms of A_2 values shall be added.

(6) For carriage of Low Specific Activity (LSA-II) material (marginal 2704, schedule 6 of Annex A of ADR) the total activity in a conveyance $\ast/$ shall not exceed the values specified in the table below.

Activity limits for LSA-II material	
Nature of contents	Limit for a conveyance $\ast/$
Non-combustible solids	100 x A_2
Combustible solids and all liquids and gases	10 x A_2

(7) For carriage of Low Specific Activity (LSA-III) material (marginal 2704, schedule 7 of Annex A of ADR), the total activity in a conveyance $\ast/$ shall not exceed the values specified in the table below.

Activity limits for LSA-III material	
Nature of contents	Limit for a conveyance $\ast/$
Non-combustible solids	100 x A_2
Combustible solids	10 x A_2

(8) For carriage of Surface Contaminated Objects (SCO-I and II) (marginal 2704, schedule 8 of Annex A of ADR), the total activity in a conveyance $\ast/$ shall not exceed 100 x A_2 .

71 402 Contamination on packages, overpacks, railway wagons, road vehicles, containers and vessels

Non-fixed contamination on all external surfaces and in addition on the internal surfaces of overpacks, railway wagons, road vehicles, containers and vessels used for transporting packages shall be kept as low as practicable and shall not exceed the following limits:

- (a) Beta and gamma emitters and low toxicity alpha emitters:
 0.4 Bq/cm² (10⁻⁵ μCi/cm²) for consignments which include excepted packages and/or non-radioactive goods;
 4 Bq/cm² (10⁻⁴ μCi/cm²) for all other consignments;

$\ast/$ See definition in marginal 10 014.

**71 402
(cont'd)**

- (b) All other alpha emitters:
 0.04 Bq/cm² (10⁻⁶ μCi/cm²) for consignments which include excepted packages and/or non-radioactive goods;

Annex B.1 - Part II

0.4 Bq/cm² (10⁻⁵ µCi/cm²) for all other consignments.

71 403 Prohibition of mixed loading (holds)

(1) Radioactive material of Class 7 shall not be stowed in the same hold together with goods of Classes 1, 4.1 or 5.2 for which marginal 10 500 prescribes marking with three blue cones or three blue lights.

(2) For the carriage of radioactive material in Type B(U) or Type B(M) packages (marginal 2704, schedules 10 and 11 of Annex A of ADR), the controls, restrictions or provisions specified in the competent authority approval certificate shall be complied with.

(3) For the carriage of radioactive material under special arrangement in accordance with marginal 2704, schedule 13 of Annex A of ADR, the special provisions specified by the competent authority shall be met. In particular, mixed loading shall not be permitted unless specifically authorized by the competent authority.

**71 404-
71 409**

71 410 Precautions with respect to foodstuffs, other articles of consumption and animal feeds

Radioactive material of Class 7 shall not be stowed in the same hold together with foodstuffs, other articles of consumption, and animal feeds, unless they are separated from them by a distance of not less than 6.00 m.

**71 411-
71 413**

71 414 Handling and stowage of cargo

(1) Packages, overpacks, containers and tanks loaded with dangerous goods of Class 7, marginal 2704, schedules 5 - 13 of Annex A of ADR shall be segregated during transport:

- (a) to limit radiation exposure of persons, from accommodation or regularly occupied working areas, if no protective material separates them and when the duration of exposure does not exceed 250 hours per year: by a distance of 15.00 metres. This distance may be reduced with the approval of the competent authorities. This segregation guarantees a radiation limit in such places of 1mSv annually, when the sum of the transport indices is not more than 50;
- (b) from other dangerous goods in accordance with marginal 71 403;
- (c) from packages bearing the word "FOTO" and from mailbags in accordance with the table below.

**71 414
(cont'd)**

NOTE: Mailbags shall be handled as if they contain undeveloped films and plates and therefore be separated from radioactive material in the same way as undeveloped films and plates.

Table: Minimum distance between packages of Category II-Yellow or of Category III-Yellow and packages bearing the word "FOTO" or mailbags

Annex B.1 - Part II

Total number of packages not more than:		Sum of transport indexes not more than:	Journey or storage duration, in hours							
			1	2	4	10	24	48	120	240
CATEGORY YELLOW		Minimum distance in metres								
III	II									
12345	1e+13	0.2	0.5	0.5	0.5	0.5	1	1	2	3
		0.5	0.5	0.5	0.5	1	1	2	3	5
	1	1	0.5	0.5	1	1	2	3	5	7
	2	2	0.5	1	1	1.5	3	4	7	9
	4	4	1	1	1.5	3	4	6	9	13
	8	8	1	1.5	2	4	6	8	13	18
1	10	10	1	2	3	4	7	9	14	20
2	20	20	1.5	3	4	6	9	13	20	30
3	30	30	2	3	5	7	11	16	25	35
4	40	40	3	4	5	8	13	18	30	40
5	50	50	3	4	6	9	14	20	32	45

(2) A package or overpack may, provided that its average surface heat flux does not exceed 15 W/m² and that the immediately surrounding cargo is not packed in bags, be carried together with other packaged goods without any special stowage requirements, except as may be specifically required by the competent authority in an applicable approval certificate.

(3) Except in the case of shipment under special arrangement, mixing of packages containing different kinds of radioactive material including fissile material, and mixing of different kinds of packages with different transport indexes is permitted without specific competent authority approval provided that the transport index limits are not exceeded. In the case of shipment under special arrangement, mixing is not permitted except as specifically authorized by the special arrangement.

(4) If the total transport index is greater than 50, the consignment shall be so handled and stowed that it is always separated from any other package, overpack, container or tank carrying radioactive material by at least 6.00 m. The intervening space between groups may be occupied by other goods, including dangerous goods according to ADN. The carriage of other goods together with consignments under exclusive use is permitted, provided that the provisions are made only by the consignor and it is not prohibited by other regulations.

71 415 Measures to be taken after unloading

(1) After unloading, the holds shall be inspected and, if necessary, cleaned by the consignee. This shall include decontamination in accordance with marginal 2702, paragraph 5 of Annex A of ADR or marginal 2703, paragraph 5 of Annex A of ADR, as appropriate. Vessels intended for the carriage under exclusive use of Low Specific Activity material (LSA-I, LSA-II and LSA-III) according to marginal 2704, schedules 5, 6 and 7 of Annex A of ADR and Surface Contaminated Objects (SCO-I and SCO-II) according to

Annex B.1 - Part II

71 415 (cont'd) marginal 2704, schedule 8 of Annex A of ADR shall be excepted from these provisions as long as they remain under such exclusive use.

(2) If it is evident that a package is damaged or leaking, or if it is suspected that the package may have leaked or been damaged, access to the package shall be restricted and a radiation protection expert shall, as soon as possible, assess the extent of contamination and the resultant radiation level. The scope of assessment shall include the package, the vessel, the adjacent loading and unloading areas and, if necessary, all other cargo which has been carried in the vessel. Where necessary, measures for the protection of human health in accordance with the provisions established by the relevant competent authority shall be taken in order to eliminate or minimize the effects of such leakage or damage.

(3) Packages leaking radioactive contents in excess of the limits acceptable under normal conditions of transport shall be removed under supervision and shall not be forwarded until they have been repaired or reconditioned and decontaminated.

(4) Vessels, equipment or parts thereof which have become contaminated shall be decontaminated, as soon as possible and in any case before reuse, to levels not exceeding:

- (a) for non-fixed contamination: see marginal 71 402;
- (b) for fixed contamination:

a surface radiation level of 5 μ Sv/h (0.5 mrem/h).

71 416

71 417 Additional provisions

(1) For consignments carried under exclusive use, the radiation level shall not exceed:

10 mSv/h (1,000 mrem/h) at any point on the external surface of any package or overpack; it may only exceed 2 mSv/h (200 mrem/h), provided that:

- there is an enclosure which prevents unauthorized access to the load during carriage;
- provisions are made to secure the package or overpack so that its position within the vessel remains fixed under normal conditions of carriage; and
- there are no loading or unloading operations in the hold in which the material is carried between the beginning and the end of the transport operation.

If the exclusive use conditions and the special additional provisions do not apply, the radiation level, at any point on any external surface of any package or overpack, shall not exceed 2 mSv/h (200 mrem/h) and the transport index shall not exceed 10.

71 418 Undeliverable consignments

If neither the consignor nor the consignee can be identified or if the consignment cannot be delivered to the consignee and the carrier has no instructions from the consignor, the consignment shall be placed in a safe location and the competent authority shall be informed as soon as possible and a request made for instructions on further action.

71 419-

Annex B.1 - Part II

71 428

71 429 Limitation of the effect of temperature

(1) If the temperature of the accessible outer surfaces of a Type B(U) or Type B(M) package could exceed 50 °C in the shade, carriage is permitted only under exclusive use. As far as practicable, the surface temperature shall be limited to 85 °C. Account may be taken of barriers or screens intended to give protection to transport workers without the barriers or screens being subject to any test.

(2) If the average heat flux from the external surfaces of a Type B(U) or B(M) package could exceed 15 W/m², the special stowage requirements specified in the competent authority package design approval certificate shall be met.

**71 430-
71 499**

SECTION 5. Additional requirements concerning the operation of vessels

71 500

71 501 Mode of navigation

When the transport of material of Class 7, marginal 2704, schedules 5-13 of Annex A of ADR is performed by vessels navigating in pushed convoys or side-by-side formations, the competent authority may impose restrictions on the dimensions of such convoys or formations. Nevertheless, the use of a motorized vessel giving temporary towing assistance is permitted.

**71 502-
79 999**

Annex B.1 - Part II

CLASS 8. CORROSIVE SUBSTANCES

General

**80 000-
80 099** *(Only the general provisions of Part I apply.)*

SECTION 1. Mode of carriage of goods

**81 100-
81 110**

81 111 Carriage in bulk

Solid substances of Class 8, 13° (b), empty packagings of Class 8, 91° and solid wastes listed under (c) of the various items may be carried in bulk.

**81 112-
81 199**

SECTION 2. Requirements applicable to vessels

**81 200-
81 259**

81 260 Special equipment

(1) When dangerous goods of Class 8 are carried on board the vessel, the protective equipment referred to in marginal 10 260 (1) (a) is required on board and shall be suitable for the goods carried.

(2) When dangerous goods of Class 8 are carried on board the vessel and marking is required in accordance with marginal 10 500, the escape devices referred to in marginal 10 260 (1) (b) is required on board and shall be kept available for immediate use.

(3) When dangerous goods of Class 8 are carried on board the vessel and marking is required in accordance with marginal 10 500, the flammable gas detector referred to in marginal 10 260 (1) (c) is required on board, together with instructions for its use.

(4) When dangerous goods of Class 8 are carried on board the vessel and marking with two blue cones or two blue lights is required in accordance with marginal 10 500, the toximeter referred to in marginal 10 260 (1) (d) is required on board, together with instructions for its use.

(5) When dangerous goods of Class 8 are carried on board the vessel and a flammable gas detector or a toximeter is required in accordance with paragraphs (3) or (4), the breathing apparatus referred to in marginal 10 260 (1) (e) is required on board.

**81 261-
81 299**

Annex B.1 - Part II

SECTION 3. General service requirements

81 300

81 301 Access to holds, double-hull spaces and double bottoms; inspections

(1) In case of suspected damage to packages the gas concentration in the holds shall be measured by means of the devices referred to in marginal 81 260 (3) or (4) before any person enters these holds.

Entry into holds is not permitted for the purpose of measuring.

(2) Entry into holds where damage is suspected as well as entry into double-hull spaces and double bottoms is not permitted, except where:

- there is no lack of oxygen and no measurable amount of dangerous substances in a harmful concentration; or
- the person entering the space wears a self-contained breathing apparatus and other necessary protective and rescue equipment and is secured by a line. Entry into these spaces is only permitted if this operation is supervised by a second person for whom the same equipment is readily at hand. Another two persons capable of giving assistance in an emergency shall be on the vessel within calling distance.

**81 302-
81 310**

81 311 Holds

The inner surfaces of holds intended for the carriage in bulk of solid substances of Class 8, 13° (b), empty packagings of Class 8, 91° and solid wastes listed under (c) of the various items shall be lined or coated so as to prevent corrosion.

**81 312-
81 399**

SECTION 4. Additional requirements concerning loading, carriage, unloading and other handling of cargo

**81 400-
81 402**

81 403 Prohibition of mixed loading (holds)

Goods of Class 8 shall not be stowed in the same hold together with goods of Classes 1, 4.1 or 5.2 in vessels for which marginal 10 500 prescribes marking with three blue cones or three blue lights.

**81 404-
81 414**

Annex B.1 - Part II

81 415 Measures to be taken after unloading

Holds which have contained goods of Class 8 in bulk shall be cleaned after unloading, unless their next cargo is to be the same goods of Class 8 in bulk.

**81 416-
81 499**

SECTION 5. Additional requirements concerning the operation of vessels

**81 500-
90 999** (*Only the general provisions of Part I apply.*)

Annex B.1 - Part II

**CLASS 9. MISCELLANEOUS DANGEROUS SUBSTANCES
AND ARTICLES**

General

**91 000-
91 094** *(Only the general provisions of Part I apply.)*

SECTION 1. Mode of carriage of goods

**91 100-
91 110**

91 111 Carriage in bulk

(1) Expandable polymeric beads of Class 9, 4° (c), castor beans of 35° (b), stabilized fishmeal and stabilized fishscrap of 39° (c) may be carried in bulk. Castor meal, castor pomace or castor flake shall not be carried in bulk.

(2) Ammonium nitrate fertilizers of Class 9, 50° (c) may be carried in bulk if, as the result of testing in the trough test according to section 38.2 of the Recommendations on the Transport of Dangerous Goods, Manual of Tests and Criteria, or Appendix D.4 of the BC Code, shows that the self-sustaining decomposition rate is not greater than 25 cm/h.

In those States where this is required, ammonium nitrate fertilizers of 50° (c) may be carried in bulk only with the approval of the competent national authority.

**91 112-
91 199**

SECTION 2. Requirements applicable to vessels

**91 200-
91 259** *(Only the general provisions of Part I apply.)*

91 260 Special equipment

(1) (Reserved).

(2) (Reserved).

(3) When expandable of polymeric beads of Class 9, 4° (c), are carried in bulk or unpackaged on board the vessel, the flammable gas detector referred to in marginal 10 260 (1) (c) is required on board together with the instructions for its use.

(4) (Reserved).

(5) When dangerous goods of Class 9 are carried on board the vessel and a flammable gas detector is required in accordance with paragraph (3), the breathing apparatus referred to in marginal 10 260 (1) (e) is required on board.

**91 261-
91 299**

Annex B.1 - Part II

SECTION 3. General service requirements

91 300

91 301 Access to holds, double-hull spaces and double bottoms; inspections

(1) Before any person enters holds containing expandable polymeric beads of Class 9, 4° (c), in bulk or unpackaged, the gas concentration in those holds and in the adjacent holds shall be measured by means of the devices referred to in marginal 91 260 (3).

Entry into holds is not permitted for the purpose of measuring.

(2) Entry into holds containing expandable polymeric beads of Class 9, 4° (c) in bulk or unpackaged as well as entry into double-hull spaces and double bottoms shall not be permitted except where:

- there is no lack of oxygen and no measurable amount of dangerous substances in a dangerous concentration; or
- the person entering the space wears a self-contained breathing apparatus and other necessary protective and rescue equipment and is secured by a line. Entry into these spaces is only permitted if this operation is supervised by a second person for whom the same equipment is readily at hand. Another two persons capable of giving assistance in an emergency shall be on the vessel within calling distance.

(3) If a hold contains polymeric beads, expandable of Class 9, 4° (c), in bulk or unpackaged, the gas concentration shall be measured in all other spaces of the vessel which are used by the crew at least once every 8 hours with the device mentioned in marginal 91 260 (3). The results of the measurements shall be recorded in writing.

(4) The steersman shall make sure everyday by checking the bilge wells or pump ducts that no water has entered the bilges in the cargo area.

Water which has entered the bilges shall be removed immediately.

**91 302-
91 311**

91 312 Ventilation

Holds containing expandable polymeric beads of Class 9, 4° (c), in bulk, shall be ventilated.

**91 313-
91 384**

91 385 Instructions in writing

For the carriage of substances of Class 9, 2° (b) or appliances of Class 9, 3°, the instructions in writing shall include a warning that highly toxic dioxins may develop if they are involved in a fire.

91 386-

Annex B.1 - Part II

91 399

SECTION 4. Additional requirements concerning loading, carriage, unloading and other handling of cargo

91 400-

91 402

91 403 Prohibition of mixed loading (holds)

(1) Goods of Class 9 in packages bearing a label conforming to model No. 9 (ADR) shall not be loaded in the same hold together with goods of Classes 1, 4.1 or 5.2 for which marginal 10 500 prescribes marking with 3 blue cones or 3 blue lights.

(2) Ammonium nitrate fertilizers of Class 9, 50° (c), shall not be loaded in the same hold together with flammable substances.

91 404-

91 409

91 410 Precautions with respect to foodstuffs, other articles of consumption and animal feeds

Goods of Class 9 shall not be stowed in the same hold together with foodstuffs, other articles of consumption or animal feeds.

91 411

91 412 Ventilation

(1) Holds containing expandable polymeric beads of Class 9, 4° (c), in bulk, shall be ventilated where after measurement it has been established that the concentration of gases given off by the cargo exceeds 10% of the lower explosive limit.

(2) The measurement required in (1) above shall be carried out immediately following loading. Measurements shall be repeated after one hour then every eight hours for monitoring purposes. The results of the measurements shall be recorded in writing.

91 413

91 414 Handling and stowage of cargo

(1) Expandable polymeric beads of Class 9, 4° (c), in bulk, may be loaded in holds only if:

- (a) these holds are separated from other spaces either by a watertight metal bulkhead or by another hold with metal bulkheads;
- (b) it is ensured that no cargo can get under the ceiling.

(2) For seagoing vessels, the stowage requirements in (1) above shall be deemed to have been met, if the stowage requirements set out in sub-section 9.3 of the BC Code have been complied with.

91 415 Measures to be taken after unloading

If goods of Class 9 have been spilled or have contaminated a hold, it may not be re-used until

Annex B.1 - Part II

after it has been thoroughly cleaned and, if necessary, decontaminated. All other goods which have been carried in the same hold shall be checked for possible contamination.

91 416 Measures to be taken during loading, carriage, unloading and handling

(1) Before any person enters a hold containing expandable polymeric beads of Class 9, 4° (c) and prior to unloading, the concentration of gases shall be measured by the consignee of the cargo.

The hold shall not be entered or unloading started until the concentration of gases in the airspace above the cargo is below 50% of the lower explosive limit.

(2) After loading and unloading expandable polymeric beads of Class 9, 4° (c) and before leaving the transshipment site, the concentration of gases in the accommodation, engine rooms and adjacent holds shall be measured by the consignor or consignee using a flammable gas detector.

(3) If significant concentrations of gases are found in the spaces referred to in (2) above, the necessary safety measures shall be taken immediately by the consignor or the consignee.

**91 417-
91 499**

SECTION 5. Additional requirements concerning the operation of vessels

**91 500-
109 999** (*Only the general provisions of Part I apply.*)

(RESERVED)

Part III

Rules for construction

(RESERVED)

Annex B.1 - Part III

**110 100-
110 199**

110 200 Materials of construction

The vessel's hull shall be constructed of shipbuilding steel or other metal, provided that this metal has at least equivalent mechanical properties and resistance to the effects of temperature and fire.

**110 201-
110 210**

110 211 Holds

- (1) (a) Each hold shall be bounded fore and aft by watertight metal bulkheads.
- (b) The holds shall have no common bulkhead with the oil fuel tanks.
- (2) The bottom of the holds shall be such as to permit them to be cleaned and dried.
- (3) The hatchway covers shall be spraytight and weathertight or be covered by waterproof tarpaulins.

Tarpaulins used to cover the holds shall not readily ignite.

- (4) No heating appliances shall be installed in the holds.

110 212 Ventilation

(1) Ventilation of each hold shall be provided by means of two mutually independent extraction ventilators having a capacity of not less than 5 changes of air per hour based on the volume of the empty hold. The ventilator fan shall be designed so that no sparks may be emitted on contact of the impeller blades with the housing and no static electricity may be generated. The extraction ducts shall be positioned at the extreme ends of the hold and extend down to not more than 50 mm above the bottom. The extraction of gases and vapours through the duct shall also be ensured for carriage in bulk.

Ventilators are not required on vessels only carrying dangerous goods packed in containers. If the extraction ducts are movable they shall be suitable for the ventilator assembly and capable of being firmly fixed. Protection shall be ensured against bad weather and spray. The air intake shall be ensured during ventilation.

- (2) The ventilation system of a hold shall be arranged so that dangerous gases cannot penetrate into the accommodation, wheelhouse or engine rooms.
- (3) Ventilation shall be provided for the accommodation and for service spaces.

**110 213-
110 216**

Annex B.1 - Part III

110 217 Accommodation and service spaces

- (1) The accommodation shall be separated from the holds by metal bulkheads having no openings.
- (2) Gastight closing appliances shall be provided for openings in the accommodation and wheelhouse facing the holds.
- (3) No entrances or openings of the engine rooms and service spaces shall face the protected area.

**110 218-
110 219**

110 220 Water ballast

The double-hull spaces and double bottoms may be arranged for being filled with water ballast.

**110 221-
110 230**

110 231 Engines

- (1) Only internal combustion engines running on fuel having a flashpoint above 55 °C are allowed.
- (2) The air vents in the engine rooms and the air intakes of the engines which do not take air in directly from the engine room shall be located not less than 2.00 m from the protected area.
- (3) Sparking shall not be possible in the protected area.

110 232 Oil fuel tanks

- (1) Double bottoms within the hold area may be arranged as oil fuel tanks provided their depth is not less than 0.6 m. Oil fuel pipes and openings to such tanks are not permitted in the holds.
- (2) The air pipes of all oil fuel tanks shall be led to 0.50 m above the open deck. Their open ends and the open ends of the overflow pipes leading to the deck shall be fitted with a protective device consisting of a gauze grid or by a perforated plate.

110 233

110 234 Exhaust pipes

- (1) Exhausts shall be evacuated from the vessel into the open-air either upwards through an exhaust pipe or through the shell plating. The exhaust outlet shall be located not less than 2.00 m from the hatchway openings. The exhaust pipes of engines shall be arranged so that the exhausts are led away from the vessel. The exhaust pipes shall not be located within the protected area.

- (2) Exhaust pipes shall be provided with a device preventing the escape of sparks, e.g.

Annex B.1 - Part III

(cont'd) spark arresters.

110 235 Stripping installation

The stripping pumps intended for the holds shall be located in the protected area. This requirement shall not apply when stripping is effected by eductors.

110 236-
110 239

110 240 Fire-extinguishing arrangements

(1) A fire-extinguishing system shall be installed on the vessel. This system shall comply with the following requirements:

- It shall be supplied by two independent fire or ballast pumps one of which shall be ready for use at any time. These pumps shall not be installed in the same space;
- It shall be provided with a water main fitted with at least three hydrants in the protected area above deck. Three suitable and sufficiently long hoses with spray nozzles having a diameter of not less than 12 mm shall be provided. It shall be possible to reach any point of the deck in the protected area simultaneously with at least two jets of water which do not emanate from the same hydrant. A spring-loaded non-return valve shall be fitted to ensure that no gases can escape through the fire-extinguishing system into the accommodation or service spaces outside the protected area;
- The capacity of the system shall be at least sufficient for a jet of water to reach a distance of not less than the vessel's breadth from any location on board with two spray nozzles being used at the same time.

A single fire or ballast pump shall suffice on board pushed barges without their own means of propulsion.

(2) The engine rooms shall be provided with a fixed fire extinguishing system which can be operated from the deck.

(3) The two hand fire-extinguishers referred to in marginal 10 240 shall be located in the protected area.

110 241 Fire and naked light

(1) The outlets of funnels shall be located not less than 2 m from the hatchway openings. Arrangements shall be provided to prevent the escape of sparks and the entry of water.

(2) Heating, cooking and refrigerating appliances shall not be fuelled with liquid fuels, liquid gas or solid fuels. The installation in the engine room or other separate space of heating appliances fuelled with liquid fuel having a flashpoint above 55 °C is, however, permitted.

Cooking and refrigerating appliances are permitted only in wheelhouses with metal floor and in the accommodation.

110 241 (3) Electric lighting appliances only are permitted outside the accommodation and (cont'd) the wheelhouse on in its vicinity.

Annex B.1 - Part III

**110 242-
110 251**

110 252 Type and location of electrical equipment

(1) It shall be possible to isolate the electrical equipment in the protected area by means of centrally located switches except where:

- the equipment in the holds is of a certified safe type corresponding at least to temperature class T4 and explosion group II B; and
- the equipment in the protected area is of the limited explosion risk type.

The corresponding electrical circuits shall have control lamps to indicate whether or not the circuits are live.

The switches shall be protected against unintended unauthorized operation. The sockets used in this area shall be so designed as to prevent connections being made except when they are not live.

(2) Electric motors for hold ventilators which are arranged in the air flow shall be of the "certified safe" type.

(3) Sockets for the connection of signal lights, gangway lighting and containers shall be fitted to the vessel close to the signal mast or the gangway or the containers. Sockets intended to supply the submerged pumps and hold ventilators shall be permanently fitted to the vessel in the vicinity of the hatches.

**110 253-
110 255**

110 256 Electric cables

(1) Cables and sockets in the protected area shall be protected against mechanical damage.

(2) Movable cables are prohibited in the protected area, except for intrinsically safe electric circuits or for the supply of signal lights and gangway lighting, for containers, for submerged pumps, hold ventilators and for electrically operated covergantries.

(3) For movable cables permitted in accordance with (2) above, only rubber-sheathed cables of type H07 RN-F in accordance with IEC 66 or cables of at least equivalent design having conductors with a cross-section of not less than 1.5 mm², shall be used. These cables shall be as short as possible and installed so that accidental damage is not likely to occur.

**110 257-
110 269**

110 270 Metal wires, masts

All metal wires passing over the holds and all masts shall be earthed, unless they are

Annex B.1 - Part III

electrically bonded to the metal hull of the vessel through their installation.

110 271 Admittance on board

The notice boards displaying the prohibition of admittance in accordance with marginal 10 371 shall be clearly legible from either side of the vessel.

110 272

110 273

110 274 Prohibition of smoking, fire and naked light

(1) The notice boards displaying the prohibition of smoking in accordance with marginal 10 374 shall be clearly legible from either side of the vessel.

(2) Notice boards indicating the circumstances under which the prohibition applies shall be fitted near the entrances to the spaces where smoking or the use of fire or naked light is not always prohibited.

(3) Ashtrays shall be provided close to each exit of the accommodation and the wheelhouse.

110 275-

110 279

Additional rules applicable to double-hull vessels

110 280-

110 287

110 288 Classification

(1) Double-hull vessels intended to carry dangerous goods of Classes 2, 3, 4.1, 5.2, 6.1, 8 or 9 except those of 31° (b), 32° (b), 41° (b) and 42° (b) of Class 4.1 and of 1° (b), 2° (b), 11° (b) and 12° (b) of Class 5.2, in quantities exceeding those referred to in marginal 10 401 (1) or material of Class 7 marginal 2704, Schedules 5 to 13 of Annex A to ADR, shall be built or transformed under survey of a recognized classification society in accordance with the rules established by this classification society to its highest class. This shall be confirmed by the classification society by the issue of an appropriate certificate.

(2) Continuation of class is not required.

(3) Future conversions and major repairs to the hull shall be carried out under survey of this classification society.

110 289-

110 290

110 291 Holds

(1) The vessel shall be built as a double-hull vessel with double-hull spaces and double bottom within the protected area.

Annex B.1 - Part III

(2) The distance between the sides of the vessel and the longitudinal bulkheads of the hold shall be not less than 0.80 m. Regardless of the requirements relating to the width of walkways on deck, a reduction of this distance to 0.60 m is permitted, provided that, compared with the scantlings specified in the rules for construction published by a recognized classification society, the following reinforcements have been made:

- (a) Where the vessel's sides are constructed according to the longitudinal framing system, the frame spacing shall not exceed 0.60 m.

The longitudinals shall be supported by web frames with lightening holes similar to the floors in the double bottom and spaced not more than 1.80 m apart;

- (b) Where the vessel's sides are constructed according to the transverse framing system, either:

- two longitudinal side shell stringers shall be fitted. The distance between the two stringers and between the uppermost stringer and the gangboard shall not exceed 0.80 m. The depth of the stringers shall be at least equal to that of the transverse frames and the cross-section of the face plate shall be not less than 15 cm².

The longitudinal stringers shall be supported by web frames with lightening holes similar to plate floors in the double bottom and spaced not more than 3.60 m apart. The transverse shell frames and the hold bulkhead vertical stiffeners shall be connected at the bilge by a bracket plate with a height of not less than 0.90 m and thickness equal to the thickness of the floors;

or:

- web frames with lightening holes similar to the double bottom plate floors shall be arranged on each transverse frame;

- (c) the gangboards shall be supported by transverse bulkheads or cross-ties spaced not more than 32 m apart.

As an alternative to compliance with the requirements of (c) above, a proof by calculation, issued by a recognized classification society confirming that additional reinforcements have been fitted in the double-hull spaces and that the vessel's transverse strength may be regarded as satisfactory.

(3) The depth of the double bottom shall be not less than 0.50 m. The depth below a suction well may however be locally reduced to 0.40 m, provided that the suction well has a capacity of not more than 0.03 m³.

110 292 Emergency exit

Spaces the entrances or exits of which are partly or fully immersed in damaged condition shall be provided with an emergency exit not less than 0.10 m above the waterline. This does not apply to forepeak and afterpeak.

Annex B.1 - Part III

110 293 Stability (general)

- (1) Proof of sufficient stability shall be furnished including stability in the damaged condition.
- (2) The basic values for the stability calculation - the vessel's lightweight and the location of the centre of gravity - shall be determined either by means of an inclining experiment or by detailed mass and moment calculation. In the latter case the lightweight shall be checked by means of a lightweight test with a resulting difference of not more than $\pm 5\%$ between the mass determined by the calculation and the displacement determined by the draught readings.
- (3) Proof of sufficient intact stability shall be furnished for all stages of loading and unloading and for the final loading condition.

Floatability after damage shall be proved for the most unfavourable loading condition. For this purpose calculated proof of sufficient stability shall be established for critical intermediate stages of flooding and for the final stage of flooding. Negative values of stability in intermediate stages of flooding may be accepted only if the continued range of curve of righting lever in damaged condition indicates adequate positive values of stability.

110 294 Stability (intact)

- (1) The requirements for intact stability resulting from the damaged stability calculation shall be fully complied with.
- (2) For the carriage of containers, proof of sufficient stability shall also be furnished in accordance with the provisions of the regulations referred to in marginal 10 001 (1).
- (3) The most stringent of the requirements of (1) and (2) above shall prevail for the vessel.

110 295 Stability (damaged condition)

- (1) The following assumptions shall be taken into consideration for the damaged condition:
 - (a) The extent of side damage is as follows:

longitudinal extent:	at least 0.10 L, but not less than 5.00 m;
transverse extent:	0.59 m;
vertical extent:	from the baseline upwards without limit.
 - (b) The extent of bottom damage is as follows:

longitudinal extent:	at least 0.10 L, but not less than 5.00 m;
transverse extent:	3.00 m;
vertical extent:	from the base 0.49 m upwards, the sump excepted.
 - (c) Any bulkheads within the damaged area shall be assumed damaged, which means that the location of bulkheads shall be chosen so as to ensure that the vessel remains afloat after the flooding of two or more adjacent compartments in the longitudinal direction.

**110 295
(cont'd)**

The following provisions are applicable:

- For bottom damage also two adjacent athwartships compartments shall be assumed as flooded.

Annex B.1 - Part III

- The lower edge of any openings that cannot be closed watertight (e.g. doors, windows, access hatchways) shall, at the final stage of flooding, be not less than 0.10 m above the damage waterline.
- In general, permeability shall be assumed to be 95%. Where an average permeability of less than 95% is calculated for any compartment, this calculated value may be used.

However, the following minimum values shall be used:

- | | |
|---|-----------|
| - engine rooms: | 85% |
| - accommodation: | 95% |
| - double bottoms, oil fuel tanks, ballast tanks, etc.,
depending on whether, according to their function,
they have to be assumed as full or empty for the
vessel floating at the maximum permissible draught: | 0% or 95% |

For the main engine room only the one-compartment standard needs to be taken into account, i.e. the end bulkheads of the engine room shall be assumed as not damaged.

(2) At the stage of equilibrium (final stage of flooding) the angle of heel shall not exceed 12°. Non-watertight openings shall not be immersed before reaching the stage of equilibrium. If such openings are immersed before that stage, the corresponding spaces shall be considered as flooded for the purpose of stability calculation.

The positive range of the righting lever curve beyond the position of equilibrium shall have a righting lever of ≥ 0.05 m in association with an area under the curve of ≥ 0.0065 m rad. The minimum values of stability shall be satisfied up to immersion of the first non-weather-tight opening and in any event up to an angle of heel $\leq 27^\circ$. If non-weather-tight openings are immersed before that stage, the corresponding spaces shall be considered as flooded for the purposes of stability calculation.

Annex B.1 - Part III

110 295
(cont'd)

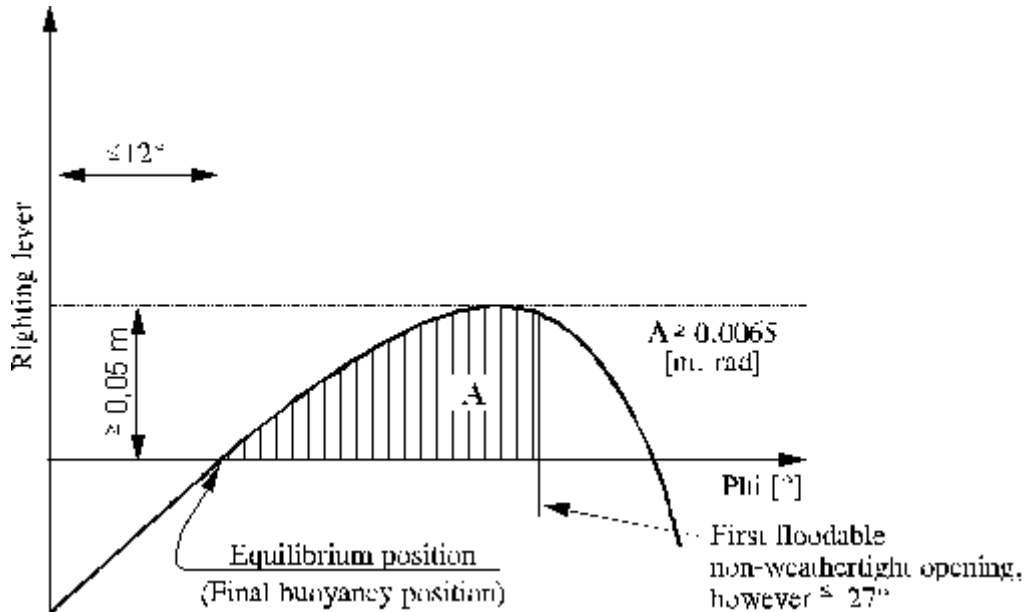

- (3) In land navigation vessels carrying containers which have not been secured shall satisfy the following damage stability criteria:

At the stage of equilibrium (final stage of flooding) the angle of heel shall not exceed 5° . Non-weather-tight openings shall not be immersed before reaching the stage of equilibrium. If such openings are immersed before that stage, the corresponding spaces shall be considered as flooded for the purpose of stability calculation.

The positive range of the righting lever curve beyond the position of equilibrium shall have an area under the curve of $\geq 0,0065$ m.rad. The minimum values of stability shall be satisfied up to immersion of the first non-weather-tight opening and in any event up to an angle of heel $\leq 10^\circ$. If non-weather-tight openings are immersed before that stage, the corresponding spaces shall be considered as flooded for the purposes of stability calculation.

Annex B.1 - Part III

110 295
(cont'd)

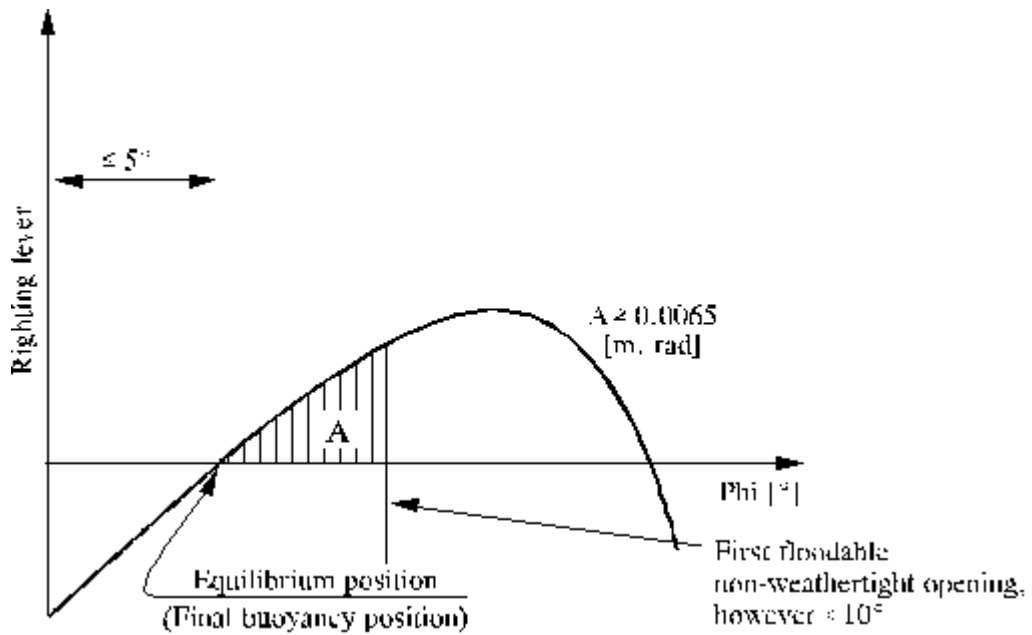

(4) If openings through which undamaged compartments may become additionally flooded are capable of being closed watertight, the closing devices shall be appropriately marked.

(5) Where cross- or down-flooding openings are provided for reduction of unsymmetrical flooding, the time for equalization shall not exceed 15 minutes if during the intermediate stages of flooding sufficient stability has been proved.

110 296-
119 999

Part IV

Rules for construction applicable to seagoing vessels which comply with the requirements of the Solas convention, Chapter II-2, Regulation 54

(RESERVED)

Annex B.1 - Part IV

**120 000-
120 099**

120 100 General

Seagoing vessels shall comply either with Part III of this Annex or with the provisions of Regulation 54 of Chapter II-2 of SOLAS and the requirements set out below.

120 200 Materials of construction

The vessels hull shall be constructed of shipbuilding steel or other metal, provided that this metal has at least equivalent mechanical properties and resistance to the effects of temperature and fire.

**120 201-
120 219**

120 220 Water ballast

The double-hull spaces and double bottoms may be arranged for being filled with water ballast.

**120 221-
120 230**

120 231 Engines

- (1) Only internal combustion engines running on a fuel having a flashpoint above 60 °C, are allowed.
- (2) Air intakes of the engines shall be located not less than 2.00 m from the protected area.
- (3) Sparking shall not be possible in the protected area.

120 232

120 233

120 234 Exhaust pipes

- (1) Exhausts shall be evacuated from the vessel into the open-air either upwards through an exhaust pipe or through the shell plating. The exhaust outlet shall be located not less than 2.00 m from the hatchway openings. The exhaust pipes of engines shall be arranged so that the exhausts are led away from the vessel. The exhaust pipes shall not be located within the protected area.
- (2) Exhaust pipes shall be provided with a device preventing the escape of sparks, e.g. spark arresters.

**120 235-
120 240**

120 241 Fire and naked light

Annex B.1 - Part IV

(1) The outlets of funnels shall be located not less than 2.00 m from the hatchway openings. Arrangements shall be provided to prevent the escape of sparks and the entry of water.

(2) Heating, cooking and refrigerating appliances shall not be fuelled with liquid fuels, liquid gas or solid fuels. The installation in the engine room or other separate space of heating appliances fuelled with liquid fuel having a flashpoint above 55 °C shall, however, be permitted. Cooking and refrigerating appliances are permitted only in wheelhouses with metal floor and in the accommodation.

(3) Electric lighting appliances only are permitted outside the accommodation and the wheelhouse.

**120 242-
120 270**

120 271 Admittance on board

The notice boards displaying the prohibition of admittance in accordance with marginal 10 371 shall be clearly legible from either side of the vessel.

120 272

120 273

120 274 Prohibition of smoking, fire and naked light

(1) The notice boards displaying the prohibition of smoking in accordance with marginal 10 374 shall be clearly legible from either side of the vessel.

(2) Notice boards indicating the circumstances under which the prohibition applies shall be fitted near the entrances to the spaces where smoking or the use of fire or naked light is not always prohibited.

(3) Ashtrays shall be provided close to each exit of the accommodation and of the wheelhouse.

**120 275-
120 279**

Additional rules applicable to double-hull vessels

**120 280-
120 287**

120 288 Classification

(1) Double-hull vessels intended to carry dangerous goods of Classes 2, 3, 4.1, 5.2, 6.1, 8 or 9 except those of 31° (b), 32° (b), 41° (b) and 42° (b) of Class 4.1 and 1° (b), 2° (b), 11° (b) and 12° (b) of Class 5.2 in quantities exceeding those referred to in marginal 10 401 (1)

Annex B.1 - Part IV

120 288 (cont'd) or material of Class 7, marginal 2704, schedules 5 to 13 of Annex A to ADR, shall be built under survey of a recognized classification society in accordance with the rules established by that classification society to its highest class. This shall be confirmed by the classification society by the issue of an appropriate certificate.

(2) The vessel's class shall be continued.

**120 289-
120 290**

120 291 Holds

(1) The vessel shall be built as a double-hull vessel with double-wall spaces and double bottom within the protected area.

(2) The distance between the sides of the vessel and the longitudinal bulkheads of the hold shall be not less than 0.80 m. A locally reduced distance at the vessel's ends shall be permitted, provided the smallest distance between vessel's side and the longitudinal bulkhead (measured perpendicular to the side) is not less than 0.60 m. The sufficient structural strength of the vessel (longitudinal, transverse and local strength) shall be confirmed by the class certificate.

(3) The depth of the double bottom shall be not less than 0.50 m.

The depth below the suction wells may however be locally reduced to 0.40 m, provided the suction well has a capacity of not more than 0.03 m³.

120 292

120 293 Stability (general)

(1) Proof of sufficient stability shall be furnished including stability in the damaged condition.

(2) The basic values for the stability calculation - the vessel's lightweight and the location of the centre of gravity - shall be determined either by means of an inclining experiment or by detailed mass and moment calculation. In the latter case the lightweight shall be checked by means of a lightweight test with a resulting difference of not more than $\pm 5\%$ between the mass determined by the calculation and the displacement determined by the draught readings.

(3) Proof of sufficient intact stability shall be furnished for all stages of loading and unloading and for the final loading condition.

Floatability after damage shall be proved for the most unfavourable loading condition. For this purpose calculated proof of sufficient stability shall be established for critical intermediate stages of flooding and for the final stage of flooding. Negative values of stability in intermediate stages of flooding may be accepted only if the continued range of curve of righting lever in damaged condition indicates adequate positive values of stability.

120 294 Stability (intact)

(1) The requirements for intact stability resulting from the damaged stability calculation shall be fully complied with.

Annex B.1 - Part IV

(2) For the carriage of containers, additional proof of sufficient stability shall be furnished in accordance with the requirements of the regulations referred to in marginal 10 001 (1).

(3) The most stringent of the requirements of paragraphs (1) and (2) shall prevail for the vessel.

(4) For seagoing vessels the provisions of (2) above may be regarded as having been complied with if the stability conforms to IMO Resolutions A.167 (ES.IV) and A.206 (VII). This applies only when all containers are secured as usual on seagoing vessels and a relevant stability document has been approved by the competent authority.

120 295 Stability (damaged condition)

(1) The following assumptions shall be taken into consideration for the damaged condition:

(a) The extent of side damage is as follows:

longitudinal extent: at least 0.10 L, but not less than 5.00 m;
transverse extent: 0.59 m;
vertical extent: from the baseline upwards without limit.

(b) The extent of bottom damage is as follows:

longitudinal extent: at least 0.10 L, but not less than 5.00 m;
transverse extent: 3.00 m;
vertical extent: from the base 0.49 m upwards, the sump excepted.

(c) Any bulkheads within the damaged area shall be assumed damaged, which means that the location of bulkheads shall be chosen so that the vessel will remain afloat after flooding of two adjacent compartments in the longitudinal direction.

The following provisions are applicable:

- For bottom damage, adjacent athwartship compartments shall also be assumed as flooded.
- The lower edge of any openings that cannot be closed watertight (e.g. doors, windows, access hatchways) shall, at the final stage of flooding, be not less than 0.10 m above the damage waterline.
- In general, permeability shall be assumed to be 95%. Where an average permeability of less than 95% is calculated for any compartment, this calculated value may be used.

However, the following minimum values shall be used:

- engine rooms 85%
- accommodation 95%
- double bottoms, oil fuel tanks, ballast tanks, etc., depending on whether according to their function, they have to be assumed as full or empty for the vessel floating at the maximum permissible draught 0% or 95%

**120 295
(cont'd)**

For the main engine room only the one-compartment standard needs to be taken into account.

Annex B.1 - Part IV

(Consequently, the end bulkheads of the engine room shall be assumed as not damaged.)

(2) At the stage of equilibrium (final stage of flooding) the angle of heel shall not exceed 12° . Non-watertight openings shall not be immersed before reaching the stage of equilibrium. If such openings are immersed before that stage, the corresponding spaces shall be considered as flooded for the purpose of stability calculation.

The positive range of the righting lever curve beyond the position of equilibrium shall have a righting lever of ≥ 0.05 m in association with an area under the curve of ≥ 0.0065 m.rad. The minimum values of stability shall be satisfied up to immersion of the first non-weather-tight opening and in any event up to an angle of heel $\leq 27^\circ$. If non-weather-tight openings are immersed before that stage, the corresponding spaces shall be considered as flooded for the purposes of stability calculation.

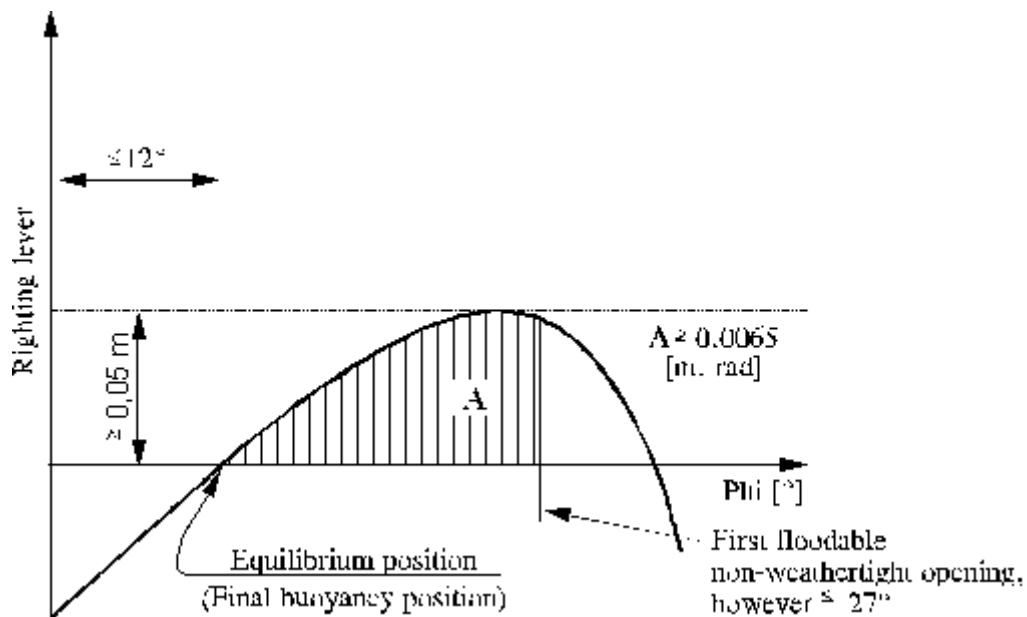

(3) If openings through which undamaged compartments may become additionally flooded are capable of being closed watertight, the closing devices shall be appropriately marked.

(4) Where cross- or down-flooding openings are provided for reduction of unsymmetrical flooding, the time for equalization shall not exceed 15 minutes if during the intermediate stages of flooding sufficient stability has been proved.

120 296-
120 299

120 300-
209 999

(RESERVED)

ANNEX B.1

APPENDICES

(RESERVED)

Annex B.1 - Appendix 1

**APPENDIX 1
Model 1**

Model for a certificate of approval

Competent authority :
Space reserved for the emblem and name of the State

Certificate of approval No:
according to Annex B.1, marginal 10 282, ADN

1. Name of vessel

2. Official number

3. Type of vessel

4. Additional requirements:

Vessel subject to ADN under marginal 10 219 (1) only 1/

Vessel subject to ADN under marginal 210 219 (3) only 1/

The vessel conforms to the additional rules for construction of Annex B.1 of ADN applicable to double-hull vessels 1/

5. Permitted derogations :

6. The validity of this certificate of approval expires on (date)

7. The previous certificate of approval No was issued on
by (competent authority)

8. The vessel is approved for the carriage of dangerous goods following:

- inspection on 1/ (date)

- certification by a recognized classification society 1/

Name of the classification society 1/ (date)

9. Subject to permitted equivalences: 1/

.....
.....

10. Subject to special authorizations: 1/

.....
.....

11. Issued at: on
(place) (date)

12. (Stamp)
(competent authority)

.....
(signature)

1/ Delete as appropriate.

Annex B.1 - Appendix 1

Extension of the validity of the certificate of approval

13. The validity of this certificate is extended under marginal 10 282 (4) of Annex B.1 of ADN

Until
(date)

14. on
(place) (date)

15. (Stamp)
(competent authority)

.....
(signature)

Annex B.1 - Appendix 1

**APPENDIX 1
Model 2**

Model for a provisional certificate of approval

NOTE : This model certificate of approval may be replaced by a single certificate model combining a provisional certificate of inspection and the provisional certificate of approval, provided that this single certificate model contains the same particulars as the model below and is approved by the competent authorities.

Competent authority :

Space reserved for the emblem and name of the State

Provisional certificate of approval No:
according to Annex B.1, marginal 10 283, ADN

1. Name of vessel

2. Official number

3. Type of vessel

4. Additional requirements:

Vessel subject to ADN under marginal 10 219 (1) only /

Vessel subject to ADN under marginal 2 10 2 19 (3) only /

The vessel conforms to the additional rules for construction of Annex B.1 of ADN applicable to double-hull vessels /

5. Permitted derogations :

6. The provisional certificate of approval is valid /

6.1 until

6.2 for a single journey from to

7. Issued at: on
(place) (date)

8. (Stamp)
(competent authority)

.....
(signature)

_____ Delete as appropriate.

(RESERVED)

Annex B.1 - Appendix 1

**APPENDIX 1
Model 3**

**Certificate of special knowledge of ADN according
to marginals 10 315, 210 315, 210 317 or 210 318**

(see next page)
(Format: A6, Colour: orange)

Annex B.1 - Appendix 1

(Space reserved for the emblem of State, competent authority)

ADN certificate
of special knowledge of ADN

No of certificate:.....

Name:

First name(s):

Born on:

Nationality:

Signature of holder:

The holder of this certificate has special knowledge of ADN.

The certificate is valid for special knowledge of ADN according to marginals 10 315/210 315, 210 317, 210 318 */

until:

Issued by:

Date:

(Stamp)

Signature:

*) Delete as appropriate.

(Recto)

(Verso)

Annex B.1 - Appendix 2

APPENDIX 2

Models of danger labels prescribed by international Regulations





A. Danger labels

- (1) The danger labels prescribed for dangerous goods are based on those appearing in the United Nations Recommendations on the Transport of Dangerous Goods. The IMDG Code and the ICAO-TI follow entirely the system of the United Nations Recommendations, which distinguishes between primary risk labels (with the class or division number in the bottom corner) and subsidiary risk labels (with no number in the bottom corner). RID and ADR use the same labels but do not distinguish systematically between primary hazard labels and subsidiary risk labels, and the figure in the bottom corner of the label is therefore not always prescribed.
- (2) The table set out below describes the labels. The column furthest to the left gives the label model number appearing in the United Nations Recommendations on the Transport of Dangerous Goods; the second column gives the RID/ADR model number.
- (3) Labels Nos. 1 to 7C and 8 to 9 are diamond-shaped with dimensions of 100 mm by 100 mm. They have a black line 5 mm inside the edge and running parallel to it. If the size of the package so requires, the dimensions of the labels may be reduced, provided that they remain clearly visible. On gas cylinders, the labels may be affixed to the shoulder of the cylinder and the dimensions may therefore be reduced, provided that they remain clearly visible.
- (4) Label No. 7D and other labels to be affixed to transport units (containers, vehicles, wagons, tanks) must measure not less than 250 x 250 mm. According to the IMDG Code, these enlarged labels (placards) must bear the appropriate class number in the bottom corner, as prescribed for labels, in figures not less than 25 mm high.
- (5) RID/ADR labels No. 11 is rectangular, of standard format A5 (148 x 210 mm). If the size of the package so requires, the dimensions of the labels may be reduced, provided they remain clearly visible.
- (6) An inscription in figures (e.g. the UN number) or letters (e.g. "FLAMMABLE LIQUID"), concerning the nature of the danger, may be placed on the lower part of the label.
- (7) Wording on danger labels must be legible and indelible. According to the IMDG Code, the stencilling of labels on packages must be so executed that the labels on the packages can still be recognized after not less than three months in seawater.
- (8) The IMDG Code prescribes a special label (or marking) to identify marine pollutants. This marking must be of a colour contrasting with that of the package, or in the case of a sticker be black and white. The sides of this triangular marking must measure not less than 100 mm for packages, (except where the dimensions of the latter make it necessary to use smaller markings), and not less than 250 mm for transport equipment.





Annex B.1 - Appendix 2

Models of danger labels prescribed by international regulations





A. Danger labels

Danger label number according to		Description	Explanation	Label
UN	RID/ADR			
1	1	Black on orange background: bomb blast in upper half; appropriate division number and compatibility group letter in lower half; small figure "1" in bottom corner	Liable to explosion, Divisions 1.1, 1.2 and 1.3	
1.4	1.4	Black on orange background: Division No. "1.4" filling most of the upper half; appropriate compatibility group letter in the lower half; small figure "1" in bottom corner	Liable to explosion, Division 1.4	
1.5	1.5	Black on orange background: Division No. "1.5" filling most of the upper half; compatibility group letter "D" in the lower half; small figure "1" in bottom corner	Liable to explosion, Division 1.5	
1.6	1.6	Black on orange background: Division No. "1.6" filling most of the upper half; compatibility group letter "N" in the lower half; small figure "1" in bottom corner	Liable to explosion, Division 1.6	
01	01	Black on orange background: bomb blast in upper half	Liable to explosion	





Annex B.1 - Appendix 2

Danger label number according to		Description	Explanation	Label
UN	RID/ADR			
2.1	-	Black or white flame on red ground, small figure "2" in bottom corner	Danger of fire (flammable gases) (IMDG Code and ICAO-TI only)	
2.2	2	Gas cylinder, black or white, on green background, small figure "2" in bottom corner	Non-flammable, non-toxic gases	
2.3	-	Death's head on cross-bones black on white ground, small figure "2" in bottom corner	Toxic gases (IMDG Code and ICAO-TI only)	
3	-	Black or white flame on red ground, small figure "3" in bottom corner	Danger of fire (flammable liquids) (IMDG Code/ICAO-TI only) (primary hazard only)	
03	3	As above, without the figure "3" in the bottom corner	Danger of fire (flammable liquids and gases) (RID/ADR: primary hazard or subsidiary risk) (IMDG Code/ICAO-TI: subsidiary risk only)	





Annex B.1 - Appendix 2

Danger label number according to		Description	Explanation	Label
UN	RID/ADR			
4.1	-	Black flame on ground of equidistant alternate red and white vertical stripes small figure "4" in bottom corner	Danger of fire (flammable solids) (IMDG Code and ICAO-TI only, primary hazard only)	
04.1	4.1	As above, without the figure "4" in the bottom corner	Danger of fire (flammable solids) (RID/ADR: primary hazard and subsidiary risk) (IMDG Code/ICAO-TI: subsidiary risk only)	
4.2	-	Black flame on white ground, lower triangle of label red small figure "4" in bottom corner	Substance liable to spontaneous ignition (IMDG Code/ICAO-TI only, primary hazard only)	
04.2	4.2	As above, without the figure "4" in the bottom corner	Substance liable to spontaneous ignition (RID/ADR: primary hazard and subsidiary risk) (IMDG Code/ICAO-TI: subsidiary risk only)	





Annex B.1 - Appendix 2

Danger label number according to		Description	Explanation	Label
UN	RID/ADR			
4.3	-	Black or white flame on blue ground, figure "4" in bottom corner	Danger of emission of flammable gases on contact with water (IMDG Code/ICAO-TI only; primary hazard only)	
04.3	4.3	As above, without the figure "4" in the bottom corner	Danger of emission of flammable gases on contact with water (RID/ADR: primary hazard and subsidiary risk; IMDG Code/ICAO-TI: subsidiary risk only)	
5.1	5.1	Flame over a circle, black on yellow background, small figure "5.1" in bottom corner	Oxidizing substance	
5.2	5.2	Flame over a circle, black on yellow background, small figure "5.2" in bottom corner	Organic peroxide: risk of fire	
05	05	Flame over a circle, black on yellow background	Fire-intensifying risk	





Annex B.1 - Appendix 2

Danger label number according to		Description	Explanation	Label
UN	RID/ADR			
6.1	-	Death's head on cross-bones black on white ground, small figure "6" in bottom corner	Toxic substance: to be kept apart from foodstuffs and other articles for consumption in vehicles and at loading, unloading or transloading points (IMDG Code/ICAO-TI only: primary hazard only)	
06.1	6.1	As above, without the figure "6" in the bottom corner	As above but: RID/ADR: primary hazard and subsidiary risk; IMDG Code/ICAO-TI: subsidiary risk only	
6.2	6.2	Three crescents superimposed on a circle, black on white ground, small figure "6" in bottom corner	Infectious substances: to be kept apart from foodstuffs and other articles for consumption in vehicles and at loading, unloading or transloading points	
7A	7A	Stylized trefoil, inscription RADIOACTIVE followed by a vertical stripe in the lower half, with the following text: Contents ... Activity ... small figure "7" in lower corner; black symbol and inscription on white background; red vertical stripe	Radioactive material in packages of category I-WHITE; in the event of damage to the packages, danger to health by ingestion or inhalation of, or contact with, spilled contents	

Annex B.1 - Appendix 2

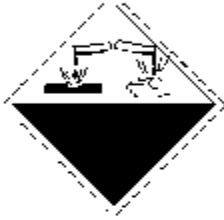
Danger label number according to		Description	Explanation	Label
UN	RID/ADR			
7B	7B	As above, but with two red vertical stripes in the lower half and the following text: Contents ... Activity ... Transport index ... (in the rectangular black-bordered box); small figure "7" in bottom corner, black symbol and inscriptions; upper half of background: yellow; lower half of background: white; red vertical stripes	Radioactive material in packages of category II-YELLOW; packages to be kept away from packages bearing the inscription "FOTO"; in the event of damage to packages, danger to health by ingestion or inhalation of, or contact with, spilled contents, and risk of external radiation at a distance	
7C	7C	As above, but with three red vertical stripes in the lower half	Radioactive material in packages of category III-YELLOW; packages to be kept away from packages bearing the inscription "FOTO"; in the event of damage to packages, danger to health by ingestion or inhalation of, or contact with, spilled contents, and a risk of external radiation at a distance	
7D	7D	Stylized trefoil, inscription RADIOACTIVE, and figure "7". Black symbol and inscription; upper half of background: yellow; lower half of background: white. The use of the word "Radioactive" in the lower half is optional to allow the alternative use of this label to display the appropriate substance identification number for the consignment	Radioactive material presenting the dangers described under 7A, 7B or 7C	 or 

Annex B.1 - Appendix 2

Danger label number according to		Description	Explanation	Label
UN	RID/ADR			
8	-	Liquid dripping from a test-tube on to a plate, and from another test-tube on to a hand; black or white ground, lower triangle of label black with a white border, small white figure "8" in bottom corner	Corrosive substance (IMDG Code/ICAO-TI only, primary hazard only)	
08	8	As above, without the figure "8" in the bottom corner	Corrosive substance (RID/ADR: primary hazard and subsidiary risk; IMDG Code/ICAO-TI: subsidiary risk only)	
9	9	White background with seven black vertical stripes in the upper half, and small figure "9", underlined, in the bottom corner	Miscellaneous substances and articles which, during transport, present dangers other than those covered by the other classes	
-	-	Triangular marking; a cross superimposed on a fish, black on white ground	Marine pollutant (IMDG Code only)	
-	10	(Reserved)		
-	11	Two black arrows on white or suitable contrasting ground	This side up: label to be affixed, with arrows pointing upwards	
-	12	(Reserved)		

Annex B.1 - Appendix 2

B. Marking of transport units (placarding)

- (1) In addition to the affixing of enlarged labels on transport units, the IMDG Code, RID and ADR prescribe special marking for certain transport units.
- (2) The IMDG Code prescribes that the UN number for dangerous goods should be displayed in black digits not less than 65 mm high, either on a white background in the lower half of the placard, or on an orange rectangular panel not less than 120 mm high and 300 mm wide, with a 10 mm black border, to be placed immediately adjacent to the placard (see examples B.1 and B.2 below). These markings are applicable to tank-vehicles, vehicles and containers for bulk transport and transport units loaded with a single special substance in packages (except for goods of Class 1) constituting a full load.
- (3) ADR prescribes that rectangular orange-coloured plates (40 cm x 30 cm) must be affixed to transport units carrying dangerous goods. In addition, RID and ADR prescribe for bulk tank units and vehicles, wagons and containers a marking on the orange panels (40 cm x 30 cm) including in the lower half the substance-identification number (UN number) and in the upper half the hazard-identification number. The conditions of application are set out in marginal 10 500 of Annex B of ADR, and the hazard identification numbers (and their meaning) in Appendix B.5 of ADR (ADR, Annex B, marginal 250 000).
- (4) ADR prescribes that special vehicles carrying substances of 20° (c) of Class 9 and specially equipped vehicles carrying substances of 21° (c) of Class 9 shall bear on two sides and at the rear the mark referred to in Appendix B.7 (marginal 270 000) (see B.3 below) (triangular shaped mark with sides of at least 250 mm, to be shown in red). This mark is also required on both sides of shells of tank-containers, tank-vehicles and tank-wagons carrying substances of 21° (c) of Class 9 according to ADR, RID, and the IMDG Code.
- (5) The IMDG Code prescribes that closed transport units loaded with cargoes under fumigation should clearly display the fumigation warning sign (see B.4 below) in a location where it will be easily seen by persons attempting to enter the interior of the unit.

Annex B.1 - Appendix 2

B.1 Example of marking for a tank-container carrying acetal, Class 3, UN No 1088, according to the IMDG Code

FIRST VARIANT



black flame on
red background

SECOND VARIANT



black flame on
red background



orange background
border and digits in black

B.2 Example of marking for a tank-container carrying acetal, Class 3, UN No 1088, according to RID/ADR



black flame on
red background



Hazard-identification
number (2 or 3 digits)

Substance -identification
number (4 digits)

orange background.
Border, horizontal line and digits,
15 mm in stroke width

Annex B.1 - Appendix 2

B.3 Mark for carriage at elevated temperature



B.4 Fumigation warning sign

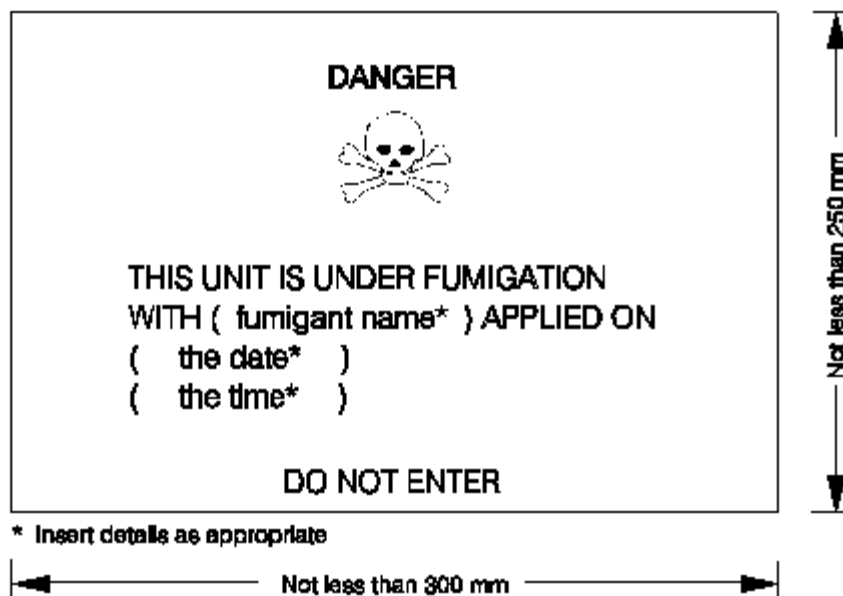

(RESERVED)

ANNEX B.2

Provisions concerning the carriage of dangerous goods in tank vessels

(RESERVED)

ANNEX B.2**PROVISIONS CONCERNING THE CARRIAGE OF DANGEROUS GOODS
IN TANK VESSELS****TABLE OF CONTENTS**

	Marginals
Part I - DEFINITIONS AND GENERAL PROVISIONS CONCERNING THE CARRIAGE OF DANGEROUS GOODS OF ALL CLASSES	
General	
Plan of Annex B.2	210 000
Applicability of other regulations	210 001
Scope of Annex B.2	210 003
Definitions	210 014
SECTION 1. Mode of carriage of goods	
Carriage in cargo tanks	210 121
SECTION 2. Requirements applicable to vessels	
Construction	210 200
Types of vessel	210 204
Instructions for the use of devices and installations	210 205
Gas detection system	210 206
Classification	210 208
Pushed convoys and side-by-side formations	210 219
Fire-extinguishing arrangements	210 240
Electrical installations	210 251
Special equipment	210 260
Checking and inspection of equipment	210 280
Certificate of approval	210 282
Provisional certificate of approval	210 283
Loading journal	210 284
SECTION 3. General service requirements	
Access to cargo tanks, residual cargo tanks, cargo pump-rooms below deck, cofferdams, double-hull spaces, double bottoms and hold spaces; inspections	210 301
Cargo pump-rooms below deck	210 302
Gas detection system	210 306
Gas-freeing of empty cargo tanks	210 307
Repair and maintenance work	210 308
Ventilation	210 312
Dangerous goods training	210 315
Knowledge of gases	210 317
Knowledge of chemicals	210 318
Water ballast	210 320
Entrances to hold spaces, cargo pump-rooms below deck, cofferdams, opening of cargo tanks and residual cargo tanks; closing devices	210 322
Connections between pipes	210 325
Persons authorized on board	210 327

Table of Content of Annex B.2**Marginals**

Lifeboats	210 329
Engines	210 331
Oil fuel tanks	210 332
Fire-extinguishing arrangements	210 340
Fire and naked light	210 341
Cargo heating system	210 342
Cleaning operations	210 344
Electrical installations	210 351
Portable lamps	210 354
Special equipment	210 360
Admittance on board	210 371
Prohibition of smoking	210 374
Risk of sparking	210 375
Checking of equipment	210 380
Documents	210 381
Instructions in writing	210 385

SECTION 4. Additional requirements concerning loading, carriage, unloading and other handling of cargo

Limitation of the quantities carried	210 401
Reception of oily and greasy wastes resulting from the operation of vessels and delivery of products for the operation of vessels	210 402
Places of loading and unloading	210 407
Cargo transfer operations	210 409
Check list	210 410
Loading journal	210 411
Measures to be taken before loading	210 413
Cargo handling and stowage	210 414
Measures to be taken after unloading	210 415
Measures to be taken during loading, carriage, unloading and handling	210 416
Closing of windows and doors	210 417
Monitoring of gaseous phases in cargo tanks and adjacent empty spaces	210 418
Filling of cargo tanks	210 421
Opening of openings	210 422
Simultaneous loading and unloading	210 424
Cargo piping	210 425
Fire-extinguishing arrangements	210 440
Fire or naked light	210 441
Electrical installations	210 451
Lighting	210 453
Specific equipment	210 460
Prohibition of smoking, fire and naked light	210 474
Risk of sparking	210 475
Synthetic ropes	210 476

SECTION 5. Additional requirements concerning the operation of vessels

Table of Content of Annex B.2

	Marginals
Marking	210 500
Mode of navigation	210 501
Mooring	210 503
Berthing	210 504
Part II - SPECIAL PROVISIONS CONCERNING THE CARRIAGE OF DANGEROUS GOODS OF CLASSES 2, 3, 4.1, 6.1, 8 AND 9 SUPPLEMENTING OR AMENDING THE PROVISIONS OF PART I	
Class 2 Gases	221 000 and seq.
Class 3 Flammable liquids	231 000 and seq.
Class 4.1 Flammable solids	241 000 and seq.
Class 6.1 Toxic substances	261 000 and seq.
Class 8 Corrosive substances	281 000 and seq.
Class 9 Miscellaneous dangerous substances and articles	291 000 and seq.
Part III - RULES FOR CONSTRUCTION OF TANK VESSELS	
Chapter 1 - Rules for construction of type G tank vessels	
General	311 100
Materials of construction	311 200
Classification	311 208
Protection against the penetration of gases	311 210
Hold spaces and cargo tanks	311 211
Ventilation	311 212
Stability (general)	311 213
Stability (intact)	311 214
Stability (damaged condition)	311 215
Engine rooms	311 216
Accommodation and service spaces	311 217
Safety and control in stallations	311 221
Cargo tank openings	311 222
Pressure test	311 223
Pumps and piping	311 225
Cargo refrigeration systems	311 227
Water-spray system	311 228
Engines	311 231
Oil fuel tanks	311 232
Exhaust pipes	311 234
Bilge pumping and ballasting arrangements	311 235
Fire-extinguishing arrangements	311 240
Fire and naked light	311 241
Documents concerning electrical installations	311 250
Electrical installations	311 251
Type and location of electrical equipment	311 252
Earthing	311 253
Electrical cables	311 256
Special equipment	311 260
Admittance on board	311 271
Prohibition of smoking, fire or naked light	311 274
Emergency exit	311 292

Table of Content of Annex B.2**Marginals****Chapter 2 - Rules for construction of type C tank vessels**

General	321 100
Materials of construction	321 200
Classification	321 208
Protection against the penetration of gases	321 210
Hold spaces and cargo tanks	321 211
Ventilation	321 212
Stability (general)	321 213
Stability (intact)	321 214
Stability (damaged condition)	321 215
Engine rooms	321 216
Accommodation and service spaces	321 217
Arrangement of cofferdams	321 220
Safety and control installations	321 221
Cargo tank openings	321 222
Pressure tests	321 223
Pumps and piping	321 225
Residual cargo tanks and slop tanks	321 226
Water-spray system	321 228
Engines	321 231
Oil fuel tanks	321 232
Exhaust pipes	321 234
Bilge pumping and ballasting arrangements	321 235
Fire-extinguishing arrangements	321 240
Fire and naked light	321 241
Cargo heating system	321 242
Documents concerning electrical installations	321 250
Electrical installations	321 251
Type and location of electrical equipment	321 252
Earthing	321 253
Electrical cables	321 256
Special equipment	321 260
Admittance on board	321 271
Prohibition of smoking, fire or naked light	321 274
Emergency exit	321 292

Chapter 3 - Rules for construction of type N tank vessels

General	331 100
Materials of construction	331 200
Classification	331 208
Protection against the penetration of gases	331 210
Hold spaces and cargo tanks	331 211
Ventilation	331 212
Stability (general)	331 213
Stability (intact)	331 214
Engine rooms	331 216
Accommodation and service spaces	331 217
Arrangement of cofferdams	331 220
Safety and control installations	331 221

Table of Content of Annex B.2

	Marginals
Cargo tank openings	331 222
Pressure tests	331 223
Pumps and piping	331 225
Residual cargo tanks and slop tanks	331 226
Water-spray system	331 228
Engines	331 231
Oil fuel tanks	331 232
Exhaust pipes	331 234
Bilge pumping and ballasting arrangements	331 235
Fire-extinguishing arrangements	331 240
Fire and naked light	331 241
Cargo heating system	331 242
Documents concerning electrical installations	331 250
Electrical installations	331 251
Type and location of electrical equipment	331 252
Earthing	331 253
Electrical cables	331 256
Special equipment	331 260
Admittance on board	331 271
Prohibition of smoking, fire or naked light	331 274
 Appendices	
Appendix 1	Model 1: Model for a certificate of approval Model 2: Model for a provisional certificate of approval Model 3: Certificate of special knowledge of ADN
Appendix 2	Checklist ADN
Appendix 3	Model 1: Device for the discharge of residual quantities Model 2: Test of the stripping system Model 3: Certificate for the test of the stripping system
Appendix 4	List of substances

(RESERVED)

Part I

Definitions and general provisions concerning the carriage of dangerous goods of all classes

(RESERVED)

Annex B.2 - Part I

General

210 000 Plan of Annex B.2

(1) This Annex comprises provisions concerning the carriage of dangerous goods in tank vessels.

(2) The provisions of Annex B.2 are divided into parts as follows:

Part I - Definitions and general provisions concerning the carriage of dangerous goods of all classes

Part II - Special provisions concerning the carriage of dangerous goods of Classes 2, 3, 4.1, 6.1, 8 and 9 supplementing or amending the provisions of Part I

Part III - Rules for construction

210 001 Applicability of other regulations

(1) In accordance with Article 9 of the Agreement, transport operations shall remain subject to local, regional or international provisions applicable in general to the carriage of goods by inland waterway.

(2) Where provisions of Parts II or III conflict with provisions of Part I or with the provisions referred to in paragraph (1) above, the provisions of Part I or those referred to in paragraph (1) above shall not apply.

The provisions of marginals 210 003 to 210 121, however, shall take precedence over those of Parts II and III.

(3) The special provisions applicable to the individual classes as set out in Part II shall supplement the general provisions of Part I.

210 002

210 003 Scope of Annex B.2

The provisions of this Annex shall also apply to empty vessels or vessels which have been unloaded as long as the cargo tanks or receptacles accepted on board are not free from dangerous goods or gases.

**210 004-
210 013**

Annex B.2 - Part I

210 014 Definitions

For the purposes of this Annex:

Electrical equipment

IEC means the International Electrotechnical Commission.

Limited explosion risk electrical apparatus

means:

- an electrical apparatus which, during normal operation, does not cause sparks or exhibits surface temperatures which are above the required temperature class, including e.g.
 - three-phase squirrel cage rotor motors;
 - brushless generators with contactless excitation;
 - fuses with an enclosed fuse element;
 - contactless electronic apparatus;

or:

- an electrical apparatus with an enclosure protected against water jets (degree of protection IP 55) which during normal operation does not exhibit surface temperatures which are above the required temperature class.

Certified safe type electrical apparatus

means an electrical apparatus which has been tested and approved by the competent authority regarding its safety of operation in an explosive atmosphere, e.g.

- intrinsically safe apparatus;
- flameproof enclosure apparatus;
- apparatus protected by pressurization;
- powder filling apparatus;
- apparatus protected by encapsulation;
- increased safety apparatus.

NOTE: "*Limited explosion risk*" apparatus is not covered by this definition.

Explosion group (see IEC publication 79 and EN 50 014)

means a grouping of flammable gases and vapours according to their maximum experimental safe gaps and minimum ignition currents, and of electrical apparatus which may be used in the corresponding potentially explosive atmospheres.

Electrical apparatus protected against water jets

means an electrical apparatus so designed that water, projected by a nozzle on the enclosure from any direction, has no damaging effects. The test conditions are specified in the IEC publication 529, minimum degree of protection IP 55.

Annex B.2 - Part I

210 014 *Temperature class* (see IEC publication 79 and EN 50 014) (cont'd)

means a grouping of flammable gases and vapours of flammable liquids according to their ignition temperature, and of electrical apparatus which may be used in the corresponding potentially explosive atmosphere according to their maximum surface temperature.

Types of protection (see IEC Publication 79 and EN 50 014)

EEx (d)	:	flameproof enclosure (EN 50 018);
EEx (e)	:	increased safety (EN 50 019);
EEx (ia) and EEx (ib)	:	intrinsic safety (EN 50 020);
EEx (m)	:	encapsulation (EN 50 028);
EEx (p)	:	pressurized apparatus (EN 50 016);
EEx (q)	:	powder filling (EN 50 017).

Classification of zones (see IEC publication 79-10)

- Zone 0: areas in which dangerous explosive atmospheres of gases, vapours or sprays exist permanently or during long periods;
- Zone 1: areas in which dangerous explosive atmospheres of gases, vapours or sprays are likely to occur occasionally;
- Zone 2: areas in which dangerous explosive atmospheres of gases, vapours or sprays are likely to occur rarely and if so for short periods only.

Division of space

Accommodation

means spaces intended for the use of persons normally living on board, including galleys, food stores, lavatories, washrooms, bathrooms, laundries, halls, alleyways, etc., but excluding the wheelhouse.

Bulkhead

means a metal wall or partition, generally vertical, both sides of which are inside the vessel and which is bounded by the bottom, the side plating, a deck or by another bulkhead.

Bulkhead (watertight)

A bulkhead shall be considered watertight if it has been constructed so that it can withstand water pressure with a head of 1.00 metre above the deck.

Cargo area

see "MISCELLANEOUS".

Cargo pump-room (comparable to "zone 1")

means a service space where the cargo pumps and stripping pumps are installed together with their operational equipment.

Annex B.2 - Part I

210 014 *Cargo tank* (comparable to "zone 0") **(cont'd)**

means a tank which is permanently attached to the vessel and the boundaries of which are either formed by the hull itself or by walls separate from the hull and which is intended for the carriage of dangerous goods.

Cofferdam (comparable to "zone 1")

means an athwartship compartment which is bounded by watertight bulkheads and which can be inspected. The cofferdam shall extend over the whole area of the end bulkheads of the cargo tanks. The bulkhead not facing the cargo area shall extend from one side of the vessel to the other and from the bottom to the deck in one frame plane.

Hold space (comparable to "zone 1")

means an enclosed part of the vessel which is bounded fore and aft by watertight bulkheads and which is intended only to carry cargo tanks independent of the vessel's hull.

Independent cargo tank (comparable to "zone 0")

means a cargo tank which is permanently built in, but which is independent of the vessel's structure.

Service space

means a space which is accessible during the operation of the vessel and which is neither part of the accommodation nor of the cargo tanks, with the exception of the forepeak and after peak, provided no machinery has been installed in these latter spaces.

Regulations

SOLAS

means the International Convention for the Safety of Life at Sea, 1974, as amended.

Miscellaneous

Bilge water

means oily water from the engine room bilges, the peak, the cofferdams and the double-hull spaces.

Breathing apparatus (ambient air-dependent)

means an apparatus which protects the person wearing it when working in a dangerous atmosphere by means of a suitable filter.

Breathing apparatus (self-contained)

means an apparatus which supplies the person wearing it when working in a dangerous atmosphere with breathing air by means of pressurized air carried with him or by means of a tube.

210 014 *Cargo area*

Annex B.2 - Part I

(cont'd)

means the whole of the following spaces (see figures below)

Cargo area

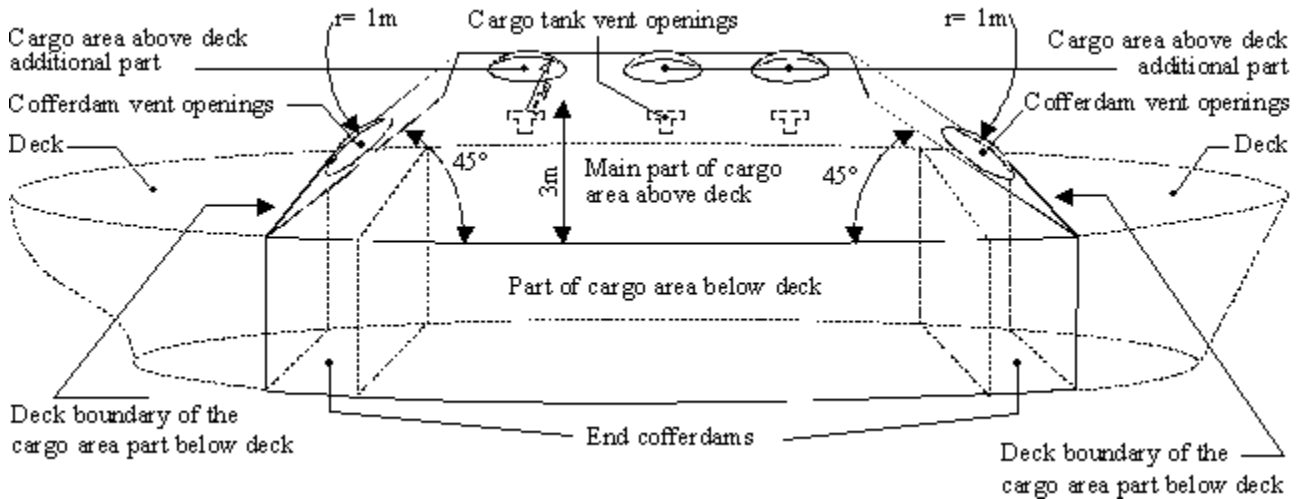

Above deck cargo area for various tank vessel

Tank vessels with deck formed by the top of tanks

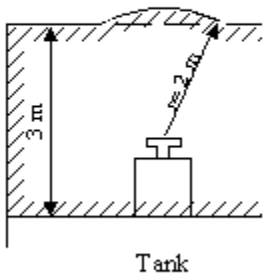

Tank vessels with trunk-deck

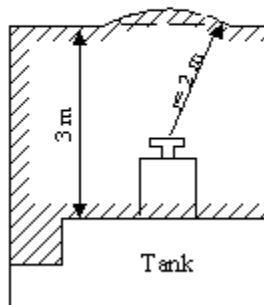

Tank vessels with independant cargo tanks

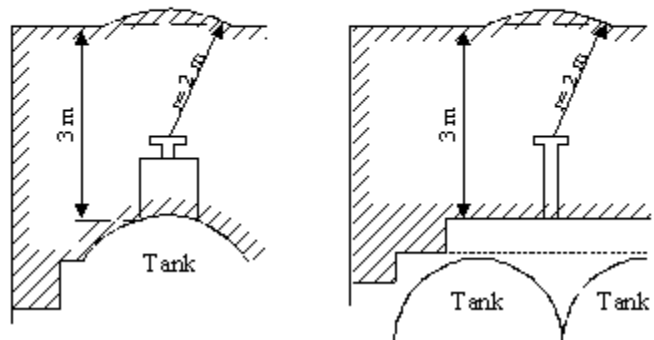

Cargo area (part below deck)

means the space between two vertical planes perpendicular to the centre-line plane of the vessel, which comprises cargo tanks, hold spaces, cofferdams, double-hull spaces and double bottoms; these planes normally coincide with the outer cofferdam bulkheads or hold end bulkheads. Their intersection line with the deck is referred to as the "boundary of the cargo area part below deck".

Cargo area (main part above deck) (comparable to "zone 1")

means the space which is bounded:

- at the sides, by the shell plating extending upwards from the decks sides;

210 014

- fore and aft, by planes inclined at 45° towards the cargo area, starting at the

Annex B.2 - Part I

- (cont'd) boundary of the cargo area part below deck;
- vertically, 3.00 m above the deck.

Cargo area (additional part above deck) (comparable to "zone 1")

means the spaces not included in the main part of cargo area above deck comprising 1.00 m radius spherical segments centred over the ventilation openings of the cofferdams and the service spaces located in the cargo area part below the deck and 2.00 m spherical segments centred over the ventilation openings of the cargo tanks and the opening of the pump-rooms.

Cargo piping

See "pipes for loading and unloading".

Cargo residues

means liquid cargo which cannot be removed from the cargo tank or cargo piping by discharging, draining or stripping.

Cargo tank (condition)

discharged: empty, but containing residual cargo;
empty: dry, but not gas-free;
gas-free: not containing any measurable concentration of dangerous gases or vapours.

Classification society (recognized)

means a classification society which is recognized by the competent authorities in accordance with Annex C, Chapter 2.

Competent authority

means the authority designated or recognized as such in each country and in each specific case in connection with these provisions.

Construction pressure

means the pressure on the basis of which the cargo tank or the residual cargo tank has been designed and built. This pressure generally equals the maximum working pressure.

Damage control plan

The damage control plan shall indicate the boundaries of the watertight compartments serving as the basis for the stability calculations, the openings therein with the means of closure which are to be kept closed when the vessel is under way and position of any controls thereof, and the arrangements for the correction of any list due to flooding.

Dangerous goods

means the substances and materials themselves and articles containing dangerous substances, including wastes as defined in marginal 6000 (5), and which are covered by the relevant

Annex B.2 - Part I

210 014 (cont'd) definitions (see lists of substances) for Classes 1 to 9 of ADR or which are listed as such in Part II of Annex A to ADN.

NOTE: In accordance with marginal 6002 (4) of Annex A, dangerous goods used for the propulsion of the vessels or vehicles, the operation of their special equipment, for household purposes or for maintaining safety and which are carried on board in their usual containment are not subject to the provisions of this Agreement.

Escape device (suitable)

means a respiratory protection device, designed to cover the wearer's mouth, nose and eyes, which can be easily put on and which serves to escape from a danger area.

Filling ratio

Where a filling ratio is given for a cargo tank, it refers to a percentage of the volume at a temperature of the substance of 15 °C, except where a different temperature is indicated.

Flammable gas detector

means a device allowing measuring of any significant concentration of flammable gases below the lower explosive limit and which clearly indicates the presence of higher concentrations of such gases given off by the cargo. Flammable gas detectors may be designed for measuring flammable gas only, but also for measuring both flammable gas concentrations and oxygen content. This device shall be so designed that measurements are possible without the necessity of entering the spaces to be checked.

Gases

means gases or vapours.

Gas detection system

means a fixed system capable of detecting in time significant concentrations of flammable gases given off by the cargoes at concentrations below the lower explosion limit and capable of activating the alarms.

Highest class may be assigned to a vessel when:

- the hull, inclusive of rudder and steering gear and equipment of anchors and chains, complies with the rules and regulations of a recognized classification society and has been built and tested under its supervision;
- the propulsion plant, together with the essential auxiliary engines, mechanical and electrical installations, have been made and tested in conformity with the rules and regulations of this classification society, and the installation has been carried out under its supervision, and the complete plant was tested to its satisfaction on completion.

Identification number (UN No.)

means the number for identifying a substance, material or article. These numbers are taken from the United Nations "Recommendations on the Transport of Dangerous Goods".

Annex B.2 - Part I

210 014 *Loading journal*
(cont'd)

means a journal where all activities relating to loading, unloading, cleaning, gas-freeing, delivering washing water and taking in and discharging ballast water (in cargo tanks) are recorded.

Maximum working pressure

means the maximum pressure occurring in a cargo tank or a residual cargo tank during operation. This pressure equals the opening pressure of high velocity vent valves.

Naked light

means light produced by a flame which is not enclosed in a flameproof enclosure.

Oil separator vessel

means an open type tank—vessel with a dead weight of up to 300 tonnes, constructed and fitted to accept and carry oily and greasy wastes from the operation of vessels. Vessels without cargo tanks are considered to be subject to Annex B.1.

Oily and greasy wastes from the operation of the vessel

means used oils, bilge water and other oily or greasy wastes, such as used grease, used filters, used rags, and receptacles and packagings for such wastes.

Opening pressure

means the pressure referred to in a list of substances at which the high velocity vent valves open. For pressure tanks the opening pressure of the safety valve shall be established in accordance with the requirements of the competent authority or a recognized classification society.

Oxygen meter

means a device allowing measuring of any significant reduction of the oxygen content of the air. Oxygen meters may be designed and constructed for measuring oxygen only but also for measuring flammable gases and oxygen. This device shall be so designed that such measurements are possible without the necessity of entering the spaces to be checked.

Pipes for loading or unloading (cargo piping)

means all pipes which may contain liquid or gaseous cargo, including the connected pumps, filters and closure devices.

Pressures

For tanks, all kinds of pressures (e.g. working pressure, opening pressure of the high velocity vent valves, test pressure) shall be expressed as gauge pressures in kPa (bar); the vapour pressure of substances, however, shall be expressed as an absolute pressure in kPa (bar).

Annex B.2 - Part I

210 014 *Pressure tank*
(cont'd)

means a tank designated and approved for a working pressure \geq 400 kPa (4 bar).

Rescue winch

means a device for hoisting persons from spaces such as cargo tanks, cofferdams and double-hull spaces. The device shall be operable by one person.

Residual cargo

means liquid cargo remaining in the cargo tank or cargo piping after unloading without the use of the stripping system.

Slops

means a mixture of cargo residues and e.g. washing water, rust, etc., which is either suitable or not suitable for pumping.

Steersman

means a person as defined in Article 1.02 of the European Code for Inland Waterways (CEVNI).

Stripping system (efficient)

means a system for draining the cargo tanks and stripping the cargo piping except for the cargo residues.

Supply installation (bunkering system)

means an installation for the supply of vessels with liquid fuels.

Supply vessel

means an open type N tank—vessel with a dead weight of up to 300 tonnes, constructed and fitted for the carriage and delivery to other vessels of products intended for the operation of vessels.

Tank vessel

means a vessel intended for the carriage of substances in cargo tanks.

Test pressure

means the pressure at which a cargo tank, a residual cargo tank, a cofferdam or the loading and unloading pipes shall be tested prior to being brought into service for the first time and subsequently regularly within prescribed times.

Toximeter

means a device allowing measuring of any significant concentration of toxic gases given off by the cargo.

210 014 This device shall be so designed that such measurements are possible without the necessity

Annex B.2 - Part I

(cont'd) of entering the spaces to be checked.

Type of vessel

Type G ...: means a tank vessel intended for the carriage of gases. Carriage may be under pressure or in the liquid state under refrigeration.

Type C ...: means a tank vessel intended for the carriage of liquids. The vessel shall be of the flush-deck/double-hull type with double-hull spaces, double bottoms, but without trunk. The cargo tanks may be formed by the vessel's inner hull or may be installed in the hold spaces as independent tanks.

Type N ...: means a tank vessel intended for the carriage of liquids.

Sketches (as examples)

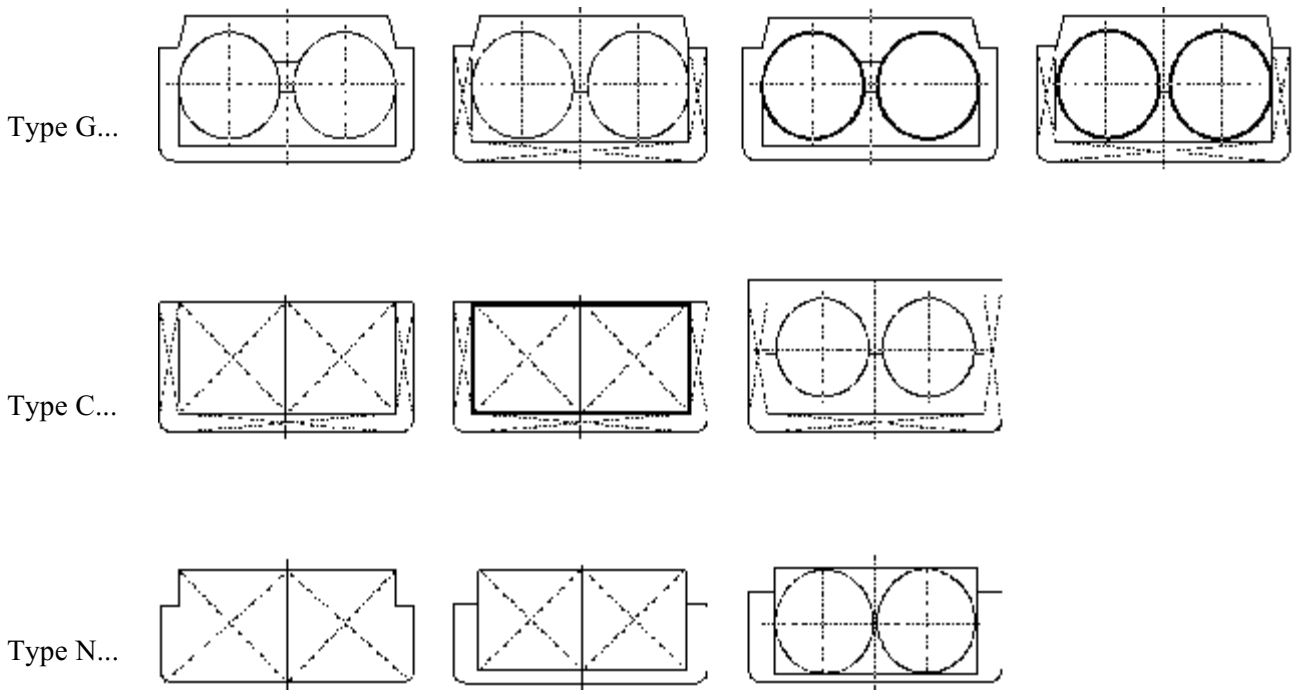

Vessel

means an inland navigation vessel or a seagoing vessel.

**210 015-
210 099**

SECTION 1. Mode of carriage of goods

**210 100-
210 120**

Annex B.2 - Part I

210 121 Carriage in cargo tanks

- (1) Substances, their assignment to the various types of tank vessels and the special conditions for their carriage in these tank vessels, are listed in Appendix 4.
- (2) Substances, which according to the list of substances of Appendix 4, have to be carried in a tank vessel of type N, open, may also be carried in a tank vessel of type N, open, with flame—arresters; type N, closed; types C or G provided that all conditions of carriage prescribed for tank vessels of type N, open, as well as all other conditions of carriage prescribed in the list of substances of Appendix 4 are met.
- (3) Substances which, according to the list of substances of Appendix 4 have to be carried in a tank vessel of type N, open, with flame—arresters, may also be carried in tank vessels of type N, closed, and types C or G provided that all conditions of carriage prescribed for tank vessels of type N, open, with flame arresters, as well as all other conditions of carriage prescribed in the list of substances of Appendix 4 are met.
- (4) Substances which, according to the list of substances of Appendix 4 have to be carried in a tank vessel of type N, closed, may also be carried in tank vessels of type C or G provided that all conditions of carriage prescribed for tank vessels of type N, closed, as well as all other conditions of carriage prescribed in the list of substances of Appendix 4 are met.
- (5) Substances which, according to the list of substances of Appendix 4 have to be carried in tank vessels of type C may also be carried in tank vessels of type G provided that all conditions of carriage prescribed for tank vessels of type C as well as all other conditions of carriage prescribed in the list of substances of Appendix 4 are met.
- (6) Oily and greasy wastes resulting from the operation of the vessel may only be carried in fire—resistant receptacles, fitted with a lid, or in cargo tanks.

**210 122-
210 199**

SECTION 2. Requirements applicable to vessels

210 200 Construction

Tank vessels carrying dangerous goods shall comply with the provisions of this Part as well as with the applicable provisions of Part II and the applicable rules for construction of Part III.

**210 201-
210 203**

210 204 Types of vessel

Distinction is made between the following types of vessel:

Type G, Type C and Type N

The relief pressure of the safety valves or of the high-velocity vent valves shall be indicated in the certificate of approval.

210 204 The design pressure and the test pressure of cargo tanks shall be indicated in the certificate of

Annex B.2 - Part I

(cont'd) the classification society prescribed in marginal 210 208.

Where a vessel carries cargo tanks with different valve-relief pressures, the relief pressure of each tank shall be indicated in the certificate of approval and the design and test pressures of each tank shall be indicated in the certificate of the classification society.

210 205 Instructions for the use of devices and installations

Where specific safety rules have to be complied with when using any device or installation, instructions for the use of the particular device or installation shall be readily available for consultation at appropriate places on board in the language normally spoken on board, and also, if that language is not English, French or German, in English, French or German unless agreements concluded between the countries concerned in the transport operation provide otherwise.

210 206 Gas detection system

The sensors of the gas detection system shall be set at not more than 20% of the lower explosive limit of the substances allowed for carriage in the vessel.

The system shall have been approved by the competent authority or a recognized classification society.

210 207

210 208 Classification

(1) Tank vessels intended for the carriage of dangerous goods shall be built under survey of a recognized classification society in accordance with the rules established by this classification society to its highest class.

This shall be confirmed by the classification society by the issue of an appropriate certificate.

(2) The vessel's class shall be continued.

(3) The classification society shall issue a certificate listing all the dangerous substances authorized for carriage in the vessel.

**210 209-
210 218**

210 219 Pushed convoys and side-by-side formations

(1) Where at least one vessel of a convoy or side-by-side formation is required to be provided with a certificate of approval in accordance with marginal 210 282, all vessels of such convoy or side-by-side formation shall be provided with an appropriate certificate of approval.

Vessels not carrying dangerous goods shall comply with the provisions of marginal 10 219 of Annex B.1.

(2) For the purposes of the application of the provisions of Parts I and II, the entire pushed convoy or side-by-side formation shall be deemed to be a single vessel.

210 219 (cont'd) (3) Vessels used for propulsion shall conform to the following rules for construction of Part III of this Annex:

Annex B.2 - Part I

marginals 210 205, 210 240 (2), 210 251, 210 260 (1) and (2), 210 280 (1) and (3), 210 282 (1) to (8), 210 283 (1) and (2), 331 200 (1), (3)(d) and (5), 331 210 (1) and (2), 331 212 (3) and (5), 331 216 (1) and (2), 331 217 (1) to (4), 331 231 (1) to (5), 331 232 (2), 331 234 (1) and (2), 331 240 (1) and (2), 331 241 (1) to (3), 331 250 (1) (c) and (2), 331 251 (1) to (3), 331 252 (3) (a) and (b), (4) to (6), 331 256 (5), 331 271 and 331 274 (1) to (3).

However, for the application of marginal 331 240 (1), one single fire or ballast pump shall be sufficient.

**210 220-
210 239**

210 240 Fire-extinguishing arrangements

(1) In addition to the fire-extinguishing appliances prescribed in marginal 210 001 (1), each vessel shall be equipped with at least two additional hand fire-extinguishers having the same capacity. The fire-extinguishing agent contained in these additional hand fire-extinguishers shall be suitable for fighting fires involving the dangerous goods carried.

(2) The fire-extinguishing agent contained in fixed fire-extinguishing systems shall be suitable and sufficient in quantity for fighting fires.

**210 241-
210 250**

210 251 Electrical installations

The insulation resistance of the electrical installations, the earthing and the flameproof electrical equipment shall be inspected whenever the certificate of approval is renewed and, in addition, within the third year from the date of issue of the certificate of approval by a person authorized for this purpose by the competent authority. An appropriate inspection certificate shall be kept on board.

**210 252-
210 259**

210 260 Special equipment

(1) When this is required in Part II, the following equipment shall be available on board:

- (a) for each member of the crew, a pair of protective goggles, a full face mask with suitable respirator, a pair of protective gloves and boots, and a protective suit;
- (b) a suitable escape device for each person on board;
- (c) two self-contained breathing apparatus;
- (d) two safety harnesses;
- (e) a rescue winch;
- (f) a flammable gas detector with the instructions for its use;

**210 260
(cont'd)**

Annex B.2 - Part I

- (g) a toximeter with the instructions for its use.

Materials and additional protective equipment specified by the consignor in the instructions shall be provided by the consignor and shall be available on board.

- (2) For pushed convoys or side-by-side formations under way, it shall be sufficient, however, if the pusher tug or the vessel propelling the formation is equipped with the special equipment referred to in (1) above, when this is required in Part II.

**210 261-
210 279**

210 280 Checking and inspection of equipment

- (1) The fire-extinguishing appliances and hoses shall be inspected at least once every two years by persons authorized for this purpose by the competent authority.
- (2) The pipes for loading and unloading shall be inspected once a year by persons authorized for this purpose by the competent authority.
- (3) The special equipment referred to in marginal 210 260 (1) and the gas detection system shall be inspected in accordance with the instructions of the manufacturer concerned either by the manufacturer himself or by persons authorized for this purpose by the competent authority.

210 281

210 282 Certificate of approval

- (1) Any tank vessel carrying dangerous goods and vessels referred to in marginal 210 219 (3) shall be provided with an appropriate certificate of approval.
- (2) The certificate of approval shall attest that the vessel has been inspected and that its construction and equipment comply with the applicable provisions of this Annex.
- (3) The certificate of approval shall be issued in accordance with the requirements and procedures set out in Annex C.

It shall conform to model No. 1 in Appendix 1 of this Annex.

- (4) The certificate of approval shall be valid for not more than five years. The date on which the period of validity expires shall be shown on the certificate. The competent authority which issued the certificate may, without inspection of the vessel, extend the validity of the certificate by not more than one year. Such extension may be granted only once within two periods of validity.

**210 282
(cont'd)**

- (5) If the vessel's hull or equipment has undergone alterations liable to reduce the safety as regards the carriage of dangerous goods or has sustained damage affecting such safety, the vessel shall undergo a further inspection in accordance with (3) above without delay.

Annex B.2 - Part I

(6) The certificate of approval may be withdrawn if the vessel is not properly maintained or if the vessel's construction or equipment no longer complies with the applicable provisions of this Annex.

(7) The certificate of approval may only be withdrawn by the authority by which it has been issued.

Nevertheless, in the cases referred to in (5) and (6) above, the competent authority of the State in which the vessel is staying may prohibit its use for the carriage of those dangerous goods for which the certificate is required. For this purpose it may withdraw the certificate until such time as the vessel again complies with the applicable provisions of this Annex. In that case it shall notify the competent authority which issued the certificate.

(8) Notwithstanding (7) above, any competent authority may amend or withdraw the certificate of approval at the request of the vessel's owner, provided that it so notifies the competent authority which issued the certificate.

210 283 Provisional certificate of approval

(1) For a vessel which is not provided with a certificate of approval, a provisional certificate of approval of limited duration may be issued in the following cases, subject to the following conditions:

- (a) The vessel complies with the applicable provisions of this Annex, but the certificate of approval could not be issued in time. The provisional certificate of approval shall be valid for an appropriate period but not exceeding three months.
- (b) The vessel does not comply with every applicable provisions of this Annex after sustaining damage. In this case the provisional certificate of approval shall be valid only for a single specified voyage and for a specified cargo. The competent authority may impose additional conditions.

(2) The provisional certificate of approval shall conform to model No. 2 in Appendix 1 to this Annex.

210 284 Loading journal

All tank vessels shall be provided with a loading journal. The original of the loading journal shall be kept on board for not less than 12 months after the last entry is made.

The first loading journal shall be issued by the authority which issued the certificate of approval. Subsequent journals may be issued by authorities competent to do so.

**210 285-
210 299**

SECTION 3. General service requirements

210 300

Annex B.2 - Part I

210 301 Access to cargo tanks, residual cargo tanks, cargo pump-rooms below deck, cofferdams, double-hull spaces, double bottoms and hold spaces; inspections

(1) The cofferdams shall be empty. They shall be inspected once a day in order to ascertain that they are dry (except for condensation water).

(2) Access to the cargo tanks, residual cargo tanks, cofferdams, double-hull spaces, double bottoms and hold spaces is not permitted except for carrying out inspections or cleaning operations.

(3) Access to the double-hull spaces and the double bottoms is not permitted while the vessel is under way.

(4) When the gas concentration has to be measured before entry into cargo tanks, residual cargo tanks, cargo pump-rooms below deck, cofferdams, double hold spaces, double bottoms or hold spaces, the results of these measurements shall be recorded in writing.

The measurement may only be effected by persons equipped with breathing apparatus suited to the substance carried.

Entry into these spaces is not permitted for the purpose of measuring.

210 302 Cargo pump-rooms below deck

The cargo pump-rooms below deck shall be inspected daily so as to ascertain that there are no leaks. The bilges and the drip pans shall be kept clean and free from products.

**210 303-
210 305**

210 306 Gas detection system

The gas detection system shall be maintained and calibrated in accordance with the instructions of the manufacturer.

210 307 Gas-freeing of empty cargo tanks

(1) Empty or unloaded cargo tanks having previously contained dangerous goods of Class 2, Class 3, 5° and 11° to 19°, Class 6.1 or Class 8, letter (a) of all items, may only be gas-freed at the locations designated or approved for such purpose by the competent authority. Gas-freeing may be carried out only by competent persons or companies approved for that purpose.

(2) Gas-freeing of empty or unloaded cargo tanks having contained dangerous goods other than those referred to under (1) above, may be carried out while the vessel is under way by means of suitable venting equipment with the tank lids closed and by leading the gas/air mixtures through the flame-arresters, provided that in normal conditions of operation, the product concentration in the vented mixture at the outlet is less than 50% of the lower explosive limit. The suitable venting equipment may be used for gas-freeing by extraction

Annex B.2 - Part I

210 307 (cont'd) only when a flame arrester is fitted immediately before the ventilation fan on the extraction side. During normal operation, the gas concentration in the mixture at the outlet shall be less than 50% of the lower explosive limit. The gas concentration shall be measured once each hour during the two first hours after the beginning of the gas-freeing operation by forced ventilation or by extraction, by an expert referred to in marginal 210 315. The results of these measurements shall be recorded in writing.

Gas-freeing is, however, prohibited within the area of locks including their lay-bys.

(3) Where gas-freeing of cargo tanks having previously contained the dangerous goods referred to in (1) above is not practicable at the locations designated or approved for this purpose by the competent authority, gas-freeing may be carried out while the vessel is under way, provided that :

- the requirements of paragraph (2) are complied with; the concentration of dangerous substances in the vented mixture at the outlet shall, however, be not more than 10% of the lower explosive limit;
- there is no risk involved for the crew;
- any entrances or openings of spaces connected to the outside are closed; this provision does not apply to the air supply openings of the engine room and overpressure installations;
- any member of the crew working on deck is wearing suitable protective equipment;
- it is not carried out within the area of locks including their lay-bys, under bridges or within densely populated areas.

(4) Gas-freeing operations shall be interrupted when, due to unfavourable wind conditions, dangerous concentrations of gases are to be expected outside the cargo area in front of accommodation, the wheelhouse and service spaces. The critical state is reached as soon as concentrations of more than 20% of the lower explosive limit have been detected in those areas by measurements by means of portable equipment.

(5) The marking prescribed in marginal 210 500 may be withdrawn when, after gas-freeing of the cargo tanks, it has been ascertained, using the equipment described in marginal 210 260 (1) (f) or (g), that the cargo tanks no longer contain flammable gases in concentrations of more than 10% of the lower explosive limit or do not contain any significant concentration of toxic gases.

210 308 Repair and maintenance work

No repair or maintenance work liable to cause sparks or requiring the use of an open flame or electric current shall be undertaken unless permission has been given by the competent authority or a certificate attesting gas-free condition has been issued for the vessel.

210 308 (cont'd) In the service spaces outside the cargo area repair and maintenance work may be undertaken, provided the doors and openings are closed and the cargo tanks are not being loaded, unloaded or gas-freed.

The use of chromium vanadium steel screw drivers and wrenches is permitted.

Annex B.2 - Part I

210 309-
210 311

210 312 Ventilation

(1) While the machinery in the service spaces is operating, the extension ducts connected to the air inlets, if any, shall be in the upright position; otherwise the inlets shall be closed. This provision does not apply to air inlets of service spaces outside the cargo area, provided the inlets without extension duct are located not less than 0.50 m above the deck.

(2) The ventilation of pump rooms shall be in operation:

- at least 30 minutes before entry and during occupation;
- during loading, unloading and gas-freeing; and
- after the gas detection system has been activated.

210 313-
210 314

210 315 Dangerous goods training

(1) An expert shall be on board the vessel. This person shall not be less than 18 years of age.

(2) An expert is a person who has a special knowledge of the ADN. Proof of this knowledge shall be furnished by means of a certificate from a competent authority or from an agency recognized by the competent authority.

This certificate shall be issued to persons who, after training, have successfully passed a qualifying ADN examination. The training shall be approved by the competent authority.

The certificate shall conform to model No. 3 of Appendix 1 to this Annex.

(3) The training programme shall comprise at least the subjects listed below and the training shall include practical exercises:

- (a) General provisions concerning the carriage of dangerous goods, e.g. with respect to contents of ADN, temperature, mass, quantity, concentration, degree of filling, calculation of contents, liquid-level gauging, sampling, check list, overfilling, pumping, marking of vessels, labelling of packages, instructions in writing;
- (b) Definition of terms (e.g. liquids, solids, viscosity, gases and vapours), basic knowledge of products;

210 315
(cont'd)

- (c) Nature of risks such as combustion, explosion, sources of ignition, electrostatic charge, toxicity, radioactivity, corrosivity, danger to the aquatic environment;
- (d) Measures to avoid accidents, prevention of explosion;
- (e) Measures to be taken in the event of an accident or an incident (first aid, "keep-off" signal, emergency call, safety of traffic, use of appliances such as fire-extinguishers and personal protective equipment, etc.);

Annex B.2 - Part I

- (f) Tasks of the crew and of the expert with respect to the carriage of dangerous goods;
- (g) Equipment of vessels carrying dangerous goods e.g flammable gas detector, oxygen meters and toximeters; tests to be carried out before entering spaces; certificates attesting a gas-free condition;
- (h) Practical exercises, in particular with respect to entry into spaces, use of fire-extinguishers, fire-fighting equipment and personal protective equipment as well as flammable gas detectors, oxygen meters and toximeters.

(4) Every competent authority or agency recognized by that competent authority may determine the procedures and syllabus of the qualifying examination according to (2) above on the basis of the subjects listed in (3) above, letters (a) to (g) and of Annex C, Chapter 6.

(5) The certificate referred to in (2) above shall be valid for a period of five years and may be extended if proof is furnished of participation in a refresher or advanced training course recognized by the competent authority, which is based on the programme referred to in (3) above and which comprises, in particular, current new developments. The refresher or advanced training course shall be taken in the last year prior to the expiry of the certificate. When the refresher or advanced training course is taken in the year preceding the date of expiry of the certificate, the new period of validity shall begin on the expiry date of the preceding certificate; in other cases it shall begin on the date of the certificate of participation in the course.

210 316

210 317 Knowledge of gases

(1) An expert for the carriage of gases shall be on board when the carried are goods which may be carried in Type G vessels only.

(2) An expert for the carriage of gases is an expert person in accordance with marginal 210 315 having a specific knowledge of the carriage of gases in tank vessels. Proof of this knowledge shall be furnished by means of a certificate from a competent authority or from an agency recognized by the competent authority.

This certificate shall be issued to persons who, after training, have successfully passed a qualifying examination concerning the carriage of gases and who may produce evidence of not less than one year work on board a Type G vessel during a period of two years prior to or after the examination. The training shall be approved by the competent authority.

The certificate shall conform to model No. 3 in Appendix 1 to this Annex.

**210 317
(cont'd)**

(3) The training programme shall comprise at least the subjects listed below and the training shall include practical exercises:

- (a) Common properties of gases:

compressibility, mixtures and partial pressures, expansion at constant pressure, laws of Boyle-Mariotte and Gay-Lussac, relative density, volume; density and critical pressure;

- (b) Purging and sampling of gases;

Annex B.2 - Part I

- (c) Explosion hazards presented by liquefied gases (e.g. LPG);
- (d) Measurement of gas concentration, tests to be carried out before entering spaces, certificates attesting a gas-free condition;
- (e) Knowledge of products:
chemical and physical properties, mixtures, compounds and chemical formulae – hydrocarbons, ammonia-;
- (f) Liquids and vapours:
evaporation and condensation, relation between liquid volume and vapour volume;
- (g) Action to be taken in case of emergency;
- (h) Operational procedures:
loading and discharging, quick-action stop valve systems, effects of temperature, filling ratios, overfilling, compressors, pumps, functioning of excess flow valves, leakage;
- (i) Participation in appropriate fire-fighting drills and appropriate training in the use of protective breathing apparatus.

(4) Every competent authority or agency recognized by the competent authority may determine the procedures and syllabus of the qualifying examination according to (2) above on the basis of the subjects listed in (3) above and of Annex C, Chapter 6.

(5) The certificate referred to in (2) above shall be valid for a period of five years and may be renewed if:

- proof is furnished of the participation in a refresher or advanced training course recognized by the competent authority, which is based on the programme referred to in (3) above and which comprises, in particular, current new developments. The refresher or advanced training course shall be taken in the last year prior to the expiry of the certificate; or if
- proof is furnished of not less than one year's work on board a Type G vessel during the preceding two years.

210 317 (cont'd) The new period of validity shall begin on the expiry date of the preceding certificate.

(6) The document attesting training and experience in accordance with the requirements of Chapter V of the STCW Code on Training and Qualifications of Masters, Officers and Ratings of Tankers shall be equivalent to the certificate referred to in (2) above, provided it has been recognized by a competent authority. No more than five years shall have passed since the date of issue or renewal of such a document.

210 318 Knowledge of chemicals

(1) An expert for the carriage of chemicals shall be on board when goods carried are goods which may be carried in Type C vessels only.

Annex B.2 - Part I

(2) An expert for the carriage of chemicals is an expert in accordance with marginal 210 315 having a specific knowledge of the carriage of chemicals in tank vessels. Proof of this knowledge shall be furnished by means of certificate from a competent authority or from an agency recognized by the competent authority.

This certificate shall be issued to persons who, after training, have successfully passed a qualifying examination concerning the carriage of chemicals and who may produce evidence of not less than one year's work on board a Type C vessel during a period of two years prior to or after the examination. The training shall be approved by the competent authority.

The certificate shall conform to model No. 3 in Appendix 1 to this Annex.

(3) The training programme shall comprise at least the subjects listed below and the training shall include practical exercises:

- (a) Common properties of gases and vapours:
compressibility, mixtures, expansion at constant pressure, laws of Boyle-Mariotte and Gay-Lussac, vapour/density ratio and boiling point, relative density, volume;
- (b) Sampling of chemicals;
- (c) Explosion hazards presented by chemicals;
- (d) Measurement of gas concentration, cargo tank-washing, gas-freeing, venting, tests to be carried out before entering spaces, certificates attesting a free gas condition;
- (e) Knowledge of products:
chemical and physical properties, mixtures, compounds and chemical formulae—hydrocarbons, toxic substances, acids and alkalis—polymerization and oxidation;
- (f) Liquids and vapours:
evaporation and condensation, relation between liquid volume and vapour volume;
- (g) Action to be taken in case of emergency;
- (h) Operational procedures:
loading and discharging, vapour recovery systems, quick-action stop valve systems, effects of temperature, filling ratios, overfilling, types of pump, contamination;
- (i) Participation in appropriate fire-fighting drills and appropriate training in the use of protective breathing apparatus.

**210 317
(cont'd)**

(4) Every competent authority or agency recognized by the competent authority may determine the procedures and syllabus of the qualifying examination according to (2) above on the basis of the subjects listed in (3) above and of Annex C, Chapter 6.

(5) The certificate referred to in (2) above shall be valid for a period of five years and may

Annex B.2 - Part I

be renewed if:

- proof is furnished of the participation in a refresher or advanced training course recognized by the competent authority, which is based on the programme referred to in (3) above and which comprises, in particular, current new developments. The refresher or advanced training course shall be taken in the last year prior to the expiry of the certificate; or if
- proof is furnished of not less than one year's work on board a Type C vessel during the preceding two years.

The new period of validity shall begin on the expiry date of the preceding certificate.

(6) The document attesting training and experience in accordance with the STCW Convention and the requirements of Chapter V of the STCW Code on Training and Qualifications of Masters, Officers and Ratings of Tankers shall be equivalent to the certificate referred to in (2) above, provided it has been recognized by a competent authority. No more than five years shall have passed since the date of issue or renewal of such a document.

210 319

210 320 Water ballast

(1) Cofferdams and hold spaces containing insulated cargo tanks shall not be filled with water. Double-hull spaces, double bottoms and hold spaces may be filled with ballast water provided the cargo tanks have been discharged.

If the cargo tanks are not empty, double-hull spaces and double bottoms may be filled with ballast water provided this has been taken into account in the damage-control plan and the ballast tanks are not filled to more than 90% of their capacity and provided this is not prohibited in the list of substances of Appendix 4.

(2) Where ballast water is discharged from cargo tanks, an appropriate entry shall be made in the loading journal.

210 321

210 322 Entrances to hold spaces, cargo pump-rooms below deck, cofferdams, opening of cargo tanks and residual cargo tanks; closing devices

The cargo tanks, residual cargo tanks and entrances to cargo pump-rooms below deck, cofferdams and hold spaces shall remain closed. This requirement shall not apply to cargo pump-rooms on board oil separator and supply vessels or to the other exceptions set out in this Annex.

**210 323-
210 324**

Annex B.2 - Part I

210 325 Connections between pipes

- (1) Connecting two or more of the following groups of pipes is prohibited:
 - (a) pipes for loading and unloading;
 - (b) pipes for ballasting and draining cargo tanks, cofferdams, hold spaces, double-hull spaces and double bottoms;
 - (c) pipes located outside the cargo area.
- (2) The provision of paragraph (1) above does not apply to removable pipe connections between cofferdam pipes and
 - pipes for loading and unloading;
 - pipes located outside the cargo area while the cofferdams have to be filled with water in case of emergency.

In these cases the connections shall be designed so as to prevent water from being drawn from the cargo tanks. The cofferdams shall be emptied only by means of eductors or an independent system within the cargo area.

- (3) Paragraphs (1) (b) and (c) above do not apply to:
 - pipes intended for ballasting and draining double-hull spaces and double bottoms which have no common boundary with the cargo tanks;
 - pipes intended for ballasting hold spaces where the pipes of the fire-fighting system within the cargo area are used for this purpose. Hold spaces shall be stripped only by means of eductors or an independent system within the cargo area.

210 326

210 327 Persons authorized on board

- (1) Only the following persons are authorized to be on board:

**210 327
(cont'd)**

- (a) members of the crew;
 - (b) persons who, although not being members of the crew, normally lived on board; and
 - (c) persons who are on board for official reasons.
- (2) The persons referred to in (1) (b) above are not authorized to remain in the cargo area except for short periods.

210 328

Annex B.2 - Part I

210 329 Lifeboats

(1) The lifeboat required in accordance with the requirements set out in marginal 10 001 (1) shall be stowed outside the cargo area. The lifeboat may, however, be stowed in the cargo area provided an easily accessible collective life-saving appliance conforming to the requirements set out in marginal 10 001 (1) is available within the accommodation area.

(2) Paragraph (1) above does not apply to oil separator or supply vessels.

210 330

210 331 Engines

(1) The use of engines running on fuels having a flashpoint below 55 °C (e.g. petrol engines) is prohibited. This requirement does not apply to the outboard motors of lifeboats.

(2) The carriage of power-driven conveyances such as passenger cars and motor boats in the cargo area is prohibited.

210 332 Oil fuel tanks

Double bottoms with a height of at least 0.6 m may be used as oil fuel tanks, provided they have been constructed in accordance with Part III.

**210 333-
210 339**

210 340 Fire-extinguishing arrangements

The crew shall have been trained in the use of the fire-extinguishing systems and the fire-extinguishing appliances.

210 341 Fire and naked light

(1) The use of fire or naked light is prohibited.

This provision does not apply to the accommodation and the wheelhouse.

(2) Heating, cooking and refrigerating appliances shall not be fuelled with liquid fuels, liquid gas or solid fuels.

210 341 (cont'd) Cooking and refrigerating appliances may only be used in the accommodation and in the wheelhouse.

(3) Heating appliances or boilers fuelled with liquid fuels having a flashpoint above 55 °C which are installed in the engine room or in an other suitable space may, however, be used.

210 342 Cargo heating system

(1) Heating of the cargo is not permitted except where there is a risk of solidification of the cargo or where the cargo, because of its viscosity, cannot be unloaded in the usual manner.

In general, a liquid shall not be heated up to a temperature above its flashpoint.

Annex B.2 - Part I

Special provisions are included in the list of substances of Appendix 4 to this Annex.

(2) Cargo tanks containing substances which are heated during transport shall be equipped with devices for measuring the temperature of the cargo.

(3) During unloading, the cargo heating system may be used provided that the space where it has been installed meets in all respects the provisions of marginal 321 252 (3) (b) or 331 252 (3) (b).

(4) The provisions of paragraph (3) above do not apply when the cargo heating system is supplied with steam from shore and only the circulation pump is in operation, as well as when the flashpoint of the cargo being unloaded is not less than 61 °C.

210 343

210 344 Cleaning operations

The use of liquids having a flashpoint below 55 °C for cleaning purposes is permitted only in the cargo area.

**210 345-
210 350**

210 351 Electrical installations

(1) The electrical installations shall be properly maintained in a faultless condition.

(2) The use of movable electric cables is prohibited in the cargo area.

This provision does not apply to:

- intrinsically safe electric circuits;
- electric cables for connecting signal lights or gangway lighting, provided the socket is permanently fitted to the vessel close to the signal mast or gangway;
- electric cables for connecting submerged pumps on board oil separator vessels.

210 351 (cont'd) (3) The sockets for connecting the signal lights and gangway lighting or for submerged pumps on board oil separator vessels shall not be live except when the signal lights or the gangway lighting or the submerged pumps on board oil separator vessels are switched on.

Connecting or disconnecting shall not be possible except when the sockets are not live.

**210 352-
210 353**

210 354 Portable lamps

The only portable lamps permitted in the cargo area and on deck outside the cargo area are electric lamps having their own source of power. They shall, at least, be of the "certified safe type".

Annex B.2 - Part I

**210 355-
210 359**

210 360 Special equipment

(1) The crew shall be familiar with the use of the special equipment referred to in marginal 210 260 (1).

(2) Persons who have to wear the breathing apparatus in accordance with marginal 221 301 (2), 231 301 (2), 261 301 (2), 281 301 (2) or 291 301 (2) of Part II of this Annex when entering cargo tanks, residual cargo tanks, cargo pump-rooms below deck, cofferdams, double-hull spaces, double bottoms or hold spaces shall have been trained in the use of such apparatus and shall have been capable of withstanding the additional physical strain.

**210 361-
210 370**

210 371 Admittance on board

(1) No unauthorized person shall be permitted on board. This prohibition shall be displayed on notice boards at appropriate places.

(2) When the vessel is required to be marked with two blue cones or two blue lights in accordance with marginal 210 500, no persons under 14 years of age shall be permitted on board.

**210 372-
210 373**

210 374 Prohibition of smoking

Smoking on board the vessel is prohibited. This prohibition shall be displayed on notice boards at appropriate places.

This prohibition does not apply to the accommodation or the wheelhouse provided their windows, doors, skylights and hatches are closed.

210 375 Risk of sparking

Work liable to cause sparking is prohibited in the cargo area. This provision does not apply to mooring work.

**210 376-
210 379**

210 380 Checking of equipment

The measuring instruments prescribed by this Annex shall be checked each time before use by the user in accordance with the instructions for use.

Annex B.2 - Part I

210 381 Documents

(1) In addition to the documents required by other regulations, the following documents shall be kept on board:

- (a) The vessel's certificate of approval;
- (b) Transport documents (see marginal 6002 (6));
The transport documents shall cover all dangerous goods on board;
- (c) The instructions in writing referred to in marginal 210 385 for all dangerous goods on board;
- (d) The loading journal required by marginal 210 284;
- (e) A copy of the ADN with its Annexes A, B.1 and B.2 (at least Annex A and Annex B.2) and its Annexes C, D.1 and D.2;
- (f) The certificate referred to in marginal 210 315 and, where applicable, marginal 210 317 or marginal 210 318;
- (g) A book in which all required measurement results are recorded;
- (h) For vessels which have to conform to the conditions of damage-control, the damage-control plan;
- (i) The documents concerning intact stability as well as all conditions of intact stability taken into account for the damaged stability calculation in a form the steersman understands;
- (j) The documents concerning electrical installations prescribed in marginals 311 250 (1), 321 250 (1) or 331 250 (1);
- (k) The classification certificate;
- (l) Certificate referred to in marginals 311 208 (2) or (3), 321 208 (2) or (3) or 331 208 (2) or (3);

**210 381
(cont'd)**

- (m) In the event of the carriage of goods having a melting point of 0 °C or above, heating instructions.

(2) The transport documents and the instructions in writing shall be given to the steersman before loading. The gross mass may be entered after loading.

(3) Where an inspection or examination is prescribed in this Annex, the following additional documents shall also be kept on board:

- (a) The valid inspection documents for the fire-extinguishing appliances, fire-hoses, electrical appliances and, if required, for the special equipment.

Particulars of the inspection shall be marked on the fire-extinguishing appliances as a proof of inspection;

Annex B.2 - Part I

- (b) The valid inspection documents for the cargo hoses;
- (c) The valid certificate for the test of the stripping system according to Model No. 3 in Appendix 3 to this Annex.

(4) For tank vessels with empty cargo tanks or cargo tanks that have been discharged, the steersman is deemed to be the consignor for the purpose of the transport documents required. In this case, the following particulars shall be entered on the transport document for each empty cargo tank or cargo tank that has been discharged:

- number of cargo tank;
- name of the substance previously carried, class and item number and, if applicable, the letter in accordance with marginal 6002 (6).

(5) Paragraphs (1) (b) and (g), (2) and (4) do not apply to oil separator or supply vessels. Paragraph (1) (c) does not apply to oil separator vessels.

**210 382-
210 384**

210 385 Instructions in writing

(1) For the action to be taken in the event of an accident or incident, the steersman shall be supplied by the consignor with instructions in writing specifying concisely:

- (a) The nature of the danger presented by the dangerous goods carried and the safety measures that need to be taken to avert it;
- (b) The action to be taken and the treatment to be given if the event of any person coming into contact with the goods being carried or with any substances which might be expelled from them;
- (c) The measures to be taken in case of fire and the fire extinguishing agents or groups of agents to be used or not to be used to fight the fire;

**210 385
(cont'd)**

- (d) The measures to be taken in case of breakage or other deterioration of the tanks or release of the dangerous goods being carried, in particular where such dangerous goods have spilled; and
- (e) The materials and additional protective equipment if the special equipment referred to in marginal 210 260 (1) is not sufficient.

(2) Instructions shall be provided for each dangerous substance carried. These instructions in writing shall be supplied by the consignor and handed to the steersman before loading. The consignor is held responsible for the content of the instructions in writing. These instructions shall be drawn up in a language the steersman is able to read and understand and in at least each of the languages of the States concerned by the transport operation.

(3) The steersman shall bring these instructions to the attention of the persons on board to enable them to carry them out. They shall be kept readily at hand in the wheelhouse and clearly separated from those instructions which are not applicable.

Annex B.2 - Part I

(4) Paragraphs (1) to (3) above shall not apply to oil separator vessels.

**210 386-
210 399**

SECTION 4. Additional requirements concerning loading, carriage, unloading and other handling of cargo

210 400

210 401 Limitation of the quantities carried

(1) The carriage of packages in the cargo area is prohibited. This prohibition does not apply to:

- residual cargo, cargo residues and slops in approved intermediate bulk containers or tank—containers having a maximum individual capacity of not more than 2.00 m³; not more than six such intermediate bulk containers or tank—containers, however, shall be carried. These intermediate bulk containers or tank—containers shall be properly secured in the cargo area and shall comply with the provisions of marginal 321 226 or 331 226 for the reception of residual cargo, cargo residues or slops;
- to cargo samples, up to a maximum of 30, of substances listed in the annex to the certificate of approval, where the maximum contents are 500 ml per receptacle. Receptacles for samples shall be placed on board, at a specific point in the cargo area, such that under normal conditions of carriage they cannot break or be punctured and their contents cannot spill in the hold space. Fragile receptacles shall be suitably padded.

(2) On board oil separator vessel receptacles with a maximum capacity of 2.00 m³ oily and greasy wastes resulting from the operation of vessels may be placed in the cargo area provided that these receptacles are properly secured.

210 401 (cont'd) (3) On board supply vessel packages of dangerous goods may be carried in the cargo area up to a gross quantity of 5,000 kg provided that this possibility is mentioned in the certificate of approval. The packages shall be properly secured and shall be protected against heat, sun and bad weather.

210 402 Reception of oily and greasy wastes resulting from the operation of vessels and delivery of products for the operation of vessels

(1) The reception of unpackaged liquid oily and greasy wastes resulting from the operation of vessels may only be effected by suction.

(2) The landing and reception of oily and greasy wastes may not take place during the loading and unloading of substances for which protection against explosion is required in the list of substances (Annex 4) nor during the gas—freeing of tank vessels. This requirement does not apply to oil separator vessels provided that the provisions for protection against explosion applicable to the dangerous substance are complied with.

Annex B.2 - Part I

(3) Berthing and handing over of products for the operation of vessels shall not take place during the loading or unloading of substances for which protection against explosions is required in the list of substances (Annex 4) nor during the gas-freeing of tank vessels. This requirement does not apply to supply vessels provided that the provisions for protection against explosion applicable to the dangerous substance are complied with.

(4) The competent authority may issue derogations to the requirements of paragraphs (1) and (2) above.

**210 403-
210 406**

210 407 Places of loading and unloading

(1) Tank vessels shall be loaded, unloaded or gas-freed only at the places designated or approved for this purpose by the competent authority.

(2) The reception of unpackaged oily and greasy liquid wastes resulting from the operation of vessels and the handing over of products for the operation of vessels shall not be taken to be loading or unloading within the meaning of paragraph (1) above.

210 408

210 409 Cargo transfer operations

Partial or complete cargo transfer without permission from the competent authority is prohibited outside a cargo transfer place approved for this purpose.

210 410 Check list

(1) Loading or unloading shall not be started before a check list for the cargo in question has been completed; the answers to the questions contained in this list shall be satisfactory. The list shall be completed in duplicate and signed by the steersman and the person responsible for the handling at the shore facilities.

**210 410
(cont'd)**

(2) The list shall conform to the model in Appendix 2 to this Annex.

(3) The list shall be printed at least in languages understood by the steersman and the person responsible for the handling at the shore facilities.

(4) Paragraphs (1) to (3) above shall not apply to the reception of oily and greasy wastes by oil separator vessels nor to the handing over of products for the operation of vessels by supply vessels.

210 411 Loading journal

(1) The steersman shall record without delay in a loading journal all activities relating to loading, unloading, cleaning, gas-freeing, discharge of washing water and reception or discharge of ballast water (in cargo tanks). The goods shall be described as in the transport document (name of substance, class, item number, letter and, when applicable, substance identification number).

(2) The steersman shall enter on a cargo stowage plan the goods carried in the individual

Annex B.2 - Part I

cargo tanks. The goods shall be described as in the transport document (name of substance, class, item number, letter and, where applicable, identification number).

210 412

210 413 Measures to be taken before loading

(1) When residues of the previous cargo may cause dangerous reactions with the next cargo, any such residues shall be properly removed.

(2) Before the start of loading operations, any prescribed safety and control devices and any items of equipment shall, if possible, be checked and controlled for their proper functioning.

(3) Before the start of loading operations the overflow control device switch shall be connected to the shore installation.

210 414 Cargo handling and stowage

Dangerous goods shall be loaded in the cargo area.

210 415 Measures to be taken after unloading

(1) After each unloading operation the cargo tanks and the cargo piping shall be emptied by means of the stripping system in accordance with the conditions laid down in the testing procedure. This provision need not be complied with if the new cargo is the same as the previous cargo.

Residual cargo shall be discharged ashore by means of the equipment provided to that effect or shall be stored in the vessel's own residual cargo tank or stored in intermediate bulk containers or tank-containers permitted according to marginal 210 401.

210 415 (cont'd) (2) After additional stripping, cargo tanks and pipes for loading and unloading shall, if necessary, be cleaned and gas-freed by persons or companies approved for this purpose by the competent authority in places approved for this purpose.

210 416 Measures to be taken during loading, carriage, unloading and handling

(1) The loading rate and the maximum operational pressure of the cargo pumps shall be determined in agreement with the personnel at the shore installation.

(2) All safety or control devices required in the cargo tanks shall remain switched on. During carriage this provision is only applicable for the installations mentioned in marginals 311 221 (1) (e) and (f), 321 221 (1) (e) and (f) or 331 221 (1) (e) and (f).

In the event of a failure of a safety or control device, loading or unloading shall be suspended immediately.

When a cargo pump-room is located below deck, the prescribed safety and control devices in the cargo pump-room shall remain permanently switched on.

Annex B.2 - Part I

Any failure of the gas detection system shall be immediately signalled in the wheelhouse and on deck by a visual and audible warning.

(3) The shut-off devices of the cargo piping as well as of the pipes of the stripping systems shall remain closed except during loading, unloading, stripping, cleaning or gas-freeing operations.

(4) If the vessel is fitted with a transverse bulkhead according to marginals 311 225 (3), 321 225 (3) or 331 225 (3), the doors in this bulkhead shall be closed during loading and unloading.

(5) Receptacles intended for recovering possible liquid spillage shall be placed under connections to shore installations used for loading and unloading. This requirement shall not apply to the carriage of goods of Class 2.

(6) In case of recovery of the gas-air mixture from shore into the vessel, the pressure at the connection point shall not be more than the opening pressure of the high velocity vent valve.

(7) Persons entering the premises located in the below deck cargo area during loading or unloading shall wear the equipment referred to in marginal 210 260 (1) (a) if this equipment is prescribed in Part II.

Persons connecting or disconnecting the loading and unloading pipes, the vapour pipes or taking samples shall wear the equipment referred to in marginal 210 260 (1) (a) if this equipment is prescribed in Part II.

210 417 Closing of windows and doors

(1) During loading, unloading and gas-freeing operations, all entrances which are accessible from the deck and all openings of spaces facing the outside shall remain closed. This provision does not apply to:

210 417 (cont'd)

- air intakes of running engines;
- ventilation inlets of engine rooms while the engines are running;
- air intakes of the overpressure ventilation system referred to in marginals 311 252 (3) (b), 321 252 (3) (b) or 331 252 (3) (b);
- air intakes of air conditioning installations if these openings are fitted with a gas detection system referred to marginals 311 252 (3) (b), 321 252(3) (b) or 331 252 (3) (b).

These entrances and openings may only be opened when necessary and for a short time, after the steersman has given his permission.

(2) After the loading, unloading and gas-freeing operations, the spaces which are accessible from the deck shall be ventilated.

(3) Paragraphs (1) and (2) above shall not apply to the reception of oily and greasy wastes resulting from the operation of vessels nor to the handing over of products for the operation of vessels.

Annex B.2 - Part I

210 418 Monitoring of gaseous phases in cargo tanks and adjacent empty spaces

(1) For the gaseous phases of tanks, inerting or blanketing may be necessary. These are defined as follows:

- Inerting: cargo tanks and their piping and other spaces for which this process is prescribed in this Annex are filled with gases or vapours which prevent combustion, do not react with the cargo and maintain this state;
- Blanketing: cargo tanks and their piping are filled with a liquid, gas or vapour which separates the cargo from the air and maintains this situation.

(2) When inerting or blanketing of the cargo is prescribed, the following requirements shall apply:

- (a) A sufficient quantity of inert gas for loading or unloading shall be on board or shall be capable of being produced if it is not possible to obtain it on shore. A sufficient quantity of inert gas to offset normal losses occurring during carriage shall be on board;
- (b) The inerting facility on board the vessel shall be capable of maintaining a permanent minimum pressure of 7 kPa (0.07 bar) in the spaces to be inerted. In addition, the inerting facility shall not increase the pressure in the cargo tank to a pressure greater than that at which the pressure valve is regulated;
- (c) For the blanketing of the cargo the requirements referred to in (a) and (b) for inerting shall apply as regards the quantity of gas required for blanketing;
- (d) The parts above the surface of the liquid covered by a layer of gas shall be fitted with monitoring devices so as to ensure the correct atmosphere on a permanent basis;

210 418
(cont'd)

- (e) Inerting or blanketing of flammable cargoes shall be carried out in such a way as to reduce the electrostatic charge as far as possible when the inerting agent is added.

(3) For certain substances the requirements for the monitoring of the gaseous phases in cargo tanks and in adjacent empty spaces are given in column 20 of the list of substances (Appendix 4).

210 419-
210 420

210 421 Filling of cargo tanks

(1) The degree of filling given in the list of substances of Appendix 4 or calculated in accordance with (3) below shall not be exceeded.

(2) The provisions of (1) above do not apply to cargo tanks the contents of which are maintained at the filling temperature during carriage by means of heating equipment. In this case calculation of the degree of filling at the beginning of carriage and control of the temperature shall be such that, during carriage, the maximum allowable degree of filling is not exceeded.

(3) For carriage of substances having a relative density higher than that stated in the

Annex B.2 - Part I

certificate of approval, the degree of filling shall be calculated in accordance with the following formula:

$$\text{Permitted degree of filling} = \frac{a}{b} \times 100 (\%)$$

a = relative density stated in the certificate of approval.

b = relative density of the substance.

The degree of filling given in the list of substances of Appendix 4 shall, however, not be exceeded.

(4) If the degree of filling of 97.5% is exceeded a technical installation shall be authorized to pump off the overflow. During such an operation an automatic visual alarm shall be activated on deck

210 422 Opening of openings

(1) Opening of tank hatches, sampling outlets or ullage openings shall not be permitted except for the purpose of inspecting or cleaning of unloaded cargo tanks, after the tanks have been relieved from pressure. Sampling is permitted only when carried out by means of a device of the type prescribed in the list of substances of Appendix 4 or a device of a higher safety type.

(2) Opening of sampling outlets and ullage openings of cargo tanks loaded with dangerous goods listed in marginal 210 500 is permitted only:

- after the loading operations have been interrupted for not less than 10 minutes;
- if the persons carrying out the sampling or gauging operation are protected against the action of the gases or vapours released by the cargo against the eyes, skin or respiratory tract;
- after the cargo tanks concerned has been relieved from pressure.

210 422 (cont'd)

(3) The sampling receptacles including all accessories such as ropes, etc., shall consist of electrostatically conductive material and shall, during sampling, be electrically connected to the vessel's hull.

(4) The duration of opening shall be limited to the time necessary for control, cleaning, gauging or sampling.

(5) Pressure relief of cargo tanks is permitted only when carried out by means of the device for safe pressure relief prescribed in marginals 321 222 (4) (a) or 331 222 (4) (a) of Part III.

(6) Paragraphs (1) to (5) shall not apply to oil separator or supply vessels.

210 423

210 424 Simultaneous loading and unloading

During loading or unloading of cargo tanks, no other cargo shall be loaded or unloaded. The competent authority may grant exceptions during unloading.

Annex B.2 - Part I

210 425 Cargo piping

(1) Loading and unloading as well as stripping of cargo tanks shall be carried out by means of the fixed cargo piping of the vessel.

The metal fittings of the connections to the shore piping shall be electrically earthed so as to prevent the accumulation of electrostatic charges.

(2) The cargo piping shall not be extended by rigid or flexible pipes fore or aft beyond the cofferdams.

This requirement shall not apply to hoses used for the reception of oily and greasy wastes resulting from the operation of vessels and the delivery of products for the operation of vessels.

(3) The shut-off devices of the cargo piping shall not be open except as necessary during loading, unloading or gas-freeing operations.

(4) The liquid remaining in the piping shall be completely drained into the cargo tanks, if possible, or safely removed. This requirement shall not apply to supply vessels.

(5) The gas/air mixtures shall be returned ashore through a pipe during loading operations when a closed type vessel is required in the list of substances of Appendix 4 and the shore installation is equipped for that purpose.

**210 426-
210 439**

210 440 Fire-extinguishing arrangements

During loading and unloading, the fire extinguishing systems, the hoses and spray nozzles shall be kept ready for operation in the cargo area on deck.

210 441 Fire or naked light

During loading, unloading or gas-freeing operations fires and naked lights are prohibited on board the vessel.

However, the provisions of marginal 210 342 (3) and (4) are applicable.

**210 442-
210 450**

210 451 Electrical installations

(1) During loading, unloading or gas-freeing operations, only electrical equipment conforming to the rules for construction in Part III, or which are installed in spaces complying with the conditions of marginals 311 252 (3), 321 252 (3) or 331 252 (3), may be used.

(2) Electrical equipment which have been switched off by the device referred to in marginals 311 252 (3) (b), 321 252 (3) (b) or 331 252 (3) (b) shall only be switched on after

Annex B.2 - Part I

the gas-free condition has been established in these spaces.

210 452

210 453 Lighting

If loading or unloading is performed at night or in conditions of poor visibility, effective lighting shall be provided. If provided from the deck, it shall be effected by properly secured electric lamps which shall be positioned in such a way that they cannot be damaged. Where these lamps are positioned in the cargo area, they shall be of the "certified safe" type.

210 454-

210 459

210 460 Specific equipment

The shower and the eye and face bath prescribed in the rules for construction shall be kept ready in all weather conditions for use during loading and unloading operations and cargo transfer operations by pumping.

210 461-

210 473

210 474 Prohibition of smoking, fire and naked light

The prohibition of smoking does not apply in accommodation or wheelhouses conforming to the provisions of marginals 311 252 (3) (b), 321 252 (3) (b) or 331 252 (3) (b).

210 475 Risk of sparking

All electrical connections between the vessel and the shore shall be so designed that they do not present a source of ignition.

210 476 Synthetic ropes

During loading and unloading operations, the vessel may be moored by means of synthetic ropes only when steel cables are used to prevent the vessel from going adrift.

Oil separator vessels may, however, be moored by means of synthetic ropes during the reception of oily and greasy wastes resulting from the operation of vessels, as may supply vessels during the delivery of products for the operation of vessels.

210 477-

210 499

SECTION 5. Additional requirements concerning the operation of vessels

210 500 Marking

(1) Vessels carrying dangerous goods listed in the list of substances of Appendix 4 shall display the number of blue cones or blue lights indicated in that list.

Annex B.2 - Part I

(2) Where more than one marking could apply to a vessel, only the marking which includes the greatest number of blue cones or blue lights shall apply, i.e. in the following order of precedence:

- two blue cones or two blue lights; or
- one blue cone or one blue light.

(3) By derogation from paragraph (1), and in accordance with the footnotes to article 3.14

(4)

(5) of the European Code for Inland Waterways (CEVNI), the competent authority of a Contracting Party may authorize seagoing vessels temporarily operating in an inland navigation area on the territory of this Contracting Party, the use of the day and night signals prescribed in the Recommendations on the Safe transport of Dangerous Cargoes and Related Activities in Port Areas adopted by the Maritime Safety Committee of the International Maritime Organization (by night and all-round fixed red light and by day flag "B" of the International Code of Signals), instead of the signals prescribed in paragraph (1). Contracting Parties which have taken the initiative with respect to the derogation granted shall notify the Executive Secretary of the United Nations Economic Commission for Europe, who shall bring this derogation to the attention of the Administrative Committee.

210 501 Mode of navigation

The competent authorities may impose restrictions on the inclusion of tank vessels in pushed convoys of large dimension.

210 502

210 503 Mooring

Vessels shall be moored securely, but in such a way that electrical power cables and flexible hoses are not subject to tensile strain and the vessels can be released quickly in an emergency.

210 504 Berthing

(1) The distances from other vessels to be kept by vessels carrying dangerous goods shall be not less than those prescribed by the European Code for Inland Waterways.

(2) An expert, as required by marginal 210 315 or, when applicable, by marginals 210 317 or 210 318 shall be permanently on board of berthed vessels. The competent authority may, however, exempt from this obligation those vessels which are berthed in the harbour basin or in a permitted berthing position.

(3) Outside the berthing areas specifically designated by the competent authority, the distances to be kept by berthed vessels shall not be less than:

100 m from residential areas, civil engineering structures or storage tanks, if the vessel is required to be marked with one blue cone or blue light in accordance with marginal 210 500;

100 m from civil engineering structures and storage tanks; and

Annex B.2 - Part I

300 m from residential areas if the vessel is required to be marked with two blue cones or two blue lights.

While waiting in front of locks or bridges, vessels are allowed to keep distances different from those given above. In no case shall the distance be less than 100 m.

(4) The competent authority may prescribe distances different from those given in (3) above, especially taking local conditions into account.

**210 505-
220 099**

Part II

**Special provisions concerning the carriage
of dangerous goods of classes 2, 3, 4.1, 6.1,
8 and 9 supplementing or amending
the provisions of Part I**

(RESERVED)

CLASS 2. GASES

Annex B.2 - Part II

General

221 000- *(Only the general provisions of Part I apply.)*
221 099

SECTION 1. Mode of carriage of goods

221 100- *(Only the general provisions of Part I apply.)*
221 199

SECTION 2. Requirements applicable to vessels

221 200-
221 220

221 221 Safety and control equipment

It shall be possible to interrupt loading or unloading of the cargo by means of switches installed at two locations on the vessel (fore and aft) and at two locations ashore (directly at the access to the vessel and at an appropriate distance on the quay). Interruption of loading and unloading shall be effected by the means of a quick action stop valve which shall be directly fitted to the flexible connecting hose between the vessel and the shore facility.

The system of disconnection shall be designed in accordance with the closed circuit principle.

221 222-
221 259

221 260 Special equipment

(1) When dangerous goods of Class 2 are carried on board the vessel, the protective equipment referred to in marginal 210 260 (1) (a) is required on board and shall be suitable for the goods carried.

(2) When dangerous goods of Class 2 are carried on board the vessel, the escape devices referred to in marginal 210 260 (1) (b) are required on board and shall be kept available for immediate use.

(3) When dangerous goods of Class 2 have been carried in the vessel and it is necessary to enter empty cargo tanks or hold spaces where the oxygen content is not sufficient or a measurable concentration of dangerous substances still remains, the items of equipment referred to in marginal 210 260 (1) (c) and (d) are required on board.

(4) When dangerous goods of Class 2 for which a flammable gas detector is required in the list of substances of Appendix 4 are carried on board, the flammable gas detector referred to in marginal 210 260 (1) (f) is required on board, together with instructions for its use.

(5) When dangerous goods of Class 2 for which a toximeter is required in the list of substances of Appendix 4 are carried on board, the toximeter referred to in marginal 210 260 (1) (g) is required on board, together with instructions for its use.

221 261-
221 299

Annex B.2 - Part II

SECTION 3. General service requirements

221 300

221 301 Access to cargo tanks, cargo pump-rooms below deck, cofferdams, double-hull spaces, double bottoms and hold spaces; inspections

(1) Before any person enters cargo tanks, the cargo pump-rooms below deck, cofferdams, double-hull spaces, double bottoms or hold spaces:

- (a) When dangerous goods of Class 2 for which a flammable gas detector is required in the list of substances of Appendix 4 are carried on board the vessel, it shall be established, by means of the device prescribed in marginal 221 260 (4) that the gas concentration in these cargo tanks, cargo pump-rooms below deck, cofferdams, double-hull spaces, double bottoms or hold spaces is not more than 50% of the lower explosive limit of the cargo. For the cargo pump-rooms below deck this may be determined by means of the permanent gas detection system;
- (b) When dangerous goods of Class 2 for which a toximeter is required in the list of substances of Appendix 4 are carried on board the vessel, it shall be established, by means of the device prescribed in marginal 221 260 (5) that the cargo tanks, cargo pump-rooms below deck, cofferdams, double-hull spaces, double bottoms or hold spaces do not contain any significant concentration of toxic gases.

Entry into spaces to be inspected is not permitted for the purpose of measuring.

(2) Entry into empty cargo tanks, the cargo pump-rooms below deck, cofferdams, double-hull spaces, double bottoms and hold spaces is not permitted, except where:

- there is no lack of oxygen and no measurable amount of dangerous substances in dangerous concentrations; or
- the person entering the spaces wears a self-contained breathing apparatus and other necessary protective and rescue equipment, and is secured by a line. Entry into these spaces is only permitted if this operation is supervised by a second person for whom the same equipment is readily at hand. Another two persons capable of giving assistance in an emergency shall be on the vessel within calling distance. If a rescue winch has been installed, only one other person is sufficient.

221 302 Cargo pump-rooms below deck

When the gas detection system is activated, the loading and unloading operations shall be stopped immediately. All shut-off devices shall be closed and the cargo pump-rooms shall be evacuated immediately. All entrances shall be closed. The loading or unloading operations shall not be continued except when the damage has been repaired or the fault eliminated.

**221 303-
221 399**

Annex B.2 - Part II

SECTION 4. Additional requirements concerning loading, carriage, unloading and other handling of cargo

221 400-
221 413

221 414 Handling of cargo

When supervision is required for dangerous goods of Class 2 in the list of substances of Appendix 4, loading and unloading shall be carried out under the supervision of a person who is not a member of the crew and who has been authorized for this purpose by the consignor or consignee.

221 415-
221 424

221 425 Cargo piping

The requirements of marginal 210 425 (4) shall be deemed to have been satisfied if the pipes for loading and unloading have been purged with the cargo gas or with nitrogen.

221 426-
221 427

221 428 Water-spray system

If a water-spray system is required in the list of substances of Appendix 4, it shall be kept ready for operation during loading or unloading of goods of Class 2.

221 429-
221 499

SECTION 5. Additional requirements concerning the operation of vessels

221 500- (Only the general provisions of Part I apply.)
230 999

Annex B.2 - Part II

CLASS 3. FLAMMABLE LIQUIDS

General

231 000- *(Only the general provisions of Part I apply.)*
231 099

SECTION 1. Mode of carriage of goods

231 100- *(Only the general provisions of Part I apply.)*
231 199

SECTION 2. Requirements applicable to vessels

231 200-
231 221

231 222 Cargo tank openings

When dangerous goods of Class 3 for which a type C vessel is required in the list of substances of Appendix 4 are carried, the high-velocity vent valves shall be set so that blowing-off does not normally occur while the vessel is under way.

231 223-
231 259

231 260 Special equipment

(1) When dangerous goods of Class 3 are carried on board the vessel, the protective equipment referred to in marginal 210 260 (1) (a) is required on board, with the exception of the full face mask with respirator for the carriage of goods for which an open type N is required in the list of substances (Appendix 4). This equipment shall be suitable for the goods carried.

(2) When dangerous goods of Class 3 are carried on board the vessel, except in the case of substances for which a tank vessel of type N, open, is required in the list of substances of Appendix 4, the escape devices referred to in marginal 210 260 (1) (b) are required on board and shall be kept available for immediate use.

(3) When dangerous goods of Class 3 have been carried in the vessel and it is necessary to enter empty cargo tanks or hold spaces where the oxygen content is not sufficient or a measurable concentration of dangerous substances still remains, the items of equipment referred to in marginal 210 260 (1) (c) and (d) are required on board.

(4) When dangerous goods of Class 3 for which a flammable gas detector is required in the list of substances of Appendix 4 are carried on board, the flammable gas detector referred to in marginal 210 260 (1) (f) is required on board, together with instructions for its use.

(5) When dangerous goods of Class 3 for which a toximeter is required in the list of substances of Appendix 4 are carried on board, the toximeter referred to in marginal 210 260 (1) (g) is required on board, together with instructions for its use.

231 261-
231 299

Annex B.2 - Part II

SECTION 3. General service requirements

231 300

231 301 Access to cargo tanks, residual cargo tanks, cargo pump-rooms below deck, cofferdams, double-hull spaces, double bottoms and hold spaces; inspections

(1) Before any person enters cargo tanks, residual cargo tanks, the cargo pump-rooms below deck, cofferdams, double-hull spaces, double bottoms or hold spaces:

- (a) When dangerous goods of Class 3 for which a flammable gas detector is required in the list of substances of Appendix 4 are carried on board the vessel, it shall be established, by means of the device prescribed in marginal 231 260 (4) that the gas concentration in these cargo tanks, residual cargo tanks, cargo pump-rooms below deck, cofferdams, double-hull spaces, double bottoms or hold spaces is not more than 50% of the lower explosive limit of the cargo. For the cargo pump-rooms below deck this may be determined by means of the permanent gas detection system;
- (b) When dangerous goods of Class 3 for which a toximeter is required in the list of substances of Appendix 4 are carried on board the vessel, it shall be established, by means of the device prescribed in marginal 231 260 (5) that the cargo tanks, residual cargo tanks, cargo pump-rooms below deck, cofferdams, double-hull spaces, double bottoms or hold spaces do not contain any significant concentration of toxic gases.

Entry into spaces to be inspected is not permitted for the purpose of measuring.

(2) Entry into empty cargo tanks, residual cargo tanks, the cargo pump-rooms below deck, cofferdams, double-hull spaces, double bottoms and hold spaces is not permitted, except where:

- there is no lack of oxygen and no measurable amount of dangerous substances in dangerous concentrations; or
- the person entering the spaces wears a self-contained breathing apparatus and other necessary protective and rescue equipment, and is secured by a line. Entry into these spaces is only permitted if this operation is supervised by a second person for whom the same equipment is readily at hand. Another two persons capable of giving assistance in an emergency shall be on the vessel within calling distance. If a rescue winch has been installed only one other person is sufficient.

231 302 Cargo pump-rooms below deck

(1) When the gas detection system is activated, the loading and unloading operations shall be stopped immediately. All shut-off devices shall be closed and the cargo pump-rooms shall be evacuated immediately. All entrances shall be closed. The loading or unloading operations shall not be continued except when the damage has been repaired or the fault eliminated.

(2) Cargo pump-rooms shall be inspected for leakage once every day. The bilges and collecting receptacles shall be kept clean and free from cargo.

Annex B.2 - Part II

**231 303-
231 399**

**SECTION 4. Additional requirements concerning loading, carriage, unloading
and other handling of cargo**

**231 400-
231 427**

231 428 Water-spray system

(1) If a water-spray system is required in the list of substances of Appendix 4, it shall be kept ready for operation during the loading or unloading of goods of Class 3, and during the voyage.

(2) When water-spraying is required in the list of substances of Appendix 4 for substances of Class 3 and the pressure of the gaseous phase in the cargo tanks may reach 80% of the relief pressure of the high velocity vent valves, the steersman shall take all measures compatible with safety to prevent the pressure from reaching that value. He shall in particular actuate the water-spray system.

(3) If a water-spray system is required in the list of substances of Appendix 4 and remark 23 is indicated in column 20, the instrument measuring the internal pressure shall activate an alarm when the internal pressure reaches 40 kPa. The water-spray system shall immediately be activated and remain in operation until the internal pressure drops to 30 kPa.

**231 429-
231 499**

SECTION 5. Additional requirements concerning the operation of vessels

**231 500-
240 999** (*Only the general provisions of Part I apply.*)

Annex B.2 - Part II

CLASS 4.1. FLAMMABLE SOLIDS

241 000 General

These provisions shall apply only to the carriage of molten sulphur, UN No.2448, in tank vessels.

**241 001-
241 099**

SECTION 1. Mode of carriage of goods

**241 100-
241 199** *(Only the general provisions of Part I apply.)*

SECTION 2. Requirements applicable to vessels

**241 200-
241 210**

241 211 Hold spaces and cargo tanks

Cargo tanks shall be provided with an external insulation which does not readily ignite. This insulation shall be sufficiently resistant to shock and impact. Above deck, the insulation shall be protected with a covering.

The external temperature of this covering shall not exceed 70 °C.

241 212 Ventilation

- (1) Hold spaces shall be provided with duct connections for force ventilation.
- (2) Cargo tanks shall be equipped with forced ventilation systems to maintain, in all conditions of transport, the concentration of hydrogen sulphide above the liquid phase below 1.85% by volume.
- (3) Ventilation systems shall be arranged so as to preclude depositing of substances to be carried within the system.
- (4) Ventilation exhaust ducts shall be arranged so as not to constitute a danger for people.

**241 213-
241 220**

241 221 Safety and control equipment

Cargo tanks and hold spaces shall be provided with openings and pipes for gas sampling.

241 222 Cargo tank openings

- (1) When sulphur is carried in the molten state, openings of cargo tanks shall be situated at such a height that for a 2° trim angle and 10° list angle, no sulphur can escape.
- 241 222** (2) Each opening of cargo tanks shall be provided with a satisfactory permanently fitted

Annex B.2 - Part II

(cont'd) closure device.

One of these devices shall open under the effect of a slight overpressure inside the tank.

241 223-
241 224

241 225 Pumps and pipes

Pipes for loading and unloading shall be provided with a sufficient insulation. It shall be possible to heat these pipes.

241 226-
241 241

241 242 Cargo heating systems

For carriage of sulphur in the molten state, the heating medium shall be of such a nature that in case of leakage inside the tank, no dangerous reaction with sulphur can occur.

Efficient temperature regulation of the cargo shall be possible.

241 243
241 259

241 260 Special equipment

(1) When dangerous goods of Class 4.1 are carried on board the vessel, the protective equipment referred to in marginal 210 260 (1) (a) is required on board and shall be suitable for the goods carried.

(2) When dangerous goods of Class 4.1 are carried on board the vessel, the escape devices referred to in marginal 210 260 (1) (b) are required on board and shall be kept available for immediate use.

(3) When dangerous goods of Class 4.1 have been carried in the vessel and it is necessary to enter empty cargo tanks or hold spaces where the oxygen content is not sufficient or a measurable concentration of dangerous substances still remains the items of equipment referred to in marginal 210 260 (1) (c) and (d) are required on board.

(4) When dangerous goods of Class 4.1 for which a flammable gas detector is required in the list of substances of Appendix 4 are carried on board, the flammable gas detector referred to in marginal 210 260 (1) (f) is required on board, together with instructions for its use.

(5) When dangerous goods of Class 4.1 for which a toximeter is required in the list of substances of Appendix 4 are carried on board, the toximeter referred to in marginal 210 260 (1) (g) is required on board, together with instructions for its use.

(6) During loading, carriage and unloading, each member of the crew in the cargo area shall be provided with a hydrogen sulphide detector constantly in operation which actuates an alarm when the Maximum Allowable Concentration (MAC) value of 10 ppm (= 0.001% by volume) has been reached.

241 261-

Annex B.2 - Part II

241 299

SECTION 3. General service requirements

241 300

241 301 Access to cargo tanks, residual cargo tanks, cargo pump-rooms below deck, cofferdams, double-hull spaces, double bottoms and hold spaces; inspections

(1) Before any person enters cargo tanks, residual cargo tanks, the cargo pump-rooms below deck, cofferdams, double-hull spaces, double bottoms or hold spaces:

- (a) When dangerous goods of Class 4.1 for which a flammable gas detector is required in the list of substances of Appendix 4 are carried on board the vessel, it shall be established, by means of the device prescribed in marginal 241 260 (4) that the gas concentration in these cargo tanks, residual cargo tanks, cargo pump-rooms below deck, cofferdams, double-hull spaces, double bottoms or hold spaces, is not more than 50% of the lower explosive limit of the cargo. For the cargo pump-rooms below deck this may be determined by means of the permanent gas detection system;
- (b) When dangerous goods of Class 4.1 for which a toximeter is required in the list of substances of Appendix 4 are carried on board the vessel, it shall be established, by means of the device prescribed in marginal 241 260 (5) that the cargo tanks, residual cargo tanks, cargo pump-rooms below deck, cofferdams, double-hull spaces, double bottoms or hold spaces do not contain any significant concentration of toxic gases.

Entry into spaces to be inspected is not permitted for the purpose of measuring.

(2) Entry into empty cargo tanks, residual cargo tanks, the cargo pump-rooms below deck, cofferdams, double-hull spaces, double bottoms and hold spaces is not permitted, except where:

- there is no lack of oxygen and no measurable amount of dangerous substances in dangerous concentrations; or
- the person entering the spaces wears a self-contained breathing apparatus and other necessary protective and rescue equipment, and is secured by a line. Entry into these spaces is only permitted if this operation is supervised by a second person for whom the same equipment is readily at hand. Another two persons capable of giving assistance in an emergency shall be on the vessel within calling distance. If a rescue winch has been installed only one other person is sufficient.

241 302 Cargo pump-rooms below deck

When the gas detection system is activated, the loading and unloading operations shall be stopped immediately. All shut-off devices shall be closed and the cargo pump-rooms shall be evacuated immediately. All entrances shall be closed. The loading or unloading operations shall not be continued except when the damage has been repaired or the fault eliminated.

241 303-
241 399

Annex B.2 - Part II

SECTION 4. Additional requirements concerning loading, carriage, unloading and other handling of cargo

**241 400-
241 411**

241 412 Ventilation

(1) For the carriage of molten sulphur, the forced ventilation shall be actuated at the latest when the hydrogen sulphide concentration reaches 1.0% by volume.

(2) For the carriage of molten sulphur, the steersman shall immediately inform the nearest competent authority if the hydrogen sulphide concentration in the cargo tanks exceeds 1.85%.

If, owing to a significant increase in the hydrogen sulphide concentration in a hold space, leakage of sulphur is suspected, the cargo tanks shall be discharged as soon as possible. Loading of new cargo is not permitted until the vessel has been inspected by the competent authority which issued the certificate of approval.

(3) During the carriage of molten sulphur, the hydrogen sulphide concentration in the free space in the cargo tanks and the concentration of sulphur dioxide and hydrogen sulphide in the hold spaces shall be measured.

(4) The measurements required in (3) above shall be carried out at least once every eight hours. The results shall be recorded in writing.

**241 413-
241 441**

241 442 Cargo heating system

The maximum allowable temperature indicated in the list of substances of Appendix 4 shall not be exceeded.

**241 443-
241 499**

SECTION 5. Additional requirements concerning the operation of vessels

(Only the general provisions of Part I apply.)

**241 500
260 999**

Annex B.2 - Part II

CLASS 6.1. TOXIC SUBSTANCES

General

261 000- *(Only the general provisions of Part I apply.)*
261 099

SECTION 1. Mode of carriage of goods

261 100- *(Only the general provisions of Part I apply.)*
261 199

SECTION 2. Requirements applicable to vessels

261 200-
261 221

261 222 Cargo tanks openings

When dangerous goods of Class 6.1 are carried, the high-velocity vent valves shall be set so that blowing-off does not normally occur while the vessel is under way.

261 223-
261 259

261 260 Special equipment

(1) When dangerous goods of Class 6.1 are carried on board the vessel, the protective equipment referred to in marginal 210 260 (1) (a) is required on board and shall be suitable for the goods carried.

(2) When dangerous goods of Class 6.1 are carried on board the vessel, the escape devices referred to in marginal 210 260 (1) (b) are required on board and shall be kept available for immediate use.

(3) When dangerous goods of Class 6.1 have been carried in the vessel and it is necessary to enter empty cargo tanks or hold spaces where the oxygen content is not sufficient or a measurable concentration of dangerous substances still remains, the items of equipment referred to in marginal 210 260 (1) (c) and (d) are required on board.

(4) When dangerous goods of Class 6.1 for which a flammable gas detector is required in the list of substances of Appendix 4 are carried on board, the flammable gas detector referred to in marginal 210 260 (1) (f) is required on board, together with instructions for its use.

(5) When dangerous goods of Class 6.1 for which a toximeter is required in the list of substances of Appendix 4 are carried on board, the toximeter referred to in marginal 210 260 (1) (g) is required on board, together with instructions for its use.

261 261-
261 299

Annex B.2 - Part II

SECTION 3. General service requirements

261 300

261 301 Access to cargo tanks, residual cargo tanks, cofferdams, double-hull spaces, double bottoms and hold spaces; inspections

(1) Before any person enters cargo tanks, residual cargo tanks, cofferdams, double-hull spaces, double bottoms or hold spaces:

- (a) When dangerous goods of Class 6.1 for which a flammable gas detector is required in the list of substances of Appendix 4 are carried on board the vessel, it shall be established, by means of the device prescribed in marginal 261 260 (4) that the gas concentration in these cargo tanks, residual cargo tanks, cofferdams, double-hull spaces, double bottoms or hold spaces, is not more than 50% of the lower explosive limit of the cargo.
- (b) When dangerous goods of Class 6.1 for which a toximeter is required in the list of substances of Appendix 4 are carried on board the vessel, it shall be established, by means of the device prescribed in marginal 261 260 (5) that the cargo tanks, residual cargo tanks, cofferdams, double-hull spaces, double bottoms or hold spaces do not contain any significant concentration of toxic gases.

Entry into spaces to be inspected is not permitted for the purpose of measuring.

(2) Entry into empty cargo tanks, residual cargo tanks, cofferdams, double-hull spaces, double bottoms and hold spaces is not permitted, except where:

- there is no lack of oxygen and no measurable amount of dangerous substances in dangerous concentrations; or
- the person entering the spaces wears a self-contained breathing apparatus and other necessary protective and rescue equipment, and is secured by a line. Entry into these spaces is only permitted if this operation is supervised by a second person for whom the same equipment is readily at hand. Another two persons capable of giving assistance in an emergency shall be on the vessel within calling distance. If a rescue winch has been installed only one other person is sufficient.

**261 302-
261 399**

SECTION 4. Additional requirements concerning loading, carriage, unloading and other handling of cargo

**261 400-
261 413**

261 414 Handling of cargo

When supervision is required for dangerous goods of Class 6.1 in the list of substances of Appendix 4, loading and unloading shall be carried out under supervision of a person who is not a member of the crew and who has been authorized for this purpose by the consignor or consignee.

Annex B.2 - Part II

**261 415-
261 427**

261 428 Water-spray system

(1) If a water-spray system is required in the list of substances of Appendix 4, it shall be kept ready for operation during loading or unloading of goods of Class 6.1, and during the voyage.

(2) When water-spraying is required in the list of substances of Appendix 4 for substances of Class 6.1 and the pressure of the gaseous phase in the cargo tanks may reach 80% of the relief pressure of the high-velocity vent valves, the steersman shall take all measures compatible with safety to prevent the pressure from reaching that value. He shall in particular actuate the water-spray system.

(3) If a water-spray system is required in the list of substances of Appendix 4 and remark 23 is indicated in column 20, the instrument measuring the internal pressure shall activate an alarm when the internal pressure reaches 40 kPa. The water-spray system shall immediately be activated and remain in operation until the internal pressure drops to 30 kPa.

**261 429-
261 499**

SECTION 5. Additional requirements concerning the operation of vessels

**261 500-
280 999** (*Only the general provisions of Part I apply.*)

Annex B.2 - Part II

CLASS 8. CORROSIVE SUBSTANCES

General

281 000- *(Only the general provisions of Part I apply.)*
281 099

SECTION 1. Mode of carriage of goods

281 100- *(Only the general provisions of Part I apply.)*
281 199

SECTION 2. Requirements applicable to vessels

281 200-
281 221

281 222 Cargo tanks openings

When dangerous goods of Class 8 for which a type C vessel is required in the list of substances of Appendix 4 are carried, the high-velocity vent valves shall be set so that blowing-off does not normally occur while the vessel is under way.

281 223-
281 259

281 260 Special equipment

(1) When dangerous goods of Class 8 are carried on board the vessel, the protective equipment referred to in marginal 210 260 (1) (a) is required on board and shall be suitable for the goods carried.

(2) When dangerous goods of Class 8 are carried on board the vessel, except in the case of substances for which a tank vessel of type N, open, is required in the list of substances of Appendix 4, the escape devices referred to in marginal 210 260 (1) (b) are required on board and shall be kept available for immediate use.

(3) When dangerous goods of Class 8 have been carried in the vessel and it is necessary to enter empty cargo tanks or hold spaces, where the oxygen content is not sufficient or a measurable concentration of dangerous substances still remains, the items of equipment referred to in marginal 210 260 (1) (c) and (d) are required on board.

(4) When dangerous goods of Class 8 for which a flammable gas detector is required in the list of substances of Appendix 4 are carried on board, the flammable gas detector referred to in marginal 210 260 (1) (f) is required on board, together with instructions for its use.

(5) When dangerous goods of Class 8 for which a toximeter is required in the list of substances of Appendix 4 are carried on board, the toximeter referred to in marginal 210 260 (1) (g) is required on board, together with instructions for its use.

281 261-
281 299

Annex B.2 - Part II

SECTION 3. General service requirements

281 300

281 301 Access to cargo tanks, residual cargo tanks, cargo pump-rooms below deck, cofferdams, double-hull spaces, double bottoms and hold spaces; inspections

(1) Before any person enters cargo tanks, cargo residues tanks, the cargo pump-rooms below deck, cofferdams, double-hull spaces, double bottoms or hold spaces:

- (a) When dangerous goods of Class 8 for which a flammable gas detector is required in the list of substances of Appendix 4 are carried on board the vessel, it shall be established, by means of the device prescribed in marginal 281 260 (4) that the gas concentration in these cargo tanks, residual cargo tanks, cargo pump-rooms below deck, cofferdams, double-hull spaces, double bottoms and hold spaces, is not more than 50% of the lower explosive limit of the cargo. For the cargo pump-rooms below deck this may be determined by means of the permanent gas detection system;
- (b) When dangerous goods of Class 8 for which a toximeter is required in the list of substances of Appendix 4 are carried on board the vessel, it shall be established, by means of the device prescribed in marginal 281 260 (5) that the cargo tanks, residual cargo tanks, cargo pump-rooms below deck, cofferdams, double-hull spaces, double bottoms or hold spaces do not contain any significant concentration of toxic or corrosive gases.

Entry into spaces to be inspected is not permitted for the purpose of measuring.

(2) Entry into empty cargo tanks, residual cargo tanks, the cargo pump-rooms below deck, cofferdams, double-hull spaces, double bottoms and hold spaces is not permitted, except where:

- there is no lack of oxygen and no measurable amount of dangerous substances in dangerous concentrations; or
- the person entering the spaces wears a self-contained breathing apparatus and other necessary protective and rescue equipment, and is secured by a line. Entry into these spaces is only permitted if this operation is supervised by a second person for whom the same equipment is readily at hand. Another two persons capable of giving assistance in an emergency shall be on the vessel within calling distance. If a rescue winch has been installed only one other person is sufficient.

281 302 Cargo pump-rooms below deck

(1) When the gas detection system is activated, the loading and unloading operations shall be stopped immediately. All shut-off devices shall be closed and the cargo pump-rooms shall be evacuated immediately. All entrances shall be closed. The loading or unloading operations shall not be continued except when the damage has been repaired or the fault eliminated.

(2) Cargo pump-rooms shall be inspected for leakage once every day. The bilges and collecting receptacles shall be kept clean and free from cargo.

Annex B.2 - Part II

**281 303-
281 399**

**SECTION 4. Additional requirements concerning loading, carriage, unloading
and other handling of cargo**

**281 400-
281 427**

281 428 Water-spray system

(1) If a water-spray system is required in the list of substances of Appendix 4, it shall be kept ready for operation during loading or unloading of goods of Class 8, and during the voyage.

(2) When water-spraying is required in the list of substances of Appendix 4 for substances of Class 8 and the pressure of the gaseous phase in the cargo tanks may reach 80% of the relief pressure of the high-velocity vent valves, the steersman shall take all measures compatible with safety to prevent the pressure from reaching that value. He shall in particular actuate the water-spray system.

(3) If a water-spray system is required in the list of substances of Appendix 4 and remark 23 is indicated in column 20, the instrument measuring the internal pressure shall activate an alarm when the internal pressure reaches 40 kPa. The water-spray system shall immediately be activated and remain in operation until the internal pressure drops to 30 kPa.

**281 429-
281 499**

SECTION 5. Additional requirements concerning the operation of vessels

**281 500- (Only the general provisions of Part I apply.)
290 999**

Annex B.2 - Part II

CLASS 9. MISCELLANEOUS DANGEROUS SUBSTANCES AND ARTICLES

General

291 000- *(Only the general provisions of Part I apply.)*
291 099

SECTION 1. Mode of carriage of goods

291 100- *(Only the general provisions of Part I apply.)*
291 199

SECTION 2. Requirements applicable to vessels

291 200-
291 221

291 222 Cargo tanks openings

When dangerous goods of Class 9 for which a type C vessel is required in the list of substances of Appendix 4 are carried, the high-velocity vent valves shall be set so that blowing-off does not normally occur while the vessel is under way.

291 223-
291 259

291 260 Special equipment

(1) When dangerous goods of Class 9 are carried on board the vessel, the protective equipment referred to in marginal 210 260 (1) (a) is required on board, with the exception of the full face mask with respirator for the carriage of goods for which an open type N is required in the list of substances (Appendix 4). This equipment shall be suitable for the goods carried.

(2) When dangerous goods of Class 9 are carried on board the vessel, except in the case of substances for which a tank vessel of type N, open, is required in the list of substances of Appendix 4, the escape devices referred to in marginal 210 260 (1) (b) are required on board.

(3) When dangerous goods of Class 9 have been carried in the vessel and it is necessary to enter empty cargo tanks or hold spaces, where the oxygen content is not sufficient or a measurable concentration of dangerous substances still remains, the items of equipment referred to in marginal 210 260 (1) (c) and (d) are required on board.

(4) When dangerous goods of Class 9 for which a flammable gas detector is required in the list of substances of Appendix 4 are carried on board, the flammable gas detector referred to in marginal 210 260 (1) (f) is required on board, together with instructions for its use.

(5) When dangerous goods of Class 9 for which a toximeter is required in the list of substances of Appendix 4 are carried on board, the toximeter referred to in marginal 210 260 (1) (g) is required on board, together with instructions for its use.

Annex B.2 - Part II

**291 261-
291 299**

SECTION 3. General service requirements

291 300

291 301 Access to cargo tanks, residual cargo tanks, cargo pump-rooms below deck, cofferdams, double-hull spaces, double bottoms and hold spaces; inspections

(1) Before any person enters cargo tanks, residual cargo tanks, the cargo pump-rooms below deck, cofferdams, double-hull spaces, double bottoms or hold spaces:

- (a) When dangerous goods of Class 9 for which a flammable gas detector is required in the list of substances of Appendix 4 are carried on board the vessel, it shall be established, by means of the device prescribed in marginal 291 260 (4) that the gas concentration in these cargo tanks, residual cargo tanks, cargo pump-rooms below deck, cofferdams, double-hull spaces, double bottoms or hold spaces is not more than 50% of the lower explosive limit of the cargo. For the cargo pump-rooms below deck this may be determined by means of the permanent gas detection system;
- (b) When dangerous goods of Class 9 for which a toximeter is required in the list of substances of Appendix 4 are carried on board the vessel, it shall be established, by means of the device prescribed in marginal 291 260 (5) that the cargo tanks, residual cargo tanks, cargo pump-rooms below deck, cofferdams, double-hull spaces, double bottoms or hold spaces do not contain any significant concentration of toxic or corrosive gases.

Entry into spaces to be inspected is not permitted for the purpose of measuring.

(2) Entry into empty cargo tanks, residual cargo tanks, the cargo pump-rooms below deck, cofferdams, double-hull spaces, double bottoms and hold spaces is not permitted, except where:

- there is no lack of oxygen and no measurable amount of dangerous substances in dangerous concentrations; or
- the person entering the spaces wears a self-contained breathing apparatus and other necessary protective and rescue equipment, and is secured by a line. Entry into these spaces is only permitted if this operation is supervised by a second person for whom the same equipment is readily at hand. Another two persons capable of giving assistance in an emergency shall be on the vessel within calling distance. If a rescue winch has been installed only one other person is sufficient.

291 302 Cargo pump-rooms below deck

(1) When the gas detection system is activated, the loading and unloading operations shall be stopped immediately. All shut-off devices shall be closed and the cargo pump-rooms shall be evacuated immediately. All entrances shall be closed. The loading or unloading operations shall not be continued except when the damage has been repaired or the fault eliminated.

**291 302
(cont'd)**

(2) Cargo pump-rooms shall be inspected for leakage once a day. Bilges and collecting receptacles shall be kept clean and free from cargo.

Annex B.2 - Part II

**291 303-
291 399**

**SECTION 4. Additional requirements concerning loading, carriage, unloading
and other handling of cargo**

**291 400-
291 427**

291 428 Water-spray system

(1) If a water-spray system is required in the list of substances of Appendix 4, it shall be kept ready for operation during loading or unloading of goods of Class 9, and during the voyage.

(2) When water-spraying is required in the list of substances of Appendix 4 for substances of Class 9 and the pressure of the gaseous phase in the cargo tanks may reach 80% of the relief pressure of the high-velocity vent valves, the steersman shall take all measures compatible with safety to prevent the pressure from reaching that value. He shall in particular actuate the water-spray system.

(3) If a water-spray system is required in the list of substances of Appendix 4 and remark 23 is indicated in column 20, the instrument measuring the internal pressure shall activate an alarm when the internal pressure reaches 40 kPa. The water-spray system shall immediately be activated and remain in operation until the internal pressure drops to 30 kPa.

**291 429-
291 499**

SECTION 5. Additional requirements concerning the operation of vessels

**291 500-
310 999** (*Only the general provisions of Part I apply.*)

(RESERVED)

Part III

Rules for construction of tank vessels

(RESERVED)

Annex B.2 - Part III - Chapter 1

CHAPTER 1

Rules for construction of type G tank vessels

**311 000-
311 099**

311 100 General

The rules for construction of Chapter 1 of Part III apply to type G tank vessels.

**311 101-
311 199**

311 200 Materials of construction

- (1) (a) The vessel's hull and the cargo tanks shall be constructed of shipbuilding steel or other at least equivalent metal.

The independent cargo tanks may also be constructed of other materials, provided these have at least equivalent mechanical properties and resistance against the effects of temperature and fire.

- (b) Every part of the vessel including any installation and equipment which may come into contact with the cargo shall consist of materials which can neither be dangerously affected by the cargo nor cause decomposition of the cargo or react with it so as to form harmful or hazardous products.

- (2) Except where explicitly permitted in (3) below or in the certificate of approval, the use of wood, aluminium alloys or plastic materials within the cargo area is prohibited.

- (3) (a) The use of wood, aluminium alloys or plastic materials within the cargo area is only permitted for:

- gangways and external ladders;
- movable items of equipment;
- chocking of cargo tanks which are independent of the vessel's hull and chocking of installations and equipment;
- masts and similar round timber;
- engine parts;
- parts of the electrical installation;
- lids of boxes which are placed on the deck.

- (b) The use of wood or plastic materials within the cargo area is only permitted for:

- supports and stops of any kind.

- (c) The use of plastic materials or rubber within the cargo area is only permitted for:

- all kinds of gaskets (e.g. for dome or hatch covers);

311 200

Annex B.2 - Part III - Chapter 1

- (cont'd)
- electric cables;
 - hoses for loading and unloading;
 - insulation of cargo tanks and of hoses for loading and unloading.

(d) All permanently fitted materials in the accommodation or wheelhouse, with the exception of furniture, shall not readily ignite. They shall not evolve fumes or toxic gases in dangerous quantities, if involved in a fire.

(4) The paint used in the cargo area shall not be liable to produce sparks in case of impact.

(5) The use of plastic material for vessel's boats is permitted only if the material does not readily ignite.

**311 201-
311 207**

311 208 Classification

(1) The tank vessel shall be built under survey of a recognized classification society in accordance with the rules established by that classification society for its highest class, and the tank vessel shall be classed accordingly.

The vessel's class shall be continued.

(2) The cargo pump-rooms shall be inspected by a recognized classification society whenever the certificate of approval has to be renewed as well as during the third year of validity of the certificate of approval. The inspection shall comprise at least:

- an inspection of the whole system for its condition, for corrosion, leakage or conversion works which have not been approved;
- a checking of the condition of the gas detection system in the cargo pump-rooms.

Inspection certificates signed by the recognized classification society with respect to the inspection of the cargo pump-rooms shall be kept on board. The inspection certificates shall at least include particulars of the above inspection and the results obtained as well as the date of the inspection.

(3) The condition of the gas detection system referred to in marginal 311 252 (3) (b) shall be checked by a recognized classification society whenever the certificate of approval has to be renewed and during the third year of validity of the certificate of approval. A certificate signed by the recognized classification society shall be kept on board.

311 209

311 210 Protection against the penetration of gases

(1) The vessel shall be designed so as to prevent gases from penetrating into the accommodation and the service spaces.

311 210 (cont'd) (2) The sills of doors in the sidewalls of superstructures and the coamings of access hatches to under-deck spaces shall have a height of not less than 0.50 m.

Annex B.2 - Part III - Chapter 1

This requirement need not be complied with if the wall of the superstructures facing the cargo area extends from one side of the ship to the other and has doors the sills of which have a height of not less than 0.50 m. The wall shall have a height not less than 2.00 m. In this case, the sills of doors in the sidewalls of superstructures and the coamings of access hatches behind this wall shall have a height of not less than 0.10 m. The sills of engine room doors and coamings of engine room access hatches shall, however, always have a height of not less than 0.50 m.

(3) The bulwarks shall be provided with sufficiently large openings which are located directly above the deck.

311 211 Hold spaces and cargo tanks

(1) (a) The maximum permissible capacity of a cargo tank shall be determined in accordance with the following table:

L · B · H (m³)	Maximum permissible capacity of a cargo tank (m³)
up to 600	$L \cdot B \cdot H \cdot 0.3$
600 to 3 750	$180 + (L \cdot B \cdot H - 600) \cdot 0.0635$
> 3 750	380

In the table above L · B · H is the product of the main dimensions of the tank vessel in metres (according to the measurement certificate), where:

L = overall length of the hull, in m;

B = extreme breadth of the hull, in m;

H = shortest vertical distance between the top of the keel and the lowest point of the deck at the side of the vessel (moulded depth) within the cargo area, in m;

For trunk vessels, H shall be replaced by H', where H' shall be obtained from the following formula:

$$H' = H + (ht \cdot bt/B \cdot lt/L)$$

where:

ht = trunk height, in m (distance between trunk deck and main deck measured on trunk side at L/2);

bt = trunk breadth, in m;

lt = trunk length, in m.

(b) Pressure cargo tanks whose ratio of length to diameter exceeds 7 are prohibited.

(c) The pressure cargo tanks shall be designed for a cargo temperature of + 40°C.

Annex B.2 - Part III - Chapter 1

311 211 (2) (a) In the cargo area, the hull shall be designed as follows */:
(cont'd)

- as a double-hull and double bottom vessel. The internal distance between the sideplatings of the vessel and the longitudinal bulkheads shall not be less than 0.80 m, the height of the double bottom shall be not less than 0.60 m, the cargo tanks shall be supported by saddles extending between the tanks to not less than 20° below the horizontal centreline of the cargo tanks.

Refrigerated cargo tanks shall be installed only in hold spaces bounded by double-hull spaces and double-bottom. Cargo tank fastenings shall meet the requirements of a recognized classification society;

or:

- as a single-hull vessel with the sideplatings of the vessel between gangboard and top of floor plates provided with side stringers at regular intervals of not more than 0.60 m which are supported by web frames spaced at intervals of not more than 2.00 m. The side stringers and the web frames shall have a height of not less than 10% of the depth, however, not less than 0.30 m. The side stringers and web frames shall be fitted with a face plate made of flat steel and having a cross-section of not less than 7.5 cm² and 15 cm², respectively.

The distance between the sideplating of the vessel and the cargo tanks shall be not less than 0.80 m and between the bottom and the cargo tanks not less than 0.60 m. The depth below the suction wells may be reduced to 0.50 m.

The lateral distance between the suction well of the cargo tanks and the bottom structure shall be not less than 0.10 m.

The cargo tank supports and fastenings shall be as follows:

- the cargo tanks shall be supported by saddles extending between the tanks to not less than 10° below the horizontal centreline of the tanks; and
- for adjacent cylindrical cargo tanks, a spacer of 500 mm x 450 mm shall be provided at the saddles, and a spacer of 2 000 mm x 450 mm shall be provided midway between the saddles.

The spacers shall fit the adjacent cargo tanks closely.

The spacers shall consist of an energy-absorbing material.

- (b) The cargo tanks shall be fixed so that they cannot float.
- (c) The capacity of a suction well shall be limited to not more than 0.10 m³. For pressure cargo tanks, however, the capacity of a suction well may be of 0.20 m³.

*/ For a different design of the hull in the cargo area, proof shall be furnished by way of calculation that in the event of a lateral collision with another vessel having a straight bow, an energy of 22 MJ can be absorbed without any rupture of the cargo tanks and the piping leading to the cargo tanks.

Annex B.2 - Part III - Chapter 1

**311 211
(cont'd)**

- (3) (a) The hold spaces shall be separated from the accommodation and service spaces outside the cargo area below deck by bulkheads provided with a Class A-60 fire protection insulation according to SOLAS Chapter II-2, Regulation 3. A space of not less than 0.20 m shall be provided between the cargo tanks and the end bulkheads of the hold spaces. Where the cargo tanks have plane end bulkheads this space shall be not less than 0.50 m.
- (b) The hold spaces and cargo tanks shall be capable of being inspected.
- (c) All spaces in the cargo area shall be capable of being ventilated. Means for checking their gas-free condition shall be provided.
- (4) The bulkheads bounding the hold spaces shall be watertight. The cargo tanks and the end bulkheads of the hold spaces as well as the bulkheads bounding the cargo area shall have no openings or penetrations below deck. Penetrations through bulkheads between two hold spaces are, however, permitted. The bulkhead between the engine room and the service spaces within the cargo area or between the engine room and a hold space may be fitted with penetrations provided that they conform to the requirements of marginal 311 217 (5).
- (5) Double-hull spaces and double bottoms in the cargo area shall be arranged for being filled with ballast water only. Double bottoms may, however, be used as oil fuel tanks, provided they comply with the requirements of marginal 311 232.
- (6) (a) A space in the cargo area below deck may be arranged as a service space, provided that the bulkhead bounding the service space extends vertically to the bottom and the bulkhead not facing the cargo area extends from one side of the vessel to the other in one frame plane. This service space shall only be accessible from the deck.
- (b) The service space shall be watertight with the exception of its access hatches and ventilation inlets.
- (c) No pipes for loading or unloading shall be fitted within the service space referred to under (a) above.
- Pipes for loading and unloading may be fitted in the cargo pump-rooms below deck only when they conform to the provisions of marginal 311 217 (6).
- (7) Where service spaces are located in the cargo area under deck, they shall be arranged so as to be easily accessible and to permit persons wearing protective clothing and breathing apparatus to safely operate the service equipment contained therein. They shall be designed so as to allow injured or unconscious personnel to be removed from such spaces without difficulty, if necessary by means of fixed equipment.
- (8) Hold spaces and other accessible spaces within the cargo area shall be arranged so as to ensure that they may be completely inspected and cleaned in an appropriate manner. The dimensions of openings, except for those of double-hull spaces and double bottoms which do not have a wall adjoining the cargo tanks, shall be sufficient to allow a person wearing breathing apparatus to enter or leave the space without difficulty. These openings shall have a minimum cross-sectional area of 0.36 m² and a minimum side length of 0.50 m. They shall be designed so as to allow injured or unconscious personnel to be removed from the bottom of such spaces without difficulties, if necessary by means of fixed equipment.

Annex B.2 - Part III - Chapter 1

311 211 (cont'd) In these spaces the distance between the reinforcements shall not be less than 0.50 m. In double bottoms this distance may be reduced to 0.45 m.

Cargo tanks may have circular openings with a diameter of not less than 0.68 m.

311 212 Ventilation

(1) Each hold space shall have two openings the dimensions and location of which shall be such as to permit effective ventilation of any part of the hold space. If there are no such openings, it shall be possible to fill the hold spaces with inert gas or dry air.

(2) Double-hull spaces and double bottoms within the cargo area which are not arranged for being filled with ballast water and cofferdams between engine rooms and pump-rooms, if they exist, shall be provided with ventilation systems.

(3) Any service spaces located in the cargo area below deck shall be provided with a system of forced ventilation with sufficient power for ensuring at least 20 changes of air per hour based on the volume of the space. The ventilator fan shall be designed so as that no spark may be emitted on contact of the impeller blades with the housing and no static electricity may be generated.

The ventilation exhaust ducts shall extend down to 50 mm above the bottom of the service space. The air shall be supplied through a duct at the top of the service space. The air inlets shall be located not less than 2.00 m above the deck, at a distance of not less than 2.00 m from tank openings and 6.00 m from the outlets of safety valves.

The extension pipes, which may be necessary, may be of the hinged type.

(4) Ventilation of accommodation and service spaces shall be possible.

(5) Ventilators used for gas-freeing of cargo tanks shall be designed so that no sparks may be emitted on contact of the impeller blades with the housing and no static electricity may be generated.

(6) Notice boards shall be fitted at the ventilation inlets indicating the conditions when they shall be closed. All ventilation inlets of accommodation and service spaces leading outside shall be fitted with fire flaps. Such ventilation inlets shall be located not less than 2.00 m from the cargo area.

Ventilation inlets of service spaces in the cargo area below deck may be located within such area.

311 213 Stability (general)

(1) Proof of sufficient stability shall be furnished including for stability in damaged condition.

(2) The basic values for the stability calculation - the vessel's lightweight and location of the centre of gravity - shall be determined either by means of an inclining experiment or by detailed mass and moment calculation. In the latter case the lightweight of the vessel shall be checked by means of a lightweight test with a tolerance limit of $\pm 5\%$ between the mass determined by calculation and the displacement determined by the draught readings.

Annex B.2 - Part III - Chapter 1

311 213 (cont'd) (3) Proof of sufficient intact stability shall be furnished for all stages of loading and unloading and for the final loading condition.

Floatability after damage shall be proved for the most unfavourable loading condition. For this purpose, calculated proof of sufficient stability shall be established for critical intermediate stages of flooding and for the final stage of flooding. Negative values of stability in intermediate stages of flooding may be accepted only if the continued range of curve of righting lever in damaged condition indicates adequate positive values of stability.

311 214 Stability (intact)

The requirements for intact stability resulting from the damaged stability calculation shall be fully complied with.

311 215 Stability (damaged condition)

(1) The following assumptions shall be taken into consideration for the damaged condition:

(a) The extent of side damage is as follows:

longitudinal extent:	at least 0.10 L, but not less than 5.00 m;
transverse extent:	0.79 m;
vertical extent:	from the base line upwards without limit.

(b) The extent of bottom damage is as follows:

longitudinal extent:	at least 0.10 L, but not less than 5.00 m;
transverse extent:	3.00 m;
vertical extent:	from the base 0.59 m upwards, the well excepted.

(c) Any bulkheads within the damaged area shall be assumed damaged, which means that the location of bulkheads shall be chosen so as to ensure that the vessel remains afloat after the flooding of two or more adjacent compartments in the longitudinal direction.

The following provisions are applicable:

- For bottom damage, adjacent athwartship compartments shall also be assumed as flooded;
- The lower edge of any non-watertight openings (e.g. doors, windows, access hatchways) shall, at the final stage of flooding, be not less than 0.10 m above the damage waterline;
- In general, permeability shall be assumed to be 95%. Where an average permeability of less than 95% is calculated for any compartment, this calculated value obtained may be used. However, the following minimum values shall be used:

- engine rooms:	85%
- accommodation:	95%
- double bottoms, oil fuel tanks, ballast tanks, etc., depending on whether, according to their function, they have to be assumed	

Annex B.2 - Part III - Chapter 1**311 215
(cont'd)**as full or empty for the vessel floating
at the maximum permissible draught:

0% or 95%.

For the main engine room only the one-compartment standard need be taken into account, i.e. the end bulkheads of the engine room shall be assumed as not damaged.

(2) At the stage of equilibrium (final stage of flooding), the angle of heel shall not exceed 12° . Non-watertight openings shall not be flooded before reaching the stage of equilibrium. If such openings are immersed before that stage, the corresponding spaces shall be considered as flooded for the purpose of stability calculation.

The positive range of the righting lever curve beyond the stage of equilibrium shall have a righting level of ≥ 0.05 m in association with an area under the curve of ≥ 0.0065 m.rad. The minimum values of stability shall be satisfied up to immersion of the first non-weather-tight opening and in any event up to an angle of heel $\leq 27^\circ$. If non-weather-tight openings are immersed before that stage, the corresponding spaces shall be considered as flooded for the purpose of stability calculation.

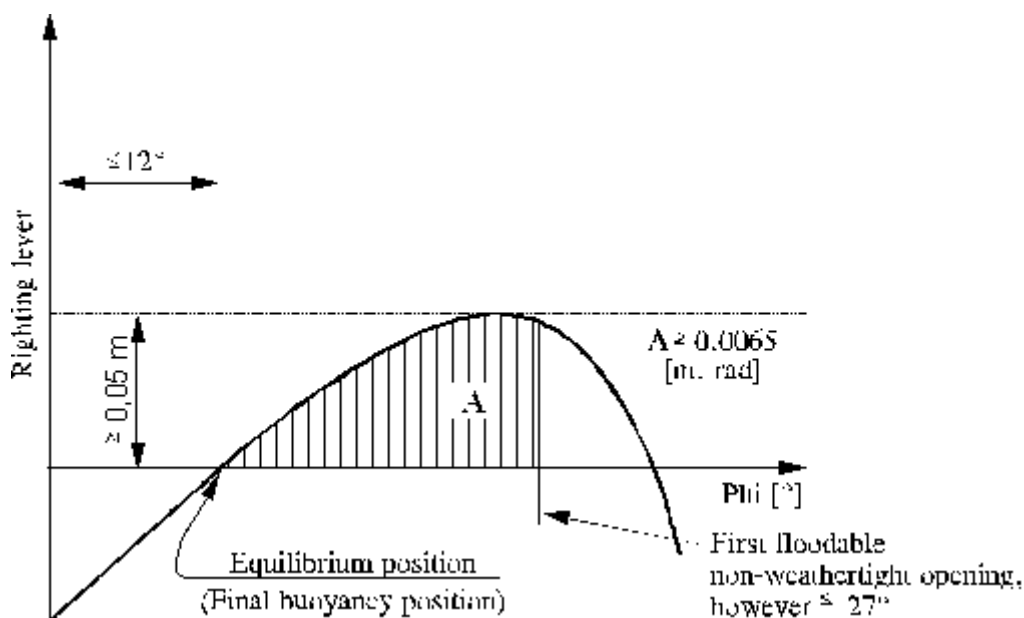

(3) If

openings through which undamaged compartments may additionally become flooded are capable of being closed watertight, the closing appliances shall be marked accordingly.

(4) When cross- or down-flooding openings are provided for reduction of unsymmetrical flooding, the time for equalization shall not exceed 15 minutes, if during the intermediate stages of flooding sufficient stability has been proved.

311 216 Engine rooms

(1) Internal combustion engines for the vessel's propulsion as well as internal combustion engines for auxiliary machinery shall be located outside the cargo area. Entrances and other openings of engine rooms shall be at a distance of not less than 2.00 m from the cargo area.

(2) The engine room shall be accessible from the deck; the entrances shall not face the

Annex B.2 - Part III - Chapter 1

(cont'd) cargo area. When the doors are not located in a recess whose depth is at least equal to the door width, the hinges shall face the cargo area.

311 217 Accommodation and service spaces

(1) Accommodation spaces and the wheelhouse shall be located outside the cargo area forward of the fore vertical plane or abaft the aft vertical plane bounding the part of cargo area below deck. Windows of the wheelhouse which are located not less than 1.00 m above the bottom of the wheelhouse may tilt forward.

(2) Entrances to spaces and openings of superstructures shall not face the cargo area. Doors opening outward and not located in a recess the depth of which is at least equal to the width of the doors shall have their hinges facing the cargo area.

(3) Entrances from the deck and openings of spaces facing the weather shall be capable of being closed. The following instruction shall be displayed at the entrance of such spaces:

**DO NOT OPEN DURING LOADING, UNLOADING OR GAS-FREEING
WITHOUT PERMISSION FROM THE STEERSMAN.
CLOSE IMMEDIATELY.**

(4) Entrances and windows of superstructures and accommodation spaces which can be opened as well as other openings of these spaces shall be located not less than 2.00 m from the cargo area. No wheelhouse doors and windows shall be located within 2.00 m from the cargo area, except where there is no direct connection between the wheelhouse and the accommodation.

(5) (a) Driving shafts of the bilge or ballast pumps may penetrate through the bulkhead between the service space and the engine room, provided the arrangement of the service space is in compliance with marginal 311 211 (6).

(b) The penetration of the shaft through the bulkhead shall be gastight and shall have been approved by a recognized classification society.

(c) The necessary operating instructions shall be displayed.

(d) Penetrations through the bulkhead between the engine room and the service space in the cargo area, and the bulkhead between the engine room and the hold spaces may be provided for electrical cables, hydraulic lines and piping for measuring, control and alarm systems, provided that the penetrations have been approved by a recognized classification society. The penetrations shall be gastight. Penetrations through a bulkhead with an "A-60" fire protection insulation according to SOLAS II-2, Regulation 3, shall have an equivalent fire protection.

(e) Pipes may pass through the bulkhead between the engine room and the service space in the cargo area provided that these are pipes between the mechanical equipment in the engine room and the service space which do not have any openings within the service space and which are provided with shut-off devices at the bulkhead in the engine room.

Annex B.2 - Part III - Chapter 1

**311 217
(cont'd)**

- (f) Pipes from the engine room may pass through the service space in the cargo area or a hold space to the outside provided that within the service space or hold space they are of the thick-walled type and have no flanges or openings.
- (g) Where a driving shaft of auxiliary machinery penetrates through a wall located above the deck the penetration shall be gastight.

(6) A service space located within the cargo area below deck shall not be used as a cargo pump-room for the vessel's own gas discharging system, e.g. compressors or the compressor/heat exchanger/pump combination, except where:

- the pump-room is separated from the engine room or from service spaces outside the cargo area by a cofferdam or a bulkhead with an "A-60" fire protection insulation according to SOLAS Chapter II-2, Regulation 3, or by a service space or a hold space;
- the "A-60" bulkhead required above does not include penetrations referred to in paragraph (5) (a);
- ventilation exhaust outlets are located not less than 6.00 m from entrances and openings of the accommodation and service spaces outside the cargo area;
- the access hatches and ventilation inlets can be closed from the outside;
- all pipes for loading and unloading (at the suction side and delivery side) are led through the deck above the pump-room. The necessary operation of the control devices in the pump-room, starting of pumps or compressors and control of the liquid flow rate shall be effected from the deck;
- the system is fully integrated in the gas and liquid piping system;
- the cargo pump-room is provided with a permanent gas detection system which automatically indicates the presence of explosive gases or lack of oxygen by means of direct-measuring sensors and which actuates a visual and audible alarm when the gas concentration has reached 20% of the lower explosive limit. The sensors of this system shall be placed at suitable positions at the bottom and directly below the deck.

Measurement shall be continuous;

- the audible and visual alarms are installed in the wheelhouse and in the cargo pump-room and, when the alarm is actuated, the loading and unloading system is shut down. Failure of the gas detection system shall be immediately signalled in the wheelhouse and on deck by means of audible and visual alarms;
- the ventilation system prescribed in marginal 311 212 (3) has a capacity of not less than 30 changes of air per hour based on the total volume of the service space.

311 217 (7) The following instruction shall be displayed at the entrance of the cargo pump-room:

Annex B.2 - Part III - Chapter 1

(cont'd)

BEFORE ENTERING THE CARGO PUMP-ROOM CHECK WHETHER IT IS FREE FROM GASES AND CONTAINS SUFFICIENT OXYGEN. DO NOT OPEN DOORS AND ENTRANCE OPENINGS WITHOUT THE PERMISSION OF THE STEERSMAN. LEAVE IMMEDIATELY IN THE EVENT OF ALARM.

**311 218-
311 220**

311 221 Safety and control installations

- (1) Cargo tanks shall be provided with the following equipment:
 - (a) (reserved);
 - (b) a level gauge;
 - (c) a level alarm device which is activated at the latest when a degree of filling of 86% is reached;
 - (d) a high level sensor for actuating the facility against overflowing at the latest when a degree of filling of 97.5% is reached;
 - (e) an instrument for measuring the pressure;
 - (f) an instrument for measuring the temperature of the cargo;
 - (g) a sampling device of the closed type;
 - (h) (reserved).
- (2) When the degree of filling in per cent is determined, an error of not more than 0.5% is permitted. It shall be calculated on the basis of the total cargo tank capacity including the expansion trunk.
- (3) The level gauge shall allow readings from the control position of the shut-off devices of the particular cargo tank.
- (4) The level alarm device shall give a visual and audible warning on board when actuated. The level alarm device shall be independent of the level gauge.
- (5) The high level sensor referred to in paragraph (1) (d) shall give a visual and audible alarm on board and at the same time actuate an electrical contact which in the form of a binary signal interrupts the electric current loop provided and fed by the shore facility, thus initiating measures at the shore facility against overflowing during loading operations.

The signal shall be transmitted to the shore facility via a watertight two-pin plug of a connector device in accordance with IEC Publication No. 309 for direct current of 40 to 50 volts, identification colour white, position of the nose 10 h.

The plug shall be permanently fitted to the vessel close to the shore connections of the loading and unloading pipes.

311 221 (cont'd) The high level sensor shall also be capable of switching off the vessel's own discharging pump.

Annex B.2 - Part III - Chapter 1

The high level sensor shall be independent of the level alarm device, but it may be connected to the level gauge.

(6) The visual and audible signals given by the level alarm device shall be clearly distinguishable from those of the high level sensor.

The visual alarm shall be visible at each control position on deck of the cargo tank stop valves. It shall be possible to easily check the functioning of the sensors and electric circuits or these shall be of the "failsafe" design.

(7) When the pressure or the temperature exceeds a set value, the instruments for measuring the pressure and the temperature of the cargo shall activate a visual and an audible alarm in the wheelhouse and in the accommodation. When the pressure exceeds a set value during loading or unloading, the instrument for measuring the pressure shall simultaneously initiate an electrical contact which, by means of the plug referred to in paragraph (5) above, enables measures to be taken to interrupt the loading operation. When the vessel's own discharge pump is used, it shall be switched off automatically. The sensor for the alarms referred to above may be connected to the alarm installation. If the overpressure or the vacuum measurement is effected using a manometer, its indicator scale shall not be less than 0.14 m in diameter. The maximum permissible overpressure or vacuum values shall be indicated by a red mark. The manometers shall be capable of being read at all times from the location where it is possible to interrupt loading or unloading.

(8) Where the control elements of the shut-off devices of the cargo tanks are located in a control room, reading of the level gauges shall be possible in the control room and the visual and audible warning given by the level alarm device, the high level sensor and the instruments for measuring the pressure and temperature of the cargo shall be noticeable in the control room and on deck.

Satisfactory monitoring of the cargo area shall be ensured from the control room.

(9) The closed sampling device penetrating through the boundary of the cargo tank but constituting a part of a closed system shall be designed so that during sampling no gas or liquid may escape from the cargo tank. The device shall be of a type approved by the competent authority for this purpose.

311 222 Cargo tank openings

(1) Cargo tank openings shall be located on deck in the cargo area.

(2) Cargo tank openings shall be fitted with gastight closures capable of withstanding the test pressure in accordance with marginal 311 223 (1).

(3) The exhaust outlets of the pressure relief valves shall be located not less than 2.00 m above the deck at a distance of not less than 6.00 m from the accommodation and from the service spaces located outside the cargo area. This height may be reduced when within a radius of 1.00 m round the pressure relief valve outlet there is no equipment, no work is being carried out and signs indicate the area.

311 223 Pressure test

(1) Cargo tanks and pipes for loading and unloading shall comply with the provisions

Annex B.2 - Part III - Chapter 1

concerning pressure vessels which have been established by the competent authority or a recognized classification society for the substances carried.

The test pressure of refrigerated cargo tanks shall be not less than 25 kPa (0.25 bar) gauge pressure.

(2) Any cofferdams shall be subjected to initial tests before being put into service and thereafter at the prescribed intervals.

The test pressure shall be not less than 10 kPa (0.10 bar) gauge pressure.

(3) The maximum intervals for the periodic tests referred to in paragraph (2) above shall be 11 years.

311 224

311 225 Pumps and piping

(1) Pumps, compressors and accessory loading and unloading piping shall be placed in the cargo area. Cargo pumps and compressors shall be capable of being shut down from the cargo area and, in addition, from a position outside the cargo area. Cargo pumps and compressors situated on deck shall be located not less than 6.00 m from entrances to, or openings of, the accommodation and service spaces outside the cargo area.

(2) (a) Pipes for loading and unloading shall be independent of any other piping of the vessel. No cargo piping shall be located below deck, except those inside the cargo tanks and in the service spaces intended for the installation of the vessel's own gas discharging system.

(b) (reserved)

(c) Pipes for loading and unloading shall be clearly distinguishable from other piping, e.g. by means of colour marking.

(d) The pipes for loading and unloading on deck, the vapour pipes with the exception of the shore connections but including the safety valves, and the valves shall be located within the longitudinal line formed by the outer boundaries of the domes and not less than one quarter of the vessel's breadth from the outer shell. This requirement does not apply to the relief pipes situated behind the safety valves. If there is, however, only one dome athwartships, these pipes and their valves shall be located at a distance not less than 2.70 m from the shell.

Where cargo tanks are placed side by side, all the connections to the domes shall be located on the inner side of the domes. The external connections may be located on the fore and aft centre line of the dome. The shut-off devices shall be located directly at the dome or as close as possible to it. The shut-off devices of the loading and unloading piping shall be duplicated, one of the devices being constituted by a remote-controlled quick-action stop device. When the inside diameter of a shut-off device is less than 50 mm this device may be regarded as a safety device against bursts in the piping.

**311 225
(cont'd)**

(e) The shore connections shall be located not less than 6.00 m from the entrances to or openings of, the accommodation and service spaces outside the cargo area.

(f) Each shore connection of the vapour pipe and shore connections of the pipes for

Annex B.2 - Part III - Chapter 1

loading and unloading, through which the loading or unloading operation is carried out, shall be fitted with a shut-off device and a quick-action stop valve. However, each shore connection shall be fitted with a blind flange when it is not in operation.

(3) The distance referred to in (1) and (2) (e) may be reduced to 3.00 m if a transverse bulkhead complying with 311 210 (2) is situated at the end of the cargo area. The openings shall be provided with doors. The following notice shall be displayed on the doors:

**DO NOT OPEN DURING LOADING AND UNLOADING WITHOUT
THE PERMISSION OF THE STEERSMAN.
CLOSE IMMEDIATELY.**

(4) Every component of the pipes for loading and unloading shall be electrically connected to the hull.

(5) The stop valves or other shut-off devices of the pipes for loading and unloading shall indicate whether they are open or shut.

(6) The pipes for loading and unloading shall have, at the test pressure, the required elasticity, leakproofness and resistance to pressure.

(7) The pipes for loading and unloading shall be fitted with pressure gauges at the inlet and outlet of the vessels' own gas discharging system.

Where these pressure gauges are manometers, the indicator scale shall have a diameter of not less than 0.14 m.

Reading of the pressure gauges shall be possible from the control position of the vessel's own gas discharging system. The maximum permissible overpressure or vacuum shall be indicated by a red mark.

(8) Use of the cargo piping for ballasting purposes shall not be possible.

311 226

311 227 Cargo refrigeration systems

(1) When refrigeration is required in the list of substances of Appendix 4, the vessel shall be provided with two independent refrigeration systems:

- (a) The capacity of the cargo refrigeration systems shall be such that, in the event of the failure of one system, the remaining system may maintain the temperature of the cargo at such a value that gas cannot escape through safety devices;
- (b) If the systems are operated electrically, they shall be connected to two electric circuits which are independent of each other and which are supplied by at least two different sources of electrical power. In addition, there shall be a possibility

Annex B.2 - Part III - Chapter 1

**311 227
(cont'd)**

for connection to a power source on shore; the necessary connecting cable shall be available on board;

- (c) Cargo tanks, piping and accessories shall be insulated so that, in the event of a failure of all cargo refrigeration systems, the entire cargo remains for at least 52 hours in a condition not causing the safety valves to open.

This provision shall be satisfied in the following ambient temperature conditions:

air temperature: + 30 °C
water temperature: + 20 °C;

- (d) The cargo refrigeration systems shall be arranged so that their function can be taken over by a third system independent of the vessel.

(2) The safety devices and the connecting lines from the refrigeration system shall be connected to the cargo tanks above the liquid phase of the cargo when the tanks are filled to their maximum permissible degree of filling. They shall remain within the gaseous phase, even if the vessel has a list up to 12 degrees.

(3) The cargo refrigeration system shall be installed in a separate service space provided with forced mechanical ventilation.

(4) For all cargo systems, the heat transmission coefficient shall be determined by calculation. The correctness of the calculation shall be checked by means of a refrigeration test (heat balance test).

This test shall be performed in accordance with the rules set up by a recognized classification society.

(5) A certificate from a recognized classification society stating that paragraphs (1) and (4) above have been complied with shall be submitted together with the application for issue or renewal of the certificate of approval.

311 228 Water-spray system

When water-spraying is required in the list of substances of Appendix 4, a water-spray system shall be installed in the cargo area on deck for the purpose of reducing vapours given off by the cargo.

The system shall be fitted with a connection device for supply from the shore. The system shall be capable of being put into operation from the wheelhouse and from the deck. The capacity of the water-spray system shall be such that when all the spray nozzles are in operation, the outflow is of 50 litres per square metre of cargo deck area and per hour.

**311 229-
311 230**

311 231 Engines

(1) Only internal combustion engines running on fuel with a flashpoint of more than 55 °C are allowed.

311 231 (2) Ventilation inlets of the engine room and, when the engines do not take in air directly

Annex B.2 - Part III - Chapter 1

(cont'd) from the engine room, the air in takes of the engines shall be located not less than 2.00 m from the cargo area.

(3) Sparking shall not be possible within the cargo area.

(4) The surface temperature of the outer parts of engines used during loading or unloading operations, as well as that of their air inlets and exhaust ducts shall not exceed the allowable temperature according to the temperature class. This provision does not apply to engines installed in service spaces provided the provisions of marginal 311 252 (3) (b) are fully complied with.

(5) The ventilation in the closed engine room shall be designed so that, at an ambient temperature of 20 °C, the average temperature in the engine room does not exceed 40 °C.

311 232 Oil fuel tanks

(1) Double bottoms within the cargo area may be arranged as oil fuel tanks, provided their depth is not less than 0.60 m.

Oil fuel pipes and openings of such tanks are not permitted in the hold space.

(2) The air pipes of all oil fuel tanks shall extend to 0.5 m above the open deck. Their open ends and the open ends of overflow pipes leading on the deck shall be fitted with a protective device consisting of a gauze diaphragm or a perforated plate.

311 233

311 234 Exhaust pipes

(1) Exhausts shall be evacuated from the vessel into the open air either upwards through an exhaust pipe or through the shell plating. The exhaust outlet shall be located not less than 2 m from the cargo area. The exhaust pipes of engines shall be arranged so that the exhausts are led away from the vessel. The exhaust pipes shall not be located within the cargo area.

(2) Exhaust pipes shall be provided with a device preventing the escape of sparks, e.g. spark arresters.

311 235 Bilge pumping and ballasting arrangements

(1) Bilge and ballast pumps for spaces within the cargo area shall be installed within such area.

This provision does not apply to:

- double-hull spaces and double bottoms which do not have a common boundary wall with the cargo tanks;
- cofferdams and hold spaces where ballasting is carried out using the piping of the fire-fighting system in the cargo area and bilge-pumping is performed using eductors.

311 235 (2) Where the double bottom is used as an oil fuel tank, it shall not be connected to the

Annex B.2 - Part III - Chapter 1

(cont'd) bilge piping system.

(3) Where the ballast pump is installed in the cargo area, the standpipe and its outboard connection for suction of ballast water shall be located within the cargo area.

**311 236-
311 239**

311 240 Fire-extinguishing arrangements

(1) A fire-extinguishing system shall be installed on the vessel.

This system shall comply with the following requirements:

- It shall be supplied by two independent fire or ballast pumps, one of which shall be ready for use at any time. These pumps shall not be installed in the same space;
- It shall be provided with a water main fitted with at least three hydrants in the cargo area above deck. Three suitable and sufficiently long hoses with spray nozzles having a diameter of not less than 12 mm shall be provided. It shall be possible to reach any point of the deck in the cargo area simultaneously with at least two jets of water which do not emanate from the same hydrant;

A spring-loaded non-return valve shall be fitted to ensure that no gases can escape through the fire-extinguishing system into the accommodation or service spaces outside the cargo area;

- The capacity of the system shall be at least sufficient for a jet of water to have a minimum reach of not less than the vessel's breadth from any location on board with two spray nozzles being used at the same time.

(2) In addition the engine rooms, the cargo pump-rooms and all spaces containing essential equipment under deck (diesel generators, switchboards, compressors, etc.) for the refrigeration equipment, if any, shall be provided with a fixed fire-extinguishing system which can be operated from the deck.

(3) The two hand fire-extinguishers referred to in marginal 210 240 shall be located in the cargo area.

311 241 Fire and naked light

(1) The outlets of funnels shall be located not less than 2.00 m from the cargo area. Arrangements shall be provided to prevent the escape of sparks and the entry of water.

(2) Heating, cooking and refrigerating appliances shall not be fuelled with liquid fuels, liquid gas or solid fuels.

The installation in the engine room or in an other separate space of heating appliances fuelled with liquid fuel having a flash-point above 55 °C is, however, permitted.

311 241 Cooking and refrigerating appliances are permitted only in the accommodation.

Annex B.2 - Part III - Chapter 1

(cont'd)

- (3) Only electrical lighting appliances are permitted.

**311 242-
311 249**

311 250 Documents concerning electrical installations

(1) In addition to the documents required by the "Recommendations on Technical Requirements for Inland Navigation Vessels", the following documents shall be on board:

- (a) a drawing indicating the boundaries of the cargo area and the location of the electrical equipment installed in this area;
- (b) a list of the electrical equipment referred to in (a) above including the following particulars:

machine or appliance, location, type of protection, type of protection against explosion, testing body and approval number;
- (c) a list of or general plan indicating the electrical equipment outside the cargo area which may be operated during loading, unloading or gas-freeing. All other electrical equipment shall be marked in red. See marginal 311 252 (3) and (4).

(2) The documents listed above shall bear the stamp of the competent authority issuing the certificate of approval.

311 251 Electrical installations

(1) Only distribution systems without return connection to the hull are permitted.

This provision does not apply to:

- local installations outside the cargo area (e.g. connections of starters of diesel engines);
- the device for checking the insulation level referred to in (2) below.

(2) Every insulated distribution network shall be fitted with an automatic device with a visual and audible alarm for checking the insulation level.

(3) For the selection of electrical equipment to be used in zones presenting an explosion risk, the explosion groups and temperature classes assigned to the substances carried in the list of substances of Appendix 4 shall be taken into consideration.

311 252 Type and location of electrical equipment

(1) (a) Only the following equipment may be installed in cargo tanks and pipes for loading and unloading (comparable to zone 0):

- measuring, regulation and alarm devices of the EEx (ia) type of protection.

**311 252
(cont'd)**

(b) Only the following equipment may be installed in the cofferdams, double-hull spaces, double bottoms and hold spaces (comparable to zone 1):

Annex B.2 - Part III - Chapter 1

- measuring, regulation and alarm devices of the "certified safe" type;
 - lighting appliances of the "flame-proof enclosure" or "pressurized apparatus" type of protection;
 - hermetically sealed echo sounding devices the cables of which are led through thick-walled steel tubes with gastight connections up to the main deck;
 - cables for the active cathodic protection of the shell plating in protective steel tubes such as those provided for echo sounding devices.
- (c) Only the following equipment may be installed in the service spaces in the cargo area below deck (comparable to zone 1):
- measuring, regulation and alarm devices of the "certified safe" type;
 - lighting appliances of the "flame-proof enclosure" or "pressurized apparatus" type of protection;
 - motors driving essential equipment such as ballast pumps; they shall be of the "certified safe" type.
- (d) The control and protective equipment of the electrical equipment referred to in paragraphs (a), (b) and (c) above shall be located outside the cargo area if they are not intrinsically safe.
- (e) The electrical equipment in the cargo area on deck (comparable to zone 1) shall be of the "certified safe" type.
- (2) Accumulators shall be located outside the cargo area.
- (3) (a) Electrical equipment used during loading, unloading and gas-freeing during berthing and which are located outside the cargo area (comparable to zone 2) shall be at least be of the "limited explosion risk" type.
- (b) This provision does not apply to:
- (i) lighting installations in the accommodation, except for switches near entrances to accommodation;
 - (ii) radiotelephone installations in the accommodation or the wheelhouse;
 - (iii) electrical installations in the accommodation, the wheelhouse or the service spaces outside the cargo areas if:
 1. These spaces are fitted with a ventilation system ensuring an overpressure of 0.1 kPa (0.001 bar) and none of the windows is capable of being opened; the air intakes of the ventilation system

Annex B.2 - Part III - Chapter 1

**311 252
(cont'd)**

located as far away as possible, however, not less than 6.00 m from the cargo area and not less than 2.00 m above the deck;

2. The spaces are fitted with a gas detection system with sensors:
 - at the suction inlets of the ventilation system;
 - directly at the top edge of the sill of the entrance doors of the accommodation and service spaces;
3. The gas concentration measurement is continuous;
4. When the gas concentration reaches 20% of the lower explosive limit, the ventilators is switched off. In such a case and when the overpressure is not maintained or in the event of failure of the gas detection system, the electrical installations which do not comply with (a) above, shall be switched off. These operations shall be performed immediately and automatically and activate the emergency lighting in the accommodation, the wheelhouse and the service spaces, which shall comply at least with the "limited explosion risk" type. The switching-off shall be indicated in the accommodation and wheelhouse by visual and audible signals;
5. The ventilation system, the gas detection system and the alarm of the switch-off device fully comply with the requirements of (a) above.
6. The automatic switch-off device is set so that no automatic switching-off may occur while the vessel is under way.

(4) The electrical equipment which do not meet the requirements set out in (3) above together with their switches shall be marked in red. The disconnection of such equipment shall be operated from a centralized location on board.

(5) An electric generator which is permanently driven by an engine and which does not meet the requirements of paragraph (3) above, shall be fitted with a switch capable of shutting down the excitation of generator. A notice board with the operating instructions shall be displayed near the switch.

(6) Sockets for the connection of signal lights and gangway lighting shall be permanently fitted to the vessel close to the signal mast or the gangway. Connecting and disconnecting shall not be possible except when the sockets are not live.

(7) The failure of the power supply for the safety and control equipment shall be immediately indicated by visual and audible signals at the locations where the alarms are usually actuated.

311 253 Earthing

(1) The metal parts of electrical appliances in the cargo area which are not live as well as protective metal tubes or metal sheaths of cables in normal service shall be earthed, unless they are so arranged that they are automatically earthed by bonding to the metal structure of the vessel.

311 253 (2) The provisions of paragraph (1) above apply also to equipment having service voltages

Annex B.2 - Part III - Chapter 1

(cont'd) of less than 50 V.

(3) Cargo tanks shall be earthed.

**311 254-
311 255**

311 256 Electrical cables

(1) All cables in the cargo area shall have a metallic sheath.

(2) Cables and sockets in the cargo area shall be protected against mechanical damage.

(3) Movable cables are prohibited in the cargo area, except for intrinsically safe electric circuits or for the supply of signal lights and gangway lighting.

(4) Cables of intrinsically safe circuits shall only be used for such circuits and shall be separated from other cables not intended for being used in such circuits (e.g. they shall not be installed together in the same string of cables and they shall not be fixed by the same cable clamps).

(5) For movable cables intended for signal lights and gangway lighting, only sheathed cables of type H 07 RN-F in accordance with 245 IEC 66 or cables of at least equivalent design having conductors with a cross-section of not less than 1.5 mm² shall be used.

These cables shall be as short as possible and installed so that damage is not likely to occur.

**311 257-
311 259**

311 260 Special equipment

A shower and an eye and face bath shall be provided on the vessel at a location which is directly accessible from the cargo area.

**311 261-
311 270**

311 271 Admittance on board

The notice boards displaying the prohibition of admittance in accordance with marginal 210 371 shall be clearly legible from either side of the vessel.

**311 272-
311 273**

311 274 Prohibition of smoking, fire or naked light

(1) The notice boards displaying the prohibition of smoking in accordance with marginal 210 374 shall be clearly legible from either side of the vessel.

311 274 (2) Notice boards indicating the circumstances under which the prohibition is applicable

Annex B.2 - Part III - Chapter 1

(cont'd) shall be fitted near the entrances to the spaces where smoking or the use of fire or naked light is not always prohibited.

(3) Ashtrays shall be provided close to each exit of the accommodation and the wheelhouse.

311 275

311 291

311 292 Emergency exit

Spaces the entrances or exits of which are likely to become partly or completely immersed in the damaged condition shall have an emergency exit which is situated not less than 0.10 m above the damage waterline. This does not apply to forepeak and afterpeak.

311 293-

311 299

Annex B.2 - Part III - Chapter 2

CHAPTER 2

Rules for construction of type C tank vessels

**321 000-
321 099**

321 100 General

The rules for construction of Chapter 2 of Part III apply to type C tank vessels.

**321 101-
321 199**

321 200 Materials of construction

- (1) (a) The vessel's hull and the cargo tanks shall be constructed of shipbuilding steel or other at least equivalent metal.

The independent cargo tanks may also be constructed of other materials, provided these have at least equivalent mechanical properties and resistance against the effects of temperature and fire.

- (b) Every part of the vessel including any installation and equipment which may come into contact with the cargo shall consist of materials which can neither be dangerously affected by the cargo nor cause decomposition of the cargo or react with it so as to form harmful or hazardous products.

- (2) Except where explicitly permitted in (3) below or in the certificate of approval, the use of wood, aluminium alloys or plastic materials within the cargo area is prohibited.

- (3) (a) The use of wood, aluminium alloys or plastic materials within the cargo area is only permitted for:

- gangways and external ladders;
- movable items of equipment (aluminium gauging rods are, however permitted, provided that they are fitted with brass feet or protected in another way to avoid sparking);
- chocking of cargo tanks which are independent of the vessel's hull and chocking of installations and equipment;
- masts and similar round timber;
- engine parts;
- parts of the electrical installation;
- loading and unloading appliances;
- lids of boxes which are placed on the deck.

Annex B.2 - Part III - Chapter 2

**321 200
(cont'd)**

- (b) The use of wood or plastic materials within the cargo area is only permitted for:
- supports and stops of any kind.
- (c) The use of plastic materials or rubber within the cargo area is only permitted for:
- coating of cargo tanks and of pipes for loading and unloading;
 - all kinds of gaskets (e.g. for dome or hatch covers);
 - electric cables;
 - hoses for loading and unloading;
 - insulation of cargo tanks and of hoses for loading and unloading.
- (d) All permanently fitted materials in the accommodation or wheelhouse, with the exception of furniture, shall not readily ignite. They shall not evolve fumes or toxic gases in dangerous quantities, if involved in a fire.
- (4) The paint used in the cargo area shall not be liable to produce sparks in case of impact.
- (5) The use of plastic material for vessel's boats is permitted only if the material does not readily ignite.

**321 201-
321 207**

321 208 Classification

(1) The tank vessel shall be built under survey of a recognized classification society in accordance with the rules established by that classification society for its highest class, and the tank vessel shall be classed accordingly.

The vessel's class shall be continued.

(2) The cargo pump-rooms shall be inspected by a recognized classification society whenever the certificate of approval has to be renewed as well as during the third year of validity of the certificate of approval. The inspection shall comprise at least:

- an inspection of the whole system for its condition, for corrosion, leakage or conversion works which have not been approved;
- a checking of the condition of the gas detection system in the cargo pump-rooms.

Inspection certificates signed by the recognized classification society with respect to the inspection of the cargo pump-rooms shall be kept on board. The inspection certificates shall at least include particulars of the above inspection and the results obtained as well as the date of the inspection.

(3) The condition of the gas detection system referred to in marginal 321 252 (3) (b) shall be checked by a recognized classification society whenever the certificate of approval has to be renewed and during the third year of validity of the certificate of approval. A certificate signed by the recognized classification society shall be kept on board.

321 209

321 210 Protection against the penetration of gases

Annex B.2 - Part III - Chapter 2

- (1) The vessel shall be designed so as to prevent gases from penetrating into the accommodation and the service spaces.
- (2) The sills of doors in the sidewalls of superstructures and the coamings of access hatches to under-deck spaces shall have a height of not less than 0.50 m.

This requirement need not be complied with if the wall of the superstructures facing the cargo area extends from one side of the ship to the other and has doors the sills of which have a height of not less than 0.50 m. The wall shall have a height not less than 2.00 m.

In this case, the sills of doors in the sidewalls of superstructures and of coamings of engine room access hatches behind this wall shall have a height of not less than 0.10 m. The sills of engine room doors and access hatches shall, however, always have a height of not less than 0.50 m.

- (3) The bulwarks shall be provided with sufficiently large openings which are located directly above the deck.

321 211 Hold spaces and cargo tanks

- (1) (a) The maximum permissible capacity of a cargo tank shall be determined in accordance with the following table:

$L \cdot B \cdot H$ (m ³)	Maximum permissible capacity of a cargo tank (m ³)
up to 600	$L \cdot B \cdot H \cdot 0.3$
600 to 3 750	$180 + (L \cdot B \cdot H - 600) \cdot 0.0635$
> 3 750	380

In the table above $L \cdot B \cdot H$ is the product of the main dimensions of the tank vessel in metres (according to the measurement certificate), where:

L = overall length of the hull, in m;

B = extreme breadth of the hull, in m;

H = shortest vertical distance between the top of the keel and the lowest point of the deck at the side of the vessel (moulded depth) within the cargo area, in m;

- (b) The relative density of the substances to be carried shall be taken into consideration in the design of the cargo tanks. The maximum relative density shall be indicated in the certificate of approval;
- (c) When the vessel is provided with pressure cargo tanks, these tanks shall be designed for a working pressure of 400 kPa (4 bar);
- (d) For vessels with a length of not more than 50.00 m, the length of a cargo tank shall not exceed 10.00 m;
for vessels with a length of more than 50.00 m, the length of a cargo tank shall not exceed 0.20 L.

321 211
(cont'd)

Annex B.2 - Part III - Chapter 2

This provision does not apply to vessels with independent built-in cylindrical tanks having a length to diameter ratio ≤ 7 .

- (2) (a) In the cargo area (except cofferdams) the vessel shall be designed as a flush-deck double-hull vessel, with double-hull spaces and double bottoms, but without a trunk.

Cargo tanks independent of the vessels' hull and refrigerated cargo tanks may only be installed in a hold space which is bounded by double-hull spaces and double bottoms in accordance with (7) below. The cargo tanks shall not extend beyond the deck.

- (b) The cargo tanks independent of the vessel's hull shall be fixed so that they cannot float.
- (c) The capacity of a suction well shall be limited to not more than 0.10 m³.
- (3) (a) The cargo tanks shall be separated by cofferdams of at least 0.60 m in width from the accommodation, engine room and service spaces outside the cargo area below deck or, if there are no such accommodation, engine room and service spaces, from the vessel's ends. Where the cargo tanks are installed in a hold space, a space of not less than 0.50 m shall be provided between such tanks and the end bulkheads of the hold space. In this case an insulated end bulkhead meeting the definition for Class "A-60" according to SOLAS II-2, Regulation 3, shall be deemed equivalent to a cofferdam. For pressure cargo tanks, the 0.50 m distance may be reduced to 0.20 m.
- (b) Hold spaces, cofferdams and cargo tanks shall be capable of being inspected.
- (c) All spaces in the cargo area shall be capable of being ventilated. Means for checking their gas-free condition shall be provided.

- (4) The bulkheads bounding the cargo tanks, cofferdams and hold spaces shall be watertight. The cargo tanks, cofferdams and the end bulkheads of the hold spaces, as well as the bulkheads bounding the cargo area shall have no openings or penetrations below deck. Penetrations through bulkheads between two hold spaces are, however, permitted.

The bulkhead between the engine room and the cofferdam or service space in the cargo area or between the engine room and a hold space may be fitted with penetrations provided that they conform to the provisions of marginal 321 217 (5).

The bulkhead between the cargo tank and the cargo pump-room below deck may be fitted with penetrations provided that they conform to the provisions of marginal 321 217 (6). If the vessel is fitted with a cargo pump-room below deck, the bulkheads between the cargo tanks may be fitted with passages provided that the loading pipes are fitted with shut-off devices in the cargo tank direct at the bulkhead and in the cargo pump-room direct at the bulkhead. The shut-off devices shall be capable of being activated from the deck.

Annex B.2 - Part III - Chapter 2

321 211 (cont'd) (5) Double-hull spaces and double bottoms in the cargo area shall be arranged for being filled with ballast water only. Double bottoms may, however, be used as oil fuel tanks, provided they comply with the provisions of marginal 321 232.

- (6) (a) A cofferdam, the centre part of a cofferdam or another space below deck in the cargo area may be arranged as a service space, provided the bulkheads bounding the service space extend vertically to the bottom. This service space shall only be accessible from the deck.
- (b) The service space shall be watertight with the exception of its access hatches and ventilation inlets.
- (c) No pipes for loading and unloading shall be fitted within the service space referred to under (a) above.

Pipes for loading and unloading may be fitted in the cargo pump-rooms below deck only when they conform to the provisions of marginal 321 217 (6).

(7) For double-hull construction with the cargo tanks integrated in the vessel's structure, the distance between the side wall of the vessel and the longitudinal bulkhead of the cargo tanks shall be not less than 1.00 m. A distance of 0.80 m may however be permitted, provided that, compared with the scantling requirements specified in the rules for construction of a recognized classification society, the following reinforcements have been made:

- (a) 25% increase in the thickness of the deck stringer plate;
- (b) 15% increase in the side plating thickness;
- (c) Arrangement of a longitudinal framing system at the vessel's side, where depth of the longitudinals shall be not less than 0.15 m and the longitudinals shall have a face plate with the cross-sectional area of at least 7.0 cm².
- (d) The stringer or longitudinal framing systems shall be supported by webframes, and like bottom girders fitted with lightening holes, at a maximum spacing of 1.80 m. These distances may be increased if the longitudinals are strengthened accordingly.

When a vessel is built according to the transverse framing system, a longitudinal stringer system shall be arranged instead of (c) above. The distance between the longitudinal stringers shall not exceed 0.80 m and their depth shall be not less than 0.15 m, provided they are completely welded to the frames. The cross-sectional area of the facebar or faceplate shall be not less than 7.0 cm² as in (c) above. Where cut-outs are arranged in the stringer at the connection with the frames, the web depth of the stringer shall be increased with the depth of cut-outs.

The mean depth of the double bottoms shall be not less than 0.70 m. It shall, however, never be less than 0.60 m.

The depth below the suction wells may be reduced to 0.50 m.

Annex B.2 - Part III - Chapter 2

321 211 (cont'd) (8) When a vessel is built with cargo tanks located in a hold space or refrigerated cargo tanks, the distance between the double walls of the hold space shall be not less than 0.80 m and the depth of the double bottom shall be not less than 0.60 m.

(9) Where service spaces are located in the cargo area under deck, they shall be arranged so as to be easily accessible and to permit persons wearing protective clothing and breathing apparatus to safely operate the service equipment contained therein. They shall be designed so as to allow injured or unconscious personnel to be removed from such spaces without difficulties, if necessary by means of fixed equipment.

(10) Cofferdams, double-hull spaces, double bottoms, cargo tanks, hold spaces and other accessible spaces within the cargo area shall be arranged so that they may be completely inspected and cleaned in an appropriate manner. The dimensions of openings except for those of double-hull spaces and double bottoms which do not have a wall adjoining the cargo tanks shall be sufficient to allow a person wearing breathing apparatus to enter or leave the space without difficulties. These openings shall have a minimum cross-sectional area of 0.36 m² and a minimum side length of 0.50 m. They shall be designed so as to allow injured or unconscious personnel to be removed from the bottom of such a space without difficulties, if necessary by means of fixed equipment. In these spaces the distance between the reinforcements shall not be less than 0.50 m. In double bottoms this distance may be reduced to 0.45 m.

Cargo tanks may have circular openings with a diameter of not less than 0.68 m.

321 212 Ventilation

(1) Double-hull spaces and double bottoms within the cargo area which are not arranged for being filled with ballast water, hold spaces and cofferdams shall be provided with ventilation systems.

(2) Any service spaces located in the cargo area below deck shall be provided with a system of forced ventilation with sufficient power for ensuring at least 20 changes of air per hour based on the volume of the space. The ventilator fan shall be designed so that no sparks may be emitted on contact of the impeller blades with the housing and no static electricity may be generated.

The ventilation exhaust ducts shall extend down to 50 mm above the bottom of the service space. The air shall be supplied through a duct at the top of the service space. The air inlets shall be located not less than 2.00 m above the deck, at a distance of not less than 2.00 m from tank openings and 6.00 m from the outlets of safety valves. The extension pipes, which may be necessary, may be of the hinged type.

(3) Ventilation of accommodation and service spaces shall be possible.

(4) Ventilators used for gas-freeing of tanks shall be designed so that no sparks may be emitted on contact of the impeller blades with the housing and no static electricity may be generated.

(5) Notice boards shall be fitted at the ventilation inlets indicating the conditions when they shall be closed. Any ventilation inlets of accommodation and service spaces leading outside shall be fitted with fire flaps. Such ventilation inlets shall be located not less than 2.00 m from the cargo area.

321 212 Ventilation inlets of service spaces in the cargo area below deck may be located within

Annex B.2 - Part III - Chapter 2

(cont'd) such area.

(6) The flame—arresters prescribed in marginals 321 220 (4), 321 221 (11), 321 222 (4) and (5) and 321 226 (2) shall be of a type approved for this purpose by the competent authority.

321 213 Stability (general)

(1) Proof of sufficient stability shall be furnished including for stability in damaged condition.

(2) The basic values for the stability calculation - the vessel's lightweight and location of the centre of gravity - shall be determined either by means of an inclining experiment or by detailed mass and moment calculation. In the latter case the lightweight of the vessel shall be checked by means of a lightweight test with a tolerance limit of $\pm 5\%$ between the mass determined by calculation and the displacement determined by the draught readings.

(3) Proof of sufficient intact stability shall be furnished for all stages of loading and unloading and for the final loading condition.

Floatability after damage shall be proved for the most unfavourable loading condition. For this purpose, calculated proof of sufficient stability shall be established for critical intermediate stages of flooding and for the final stage of flooding. Negative values of stability in intermediate stages of flooding may be accepted only if the continued range of curve of righting lever in damaged condition indicates adequate positive values of stability.

321 214 Stability (intact)

(1) The requirements for intact stability resulting from the damage stability calculation shall be fully complied with.

(2) For vessels with cargo tanks of more than $0.70 \cdot B$ in width, additional proof shall be furnished that, at an angle of 5° or, when this angle is less, at a heeling angle at which an opening becomes immersed, the righting arm is 0.10 m. The stability-reducing free surface effect in the case of cargo tanks filled to less than 95% of their capacity shall be taken into account.

(3) The most stringent requirement of paragraphs (1) and (2) is applicable to the vessel.

321 215 Stability (damaged condition)

(1) The following assumptions shall be taken into consideration for the damaged condition:

(a) The extent of side damage is as follows:

longitudinal extent:	at least 0.10 L, but not less than 5.00 m;
transverse extent:	0.79 m;
vertical extent:	from the base line upwards without limit.

Annex B.2 - Part III - Chapter 2**321 215
(cont'd)**

(b) The extent of bottom damage is as follows:

longitudinal extent: at least 0.10 L, but not less than 5.00 m;
 transverse extent: 3.00 m;
 vertical extent: from the base 0.59 m upwards, the sump excepted.

(c) Any bulkheads within the damaged area shall be assumed damaged, which means that the location of bulkheads shall be chosen so as to ensure that the vessel remains afloat after the flooding of two or more adjacent compartments in the longitudinal direction.

The following provisions are applicable:

- For bottom damage, adjacent athwartship compartments shall also be assumed as flooded;
- The lower edge of any non-watertight openings (e.g. doors, windows, access hatchways) shall, at the final stage of flooding, be not less than 0.10 m above the damage waterline;
- In general, permeability shall be assumed to be 95%. Where an average permeability of less than 95% is calculated for any compartment, this calculated value obtained may be used. However, the following minimum values shall be used:
 - engine rooms: 85%
 - accommodation: 95%
 - double bottoms, oil fuel tanks, ballast tanks, etc., depending on whether, according to their function, they have to be assumed as full or empty for the vessel floating at the maximum permissible draught: 0% or 95%.

For the main engine room only the one-compartment standard need be taken into account, i.e. the end bulkheads of the engine room shall be assumed as not damaged.

(2) At the stage of equilibrium (final stage of flooding), the angle of heel shall not exceed 12°. Non-watertight openings shall not be flooded before reaching the stage of equilibrium. If such openings are immersed before that stage, the corresponding spaces shall be considered as flooded for the purpose of the stability calculation.

The positive range of the righting lever curve beyond the stage of equilibrium shall have a righting lever of ≥ 0.05 m in association with an area under the curve of ≥ 0.0065 m.rad. The minimum values of stability shall be satisfied up to immersion of the first non-weather-tight opening and in any event up to an angle of heel $\leq 27^\circ$. If non-weather-tight openings are immersed before that stage, the corresponding spaces shall be considered as flooded for the purposes of stability calculation.

Annex B.2 - Part III - Chapter 2

321 215
(cont'd)

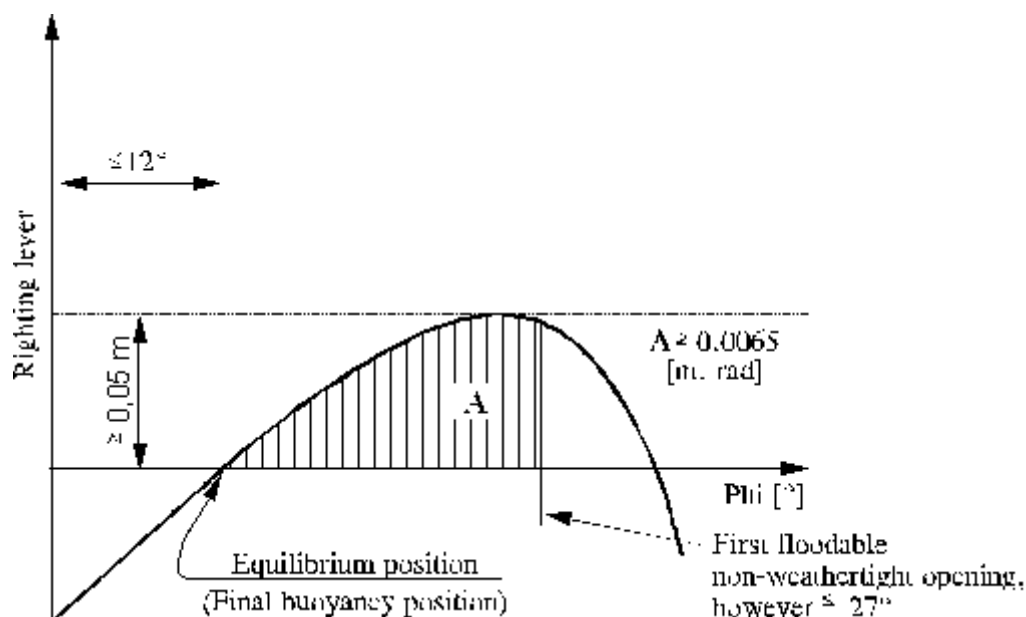

(3) If openings through which undamaged compartments may additionally become flooded are capable of being closed watertight, the closing appliances shall be marked accordingly.

(4) Where cross- or down-flooding openings are provided for reduction of unsymmetrical flooding, the time for equalization shall not exceed 15 minutes, if during the intermediate stages of flooding sufficient stability has been proved.

321 216 Engine rooms

(1) Internal combustion engines for the vessel's propulsion as well as internal combustion engines for auxiliary machinery shall be located outside the cargo area. Entrances and other openings of engine rooms shall be at a distance of not less than 2.00 m from the cargo area.

(2) The engine rooms shall be accessible from the deck; the entrances shall not face the cargo area. Where the doors are not located in a recess whose depth is at least equal to the door width, the hinges shall face the cargo area.

321 217 Accommodation and service spaces

(1) Accommodation spaces and the wheelhouse shall be located outside the cargo area forward of the fore vertical plane or abaft the aft vertical plane bounding the part of cargo area below deck. Windows of the wheelhouse which are located not less than 1.00 m above the bottom of the wheelhouse may tilt forward.

(2) Entrances to spaces and openings of superstructures shall not face the cargo area. Doors opening outward and not located in a recess the depth of which is at least equal to the width of the doors shall have their hinges face the cargo area.

Annex B.2 - Part III - Chapter 2

- 321 217 (cont'd)** (3) Entrances from the deck and openings of spaces facing the weather shall be capable of being closed. The following instruction shall be displayed at the entrance of such spaces:

**DO NOT OPEN DURING LOADING, UNLOADING OR GAS-FREEING
WITHOUT PERMISSION FROM THE STEERSMAN.
CLOSE IMMEDIATELY.**

- (4) Entrances and windows of superstructures and accommodation spaces which can be opened as well as other openings of these spaces shall be located not less than 2.00 m from the cargo area. No wheelhouse doors and windows shall be located within 2.00 m from the cargo area, except where there is no direct connection between the wheelhouse and the accommodation.
- (5) (a) Driving shafts of the bilge or ballast pumps may penetrate through the bulkhead between the service space and the engine room, provided the arrangement of the service space is in compliance with marginal 321 211 (6).
- (b) The penetration of the shaft through the bulkhead shall be gastight and shall have been approved by a recognized classification society.
- (c) The necessary operating instructions shall be displayed.
- (d) Penetrations through the bulkhead between the engine room and the service space in the cargo area and the bulkhead between the engine room and the hold spaces may be provided for electrical cables, hydraulic lines and piping for measuring, control and alarm systems, provided that the penetration have been approved by a recognized classification society. The penetrations shall be gastight. Penetrations through a bulkhead with an "A-60" fire protection insulation according to SOLAS II-2, Regulation 3, shall have an equivalent fire protection.
- (e) Pipes may penetrate the bulkhead between the engine room and the service space in the cargo area provided that these are pipes between the mechanical equipment in the engine room and the service space which do not have any openings within the service space and which are provided with shut-off devices at the bulkhead in the engine room.
- (f) Pipes from the engine room may pass through the service space in the cargo area or a cofferdam or a hold space to the outside provided that within the service space or cofferdam or hold space they are of the thick-walled type and have no flanges or openings.
- (g) Where a driving shaft of auxiliary machinery penetrates through a wall located above the deck the penetration shall be gastight.
- (6) A service space located within the cargo area below deck shall not be used as a cargo pump-room for the loading and unloading system, except where:
- the pump room is separated from the engine room or from service spaces outside the cargo area by a cofferdam or a bulkhead with an "A-60" fire protection insulation according to SOLAS Chapter II-2, Regulation 3, or by a service space or a hold space;

Annex B.2 - Part III - Chapter 2

**321 217
(cont'd)**

- the "A-60" bulkhead required above does not include penetrations referred to in paragraph (5) (a);
- ventilation exhaust outlets are located not less than 6.00 m from entrances and openings of the accommodation and service spaces outside the cargo area;
- the access hatches and ventilation inlets can be closed from the outside;
- all pipes for loading and unloading as well as those of stripping systems are provided with shut-off devices at the pump suction side in the cargo pump-room immediately at the bulkhead. The necessary operation of the control devices in the pump-room, starting of pumps and control of the liquid flow rate shall be effected from the deck;
- the bilge of the cargo pump-room is equipped with a gauging device for measuring the filling level which activates a visual and audible alarm in the wheelhouse when liquid is accumulating in the cargo pump-room bilge;
- the cargo pump-room is provided with a permanent gas-detection system which automatically indicates the presence of explosive gases or lack of oxygen by means of direct-measuring sensors and which actuates a visual and audible alarm when the gas concentration has reached 20% of the lower explosive limit. The sensors of this system shall be placed at suitable positions at the bottom and directly below the deck.

Measurement shall be continuous.

The audible and visual alarms are installed in the wheelhouse and in the cargo pump-room and, when the alarm is actuated, the loading and unloading system is shut down. Failure of the gas detection system shall be immediately signalled in the wheelhouse and on deck by means of audible and visual alarms;

- the ventilation system prescribed in marginal 321 212 (2) has a capacity of not less than 30 changes of air per hour based on the total volume of the service space.

(7) The following instruction shall be displayed at the entrance of the cargo pump-room:

**BEFORE ENTERING THE CARGO PUMP-ROOM CHECK WHETHER
IT IS FREE FROM GASES AND CONTAINS SUFFICIENT OXYGEN.
DO NOT OPEN DOORS AND ENTRANCE OPENINGS WITHOUT
THE PERMISSION OF THE STEERSMAN.
LEAVE IMMEDIATELY IN THE EVENT OF ALARM.**

**321 218-
321 219**

321 220 Arrangement of cofferdams

(1) Cofferdams or cofferdam compartments located next to a service space which has been arranged in accordance with marginal 321 211 (6) shall be accessible through an access hatch.

321 220 The access hatches and ventilation inlets shall be located not less than 0.50 m above the deck.

Annex B.2 - Part III - Chapter 2

(cont'd)

- (2) Cofferdams shall be capable of being filled with water and emptied by means of a pump. Filling shall be effected within 30 minutes. The cofferdams shall not be fitted with inlet valves.
- (3) No fixed pipe shall permit connection between a cofferdam and other piping of the vessel outside the cargo area.
- (4) The ventilation openings of cofferdams shall be fitted with a flame-arrester.

321 221 Safety and control installations

- (1) Cargo tanks shall be provided with the following equipment:
 - (a) a mark inside the tank indicating the liquid level of 95%;
 - (b) a level gauge;
 - (c) a level alarm device which is activated at the latest when a degree of filling of 90% is reached;
 - (d) a high level sensor for actuating the facility against overflowing at the latest when a degree of filling of 97.5% is reached;
 - (e) an instrument for measuring the pressure of the vapour phase inside the cargo tank;
 - (f) an instrument for measuring the temperature of the cargo, when a system for heating the cargo is required in the list of substances of Appendix 4 or a maximum temperature is indicated in column 20 of that list;
 - (g) a sampling device of the closed type or of the partly closed type and/or a sampling opening as required in the list of substances of Appendix 4.
- (2) When the degree of filling in per cent is determined, an error of not more than 0.5% is permitted. It shall be calculated on the basis of the total cargo tank capacity including the expansion trunk.
- (3) The level gauge shall allow readings from the control position of the shut-off devices of the particular cargo tank.
- (4) The level alarm device shall give a visual and audible warning on board when actuated. The level alarm device shall be independent of the level gauge.
- (5) The high level sensor referred to in paragraph (1) (d) above shall give a visual and audible alarm on board and at the same time actuate an electrical contact which in the form of a binary signal interrupts the electric current loop provided and fed by the shore facility, thus initiating measures at the shore facility against overflowing during loading operations. The signal shall be transmitted to the shore facility via a watertight two-pin plug of a connector device in accordance with IEC Publication No. 309 for direct current of 40 to 50 volts, identification colour white, position of the nose 10 h.

321 221 (cont'd) The plug shall be permanently fitted to the vessel close to the shore connections of the loading and unloading pipes.

Annex B.2 - Part III - Chapter 2

The high level sensor shall also be capable of switching off the vessel's own discharging pump. The high level sensor shall be independent of the level alarm device, but it may be connected to the level gauge.

(6) The visual and audible signals given by the level alarm device shall be clearly distinguishable from those of the high level sensor.

The visual alarm shall be visible at each control position on deck of the cargo tank stop valves. It shall be possible to easily check the functioning of the sensors and electric circuits or these shall be of the "failsafe" design.

(7) When the pressure or temperature exceeds a set value, instruments for measuring the vacuum or overpressure of the gaseous phase in the cargo tank or the temperature of the cargo, shall activate a visual and audible alarm in the wheelhouse and in the accommodation. When the pressure exceeds the set value during loading, the instrument for measuring the pressure shall, by means of the plug referred to in paragraph (5) above, initiate simultaneously an electrical contact which shall put into effect measures to interrupt the loading operation. If the vessel's own discharge pump is used, it shall be switched off automatically.

The instrument for measuring the overpressure or vacuum shall activate the alarm when an overpressure equal to 1.15 times the opening pressure of the pressure valve, or a vacuum pressure of 1.1 times the opening pressure of the vacuum pressure valve is reached. The maximum allowable temperature is indicated in the list of substances in Appendix 4. The sensors for the alarms mentioned in this paragraph may be connected to the alarm device of the sensor.

When a manometer is used to measure the overpressure or the vacuum pressure, its indicator scale shall not be less than 0.14 m in diameter. The maximum permissible overpressure or vacuum values shall be indicated by a red mark. The manometers shall be capable of being read at all times from the location where it is possible to interrupt loading or unloading.

(8) Where the control elements of the shut-off devices of the cargo tanks are located in a control room, reading of the level gauges shall be possible in the control room and the visual and audible warning given by the level alarm device, the high level sensor referred to in (1) (d) and the instruments for measuring the pressure of the vapour phase and temperature of the cargo shall be noticeable in the control room and on deck.

Satisfactory monitoring of the cargo area shall be ensured from the control room.

(9) The closed-type sampling device penetrating through the boundary of the cargo tank but constituting a part of a closed system shall be designed so that during sampling no gas or liquid may escape from the cargo tank. The device shall be of a type approved by the competent authority for this purpose.

(10) The partly closed sampling device penetrating through the boundary of the cargo tank shall be such that during sampling only a small quantity of gaseous or liquid cargo can escape into the open air. As long as the device is not used it shall be closed completely. The device shall be of a type approved by the competent authority for this purpose.

**321 221
(cont'd)**

(11) The sampling openings shall have a diameter of not more than 0.30 m. They shall be fitted with a flame-arrester and shall be such that the period during which they remain open is as short as possible and that the flame-arrester closes automatically.

(12) The ullage openings shall be such that the filling level may be measured by means

Annex B.2 - Part III - Chapter 2

of a gauging rod. The ullage openings shall be fitted with a self-closing lid.

321 222 Cargo tank openings

- (1) (a) Cargo tank openings shall be located on deck in the cargo area.
 - (b) Cargo tank openings with a cross-section of more than 0.10 m² and openings of safety devices for preventing overpressures shall be located not less than 0.50 m above deck.
 - (2) Cargo tank openings shall be fitted with gastight closures capable of withstanding the test pressure in accordance with marginal 321 223 (2).
 - (3) Closures which are normally used during loading or unloading operations shall not cause sparking when operated.
 - (4) (a) Each cargo tank or group of cargo tanks connected to a common vapour pipe shall be fitted with:
 - safety devices for preventing unacceptable overpressures or vacuums, where the vacuum valve is fitted with a flame-arrester and the pressure-relief valve is designed as a high-velocity vent valve with a flame-arresting effect.

The gases shall be discharged upwards. The opening pressure of the high-velocity vent valve and the opening pressure of the vacuum valve shall be indelibly indicated on the valve;
 - a connection for the safe return ashore of gases expelled during loading;
 - a device for the safe depressurization of the tanks consisting of at least a flame-arrester and a stop valve which clearly indicates whether it is open or shut.
 - (b) The outlets of high-velocity vent valves shall be located not less than 2.00 m above the deck and at a distance of not less than 6.00 m from the accommodation and from the service spaces outside the cargo area. This height may be reduced when within a radius of 1.00 m round the outlet of the high-velocity vent valve, there is no equipment, no work is being carried out and signs indicate the area. The setting of the high-velocity vent valves shall be such that during the transport operation they do not blow off until the maximum permissible working pressure of the cargo tanks is reached.
- (5) (a) When a vapour pipe connects two or more cargo tanks, a flame-arrester capable of withstanding an explosion or detonation inside the pipe shall be fitted at the connection to each cargo tank. Only substances which do not mix and which do not react dangerously with each other may be carried simultaneously in cargo

Annex B.2 - Part III - Chapter 2

**321 222
(cont'd)**

tanks connected to a common vapour pipe;

or:

- (b) When a vapour pipe connects two or more cargo tanks, a pressure/vacuum relief device provided with a flame-arrester shall be fitted at the connection to each cargo tank; the gas expelled shall be discharged into the vapour pipe. Several different substances may be carried simultaneously in a vessel if they do not react dangerously with each other in the gaseous phase;

or:

- (c) Each tank has its own vapour pipe fitted with a vacuum relief valve incorporating a flame-arrester and a high-velocity vent valve with a flame-arresting effect. Several different substances may be carried simultaneously on board.

321 223 Pressure tests

(1) The cargo tanks, residual cargo tanks, cofferdams, pipes for loading and unloading shall be subjected to initial tests before being put into service and thereafter at prescribed intervals.

Where a heating system is provided inside the cargo tanks, the heating coils shall be subjected to initial tests before being put into service and thereafter at prescribed intervals.

(2) The test pressure for the cargo tanks and residual cargo tanks shall be not less than 1.3 times the construction pressure. The test pressure for the cofferdams and open cargo tanks shall be not less than 10 kPa (0.10 bar) gauge pressure.

(3) The test pressure for pipes for loading and unloading shall be not less than 1000 kPa (10 bar) gauge pressure.

(4) The maximum intervals for the periodic tests shall be 11 years.

(5) The procedure for pressure tests shall comply with the provisions established by the competent authority or a recognized classification society.

321 224

321 225 Pumps and piping

(1) Pumps, compressors and accessory loading and unloading piping shall be placed in the cargo area. Cargo pumps shall be capable of being shut down from the cargo area and, in addition, from a position outside the cargo area.

Cargo pumps situated on deck shall be located not less than 6.00 m from entrances to, or openings of, the accommodation and service spaces outside the cargo area.

(2) (a) Pipes for loading and unloading shall be independent of any other piping of the vessel. No cargo piping shall be located below deck, except those inside the cargo tanks and inside the cargo pump-room.

(b) The pipes for loading and unloading shall be arranged so that, after loading or

Annex B.2 - Part III - Chapter 2

**321 225
(cont'd)**

unloading operations, the liquid remaining in these pipes may be safely removed and may flow either into the vessel's tanks or the tanks ashore.

- (c) Pipes for loading and unloading shall be clearly distinguishable from other piping, e.g. by means of colour marking.
- (d) The pipes for loading and unloading located on deck, with the exception of the shore connections, shall be located not less than a quarter of the vessel's breadth from the outer shell.
- (e) The shore connections shall be located not less than 6.00 m from the entrances to, or openings of, the accommodation and service spaces outside the cargo area.
- (f) Each shore connection of the vapour pipe and shore connections of the pipes for loading and unloading, through which the loading or unloading operation is carried out, shall be fitted with a shut-off device. However, each shore connection shall be fitted with a blind flange when it is not in operation.

Each shore connection of the pipes for loading and unloading through which the loading or unloading operation is carried out shall be fitted with the device intended for the discharge of residual cargo described in Model No.1 of Appendix 3.

- (g) The vessel shall be equipped with a permanently installed stripping system.
- (h) The flanges and stuffing boxes shall be provided with a spray protection device.

(3) The distance referred to in (1) and (2) (e) may be reduced to 3.00 m if a transverse bulkhead complying with 321 210 (2) is situated at the end of the cargo area. The openings shall be provided with doors.

The following notice shall be displayed on the doors:

**DO NOT OPEN DURING LOADING AND UNLOADING WITHOUT
THE PERMISSION OF THE STEERSMAN.
CLOSE IMMEDIATELY.**

- (4) (a) Every component of the pipes for loading and unloading shall be electrically connected to the hull.
 - (b) The pipes for loading shall extend down to the bottom of the cargo tanks.
- (5) The stop valves or other shut-off devices of the pipes for loading and unloading shall indicate whether they are open or shut.
- (6) The pipes for loading and unloading shall have, at the test pressure, the required elasticity, leakproofness and resistance to pressure.
- (7) The pipes for loading and unloading shall be fitted with pressure gauges at the pump outlet.

321 225 Where these pressure gauges are manometers, the indicator scale shall have a diameter of not

Annex B.2 - Part III - Chapter 2

(cont'd) less than 0.14 m.

Reading of the pressure gauges shall be possible from the control position of the loading pump at any time. The maximum permissible overpressure or vacuum shall be indicated by a red mark.

(8) (a) When pipes for loading and unloading are used for supplying the cargo tanks with washing or ballast water, the suctions of these pipes shall be located within the cargo area but outside the cargo tanks.

Pumps for tank washing systems with associated connections may be located outside the cargo area, provided the discharge side of the system is arranged in such a way the suction is not possible through that part.

A spring-loaded non-return valve shall be provided to prevent any gases from being expelled from the cargo area through the tank washing system.

(b) A non-return valve shall be fitted at the junction between the water suction pipe and the cargo loading pipe.

(9) The maximum permissible loading rate for each cargo tank and for the vessel determined in relation to the design of the cargo tanks, the pipes for loading and unloading, the vapour pipe and safety devices shall be indicated in the certificate of approval.

(10) The stripping system shall be subjected to initial tests before being put into service or thereafter if any alteration has been made to it, using water as test medium. The test and the determination of the residual quantities shall be carried out in accordance with the requirements of Model No. 2 of Appendix 3.

In this test, the following residual quantities shall not be exceeded:

- (a) 5 l for each cargo tank;
- (b) 15 l for each pipe system.

The residual quantities obtained in the test shall be entered in the certificate for the test of stripping system referred to in marginal 210 381 (3) (c).

321 226 Residual cargo tanks and slop tanks

(1) The vessel shall be provided with at least one residual cargo tank and with slop tanks for slops which are not suitable for pumping. These tanks shall be located only in the cargo area. Intermediate bulk containers or tank-containers in accordance with marginal 210 401 may be used instead of a fixed residual cargo tank. During filling of these intermediate bulk containers or tank-containers, means for collecting any leakage shall be placed under the filling connections.

(2) Slop tanks shall be fire resistant and shall be capable of being closed with lids (e.g. drums with lever closing ring lids). The tanks shall be marked and easy to handle.

(3) The maximum capacity of a residual cargo tank is 30 m³.

321 226 The residual cargo tank shall be equipped with:
(cont'd)

Annex B.2 - Part III - Chapter 2

- pressure/vacuum valves fitted with a flame—arrester. The pressure valve and the flame—arrester shall form a single appliance designed for the high speed ejection of gases. The educt or shall be so regulated that it does not open during the transport operation. This condition is complied with when the opening pressure of the valve meets the conditions required in the list of substances in Appendix 4 for the substance to be carried;
- an ullage opening capable of being closed;
- connections, with stop valves, for pipes and hoses.

No connection between the residual cargo tanks and the vapour pipe of the cargo tanks is permitted.

The residual cargo tanks, the intermediate bulk containers or tank—containers placed on the deck shall be located at a minimum distance from the hull equal to a quarter of the vessel's breadth.

321 227

321 228 Water-spray system

When water-spraying is required in the list of substances of Appendix 4, a water-spray system shall be installed in the cargo area on deck for the purpose of reducing vapours given off by the cargo, and of cooling the tops of cargo tanks.

The system shall be fitted with a connection device for supply from the shore. The system shall be capable of being put into operation from the wheelhouse and from the deck. The capacity of the water-spray system shall be such that when all the spray nozzles are in operation, the outflow is of 50 litres per square metre of cargo deck area and per hour.

321 229-

321 230

321 231 Engines

- (1) Only internal combustion engines running on fuel with a flashpoint of more than 55 °C are allowed.
- (2) Ventilation inlets of the engine room, and when the engines do not take in air directly from the engine room, air intakes of the engines shall be located not less than 2.00 m from the cargo area.
- (3) Sparking shall not be possible within the cargo area.
- (4) The surface temperature of the outer parts of engines used during loading or unloading operations, as well as that of their air inlets and exhaust ducts shall not exceed the allowable temperature according to the temperature class. This provision does not apply to engines installed in service spaces provided the provisions of marginal 321 252 (3) (b) are fully complied with.

**321 231
(cont'd)**

- (5) The ventilation in the closed engine room shall be designed so that, at an ambient temperature of 20 °C, the average temperature in the engine room does not exceed 40 °C.

Annex B.2 - Part III - Chapter 2

321 232 Oil fuel tanks

(1) Where the vessel is provided with hold spaces, the double bottoms within these spaces may be arranged as oil fuel tanks, provided their depth is not less than 0.60 m.

Oil fuel pipes and openings of such tanks are not permitted in the hold space.

(2) The air pipes of all oil fuel tanks shall extend to 0.5 m above the open deck. Their open ends and the open ends of overflow pipes leading to the deck shall be fitted with a protective device consisting of a gauze diaphragm or a perforated plate.

321 233

321 234 Exhaust pipes

(1) Exhausts shall be evacuated from the vessel into the open air either upwards through an exhaust pipe or through the shell plating. The exhaust outlet shall be located not less than 2.00 m from the cargo area. The exhaust pipes of engines shall be arranged so that the exhausts are led away from the vessel. The exhaust pipes shall not be located within the cargo area.

(2) Exhaust pipes shall be provided with a device preventing the escape of sparks, e.g. spark arresters.

321 235 Bilge pumping and ballasting arrangements

(1) Bilge and ballast pumps for spaces within the cargo area shall be installed within such area.

This provision does not apply to:

- double-hull spaces and double bottoms which do not have a common boundary wall with the cargo tanks;
- cofferdams and hold spaces where ballasting is carried out using the piping of the fire-fighting system in the cargo area and bilge-pumping is performed using eductors.

(2) Where the double bottom is used as an oil fuel tank, it shall not be connected to the bilge piping system.

(3) Where the ballast pump is installed in the cargo area, the standpipe and its outboard connection for suction of ballast water shall be located within the cargo area but outside the cargo tanks.

(4) A cargo pump-room below deck shall be capable of being drained in an emergency by an installation located in the cargo area and independent from any other installation. This installation shall be provided outside the cargo pump-room.

**321 236-
321 239**

321 240 Fire-extinguishing arrangements

Annex B.2 - Part III - Chapter 2

(1) A fire-extinguishing system shall be installed on the vessel. This system shall comply with the following requirements:

- It shall be supplied by two independent fire or ballast pumps, one of which shall be ready for use at any time. These pumps shall not be installed in the same space;
- It shall be provided with a water main fitted with at least three hydrants in the cargo area above deck. Three suitable and sufficiently long hoses with spray nozzles having a diameter of not less than 12 mm shall be provided. It shall be possible to reach any point of the deck in the cargo area simultaneously with at least two jets of water which do not emanate from the same hydrant.

A spring-loaded non-return valve shall be fitted to ensure that no gases can escape through the fire-extinguishing system into the accommodation or service spaces outside the cargo area;

- The capacity of the system shall be at least sufficient for a jet of water to have a minimum reach of not less than the vessel's breadth from any location on board with two spray nozzles being used at the same time.

(2) In addition, the engine rooms, the cargo pump-rooms and all spaces containing essential equipment under deck (diesel generators, switch boards, compressors, etc.) for the refrigeration equipment, if any, shall be provided with a fixed fire-extinguishing system which can be operated from the deck.

(3) The two hand fire-extinguishers referred to in marginal 210 240 shall be located in the cargo area.

321 241 Fire and naked light

(1) The outlets of funnels shall be located not less than 2.00 m from the cargo area. Arrangements shall be provided to prevent the escape of sparks and the entry of water.

(2) Heating, cooking and refrigerating appliances shall not be fuelled with liquid fuels, liquid gas or solid fuels.

The installation in the engine room or in an other separate space of heating appliances fuelled with liquid fuel having a flash-point above 55 °C is, however, permitted.

Cooking and refrigerating appliances are permitted only in the accommodation.

(3) Only electrical lighting appliances are permitted.

321 242 Cargo heating system

(1) Boilers which are used for heating the cargo shall be fuelled with a liquid fuel having a flashpoint of more than 55 °C. They shall be placed either in the engine room or in another separate space below deck and outside the cargo area, which is accessible from the deck or from the engine room.

321 242 (cont'd) (2) The cargo heating system shall be designed so that the cargo cannot penetrate into the boiler in the case of a leak in the heating coils. A cargo heating system with artificial draught

Annex B.2 - Part III - Chapter 2

shall be ignited electrically.

(3) The ventilation system of the engine room shall be designed taking into account the air required for the boiler.

(4) Where the cargo heating system is used during loading, unloading or gas-freeing, the service space which contains this system shall fully comply with the requirements of marginal 321 252 (3) (b). This requirement does not apply to the inlets of the ventilation system. These inlets shall be located at a minimum distance of 2.00 m from the cargo area and 6.00 m from the openings of cargo tanks or residual cargo tanks, loading pumps situated on deck, openings of high velocity vent valves, pressure valves and shore connections of loading and unloading pipes and must be located not less than 2.00 m above the deck.

**321 243-
321 249**

321 250 Documents concerning electrical installations

(1) In addition to the documents required by the "Recommendations on Technical Requirements for Inland Navigation Vessels", the following documents shall be on board:

- (a) a drawing indicating the boundaries of the cargo area and the location of the electrical equipment installed in this area;
- (b) a list of the electrical equipment referred to in (a) above including the following particulars:

machine or appliance, location, type of protection, type of protection against explosion, testing body and approval number;
- (c) a list of or general plan indicating the electrical equipment outside the cargo area which may be operated during loading, unloading or gas-freeing. All other electrical equipment shall be marked in red. See marginal 321 252 (3) and (4).

(2) The documents listed above shall bear the stamp of the competent authority issuing the certificate of approval.

321 251 Electrical installations

(1) Only distribution systems without return connection to the hull are permitted:

This provision does not apply to:

- local installations outside the cargo area (e.g. connections of starters of diesel engines);
- the device for checking the insulation level referred to in (2) below.

321 251 (cont'd) (2) Every insulated distribution network shall be fitted with an automatic device with a visual and audible alarm for checking the insulation level.

Annex B.2 - Part III - Chapter 2

(3) For the selection of electrical equipment to be used in zones presenting an explosion risk, the explosion groups and temperature classes assigned to the substances carried in the list of substances of Appendix 4 shall be taken in to consideration.

321 252 Type and location of electrical equipment

- (1) (a) Only the following equipment may be installed in cargo tanks, residual cargo tanks and pipes for loading and unloading (comparable to zone 0):
- measuring, regulation and alarm devices of the EEx (ia) type of protection;
- (b) Only the following equipment may be installed in the cofferdams, double-hull spaces, double bottoms and hold spaces (comparable to zone 1):
- measuring, regulation and alarm devices of the "certified safe" type;
 - lighting appliances of the "flame-proof enclosure" or "pressurized enclosure" type of protection;
 - hermetically sealed echo sounding devices the cables of which are led through thick-walled steel tubes with gastight connections up to the main deck;
 - cables for the active cathodic protection of the shell plating in protective steel tubes such as those provided for echo sounding devices;
- (c) Only the following equipment may be installed in the service spaces in the cargo area below deck (comparable to zone 1):
- measuring, regulation and alarm devices of the "certified safe" type;
 - lighting appliances of the "flame-proof enclosure" or "pressurized apparatus" type of protection;
 - motors driving essential equipment such as ballast pumps; they shall be of the "certified safe" type;
- (d) The control and protective equipment of the electrical equipment referred to in paragraphs (a), (b) and (c) above shall be located outside the cargo area if they are not intrinsically safe;
- (e) The electrical equipment in the cargo area on deck (comparable to zone 1) shall be of the "certified safe" type.
- (2) Accumulators shall be located outside the cargo area.
- (3) (a) Electrical equipment used during loading, unloading and gas-freeing during berthing and which are located outside the cargo area shall (comparable to zone 2) be at least of the "limited explosion risk" type.
- (b) This provision does not apply to:
- (i) lighting installations in the accommodation, except for switches near entrances to accommodation;

321 252
(cont'd)

Annex B.2 - Part III - Chapter 2

- (ii) radiotelephone installations in the accommodation or the wheelhouse;
- (iii) electrical installations in the accommodation, the wheelhouse or the service spaces outside the cargo areas if:
 - 1. These spaces are fitted with a ventilation system ensuring an overpressure of 0.1 kPa (0.001 bar) and none of the windows is capable of being opened; the air intakes of the ventilation system shall be located as far away as possible, however, not less than 6.00 m from the cargo area and not less than 2.00 m above the deck;
 - 2. The spaces are fitted with a gas detection system with sensors:
 - at the suction inlets of the ventilation system;
 - directly at the top edge of the sill of the entrance doors of the accommodation and service spaces;
 - 3. The gas concentration measurement is continuous;
 - 4. When the gas concentration reaches 20% of the lower explosive limit, the ventilators are switched off. In such a case and when the overpressure is not maintained or in the event of failure of the gas detection system, the electrical installations which do not comply with (a) above, shall be switched off. These operations shall be performed immediately and automatically and activate the emergency lighting in the accommodation, the wheelhouse and the service spaces, which shall comply at least with the "limited explosion risk" type. The switching-off shall be indicated in the accommodation and wheelhouse by visual and audible signals;
 - 5. The ventilation system, the gas detection system and the alarm of the switch-off device fully comply with the requirements of (a) above;
 - 6. The automatic switching-off device is set so that no automatic switch off may occur while the vessel is under way.

(4) The electrical equipment which do not meet the requirements set out in (3) above together with their switches shall be marked in red. The disconnection of such equipment shall be operated from a centralized location on board.

(5) An electric generator which is permanently driven by an engine and which does not meet the requirements of paragraph (3) above, shall be fitted with a switch capable of shutting down the excitation of the generator. A notice board with the operating instructions shall be displayed near the switch.

**321 252
(cont'd)**

(6) Sockets for the connection of signal lights and gangway lighting shall be permanently fitted to the vessel close to the signal mast or the gangway. Connecting and disconnecting shall not be possible except when the sockets are not live.

(7) The failure of the power supply for the safety and control equipment shall be immediately indicated by visual and audible signals at the locations where the alarms are

Annex B.2 - Part III - Chapter 2

usually actuated.

321 253 Earthing

(1) The metal parts of electrical appliances in the cargo area which are not live as well as protective metal tubes or metal sheaths of cables in normal service shall be earthed, unless they are so arranged that they are automatically earthed by bonding to the metal structure of the vessel.

(2) The provisions of paragraph (1) above apply also to equipment having service voltages of less than 50 V.

(3) Independent cargo tanks, metal intermediate bulk containers and tank-containers shall be earthed.

**321 254-
321 255**

321 256 Electrical cables

(1) All cables in the cargo area shall have a metallic sheath.

(2) Cables and sockets in the cargo area shall be protected against mechanical damage.

(3) Movable cables are prohibited in the cargo area, except for intrinsically safe electric circuits or for the supply of signal lights and gangway lighting.

(4) Cables of intrinsically safe circuits shall only be used for such circuits and shall be separated from other cables not intended for being used in such circuits (e.g. they shall not be installed together in the same string of cables and they shall not be fixed by the same cable clamps).

(5) For movable cables intended for signal lights and gangway lighting, only sheathed cables of type H 07 RN-F in accordance with 245 IEC 66 or cables of at least equivalent design having conductors with a cross-section of not less than 1.5 mm² shall be used.

These cables shall be as short as possible and installed so that damage is not likely to occur.

**321 257-
321 259**

321 260 Special equipment

A shower and an eye and face bath shall be provided on the vessel at a location which is directly accessible from the cargo area.

**321 261-
321 270**

321 271 Admittance on board

The notice boards displaying the prohibition of admittance in accordance with marginal 210 371 shall be clearly legible from either side of the vessel.

Annex B.2 - Part III - Chapter 2

**321 272-
321 273**

321 274 Prohibition of smoking, fire or naked light

(1) The notice boards displaying the prohibition of smoking in accordance with marginal 210 374 shall be clearly legible from either side of the vessel.

(2) Notice boards indicating the circumstances under which the prohibition is applicable shall be fitted near the entrances to the spaces where smoking or the use of fire or naked light is not always prohibited.

(3) Asht rays shall be provided close to each exit of the accommodation and the wheelhouse.

**321 275
321 291**

321 292 Emergency exit

Spaces the entrances or exits of which are likely to become partly or completely immersed in the damaged condition shall have an emergency exit which is situated not less than 0.10 m above the damage waterline. This does not apply to forepeak and afterpeak.

**321 293-
330 999**

Annex B.2 - Part III - Chapter 3

CHAPTER 3

Rules for construction of type N tank vessels

**331 000-
331 099**

331 100 General

The rules for construction of Chapter 3 of Part III apply to type N tank vessels.

**331 101-
331 199**

331 200 Materials of construction

- (1) (a) The vessel's hull and the cargo tanks shall be constructed of shipbuilding steel or other at least equivalent metal.

The independent cargo tanks may also be constructed of other materials, provided these have at least equivalent mechanical properties and resistance against the effects of temperature and fire.

- (b) Every part of the vessel including any installation and equipment which may come into contact with the cargo shall consist of materials which can neither be dangerously affected by the cargo nor cause decomposition of the cargo or react with it so as to form harmful or hazardous products.

- (2) Except where explicitly permitted in (3) below or in the certificate of approval, the use of wood, aluminium alloys or plastic materials within the cargo area is prohibited.

- (3) (a) The use of wood, aluminium alloys or plastic materials within the cargo area is only permitted for:

- gangways and external ladders;
- movable items of equipment (aluminium gauging rods are, however, permitted provided that they are fitted with brass feet or protected in another way to avoid sparking);
- chocking of cargo tanks which are independent of the vessel's hull and chocking of installations and equipment;
- masts and similar round timber;
- engine parts;
- parts of the electrical installation;
- loading and unloading appliances;
- lids of boxes which are placed on the deck.

- (b) The use of wood or plastic materials within the cargo area is only permitted for:

- supports and stops of any kind.

- (c) The use of plastic materials or rubber within the cargo area is only permitted for:

Annex B.2 - Part III - Chapter 3

**331 200
(cont'd)**

- coating of cargo tanks and of hoses for loading and unloading;
- all kinds of gaskets (e.g. for dome or hatch covers);
- electric cables;
- hoses for loading and unloading;
- insulation of cargo tanks and of hoses for loading and unloading.

(d) All permanently fitted materials in the accommodation or wheelhouse, with the exception of furniture, shall not readily ignite. They shall not evolve fumes or toxic gases in dangerous quantities, if involved in a fire.

(4) The paint used in the cargo area shall not be liable to produce sparks in case of impact.

(5) The use of plastic material for vessel's boats is permitted only if the material does not readily ignite.

**331 201-
331 207**

331 208 Classification

(1) The tank vessel shall be built under survey of a recognized classification society in accordance with the rules established by that classification society for its highest class, and the tank vessel shall be classed accordingly.

The vessel's class shall be continued.

(2) The cargo pump-rooms shall be inspected by a recognized classification society whenever the certificate of approval has to be renewed as well as during the third year of validity of the certificate of approval. The inspection shall comprise at least:

- an inspection of the whole system for its condition, for corrosion, leakage or conversion works which have not been approved;
- a checking of the condition of the gas detection system in the cargo pump-rooms.

Inspection certificates signed by the recognized classification society with respect to the inspection of the cargo pump-rooms shall be kept on board. The inspection certificates shall at least include particulars of the above inspection and the results obtained as well as the date of the inspection.

(3) The condition of the gas detection system referred to in marginal 331 252 (3) (b) shall be checked by a recognized classification society whenever the certificate of approval has to be renewed and during the third year of validity of the certificate of approval. A certificate signed by the recognized classification society shall be kept on board.

(4) Paragraphs (2) and (3), checking of the condition of the gas detection system, do not apply to open type N.

331 209

Annex B.2 - Part III - Chapter 3**331 210 Protection against the penetration of gases**

- (1) The vessel shall be designed so as to prevent gases from penetrating into the accommodation and the service spaces.
- (2) The sills of doors in the sidewalls of superstructures and the coaming of access hatches to under-deck spaces shall have a height of not less than 0.50 m.

This requirement need not be complied with if the wall of the superstructures facing the cargo area extends from one side of the ship to the other and has doors the sills of which have a height of not less than 0.50 m. The wall shall have a height not less than 2.00 m.

In this case, the sills of doors in the sidewalls of superstructures and of access hatches behind this wall shall have a height of not less than 0.10 m. The sills of engine room doors and the coamings access hatches shall, however, always have a height of not less than 0.50 m.

- (3) The bulwarks shall be provided with sufficiently large openings which are located directly above the deck.
- (4) Paragraphs (1) to (3) above do not apply to open type N.

331 211 Hold spaces and cargo tanks

- (1) (a) The maximum permissible capacity of a cargo tank shall be determined in accordance with the following table:

L · B · H (m³)	Maximum permissible capacity of a cargo tank (m³)
up to 600	$L \cdot B \cdot H \cdot 0.3$
600 to 3 750	$180 + (L \cdot B \cdot H - 600) \cdot 0.0635$
> 3 750	380

In the table above $L \cdot B \cdot H$ is the product of the main dimensions of the tank vessel in metres (according to the measurement certificate), where:

- L = overall length of the hull, in m;
 B = extreme breadth of the hull, in m;
 H = shortest vertical distance between the top of the keel and the lowest point of the deck at the side of the vessel (moulded depth) within the cargo area, in m;

For trunk vessels, H shall be replaced by H', where H' shall be obtained from the following formula:

$$H' = H + (ht \cdot bt/B \cdot lt/L)$$

where:

- ht = trunk height, in m (distance between trunk deck and main deck measured on trunk side at L/2);

Annex B.2 - Part III - Chapter 3

**331 211
(cont'd)**

bt = trunk breadth, in m;
lt = trunk length, in m.

- (b) The relative density of the substances to be carried shall be taken into consideration in the design of the cargo tanks. The maximum relative density shall be indicated in the certificate of approval.
- (c) When the vessel is provided with pressure cargo tanks, these tanks shall be designed for a working pressure of 400 kPa (4 bar).
- (d) For vessels with a length of not more than 50.00 m, the length of a cargo tank shall not exceed 10.00 m;

for vessels with a length of more than 50.00 m, the length of a cargo tank shall not exceed 0.20 L.

This provision does not apply to vessels with independent built-in cylindrical tanks having a length to diameter ratio ≤ 7 .

- (2) (a) The cargo tanks independent of the vessel's hull shall be fixed so that they cannot float.
- (b) The capacity of a suction well shall be limited to not more than 0.10 m³.
- (3) (a) The cargo tanks shall be separated by cofferdams of at least 0.60 m in width from the accommodation, engine room and service spaces outside the cargo area below deck or, if there are no such accommodation, engine room and service spaces, from the vessel's ends. Where the cargo tanks are installed in a hold space, a space of not less than 0.50 m shall be provided between such tanks and the end bulkheads of the hold space. In this case an insulated end bulkhead meeting the definition for Class "A-60" according to SOLAS II-2, Regulation 3, shall be deemed equivalent to a cofferdam. For pressure cargo tanks, the 0.50 m distance may be reduced to 0.20 m.
- (b) Hold spaces, cofferdams and cargo tanks shall be capable of being inspected.
- (c) All spaces in the cargo area shall be capable of being ventilated. Means for checking their gas-free condition shall be provided.

(4) The bulkheads bounding the cargo tanks, cofferdams and hold spaces shall be watertight. The cargo tanks, cofferdams and the end bulkheads of the hold spaces, as well as the bulkheads bounding the cargo area shall have no openings or penetrations below deck. Penetrations through bulkheads between two hold spaces are, however, permitted.

The bulkhead between the engine room and the cofferdam or service space in the cargo area or between the engine room and a hold space may be fitted with penetrations provided that they conform to the provisions of marginal 331 217 (5).

The bulkhead between the cargo tank and the cargo pump-room below deck may be fitted with penetrations provided that they conform to the provisions of marginal 331 217 (6). If the vessel is fitted with a cargo pump-room below deck, the bulkheads between the cargo tanks may be fitted with passages provided that the loading pipes are fitted with shut-off

Annex B.2 - Part III - Chapter 3

331 211 (cont'd) devices in the cargo tank direct at the bulkhead and in the cargo pump-room direct at the bulkhead. The shut-off devices shall be capable of being activated from the deck.

(5) Double-hull spaces and double bottoms in the cargo area shall be arranged for being filled with ballast water only. Double bottoms may, however, be used as oil fuel tanks, provided they comply with the provisions of marginal 331 232.

- (6) (a) A cofferdam, the centre part of a cofferdam or another space below deck in the cargo area may be arranged as a service space, provided the bulkheads bounding the service space extend vertically to the bottom. This service space shall only be accessible from the deck.
- (b) The service space shall be watertight with the exception of its access hatches and ventilation inlets.
- (c) No pipes for loading and unloading shall be fitted within the service space referred to under (4) above.

Pipes for loading and unloading may be fitted in the cargo pump-rooms below deck only when they conform to the provisions of marginal 331 217 (6).

(7) Where service spaces are located in the cargo area under deck, they shall be arranged so as to be easily accessible and to permit persons wearing protective clothing and breathing apparatus to safely operate the service equipment contained therein. They shall be designed so as to allow injured or unconscious personnel to be removed from such spaces without difficulties, if necessary by means of fixed equipment.

(8) Cofferdams, double-hull spaces, double bottoms, cargo tanks, hold spaces and other accessible spaces within the cargo area shall be arranged so that they may be completely inspected and cleaned. The dimensions of openings except for those of double-hull spaces and double bottoms which do not have a wall adjoining the cargo tanks shall be sufficient to allow a person wearing breathing apparatus to enter or leave the space without difficulties. These openings shall have a minimum cross-section of 0.36 m² and a minimum side length of 0.50 m. They shall be designed so as to allow injured or unconscious personnel to be removed from the bottom of such a space without difficulties, if necessary by means of fixed equipment. In these spaces the distance between the reinforcements shall not be less than 0.50 m. In double bottoms this distance may be reduced to 0.45 m.

Cargo tanks may have circular openings with a diameter of not less than 0.68 m.

(9) Paragraphs (4) to (6) above do not apply to open type N.

331 212 Ventilation

(1) Double-hull spaces and double bottoms within the cargo area which are not arranged for being filled with ballast water, hold spaces and cofferdams shall be provided with ventilation systems.

(2) Any service spaces located in the cargo area below deck shall be provided with a system of forced ventilation with sufficient power for ensuring at least 20 changes of air per hour based on the volume of the space. The ventilator fan shall be designed so that no sparks may be emitted on contact of the impeller blades with the housing and no static electricity may be generated.

Annex B.2 - Part III - Chapter 3

331 212 (cont'd) The ventilation exhaust ducts shall be located up to 50 mm above the bottom of the service space. The fresh air inlets shall be located in the upper part; they shall be not less than 2.00 m above the deck, not less than 2.00 m from the openings of the cargo tanks and not less than 6.00 m from the outlets of safety valves. The extension pipes which may be necessary may be of the hinged type.

On board open type N vessels fixed ventilation devices shall be sufficient.

(3) Ventilation of accommodation and service spaces shall be possible.

(4) Ventilators used for gas-freeing of tanks shall be designed so that no sparks may be emitted on contact of the impeller blades with the housing and no static electricity may be generated.

(5) Notice boards shall be fitted at the ventilation inlets indicating the conditions when they shall be closed. Any ventilation inlets of accommodation and service spaces leading outside shall be fitted with fire flaps. Such ventilation inlets shall be located not less than 2.00 m from the cargo area.

Ventilation inlets of service spaces in the cargo area below deck may be located within such area.

(6) Flame-arresters prescribed in marginals 331 220 (4), 331 221 (11), 331 222 (4) and (5) and 331 226 (2) shall be of a type approved for this purpose by the competent authority.

(7) Paragraphs (4) to (6) above do not apply to open type N.

331 213 Stability (general)

(1) Proof of sufficient stability shall be furnished. This proof is not required for vessels with cargo tanks the width of which is not more than $0.70 \cdot B$.

(2) The basic values for the stability calculation - the vessel's lightweight and location of the centre of gravity - shall be determined either by means of an inclining experiment or by detailed mass and moment calculation. In the latter case the lightweight of the vessel shall be checked by means of a lightweight test with a tolerance limit of $\pm 5\%$ between the mass determined by calculation and the displacement determined by the draught readings.

(3) Proof of sufficient intact stability shall be furnished for all stages of loading and unloading and for the final loading condition.

331 214 Stability (intact)

For vessels with cargo tanks the width of which is more than $0.70 \cdot B$, proof shall be furnished that, at an angle of 5° or, when this angle is less, at a heeling angle at which an opening becomes immersed, the righting arm is 0.10 m. The stability-reducing free surface effect in the case of cargo tanks filled to less than 95% of their capacity shall be taken into account.

331 215

331 216 Engine rooms

Annex B.2 - Part III - Chapter 3

- (1) Internal combustion engines for the vessel's propulsion as well as internal combustion engines for auxiliary machinery shall be located outside the cargo area. Entrances and other openings of engine rooms shall be at a distance of not less than 2.00 m from the cargo area.
- (2) The engine rooms shall be accessible from the deck; the entrances shall not face the cargo area. Where the doors are not located in a recess whose depth is at least equal to the door width, the hinges shall face the cargo area.
- (3) The last sentence of paragraph (2) does not apply to oil separator or supply vessels.

331 217 Accommodation and service spaces

- (1) Accommodation spaces and the wheelhouse shall be located outside the cargo area forward of the fore vertical plane or abaft the aft vertical plane bounding the part of cargo area below deck. Windows of the wheelhouse which are located not less than 1.00 m above the bottom of the wheelhouse may tilt forward.
- (2) Entrances to spaces and openings of superstructures shall not face the cargo area. Doors opening outward and not located in a recess whose depth is at least equal to the width of the doors shall have their hinges face the cargo area.
- (3) Entrances from the deck and openings of spaces facing the weather shall be capable of being closed. The following instruction shall be displayed at the entrance of such spaces:

**DO NOT OPEN DURING LOADING, UNLOADING OR GAS-FREEING
WITHOUT PERMISSION FROM THE STEERSMAN.
CLOSE IMMEDIATELY.**

- (4) Entrances and windows of superstructures and accommodation spaces which can be opened as well as other openings of these spaces shall be located not less than 2.00 m from the cargo area. No wheelhouse doors and windows shall be located within 2.00 m from the cargo area, except where there is no direct connection between the wheelhouse and the accommodation.
- (5)
 - (a) Driving shafts of the bilge or ballast pumps may penetrate through the bulkhead between the service space and the engine room, provided the arrangement of the service space is in compliance with marginal 331 211 (6).
 - (b) The penetration of the shaft through the bulkhead shall be gastight and shall have been approved by a recognized classification society.
 - (c) The necessary operating instructions shall be displayed.
 - (d) Penetrations through the bulkhead between the engine room and the service space in the cargo area and the bulkhead between the engine room and the hold spaces may be provided for electrical cables, hydraulic lines and piping for measuring, control and alarm systems, provided that the penetrations have been approved by a recognized classification society. The penetrations shall be gastight. Penetrations through a bulkhead with an "A-60" fire protection insulation according to SOLAS II-2, Regulation 3, shall have an equivalent fire protection.

Annex B.2 - Part III - Chapter 3

**331 217
(cont'd)**

- (e) Pipes may penetrate the bulkhead between the engine room and the service space in the cargo area provided that these are pipes between the mechanical equipment in the engine room and the service space which do not have any openings within the service space and which are provided with shut-off devices at the bulkhead in the engine room.
 - (f) Pipes from the engine room may penetrate through the service space in the cargo area or a cofferdam or a hold space to the outside provided that within the service space or cofferdam or hold space they are of the thick-walled type and have no flanges or openings.
 - (g) Where a driving shaft of auxiliary machinery penetrates through a wall located above the deck the penetration shall be gastight.
- (6) A service space located within the cargo area below deck shall not be used as a cargo pump-room for the loading and unloading system, except where:
- the pump-room is separated from the engine room or from service spaces outside the cargo area by a cofferdam or a bulkhead with an "A-60" fire protection insulation according to SOLAS Chapter II-2, Regulation 3, or by a service space or a hold space;
 - the "A-60" bulkhead required above does not include penetrations referred to in paragraph (5) (a);
 - ventilation exhaust outlets are located not less than 6.00 m from entrances and openings of the accommodation and service spaces outside the cargo area;
 - the access hatches and ventilation inlets can be closed from the outside;
 - all pipes for loading and unloading as well as those of stripping systems are provided with shut-off devices at the pump suction side in the cargo pump-room immediately at the bulkhead. The necessary operation of the control devices in the pump-room, starting of pumps and control of the liquid flow rate shall be effected from the deck;
 - the bilge of the cargo pump-room is equipped with a gauging device for measuring the filling level which activates a visual and audible alarm in the wheelhouse when liquid is accumulating in the cargo pump-room bilge;
 - the cargo pump-room is provided with a permanent gas detection system which automatically indicates the presence of explosive gases or lack of oxygen by means of direct-measuring sensors and which actuates a visual and audible alarm when the gas concentration has reached 20% of the lower explosive limit. The sensors of this system shall be placed at suitable positions at the bottom and directly below the deck.

Measurement shall be continuous.

The audible and visual alarms are installed in the wheelhouse and in the cargo pump-room and, when the alarm is actuated, the loading and unloading system is shut down. Failure of the gas detection system shall be immediately signalled in the wheelhouse and on deck by means of audible and visual alarms;

331 217

- the ventilation system prescribed in marginal 331 212 (2) has a capacity of not

Annex B.2 - Part III - Chapter 3

(cont'd) less than 30 changes of air per hour based on the total volume of the service space.

(7) The following instruction shall be displayed at the entrance of the cargo pump-room:

BEFORE ENTERING THE CARGO PUMP-ROOM CHECK WHETHER IT IS FREE FROM GASES AND CONTAINS SUFFICIENT OXYGEN. DO NOT OPEN DOORS AND ENTRANCE OPENINGS WITHOUT THE PERMISSION OF THE STEERSMAN. LEAVE IMMEDIATELY IN THE EVENT OF ALARM.

(8) Paragraphs (5) (g), (6) and (7) do not apply to open type N.

Paragraphs (2), last sentence, (3), last sentence and (4) do not apply to oil separator and supply vessels.

**331 218-
331 219**

331 220 Arrangement of cofferdams

(1) Cofferdams or cofferdam compartments located next to a service space which has been arranged in accordance with marginal 331 211 (6) shall be accessible through an access hatch. The access hatches and ventilation inlets shall be located not less than 0.50 m above the deck.

(2) Cofferdams shall be capable of being filled with water and emptied by means of a pump. Filling shall be effected within 30 minutes. The cofferdams shall not be fitted with inlet valves.

(3) No fixed pipe shall permit connection between a cofferdam and other piping of the vessel outside the cargo area.

(4) The ventilation openings of cofferdams shall be fitted with a flame-arrester.

(5) Paragraph (4) above does not apply to open type N.

Paragraph (2) above does not apply to oil separator and supply vessels.

331 221 Safety and control installations

(1) Cargo tanks shall be provided with the following equipment:

(a) a mark inside the tank indicating the liquid level of 97%;

(b) a level gauge;

(c) a level alarm device which is activated at the latest when a degree of filling of 90% is reached;

(d) a high level sensor for actuating the facility against overflowing at the latest when a degree of filling of 97.5% is reached;

(e) an instrument for measuring the pressure of the vapour phase inside the cargo tank;

**331 221
(cont'd)**

(f) an instrument for measuring the temperature of the cargo, when a system for heating the cargo is required in the list of substances of Appendix 4 or a maximum temperature is indicated in column 20 of that list;

Annex B.2 - Part III - Chapter 3

- (g) a sampling device of the closed type or of the partly closed type and/or a sampling opening as required in the list of substances of Appendix 4;
 - (h) an ullage opening.
- (2) When the degree of filling in per cent is determined, an error of not more than 0.5% is permitted. It shall be calculated on the basis of the total cargo tank capacity including the expansion trunk.
- (3) The level gauge shall allow readings from the control position of the shut-off devices of the particular cargo tank.
- (4) The level alarm device shall give a visual and audible warning on board when actuated. The level alarm device shall be independent of the level gauge.
- (5) (a) The high level sensor referred to in paragraph (1) (d) above shall give a visual and audible alarm on board and at the same time actuate an electrical contact which in the form of a binary signal interrupts the electric current loop provided and fed by the shore facility, thus initiating measures at the shore facility against overflowing during loading operations. The signal shall be transmitted to the shore facility via a watertight two-pin plug of a connector device in accordance with IEC Publication No. 309 for direct current of 40 to 50 volts, identification colour white, position of the nose 10 h.

The plug shall be permanently fitted to the vessel close to the shore connections of the loading and unloading pipes.

The high level sensor shall also be capable of switching off the vessel's own discharging pump.

The high level sensor shall be independent of the level alarm device, but it may be connected to the level gauge.

- (b) On board oil separator vessels the sensor referred to in paragraph (1) (d) shall activate a visual and audible alarm and switch off the pump used to evacuate bilge water.
- (6) The visual and audible signals given by the level alarm device shall be clearly distinguishable from those of the high level sensor.

The visual alarm shall be visible at each control position on deck of the cargo tank stop valves. It shall be possible to easily check the functioning of the sensors and electric circuits or these shall be of the "failsafe" design.

- (7) When the pressure or temperature exceeds a set value, instruments for measuring the vacuum or overpressure of the gaseous phase in the cargo tank or the temperature of the cargo, shall activate a visual and audible alarm in the wheelhouse and in the accommodation. When the pressure exceeds the set value during loading, the instrument for measuring the pressure shall, by means of the plug referred to in paragraph (5) above, initiate simultaneously an electrical contact which shall put in to effect measures to interrupt the loading operation. If the vessel's own discharge pump is used, it shall be switched off automatically.

Annex B.2 - Part III - Chapter 3

The instrument for measuring the overpressure or vacuum shall activate the alarm when an overpressure equal to 1.15 times the opening pressure of the pressure valve, or a vacuum pressure of 1.1 times the opening pressure of the vacuum pressure valve is reached. The maximum allowable temperature is indicated in the list of substances in Appendix 4. The sensors for the alarms mentioned in this paragraph may be connected to the alarm device of the sensor.

When a manometer is used to measure the overpressure or the vacuum pressure, its indicator scale shall not be less than 0.14 m in diameter. The maximum permissible overpressure or vacuum values shall be indicated by a red mark. The manometers shall be capable of being read at all times from the location where it is possible to interrupt loading or unloading.

(8) Where the control elements of the shut-off devices of the cargo tanks are located in a control room, reading of the level gauges shall be possible in the control room and the visual and audible warning given by the level alarm device, the high level sensor referred to in (1) (d) and the instruments for measuring the pressure of the vapour phase and temperature of the cargo shall be noticeable in the control room and on deck.

Satisfactory monitoring of the cargo area shall be ensured from the control room.

(9) The closed-type sampling device penetrating through the boundary of the cargo tank but constituting a part of a closed system shall be designed so that during sampling no gas or liquid may escape from the cargo tank. The device shall be of a type approved by the competent authority for this purpose.

(10) The partly closed sampling device penetrating through the boundary of the cargo tank shall be such that during sampling only a small quantity of gaseous or liquid cargo can escape into open air. As long as the device is not used it shall be closed completely. The device shall be of a type approved by the competent authority for this purpose.

(11) The sampling openings shall have a diameter of not more than 0.30 m. They shall be fitted with a flame-arrester and so designed that the period during which they remain open is as short as possible and the drip pan of the flame-arrester does not remain open without external intervention.

Flame-arresters are not required on board open type N tank vessels.

(12) The ullage openings shall be such that the filling level may be measured by means of a gauging rod. The ullage openings shall be fitted with a self-closing lid.

(13) Paragraph (1) (h) does not apply to closed type N.

Paragraphs (1) (e), (7) as regards measuring the pressure, (9) and (10) do not apply to open type N with flame-arrester and to open type N.

Paragraphs (1) (h) and (12) do not apply to open type N.

Paragraphs (1) (b), (c) and (g), (3), (4) and (11) do not apply to oil separator or supply vessels.

Paragraphs (1) (f) and (7) do not apply to supply vessels.

Paragraph (5) (a) does not apply to oil separator vessels.

331 222 Cargo tank openings

(1) (a) Cargo tank openings shall be located on deck in the cargo area.

Annex B.2 - Part III - Chapter 3

(b) Cargo tank openings with a cross-section of more than 0.10 m² and openings of safety devices for preventing overpressures shall be located not less than 0.50 m above deck.

(2) Cargo tank openings shall be fitted with gastight closures capable of withstanding the test pressure in accordance with marginal 331 223 (2).

(3) Closures which are normally used during loading or unloading operations shall not cause sparking when operated.

(4) (a) Each cargo tank or group of cargo tanks connected to a common vapour pipe shall be fitted with safety devices for preventing unacceptable overpressures or vacuums.

These safety devices shall be as follows:

for the open N type:

- safety devices designed to prevent any accumulation of water and its penetration into the cargo tanks;

for the open N type with flame—arresters:

- safety devices fitted with flame—arresters and designed to prevent any accumulation of water and its penetration into the cargo tank;

for the closed N type:

- safety devices for preventing unacceptable overpressure or vacuum, where the vacuum valve is fitted with a flame—arrester and the pressure relief valve is designed as a high-velocity vent valve with a flame—arresting effect. The gases shall be discharged upwards. The opening pressure of the high—velocity vent valve and the opening pressure of the vacuum valve shall be indelibly indicated on the valve;
- a connection for the safe return ashore of gases expelled during loading;
- a device for the safe depressurization of the cargo tanks consisting of at least flame—arresters and a stop valve the position of which shall clearly indicate whether it is open or shut.

(b) The outlets of high—velocity vent valves shall be located not less than 2.00 m above the deck and at a distance of not less than 6.00 m from the accommodation and service spaces outside the cargo area. This height may be reduced when within a radius of 1.00 m round the outlet of the high—velocity vent valve, there is no equipment, no work is being carried out and signs indicate the area. The setting of the high—velocity vent valves shall be such that during the transport operation they do not blow off until the maximum permissible working pressure of the cargo tanks is reached.

**331 222
(cont'd)**

(5) (a) When a vapour pipe connects two or more cargo tanks, a flame-arrestor capable of withstanding an explosion or detonation inside the pipe shall be fitted at the connection to each cargo tank. Only substances which do not mix and which do not react dangerously with each other may be carried simultaneously in cargo tanks connected to a common vapour pipe;

Annex B.2 - Part III - Chapter 3

or:

- (b) When a vapour pipe connects two or more cargo tanks, a pressure/vacuum relief device provided with a flame-arrester shall be fitted at the connection to each cargo tank; the gas expelled shall be discharged into the vapour pipe. Several different substances may be carried simultaneously in a vessel if they do not react dangerously with each other in the gaseous phase;

or:

- (c) Each tank has its own vapour pipe fitted with a vacuum relief valve incorporating a flame-arrester and a high-velocity vent valve with a flame-arresting effect. Several different substances may be carried simultaneously on board.

(6) Paragraphs (2), (4) (b) and (5) do not apply to open type N with flame-arrester and to open type N.

Paragraph (3) does not apply to open type N.

331 223 Pressure tests

(1) The cargo tanks, residual cargo tanks, cofferdams, pipes for loading and unloading, with the exception of discharge hoses shall be subjected to initial tests before being put into service and thereafter at prescribed intervals.

Where a heating system is provided inside the cargo tanks, the heating coils shall be subjected to initial tests before being put into service and thereafter at prescribed intervals.

(2) The test pressure for the cargo tanks and residual cargo tanks shall be not less than 1.3 times the construction pressure. The test pressure for the cofferdams and open cargo tanks shall be not less than 10 kPa (0.10 bar) gauge pressure.

(3) The test pressure for pipes for loading and unloading shall be not less than 1000 kPa (10 bar) gauge pressure.

(4) The maximum intervals for the periodic tests shall be 11 years.

(5) The procedure for pressure tests shall comply with the provisions established by the competent authority or a recognized classification society.

331 224

331 225 Pumps and piping

(1) (a) Pumps and accessory loading and unloading piping shall be located in the cargo area.

(b) Cargo pumps shall be capable of being shut down from the cargo area and from a position outside the cargo area.

331 225 (cont'd)

(c) Cargo pumps situated on deck shall be located not less than 6.00 m from entrances to, or openings of, the accommodation and service spaces outside the cargo area.

(2) (a) Pipes for loading and unloading shall be independent of any other piping of the vessel. No cargo piping shall be located below deck, except those inside the cargo tanks and inside the cargo pump-room.

Annex B.2 - Part III - Chapter 3

- (b) The pipes for loading and unloading shall be arranged so that, after loading or unloading operations, the liquid remaining in these pipes may be safely removed and may flow either into the vessel's tanks or the tanks ashore.
- (c) Pipes for loading and unloading shall be clearly distinguishable from other piping, e.g. by means of colour marking.
- (d) (reserved)
- (e) The shore connections shall be located not less than 6.00 m from the entrances to, or openings of, the accommodation and service spaces outside the cargo area.
- (f) Each shore connection of the vapour pipe and shore connections of the pipes for loading and unloading, through which the loading or unloading operation is carried out, shall be fitted with a shut-off device. However, each shore connection shall be fitted with a blind flange when it is not in operation.

Each shore connection of the pipes for loading and unloading through which the loading or unloading operation is carried out shall be fitted with the device intended for the discharge of residual cargo described in Model No.1 of Appendix 3.

- (g) The vessel shall be equipped with a permanently installed stripping system.
 - (h) The flanges and stuffing boxes shall be provided with a spray protection device. This device is required only for the carriage of corrosive substances (hazard or subsidiary risk of Class 8).
- (3) The distance referred to in (1) (a) and (c) and (2) (e) may be reduced to 3.00 m if a transverse bulkhead complying with 331 210 (2) is situated at the end of the cargo area. The openings shall be provided with doors.

The following notice shall be displayed on the doors:

**DO NOT OPEN DURING LOADING AND UNLOADING WITHOUT
THE PERMISSION OF THE STEERSMAN.
CLOSE IMMEDIATELY.**

- (4) (a) Every component of the pipes for loading and unloading shall be electrically connected to the hull.
 - (b) The pipes for loading shall extend down to the bottom of the cargo tanks.
- (5) The stop valves or other shut-off devices of the pipes for loading and unloading shall indicate whether they are open or shut.

**331 225
(cont'd)**

- (6) The pipes for loading and unloading shall have, at the test pressure, the required elasticity, leakproofness and resistance to pressure.
- (7) The pipes for loading and unloading shall be fitted with pressure gauges at the pump outlet.

Where these pressure gauges are manometers, the indicator scale shall have a diameter of not less than 0.14 m.

Annex B.2 - Part III - Chapter 3

Reading of the pressure gauges shall be possible from the control position of the loading pump at any time. The maximum permissible overpressure or vacuum shall be indicated by a red mark.

- (8) (a) When pipes for loading and unloading are used for supplying the cargo tanks with washing or ballast water, the suctions of these pipes shall be located within the cargo area but outside the cargo tanks.

Pumps for tank washing systems with associated connections may be located outside the cargo area, provided the discharge side of the system is arranged in such a way that suction is not possible through that part.

A spring-loaded non-return valve shall be provided to prevent any gases from being expelled from the cargo area through the tank washing system.

- (b) A non-return valve shall be fitted at the junction between the water suction pipe and the cargo loading pipe.

- (9) The maximum permissible loading rate for each cargo tank and for the vessel determined in relation to the design of the cargo tanks, the pipes for loading and unloading, the vapour pipe and safety devices shall be indicated in the certificate of approval.

- (10) The stripping system shall be subjected to initial tests before being put into service or thereafter if any alteration has been made to it, using water as test medium. The test and the determination of the residual quantities shall be carried out in accordance with the requirements of Model No. 2 of Appendix 3.

In this test, the following residual quantities shall not be exceeded:

- (a) 5 l for each cargo tank;
(b) 15 l for each pipe system.

The residual quantities obtained in the test shall be entered in the certificate for the test of the stripping system referred to in marginal 210 381 (3) (c).

- (11) Paragraphs (1) (a) and (c), (2) (e), (3) and (4) (b), do not apply to open type N.

Paragraphs (2) (f), last sentence, (2) (g), (8) (a), last sentence and (10) do not apply to oil separator and supply vessels.

Paragraph (9) does not apply to oil separator vessels.

Paragraph (2) (h) does not apply to supply vessels.

331 226 Residual cargo tanks and slop tanks

- (1) The vessel shall be provided with at least one residual cargo tank and with slop tanks for slops which are not suitable for pumping. These tanks shall be located only in the cargo area. Intermediate bulk containers or tank-containers in accordance with marginal 210 401 may be used instead of a fixed residual cargo tank. During filling of intermediate bulk containers or tank-containers, means for collecting any leakage shall be placed under the filling connections.

- (2) Slop tanks shall be fire resistant and shall be capable of being closed with lids

Annex B.2 - Part III - Chapter 3

(e.g. drums with lever closing ring lids). The tanks shall be marked and easy to handle.

(3) The maximum permissible capacity of a residual cargo tank is 30 m³.

The residual cargo tanks shall be equipped with:

in the case of an open system:

- a device for ensuring pressure equilibrium;
- an ullage opening;
- connections, with stop valves, for pipes and hoses;

in the case of a protected system:

- a device for ensuring pressure equilibrium, fitted with a flame-arrester. The pressure valve shall be fitted with a device with a flame-arrester, designed for the high velocity ejection of gases. The eductor shall be so regulated that it does not open during the transport operation. This condition is complied with when the opening pressure of the valve meets the conditions required in the list of substances for the substance to be carried;
- an ullage opening;
- connections, with stop valves, for pipes and hoses;

in the case of a closed system:

- pressure/vacuum valves fitted with a flame-arrester;
- a device for measuring the degree of filling;
- connections, with stop valves, for pipes and hoses.

No connection between the residual cargo tanks and the vapour pipe of the cargo tanks shall be permitted.

(4) Paragraphs (1) and (3) above do not apply to oil separator vessels.

331 227

331 228 Water-spray system

When water-spraying is required in the list of substances of Appendix 4, a water-spray system shall be installed in the cargo area on deck for the purpose of reducing vapours given off by the cargo, and of cooling the tops of cargo tanks.

The system shall be fitted with a connection device for supply from the shore. The system shall be capable of being put into operation from the wheelhouse and from the deck. The capacity of the water-spray system shall be such that when all the spray nozzles are in operation, the outflow is of 50 litres per square metre of cargo deck area and per hour.

**331 229-
331 230**

331 231 Engines

(1) Only internal combustion engines running on fuel with a flashpoint of more than 55 °C are allowed.

(2) Ventilation inlets of the engine room and, when the engines do not take in air directly from the engine room, air intakes of the engines shall be located not less than 2.00 m from the cargo area.

Annex B.2 - Part III - Chapter 3

(3) Sparking shall not be possible within the cargo area.

(4) The surface temperature of the outer parts of engines used during loading or unloading operations, as well as that of their air inlets and exhaust ducts shall not exceed the allowable temperature according to the temperature class. This provision does not apply to engines installed in service spaces provided the provisions of marginal 331 252 (3) (b) are fully complied with.

(5) The ventilation in the closed engine room shall be designed so that, at an ambient temperature of 20 °C, the average temperature in the engine room does not exceed 40 °C.

(6) Paragraph (2) above does not apply to oil separator or supply vessels.

331 232 Oil fuel tanks

(1) Where the vessel is provided with hold spaces, the double bottoms within these spaces may be arranged as oil fuel tanks, provided their depth is not less than 0.60 m.

Oil fuel pipes and openings of such tanks are not permitted in the hold space.

(2) The air pipes of all oil fuel tanks shall extend to 0.5 m above the open deck. Their open ends and the open ends of overflow pipes leading to the deck shall be provided with a protective device consisting of a gauze diaphragm or a perforated plate.

331 233

331 234 Exhaust pipes

(1) Exhaust shall be evacuated from the vessel into the open air either upwards through an exhaust pipe or through the shell plating. The exhaust outlet shall be located not less than 2.00 m from the cargo area. The exhaust pipes of engines shall be arranged so that the exhausts are led away from the vessel. The exhaust pipes shall not be located within the cargo area.

(2) Exhaust pipes shall be provided with a device preventing the escape of sparks, e.g. spark arresters.

(3) The distance described in paragraph (1) above does not apply to oil separator or supply vessels.

331 235 Bilge pumping and ballasting arrangements

(1) Bilge and ballast pumps for spaces within the cargo area shall be installed within such area.

331 235 (cont'd) This provision does not apply to:

- double-hull spaces and double bottoms which do not have a common boundary wall with the cargo tanks;
- cofferdams and hold spaces where ballasting is carried out using the piping of the fire-fighting system in the cargo area and bilge-pumping is performed using eductors.

(2) Where the double bottom is used as an oil fuel tank, it shall not be connected to the bilge piping system.

(3) Where the ballast pump is installed in the cargo area, the standpipe and its outboard

Annex B.2 - Part III - Chapter 3

connection for suction of ballast water shall be located within the cargo area but outside the cargo tanks.

(4) A cargo pump-room below deck shall be capable of being drained in an emergency by an installation located in the cargo area and independent from any other installation. The installation shall be provided outside the cargo pump-room.

**331 236-
331 239**

331 240 Fire-extinguishing arrangements

(1) A fire-extinguishing system shall be installed on the vessel. This system shall comply with the following requirements:

- It shall be supplied by two independent fire or ballast pumps, one of which shall be ready for use at any time. These pumps shall not be installed in the same space;
- It shall be provided with a water main fitted with at least three hydrants in the cargo area above deck. Three suitable and sufficiently long hoses with spray nozzles having a diameter of not less than 12 mm shall be provided. It shall be possible to reach any point of the deck in the cargo area simultaneously with at least two jets of water which do not emanate from the same hydrant;

A spring-loaded non-return valve shall be fitted to ensure that no gases can escape through the fire-extinguishing system into the accommodation or service spaces outside the cargo area;

- The capacity of the system shall be at least sufficient for a jet of water to have a minimum reach of not less than the vessel's breadth from any location on board with two spray nozzles being used at the same time.

(2) In addition the engine rooms, the cargo pump-rooms and all spaces containing essential equipment under deck (diesel generators, switchboards, compressors, etc.) for the refrigeration equipment, if any, shall be provided with a fixed fire-extinguishing system which can be operated from the deck.

(3) The two hand fire-extinguishers referred to in marginal 210 240 shall be located in the cargo area.

**331 240
(cont'd)**

(4) Paragraphs (1) and (2) above do not apply to oil separator or supply vessels.

331 241 Fire and naked light

(1) The outlets of funnels shall be located not less than 2.00 m from the cargo area. Arrangements shall be provided to prevent the escape of sparks and the entry of water.

(2) Heating, cooking and refrigerating appliances shall not be fuelled with liquid fuels, liquid gas or solid fuels.

The installation in the engine room or in another separate space of heating appliances fuelled with liquid fuel having a flash-point above 55 °C is, however, permitted.

Annex B.2 - Part III - Chapter 3

Cooking and refrigerating appliances are permitted only in the accommodation.

(3) Only electrical lighting appliances are permitted.

331 242 Cargo heating system

(1) Boilers which are used for heating the cargo shall be fuelled with a liquid fuel having a flashpoint of more than 55 °C. They shall be placed either in the engine room or in another separate space below deck and outside the cargo area, which is accessible from the deck or from the engine room.

(2) The cargo heating system shall be designed so that the cargo cannot penetrate into the boiler in the case of a leak in the heating coils. A cargo heating system with artificial draught shall be ignited electrically.

(3) The ventilation system of the engine room shall be designed taking into account the air required for the boiler.

(4) Where the cargo heating system is used during loading, unloading or gas-freeing, the service space which contains this system shall fully comply with the requirements of marginal 331 252 (3) (b). This requirement does not apply to the inlets of the ventilation system. These inlets shall be located at a minimum distance of 2.00 m from the cargo area and 6.00 m from the openings of cargo tanks or residual cargo tanks, loading pumps situated on deck, openings of high velocity vent valves, pressure valves and shore connections of loading and unloading pipes and must be located not less than 2.00 m above the deck.

**331 243-
331 249**

331 250 Documents concerning electrical installations

(1) In addition to the documents required by the "Recommendations on Technical Requirements for Inland Navigation Vessels", the following documents shall be on board:

- (a) a drawing indicating the boundaries of the cargo area and the location of the electrical equipment installed in this area;
- (b) a list of the electrical equipment referred to in (a) above including the following particulars:

machine or appliance, location, type of protection, type of protection against explosion, testing body and approval number;

**331 250
(cont'd)**

- (c) a list of or general plan indicating the electrical equipment outside the cargo area which may be operated during loading, unloading or gas-freeing. All other electrical equipment shall be marked in red. See marginal 331 252 (3) and (4).

(2) The documents listed above shall bear the stamp of the competent authority issuing the certificate of approval.

331 251 Electrical installations

(1) Only distribution systems without return connection to the hull are permitted:

This provision does not apply to:

Annex B.2 - Part III - Chapter 3

- local installations outside the cargo area (e.g. connections of starters of diesel engines);
- the device for checking the insulation level referred to in (2) below.

(2) Every insulated distribution network shall be fitted with an automatic device with a visual and audible alarm for checking the insulation level.

(3) For the selection of electrical equipment to be used in zones presenting an explosion risk, the explosion groups and temperature classes assigned to the substances carried in the list of substances of Appendix 4 shall be taken in to consideration.

331 252 Type and location of electrical equipment

- (1) (a) Only the following equipment may be installed in cargo tanks, residual cargo tanks, and pipes for loading and unloading (comparable to zone 0):
- measuring, regulation and alarm devices of the EEx (ia) type of protection;
- (b) Only the following equipment may be installed in the cofferdams, double-hull spaces, double bottoms and hold spaces (comparable to zone 1):
- measuring, regulation and alarm devices of the "certified safe" type;
 - lighting appliances of the "flame-proof enclosure" or "pressurized apparatus" type of protection;
 - hermetically sealed echo sounding devices the cables of which are led through thick-walled steel tubes with gastight connections up to the main deck;
 - cables for the active cathodic protection of the shell plating in protective steel tubes such as those provided for echo sounding devices;
- (c) Only the following equipment may be installed in the service spaces in the cargo area below deck (comparable to zone 1):
- measuring, regulation and alarm devices of the "certified safe" type;
 - lighting appliances of the "flame-proof enclosure" or "pressurized apparatus" type of protection;

331 252 (cont'd)

- motors driving essential equipment such as ballast pumps; they shall be of the "certified safe" type;
- (d) The control and protective equipment of the electrical equipment referred to in paragraphs (a), (b) and (c) above shall be located outside the cargo area if they are not intrinsically safe;
- (e) The electrical equipment in the cargo area on deck (comparable to zone 1) shall be of the "certified safe" type.

(2) Accumulators shall be located outside the cargo area.

(3) (a) Electrical equipment used during loading, unloading and gas-freeing during berthing and which are located outside the cargo area shall (comparable to zone

Annex B.2 - Part III - Chapter 3

2) be at least of the "limited explosion risk" type;

(b) This provision does not apply to:

(i) lighting installations in the accommodation, except for switches near entrances to accommodation;

(ii) radiotelephone installations in the accommodation or the wheelhouse;

(iii) electrical installations in the accommodation, the wheelhouse or the service spaces outside the cargo areas if:

1. These spaces are fitted with a ventilation system ensuring an overpressure of 0.1 kPa (0.001 bar) and none of the windows is capable of being opened; the air intakes of the ventilation system shall be located as far away as possible, however, not less than 6.00 m from the cargo area and not less than 2.00 m above the deck;
2. The spaces are fitted with a gas detection system with sensors:
 - at the suction inlets of the ventilation system;
 - directly at the top edge of the sill of the entrance doors of the accommodation and service spaces;
3. The gas concentration measurement is continuous;
4. When the gas concentration reaches 20% of the lower explosive limit, the ventilators are switched off. In such a case and when the overpressure is not maintained or in the event of failure of the gas detection system, the electrical installations which do not comply with (a) above, shall be switched off. These operations shall be performed immediately and automatically and activate the emergency lighting in the accommodation, the wheelhouse and the service spaces, which shall comply at least with the "limited explosion risk" type. The switching-off shall be indicated in the accommodation and wheelhouse by visual and audible signals;
5. The ventilation system, the gas detection system and the alarm of the switch-off device fully comply with the requirements of (a) above;
6. The automatic switch off device is set so that no automatic switching-off may occur while the vessel is under way.

**331 252
(cont'd)**

(4) The electrical equipment which do not meet the requirements set out in (3) above together with their switches shall be marked in red. The disconnection of such equipment shall be operated from a centralized location on board.

(5) An electric generator which is permanently driven by an engine and which does not meet the requirements of paragraph (3) above, shall be fitted with a switch capable of shutting down the excitation of the generator. A notice board with the operating instructions shall be displayed near the switch.

(6) Sockets for the connection of signal lights and gangway lighting shall be permanently fitted to the vessel close to the signal mast or the gangway. Connecting and disconnecting shall not be possible except when the sockets are not live.

Annex B.2 - Part III - Chapter 3

(7) The failure of the power supply for the safety and control equipment shall be immediately indicated by visual and audible signals at the locations where the alarms are usually actuated.

331 253 Earthing

(1) The metal parts of electrical appliances in the cargo area which are not live as well as protective metal tubes or metal sheaths of cables in normal service shall be earthed, unless they are so arranged that they are automatically earthed by bonding to the metal structure of the vessel.

(2) The provisions of paragraph (1) above apply also to equipment having service voltages of less than 50 V.

(3) Independent cargo tanks, metal intermediate bulk containers and tank-containers shall be earthed.

**331 254-
331 255**

331 256 Electrical cables

(1) All cables in the cargo area shall have a metallic sheath.

(2) Cables and sockets in the cargo area shall be protected against mechanical damage.

(3) Movable cables are prohibited in the cargo area, except for intrinsically safe electric circuits or for the supply of signal lights, gangway lighting and submerged pumps on board oil separator vessels.

(4) Cables of intrinsically safe circuits shall only be used for such circuits and shall be separated from other cables not intended for being used in such circuits (e.g. they shall not be installed together in the same string of cables and they shall not be fixed by the same cable clamps).

(5) For movable cables intended for signal lights, gangway lighting, and submerged pumps on board oil separator vessels, only sheathed cables of type H 07 RN-F in accordance with IEC 66 or cables of at least equivalent design having conductors with a cross-section of not less than 1.5 mm² shall be used.

These cables shall be as short as possible and installed so that damage is not likely to occur.

**331 257-
331 259**

331 260 Special equipment

A shower and an eye and face bath shall be provided on the vessel at a location which is directly accessible from the cargo area.

This requirement does not apply to oil separator and supply vessels.

**331 261-
331 270**

331 271 Admittance on board

The notice boards displaying the prohibition of admittance in accordance with

Annex B.2 - Part III - Chapter 3

marginal 210 371 shall be clearly legible from either side of the vessel.

331 272-
331 273

331 274 Prohibition of smoking, fire or naked light

(1) The notice boards displaying the prohibition of smoking in accordance with marginal 210 374 shall be clearly legible from either side of the vessel.

(2) Notice boards indicating the circumstances under which the prohibition is applicable shall be fitted near the entrances to the spaces where smoking or the use of fire or naked light is not always prohibited.

(3) Ashtrays shall be provided close to each exit in the accommodation and the wheelhouse.

331 275
331 999

ANNEX B.2

APPENDICES

(RESERVED)

Annex B.2 - Appendix 1

2

13. The validity of this certificate of approval expires on (date)
14. The previous certificate of approval No was issued on
by (competent authority)
15. The vessel is approved for the carriage of dangerous goods listed in the attestation attached to this certificate following:
- inspection on 1/ (date)
 - certification by a recognized classification society 1/
 - Name of the classification society 1/ (date)
16. Subject to permitted equivalences: 1/
.....
.....
17. Subject to special authorizations: 1/
.....
.....
18. Issued at: on
(place) (date)
19. (Stamp)
..... (competent authority)
.....
..... (signature)

1/ Delete as appropriate.

Extension of the validity of the certificate of approval

20. The validity of this certificate is extended under marginal 210 282 (4) of Annex B.2 of ADN
- Until
(date)
21. on
(place) (date)
22. (Stamp)
..... (competent authority)
.....
..... (signature)

Annex B.2 - Appendix 1

If the cargo tanks of the vessel are not all of the same type or the equipment is not the same, their type and their equipment should be indicated below.

Cargo tank number	1	2	3	4	5	6	7	8	9	10	11	12
independent cargo tank												
integral cargo tank												
cargo tank wall distinct from the hull												
pressure cargo tank												
closed cargo tank												
open cargo tank with flame-arrester												
open cargo tank												
opening pressure of the high-velocity vent valve												
closed sampling device												
partly closed sampling device												
sampling opening												
water-spray system												
possibility of cargo heating from shore												
cargo heating installation												
cargo refrigeration installation												

(RESERVED)

Annex B.2 - Appendix 1

**APPENDIX 1
Model 2**

Model for a provisional certificate of approval

1

Competent authority :
Space reserved for the emblem and name of the State

Provisional certificate of approval No:
according to Annex B.2, marginal 210 283, ADN

1. Name of vessel

2. Official number

3. Type of vessel

4. Type of tank vessel

5. Types of cargo tanks

1.	Independent cargo tanks	<u>1/</u> <u>2/</u>
2.	Integral cargo tanks	<u>1/</u> <u>2/</u>
3.	Cargo tank wall distinct from the hull	<u>1/</u> <u>2/</u>

6. Types of cargo tanks

1.	Pressure cargo tanks	<u>1/</u> <u>2/</u>
2.	Closed cargo tanks	<u>1/</u> <u>2/</u>
3.	Open cargo tanks with flame-arresters	<u>1/</u> <u>2/</u>
4.	Open cargo tanks	<u>1/</u> <u>2/</u>

7. Opening pressure of high-velocity vent valves/safety valves kPa 1/ 2/

8. Additional equipment:

- Sampling device

closed	yes/no <u>1/</u> <u>2/</u>
partly closed	yes/no <u>1/</u> <u>2/</u>
sampling opening	yes/no <u>1/</u> <u>2/</u>
- Water-spray system yes/no 1/ 2/
- Cargo heating system:

possibility of cargo heating from shore	yes/no <u>1/</u> <u>2/</u>
cargo heating installation on board	yes/no <u>1/</u> <u>2/</u>
- Cargo refrigeration system yes/no 1/ 2/
- Cargo pump-room below deck yes/no 1/ 2/

9. Electrical equipment:

- Temperature class:
- Explosion group:

10. Loading rate: m³/h

11. Permitted relative density:

12. Permitted derogations :

1/ Delete as appropriate.

2/ If the tanks are not all of the same type, see page 3.

Annex B.2 - Appendix 1

13. The provisional certificate of approval is valid <u> </u> /	
13.1	until
13.2	for a single journey from to
14. Issued at: (place)	on (date)
15. (Stamp) (competent authority)
 (signature)
<hr/>	
<u> </u> / Delete as appropriate.	

NOTE : This model provisional certificate of approval may be replaced by a single certificate model combining a provisional certificate of inspection and the provisional certificate of approval, provided that this single certificate model contains the same particulars as the model below and is approved by the competent authorities.

Annex B.2 - Appendix 1

If the cargo tanks of the vessel are not all of the same type or the equipment is not the same, their type and their equipment should be indicated below.

Cargo tank number	1	2	3	4	5	6	7	8	9	10	11	12
independent cargo tank												
integral cargo tank												
cargo tank wall distinct from the hull												
pressure cargo tank												
closed cargo tank												
open cargo tank with flame-arrester												
open cargo tank												
opening pressure of the high-velocity vent valve												
closed sampling device												
partly closed sampling device												
sampling opening												
water-spray system												
possibility of cargo heating from shore												
cargo heating installation												
cargo refrigeration installation												

(RESERVED)

Annex B.2 - Appendix 1

**APPENDIX 1
Model 3**

**Certificate of special knowledge of ADN according to
marginals 10 315, 210 315, 210 317 or 210 318**

(Format: A6, Colour: orange)

Annex B.2 - Appendix 1

(Space reserved for the emblem of State, competent authority)

ADN certificate
of special knowledge of ADN

No of certificate:

Name:

First name(s):

Born on:

Nationality:

Signature of holder:

The holder of this certificate has special knowledge of ADN.

The certificate is valid for special knowledge of ADN according to marginals 10 315/210 315, 210 317, 210 318^{*}/

until:

if it has not been extended during the period of validity following participation in a refresher or advanced training course

Issued by:

Date:

(Stamp)

Signature:

*) Delete as appropriate.

(Recto)

(Verso)

Annex B.2 - Appendix 2

APPENDIX 2

1

**Checklist ADN
(Marginal 210 410)**

Concerning the observance of safety provisions and the implementation of the necessary measures for loading/unloading.

- Particulars of vessel

..... No
 (name of vessel) (official number)

 (vessel type)

- Particulars of loading or unloading operations

.....
 (shore loading or unloading installation) (place)

 (date) (time)

- Particulars of the cargo

Quantity m ³	Name of product	Identification number	Class/item number
.....
.....
.....

- Particulars of last cargo */

Name of product	Identification number	Class/item number
.....
.....
.....

*/ To be filled in only if vessel is to be loaded.

Annex B.2 - Appendix 2

2

Loading rate (not to be filled in if vessel is to be loaded with gas)

Name of substance	Cargo tank number	agreed rate of loading/unloading					
		start		half way		end	
		rate m ³ /h	quantity m ³	rate m ³ /h	quantity m ³	rate m ³ /h	quantity m ³
.....
.....
.....

Will the cargo piping be drained after loading or unloading by stripping or by blowing residual quantities to the shore installation to the vessel */?

by blowing */
by stripping */

If drained by blowing, how ?

.....
(e.g. air, inert gas, sleeve)

..... kPa
(permissible maximum pressure in the cargo tank)

Questions to the steersman and the person in charge at the loading/unloading place

Loading/unloading may only be started after all questions on the checklist have been checked off by "X", i.e. answered with YES and the list has been signed by both persons.

Non applicable questions have to be deleted.

If not all questions can be answered with YES, loading/unloading is only allowed with consent of the competent authorities.

*/ Delete as appropriate.

Annex B.2 - Appendix 2

	vessel	3 loading/ unloading place
1. Is the vessel permitted to carry this cargo?	O */	O */
2. Did the steersman receive the instructions in writing referred to in marginal 210 385 from the consignor ?	O */	O */
3. Is the vessel well moored in view of local circumstances ?	O	-
4. Have suitable means been provided at the fore and at the aft of the vessel, for boarding or leaving, including in cases of emergency ?	O	O
5. Are the escape routes and the loading/unloading place adequately lighted ?	O	O
6. Vessel/shore connection		
6.1 Are the cargo hoses between vessel and shore in satisfactory condition ?	-	O
Are these hoses correctly connected?	O	O
6.2 Are all the connecting flanges fitted with suitable gaskets ?	-	O
6.3 Are all the connecting bolts fitted and tightened ?	O	O
6.4 Are the shoreside loading arms free to move in all directions and do the hoses have enough room for easy movement ?	-	O
7. Are all flanges of the connections of the pipes for loading and unloading and of the vapour pipe not in use, correctly blanked off ?	O	O
8. Are suitable means of collecting leakages placed under the pipe connections which are in use ?	O	O
9. Are the movable connecting pieces between the ballast and bilge piping on the one hand and the pipes for loading and unloading on the other hand disconnected ?	O	-
10. Is continuous and suitable supervision of loading/ unloading ensured for the whole period of the operation ?	O	O
11. Is communication between vessel and shore ensured ?	O	O
12.1 For the loading of the vessel, is the vapour pipe, where required, or if it exists, connected with the shore gas return line ?	O	O
12.2 Is it ensured that the shore installation is such that the pressure at the connecting point cannot exceed the opening pressure of the high-velocity vent valves ?	-	O */
13. Is it known what actions are to be taken in the event of an "Emergency-stop" and an "Alarm" ?	O	O

*/ To be filled in only if vessel is to be loaded.

Annex B.2 - Appendix 2

	vessel	4 loading/ unloading place
14. Check on the most important operational requirements: - Are the required fire extinguishing systems and appliances operational ? - Have all valves and other closing devices been checked for correct open - or closed position ? - Has smoking been generally prohibited ? - Are the flame-operated heating, cooking and cooling appliances on board turned off ? - Are the liquefied gas installations shut off at the main check valve ? - Is the voltage cut off from the radar installations ? - Is all electrical equipment marked red switched off ? - Are all windows and doors closed ?	O O O O O O O O	O O O - - - - -
15.1 Has the starting working pressure of the vessel's cargo discharge pump been adjusted to the permissible working pressure of the shore installation?	O	-
15.2 Has the starting working pressure of the shore pump been adjusted to the permissible working pressure on board installation ?	-	O
16. Is the liquid level alarm-installation operational ?	O	-
17. Is the level control device activating the overflowing prevention system plugged-in, in working order and tested ?	O	O
18. To be filled in only in the case of loading or unloading of substances for the carriage of which a vessel of the closed-type or a vessel of the open type with flame-arrester is required. Are the cargo tank hatches and cargo tank inspection, gauging and sampling openings closed or protected by flame-arresters in good condition ?	O	-

Checked, filled in and signed for the vessel: name (in capital letters) (signature)	for the installation of loading and unloading name (in capital letters) (signature)
--	--

Annex B.2 - Appendix 2

Explanation

Question 3

"Well moored" means that the vessel is fastened to the pier or the cargo transfer station in such a way that, without intervention of a third person, movements of the vessel in any direction that could hamper the operation of the cargo transfer gear will be prevented. Established or predictable variations of the water-level at that location and special factors have to be taken into account.

Question 4

It must be possible to board or escape from the vessel at any time. If there is none or only one protected escape route available at the shoreside for a quick escape from the vessel in case of emergency, a suitable means of escape has to be provided on the vessel side (e.g. a lowered dinghy).

Question 6

A valid inspection certificate for the loading/unloading hoses must be available on board. The material of the hoses must be able to withstand the expected loads and be suitable for cargo transfer of the respective substances. The term cargo hoses includes hoses as well as the shoreside loading/discharging arms. The cargo transfer hoses between vessel and shore must be placed so that they cannot be damaged by variations of the water-level, passing vessels and/or loading/unloading operations. All flange connections are to be fitted with appropriate gaskets and sufficient bolt connections in order to exclude the possibility of leakage.

Question 10

Loading/unloading must be supervised on board and ashore so that dangers which may occur in the vicinity of cargo hoses can be recognized immediately.

Question 11

For a safe loading/unloading operation good communications between vessel and shore are required. For this purpose telephone and radio equipment may be used only if of an explosion protected type and located within reach of the supervisor.

Question 13

Before the start of the loading/unloading operation the representative of the shore installation and the master must agree on the applicable procedure. The specific properties of the substances to be loaded/unloaded have to be taken into account.

(RESERVED)

Annex B.2 - Appendix 3

**APPENDIX 3
Model 1**

Device for the discharge of residual quantities

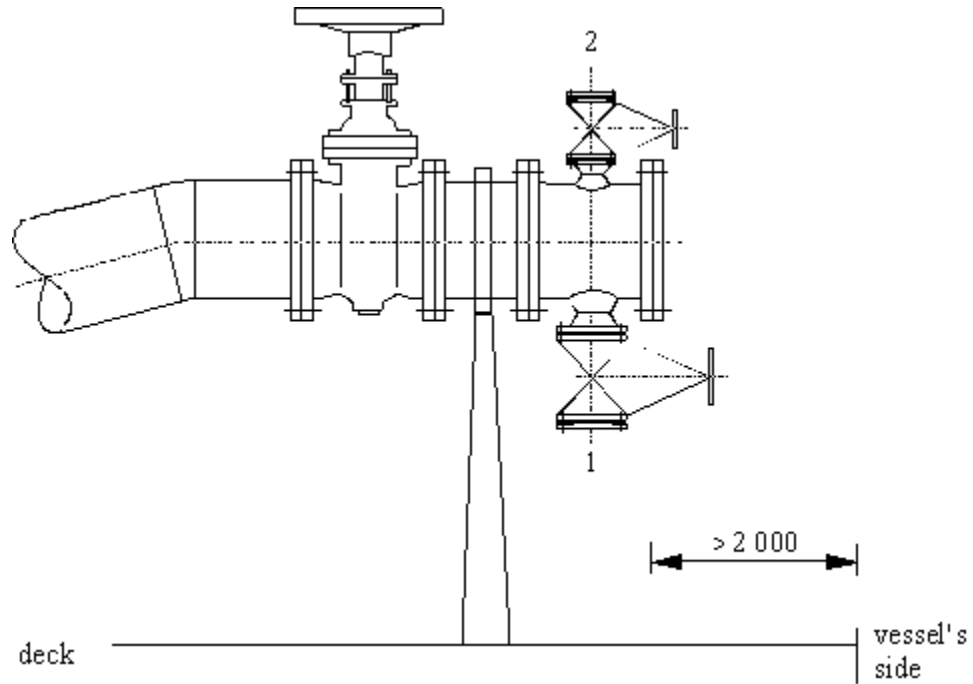

1. Connection for the discharge of residual quantities
Connection conforming to CEFIC
2. Connection of the shore installation intended for blowing residual quantities to the shore installation by means of a gas under pressure
Connection conforming to CEFIC

(RESERVED)

Annex B.2 - Appendix 3

**APPENDIX 3
Model 2**

Test of the stripping system

- (1) Before the start of the test, the cargo tanks and their piping shall be clean. The cargo tanks shall be safe for entry.
- (2) During the test, the trim and list of the vessel shall not exceed normal operating values.
- (3) During the test, a back pressure of not less than 300 kPa (3 bar) shall be maintained at the device for discharge of residual quantities fitted on the pipe for unloading.
- (4) The test shall comprise :
 - (a) The filling of the cargo tank with water until the suction intake inside the tank is submerged;
 - (b) The pumping out of the water and the emptying of the cargo tank and the corresponding piping by means of the tank's stripping system;
 - (c) The collection of the remaining water at the following points:
 - The cargo tank suction intake;
 - The bottom of the cargo tank where water has collected;
 - The lowest point drain of the cargo pump;
 - At all the lowest points of the piping associated with the cargo tank up to the device for the discharge of residual quantities.
- (5) The quantity of water collected as described in paragraph (4) (c) shall be measured precisely and noted in the test certificate.
- (6) The competent authority or the recognized classification society shall set out all the operations required for the test in the test certificate.

This certificate shall include at least the following data:

- trim of the vessel during the test;
- list of the vessel during the test;
- tank unloading order;
- back pressure at the device for the discharge of residual quantities;
- residual quantity per tank;
- residual quantity per piping system;
- duration of the stripping operation;
- cargo tank plan, duly completed.

(RESERVED)

Annex B.2 - Appendix 3

**APPENDIX 3
Model 3**

Certificate for the test of the stripping system

1. Name of vessel:

2. Official number:

3. Type of tank vessel:

4. Number of certificate of approval:

5. Date of test:

6. Place of test:

7. Number of cargo tanks:

8. The following residual quantities were measured during the test

Tank 1:	litres	Tank 2:	litres
Tank 3:	litres	Tank 4:	litres
Tank 5:	litres	Tank 6:	litres
Tank 7:	litres	Tank 8:	litres
Tank 9:	litres	Tank 10:	litres
Tank 11:	litres	Tank 12:	litres
Slop tank 1:	litres	Slop tank 2:	litres
Slop tank 3:	litres		
Piping system 1:	litres		
Piping system 2:	litres		

9. During the test, the back pressure at the device for the discharge of residual quantities was bar.

10. The tanks were discharged in the following order:

tank	tank	tank	tank	tank
tank	tank	tank	tank	tank

11. During the test, the trim of the vessel was
and the list of the vessel was

12. The total duration of the stripping operation was h.
.....
(date) (signature)

(RESERVED)

Annex B.2 - Appendix 4**APPENDIX 4****LIST OF SUBSTANCES**

The list is subdivided as follows:

Column	1	Identification number (UN No.)	
	2	Name of substance	
	3	Class, item number and letter	
	4	Hazards	
	5	Type of tank vessel: G, C or N	
	6	Cargo tank design	
		1	pressure cargo tank
		2	closed cargo tank
		3	open cargo tank with flame-arrester
		4	open cargo tank
	7	Cargo tank type	
		1	independent cargo tank
		2	integral cargo tank
		3	cargo tank with walls distinct from the outer hull
	8	Cargo tank equipment	
		1	cargo refrigeration system
		2	cargo heating system on board
		3	water-spray system
	9	Opening pressure of high-velocity vent valve in kPa	
	10	Maximum degree of filling (%)	
	11	Relative density at 20 °C	(data concerning the relative density are for information only)
	12	Type of sampling device	
		1	closed
		2	partly closed
		3	sampling outlet opening
	13	Cargo pump-room below deck permitted	
	14	Temperature class	
	15	Explosion group	

Annex B.2 - Appendix 4

- 16 Protection against explosions required
- 17 Flammable gas detector required
- 18 Toximeter required
- 19 Number of cones/blue lights
- 20 Additional requirements or remarks

- 1. Anhydrous ammonia is liable to cause stress crack corrosion in cargo tanks and cooling systems constructed of carbon-manganese steel or nickel steel.

In order to minimize the risk of stress crack corrosion the following measures shall be taken:

- (a) Where carbon-manganese steel is used, cargo tanks, pressure vessels of cargo refrigeration systems and cargo piping shall be constructed of fine-grained steel having a specified minimum yield stress of not more than 355 N/mm^2 . The actual yield stress shall not exceed 440 N/mm^2 . In addition, one of the following construction or operational measures shall be taken:
 - 1. Material with a low tensile strength ($R_{m} < 410 \text{ N/mm}^2$) shall be used; or
 - 2. Cargo tanks, etc., shall undergo a post-weld heat treatment for the purpose of stress relieving; or
 - 3. The transport temperature shall preferably be maintained close to the evaporation temperature of the cargo of $-33 \text{ }^\circ\text{C}$, but in no case above $-20 \text{ }^\circ\text{C}$; or
 - 4. Ammonia shall contain not less than 0.1 % water, by mass.
- (b) When carbon-manganese steel with yield stress values higher than those referred to in (a) above is used, the completed tanks, pipe sections, etc., shall undergo a post-weld heat treatment for the purpose of stress-relieving.
- (c) Pressure vessels of the cargo refrigeration systems and the piping systems of the condenser of the cargo refrigeration system constructed of carbon-manganese steel or nickel steel shall undergo a post-weld heat treatment for the purpose of stress relieving.
- (d) The yield stress and the tensile strength of welding consumables may exceed only by the smallest value possible the corresponding values of the tank and piping material.
- (e) Nickel steels containing more than 5 % nickel and carbon-manganese steel which are not in compliance with the requirements of (a) and (b) above may not be used for cargo tanks and piping systems intended for the transport of this substance.
- (f) Nickel steels containing not more than 5 % nickel may be used if the transport temperature is within the limits referred to in (a) above.
- 1. (g) The concentration of oxygen dissolved in the ammonia shall not exceed the

Annex B.2 - Appendix 4

(cont'd) values given in the table below:

t in °C	O ₂ in %, by volume
- 30 and below	0.90
- 20	0.50
- 10	0.28
0	0.16
10	0.10
20	0.05
30	0.03

2. Before loading, air shall be removed and subsequently kept away to a sufficient extent from the cargo tanks and the accessory cargo piping by the means of inert gas (see also marginal 210 418).
3. Arrangements shall be made to ensure that the cargo is sufficiently stabilized in order to prevent a reaction at any time during carriage. The transport document shall contain the following additional particulars:
 - (a) Name and amount of inhibitor added;
 - (b) Date on which inhibitor was added and expected duration of effectiveness under normal conditions;
 - (c) Any temperature limits having an effect on the inhibitor.

When stabilization is ensured solely by blanketing with an inert gas it is sufficient to mention the name of the inert gas used in the transport document.

When stabilization is ensured by another measurement, e.g. the special purity of the substance, this measurement shall be mentioned in the transport document.

4. The substance shall not be allowed to solidify; the transport temperature shall be maintained above the melting point. In instances where cargo heating installations are required, they must be so designed that polymerization through heating is not possible in any part of the cargo tank. Where the temperature of steam-heated coils could give rise to overheating, lower-temperature indirect heating systems shall be provided.
5. The flame-arresters in accordance with marginal 321 222 (5) or 331 222 (5) may be dismantled if no other measures for avoiding clogging of fittings have been taken (e.g. heating of the flame-arresters).
6. If external temperatures below or equal to that indicated in column 20, are encountered, the substance may only be carried in tank vessels equipped with a cargo heating system conforming to marginal 321 242 or 331 242 and, in the case of closed-type vessels, when the vapour pipes and the pressure/vacuum valves may be heated. The arrangement of heating coils inside the cargo tanks in stead of a cargo heating system may be sufficient, if there is no risk of cargo solidifying during carriage.

Annex B.2 - Appendix 4

7. For closed-type vessels, the vapour pipe and the pressure/vacuum valves shall be capable of being heated.
8. Double-hull spaces, double bottoms and heating coils shall not contain any water.
9.
 - (a) While the vessel is under way, an inert-gas pad shall be maintained in the ullage space above the liquid level.
 - (b) Cargo piping and vent lines shall be independent of the corresponding piping used for other cargoes.
 - (c) Safety valves shall be made of stainless steel.
10. (Not relevant).
11.
 - (a) Stainless steel of type 416 or 442 and cast iron shall not be used for cargo tanks and pipes for loading and unloading.
 - (b) The cargo may be discharged only by deep-well pumps or pressure inert gas displacement. Each cargo pump shall be arranged to ensure that the substance does not heat significantly if the pressure discharge line from the pump is shut off or otherwise blocked.
 - (c) The cargo shall be cooled and maintained at temperatures below 30 °C.
 - (d) The safety valves shall be set at a pressure of not less than 550 kPa (5.5 bar) gauge pressure. Special authorization is required for the maximum setting pressure .
 - (e) While the vessel is under way, a nitrogen pad shall be maintained in the ullage space above the cargo. An automatic nitrogen supply system shall be installed to prevent the pressure from falling below 7 kPa (0.07 bar) gauge within the cargo tank in the event of a cargo temperature fall due to ambient temperature conditions or to some other reason . In order to satisfy the demand of the automatic pressure control a sufficient amount of nitrogen shall be available on board. Nitrogen of a commercially pure quality of 99.9 %, by volume, shall be used for padding. A battery of nitrogen cylinders connected to the cargo tanks through a pressure reduction valve satisfies the intention of the expression "automatic" in this context.

The required nitrogen pad shall be such that the nitrogen concentration in the vapour space of the cargo tank is not less than 45 % at any time.
 - (f) Before loading and while the cargo tank contains this substance in a liquid or gaseous form, it shall be inerted with nitrogen.
 - (g) The water-spray system shall be fitted with remote-control devices which can be operated from the wheelhouse or from the control station, if any.
 - (h) Transfer arrangements shall be provided for emergency transfer of ethylene oxide in the event of an uncontrollable self-reaction.

Annex B.2 - Appendix 4

12. (a) The substances shall be acetylene free.
- (b) The cargo tanks shall be entered and inspected prior to each new loading of these substances to ensure freedom from contamination, heavy rust deposits or visible structural defects.
- When these cargo tanks are in continuous service for these substances, such inspection shall be performed at intervals of not more than two and a half years.
- (c) All shut-off valves, flanges, fittings and accessory equipment shall be of a type suitable for use with these substances and shall be constructed of steel, stainless steel or other material approved by the recognized classification society. The chemical composition of all material shall be submitted to the recognized classification society for approval prior to manufacture. Valve disks or valve sealing faces, valve seats or other wearing parts of shut-off valves shall be made of stainless steel containing not less than 11% chromium.
- (d) Threaded joints may not be used in pipes for loading and unloading.
- (e) Pipes for loading and unloading inside the cargo tank shall extend within 100 mm of the bottom of the cargo tank or pump sump.
- (f) When gas is returned to the shore installation during loading, the vapour pipe connected to the tank containing these substances shall be independent from all other cargo tanks.
- (g) During discharge operations, the pressure in the cargo tanks shall be maintained above 7 kPa (0.07 bar) gauge.
- (h) The cargo may be discharged only by deep-well pumps, hydraulically operated submerged pumps or pressure inert gas displacement. Each cargo pump shall be arranged to ensure that the substance does not heat significantly if the pressure discharge line from the pump is shut off or otherwise blocked.
- (i) Each cargo tank carrying these substances shall be provided with a vapour pipe which is independent from all other cargo tanks.
- (j) Cargo tanks, cofferdams, double-hull spaces, double bottoms, cargo tank spaces and service spaces in the cargo area adjacent to a cargo tank carrying this substance shall either contain compatible cargo or be inerted with inert gas. These spaces shall be monitored for these substances and oxygen. The oxygen content shall be maintained below 2 %, by volume.
- (k) No air shall be allowed to enter the cargo pumps and cargo piping system while these substances are contained within the system.
- (l) The piping system for cargo tanks to be loaded with these substances shall be separate from piping systems for all other cargo tanks, including empty cargo tanks. If the piping system for the cargo tanks to be loaded is not independent, separation shall be accomplished by the removal of spool pieces, shut-off valves, other pipe sections and by fitting blank flanges at

Annex B.2 - Appendix 4

12. (l) these locations. The required separation applies to all liquid pipes and vapour vent lines and any other connections which may exist such as common inert gas supply lines.

(m) These substances may be carried only in accordance with cargo handling plans that have been approved by the recognized classification society.

Each intended cargo loading arrangement shall be shown on a separate cargo handling plan.

Cargo handling plans shall show the entire cargo piping system and the locations for installation of blank flanges needed to meet the above piping separation requirements. A copy of each approved cargo handling plan shall be kept on board. Reference to the approved cargo handling plans shall be included in the certificate of approval.

(n) While the vessel is under way, a nitrogen pad shall be maintained in the ullage space above the cargo. An automatic nitrogen make-up system shall be installed to prevent the cargo tank pressure from falling below 7 kPa (0.07 bar) gauge in the event of a cargo temperature fall due to ambient temperature conditions or to some other reason. Sufficient nitrogen shall be available on board to satisfy the demand of automatic pressure control. Nitrogen of commercially pure quality of 99.9 %, by volume, shall be used for padding. A battery of nitrogen cylinders connected to the cargo tanks through a pressure reduction valve satisfies the intention of the expression "automatic" in this context.

(o) The vapour space of the cargo tanks shall be checked before and after each loading operation to ensure that the oxygen content is 2 %, by volume, or less.

(p) While loading or unloading cargo, the loading/unloading operation shall be capable of being interrupted by switches installed at two locations on board (fore and aft) and at two locations ashore (directly at the access to the ship and at a sufficient distance), i.e. the quick-action stop valve shall be capable of being shut directly at the flexible connecting line between the vessel and the shore installation.

Disconnection shall be designed according to the closed circuit principle.

13. (Not relevant.)

14. The following substances may not be carried under these conditions:

- substances with a self-ignition temperature ≤ 200 °C
- mixtures containing halogenated hydrocarbons
- mixtures containing more than 10% benzene
- substances and mixtures carried in a stabilized state.

15. Provision shall be made to ensure that alkaline or acidic substances such as sodium hydroxide solution or sulphuric acid do not contaminate this cargo.

Annex B.2 - Appendix 4

16. If there is a possibility of a dangerous reaction such as polymerisation, decomposition, thermal instability or evolution of gases resulting from local over heating of the cargo in either the cargo tank or associated piping system, this cargo shall be loaded and carried adequately segregated from other substances the temperature of which is sufficiently high to initiate such reaction. Heating coils inside cargo tanks carrying this substance shall be blanked off or secured by equivalent means.
17. The melting point of the cargo shall be shown in the transport document.
18. (Not relevant).
19. Provision shall be made to ensure that the cargo does not come into contact with water. The following additional requirements apply:

Carriage of the cargo is not permitted in cargo tanks adjacent to slop tanks or cargo tanks containing ballast water, slops or any other cargo containing water. Pumps, piping and vent lines connected to such tanks shall be separated from similar equipment of tanks carrying these substances. Pipes from slop tanks or ballast water pipes shall not pass through cargo tanks containing this cargo unless they are encased in a tunnel.
20. The maximum permitted transport temperature given in column 20 shall not be exceeded.
21. Nonanes having a flash point below 23 °C shall be carried under the substance identification number 3295, "hydrocarbons, liquid, n.o.s. (.....), Class 3, 3° (b)".
22. The relative density of the cargo shall be shown in the transport document.
23. The instrument for measuring the pressure of the vapour phase in the cargo tank shall activate the alarm when the internal pressure reaches 40 kPa. The water-spray system shall immediately be activated and remain in operation until the internal pressure drops to 30 kPa.
24. Substances having a flash point above 61° C which are handed over for carriage or which are carried heated within a limiting range of 15 K below their flash-point shall be carried as substances of Class 3, 72°.
25. Type 3 cargo tank may be used for the carriage of this substance provided that the construction of the cargo tank has been accepted by a recognized classification society for the maximum permitted transport temperature.
26. Type 2 cargo tank may be used for the carriage of this substance provided that the construction of the cargo tank has been accepted by a recognized classification society for the maximum permitted transport temperature.

Identification No	Name of substance	Class, item number and letter	Hazards	Type of tank vessel	Cargo tank design	Cargo tank type	Cargo tank equipment	Opening pressure of the velocity vent valve in kPa	Maximum degree of filling in %	Relative density at 20 °C	Type of sampling device	Cargo pump-room below deck permitted	Temperature class	Explosion group	Protection against explosions required	Flammable gas detector required	Toximeter required	Number of blue lights/cones	Other requirements/Remarks
1	2	3	4	5	6	7	8	9	10	11	12	13	14	15	16	17	18	19	20
1005	AMMONIA, ANHYDROUS	2, 2 ^o TC	2 + 6.1 + 8 + 3	G	1	1	3		91		1	yes	T1	II A	+	+	+	2	1
	AMMONIA ANHYDROUS (deeply refrigerated)	2, 3 ^o TC	2 + 6.1 + 8 + 3	G	1	1	1; 3		95		1	yes	T1	II A	+	+	+	2	1
1010	1,2 BUTADIENE, STABILIZED	2, 2 ^o F	2 + 3 + unst.	G	1	1			91		1	yes	T2	II B ¹⁾	+	+	-	1	2; 3
1010	1,3-BUTADIENE, STABILIZED	2, 2 ^o F	2 + 3 + unst.	G	1	1			91		1	yes	T2	II B	+	+	-	1	2; 3
1010	MIXTURES OF 1,3-BUTADIENE AND HYDROCARBONS, STABILIZED	2, 2 ^o F	2 + 3 + unst.	G	1	1			91		1	yes	T2	II B	+	+	-	1	2; 3
1011	BUTANE	2, 2 ^o F	2 + 3	G	1	1			91		1	yes	T2	II A	+	+	-	1	
1012	1-BUTYLENE	2, 2 ^o F	2 + 3	G	1	1			91		1	yes	T2	II A	+	+	-	1	
1020	CHLOROPENTAFLUOROETHANE (REFRIGERANT GAS R 115)	2, 2 ^o A	2	G	1	1			91		1	yes	-	-	-	-	-	0	
1030	1,1-DIFLUOROETHANE (REFRIGERANT GAS R 152(a))	2, 2 ^o F	2 + 3	G	1	1			91		1	yes	T1	II A	+	+	-	1	
1033	DIMETHYL ETHER	2, 2 ^o F	2 + 3	G	1	1			91		1	yes	T3	II B	+	+	-	1	
1040	ETHYLENE OXIDE WITH NITROGEN	2, 2 ^o TF	2 + 6.1 + 3	G	1	1			91		1	yes	T2	II B	+	+	+	2	2; 3; 11
1055	ISOBUTYLENE	2, 2 ^o F	2 + 3	G	1	1			91		1	yes	T2 ¹⁾	II B	+	+	-	1	
1063	METHYL CHLORIDE (REFRIGERANT GAS R40)	2, 2 ^o F	2 + 3	G	1	1			91		1	yes	T1	II A	+	+	-	1	
1077	PROPYLENE	2, 2 ^o F	2 + 3	G	1	1			91		1	yes	T2 ¹⁾	II A	+	+	-	1	

1	2	3	4	5	6	7	8	9	10	11	12	13	14	15	16	17	18	19	20
1083	TRIMETHYLAMINE, ANHYDROUS	2, 2°F	2 + 3	G	1	1			91		1	yes	T4	II A	+	+	-	1	
1086	VINYL CHLORIDE, STABILIZED	2, 2°F	2 + 3 + unst.	G	1	1			91		1	yes	T2	II A	+	+	-	1	2; 3
1088	ACETAL	3, 3° (b)	3	N	2	2		10	97	0.83	3	yes	T3	II B ⁴⁾	+	+	-	1	
1089	ACETALDEHYDE (ethanal)	3, 1° (a)	3	C	1	1			95	0.78	1	yes	T4	II A	+	+	-	1	
1090	ACETONE	3, 3° (b)	3	N	2	2		10	97	0.79	3	yes	T1	II A	+	+	-	1	
1092	ACROLEIN, STABILIZED	6.1, 8° (a)2.	6.1 + 3 + unst.	C	2	2	3	50	95	0.84	1	no	T3 ²⁾	II B	+	+	+	2	2; 3; 23
1093	ACRYLONITRILE, STABILIZED	3, 11° (a)	3 + 6.1 + unst.	C	2	2	3	50	95	0.80	1	no	T1	II B	+	+	+	2	3; 23
1098	ALLYL ALCOHOL	6.1, 8° (a)2.	6.1 + 3	C	2	2		40	95	0.85	1	no	T2	II B	+	+	+	2	
1100	ALLYL CHLORIDE	3, 16° (a)	3 + 6.1	C		2	3	50	95	0.94	1	no	T2	II A	+	+	+	2	23
1105	PENTANOLS (n-pentanol)	3, 31° (c)	3	N	3	2			97	0.81	3	yes	T3	II A	+	+	-	1	
1106	AMYLAMINE (n-amylamine)	3, 22° (b)	3 + 8	C	2	2		40	95	0.76	2	yes	T4 ³⁾	II A ⁷⁾	+	+	-	1	
1107	AMYL CHLORIDES (1-chloropentane)	3, 3° (b)	3	C	2	2		40	95	0.88	2	yes	T3	II A	+	+	-	1	
1107	AMYL CHLORIDES (1-chloro-3-methylbutane)	3, 3° (b)	3	C	2	2		45	95	0.89	2	yes	T3	II A	+	+	-	1	
1107	AMYL CHLORIDES (2-chloro-3-methylbutane)	3, 3° (b)	3	C	2	2		50	95	0.897	2	yes	T2	IIA	+	+	-	1	
1107	AMYL CHLORIDES (2-chloro-2-methylbutane)	3, 3° (b)	3	C	2	2		50	95	0.87	2	yes	T2	II A	+	+	-	1	
1107	AMYL CHLORIDES (1-chloro-2,2-dimethylpropane)	3, 3° (b)	3	C	2	2		50	95	0.87	2	yes	T3 ²⁾	II A	+	+	-	1	
1107	AMYL CHLORIDES (...)	3, 3° (b)	3	C	1	1			95	0.9	1	yes	T3 ²⁾	II A	+	+	-	1	
1108	1-PENTENE (n-amylene)	3, 1° (a)	3	N	1	1			97	0.64	1	yes	T3	II B ⁴⁾	+	+	-	1	
1114	BENZENE	3, 3° (b)	3	C	2	2	3	50	95	0.88	2	yes	T1	II A	+	+	+	1	5; 6: +10 °C; 17; 23
1120	BUTANOLS (n-butyl alcohol)	3, 31° (c)	3	N	3	2			97	0.81	3	yes	T2	II B	+	+	-	1	
1120	BUTANOLS (secondary butyl alcohol)	3, 31° (c)	3	N	3	2			97	0.81	3	yes	T2	II B ⁷⁾	+	+	-	1	

1	2	3	4	5	6	7	8	9	10	11	12	13	14	15	16	17	18	19	20
1120	BUTANOLS (tertiary butyl alcohol)	3, 3° (b)	3	N	2	2	2	10	97	0.79	3	yes	T1	II A ⁷⁾	+	+	-	1	5; 7; 17
1123	BUTYL ACETATES (n-butyl acetate)	3, 31° (c)	3	N	3	2			97	0.88	3	yes	T2	II A	+	+	-	1	
1123	BUTYL ACETATES (sec-butyl acetate)	3, 3° (b)	3	N	2	2		10	97	0.86	3	yes	T2	II A ⁷⁾	+	+	-	1	5
1125	n-BUTYLAMINE	3, 22° (b)	3 + 8	C	2	2	3	50	95	0.75	2	yes	T2	II A	+	+	-	1	23
1127	CHLOROBUTANES (1-chlorobutane)	3, 3° (b)	3	C	2	2	3	50	95	0.89	2	yes	T3	II A	+	+	-	1	23
1127	CHLOROBUTANES (2-chlorobutane)	3, 3° (b)	3	C	2	2	3	50	95	0.87	2	yes	T4 ³⁾	II A	+	+	-	1	23
1127	CHLOROBUTANES (2-chloro-2-methylpropane)	3, 3° (b)	3	C	2	2	3	50	95	0.84	2	yes	T1	II A	+	+	-	1	23
1127	CHLOROBUTANES (1-chloro-2-methylpropane)	3, 3° (b)	3	C	2	2	3	50	95	0.88	2	yes	T4 ³⁾	II A	+	+	-	1	23
1127	CHLOROBUTANES (...)	3, 3° (b)	3	C	1	1			95	0.89	1	yes	T4 ³⁾	II A	+	+	-	1	
1129	BUTYRALDEHYDE (n-butyraldehyde)	3, 3° (b)	3	C	2	2	3	50	95	0.80	2	yes	T4	II A	+	+	-	1	15; 23
1131	CARBON DISULPHIDE (carbonyl sulphide)	3, 18° (a)	3 + 6.1	C	2	2	3	50	95	1.26	1	no	T6	II C	+	+	+	2	2; 9; 23
1134	CHLOROBENZENE (phenyl chloride)	3, 31° (c)	3	C	2	2		30	95	1.11	2	yes	T1	II A ⁸⁾	+	+	-	1	
1135	ETHYLENE CHLOROHYDRIN (2-chloroethanol)	6.1, 16° (a)	6.1 + 3	C	2	2		30	95	1.21	1	no	T2	II A ⁸⁾	+	+	+	2	
1143	CROTONALDEHYDE, STABILIZED	6.1, 8° (a)2.	6.1 + 3 + unst.	C	2	2		40	95	0.85	1	no	T3	II B	+	+	+	2	3; 15
1145	CYCLOHEXANE	3, 3° (b)	3	N	2	2		10	97	0.78	3	yes	T3	II A	+	+	-	1	5; 6; +11 °C; 17
1146	CYCLOPENTANE	3, 3° (b)	3	N	2	2		10	97	0.75	3	yes	T2	II B ⁴⁾	+	+	-	1	
1150	1,2-DICHLOROETHYLENE (cis)	3, 3° (b)	3	C	2	2	3	50	95	1.28	2	yes	T2 ¹⁾	II A	+	+	-	1	23
1150	1,2-DICHLOROETHYLENE (trans)	3, 3° (b)	3	C	2	2	3	50	95	1.26	2	yes	T2	II A	+	+	-	1	23
1153	ETHYLENEGLYCOL DIETHYL ETHER	3, 31° (c)	3	N	3	2			97	0.84	3	yes	T4 ³⁾	II B ⁴⁾	+	+	-	1	

1	2	3	4	5	6	7	8	9	10	11	12	13	14	15	16	17	18	19	20
1155	DIETHYL ETHER (ETHYL ETHER)	3, 2° (a)	3	C	1	1			95	0.71	1	yes	T4	II B	+	+	-	1	
1157	DIISOBUTYL KETONE	3, 31° (c)	3	N	3	2			97	0.81	3	yes	T4 ³⁾	II B ⁴⁾	+	+	-	1	
1159	DIISOPROPYL ETHER	3, 3° (b)	3	N	2	2		10	97	0.72	3	yes	T2	II A	+	+	-	1	
1160	DIMETHYLAMINE AQUEOUS SOLUTION	3, 22° (b)	3 + 8	C	2	2	3	50	95	0.82	2	yes	T2	II B ⁴⁾	+	+	-	1	23
1163	DIMETHYLHYDRAZINE UNSYMMETRICAL	6.1, 7° (a)1.	6.1 + 3 + 8	C	2	2	3	50	95	0.78	1	no	T3	II B ⁴⁾	+	+	+	2	23
1165	DIOXANE	3, 3° (b)	3	N	2	2		10	97	1.03	3	yes	T2	II B	+	+	-	1	5; 6: +14 °C; 17
1167	DIVINYL ETHER, STA BILIZED	3, 2° (a)	3 + unst.	C	1	1			95	0.77	1	yes	T2	II B ⁷⁾	+	+	-	1	2; 3
1170	ETHANOLSOLUTION (ETHYL ALCOHOL SOLUTION) aqueous solution with more than 24% and not more than 70% alcohol by volume	3, 31° (c)	3	N	3	2			97	0.87 -0.96	3	yes	T2	II B	+	+	-	1	
1170	ETHANOLSOLUTION (ETHYL ALCOHOL SOLUTION) aqueous solution with more than 70% alcohol by volume	3, 3° (b)	3	N	2	2		10	97	0.79 -0.87	3	yes	T2	II B	+	+	-	1	
1170	ETHANOL(ETHYL ALCOHOL)	3, 3° (b)	3	N	2	2		10	97	0.79 -0.87	3	yes	T2	II B	+	+	-	1	
1171	ETHYLENE GLYCOL MONOETHYL ETHER	3, 31° (c)	3	N	3	2			97	0.93	3	yes	T3	II B	+	+	-	1	
1172	ETHYLENE GLYCOL MONOETHYL ETHER ACETATE	3, 31° (c)	3	N	3	2			97	0.98	3	yes	T2	II A	+	+	-	1	
1173	ETHYL ACETATE	3, 3° (b)	3	N	2	2		10	97	0.90	3	yes	T1	II A	+	+	-	1	
1175	ETH YLBENZENE	3, 3° (b)	3	N	2	2		10	97	0.87	3	yes	T2	II B	+	+	-	1	
1177	ETHYLBUTYL ACETATE	3, 31° (c)	3	N	3	2			97	0.88	3	yes	T2	II A	+	+	-	1	
1184	ETHYLENE DICHLORIDE ((1,2 -dichloroethane)	3, 16° (b)	3 + 6.1	C	2	2		50	95	1.25	2	no	T2	II A	+	+	+	2	
1188	ETHYLENE GLYCOL MONOETHYL ETHER	3, 31° (c)	3	N	3	2			97	0.97	3	yes	T3	II B	+	+	-	1	

1	2	3	4	5	6	7	8	9	10	11	12	13	14	15	16	17	18	19	20
1191	OCTYLALDEHYDES (n-octaldehyde)	3, 31° (c)	3	N	3	2			97	0.82	3	yes	T3	II B ⁴⁾	+	+	-	1	
1191	OCTYLALDEHYDES (2-ethylcapronaldehyde)	3, 31° (c)	3	C	2	2		30	95	0.82	2	yes	T4	II A	+	+	-	1	
1193	ETHYLMETHYLKETONE (METHYLETHYLKETONE)	3, 3° (b)	3	N	2	2		10	97	0.80	3	yes	T1	II A	+	+	-	1	
1198	FORMALDEHYDE SOLUTION, FLAMMABLE	3, 33° (c)	3 + 8	N	3	2			97	1.09	3	yes	T2	II B	+	+	-	1	
1199	FURFURALDEHYDES (α -furfuraldehyde) or furfuraldehydes (α -furfurylaldehyde)	6.1, 13° (b)	6.1 + 3	C	2	2		35	95	1.16	2	no	T3 ²⁾	II B	+	+	+	2	15
1202	GASOIL or DIESEL FUEL or HEATING OILLIGHT	3, 31° (c)	3	N	4	2			97	0.74	3	yes	-	-	-	-	-	0	
1203	MOTOR SPIRIT or GASOLINE or PETROL	3, 3° (b)	3	N	2	2		10	97	0.68- 0.72 ¹⁰⁾	3	yes	T3	II A	+	+	-	1	14
1203	MOTOR SPIRIT or GASOLINE or PETROL with more than 10% benzen boilingpoint ≤ 60 °C	3, 3° (b)	3	C	1	1			95		1	yes	T3	II A	+	+	-	1	
1203	MOTOR SPIRIT or GASOLINE or PETROL with more than 10% benzen 60 °C < boilingpoint ≤ 85 °C	3, 3° (b)	3	C	2	2	3	50	95		2	yes	T3	II A	+	+	-	1	23
1203	MOTOR SPIRIT or GASOLINE or PETROL with more than 10% benzen 85 °C < boilingpoint ≤ 115 °C	3, 3° (b)	3	C	2	2		50	95		2	yes	T3	II A	+	+	-	1	
1203	MOTOR SPIRIT or GASOLINE or PETROL with more than 10% benzen boiling point > 115 °C	3, 3° (b)	3	C	2	2		35	95		2	yes	T3	II A	+	+	-	1	
1206	HEPTANES (n-heptane)	3, 3° (b)	3	N	2	2		10	97	0.68	3	yes	T3	II B ⁷⁾	+	+	-	1	
1208	HEXANES (n-hexane)	3, 3° (b)	3	N	2	2		10	97	0.66	3	yes	T3	II A	+	+	-	1	
1212	ISOBUTANOL (ISOBUTYL ALCOHOL)	3, 31° (c)	3	N	3	2			97	0.80	3	yes	T2	II B	+	+	-	1	
1213	ISOBUTYLACETATE	3, 3° (b)	3	N	2	2		10	97	0.87	3	yes	T2	II A ⁷⁾	+	+	-	1	

1	2	3	4	5	6	7	8	9	10	11	12	13	14	15	16	17	18	19	20
1214	ISOBUTYLAMINE	3, 22° (b)	3 + 8	C	2	2	3	50	95	0.73	2	yes	T2	II A	+	+	-	1	23
1216	ISOOCTENE	3, 3° (b)	3	N	2	2		10	97	0.73	3	yes	T3	II B ⁴⁾	+	+	-	1	
1218	ISOPRENE, STABILIZED	3, 2° (a)	3 + unst.	N	1	1			95	0.68	1	yes	T3	II B	+	+	-	1	2; 3; 16
1219	ISOPROPANOL (ISOPROPYL ALCOHOL)	3, 3° (b)	3	N	2	2		10	97	0.78	3	yes	T2	II A	+	+	-	1	
1220	ISOPROPYLEACETATE	3, 3° (b)	3	N	2	2		10	97	0.88	3	yes	T1	II A	+	+	-	1	
1221	ISOPROPYLAMINE	3, 22° (a)	3 + 8	C	1	1			95	0.69	1	yes	T2	II A ⁷⁾	+	+	-	1	
1223	KEROSENE	3, 31° (c)	3	N	3	2			97	≤ 0.83	3	yes	T3	II A	+	+	-	1	14
1224	KETONES, LIQUID, N.O.S. (.....) f.p. < 23 °C 110 kPa < vp50 ≤ 175 kPa	3, 2° (b)	3	N	2	2		50	97		3	yes	T4 ³⁾	II B ⁴⁾	+	+	-	1	14
1224	KETONES, LIQUID, N.O.S. (...) f.p. < 23 °C 110 kPa < vp50 ≤ 150 kPa	3, 2° (b)	3	N	2	2	3	10	97		3	yes	T4 ³⁾	II B ⁴⁾	+	+	-	1	14
1224	KETONES, LIQUID, N.O.S. (...) f.p. < 23 °C vp50 ≤ 110 kPa	3, 3° (b)	3	N	2	2		10	97		3	yes	T4 ³⁾	II B ⁴⁾	+	+	-	1	14
1224	KETONES, LIQUID, N.O.S. (...) f.p. ≥ 23 °C	3, 31° (c)	3	N	3	2			97		3	yes	T4 ³⁾	II B ⁴⁾	+	+	-	1	14
1229	MESITYLOXYDE	3, 31° (c)	3	N	3	2			97	0.85	3	yes	T2	II B ⁴⁾	+	+	-	1	
1230	METHANOL	3, 17° (b)	3 + 6.1	N	2	2	3	50	97	0.79	2	yes	T1	II A	+	+	-	1	23
1231	METHYL ACETATE	3, 3° (b)	3	N	2	2		10	97	0.93	3	yes	T1	II A	+	+	-	1	
1235	METHYLAMINE, AQUEOUS SOLUTION	3, 22° (b)	3 + 8	C	2	2		50	95		2	yes	T2	II A	+	+	-	1	
1243	METHYL FORMATE	3, 1° (a)	3	N	1	1			97	0.97	1	yes	T2	II A	+	+	-	1	
1244	METHYLHYDRAZINE	6.1, 7° (a)1.	6.1 + 3 + 8	C	2	2		45	95	0.88	1	no	T4	II C ⁵⁾	+	+	+	2	
1245	METHYL ISOBUTYL KETONE	3, 3° (b)	3	N	2	2		10	97	0.80	3	yes	T1	II A	+	+	-	1	
1247	METHYL METHACRYLATE MONOMER, STABILIZED	3, 3° (b)	3 + unst.	C	2	2		40	95	0.94	1	yes	T2	II A	+	+	-	1	3; 16
1262	OCTANES (n-octane)	3, 3° (b)	3	N	2	2		10	97	0.70	3	yes	T3	II A	+	+	-	1	

1	2	3	4	5	6	7	8	9	10	11	12	13	14	15	16	17	18	19	20
1264	PARALDEHYDE	3, 31° (c)	3	N	3	2			97	0.99	3	yes	T3	II A ⁷⁾	+	+	-	1	5; 6: +16 °C; 17
1265	PENTANES, liquid (n-pentan e)	3, 2° (b)	3	N	2	2		50	97	0.63	3	yes	T3	II A	+	+	-	1	
1265	PENTANES, liquid (n-pentan e)	3, 2° (b)	3	N	2	2	3	10	97	0.63	3	yes	T3	II A	+	+	-	1	
1265	PENTANES, liquid (2-methylbutan e)	3, 1° (a)	3	N	1	1			97	0.62	1	yes	T2	II A	+	+	-	1	
1267	PETROLEUM CRUDE OIL f.p. < 23 °C vp50 > 175 kPa	3, 1° (a)	3	N	1	1			97		1	yes	T4 ³⁾	II B ⁴⁾	+	+	-	1	14
1267	PETROLEUM CRUDE OIL f. p. < 23 °C vp50 > 175 kPa	3, 1° (a)	3	N	2	2	1	50	97		2	yes	T4 ³⁾	II B ⁴⁾	+	+	-	1	14
1267	PETROLEUM CRUDE OIL f.p. < 23 °C 110 kPa < vp50 ≤ 175 kPa	3, 2° (a) 3, 2° (b)	3	N	2	2		50	97		3	yes	T4 ³⁾	II B ⁴⁾	+	+	-	1	14
1267	PETROLEUM CRUDE OIL f.p. < 23 °C 110 kPa < vp50 ≤ 150 kPa	3, 2° (a) 3, 2° (b)	3	N	2	2	3	10	97		3	yes	T4 ³⁾	II B ⁴⁾	+	+	-	1	14
1267	PETROLEUM CRUDE OIL f.p. < 23 °C vp50 ≤ 110 kPa	3, 3° (b)	3	N	2	2		10	97		3	yes	T4 ³⁾	II B ⁴⁾	+	+	-	1	14
1267	PETROLEUM CRUDE OIL f.p. ≥ 23 °C	3, 31° (c)	3	N	3	2			97		3	yes	T4 ³⁾	II B ⁴⁾	+	+	-	1	14
1267	PETROLEUM CRUDE OIL with more than 10% benzen f.p. < 23 °C vp50 > 175kPa	3, 1° (a)	3	C	1	1			95		1	yes	T4 ³⁾	II B ⁴⁾	+	+	-	1	
1267	PETROLEUM CRUDE OIL with more than 10% benzen f.p.< 23 °C 110 kPa < vp 50 ≤ 175 kPa	3, 2° (a) 3, 2° (b)	3	C	1	1			95		1	yes	T4 ³⁾	II B ⁴⁾	+	+	-	1	
1267	PETROLEUM CRUDE OIL with more than 10% benzen f.p. < 23 °C vp50 ≤ 110 kPa boilingpoint ≤ 60 °C	3, 3° (b)	3	C	1	1			95		1	yes	T4 ³⁾	II B ⁴⁾	+	+	-	1	

1	2	3	4	5	6	7	8	9	10	11	12	13	14	15	16	17	18	19	20
1267	PETROLEUM CRUDE OIL with more than 10% benzen f.p. < 23 °C vp50 ≤ 110 kPa 60 °C < boilingpoint ≤ 85 °C	3, 3° (b)	3	C	2	2	3	50	95		2	yes	T4 ³⁾	II B ⁴⁾	+	+	-	1	23
1267	PETROLEUM CRUDE OIL with more than 10% benzen f.p. < 23 °C vp50 ≤ 110 kPa 85 °C < boilingpoint ≤ 115 °C	3, 3° (b)	3	C	2	2		50	95		2	yes	T4 ³⁾	II B ⁴⁾	+	+	-	1	
1267	PETROLEUM CRUDE OIL with more than 10% de benzen f.p. < 23 °C vp50 ≤ 110 kPa boiling point > 115 °C	3, 3° (b)	3	C	2	2		35	95		2	yes	T4 ³⁾	II B ⁴⁾	+	+	-	1	
1268	PETROLEUM DISTILLATES, N.O.S.orPETROLEUM PRODUCTS, N.O.S. f.p. < 23 °C vp50 > 175 kPa	3, 1° (a)	3	N	1	1			97		1	yes	T4 ³⁾	II B ⁴⁾	+	+	-	1	14
1268	PETROLEUM DISTILLATES, N.O.S. orPETROLEUM PRODUCTS, N.O.S. f.p. < 23 °C vp50 > 175 kPa	3, 1° (a)	3	N	2	2	1	50	97		2	yes	T4 ³⁾	II B ⁴⁾	+	+	-	1	14
1268	PETROLEUM DISTILLATES, N.O.S. orPETROLEUM PRODUCTS, N.O.S. f.p. < 23 °C 110 kPa < vp50 ≤ 175 kPa	3, 2° (a) 3, 2° (b)	3	N	2	2		50	97		3	yes	T4 ³⁾	II B ⁴⁾	+	+	-	1	14
1268	PETROLEUM DISTILLATES, N.O.S. orPETROLEUM PRODUCTS, N.O.S. f.p. < 23 °C 110 kPa < vp50 ≤ 150 kPa	3, 2° (a) 3, 2° (b)	3	N	2	2	3	10	97		3	yes	T4 ³⁾	II B ⁴⁾	+	+	-	1	14
1268	PETROLEUM DISTILLATES, N.O.S. orPETROLEUM PRODUCTS N.O.S. f.p. < 23 °C vp50 ≤ 110 kPa	3, 3° (b)	3	N	2	2		10	97		3	yes	T4 ³⁾	II B ⁴⁾	+	+	-	1	14

1	2	3	4	5	6	7	8	9	10	11	12	13	14	15	16	17	18	19	20
1268	PETROLEUM DISTILLATES, N.O.S. or PETROLEUM PRODUCTS, N.O.S. f.p. ≥ 23 °C	3, 31° (c)	3	N	3	2			97		3	yes	T4 ³⁾	II B ⁴⁾	+	+	-	1	14
1268	PETROLEUM DISTILLATES, N.O.S. with more than 10% benzen or PETROLEUM PRODUCTS, N.O.S. with more than 10% benzen f.p. < 23 °C vp > 175 kPa	3, 1° (a)	3	C	1	1			95		1	yes	T4 ³⁾	II B ⁴⁾	+	+	-	1	
1268	PETROLEUM DISTILLATES N.O.S. with more than 10% benzen or PETROLEUM PRODUCTS, N.O.S. with more than 10% benzen f.p. < 23 °C 110 kPa $< vp50 < 175$ kPa	3, 2° (a) 3, 2° (b)	3	C	1	1			95		1	yes	T4 ³⁾	II B ⁴⁾	+	+	-	1	
1268	PETROLEUM DISTILLATES N.O.S. with more than 10% benzen or PETROLEUM PRODUCTS, N.O.S. with more than 10% benzen f.p. < 23 °C vp50 ≤ 110 kPa boilingpoint ≤ 60 °C	3, 3° (b)	3	C	1	1			95		1	yes	T4 ³⁾	II B ⁴⁾	+	+	-	1	
1268	PETROLEUM DISTILLATES N.O.S. with more than 10% benzen or petroleum products, n.o.s. with more than 10% benzen f.p. < 23 °C vp50 ≤ 110 kPa 60 °C $< boilingpoint \leq 85$ °C	3, 3° (b)	3	C	2	2	3	50	95		2	yes	T4 ³⁾	II B ⁴⁾	+	+	-	1	23
1268	PETROLEUM DISTILLATES N.O.S. with more 10% benzen or PETROLEUM PRODUCTS, N.O.S. with more 10% benzen f.p. < 23 °C vp50 ≤ 110 kPa 85 °C $< boilingpoint \leq 115$ °C	3, 3° (b)	3	C	2	2		50	95		2	yes	T4 ³⁾	II B ⁴⁾	+	+	-	1	

1	2	3	4	5	6	7	8	9	10	11	12	13	14	15	16	17	18	19	20
1268	PETROLEUM DISTILLATES N.O.S. with more than 10% benzen or PETROLEUM PRODUCTS, N.O.S. with more than 10% benzen f.p. < 23 °C vp50 ≤ 110 kPa boiling point > 115 °C	3, 3° (b)	3	C	2	2		35	95		2	yes	T4 ³⁾	II B ⁴⁾	+	+	-	1	
1274	n-PROPANOL (PROPYL ALCOHOL, NORMAL)	3, 3° (b)	3	N	2	2		10	97	0.80	3	yes	T2	II B	+	+	-	1	
1275	PROPIONALDEHYDE	3, 3° (b)	3	C	2	2	3	50	95	0.81	2	yes	T4	II B	+	+	-	1	15; 23
1277	PROPYLAMINE (1-aminopropane)	3, 22° (b)	3 + 8	C	2	2	3	50	95	0.72	2	yes	T3 ²⁾	II A	+	+	-	1	23
1278	PROPYL CHLORIDE (1-chloropropane)	3, 2° (b)	3	C	2	2	3	50	95	0.89	2	yes	T1	II A	+	+	-	1	23
1279	PROPYL DICHLORIDE (1,2-DICHLOROPROpane)	3, 3° (b)	3	C	2	2		45	95	1.16	2	yes	T1	II A ⁸⁾	+	+	-	1	
1280	PROPYLENE OXIDE	3, 2° (a)	3 + unst.	C	1	1			95	0.83	1	yes	T2	II B	+	+	-	1	2; 12
1282	PYRIDINE	3, 3° (b)	3	N	2	2		10	97	0.98	3	yes	T1	II A ⁸⁾	+	+	-	1	
1294	TOLUENE	3, 3° (b)	3	N	2	2		10	97	0.87	3	yes	T1	II A ⁸⁾	+	+	-	1	
1296	TRIETHYLAMINE	3, 22° (b)	3 + 8	C	2	2		50	95	0.73	2	yes	T3	II A ⁸⁾	+	+	-	1	
1300	TURPENTINESUBSTITUTE (White spirit)	3, 31° (c)	3	N	3	2			97	0.78	3	yes	T3	II B ⁴⁾	+	+	-	1	
1301	VINYL ACETATE, STABILIZED	3, 3° (b)	3 + unst.	N	2	2		10	97	0.93	2	yes	T2	II A	+	+	-	1	3; 16
1307	XYLENES (m-xylene)	3, 31° (c)	3	N	3	2			97	0.86	3	yes	T1	II A	+	+	-	1	
1307	XYLENES (o-xylene)	3, 3° (b)	3	N	3	2			97	0.88	3	yes	T1	II A	+	+	-	1	
1307	XYLENES (p-xylene)	3, 31° (c)	3	N	3	2			97	0.86	3	yes	T1	II A	+	+	-	1	5; 6; +17 °C; 17
1541	ACETONECYANOHYDRIN, STABILIZED	6.1, 12° (a)	6.1+ unst.	C	2	2		50	95	0.932	1	no	-	-	-	-	+	2	3
1545	ALLYL ISOTHIOCYANATE, STABILIZED	6.1, 20° (b)	6.1 + 3 + unst.	C	2	2		30	95	1.02	1	no	T4 ³⁾	II B ⁴⁾	+	+	+	2	2; 3
1547	ANILINE	6.1, 12° (b)	6.1	C	2	2		25	95	1.02	2	no	-	-	-	-	+	2	5
1578	CHLORONITROBENZENES (p-chloronitrobenzene)	6.1, 12° (b)	6.1	C	2	1	2	25	95	1.37	2	no	T4 ³⁾	II B ⁴⁾	+	+	+	2	5; 7; 17
1591	o-DICHLOROBENZENE	6.1, 15° (c)	6.1	C	2	2		25	95	1.32	2	no	-	-	-	-	+	0	

1	2	3	4	5	6	7	8	9	10	11	12	13	14	15	16	17	18	19	20
1593	DICHLOROMETHANE (methyl chloride)	6.1, 15° (c)	6.1	C	2	2	3	50	95	1.33	2	no	-	-	-	-	+	0	23
1594	DIETHYLSULPHATE	6.1, 14° (b)	6.1	C	2	2		25	95	1.18	2	no	-	-	-	-	-	2	
1604	ETHYLENEDIAMINE	8, 54° (b)	8 + 3	N	3	2			97	0.90	3	yes	T2	II A	+	+	-	1	5; 6: +12 °C; 17
1605	ETHYLENE DIBROMIDE	6.1, 15° (a)	6.1	C	2	2		30	95	2.18	1	no	-	-	-	-	+	2	5; 6: +14 °C; 17
1648	ACETONITRILE (methyl cyanide)	3, 3° (b)	3	N	2	2		10	97	0.78	3	yes	T1	II A	+	+	-	1	
1662	NITROBENZENE	6.1, 12° (b)	6.1	C	2	2		25	95	1.21	2	no	T1	II B	+	+	+	2	5; 6: +10 °C; 17
1663	NITROPHENOLS	6.1, 12° (c)	6.1	C	2	2	2	25	95		2	no	T1	II B ⁴⁾	+	+	+	0	5; 7; 17
1664	NITROTOLUENES (o-nitrotoluene)	6.1, 12° (b)	6.1	C	2	2		25	95	1.16	2	no	-	-	-	-	+	2	5; 17
1664	NITROTOLUENES (p-nitrotoluene, molten)	6.1, 12° (b)	6.1	C	2	2	2	25	95	1.16	2	no	T2	II B ⁴⁾	+	+	+	2	5; 7; 17
1708	TOLUIDINES (o-toluidine)	6.1, 12° (b)	6.1	C	2	2		25	95	1.00	2	no	-	-	-	-	+	2	
1708	TOLUIDINES (m-toluidine)	6.1, 12° (b)	6.1	C	2	2		25	95	1.03	2	no	-	-	-	-	+	2	
1708	TOLUIDINES (p-toluidine)	6.1, 12° (b)	6.1	C	2	2	2	25	95	1.05	2	no	T1	II A ⁸⁾	+	+	+	2	5; 7; 17
1710	TRICHOLORETHYLENE	6.1, 15° (c)	6.1	C	2	2		50	95	1.46	2	no	-	-	-	-	+	0	15
1715	ACETIC ANHYDRIDE	8, 32° (b)2.	8 + 3	N	2	3		10	97	1.08	3	yes	T2	II A	+	+	-	1	
1717	ACETYLCHLORIDE	3, 25° (b)	3 + 8	C	2	2	3	50	95	1.10	2	yes	T2	II A ⁸⁾	+	+	-	1	23
1718	BUTYLACIDPHOSPHATE	8, 38° (c)	8	N	4	3			97	0.98	3	yes	-	-	-	-	-	0	
1719	CAUSTIC ALKALI LIQUID, N.O.S. (...)	8, 42° (b) 8, 42° (c)	8	N	4	2			97		3	yes	-	-	-	-	-	0	
1738	BENZYLCHLORIDE	6.1, 27° (b)	6.1 + 8 + 3	C	2	2		25	95	1.10	2	no	T1	II A ⁸⁾	+	+	+	2	
1742	BORON TRIFLUORIDE ACETIC ACID COMPLEX	8, 33° (b)	8	N	4	2			97	1.35	3	yes	-	-	-	-	-	0	
1750	CHLORACETIC ACID SOLUTION	6.1, 27° (b)	6.1 + 8	C	2	2	2	25	95	1.58	2	no	T1	II A	+	+	+	2	5; 7; 17

1	2	3	4	5	6	7	8	9	10	11	12	13	14	15	16	17	18	19	20
1760	CORRO SIVE LIQUID, N.O.S. (...)	8, 66° (a)	8	N	2	3		10	97		3	yes	—	—	-	-	-	2	
1760	CORRO SIVE LIQUID, N.O.S. (...)	8, 66° (b)	8	N	2	3		10	97		3	yes	-	-	-	-	-	0	
1760	CORRO SIVE LIQUID, N.O.S.	8, 66° (c)	8	N	4	3			97		3	yes	-	-	-	-	-	0	
1760	CORRO SIVE LIQUID, N.O.S. (sodium mercaptobenzothiazole, 50% aqueous solution)	8, 66° (b)	8	N	4	2			97	1.25	3	yes	-	-	-	-	-	0	
1760	CORRO SIVE LIQUID, N.O.S. (fatty alcohol, C ₁₂ -C ₁₄)	8, 66° (c)	8	N	4	2			97	0.89	3	yes	-	-	-	-	-	0	
1760	CORRO SIVE, N.O.S. (ethylene diaminetetraacetic acid, tetrasodium salt, 40% aqueous solution)	8, 66° (c)	8	N	4	2			97	1.28	3	yes	-	-	-	-	-	0	
1764	DICHLOROACETIC ACID	8, 32° (b)1.	8	N	3	3			97	1.56	3	yes	T4 ³⁾	II A	+	+	-	1	5; 6: +14 °C; 17
1778	FLUROSILICIC ACID	8, 8° (b)	8	N	2	3		10	97		3	yes	—	—	—	—	—	0	
1779	FORMIC ACID	8, 32° (b)1.	8 + 3	N	2	3		10	97	1.22	3	yes	T1	II A	+	+	-	1	5; 6: +12 °C; 17
1780	FUMARYL CHLORIDE	8, 35° (b)1.	8	N	2	3		10	97	1.41	3	yes	—	—	—	—	—	0	5; 8
1783	HEXAMETHYLENEDIAMINE SOLUTION	8, 53° (b) 8, 53° (c)	8	N	3	2	2		97		3	yes	T4 ³⁾	II B ⁴⁾	+	+	-	0	5; 7; 17
1789	HYDROCHLORIC ACID	8, 5° (b)	8	N	2	3		10	97		3	yes	—	—	—	—	—	0	
1789	HYDROCHLORIC ACID	8, 5° (c)	8	N	4	3			97		3	yes	—	—	—	—	—	0	
1805	PHOSPHORIC ACID with more than 80% acid, by volume	8, 17° (c)	8	N	4	3	2		95		3	yes	—	—	—	—	—	0	7; 17; 22
1805	PHOSPHORIC ACID with 80% (volume) acid, or less	8, 17° (c)	8	N	4	3			97	1.00– 1.60	3	yes	—	—	—	—	—	0	22
1814	POTASSIUM HYDROXIDE SOLUTION	8, 42° (b) 8, 42° (c)	8	N	4	2			97		3	yes	—	—	—	—	—	0	
1823	SODIUM HYDROXIDE, molten	8, 41° (b)	8	N	4	1	2		95	2.13	3	yes	—	—	—	—	—	0	7; 17
1824	SODIUM HYDROXIDE SOLUTION	8, 42° (b) 8, 42° (c)	8	N	4	2			97		3	yes	—	—	—	—	—	0	
1830	SULFURIC ACID with more than 51% acid	8, 1° (b)	8	N	4	3			97	1.40– 1.84	3	yes	—	—	—	—	—	0	8; 22

1	2	3	4	5	6	7	8	9	10	11	12	13	14	15	16	17	18	19	20
1831	SULFURIC ACID, FUMING (oleum)	8, 1° (a)	8 + 6.1	C	2	2		50	95	1.94	1	no	-	-	-	-	+	2	8
1832	SULFURIC ACID, SPENT	8, 1° (b)	8	N	4	3			97		3	yes	-	-	-	-	-	0	8
1846	CARBON TETRACHLORIDE	6.1, 15° (b)	6.1	C	2	2	3	50	95	1.59	2	no	-	-	-	-	+	2	23
1848	PROPIONIC ACID	8, 32° (c)	8 + 3	N	3	3			97	0.99	3	yes	T1	II A ⁷⁾	+	+	-	1	
1863	FUEL, AVIATION, TURBINE ENGINE f.p. < 23 °C vp50 > 175 kPa	3, 1° (a)	3	N	1	1			97		1	yes	T4 ³⁾	II B ⁴⁾	+	+	-	1	14
1863	FUEL, AVIATION, TURBINE ENGINE f.p. < 23 °C vp50 > 175 kPa	3, 1° (a)	3	N	2	2	1	50	97		2	yes	T4 ³⁾	II B ⁴⁾	+	+	-	1	14
1863	FUEL, AVIATION, TURBINE ENGINE f.p. < 23 °C 110 kPa < vp50 ≤ 175 kPa	3, 2° (a) 3, 2° (b)	3	N	2	2		50	97		3	yes	T4 ³⁾	II B ⁴⁾	+	+	-	1	14
1863	FUEL, AVIATION, TURBINE ENGINE f.p. < 23 °C 110 kPa < vp50 ≤ 150 kPa	3, 2° (a) 3, 2° (b)	3	N	2	2	3	10	97		3	yes	T4 ³⁾	II B ⁴⁾	+	+	-	1	14
1863	FUEL, AVIATION, TURBINE ENGINE f.p. < 23 °C vp50 ≤ 110 kPa	3, 3° (b)	3	N	2	2		10	97		3	yes	T4 ³⁾	II B ⁴⁾	+	+	-	1	14
1863	FUEL, AVIATION, TURBINE ENGINE f.p. ≥ 23 °C	3, 31° (c)	3	N	3	2			97		3	yes	T4 ³⁾	II B ⁴⁾	+	+	-	1	14
1863	FUEL, AVIATION, TURBINE ENGINE with more than 10% benzen f.p. < 23 °C vp50 > 175 kPa	3, 1° (a)	3	C	1	1			95		1	yes	T4 ³⁾	II B ⁴⁾	+	+	-	1	
1863	FUEL, AVIATION, TURBINE ENGINE with more than 10% benzen f.p. < 23 °C 110 kPa < vp50 ≤ 175 kPa	3, 2° (a) 3, 2° (b)	3	C	1	1			95		1	yes	T4 ³⁾	II B ⁴⁾	+	+	-	1	

1	2	3	4	5	6	7	8	9	10	11	12	13	14	15	16	17	18	19	20
1863	FUEL, AVIATION, TURBINE ENGINE with more than 10% benzen f.p. < 23 °C vp50 ≤ 110 kPa boilingpoint ≤ 60 °C	3, 3° (b)	3	C	1	1			95		1	yes	T4 ³⁾	II B ⁴⁾	+	+	-	1	
1863	FUEL, AVIATION, TURBINE ENGINE with more than 10% benzen f.p. < 23 °C vp50 ≤ 110 kPa 60 °C < boilingpoint ≤ 85 °C	3, 3° (b)	3	C	2	2	3	50	95		2	yes	T4 ³⁾ +	II B ⁴⁾	+	1	-	1	23
1863	FUEL, AVIATION, TURBINE ENGINE with more than 10% benzen f.p. < 23 °C vp50 ≤ 110 kPa 85 °C < boilingpoint ≤ 115 °C	3, 3° (b)	3	C	2	2		50	95		2	yes	T4 ³⁾ +	II B ⁴⁾	+	+	-	1	
1863	FUEL, AVIATION, TURBINE ENGINE with more than 10% benzen f.p. < 23 °C vp50 ≤ 110 kPa boiling point > 115 °C	3, 3° (b)	3	C	2	2		35	95		2	yes	T4 ³⁾	II B ⁴⁾	+	+	-	1	
1888	CHLOROFORM	6.1, 15° (c)	6.1	C	2	2	3	50	95	1.48	2	no	-	-	-	-	+	0	23
1897	TETRACHLORETHYLENE	6.1, 15° (c)	6.1	C	2	2		35	95	1.62	2	no	-	-	-	-	+	0	
1912	METHYL CHLORIDE AND METHYLENE CHLORIDE MIXTURE (liquefied gas)	2, 2°F	2 + 3	G	1	1			91		1	yes	T1	II A ⁸⁾	+	+	-	1	
1915	CYCLOHEXANONE	3, 31° (c)	3	N	3	2			97	0.95	3	yes	T2	II A	+	+	-	1	
1917	ETHYL ACRYLATE, STABILIZED	3, 3° (b)	3 + unst.	C	2	2		40	95	0.92	1	yes	T2	II B	+	+	-	1	3
1918	ISOPROPYLBENZENE (cumene)	3, 31° (c)	3	N	3	2			97	0.86	3	yes	T2	II A ⁸⁾	+	+	-	1	
1919	METHYL ACRYLATE, STABILIZED	3, 3° (b)	3 + unst.	C	2	2	3	50	95	0.95	1	yes	T2	II B	+	+	-	1	3; 23
1920	NONANES f.p. > 23 °C	3, 31° (c)	3	N	3	2			97	0.70-0.75	3	yes	T3	II A	+	+	-	1	21
1922	PYRROLIDINE	3, 23° (b)	3 + 8	C	2	2		50	95	0.86	2	yes	T2	II A	+	+	-	1	

1	2	3	4	5	6	7	8	9	10	11	12	13	14	15	16	17	18	19	20
1965	HYDROCARBON GAS MIXTURE. LIQUEFIED N.O.S.																		
	* MIXTURE A	2, 2°F	2 + 3	G	1	1			91		1	yes	T4 ³⁾	II B ⁴⁾	+	+	-	1	
	* MIXTURE A0	2, 2°F	2 + 3	G	1	1			91		1	yes	T4 ³⁾	II B ⁴⁾	+	+	-	1	
	* MIXTURE A01	2, 2°F	2 + 3	G	1	1			91		1	yes	T4 ³⁾	II B ⁴⁾	+	+	-	1	
	* MIXTURE A02	2, 2°F	2 + 3	G	1	1			91		1	yes	T4 ³⁾	II B ⁴⁾	+	+	-	1	
	* MIXTURE A1	2, 2°F	2 + 3	G	1	1			91		1	yes	T4 ³⁾	II B ⁴⁾	+	+	-	1	
	* MIXTURE B	2, 2°F	2 + 3	G	1	1			91		1	yes	T4 ³⁾	II B ⁴⁾	+	+	-	1	
	* MIXTURE B1	2, 2°F	2 + 3	G	1	1			91		1	yes	T4 ³⁾	II B ⁴⁾	+	+	-	1	
	* MIXTURE B2	2, 2°F	2 + 3	G	1	1			91		1	yes	T4 ³⁾	II B ⁴⁾	+	+	-	1	
* MIXTURE C	2, 2°F	2 + 3	G	1	1			91		1	yes	T4 ³⁾	II B ⁴⁾	+	+	-	1		
1969	ISOBUTANE	2, 2°F	2 + 3	G	1	1			91		1	yes	T2 ¹⁾	II A	+	+	-	1	
1978	PROPANE	2, 2°F	2 + 3	G	1	1			91		1	yes	T1	II A	+	+	-	1	
1986	ALCOHOLS, FLAMMABLE, TOXIC, N.O.S. (.....) F.p. < 23 °C boiling point ≤ 60 °C	3, 17° (a) 3, 17° (b)	3 + 6.1	C	1	1			95		1	no	T4 ³⁾	II B ⁴⁾	+	+	+	2	
1986	ALCOHOLS, FLAMMABLE, TOXIC, N.O.S. (.....) f.p. < 23 °C 60 °C < boiling point ≤ 85 °C	3, 17° (b)	3 + 6.1	C	2	2	3	50	95		2	no	T4 ³⁾	II B ⁴⁾	+	+	+	2	23
1986	ALCOHOLS, FLAMMABLE, TOXIC, N.O.S. (.....) f.p. < 23 °C 60 °C < boiling point ≤ 85 °C	3, 32° (c)	3 + 6.1	C	2	2	3	50	95		2	no	T4 ³⁾	II B ⁴⁾	+	+	+	1	23
1986	ALCOHOLS, FLAMMABLE, TOXIC, N.O.S. (.....) f.p. < 23 °C 85 °C < boiling point ≤ 115 °C	3, 17° (b)	3 + 6.1	C	2	2		50	95		2	no	T4 ³⁾	II B ⁴⁾	+	+	+	2	

1	2	3	4	5	6	7	8	9	10	11	12	13	14	15	16	17	18	19	20
1986	ALCOHOLS, FLAMMABLE, TOXIC, N.O.S. (.....) f.p. < 23 °C 85 °C < boiling-point ≤ 115 °C		3 + 6.1	C	2	2		50	95		2	no	T4 ³⁾	II B ⁴⁾	+	+	+	1	
1986	ALCOHOLS, FLAMMABLE, TOXIC, N.O.S.	3, 17° (b)	3 + 6.1	C	2	2		35	95		2	no	T4 ³⁾	II B ⁴⁾	+	+	+	2	
1987	ALCOHOLS, FLAMMABLE, N.O.S. (...) f.p. < 23 °C 110 kPa < vp50 ≤ 175 kPa	3, 2° (b)	3	N	2	2		50	97		3	yes	T4 ³⁾	II B ⁴⁾	+	+	-	1	14
1987	ALCOHOLS, FLAMMABLE, N.O.S. (...) f.p. < 23 °C 110 kPa < vp50 ≤ 150 kPa	3, 2° (b)	3	N	2	2	3	10	97		3	yes	T4 ³⁾	II B ⁴⁾	+	+	-	1	14
1987	ALCOHOLS, FLAMMABLE, N.O.S. (...) f.p. < 23 °C vp50 ≤ 110 kPa	3, 3° (b)	3	N	2	2		10	97		3	yes	T4 ³⁾	II B ⁴⁾	+	+	-	1	14
1987	ALCOHOLS FLAMMABLE, N.O.S. (tert-butanol 90% (mass)/methanol 10% (mass) mixture)	3, 3° (b)	3	N	2	2		10	97		3	yes	T1	II A	+	+	-	1	
1987	ALCOHOLS FLAMMABLE, N.O.S. (...) f.p. ≥ 23 °C	3, 31° (c)	3	N	3	2			97		3	yes	T4 ³⁾	II B ⁴⁾	+	+	-	1	14
1987	ALCOHOLS FLAMMABLE, N.O.S. (cyclohexanol)	3, 31° (c)	3	N	3	2	2		95	0.95	3	yes	T3	II A	+	+	-	1	5; 7; 17
1989	ALDEHYDES FLAMMABLE, N.O.S. (...) f.p. < 23 °C 110 kPa < vp50 ≤ 175 kPa	3, 2° (b)	3	N	2	2		50	97		3	yes	T4 ³⁾	II B ⁴⁾	+	+	-	1	14
1989	ALDEHYDES FLAMMABLE, N.O.S. (...) f.p. < 23 °C 110 kPa < vp50 ≤ 150 kPa	3, 2° (b)	3	N	2	2	3	10	97		3	yes	T4 ³⁾	II B ⁴⁾	+	+	-	1	14
1989	ALDEHYDES FLAMMABLE, N.O.S. (...) f.p. < 23 °C vp50 ≤ 110 kPa	3, 3° (b)	3	N	2	2		10	97		3	yes	T4 ³⁾	II B ⁴⁾	+	+	-	1	14

1	2	3	4	5	6	7	8	9	10	11	12	13	14	15	16	17	18	19	20
1989	ALDEHYDES FLAMMABLE, N.O.S. (...) f.p. ≥ 23 °C	3, 31 ^a (c)	3	N	3	2			97		3	yes	T4 ³⁾	II B ⁴⁾	+	+	-	1	14
1991	CHLOROPRENE, STABILIZED	3, 16 ^a (a)	3 + 6.1 + unst.	C	2	2	3	50	95	0.96	1	no	T2	II B ⁴⁾	+	+	+	2	3; 23
1992	FLAMMABLE LIQUID, TOXIC, N.O.S. (...) f.p. < 23 °C boiling point ≤ 60 °C	3, 19 ^a (a) 3, 19 ^a (b)	3 + 6.1	C	1	1			95		1	no	T4 ³⁾	II B ⁴⁾	+	+	+	2	
1992	FLAMMABLE LIQUID, TOXIC, N.O.S. (...) f.p. ≥ 23 °C boiling point ≤ 60 °C	3, 32 ^a (c)	3 + 6.1	C	1	1			95		1	no	T4 ³⁾	II B ⁴⁾	+	+	+	1	
1992	FLAMMABLE LIQUID, TOXIC, N.O.S. (...) f.p. < 23 °C 60 °C < boiling point ≤ 85 °C	3, 19 ^a (b)	3 + 6.1	C	2	2	3	50	95		2	no	T4 ³⁾	II B ⁴⁾	+	+	+	2	23
1992	FLAMMABLE TOXIC, N.O.S. (...) f.p. ≥ 23 °C 60 °C < boiling point ≤ 85 °C	3, 32 ^a (c)	3 + 6.1	C	2	2	3	50	95		2	no	T4 ³⁾	II B ⁴⁾	+	+	+	1	23
1992	FLAMMABLE LIQUID, TOXIC, N.O.S. (...) f.p. < 23 °C 85 °C < boiling point ≤ 115 °C	3, 19 ^a (b)	3 + 6.1	C	2	2		50	95		2	no	T4 ³⁾	II B ⁴⁾	+	+	+	2	
1992	FLAMMABLE LIQUID, TOXIC, N.O.S. (...) f.p. ≥ 23 °C 85 °C < boiling point ≤ 115 °C	3, 32 ^a (c)	3 + 6.1	C	2	2		50	95		2	no	T4 ³⁾	II B ⁴⁾	+	+	+	1	
1992	FLAMMABLE LIQUID, TOXIC, N.O.S. (...) f.p. < 23 °C boiling point > 115 °C	3, 19 ^a (b)	3 + 6.1	C	2	2		35	95		2	no	T4 ³⁾	II B ⁴⁾	+	+	+	2	
1992	FLAMMABLE LIQUID, TOXIC, N.O.S. (...) f.p. ≥ 23 °C boiling point > 115 °C	3, 32 ^a (c)	3 + 6.1	C	2	2		35	95		2	no	T4 ³⁾	II B ⁴⁾	+	+	+	1	

1	2	3	4	5	6	7	8	9	10	11	12	13	14	15	16	17	18	19	20
1993	FLAMMABLELIQUID, N.O.S. (...) f.p. < 23 °C vp50 > 175 kPa	3, 1° (a)	3	N	1	1			97		1	yes	T4 ³⁾	II B ⁴⁾	+	+	-	1	14
1993	FLAMMABLELIQUID, N.O.S. (...) f.p. < 23 °C vp50 > 175 kPa	3, 1° (a)	3	N	2	2	1	50	97		2	yes	T4 ³⁾	II B ⁴⁾	+	+	-	1	14
1993	FLAMMABLELIQUID, N.O.S. (...) f.p. < 23 °C 110 kPa < vp50 ≤ 175 kPa	3, 2° (a) 3, 2° (b)	3	N	2	2		50	97		3	yes	T4 ³⁾	II B ⁴⁾	+	+	-	1	14
1993	FLAMMABLELIQUID, N.O.S. (...) f.p. < 23 °C 110 kPa < vp50 ≤ 150 kPa	3, 2° (a) 3, 2° (b)	3	N	2	2	3	10	97		3	yes	T4 ³⁾	II B ⁴⁾	+	+	-	1	14
1993	FLAMMABLELIQUID, N.O.S. (...) f.p. < 23 °C vp50 ≤ 110 kPa	3, 3° (b)	3	N	2	2		10	97		3	yes	T4 ³⁾	II B ⁴⁾	+	+	-	1	14
1993	FLAMMABLELIQUID, N.O.S. (...) f.p. ≥ 23 °C	3, 31° (c)	3	N	3	2			97		3	yes	T4 ³⁾	II B ⁴⁾	+	+	-	1	14
1993	FLAMMABLELIQUID, N.O.S. (cyclohexanone/cyclohexanol mixture)	3, 31° (c)	3	N	3	2			97	0.95	3	yes	T3	II A	+	+	-	1	
1993	FLAMMABLELIQUID, N.O.S. (... with more than 10% benzēn) f.p. < 23 °C vp50 > 175 kPa	3, 1° (a)	3	C	1	1			95		1	yes	T4 ³⁾	II B ⁴⁾	16	18	-	1	
1993	FLAMMABLELIQUID, N.O.S. (... with more than 10% benzēn) f.p. < 23 °C 110 kPa < vp50 ≤ 175 kPa	3, 2° (a) 3, 2° (b)	3	C	1	1			95		1	yes	T4 ³⁾	II B ⁴⁾	+	+	-	1	
1993	FLAMMABLELIQUID, N.O.S. (... with more than 10% benzēn) f.p. < 23 °C vp50 ≤ 110 kPa boilingpoint ≤ 60 °C	3, 3° (b)	3	C	1	1			95		1	yes	T4 ³⁾	II B ⁴⁾	+	+	-	1	

1	2	3	4	5	6	7	8	9	10	11	12	13	14	15	16	17	18	19	20
1993	FLAMMABLELIQUID, N.O.S. (... with more than 10% benz�n) f.p. < 23 �C vp50 � 110 kPa 60 �C < boilingpoint � 85 �C	3, 3* (b)	3	C	2	2	3	50	95		2	yes	T4 ³⁾	II B ⁴⁾	+	+	–	1	23
1993	FLAMMABLELIQUID, N.O.S. (... with more than 10% benz�n) f.p. < 23 �C vp50 � 110 kPa 85 �C < boilingpoint � 115 �C	3, 3* (b)	3	C	2	2		50	95		2	yes	T4 ³⁾	II B ⁴⁾	0	0	–	1	
1993	FLAMMABLELIQUID, N.O.S. (... with more than 10% benz�n) f.p. < 23 �C vp50 � 110 kPa boiling point > 115 �C	3, 3* (b)	3	C	2	2		35	95		2	yes	T4 ³⁾	II B ⁴⁾	+	+	–	1	
1993	FLAMMABLELIQUID, N.O.S. (... with more than 10% benz�n) f.p. � 23 �C 60 �C < boilingpoint � 85 �C	3, 31* (c)	3	C	2	2	3	50	95		2	yes	T4 ³⁾	II B ⁴⁾	+	+	–	1	23
1993	FLAMMABLELIQUID, N.O.S. (... with more than 10% benz�n) f.p. � 23 �C 85 �C < boilingpoint � 115 �C	3, 31* (c)	3	C	2	2		50	95		2	yes	T4 ³⁾	II B ⁴⁾	+	+	–	1	
1993	FLAMMABLELIQUID, N.O.S. (... with more than 10% benz�n) f.p. � 23 �C boiling point > 115 �C	3, 31* (c)	3	C	2	2		35	95		2	yes	T4 ³⁾	II B ⁴⁾	+	+	–	1	
1999	TARS, LIQUID	3, 31* (c)	3	N	4	2	2		97		3	yes	T3	II A ⁷⁾	+	+	–	0	7
2021	CHLOROPHENOLS LIQUID (2–chlorophenol)	6.1, 17* (c)	6.1	C	2	2		25	95	1.23	2	no	T1	II A ⁷⁾	+	+	+	0	5; 6; +10 �C; 17
2022	CRESYLIC ACID	6.1, 27* (b)	6.1+8 +3	C	2	2		25	95	1.03	2	no	T2	II B ⁴⁾	+	+	+	2	5; 6; +16 �C; 17
2023	EPICHLORHYDRIN	6.1, 16* (b)	6.1+3	C	2	2		35	95	1.18	2	no	T2	II B	+	+	+	2	
2031	NITRIC ACID, other than red fuming, with not more than 70% acid	8, 2* (b)	8	N	2	3		10	97	1.41 (at 68% HNO ₃)	3	yes	–	–	–	–	–	0	

1	2	3	4	5	6	7	8	9	10	11	12	13	14	15	16	17	18	19	20
2031	NITRIC ACID, other than red fuming, with more than 70% acid	8, 2° (a)1.	8	N	2	3		10	97	1.51 ⁽¹⁾ (at 100% HNO ₃)	3	yes	—	—	—	—	—	2	
2032	NITRIC ACID, RED FUMING	8, 2° (a)2.	8 + 5.1 + 6.1	C	2	2		50	95	1.51	1	no	—	—	—	—	+	2	
2045	ISO BUTYRALDEHYDE	3, 3° (b)	3	C	2	2	3	50	95	0.79	2	yes	T4	II A ⁷⁾	+	+	—	1	23
2046	CYMENES	3, 31° (c)	3	N	3	2			97	0.88	3	yes	T2	II A	+	+	—	1	
2047	DICHLOROPROPENES (2,3-dichloroprop-1-ene)	3, 3° (b)	3	C	2	2		45	95	1.20	2	yes	T1	II A	+	+	—	1	
2047	DICHLOROPROPENES (mixtures of 2,3-dichloroprop-1-ene and 1,3-dichloroprop-1-ene)	3, 3° (b) 3, 31° (c)	3	C	2	2		45	95	1.23	2	yes	T2 ¹⁾	II A	+	+	—	1	
2047	DICHLOROPROPENES (1,3-dichloroprop-1-ene)	3, 31° (c)	3	C	2	2		40	95	1.23	2	yes	T2 ¹⁾	II A ⁷⁾	+	+	—	1	
2048	DICYCLOPENTADIENE	3, 31° (c)	3	N	3	2	2			0.94	3	yes	T1	II B ⁴⁾	+	+	—	1	5; 7; 17
2050	DIISOBUTYLENE, ISOMERIC COMPOUNDS	3, 3° (b)	3	N	2	2		10	97	0.72	3	yes	T3 ²⁾	II A ⁷⁾	+	+	—	1	
2051	2-DIMETHYLAMINOETHANOL	8, 54° (b)	8 + 3	N	3	2			97	0.89	3	yes	T3	II A	+	+	—	1	
2053	METHYL ISOBUTYL CARBINOL	3, 31° (c)	3	N	3	2			97	0.81	3	yes	T4 ³⁾	II B ⁴⁾	+	+	—	1	
2054	MORPHOLINE	3, 31° (c)	3	N	3	2			97	1.00	3	yes	T3	II A	+	+	—	1	5
2055	STYRENE MONOMER, STABILIZED (vinylbenzene monomer, stabilized)	3, 31° (c)	3 + unst.	N	3	2			97	0.91	3	yes	T1	II A	+	+	—	1	3; 16
2056	TETRAHYDROFURAN	3, 3° (b)	3	N	2	2		10	97	0.89	3	yes	T3	II B	+	+	—	1	
2057	TRIPROPYLENE (propylene trimer)	3, 31° (c)	3	N	3	2			97	0.73	3	yes	T3	II B ⁴⁾	+	+	—	1	
2074	ACRYLAMIDE, AQUEOUS SOLUTION	6.1, 12° (c)	6.1	C	2	2		30	95	1.03	2	no	—	—	—	—	+	0	3; 15; 16
2076	CRESOLS	6.1, 27° (b)	6.1 + 8	C	2	2	2	25	95	1.03-1.05	2	no	T1	II A ⁸⁾	+	+	+	2	5; 7; 17
2078	TOLUENE DIISOCYANATE and isomeric mixtures (2,4-toluene diisocyanate)	6.1, 19° (b)	6.1	C	2	2	2	25	95	1.22	2	no	T1	II B ⁴⁾	+	+	+	2	2; 5; 7; 8; 17
2079	DIETHYLENTRIAMINE	8, 53° (b)	8	N	4	2			97	0.96	3	yes	—	—	—	—	—	1	

1	2	3	4	5	6	7	8	9	10	11	12	13	14	15	16	17	18	19	20
2205	ADIPO NITRILE	6.1, 12° (c)	6.1	C	2	2		25	95	0.96	2	no	T4 ³⁾	II B ⁴⁾	+	+	+	0	5; 6: +6 °C; 17
2206	ISOCYANATES, TOXIC, N.O.S. (4-chlorophenyl isocyanate)	6.1, 19° (b)	6.1	C	2	2	2	25	95	1.25	2	no	-	-	-	-	+	2	5; 7; 17
2209	FORMALDEHYDE SOLUTION with at least 25 % formaldehyde	8, 63° (c)	8	N	4	2			97	1.09	3	yes	-	-	-	-	-	0	15
2215	MALEIC ANHYDRIDE	8, 31° (c)	8	N	3	3	2			0.93	3	yes	T2	II B ⁴⁾	+	+	-	0	5; 7; 17
2218	ACRYLIC ACID, STABILIZED	8, 32° (b)2.	8 + 3 + unst.	C	2	2		30	95	1.05	1	yes	T2	II A ⁷⁾	+	+	-	1	3; 4; 5; 6: +17 °C; 17
2227	n-BUTYL METHACRYLATE, STABILIZED	3, 31° (c)	3 + unst.	C	2	2		50	95	0.90	1	yes	T3	IIA	+	+	-	1	3
2238	CHLOROTOLUENES (m-chlorotoluene)	3, 31° (c)	3	C	2	2		30	95	1.08	2	yes	T1	II A ⁷⁾	+	+	-	1	
2238	CHLOROTOLUENES (o-chlorotoluene)	3, 31° (c)	3	C	2	2		30	95	1.08	2	yes	T1	II A ⁷⁾	+	+	-	1	
2238	CHLOROTOLUENES (p-chlorotoluene)	3, 31° (c)	3	C	2	2		30	95	1.07	2	yes	T1	II A ⁷⁾	+	+	-	1	5; 6: +11 °C; 17
2239	CHLOROTOLUIDINES	6.1, 17° (c)	6.1	C	2	2		25	95	1.15	2	no	T1	II A ⁷⁾	+	+	+	0	5; 6: +6 °C; 17
2241	CYCLOHEPTANE	3, 3° (b)	3	N	2	2		10	97	0.81	3	yes	T4 ³⁾	II A	+	+	-	1	
2247	n-DECANE	3, 31° (c)	3	N	3	2			97	0.73	3	yes	T3	II A	+	+	-	1	
2248	DI-n-BUTYLAMINE	8, 54° (b)	8 + 3	N	3	2			97	0.76	3	yes	T3	II A ⁷⁾	+	+	-	1	
2259	TRIEthylenetetramine	8, 53° (b)	8	N	3	2			97	0.98	3	yes	T2	II B ⁴⁾	+	+	-	1	5; 6: +16 °C; 17
2263	DIMETHYLCYCLOHEXANES (cis-1,4-dimethylcyclohexane)	3, 3° (b)	3	C	2	2		35	95	0.78	2	yes	T4 ³⁾	II A ⁷⁾	+	+	-	1	
2263	DIMETHYLCYCLOHEXANES (trans-1,4-dimethylcyclohexane)	3, 3° (b)	3	C	2	2		35	95	0.76	2	yes	T4 ³⁾	II A ⁷⁾	+	+	-	1	
2264	N,N-DIMETHYLCYCLO- HEXYLAMINE	8, 54° (b)	8 + 3	N	3	2			97	0.85	3	yes	T3	II B ⁴⁾	+	+	-	1	
2265	N,N-DIMETHYLFORMAMIDE	3, 31° (c)	3	N	3	2			97	0.95	3	yes	T2	II A	+	+	-	1	
2266	N,N-DIMETHYLPROPYLAMINE	3, 22° (b)	3 + 8	C	2	2	3	50	95	0.72	2	yes	T4	II A	+	+	-	1	23

1	2	3	4	5	6	7	8	9	10	11	12	13	14	15	16	17	18	19	20
2276	ETHYL-2 HEXYLAMINE	3, 33° (c)	3 + 8	N	3	2			97	0.79	3	yes	T3	II A ⁷⁾	+	+	-	1	
2278	n-HEPTENE	3, 3° (b)	3	N	2	2		10	97	0.70	3	yes	T3	II B ⁴⁾	+	+	-	1	
2280	HEXAMETHYLENEDIAMINE, molten	8, 52° (c)	8	N	3	3	2		95	0.83	3	yes	T3	II B ⁴⁾	+	+	-	0	5; 7; 17
2282	HEXANOLS	3, 31° (c)	3	N	3	2			97	0.83	3	yes	T3	II A	+	+	-	1	
2286	PENTAMETHYLHEPTANE (isododecane)	3, 31° (c)	3	N	3	2			97	0.75	3	yes	T2	II A ⁷⁾	+	+	-	1	
2289	ISOPHORONEDIAMINE	8, 53° (c)	8	N	3	2			97	0.92	3	yes	T2	II A	+	+	-	0	5; 6; +14 °C; 17
2303	ISOPROPENYLBENZENE	3, 31° (c)	3	N	3	2			97	0.91	3	yes	T2	II B	+	+	-	1	16
2309	OCTADIENE (1,7 octadiene)	3, 3° (b)	3	N	2	2		10	97	0.75	3	yes	T3	II B ⁴⁾	+	+	-	1	
2311	PHENETIDINES	6.1, 12° (c)	6.1	C	2	2		25	95	1.07	2	no	-	-	-	-	+	0	6; +7 °C; 17
2312	PHENOL, MOLTEN	6.1, 24° (b)1.	6.1	C	2	2	2	25	95	1.07	2	no	T1	II A ⁸⁾	+	+	+	2	5; 7; 17
2320	TETRAETHYLENEPENTAMINE	8, 53° (c)	8	N	4	2			97	1.00	3	yes	-	-	-	-	-	0	
2321	TRICHLOROBENZENES, LIQUID (1,2,4-trichlorobenzene)	6.1, 15° (c)	6.1	C	2	2	2	25	95	1.45	2	no	T1	II A	-	-	+	0	5; 7; 17
2323	TRIETHYL PHOSPHITE	3, 31° (c)	3	N	3	2			97	0.80	3	yes	T3	II B ⁴⁾	+	+	-	1	
2324	TRISOBUTYLENE	3, 31° (c)	3	N	3	2			97	0.76	3	yes	T2	II B ⁴⁾	+	+	-	1	
2325	1,3,5 TRIMETHYLBENZENE	3, 31° (c)	3	N	3	2			97	0.87	3	yes	T1	II A	+	+	-	1	
2333	ALLYL ACETATE	3, 17° (b)	3 + 6.1	C	2	2		35	95	0.93	2	no	T2	II A ⁷⁾	+	+	+	1	
2348	BUTYL ACRYLATES, STABILIZED (n-butylacrylate, stabilized)	3, 31° (c)	3 + unst.	C	2	2		30	95	0.90	1	yes	T3	II B	+	+	-	1	3
2350	BUTYL METHYLETHER	3, 3° (b)	3	N	2	2		10	97	0.74	3	yes	T4 ³⁾	II B ⁴⁾	+	+	-	1	
2356	2-CHLOROPROPANE	3, 2° (a)	3	C	2	2	3	50	95	0.86	2	yes	T1	II A	+	+	-	1	23
2357	CYCLOHEXYLAMINE	8, 54° (b)	8 + 3	N	3	2			97	0.86	3	yes	T3	II A ⁸⁾	+	+	-	1	
2362	1,1 DICHLOROETHANE	3, 3° (b)	3	C	2	2	3	50	95	1.17	2	yes	T2	II A	+	+	-	1	23
2370	1-HEXENE	3, 3° (b)	3	N	2	2		10	97	0.67	3	yes	T3	II B ⁴⁾	+	+	-	1	

1	2	3	4	5	6	7	8	9	10	11	12	13	14	15	16	17	18	19	20
2382	DIMETHYLHYDRAZINE SYMETRICAL	6.1, 7° (a)2.	6.1 + 3	C	2	2		50	95	0.83	1	no	T4 ³⁾	II B ⁴⁾	+	+	+	2	5
2383	DIPROPYLAMINE	3, 22° (b)	3 + 8 + 6.1	C	2	2	3	50	95	0.74	2	no	T4 ⁴⁾	II B ²⁾	+	+	+	1	23
2397	3-METHYLBUTAN-2-ONE	3, 3° (b)	3	N	2	2		10	97	0.81	3	yes	T1	II A	+	+	-	1	
2398	METHYLtert-BUTYLEETHER	3, 3° (b)	3	N	2	2		10	97	0.74	3	yes	T1	II A	+	+	-	1	
2404	PRO PIONITRILE	3, 11° (b)	3 + 6.1	C	2	2		45	95	0.78	2	no	T1 ⁹⁾	II B ⁹⁾	+	+	+	2	
2414	THIOPHENE	3, 3° (b)	3	N	2	2		10	97	1.06	3	yes	T2	II A	+	+	-	1	
2430	ALKYLPHENOLS SOLID, N.O.S. (non ylphenol, isomeric mixture, molten)	8, 39° (b)	8	N	3	3	2		95	0.95		yes	T2	II A ⁷⁾	+	+	-	0	5; 7; 17
2432	N,N-DIETHYLANILINE	6.1, 12° (c)	6.1	C	2	2		25	95	0.93	2	no	-	-	-	-	+	0	
2448	SULPHUR, MOLTEN	4.1, 15°	4.1	N	4	1	2		95	2.07	3	yes	-	-	-	-	+ ²⁾	0	7; ²⁾ Toximeter for H ₂ S, 20: +150°C
2458	HEXADIENE	3, 3° (b)	3	N	2	2		10	97	0.72	3	yes	T4 ³⁾	II B ⁴⁾	+	+	-	1	
2477	METHYL ISOTHIOCYANATE	6.1, 20° (a)	6.1 + 3	C	2	2	2	35	95	1.07 ¹¹⁾	2	no	T4 ³⁾	II B ³⁾	+	+	+	2	5; 7; 17
2485	n-BUTYL ISOCYANATE	6.1, 6° (a)	6.1 + 3	C	2	2		35	95	0.89	1	no	T2	II B ³⁾	+	+	+	2	
2486	ISO BUTYL ISOCYANATE	3, 14° (b)	3 + 6.1	C	2	2		40	95		2	no	T4 ³⁾	II B ⁴⁾	+	+	+	2	
2487	PHENYL ISOCYANATE	6.1, 18° (a)	6.1 + 3	C	2	2		25	95	1.10		no	T1	II B ³⁾	+	+	+	2	
2490	DICHLOROISOPROPYL ETHER	6.1, 17° (b)	6.1	C	2	2		25	95	1.11		no	-	-	-	-	+	2	
2491	ETHANOLAMINE or ETHANOLAMINE SOLUTION	8, 53° (c)	8	N	3	2			97	1.02	3	yes	T4 ³⁾	II A ⁸⁾	+	+	-	0	5; 6; +14 °C; 17
2493	HEXAMETHYLENEIMINE	3, 23° (b)	3 + 8	N	3	2			97	0.88	3	yes	T3 ²⁾	II B ⁴⁾	+	+	-	1	
2496	PROPIONIC ANHYDRIDE	8, 32° (c)	8	N	4	3			97	1.02	3	yes	-	-	-	-	-	0	
2518	1,5,9-CYCLODODECATRIENE	6.1, 25° (c)	6.1	C	2	2		25	95	0.9	2	no	-	-	-	-	+	0	
2527	ISO BUTYL ACRYLATE, STABILIZED	3, 31° (c)	3 + unst.	C	2	2		30	95	0.89	1	yes	T2	II B ⁹⁾	+	+	-	1	3
2528	ISOBUTYL ISOBUTYRATE	3, 31° (c)	3	N	3	2			97	0.86	3	yes	T2	II B ⁴⁾	+	+	-	1	
2531	METHACRYLIC ACID, STABILIZED	8, 32° (c)	8 + unst.	C	2	2	2	25	95	1.02	1	yes	T2	II B ⁴⁾	+	+	-	0	3; 4; 5; 7; 17

1	2	3	4	5	6	7	8	9	10	11	12	13	14	15	16	17	18	19	20
2564	TRICHLOROACETIC ACID SOLUTION	8, 32° (b)1.	8	N	3	3	2			1.62 ⁽¹¹⁾	3	yes	T4 ⁽³⁾	II A ⁽⁷⁾	+	+	-	1	5; 7; 17; 22
2564	TRICHLOROACETIC ACID SOLUTION	8, 32° (c)	8	N	4	3			97	1.62 ⁽¹¹⁾	3	yes	T4 ⁽³⁾	II A ⁽⁷⁾	+	+	-	1	22
2574	TRICRESYL PHOSPHATE with more than 3% ortho isomer	6.1, 23° (b)	6.1	C	2	2		25	95	1.18	2	no	-	-	-	-	+	2	
2579	PIPERAZINE, molten (diethylenediamine)	8, 52° (c)	8 + 3	N	3	3	2		95	0.90	3	yes	T2	II B ⁽²⁾	+	+	-	1	7; 17
2586	ALKYLSULFONIC ACIDS, LIQUID with not more than 5% free sulphuric acid	8, 34° (c)	8	N	4	3			97		3	yes	-	-	-	-	-	0	
2608	NITROPROPANES	3, 31° (c)	3	N	3	2			97	1.00	3	yes	T2	II B ⁽⁷⁾	+	+	-	1	
2615	ETHYLPROPYLETHER	3, 3° (b)	3	N	2	2		10	97	0.73	3	yes	T4 ⁽³⁾	II B ⁽⁴⁾	+	+	-	1	
2651	4,4'-DIAMINODIPHENYL-METHANE	6.1, 12° (c)	6.1	C	2	2	2	25	95	1.00	2	no	-	-	-	-	+	0	5; 7; 17
2672	AMMONIA SOLUTION (relative density between 0.880 and 0.957 at 15 °C in water, with more than 10% but not more than 35% ammonia)	8, 43° (c)	8	N	2	2		10	97	0.88 ⁽¹⁰⁾ - 0.96 ⁽¹⁰⁾	3	yes	-	-	-	-	-	0	
2683	AMMONIUM SULPHIDE SOLUTION	8, 45° (b)2.	8 + 6.1 + 3	C	2	2		50	95		2	no	T4 ⁽³⁾	II B ⁽⁴⁾	+	+	+	0	15; 16
2693	BISULPHITES, AQUEOUS SOLUTION, N.O.S. (...)	8, 17° (c)	8	N	4	3			97		3	yes	-	-	-	-	-	0	
2709	BUTYLBENZENES	3, 31° (c)	3	N	3	2			97	0.87	3	yes	T2	II A	+	+	-	1	
2733	AMINES, FLAMMABLE, CORROSIVE, N.O.S. (2-aminobutane)	3, 22° (b)	3 + 8	C	2	2	3	50	95	0.72	2	yes	T4 ⁽³⁾	II A	+	+	-	1	23
2735	AMINES, LIQUID, CORROSIVE, N.O.S. or POLYAMINES, LIQUID, CORROSIVE, N.O.S. (...)	8, 53° (a)	8	N	4	2			97		3	yes	-	-	-	-	-	2	
2735	AMINES, LIQUID, CORROSIVE, N.O.S. or POLYAMINES, LIQUID, CORROSIVE, N.O.S. (...)	8, 53° (b)	8	N	4	2			97		3	yes	-	-	-	-	-	1	

1	2	3	4	5	6	7	8	9	10	11	12	13	14	15	16	17	18	19	20
2735	AMINES, LIQUID, CORROSIVE, N.O.S. or POLYAMINES, LIQUID, CORROSIVE, N.O.S. (...)	8, 53° (c)	8	N	4	2			97		3	yes	-	-	-	-	-	0	
2754	N-ETHYLTOLUIDINES (N-ethyl-o-toluidine) (N-ethyl-m-toluidine)	6.1, 12° (b)	6.1	C	2	2		25	95	0.94	2	no	-	-	-	-	+	2	
2754	N-ETHYLTOLUIDINES, (N-ethyl-o-toluidine and N-ethyl-m-toluidine mixtures)	6.1, 12° (b)	6.1	C	2	2		25	95	0.94	2	no	-	-	-	-	+	2	
2754	N-ETHYLTOLUIDINES (N-ethyl-p-toluidine)	6.1, 12° (b)	6.1	C	2	2	2	25	95	0.94	2	no	-	-	-	-	+	2	7; 17
2789	ACETIC ACID, GLACIAL	8, 32° (b)2.	8 + 3	N	2	3	2	10		1.05 (with 100% acid)	3	yes	T1	II A	+	+	-	1	5; 7; 17
2789	ACETIC ACID SOLUTION, more than 80% acid, by mass	8, 32° (b)2.	8 + 3	N	2	3	2	10		1.05 (with 100% acid)	3	yes	T1	II A	+	+	-	1	5; 7; 17
2790	ACETIC ACID SOLUTION, more than 25% but not more than 80% acid, by mass	8, 32° (b)1. 8, 32° (c)	8	N	2	3		10	97		3	yes	-	-	-	-	-	0	
2796	BATTERY FLUID, ACID	8, 1° (b)	8	N	4	3			97	1.00-1.84	3	yes	-	-	-	-	-	0	8; 22
2796	SULPHURIC ACID with not more than 51% acid	8, 1° (b)	8	N	4	3			97	1.00-1.41	3	yes	-	-	-	-	-	0	8; 22
2797	BATTERY FLUID, ALKALI	8, 42° (b)	8	N	4	2			97	1.00-2.13	3	yes	-	-	-	-	-	0	22
2810	TOXIC LIQUID, ORGANIC, N.O.S. (...) boilingpoint ≤ 60 °C	6.1, 25° (a) 6.1, 25° (b)	6.1	C	1	1			95		1	no	-	-	-	-	+	2	
2810	TOXIC LIQUID, ORGANIC, N.O.S. (...) boilingpoint ≤ 60 °C	6.1, 25° (c)	6.1	C	1	1			95		1	no	-	-	-	-	+	0	
2810	TOXIC LIQUID, ORGANIC, N.O.S. (...) 60 °C < boilingpoint ≤ 85 °C	6.1, 25° (a)	6.1	C	2	2	3	50	95		1	no	-	-	-	-	+	2	23

1	2	3	4	5	6	7	8	9	10	11	12	13	14	15	16	17	18	19	20
2810	TOXIC LIQUID,ORGANIC, N.O.S. (...) 60 °C < boilingpoint ≤ 85 °C	6.1, 25° (b)	6.1	C	2	2	3	50	95		2	no	-	-	-	-	+	2	23
2810	TOXIC LIQUID ORGANIC, N.O.S. (...) 60 °C < boilingpoint ≤ 85 °C	6.1, 25° (c)	6.1	C	2	2	3	50	95		2	no	-	-	-	-	+	0	23
2810	TOXIC LIQUID ORGANIC, N.O.S. (...) 85 °C < boilingpoint ≤ 115 °C	6.1, 25° (a)	6.1	C	2	2		50	95		1	no	-	-	-	-	+	2	
2810	TOXIC LIQUID ORGANIC, N.O.S. (...) 85 °C < boilingpoint ≤ 115 °C	6.1, 25° (b)	6.1	C	2	2		50	95		2	no	-	-	-	-	+	2	
2810	TOXIC LIQUID ORGANIC, N.O.S. (...) 85 °C < boilingpoint ≤ 115 °C	6.1, 25° (c)	6.1	C	2	2		50	95		2	no	-	-	-	-	+	0	
2810	TOXIC LIQUID ORGANIC, N.O.S. (...) boiling point > 115 °C	6.1, 25° (a)	6.1	C	2	2		35	95		1	no	-	-	-	-	+	2	
2810	TOXIC LIQUID ORGANIC, N.O.S. (...) boiling point > 115 °C	6.1, 25° (b)	6.1	C	2	2		35	95		2	no	-	-	-	-	+	2	
2810	TOXIC LIQUID ORGANIC, N.O.S. (...) boiling point > 115 °C	6.1, 25° (c)	6.1	C	2	2		35	95		2	no	-	-	-	-	2	0	
2811	TOXIC SOLID,ORGANIC, N.O.S. (1,2,3-trichlorobenzene, molten)	6.1, 25° (c)	6.1	C	2	2	2	25	95		2	no	T4 ^{2/}	II B ^{2/}	+	+	+	0	5; 7; 17; 22
2811	TOXIC SOLID,ORGANIC, N.O.S. (1,3,5-trichlorobenzene, molten)	6.1, 25° (c)	6.1	C	2	2	2	25	95		2	no	T4 ^{2/}	II B ^{2/}	+	+	+	0	5; 7; 17; 22
2815	N-AMINOETHYLPIPERAZINE	8, 53° (e)	8	N	4	2			97	0.98	3	yes	-	-	-	-	-	0	
2820	BUTYRIC ACID	8, 32° (c)	8	N	2	3		10	97	0.96	3	yes	-	-	-	-	-	0	
2829	CAPROIC ACID	8, 32° (c)	8	N	4	3			97	0.92	3	yes	-	-	-	-	-	0	
2831	1,1,1-TRICHLOROETHANE	6.1, 15° (c)	6.1	C	2	2	3	50	95	1.34	2	no	-	-	-	-	+	0	23
2850	TETRAPROPYLENE (PROPYLENE TETRAMER)	3, 31° (c)	3	N	4	2			97	0.76	3	yes	-	-	-	-	-	0	
2874	FURFURYL ALCOHOL	6.1, 14° (c)	6.1	C	2	2		25	95	1.13	2	no	-	-	-	-	+	0	

1	2	3	4	5	6	7	8	9	10	11	12	13	14	15	16	17	18	19	20
2920	CORROSIVE LIQUID, FLAMMABLE, N.O.S. (aqueous solution of hexadecyltrimethylammonium chloride (50%) and ethanol (35%))	8, 68° (b)	8 + 3	N	2	3		10	97	0.9	3	yes	T2	IIB	+	+	-	1	
2920	CORROSIVE LIQUID, FLAMMABLE, N.O.S. (2-propanol and didecyltrimethylammonium chloride, aqueous solution)	8, 68° (b)	8 + 3	N	3	3			97	0.95	3	yes	T3	II A	+	+	-	1	
2922	CORROSIVE LIQUID, N.O.S. (...) boilingpoint ≤ 60 °C	8, 76° (a)	8 + 6.1	C	1	1			95		1	no	-	-	-	-	+	2	
2922	TOXIC LIQUID CORROSIVE, N.O.S. (...) boilingpoint ≤ 60 °C	8, 76° (b) 8, 76° (c)	8 + 6.1	C	1	1			95		1	no	-	-	-	-	+	0	
2922	TOXIC LIQUID CORROSIVE, N.O.S. (...) 60 °C < boilingpoint ≤ 85 °C	8, 76° (a)	8 + 6.1	C	2	2	3	50	95		1	no	-	-	-	-	+	2	23
2922	TOXIC LIQUID CORROSIVE, N.O.S. (...) 60 °C < boilingpoint ≤ 85 °C	8, 76° (b) 8, 76° (c)	8 + 6.1	C	2	2	3	50	95		2	no	-	-	-	-	+	0	23
2922	TOXIC LIQUID CORROSIVE, N.O.S. (...) 85 °C < boilingpoint ≤ 115 °C	8, 76° (a)	8 + 6.1	C	2	2		50	95		1	no	-	-	-	-	+	2	
2922	TOXIC LIQUID CORROSIVE, N.O.S. (...) 85 °C < boilingpoint ≤ 115 °C	8, 76° (b) 8, 76° (c)	8 + 6.1	C	2	2		50	95		2	no	-	-	-	-	+	0	
2922	TOXIC LIQUID CORROSIVE, N.O.S. (...) boiling point > 115 °C	8, 76° (a)	8 + 6.1	C	2	2		35	95		1	no	-	-	-	-	+	2	
2922	TOXIC LIQUID CORROSIVE, N.O.S. (...) boiling point > 115 °C	8, 76° (b) 8, 76° (c)	8 + 6.1	C	2	2		35	95		2	no	-	-	-	-	+	0	
2924	FLAMMABLE LIQUID, CORROSIVE, N.O.S. boilingpoint ≤ 60 °C	3, 26° (a)	3 + 8	C	1	1			95		1	yes	T4 ³	II B ¹⁷	+	+	-	2	

1	2	3	4	5	6	7	8	9	10	11	12	13	14	15	16	17	18	19	20
2924	FLAMMABLE LIQUID, CORROSIVE, N.O.S. (aqueous solution of dialkyl- dimethylammonium chloride (C ₈ - C ₁₈) and 2-propanol)	3, 26° (b)	3 + 8	C	2	2		50	95	0.88	2	yes	T2	II A	+	+	-	1	
2924	FLAMMABLE, LIQUID, CORROSIVE, N.O.S. (...) 60 °C < boilingpoint ≤ 85 °C	3, 26° (b) 3, 33° (c)	3 + 8	C	1	1			95		1	yes	T4 ^{3/}	II B ^{4/}	+	+	-	1	
2924	FLAMMABLE LIQUID, CORROSIVE, N.O.S. (...) 60 °C < boilingpoint ≤ 85 °C	3, 26° (b) 3, 33° (c)	3 + 8	C	2	2	3	50	95		2	yes	T4 ^{3/}	II B ^{4/}	+	+	-	1	23
2924	FLAMMABLE LIQUID, CORROSIVE, N.O.S. (...) 85 °C < boilingpoint ≤ 115 °C	3, 26° (b) 3, 33° (c)	3 + 8	C	2	2		50	95		2	yes	T4 ^{3/}	II B ^{4/}	+	+	-	1	
2924	FLAMMABLE LIQUID, CORROSIVE, N.O.S. (...) boiling point > 115 °C	3, 26° (b) 3, 33° (c)	3 + 8	C	2	2		35	95		2	yes	T4 ^{2/}	II B ^{4/}	+	+	-	1	
2927	TOXIC LIQUID CORROSIVE, ORGANIC, N.O.S. (...) boilingpoint ≤ 60 °C	6.1, 27° (a) 6.1, 27° (b)	6.1 + 8	C	1	1			95		1	no	-	-	-	-	+	2	
2927	TOXIC LIQUID CORROSIVE, ORGANIC, N.O.S. (...) 60 °C < boilingpoint ≤ 85 °C	6.1, 27° (a)	6.1 + 8	C	2	2	3	50	95		1	no	-	-	-	-	+	2	23
2927	TOXIC LIQUID CORROSIVE ORGANIC, N.O.S. (...) 60 °C < boilingpoint ≤ 85 °C	6.1, 27° (b)	6.1 + 8	C	2	2	3	50	95		2	no	-	-	-	-	+	2	23
2927	TOXIC LIQUID CORROSIVE, ORGANIC, N.O.S. (...) 85 °C < boilingpoint ≤ 115 °C	6.1, 27° (a)	6.1 + 8	C	2	2		50	95		1	no	-	-	-	-	+	2	
2927	TOXIC LIQUID CORROSIVE, ORGANIC, N.O.S. (...) 85 °C < boilingpoint ≤ 115 °C	6.1, 27° (b)	6.1 + 8	C	2	2		50	95		2	no	-	-	-	-	+	2	
2927	TOXIC LIQUID CORROSIVE, ORGANIC, N.O.S. (...) boiling point > 115 °C	6.1, 27° (a)	6.1 + 8	C	2	2		35	95		1	no	-	-	-	-	+	2	
2927	TOXIC LIQUID CORROSIVE, ORGANIC, N.O.S. (...) boiling point > 115 °C	6.1, 27° (b)	6.1 + 8	C	2	2		35	95		2	no	-	-	-	-	+	2	

1	2	3	4	5	6	7	8	9	10	11	12	13	14	15	16	17	18	19	20
2929	TOXIC LIQUID, FLAMMABLE, ORGANIC, N.O.S. (...)	6.1, 9° (a)	6.1+3	C	1	1			95		1	no	T4 ²	II B ²	+	+	+	2	
2929	TOXIC LIQUID, FLAMMABLE N.O.S. (...) boilingpoint ≤ 60 °C	6.1, 26° (a)1. 26° (b)1.	6.1+3	C	1	1			95		1	no	T4 ²	II B ²	+	+	+	2	
2929	TOXIC LIQUID, FLAMMABLE, ORGANIC, N.O.S. (...) 60 °C < boilingpoint ≤ 85 °C	6.1, 26° (a)1.	6.1+3	C	2	2	3	50	95		1	no	T4 ²	II B ²	+	+	+	2	23
2929	TOXIC LIQUID, FLAMMABLE, ORGANIC, N.O.S. (...) 60 °C < boilingpoint ≤ 85 °C	6.1, 26° (b)1.	6.1+3	C	2	2	3	50	95		2	no	T4 ²	II B ²	+	+	+	2	23
2929	TOXIC LIQUID, FLAMMABLE, ORGANIC, N.O.S. (...) 85 °C < boilingpoint ≤ 115 °C	6.1, 26° (a)1.	6.1+3	C	2	2		50	95		1	no	T4 ²	II B ²	+	+	+	2	
2929	TOXIC LIQUID, FLAMMABLE, ORGANIC, N.O.S. (...) 85 °C < boilingpoint ≤ 115 °C	6.1, 26° (b)1.	6.1+3	C	2	2		50	95		2	no	T4 ²	II B ²	+	+	+	2	
2929	TOXIC LIQUID, FLAMMABLE, ORGANIC, N.O.S. (...) boiling point > 115 °C	6.1, 26° (a)1.	6.1+3	C	2	2		35	95		1	no	T4 ²	II B ²	+	+	+	2	
2929	TOXIC LIQUID, FLAMMABLE, ORGANIC, N.O.S. (...) boiling point > 115 °C	6.1, 26° (b)1.	6.1+3	C	2	2		35	95		2	no	T4 ²	II B ²	+	+	+	2	
2935	ETHYL-2-CHLOROPROPIONATE	3, 31° (c)	3	C	2	2		30	95	1.08	2	yes	T4 ³	II A	+	+	-	1	
2947	ISOPROPYLCHLOROACETATE	3, 31° (c)	3	C	2	2		40	95	1.09	2	yes	T4 ³	II A	+	+	-	1	
2983	ETHYLENE OXIDE AND PROPYLENE MIXTURE, with not more than 30 % ethylene oxide	3, 17° (a)	3+6.1 + unst.	C	1	1	3		95	0.85	1	no	T2	II B	+	+	-	1	2; 3; 12
3077	ENVIRONMENTALLY HAZARDOUS SUBSTANCE, SOLID, N.O.S., molten, (alkyl-amine (C ₁₂ to C ₁₈))	9, 12° (c)	9	N	4	3	2		95	0.79	3	yes	-	-	-	-	-	0	7; 17
3079	METHACRYLONITRILE, STABILIZED	3, 11° (a)	3+6.1 + unst.	C	2	2		45	95	0.80	1	no	T1	II B ³	+	+	+	2	3
3082	ENVIRONMENTALLY HAZARDOUS SUBSTANCE, LIQUID, N.O.S. (...)	9, 11° (c)		N	4	3			97	...	3	yes	-	-	-	-	-	0	22

1	2	3	4	5	6	7	8	9	10	11	12	13	14	15	16	17	18	19	20
3082	ENVIRONMENTALLY HAZARDOUS SUBSTANCE, LIQUID, N.O.S. (bilge water)	9, 11° (c)		N	4	2			97	...		yes	-	-	-	-	-	0	
3092	1-METHOXY-2-PROPANOL	3, 31° (c)	3	N	3	2			97	0.92	3	yes	T3	II B	+	+	-	1	
3145	ALKYLPHENOLS, LIQUID, N.O.S. (no nylphenols isomers mixture)	8, 40° (b) 8, 40° (c)	8	N	4	3			97	0.95	3	yes	-	-	-	-	-	0	
3175	SOLIDS CONTAINING FLAMMABLE LIQUID, N.O.S., molten (2-propanol and dialkyl (C ₁₂ to C ₁₈) dimethylammonium chloride)	4.1, 4° (c)	4.1	N	3	3	2		95	0.86	3	yes	T2	II A	+	+	-	0	7; 17
3256	ELEVATED TEMPERATURE, LIQUID, FLAMMABLE, N.O.S. (...)	3, 61° (c)	3	N	3	2	2		95		3	yes	T4 ³⁾	II B ⁴⁾	+	+	-	1	7
3257	ELEVATED TEMPERATURE LIQUID, N.O.S. (...)	9, 20° (c)		N	4	1	2		95		3	yes	-	-	-	-	-	0	7; 20; +200°C; 22; 24
3257	ELEVATED TEMPERATURE LIQUID, N.O.S. (...)	9, 20° (c)		N	4	1	2		95		3	yes	-	-	-	-	-	0	7; 20; +115°C; 22; 24; 25
3259	AMINES, SOLID, CORROSIVE, N.O.S. molten (monoalkyl (C ₁₂ to C ₁₈) amine acetate)	8, 52° (c)	8	N	4	3	2		95	0.87	3	yes	-	-	-	-	-	0	7; 17
3264	CORROSIVE LIQUID, ACIDIC, INORGANIC, N.O.S.	8, 17° (a)	8	N	2	3		10	97		3	yes	-	-	-	-	-	2	
3264	CORROSIVE LIQUID, ACIDIC, INORGANIC, N.O.S. (...)	8, 17° (b)	8	N	2	3		10	97		3	yes	-	-	-	-	-	0	
3264	CORROSIVE LIQUID, ACIDIC, INORGANIC, N.O.S.	8, 17° (c)	8	N	4	3			97		3	yes	-	-	-	-	-	0	
3264	CORROSIVE LIQUID, ACIDIC, INORGANIC, N.O.S. (aqueous solution of phosphoric acid and nitric acid)	8, 17° (a)	8	N	2	3		10	97		3	yes	-	-	-	-	-	2	
3264	CORROSIVE LIQUID, ACIDIC, INORGANIC, N.O.S. (aqueous solution of phosphoric acid and nitric acid)	8, 17° (b) 8, 17° (c)	8	N	4	3			97		3	yes	-	-	-	-	-	0	

1	2	3	4	5	6	7	8	9	10	11	12	13	14	15	16	17	18	19	20
3265	CORROSIVELIQUID, ACIDIC, ORGANIC, N.O.S. (...)	8, 40° (a)	8	N	2	3		10	97		3	yes	-	-	-	-	-	2	
3265	CORROSIVELIQUID, ACIDIC, ORGANIC, N.O.S. (...)	8, 40° (b)	8	N	2	3		10	97		3	yes	-	-	-	-	-	0	
3265	CORROSIVELIQUID, ACIDIC, ORGANIC, N.O.S. (...)	8, 40° (c)	8	N	4	3			97		3	yes	-	-	-	-	-	0	
3266	CORROSIVELIQUID, BASIC, INORGANIC, N.O.S. (...)	8, 47° (a)	8	N	4	2			97		3	yes	-	-	-	-	-	2	
3266	CORROSIVELIQUID, BASIC, INORGANIC, N.O.S. (...)	8, 47° (b) 8, 47° (c)	8	N	4	2			97		3	yes	-	-	-	-	-	0	
3267	CORROSIVELIQUID, BASIC, ORGANIC, N.O.S. (...)	8, 56° (a)	8	N	4	2			97		3	yes	-	-	-	-	-	2	
3267	CORROSIVELIQUID, BASIC, ORGANIC, N.O.S. (...)	8, 56° (b) 8, 56° (c)	8	N	4	2			97		3	yes	-	-	-	-	-	0	
3271	ETHERS, N.O.S. (...) f.p. < 23 °C vp50 ≤ 110 kPa	3, 3° (b)	3	N	2	2		10	97		3	yes	T4 ³⁾	II B ⁴⁾	+	+	-	1	14
3271	ETHERS, N.O.S. (tert -amylmethyl ether) f.p. < 23 °C vp50 ≤ 110 kPa	3, 3° (b)	3	N	2	2		10	97	0.77	3	yes	T2	II B ⁴⁾	+	+	-	1	
3271	ETHERS, N.O.S. (...) f.p. ≥ 23 °C	3, 31° (c)	3	N	3	2			97		3	yes	T4 ³⁾	II B ⁴⁾	+	+	-	1	14
3272	ESTERS, N.O.S. (...) f.p. < 23 °C vp50 ≤ 110 kPa	3, 3° (b)	3	N	2	2		10	97		3	yes	T4 ³⁾	II B ⁴⁾	+	+	-	1	14
3272	ESTERS, N.O.S. (...) f.p. ≥ 23 °C	3, 31° (c)	3	N	3	2			97		3	yes	T4 ³⁾	II B ⁴⁾	+	+	-	1	14
3286	FLAMMABLELIQUID, TOXIC, CORROSIVE, N.O.S. (...) f.p. < 23 °C boilingpoint ≤ 60 °C	3, 27° (a) 3, 27° (b)	3 + 6.1 + 8	C	1	1			95		1	no	T4 ³⁾	II B ⁴⁾	+	+	+	2	
3286	FLAMMABLELIQUID, TOXIC, CORROSIVE, N.O.S. (...) f.p. < 23 °C 60 °C < boilingpoint ≤ 85 °C	3, 27° (b)	3 + 6.1 + 8	C	2	2	3	50	95		2	no	T4 ³⁾	II B ⁴⁾	+	+	+	2	23

1	2	3	4	5	6	7	8	9	10	11	12	13	14	15	16	17	18	19	20
3286	FLAMMABLE LIQUID, TOXIC, CORROSIVE, N.O.S. (...) f.p. < 23 °C 85 °C < boilingpoint ≤ 115 °C	3, 27 ^a (b)	3 + 6.1 + 8	C	2	2		50	95		2	no	T4 ³⁾	II B ⁴⁾	+	+	+	2	
3286	FLAMMABLE LIQUID, TOXIC, CORROSIVE, N.O.S. (...) f.p. < 23 °C boiling point > 115 °C	3, 27 ^a (b)	3 + 6.1 + 8	C	2	2		35	95		2	no	T4 ³⁾	II B ⁴⁾	+	+	+	2	
3287	TOXIC LIQUID, INORGANIC, N.O.S. (sodium dichromate solution)	6.1, 65 ^a (c)	6.1	C	2	2		30	95	1.68	2	no	-	-	-	-	+	0	
3287	TOXIC LIQUID, INORGANIC, N.O.S. (...) boilingpoint ≤ 60 °C	6.1, 65 ^a (a) 6.1, 65 ^a (b)	6.1	C	1	1			95		1	no	-	-	-	-	+	2	
3287	TOXIC LIQUID, INORGANIC, N.O.S. (...) boilingpoint ≤ 60 °C	6.1, 65 ^a (c)	6.1	C	1	1			95		1	no	-	-	-	-	+	0	
3287	TOXIC LIQUID INORGANIC, N.O.S. (...) 60 °C < boilingpoint ≤ 85 °C	6.1, 65 ^a (a)	6.1	C	2	2	3	50	95		1	no	-	-	-	-	+	2	23
3287	TOXIC LIQUID, INORGANIC, N.O.S., (...) 60 °C < boilingpoint ≤ 85 °C	6.1, 65 ^a (b)	6.1	C	2	2	3	50	95		2	no	-	-	-	-	+	2	23
3287	TOXIC LIQUID INORGANIC, N.O.S. (...) 60 °C < boilingpoint ≤ 85 °C	6.1, 65 ^a (c)	6.1	C	2	2	3	50	95		2	no	-	-	-	-	+	0	23
3287	TOXIC LIQUID INORGANIC, N.O.S. (...) 85 °C < boilingpoint ≤ 115 °C	6.1, 65 ^a (a)	6.1	C	2	2		50	95		1	no	-	-	-	-	+	2	
3287	TOXIC LIQUID INORGANIC, N.O.S. (...) 85 °C < boilingpoint ≤ 115 °C	6.1, 65 ^a (b)	6.1	C	2	2		50	95		2	no	-	-	-	-	+	2	
3287	TOXIC LIQUID INORGANIC, N.O.S. (...) 85 °C < boilingpoint ≤ 115 °C	6.1, 65 ^a (c)	6.1	C	2	2		50	95		2	no	-	-	-	-	+	0	
3287	TOXIC LIQUID INORGANIC, N.O.S. (...) boiling point > 115 °C	6.1, 65 ^a (a)	6.1	C	2	2		35	95		1	no	-	-	-	-	+	2	

1	2	3	4	5	6	7	8	9	10	11	12	13	14	15	16	17	18	19	20
3287	TOXIC LIQUID INORGANIC, N.O.S. (...) boiling point > 115 °C	6.1, 65° (b)	6.1	C	2	2		35	95		2	no	-	-	-	-	+	2	
3287	TOXIC LIQUID INORGANIC, N.O.S. (...) boiling point > 115 °C	6.1, 65° (c)	6.1	C	2	2		35	95		2	no	-	-	-	-	+	0	
3289	TOXIC LIQUID CORROSIVE, INORGANIC, N.O.S. (...) boilingpoint ≤ 60 °C	6.1, 67° (a) 6.1, 67° (b)	6.1+8	C	1	1			95		1	no	-	-	-	-	+	2	
3289	TOXIC LIQUID CORROSIVE, INORGANIC, N.O.S. (...) 60 °C < boilingpoint ≤ 85 °C	6.1, 67° (a)	6.1+8	C	2	2	3	50	95		1	no	-	-	-	-	+	2	23
3289	TOXIC LIQUID CORROSIVE, INORGANIC, N.O.S. (...) 60 °C < boilingpoint ≤ 85 °C	6.1, 67° (b)	6.1+8	C	2	2	3	50	95		2	no	-	-	-	-	+	2	23
3289	TOXIC LIQUID CORROSIVE, INORGANIC, N.O.S. (...) 85 °C < boilingpoint ≤ 115 °C	6.1, 67° (a)	6.1+8	C	2	2		50	95		1	no	-	-	-	-	+	2	
3289	TOXIC LIQUID CORROSIVE, INORGANIC, N.O.S. (...) 85 °C < boilingpoint ≤ 115 °C	6.1, 67° (b)	6.1+8	C	2	2		50	95		2	no	-	-	-	-	+	2	
3289	TOXIC LIQUID CORROSIVE, INORGANIC, N.O.S. (...) boiling point > 115 °C	6.1, 67° (a)	6.1+8	C	2	2		35	95		1	no	-	-	-	-	+	2	
3289	TOXIC LIQUID CORROSIVE, INORGANIC, N.O.S. (...) boiling point > 115 °C	6.1, 67° (b)	6.1+8	C	2	2		35	95		2	no	-	-	-	-	+	2	
3295	HYDROCARBONS, LIQUID, N.O.S. (...) f.p. < 23 °C vp50 > 175 kPa	3, 1° (a)	3	N	1	1			97		1	yes	T4 ³⁾	II B ⁴⁾	+	+	-	1	14
3295	HYDROCARBONS, LIQUID, N.O.S. (...) f.p. < 23 °C vp50 > 175 kPa	3, 1° (a)	3	N	2	2	1	50	97		1	yes	T4 ³⁾	II B ⁴⁾	+	+	-	1	14
3295	HYDROCARBONS, LIQUID, N.O.S. (...) f.p. < 23 °C 110 kPa < vp50 ≤ 175 kPa	3, 2° (a) 3, 2° (b)	3	N	2	2		50	97		3	yes	T4 ³⁾	II B ⁴⁾	+	+	-	1	14

1	2	3	4	5	6	7	8	9	10	11	12	13	14	15	16	17	18	19	20
3295	HYDROCARBONS, LIQUID, N.O.S. (...) f.p. < 23 °C 110kPa < vp50 ≤ 150 kPa	3, 2° (a) 3, 2° (b)	3	N	2	2	3	10	97		3	yes	T4 ³⁾	II B ⁴⁾	+	+	-	1	14
3295	HYDROCARBONS, LIQUID, N.O.S. (...) f.p. < 23 °C v.p.50 ≤ 110 kPa	3, 3° (b)	3	N	2	2		10	97		3	yes	T4 ³⁾	II B ⁴⁾	+	+	-	1	14
3295	HYDROCARBONS, LIQUID, N.O.S. (...) f.p. ≥ 23 °C	3, 31° (c)	3	N	3	2			97		3	yes	T4 ³⁾	II B ⁴⁾	+	+	-	1	14
3295	HYDROCARBONS LIQUID, N.O.S. (polycyclic aromatic hydrocarbons mixture)	3, 31° (c)	3	N	3	2			97	1.08	3	yes	T1	II A	+	+	-	1	14
3295	HYDROCARBONS LIQUID, N.O.S. (1-Octen)	3, 3° (b)	3	N	2	2		10	97	0.71	3	yes	T3	II B ⁴⁾	+	+	-	1	14
3295	HYDROCARBONS LIQUID, N.O.S. (... with more than 10% benzen) f.p. < 23 °C vp50 > 175 kPa	3, 1° (a)	3	C	1	1			95		1	yes	T4 ³⁾	II B ⁴⁾	+	+	-	1	
3295	HYDROCARBONS LIQUID, N.O.S. (...with more than 10% benzen) f.p. < 23 °C 110 kPa < vp50 ≤ 175 kPa	3, 2° (a) 3, 2° (b)	3	C	1	1			95		1	yes	T4 ³⁾	II B ⁴⁾	+	+	-	1	
3295	HYDROCARBONS LIQUID, N.O.S. (...with more than 10% benzen) f.p. < 23 °C vp50 ≤ 110 kPa boilingpoint ≤ 60 °C	3, 3° (b)	3	C	1	1			95		1	yes	T4 ³⁾	II B ⁴⁾	+	+	-	1	
3295	HYDROCARBONS LIQUID, N.O.S. (with more than 10% benzen) f.p. < 23 °C vp50 ≤ 110 kPa 60 °C < boilingpoint ≤ 85 °C	3, 3° (b)	3	C	2	2	3	50	95		2	yes	T4 ³⁾	II B ⁴⁾	+	+	-	1	23

1	2	3	4	5	6	7	8	9	10	11	12	13	14	15	16	17	18	19	20
3295	HYDROCARBONS LIQUID, N.O.S. (with more than 10% benzen) f.p. < 23° C vp 50 ≤ 110 kPa 85 °C < boilingpoint ≤ 115° C	3, 3° (b)	3	C	2	2		50	95		2	yes	T4 ³⁾	II B ⁴⁾	+	+	-	1	
3295	HYDROCARBONS LIQUID, N.O.S. (with more than 10% benzen) f.p. < 23° C vp 50 ≤ 110 kPa boiling point > 115° C	3, 3° (b)	3	C	2	2		35	95		2	yes	T4 ³⁾	II B ⁴⁾	+	+	-	1	
3295	HYDROCARBONS LIQUID, N.O.S. (with more than 10% benzen) f.p. ≥ 23° C 60° C < boilingpoint ≤ 85° C	3, 31° (c)	3	C	2	2	3	50	95		2	yes	T4 ³⁾	II B ⁴⁾	+	+	-	1	23
3295	HYDROCARBONS LIQUID, N.O.S. (with more than 10% benzen) f.p. ≥ 23° C 85° C < boilingpoint ≤ 115 °C	3, 31° (c)	3	C	2	2		50	95		2	yes	T4 ³⁾	II B ⁴⁾	+	+	-	1	
3295	HYDROCARBONS LIQUID, N.O.S. (with more than 10% benzen) f.p. ≥ 23 °C boiling point > 115 °C	3, 31° (c)	3	C	2	2		35	95		2	yes	T4 ³⁾	II B ⁴⁾	+	+	-	1	
	SUBSTANCES WITH 61 °C < f.p. ≤ 100 °C, N.O.S. (...)	9, 80°		N	4	2			97		3	yes	-	-	-	-	-	0	
	SUBSTANCES WITH 61 °C < f.p. ≤ 100 °C, N.O.S. (eth ylene glycole monobutyl ether)	9, 80°		N	4	2			97	0.9	3	yes	-	-	-	-	-	0	
	SUBSTANCES WITH 61 °C < f.p. ≤ 100 °C, N.O.S. (2-ethylhexylacrylate, stabilized)	9, 80°	unst.	N	4	2			95	0.89	3	yes	-	-	-	-	-	0	3; 16
	DIPHENYLMETHANE-4,4'- DIISOCYANATE	9, 81°		N	2	3	2	10	95	1.21 ¹¹⁾	3	no	-	-	-	-	+	0	7; 8; 17; 19
	SUBSTANCES WITH f.p. > 61 °C, heated within a limiting range of 15 K below their f.p., N.O.S. (...)	3, 72°	3	N	3	2			97		3	yes	T4 ³⁾	II B ⁴⁾	+	+	-	0	

Footnotes related to the list of substances

- 1) The ignition temperature has not been determined in accordance with IEC 79-4; therefore, provisional assignment has been made to temperature class T2 which is considered safe.
- 2) The ignition temperature has not been determined in accordance with IEC 79-4; therefore, provisional assignment has been made to temperature class T3 which is considered safe.
- 3) The ignition temperature has not been determined in accordance with IEC 79-1A; therefore, provisional assignment has been made to temperature class T4 which is considered safe.
- 4) No maximum experimental safe gap (MESG) has been measured in accordance with IEC 79-1A; therefore, provisional assignment has been made to explosion group IIB which is considered safe.
- 5) No maximum experimental safe gap (MESG) has been measured in accordance with IEC 79-1A; therefore, provisional assignment has been made to explosion group IIC which is considered safe.
- 6) The maximum experimental safe gap (MESG) is within the marginal range between explosion group IIA and IIB.
- 7) No maximum experimental safe gap (MESG) has been measured in accordance with IEC-79-1A; therefore, assignment has been made to the explosion group which is considered safe.
- 8) No maximum experimental safe gap (MESG) has been measured in accordance with IEC 79-1A; therefore, assignment has been made to the explosion group in compliance with EN 50014.
- 9) Assignment in accordance with IMO (International Code for the Construction and Equipment of Ships Carrying Dangerous Chemicals in Bulk) (IBC Code).
- 10) Relative density at 15 °C.
- 11) Relative density at 25 °C.
- 12) Relative density at 37 °C.
- 13) Indications related to the pure substance.

ANNEX C

**Requirements and procedures concerning inspections,
the issue of certificates of approval, classification societies,
derogations, special authorizations, checks, training
and examination of experts**

(RESERVED)

ANNEX C

TABLE OF CONTENTS OF ANNEX C

Chapter 1	Procedure for the issue of the certificate of approval
1.1	Issue and recognition of certificates of approval
1.1.1	Certificate of approval
1.1.2	Provisional certificate of approval
1.2	Inspection procedure
1.3	Inspection body
1.4	Application for the issue of a certificate of approval
1.5	Particulars entered in the certificate of approval and amendments thereto
1.6	Presentation of the vessel for inspection
1.7	First inspection
1.8	Special inspection
1.9	Periodic inspection and renewal of the certificate of approval
1.10	Extension of the certificate of approval without an inspection
1.11	Official inspection
1.12	Withholding and return of the certificate of approval
1.13	Duplicate copy
1.14	Register of certificates of approval
Chapter 2	Recognition of classification societies
2.1	General
2.2	Procedure for the recognition of classification societies
2.3	Conditions and criteria for the recognition of a classification society applying for recognition under this Agreement
2.4	Obligations of recommended classification societies
Chapter 3	Procedure for equivalents and derogations
3.1	Procedure for equivalents
3.2	Derogations on a trial basis
3.3	Particulars of equivalents and derogations
Chapter 4	Special authorizations concerning transport in tank vessels
4.1	Special authorizations
4.2	Procedure
4.3	Update of the list of substances authorized for carriage in tank vessels

Table of contents of Annex C (cont'd)

Chapter 5	Monitoring the carriage of dangerous goods by inland waterways
5.1	Monitoring compliance with requirements
5.2	Monitoring procedure
5.3	Infringements of the requirements
5.4	Checks in companies and at places of loading and unloading
5.5	Sampling
5.6	Cooperation of the competent authorities
5.7	Administrative assistance during the checking of a foreign vessel
Chapter 6	Training and examination of experts
6.1	Training
6.2	Purpose and content of training course
6.3	Approval of training courses
6.4	Conduct of training courses
6.5	Examinations
6.6	ADN specialized knowledge certificate
Chapter 7	Special bilateral and multilateral agreements

Annex C - Chapter 1

CHAPTER 1

PROCEDURE FOR THE ISSUE OF THE CERTIFICATE OF APPROVAL

Certificates of approval shall conform to the requirements set out in marginals 10 282 and 10 283 of Annex B.1, or marginals 210 282 and 210 283 of Annex B.2 of these Regulations. They shall be issued in accordance with the following procedure:

1.1 Issue and recognition of certificates of approval

1.1.1 *Certificate of approval*

1.1.1.1 The certificate of approval referred to in marginal 10 282 or 210 282 shall be issued by the competent authority of the Contracting Party where the vessel is registered, or in its absence, of the Contracting Party where it has its home port or, in its absence, of the Contracting Party where the owner is domiciled or in its absence, by the competent authority selected by the owner or his representative.

The other Contracting Parties shall recognize such certificates of approval.

The period of validity, which shall not exceed five years, shall be entered in the certificate of approval.

1.1.1.2 The competent authority of any of the Contracting Parties may request the competent authority of any other Contracting Party to issue a certificate of approval in its stead.

1.1.1.3 The competent authority of any of the Contracting Parties may delegate the authority to issue the certificate of approval to an inspection body as defined in 1.3.

1.1.2 *Provisional certificate of approval*

The provisional certificate of approval referred to in marginal 10 283 or in marginal 210 283 shall be issued by the competent authority of one of the Contracting Parties for the cases and under the conditions referred to in these marginals.

The other Contracting Parties shall recognize such provisional certificates of approval.

1.2 Inspection procedure

1.2.1 The competent authority of the Contracting Party shall supervise the inspection of the vessel. Under this procedure, the inspection may be performed by an inspection body designated by the Contracting Party or by a recognized classification society. The inspection body or the recognized classification society shall issue an inspection report certifying that the vessel conforms partially or completely to the provisions of these Regulations.

1.2.2 This inspection report shall be drawn up in a language accepted by the competent authority and shall contain all the necessary information to enable the certificate to be drawn up.

Annex C - Chapter 1

1.3 Inspection body

1.3.1 Inspection bodies shall be subject to recognition by the Contracting Party administration as expert bodies on the construction and inspection of inland navigation vessels and as expert bodies on the transport of dangerous goods by inland waterway. They shall meet the following criteria:

- Compliance by the body with the requirements of impartiality;
- Existence of a structure and personnel that provide objective evidence of the professional ability and experience of the body;
- Compliance with the material contents of standard EN 45004: 1995 supported by detailed inspection procedures.

1.3.2 Inspection bodies may be assisted by experts (e.g. an expert in electrical installations) or specialized bodies according to the national provisions applicable (e.g. classification societies).

1.3.3 The Administrative Committee shall maintain an up-to-date list of the inspection bodies appointed.

1.4 Application for the issue of a certificate of approval

The owner of a vessel, or his representative, who requests a certificate of approval, shall deposit an application with the competent authority referred to in 1.1.1.1. The competent authority shall specify the documents to be submitted to it. In order to obtain a certificate of approval a valid vessel certificate shall accompany the request.

1.5 Particulars entered in the certificate of approval and amendments thereto

1.5.1 The owner of a vessel, or his representative, shall inform the competent authority of any change in the name of the vessel or change of official number or registration number and shall transmit to it the certificate of approval for amendment.

1.5.2 All particulars or amendments to the certificate of approval provided for in these Regulations and in the other regulations drawn up by mutual agreement by the Contracting Parties may be entered in the certificate by the competent authority.

1.5.3 When the owner of the vessel, or his representative, has the vessel registered in another Contracting Party, he shall request a new certificate of approval from the competent authority of that Contracting Party. The competent authority may issue the new certificate for the remaining period of validity of the existing certificate without making a new inspection of the vessel, provided that the state and the technical specifications of the vessel have not undergone any modification.

Annex C - Chapter 1

1.6 Presentation of the vessel for inspection

- 1.6.1 The owner, or his representative, shall present the vessel for inspection unladen, cleaned and equipped; he shall be required to provide such assistance as may be necessary for the inspection, such as providing a suitable launch and personnel, and uncovering those parts of the hull or installations which are not directly accessible or visible.
- 1.6.2 In the case of a first, special or periodical inspection, the inspection body or the recognized classification society may require a dry-land inspection.

1.7 First inspection

If a vessel does not yet have a certificate of approval or if the validity of the certificate of approval expired more than six months ago, the vessel shall undergo a first inspection.

1.8 Special inspection

If the vessel's hull or equipment has undergone alterations liable to diminish safety in respect of the carriage of dangerous goods, or has sustained damage affecting such safety, the vessel shall be presented without delay by the owner or his representative for further inspection.

1.9 Periodic inspection and renewal of the certificate of approval

- 1.9.1 To renew the certificate of approval, the owner of the vessel, or his representative, shall present the vessel for a periodic inspection. The owner of the vessel or his representative may request an inspection at any time.
- 1.9.2 If the request for a periodic inspection is made during the last year preceding the expiry of the validity of the certificate of approval, the period of validity of the new certificate shall commence when the validity of the preceding certificate of approval expires.
- 1.9.3 A periodic inspection may also be requested during a period of six months after the expiry of the certificate of approval.
- 1.9.4 The competent authority shall establish the period of validity of the new certificate of approval on the basis of the results of the inspection.

1.10 Extension of the certificate of approval without an inspection

By derogation from 1.9, at the substantiated request of the owner or his representative, the competent authority may grant an extension of the validity of the certificate of approval of not more than one year without an inspection. This extension shall be granted in writing and shall be kept on board the vessel. Such extensions may be granted only once every two validity periods.

1.11 Official inspection

- 1.11.1 If the competent authority of a Contracting Party has reason to assume that a vessel

Annex C - Chapter 1

which is in its territory may constitute a danger in relation to the transport of dangerous goods, for the persons on board or for shipping or for the environment, it may order an inspection of the vessel in accordance with 1.2.

- 1.11.2 When exercising this right to inspect, the authorities will make all possible efforts to avoid unduly detaining or delaying a vessel. Nothing in this Agreement affects rights relating to compensation for undue detention or delay. In any instance of alleged undue detention or delay the burden of proof shall lie with the owner or operator of the vessel.

1.12 Withholding and return of the certificate of approval

- 1.12.1 When an inspection body or a classification society observes, in the course of an inspection, that a vessel or its equipment suffers from serious defects in relation to dangerous goods which might jeopardize the safety of the persons on board or the safety of shipping, or constitute a hazard for the environment, it shall immediately notify the competent authority to which it answers with a view to a decision to withhold the certificate.

If this authority which decided to withdraw the certificate is not the authority which issued the certificate, it shall immediately inform the latter and, where necessary, return the certificate to it if it presumes that the defects cannot be eliminated in the near future.

- 1.12.2 When the inspection body or the classification society referred to in 1.12.1 above ascertains, by means of a special inspection according to 1.8, that these defects have been remedied, the certificate of approval shall be returned by the competent authority to the owner or to his representative.

This inspection may be made at the request of the owner or his representative by another inspection body or another classification society. In this case, the certificate of approval shall be returned through the competent authority to which the inspection body or the classification society answers.

- 1.12.3 When a vessel is finally immobilized or scrapped, the owner shall send the certificate of approval back to the competent authority which issued it.

1.13 Duplicate copy

In the event of the loss, theft or destruction of the certificate of approval or when it becomes unusable for other reasons, an application for a duplicate copy, accompanied by appropriate supporting documents, shall be made to the competent authority which issued the certificate.

This authority shall issue a duplicate copy of the certificate of approval, which shall be designated as such.

1.14 Register of certificates of approval

- 1.14.1 The competent authorities shall assign a serial number to the certificates of approval which they issue. They shall keep a register of all the certificates issued.

Annex C - Chapter 1

- 1.14.2 The competent authorities shall keep copies of all the certificates which they have issued and enter all particulars and amendments in them, as well as cancellations and replacements of certificates.

Annex C - Chapter 2

CHAPTER 2

RECOGNITION OF CLASSIFICATION SOCIETIES

2.1 General

In the event of the conclusion of an international agreement concerning more general regulations for the navigation of vessels on inland waterways and containing provisions relating to the full range of activities of classification societies and their recognition, any provision of this Chapter in contradiction with any of the provisions of the said international agreement would, in the relations among Parties to this Agreement which had become parties to the international agreement and as from the day of the entry into force of the latter, automatically be deleted and replaced ipso facto by the relevant provision of the international agreement. This Chapter would become null and void once the international agreement came into force if all Parties to this Agreement became Parties to the international agreement.

2.2 Procedure for the recognition of classification societies

2.2.1 A classification society which wishes to be recommended for recognition under this Agreement shall submit its application for recognition, in accordance with the provisions of this chapter, to the competent authority of a Contracting Party.

The classification society shall prepare the relevant information in accordance with the provisions of this chapter. It shall produce it in, at least, an official language of the State where the application is submitted and in English.

The Contracting Party shall forward the application to the Administrative Committee unless in its opinion the conditions and criteria referred to in 4.3 have manifestly not been met.

2.2.2 The Administrative Committee shall appoint a Committee of Experts and determine its composition and its rules of procedure. This Committee of Experts shall consider the proposal; it shall determine whether the classification society meets the criteria set out in 2.3 and shall make a recommendation to the Administrative Committee within a period of six months.

2.2.3. The Administrative Committee shall examine the report of the experts. It shall decide in accordance with the procedure set out in Article 17, 7(c), within one year maximum, whether or not to recommend to the Contracting Parties that they should recognize the classification society in question. The Administrative Committee shall establish a list of the classification societies recommended for recognition by the Contracting Parties.

2.2.4 Each Contracting Party may or may not decide to recognize the classification societies in question, only on the basis of the list referred to in 2.2.3. The Contracting Party shall inform the Administrative Committee and the other Contracting Parties of its decision.
The Administrative Committee shall update the list of recognitions issued by

Annex C - Chapter 2

Contracting Parties.

- 2.2.5 If a Contracting Party considers that a classification society no longer meets the conditions and criteria set out in 2.3, it may submit a proposal to the Administrative Committee for withdrawal from the list of recommended societies. Such a proposal shall be substantiated by convincing evidence of a failure to meet the conditions and criteria.
- 2.2.6 The Administrative Committee shall set up a new Committee of Experts following the procedure set out under 2.2.2 which shall report to the Administrative Committee within a period of six months.
- 2.2.7 The Administrative Committee may decide, according to Article 17, 7 (c), to withdraw the name of the society in question from the list of societies recommended for recognition.

In such a case the society in question shall immediately be so informed. The Administrative Committee shall also inform all the Contracting Parties that the classification society in question no longer meets the requirements to act as a recognized classification society in the context of the Agreement and shall invite them to take the necessary steps in order to remain in conformity with the requirements of the Agreement.

2.3 Conditions and criteria for the recognition of a classification society applying for recognition under this Agreement

A classification society applying for recognition under this Agreement shall meet all the following conditions and criteria:

- 2.3.1 A classification society shall be able to demonstrate extensive knowledge of and experience in the assessment of the design and construction of inland navigation vessels. The society should have comprehensive rules and regulations for the design, construction and periodical inspection of vessels. These rules and regulations shall be published and continuously updated and improved through research and development programmes.
- 2.3.2 Registers of the vessels classified by the classification society shall be published annually.
- 2.3.3 The classification society shall not be controlled by shipowners or shipbuilders, or by others engaged commercially in the manufacture, fitting out, repair or operation of ships. The classification society shall not be substantially dependent on a single commercial enterprise for its revenue.
- 2.3.4 The headquarters or a branch of the classification society authorized and entitled to give a ruling and to act in all areas incumbent on it under the regulations governing inland navigation shall be located in one of the Contracting Parties.
- 2.3.5 The classification society and its experts shall have a good reputation in inland

Annex C - Chapter 2

navigation; the experts shall be able to provide proof of their professional abilities.

2.3.6

The classification society:

- shall have sufficient professional staff and engineers for the technical tasks of monitoring and inspection and for the tasks of management, support and research, in proportion to the tasks and the number of vessels classified and sufficient to keep regulations up to date and develop them in the light of quality requirements;
- shall have experts in at least two Contracting Parties.

2.3.7

The classification society shall be governed by a code of ethics.

2.3.8

The classification society shall have prepared and implemented and shall maintain an effective system of internal quality based on the relevant aspects of internationally recognized quality standards and conforming to the standards EN: 45004: 1995 (control mechanisms) and ISO 9001 or EN 29001: 1997. The classification society is subject to certification of its quality system by an independent body of auditors recognized by the administration of the State in which it is located.

2.4

Obligations of recommended classification societies

2.4.1

Recommended classification societies shall undertake to cooperate with each other so as to guarantee the equivalence of their technical standards and their implementation.

2.4.2

Recommended classification societies shall undertake to bring their requirements into line with the present and future provisions of this Agreement.

Annex C - Chapter 3

CHAPTER 3

PROCEDURE FOR EQUIVALENTS AND DEROGATIONS

3.1 Procedure for equivalents

When the provisions of these Regulations prescribe for a vessel the use or the presence on board of certain materials, installations or equipment or the adoption of certain construction measures or certain fixtures, the competent authority may agree to the use or the presence on board of other materials, installations or equipment or the adoption of other construction measures or other fixtures for this vessel if, in line with recommendations established by the Administrative Committee, they are accepted as equivalent.

3.2 Derogations on a trial basis

The competent authority may, on the basis of a recommendation by the Administrative Committee, issue a trial certificate of approval for a limited period for a specific vessel having new technical characteristics departing from the requirements of these Regulations, provided that these characteristics are sufficiently safe.

3.3 Particulars of equivalents and derogations

The equivalents and derogations referred to in 3.1 and 3.2 shall be entered in the certificate of approval.

Annex C - Chapter 4

CHAPTER 4

SPECIAL AUTHORIZATIONS CONCERNING TRANSPORT IN TANK VESSELS

4.1 Special authorizations

- 4.1.1 In accordance with paragraph 2 of Article 7, the competent authority shall have the right to issue special authorizations to a carrier or a shipper for the international carriage in tank vessels of dangerous substances, including mixtures, the carriage of which in tank vessels is not authorized under these Regulations, in accordance with the procedure set out below.
- 4.1.2 The special authorization shall be valid, due account being taken of the restrictions specified therein, for the Contracting Parties and on whose territory the transport operation will take place, for not more than two years but unless it is repealed at an earlier date. With the approval of the Competent authorities of these Contracting Parties, the special authorization may be renewed for a period of not more than one year.
- 4.1.3 The special authorization shall include a statement concerning its repeal at an earlier date and shall conform to the model given in these Regulations.

4.2 Procedure

- 4.2.1 The carrier or the shipper shall apply to the competent authority of a Contracting Party on whose territory the transport operation takes place for the issue of a special authorization.

The application shall include the particulars mentioned in these Regulations. The applicant shall be responsible for the accuracy of the particulars.

- 4.2.2 The competent authority shall consider the application from the technical and safety point of view. If it has no reservations, it shall draw up a special authorization in accordance with the criteria established by the Administrative Committee and immediately inform the other competent authorities involved in the carriage in question. The special authorization shall be issued only when the authorities concerned agree to it or have not expressed opposition within a period of two months after receiving the information. The applicant shall receive the original of the special authorization and keep a copy of it on board the vessel(s) involved in the carriage in question. The competent authorities shall immediately communicate to the Administrative Committee the applications for special authorizations, the applications rejected and the special authorizations granted.
- 4.2.3 If the special authorization is not issued because doubts or opposition have been expressed, the Administrative Committee shall decide whether or not to issue a special authorization.

4.3 Update of the list of substances authorized for carriage in tank vessels

- 4.3.1 The Administrative Committee shall consider all the special authorizations and applications communicated to it and decide whether the substance is to be included in the list of substances in these Regulations, authorized for carriage in tank vessels.

Annex C - Chapter 4

- 4.3.2 If the Administrative Committee enters technical or safety reservations concerning the inclusion of the substance in the list of substances of these Regulations authorized for carriage in tank vessels or concerning certain conditions, the competent authority shall be so informed. The competent authority shall immediately withdraw or, if necessary, modify the special authorization.

Annex C - Chapter 5

CHAPTER 5

MONITORING THE CARRIAGE OF DANGEROUS GOODS BY INLAND WATERWAYS

5.1 Monitoring compliance with requirements

Contracting Parties shall ensure that a representative proportion of consignments of dangerous goods carried by inland waterways is subject to monitoring in accordance with the provisions of this Chapter.

5.2 Monitoring procedure

5.2.1 In order to carry out the checks provided for in this Agreement, the Contracting Parties shall use the checklist to be developed by the Administrative Committee. A copy of this checklist or a certificate showing the result of the check drawn up by the competent authority which carried it out shall be given to the master of the vessel and presented on request in order to simplify or avoid, where possible, subsequent checks. This paragraph shall not prejudice Contracting Parties' right to carry out specific measures for detailed checks.

5.2.2 The checks shall be random and shall as far as possible cover an extensive portion of the inland waterway network.

5.2.3 When exercising the right to monitor, the authorities shall make all possible efforts to avoid unduly detaining or delaying a vessel.

5.3 Infringements of the requirements

Without prejudice to other penalties which may be imposed, vessels in respect of which one or more infringements of the rules on the transport of dangerous goods are established may be detained at a place designated for this purpose by the authorities carrying out the check and required to be brought into conformity before continuing their journey or may be subject to other appropriate measures, depending on the circumstances or the requirements of safety.

5.4 Checks in companies and at places of loading and unloading

5.4.1 Checks may be carried out at the premises of undertakings, as a preventive measure or where infringements which jeopardize safety in the transport of dangerous goods have been recorded during the voyage.

5.4.2 The purpose of such checks shall be to ensure that safety conditions for the transport of dangerous goods by inland waterways comply with the relevant laws.

Annex C - Chapter 5

5.5. Sampling

Where appropriate and provided that this does not constitute a safety hazard, samples of the goods transported may be taken for examination by laboratories recognized by the competent authority.

5.6 Cooperation of the competent authorities

5.6.1 Contracting Parties shall assist one another in order to give proper effect to these requirements.

5.6.2 Serious or repeated infringements jeopardizing the safety of the transport of dangerous goods committed by a foreign vessel or undertaking shall be reported to the competent authority in the Contracting Party where the certificate of approval of the vessel was issued or where the undertaking is established.

5.6.3 The competent authority of the Contracting Party where serious or repeated infringements have been recorded may ask the competent authority of the Contracting Party where the certificate of approval of the vessel was issued or where the undertaking is established for appropriate measures to be taken with regard to the offender or offenders.

5.6.4 The latter competent authority shall notify the competent authorities of the Contracting Party where the infringements were recorded of any measures taken with regard to the offender or offenders.

5.7 Administrative assistance during the checking of a foreign vessel

If the findings of a check on a foreign vessel give grounds for believing that serious or repeated infringements have been committed which can not be detected in the course of that check in the absence of the necessary data, the competent authorities of the Contracting Parties concerned shall assist one another in order to clarify the situation.

Annex C - Chapter 6

CHAPTER 6

TRAINING AND EXAMINATION OF EXPERTS

The following provisions are applicable to the approval of expert training courses in accordance with marginals 10 315 of Annex B.1 and 210 315, 210 317 and 210 318 of Annex B.2 of these Regulations.

The purpose of the training courses is to provide persons who are to work as experts and persons wishing to obtain the certificate showing that they have completed a training course on the transport of dangerous goods by inland waterways with the necessary theoretical and practical knowledge, in accordance with marginals 10 315 or 210 315, 210 317 and 210 318.

6.1. Training

6.1.1 General

Special knowledge shall be acquired through initial theoretical and practical training. Theoretical knowledge shall be tested by means of an examination concerning these Regulations.

Training shall recommence before the expiry of the period referred to in marginals 10 315 (5), 210 315 (5), 210 317 (5) or 210 318 (5).

6.1.2 Organization of training and subjects

6.1.2.1 Organization

Basic courses and refresher and further training courses shall be organized in accordance with marginals 10 315 or 210 315, while specialization courses shall be organized in accordance with marginals 210 317 and 210 318. The courses referred to in marginals 10 315 or 210 315 may have three variants: transport of dry cargo, transport in tankers and combined transport of dry cargo using tankers.

6.1.2.2 Basic course and refresher and further training courses

Basic course on the transport of dry cargo

Prior training: none
Knowledge: ADN in general, Annexes A and B.1
Authorized for: vessels carrying dry cargo only

Basic course on transport by tanker

Prior training: none
Knowledge: ADN in general, Annexes A, B.1 and B.2
(excluding marginals 311 000-320 999 and 321 000-330 999)
Authorized for: type N tankers only
Combined basic course dry cargo and transport in tankers

Annex C - Chapter 6

Prior training: none
Knowledge: ADN in general, Annexes A, B.1 and B.2
(excluding marginals 311 000-320 999 and 321 000-330 999)
Authorized for: dry cargo vessels and type N tankers

Specialization course in gases

Prior training: basic tanker or combined training
Knowledge: ADN, Annex B.2, marginals 311 000-320 999
Authorized for: tankers of types N and G

Specialization course in chemicals

Prior training: basic tanker or combined training
Knowledge: ADN, Annex B.2, marginals 321 000-330 999
Authorized for: tankers of types N and C

6.1.2.3 Refresher and further training courses based on the certified basic courses referred to in paragraph 6.1.2.2

Prior training: Valid ADN certificate referred to in paragraph 6.1.2.2 with a refresher course in accordance with marginals 10 315, 210 315, 10 315/210 315, 210 317 or 210 318.

6.2. Purpose and content of training course

6.2.1 The following provisions are applicable to the approval of the expert training courses in accordance with marginal 10 315 or marginals 210 315, 210 317 and 210 318.

6.2.2 The purpose of the training courses is to provide the theoretical and practical knowledge referred to in paragraph 6.1.2.

6.2.2.1 Initial training

The following periods of training are to be completed:

basic training course on dry cargo vessels:	24 lessons of 45 minutes
each basic training course on tankers:	24 lessons of 45 minutes
each combined basic training course:	32 lessons of 45 minutes
each specialization course on gases:	16 lessons of 45 minutes
each specialization course on chemicals:	16 lessons of 45 minutes

One day's training may comprise a maximum of eight lessons.

If theoretical training is by correspondence, equivalences with the above-mentioned lessons shall be determined. Training by correspondence must be completed within nine months.

Approximately 30% of basic training shall be devoted to practical exercises. These practical exercises shall if possible be completed during the theoretical training period; in any event,

Annex C - Chapter 6

they shall take place not more than three months following the completion of theoretical training.

6.2.2.2 Refresher and further training courses

Additional training courses are intended to refresh existing knowledge and provide information on new developments in the technical and legal fields and in relation to subject matter.

These courses shall take place before the expiry of the period referred to in marginal 10 315 (5) or, where pertinent, in marginals 210 315 (5), 210 317 (5) and 210 318 (5).

The duration of training courses shall be as follows:

Basic refresher course:

- | | | |
|---|--|-------------------------------|
| - | dry cargo vessels | 16 lessons of 45 minutes each |
| - | tankers | 16 lessons of 45 minutes each |
| - | combined dry cargo vessels and tankers | 16 lessons of 45 minutes each |

Specialization refresher course on gases:	8 lessons of 45 minutes each
Specialization refresher course on chemicals:	8 lessons of 45 minutes each

Each day of training may comprise not more than eight lessons.

If the theoretical training is by correspondence, equivalences to the above-mentioned lessons shall be determined. Training by correspondence shall be completed within a period of nine months.

Approximately 50% of basic training shall be devoted to practical exercises. Practical exercises shall, where possible, be undertaken during the period of theoretical training; in any event, they shall be completed not later than three months following the completion of theoretical training.

6.3. Approval of training courses

6.3.1 Training courses shall be approved by the competent authority.

6.3.2 Approval shall be granted only on written application. Application for approval may be made by individuals or corporate entities.

Applications for approval shall be accompanied by:

- the detailed course curriculum showing the course topics and the length of time to be devoted to them, as well as the teaching method envisaged;
- the roster of teaching staff, listing their qualifications and the subjects to be taught by each one;

Annex C - Chapter 6

(c) information on classrooms and teaching materials, as well as on the facilities available for practical exercises;

(d) enrolment requirements.

The competent authority may ask for additional information or documents concerning the qualifications of teachers particularly with regard to adult education.

6.3.3 The competent authority may, where it deems necessary, require amendments to be made to the documents relating to the approval application.

6.3.4 *Granting of approval*

6.3.4.1 The competent authority shall grant approval in writing. Such approval shall be subject to the following conditions, inter alia:

- training courses shall conform to the information accompanying the application for approval;
- the competent authority may send inspectors to attend training courses;
- the timetables for the various training courses shall be notified in advance to the competent authority;
- approval may be withdrawn in the event of failure to abide by the approval conditions.

The approval document shall indicate whether the course in question is a basic training course, a specialized course or a refresher and further training course.

6.3.4.2 If, after approval is granted, the organizer of the training course wishes to change conditions affecting the approval, he shall seek the prior agreement of the competent authority. This provision shall apply in particular to the replacement of serving teachers and amendments to syllabuses.

6.4. Conduct of training courses

6.4.1 Training courses shall take account of the current developments in the various subjects taught. The course organizer shall be responsible for ensuring that recent developments are brought to the attention of, and properly understood by, teachers.

6.4.2 Training courses shall be as practically oriented as possible. Course syllabuses shall be based on the subjects listed in 6.1.2. Basic training courses shall also comprise a practical component (see 6.2.2 above).

6.4.3 During the refresher and further training courses, exercises and tests should ensure that the participant has taken an active part in the course.

6.5. Examinations

Annex C - Chapter 6

6.5.1 *Basic training courses*

After initial training, including practical exercises, an ADN basic training examination shall be taken. This examination shall be held either immediately after the training courses or within six months following the completion of such courses.

The list of questions drawn up by the competent authority shall be used for this purpose.

Candidates shall be asked 30 questions. The examination shall last 60 minutes. It is deemed to have been passed if at least 25 of the 30 questions have been answered correctly. During the examination, candidates may consult the texts of regulations on dangerous goods.

Each competent authority shall determine the conditions of the ADN examination on the basis of the programme described in marginals 10 315 (3) or 210 315 (3) of Annex 1 and the list of questions drawn up by the competent authority.

6.5.2 *Specialization course on gases and chemicals*

Candidates who are successful in the ADN basic training examination may apply for enrolment in a “gases” and/or “chemicals” specialization course, to be followed by an examination. The examination shall be based on the competent authority’s list of questions.

The candidate is to be asked 30 multiple-choice questions and one substantive question. The examination shall last a total of 120 minutes, of which 60 minutes for the multiple-choice questions and 60 minutes for the substantive question.

The examination shall be marked out of a total of 60, of which 30 marks will go to the multiple-choice questions (one mark per question) and 30 to the substantive question (the distribution of marks is left to the appreciation of the competent authority). A total of 44 marks must be achieved to pass. However, not less than 20 marks must be obtained in each subject. If the candidate obtains 44 but does not achieve 20 in one subject, the subject in question may be set in a resit.

The texts of regulations and technical literature are permitted during the examination.

Each competent authority shall determine the conditions of the examination on the basis of the programme described in marginal 210 317 (3) or 210 318 (3) and the competent authority's list of questions.

Annex C - Chapter 6

6.6. ADN specialized knowledge certificate

The issue and renewal of the ADN specialized knowledge certificate conforming to model No. 3 of Annex B.1, Appendix 1, or model No. 3 of Annex B.2, Appendix 1, shall be the responsibility of the competent authority.

Certificates shall be issued to:

- candidates who have attended a basic training course and have passed the ADN examination;
- candidates who have taken part in a refresher or further training course.

The validity of the “gases” and/or “chemicals” specialized training certificate shall be brought into line with the validity of the basic training certificate.

If the training was not completed before the expiry of the period of validity of the certificate, a new certificate shall not be issued until the candidate has completed a further initial basic training course and passed an ADN examination or an examination referred to in 6.5.2 above.

Annex C - Chapter 7

CHAPTER 7

SPECIAL BILATERAL AND MULTILATERAL AGREEMENTS

The period of validity of the special bilateral or multilateral agreements referred to in Article 7, paragraph 1, shall not be more than five years from the date of their entry into force.

ANNEX D.1

General transitional provisions

(RESERVED)

Annex D.1 - GENERAL TRANSITIONAL PROVISIONS

1. In this Annex D.1

- Vessel in service” means a vessel according to Article 8, paragraph 2 of the Agreement;
- “N.R.M.” means that the requirement does not apply to vessels in service except where the parts concerned are replaced or modified, i.e. it applies only to vessels which are new, or to parts which are replaced or modified; where existing parts are replaced by spare or replacement parts of the same type and manufacture, this shall not be considered a replacement “R” as defined in these transitional provisions.

Modification shall also be taken to mean the conversion of an existing type of tank vessel, a type of cargo tank or a cargo tank design to another type or design at a higher level.

- “Renewal of the certificate of approval after the ...” means that the requirement shall be met at the next renewal of the certificate of approval following the date indicated. If the certificate of approval expires during the first year after the date of application of these Regulations, the requirement shall be mandatory only after the expiry of this first year.

2. Vessels in service shall meet:

- the requirements of marginals and, where necessary, paragraphs and subparagraphs mentioned in the table below within the period established therein;
- the requirements of marginals and, where necessary, paragraphs and subparagraphs not mentioned in the table below at the date of application of these Regulations.

The construction and equipment of vessels in service shall be maintained at least at the previous standard of safety.

Table of transitional provisions		
Marginal	Subject	Time limit and comments
110 212 (1)	Ventilation of holds	N.R.M. The following requirements apply on board vessels in service: Each hold shall have appropriate natural or artificial ventilation; for the carriage of substances of Class 4.3, each hold shall be equipped with forced-air ventilation; the appliances used for this purpose must be so constructed that water cannot enter the hold.
110 212 (3)	Ventilation of service spaces	N.R.M.

Annex D.1

Table of transitional provisions		
Marginal	Subject	Time limit and comments
110 217 (2)	Gas-tight openings facing holds	N.R.M. The following requirements apply on board vessels in service: Openings of accommodation and the wheelhouse facing the holds must be capable of being tightly closed.
110 217 (3)	Entrances and openings in the protected area	N.R.M. The following requirements apply on board vessels in service: Openings of accommodation and the wheelhouse facing holds shall be capable of being tightly closed.
110 231 (2)	Air intakes of engines	N.R.M.
110 232 (2)	Air pipes 50 cm above the deck	N.R.M.
110 234 (1)	Exhaust pipes	N.R.M.
110 235	Stripping pumps in the protected area	N.R.M. The following requirements apply on board vessels in service: In the event of the carriage of substances of Class 4.1, 52°, of all substances of Class 4.3 in bulk or unpackaged and polymeric beads, expandable, of Class 9, 4° (c), the stripping of the holds may only be effected using a stripping installation located in the protected area. The stripping installation located above the engine room must be clamped.
110 240 (1)	Fire extinguishers, two pumps, etc.	N.R.M.
110 240 (2)	Fire extinguishing systems permanently fixed in engine rooms	N.R.M.

Annex D.1

Table of transitional provisions		
Marginal	Subject	Time limit and comments
110 241 in conjunction with 10 341	Fire and naked light	N.R.M. The following requirements apply on board vessels in service: The outlets of funnels shall be located not less than 2.00 m from the nearest point on hold hat chways. Heating and cooking appliances shall be permitted only in metal-based accommodation and wheelhouses.
		However: Heating appliances fuelled with liquid fuels having a flashpoint above 55° C shall be permitted in engine rooms; Central-heating boilers fuelled with solid fuels shall be permitted in spaces situated below deck and accessible only from the deck.
120 231 (2)	Air intakes of engines	N.R.M.
120 234 (1)	Position of exhaust pipes	N.R.M.
120 241 in conjunction with 10 341	Fire and naked light	N.R.M. The following requirements apply on board vessels in service: Out lets of fun nels shall be located not less than 2.00 m from the nearest point on hold hat chways. Heating and cooking appliances shall be permitted only in metal-based accommodation and wheelhouses. However: - Heating appliances fuelled with liquid fuels having a flashpoint above 55° C shall be permitted in engine rooms; - central-heating boilers fuelled by solid fuels shall be permitted in spaces situated below the deck and accessible only from the deck.

Annex D.1

Table of transitional provisions		
Marginal	Subject	Time limit and comments
210 014	Limited explosion risk electrical apparatus	N.R.M. The following requirements apply on board vessels in service: Limited explosion risk electrical apparatus is: - Electrical apparatus which, during normal operation, does not cause sparks or exhibit surface temperatures exceeding 200° C; or - electrical apparatus with a spray-water protected housing which, during normal operation, does not exhibit surface temperatures above 200° C.
210 014	Hold space	Not applicable to Type N open vessels whose hold spaces contain auxiliary appliances and which are carrying only substances of Class 8, 1° (a), 1° (b) or 42° (b).
210 206	Approved gas detection system	N.R.M.
210 208 (2) and (3)	Classification of Type N open vessels with flame-traps and Type N open vessels	N.R.M.
210 219 (3)	Vessels used for propulsion	N.R.M.
210 320	Use of cofferdams for ballasting	On board vessels in service, cofferdams may be filled with water during unloading to provide trim and to permit residue-free drainage if possible.
210 320 (1)	Ballast water Prohibition against filling cofferdams with water	N.R.M. The following requirements apply on board vessels in service: Cofferdams may be filled with ballast water only when cargo tanks are empty.
210 320 (1)	Proof of stabilization in the event of a leak connected with ballast water for Type G vessels	N.R.M.

Annex D.1

Table of transitional provisions		
Marginal	Subject	Time limit and comments
210 325(1)(c)	Connections prohibited between pipes for loading and unloading and pipes located outside the cargo area	N.R.M. for oil-separator vessels.
210 331 (2)	Motor vehicles only outside the cargo area: Type N open	N.R.M. The following requirements apply in board vessels in service: The vehicle shall not be started on board.
210 342 (3)	Use of the cargo heating system	Not applicable to vessels in service of Type N open.
210 351 (3)	Live sockets for Type G and Type N vessels	N.R.M.
210 381 (1)(h)	Damage control plan: Type G	N.R.M.
210 381 (1)(i)	Documents concerning intact stability	N.R.M.
210 422 (1)	Opening of openings Type N open	N.R.M. On board vessels in service cargo tank hatches may be opened during loading for control and sampling.
311 200 (3)(d) 321 200 (3)(d) 331 200 (3)(d)	Fire-resistant materials of accommodation and wheelhouse	N.R.M.
331 208 (1) in conjunction with 210 208	Continuation of class for Type N open vessels with flame-traps and Type N open vessels	N.R.M. The following requirements apply on board vessels in service: Except where otherwise provided, the type of construction, the strength, the subdivision, the equipment and the gear of the vessel shall conform or be equivalent to the construction requirements for classification in the highest class of a recognized classification society.

Annex D.1

Table of transitional provisions		
Marginal	Subject	Time limit and comments
311 210 (2) 321 210 (2) 331 210 (2)	Door coamings, etc.	N.R.M. The following requirements apply on board vessels in service, with the exception of Type N open vessels: This requirement may be met by fitting vertical protection walls not less than 0.50 m in height; On board vessels in service less than 50.00 m long, the height of 0.50 m may be reduced to 0.30 m in passageways leading to the deck.
311 211 (1)(b)	Ratio of length to diameter of pressure cargo tanks	Not applicable to Type G vessels whose keels were laid before 1 January 1977.
331 211 (1)(d)	Limitation of length of cargo tanks	N.R.M.
311 211 (2)(a)	Arrangement of cargo tanks Distance between cargo tanks and side walls Height of saddles, spacers	N.R.M. Not applicable to Type G vessels whose keels were laid before 1 January 1977. N.R.M. The following requirements apply on board vessels in service: Where tank volume is more than 200 m ³ or where the ratio of length to diameter is less than 7 but more than 5, the hull in the tank area shall be such that, in the event of a collision, the tanks remain intact as far as possible. This requirement shall be considered as having been met where, in the tank area, the vessel: is double-hulled with a distance of at least 80 cm between the side plating and the longitudinal bulkhead,

Annex D.1

Table of transitional provisions		
Marginal	Subject	Time limit and comments
		<p>or is designed as follows:</p> <p>(a) Between the gangboard and the top of the floorplates there shall be side stringers at regular intervals of not more than 60 cm;</p> <p>(b) The side stringers shall be supported by web frames spaced at intervals of not more than 2.00 m. The height of the web frames shall be not less than 10% of the depth and in any event not less than 30 cm. They shall be fitted with a face plate made of flat steel having a cross section of not less than 15 cm²;</p> <p>(c) The side stringers referred to in (a) shall have the same height as the web frames and be fitted with a face plate made of flat steel having a cross section of not less than 7.5 cm².</p>
311 211 (2)(b) 321 211 (2)(b) 331 211 (2)(a)	Cargo tank fastenings	N.R.M.
311 211 (2)(c) 321 211 (2)(c) 331 211 (2)(b)	Capacity of suction well	N.R.M.
311 211 (3)(a)	End bulkheads of cargo area with "A-60" insulation. Distance of 0.50 m from cargo tanks in hold spaces	N.R.M.

Annex D.1

Table of transitional provisions		
Marginal	Subject	Time limit and comments
321 211 (3)(a) 331 211 (3)(a)	Width of cofferdams of 0.60 m Hold spaces with cofferdams or "A-60" insulated bulkheads Distance of 0.50 m from cargo tanks in hold spaces	N.R.M. The following requirements apply on board vessels in service: Type C: min imum width of cofferdams: 0.50 m; Type N: min imum width of cofferdams: 0.50 m, on board vessels with a dead weight of up to 150 t: 0.40 m; Type N open: cofferdams shall not be required with deadweight up to 150 t: The distance between cargo tanks and end bulkheads of hold spaces shall be at least 0.40 m.
331 211 (4)	Passages through the end bulkheads of hold spaces	Shall not apply to Type N open vessels whose keels were laid before 1 January 1977.
331 211 (6)(a)	Form of cofferdam arranged as a pump room	Shall not apply to Type N vessels whose keels were laid before 1 January 1977.
311 211 (7) 331 211 (7)	Arrangement of service spaces located in the cargo area below decks	N.R.M.
311 211 (8) 331 211 (8)	Dimensions of openings for access to spaces within the cargo area	N.R.M.
311 211 (8) 321 211 (10) 331 211 (8)	Interval between reinforcing elements	N.R.M.
311 212 (2) 331 212 (1)	Ventilation systems in double-hull spaces and double bottoms	N.R.M.

Annex D.1

Table of transitional provisions		
Marginal	Subject	Time limit and comments
311 212 (3) 321 212 (2) 331 212 (2)	Height above the deck of the air intake for service spaces located below deck	N.R.M.
311 212 (6) 321 212 (5) 331 212 (5)	Distance of ventilation inlets from cargo area	N.R.M.
331 212 (6) 311 213 331 213	Approval of flame—arresters General stability	Shall not apply to Type N vessels whose keels were laid before 1 January 1977. N.R.M.
311 214 331 214	Intact stability	N.R.M.
311 215	Stability after damage	N.R.M.
311 216 (1) 331 216 (1)	Distance of openings of engine rooms from the cargo area	N.R.M.
331 216 (1)	Internal combustion engines outside the cargo area for Type N open vessels	N.R.M.
311 216 (2) 331 216 (2)	Hinges of doors facing the cargo area Engine rooms accessible from the deck for Type N open vessels	Shall not apply to vessels whose keels were laid before 1 January 1977 where alterations would obstruct other major openings. N.R.M.

Annex D.1

Table of transitional provisions		
Marginal	Subject	Time limit and comments
311 217 (1) 331 217 (1)	Accommodation and wheelhouse outside the cargo area Type N open	Shall not apply to vessels whose keels were laid before 1 January 1977, provided that there is no connection between the wheelhouse and other enclosed spaces. Shall not apply to vessels up to 50 m in length whose keels were laid before 1 January 1977 and whose wheelhouses are located in the cargo area even if it provides access to another enclosed space, provided that safety is ensured by appropriate service requirements of the competent authority. N.R.M.
311 217 (2) 321 217 (2) 331 217 (2)	Arrangement of entrances and openings of forward superstructures Entrances facing the cargo area Entrances and openings on Type N open vessels	N.R.M. Shall not apply to vessels up to 50.00 m in length whose keels were laid before 1 January 1977, provided that gas screens are installed. N.R.M.
331 217 (3)	Entrances and openings must be capable of being closed: Type N open	N.R.M.
311 217 (4) 331 217 (4)	Distance of openings from the cargo area	N.R.M.
331 217 (5) (b), (c)	Approval of shaft passages and displaying of instructions Type N open	N.R.M.

Annex D.1

Table of transitional provisions		
Marginal	Subject	Time limit and comments
311 217 (6) 331 217 (6)	Pump—room below deck	N.R.M. The following requirements apply on board vessels in service: Pump—rooms below deck shall meet the requirements for service spaces: for Type G vessels: marg. 311 212 (3) for Type N vessels: marg. 331 212 (2)
321 220 (1) 331 220 (1)	Access and ventilation openings 0.50 m above the deck	N.R.M.
321 220 (2) 331 220 (2)	Intake valve	N.R.M.
331 220 (2)	Filling of cofferdams with pump Type N open	N.R.M.
321 220 (2) 331 220 (2)	Filling of cofferdams within 30 minutes	N.R.M.
331 221 (1)(b)	Liquid level gauge Type N open with flame—trap Type N open	N.R.M.
331 221 (1)(c) 331 221 (1)(d) 321 221 (1)(d) 331 221 (1)(d)	Level alarm device Sensor for actuating the facility against overflowing	Not applicable to open Type N vessels in service permitted only to carry sulphur in the molten state, UN No. 2448. Applicable only to vessels to be loaded in a Contracting Party where the share in stallation is equipped accordingly.

Annex D.1

Table of transitional provisions		
Marginal	Subject	Time limit and comments
321 221 (1)(e)	Alarm of the instrument for measuring the pressure in each cargo tank in the event of the carriage of substances for which deck spraying is required	Renewal of certificate of approval after 1 January 1999.
321 221 (1)(f) 331 221 (1)(f)	Installation of the instrument for measuring the temperature	Renewal of certificate of approval after 1 January 1999.
331 221 (1)(g)	Sampling opening Type N open	N.R.M.
311 221 (4) 321 221 (4) 331 221 (4)	Independent liquid-level alarm device	N.R.M.
311 221 (5) 321 221 (5) 331 221 (5)	Socket close to the shore connections and cut-out of vessel's pump	N.R.M.
331 221 (5)(c)	Rapid closure device enabling the supply to be shut off	31 December 2003
311 221 (7) 321 221 (7) 331 221 (7)	Alarms for over-pressure, vacuum and temperature in cargo tanks	N.R.M.
331 221 (12)	Self-closing lid	N.R.M.
331 222 (1)(b)	Cargo tank openings 0.50 m above the deck	Shall not apply to vessels whose keels were laid before 1 January 1977.
311 222 (3) 321 222 (4)(b) 331 222 (4)(b)	Position of outlets of valves above the deck	N.R.M.
321 222 (4)(b) 331 222 (4)(b)	Pressure setting of high-velocity vent valves	N.R.M.

Annex D.1

Table of transitional provisions		
Marginal	Subject	Time limit and comments
331 223 (2)	Test pressure for cargo tanks	Shall not apply to vessels whose keels were laid before 1 January 1977, for which a test pressure of 15 kPa (0.15 bar) is required. A test pressure of 10 kPa (0.10 bar) shall be sufficient.
331 223 (3)	Test pressure for pipes for loading and unloading	On board oil-separator vessels in service before 1 January 1999 a test pressure of 400 kPa is sufficient.
321 225 (1) 331 225 (1)	Shut-down of cargo pumps	N.R.M.
311 225 (1) 321 225 (1) 331 225 (1)	Distance of pumps, etc. from accommodation, etc.	N.R.M.
331 225 (2)(a)	Pipes for loading and unloading located in the below-deck area	N.R.M. for oil-separator vessels.
311 225 (2)(d) 321 225 (2)(d)	Position of loading and unloading pipes on deck	N.R.M.
311 225 (2)(e) 321 225 (2)(e) 331 225 (2)(e)	Distance of shore connections from accommodation, etc.	N.R.M.
311 225 (2)(i) 311 225 (2)(j) 311 225 (2)(k)	Position of cargo piping	N.R.M.
331 225 (8)(a)	Ballasting suction pipes located within the cargo area but outside the cargo tanks	N.R.M.
311 227 (2)	Refrigeration system List of 12° instead of 10°	N.R.M.
311 231 (2) 321 231 (2) 331 231 (2)	Distance of engine air intakes from the cargo area	N.R.M.

Annex D.1

Table of transitional provisions		
Marginal	Subject	Time limit and comments
311 231 (4) 321 231 (4) 331 231 (4)	Temperature of outer parts of engines, etc.	N.R.M. The following requirements apply on board vessels in service: the temperature of outer parts shall not exceed 300 °C.
311 231 (5) 321 231 (5) 331 231 (5)	Temperature in the engine room	N.R.M. The following requirements apply on board vessels in service: the temperature in the engine room shall not exceed 45 °C.
311 232 (2) 321 232 (2) 331 232 (2)	Ventilation pipes 0.50 m above the deck	N.R.M.
331 234 (1)	Exhaust pipes	N.R.M.
311 235 (1) 331 235 (1)	Stripping and ballast pumps in the cargo area	N.R.M.
331 235 (3)	Suction pipes for ballasting located within the cargo area but outside the cargo tanks	N.R.M.
311 240 (1) 321 240 (1) 331 240 (1)	Fire extinguishing systems, two pumps, etc.	N.R.M.
311 240 (2) 321 240 (2) 331 240 (2)	Fixed fire extinguishing system in engine room	N.R.M.
311 241 (1) 331 241 (1)	Outlets of funnels located not less than 2 m from the cargo area	Not applicable to vessels whose keels were laid before 1 January 1977.
331 241 (1)	Outlets of funnels	N.R.M. for oil-separator vessels.

Annex D.1

Table of transitional provisions		
Marginal	Subject	Time limit and comments
311 241 (2) 321 241 (2) 331 241 (2) in conjunction with 210 341	Heating cooking and refrigerating appliances	N.R.M.
331 242 (2)	Cargo heating system: Type N open	N.R.M. The following requirements apply on board vessels in service: This can be achieved by an oil separator fitted to the condensed water return pipe.
311 251 (2) 321 251 (2) 331 251 (2) 311 251 (3) 321 251 (3) 331 251 (3)	Visual and audible alarm Temperature class and explosion group	N.R.M. N.R.M.
331 252 (1)(b) 331 252 (1)(c) 331 252 (1)(d) 331 252 (1)(e)	Electrical installations: Type N open	N.R.M.

Table of transitional provisions		
Marginal	Subject	Time limit and comments
311 252 (1)(e) 331 252 (1)(e)	Electrical installations of the “certified safe” type in the cargo area	<p>Shall not apply to vessels whose keels were laid before 1 January 1977. The following conditions shall be met during loading, unloading and gas-freeing on board vessels having non-gast ight wheelhouse openings (e.g. doors, windows, etc.) giving on to the cargo area:</p> <p>(a) All electrical installations designed to be used shall be of a limited explosion-risk type, i.e. they shall be so designed that there is no sparking under normal operating conditions and the temperature of their outer surfaces does not rise above 200° C, or be of a type protected against water spray the temperature of whose outer surfaces does not exceed 200° C under normal operating conditions;</p> <p>(b) Electrical installations which do not meet the requirements of (a) above shall be marked in red and it shall be possible to switch them off by means of a central switch.</p>
331 252 (2)	Accumulators located outside the cargo area	N.R.M.
311 252 (3)(a) 311 252 (3)(b) 331 252 (3)(a) 331 252 (3)(b)	Electrical installations used during loading unloading or gas-freeing	<p>Shall not apply to the following installations on vessels whose keels were laid before 1 January 1977:</p> <p>Lighting installations in accommodation, with the exception of switches near the entrances to accommodation;</p> <p>radio telephone installations in accommodation and wheelhouses and combustion engine control appliances.</p>
	Type N open	<p>All other electrical installations shall meet the following requirements:</p> <p>(a) Generators, engines, etc. P13 protection mode</p> <p>(b) Control panels, lamps, etc. IP23 protection mode</p> <p>(c) Appliances, etc. IP55 protection mode.</p> <p>N.R.M.</p>

Annex D.1

Table of transitional provisions		
Marginal	Subject	Time limit and comments
311 252 (3)(b) 321 252 (3)(b) 331 252 (3)(b) in conjunction with paragraph (3)(a)	Electrical installations used during loading unloading and gas-freeing	N.R.M. On board vessels in service, paragraph (3) (a) shall not apply to: Lighting installations in accommodation, with the exception of switches near entrances to accommodation; Radiotelephone installations in accommodation and wheelhouses.
311 252 (4) 321 252 (4) 331 252 (4) last sentence	Disconnection of such installations from a centralized location	N.R.M.
331 252 (4)	Red mark on electrical installations Type N open	N.R.M.
331 252 (5)	Cut-out switch for continuously driven generator: Type N open	N.R.M.
331 252 (6)	Permanently fitted sockets: Type N open	N.R.M.
311 256 (1) 331 256 (1)	Metallic sheaths for all cables	Shall not apply to vessels whose keels were laid before 1 January 1977.
331 256 (1)	Metallic sheath	N.R.M. for oil-separator vessels.
311 256 (3) 321 256 (3) 331 256 (3)	Movable cables in the cargo area	N.R.M.

3. The goods for which Type N open, Type N closed with a minimum valve setting of 10 kPa (0.10 bar) is required in the list of substances (Annex B.2, Appendix 4) may be carried in tank-vessels in service of Type N closed with a minimum valve setting of 6 kPa (0.06 bar) (cargo tank test pressure of 10 kPa (0.10 bar)).

4. Vessels carrying only the dangerous goods referred to below shall be subject to this Agreement as from 1 January 2005 only:

Annex D.1

Classe 4.1 3175 solids or mixtures of solids (such as preparations or wastes) containing flammable liquid n.o.s. having a flashpoint up to 61 °C of 4° (c);

1350 sulphur (also flowers of sulphur) of 11° (c);

Class 4.2 substances of 3° (c) and 16° (c) in bulk;

Class 9 2969 castor beans of 35° (b).

Vessels must, however, still meet the requirements of marginals 10 011(2) and 10 351(4) of Annex B.1.

Annex D.1

(RESERVED)

ANNEX D.2

Supplementary transitional provisions applicable to specific inland waterways

(RESERVED)

Annex D.2

Annex D.2 - SUPPLEMENTARY TRANSITIONAL PROVISIONS APPLICABLE TO SPECIFIC INLAND WATERWAYS

1. In this Annex D.2:

- “Vessel in service” means a vessel according to Article 8, paragraph 3 of the Agreement;
- “N.R.M.” means that the requirement does not apply to vessels in service except where the parts concerned are replaced or modified, i.e. it applies only to vessels which are new, or to parts which are replaced or modified; where existing parts are replaced by spare or replacement parts of the same type and manufacture, this shall not be considered a replacement “R” as defined in these transitional provisions.

Modification shall also be taken to mean the conversion of a type of tank vessel, a type of cargo tank or a category of cargo tank to another type or category at a higher level.

2. Vessels in service to which the transitional provisions of this Annex are applied shall meet:

- the requirements of marginals and, where necessary, paragraphs and subparagraphs mentioned in the table below and in the table of general transitional provisions within the period established therein;
- the requirements of marginals and, where necessary, paragraphs and subparagraphs not mentioned in the table below or in the table of general transitional provisions at the date of application of these Regulations.

The construction and equipment of vessels in service shall be maintained at least at the previous standard of safety.

Annex D.2

<u>Table of transitional provisions</u>		
Marginal	Subject	Time limit and comments
110 211 (1) (b)	Holds, common bulkheads with oil fuel tanks	<p>N.R.M.</p> <p>The following requirements apply on board vessels in service:</p> <p>Holds may share a common bulkhead with the oil fuel tanks, provided that the cargo or its packaging does not react chemically with the fuel.</p>
110 292	Emergency exit	<p>N.R.M.</p> <p>The following requirements apply on board vessels in service:</p> <p>Spaces the entrances or exits of which are partly or fully immersed in damaged condition shall be provided with an emergency exit not less than 0.075 m above the damage waterline.</p>

Annex D.2

<u>Table of transitional provisions</u>		
Marginal	Subject	Time limit and comments
110 295 (1) (c)	Height of openings above damage waterline	N.R.M. The following requirements apply on board vessels in service: The lower edge of any non watertight openings (e.g. doors, windows, access hatchways) shall, at the final stage of flooding, be not less than 0.075 m above the damage waterline.
110 295 (2) 321 215 (2)	Extent of the stability diagram (damaged condition).	N.R.M. The following requirements apply on board vessels in service: At the final stage of flooding the angle of heel shall not exceed: 20° before measures to right the vessel; 12° following measures to right the vessel.
210 208 (1)	Classification of Type N open vessels	N.R.M.

Annex D.2

Table of transitional provisions		
Marginal	Subject	Time limit and comments
311 211 (1) (a) 321 211 (1) (a) 331 211 (1) (a)	Maximum capacity of cargo tanks.	N.R.M. The following requirements apply on board vessels in service: The maximum permissible capacity of a cargo tank shall be 760 m ³ .
311 212 (3) 321 212 (2) 331 212 (2)	Position of air inlets	N.R.M. The following requirements apply on board vessels in service: The air inlets to be positioned at least 5.00 m from the safety-valve outlets
321 211 (1) (d)	Length of cargo tanks	N.R.M. The following requirements apply on board vessels in service: The length of a cargo tank may exceed 10 m and 0.2 L.
331 208 (1)	Classification of Type N open vessels	N.R.M.

Annex D.2

Table of transitional provisions		
Marginal	Subject	Time limit and comments
321 215 (1) (c)	Height of openings above damage waterline	N.R.M. The following requirements apply on board vessels in service: The lower edge of any non watertight openings (e.g. doors, windows, access hatchways) shall, at the final stage of flooding, be not less than 0.075 m above the damage waterline.
321 220 (2) 331 220 (2)	Filling of cofferdams with water	N.R.M. The following requirements apply on board vessels in service: Cofferdams shall be fitted with a system for filling with water or inert gas.
311 292 321 292	Emergency Exit	N.R.M. The following requirements apply on board vessels in service: Spaces the entrances or exits of which are partly or fully immersed in damaged condition shall be provided with an emergency exit not less than 0.075 m above the damage waterline.

Annex D.2
