

PART 6

Requirements for the construction and testing of packagings, intermediate bulk containers (IBCs), large packagings and tanks

CHAPTER 6.1

REQUIREMENTS FOR THE CONSTRUCTION AND TESTING OF PACKAGINGS

6.1.1 General

6.1.1.1 The requirements of this Chapter do not apply to:

- (a) Packages containing radioactive material of Class 7, unless otherwise provided (see 4.1.9);
- (b) Packages containing infectious substances of Class 6.2, unless otherwise provided (see Chapter 6.3, Note and packing instruction P621 of 4.1.4.1);
- (c) Pressure receptacles containing gases of Class 2;
- (d) Packages whose net mass exceeds 400 kg;
- (e) Packagings with a capacity exceeding 450 litres.

6.1.1.2 The requirements for packagings in 6.1.4 are based on packagings currently used. In order to take into account progress in science and technology, there is no objection to the use of packagings having specifications different from those in 6.1.4, provided that they are equally effective, acceptable to the competent authority and able successfully to withstand the tests described in 6.1.1.3 and 6.1.5. Methods of testing other than those described in this Chapter are acceptable, provided they are equivalent, and are recognized by the competent authority.

6.1.1.3 Every packaging intended to contain liquids shall successfully undergo a suitable leakproofness test, and be capable of meeting the appropriate test level indicated in 6.1.5.4.3:

- (a) before it is first used for carriage;
- (b) after remanufacturing or reconditioning, before it is re-used for carriage;

For this test, packagings need not have their own closures fitted.

The inner receptacle of composite packagings may be tested without the outer packaging provided the test results are not affected.

This test is not necessary for:

- inner packagings of combination packagings;
- inner receptacles of composite packagings (glass, porcelain or stoneware), marked with the symbol "RID/ADR" according to 6.1.3.1 (a) (ii);
- light gauge metal packagings, marked with the symbol "RID/ADR" according to 6.1.3.1 (a) (ii).

6.1.1.4 Packagings shall be manufactured, reconditioned and tested under a quality assurance programme which satisfies the competent authority in order to ensure that each packaging meets the requirements of this Chapter.

6.1.1.5 Manufacturers and subsequent distributors of packagings shall provide information regarding procedures to be followed and a description of the types and dimensions of closures

(including required gaskets) and any other components needed to ensure that packages as presented for carriage are capable of passing the applicable performance tests of this Chapter.

6.1.2 Code for designating types of packagings

6.1.2.1 The code consists of:

- (a) an Arabic numeral indicating the kind of packaging, e.g. drum, jerrican, etc., followed by;
- (b) a capital letter(s) in Latin characters indicating the nature of the material, e.g. steel, wood, etc., followed where necessary by;
- (c) an Arabic numeral indicating the category of packaging within the kind to which the packaging belongs.

6.1.2.2 In the case of composite packagings, two capital letters in Latin characters are used in sequence in the second position of the code. The first indicates the material of the inner receptacle and the second that of the outer packaging.

6.1.2.3 In the case of combination packagings only the code number for the outer packaging is used.

6.1.2.4 The letters "T", "V" or "W" may follow the packaging code. The letter "T" signifies a salvage packaging conforming to the requirements of 6.1.5.1.11. The letter "V" signifies a special packaging conforming to the requirements of 6.1.5.1.7. The letter "W" signifies that the packaging, although of the same type indicated by the code, is manufactured to a specification different to that in 6.1.4 and is considered equivalent under the requirements of 6.1.1.2.

6.1.2.5 The following numerals shall be used for the kinds of packaging:

1. Drum
2. Wooden barrel
3. Jerrican
4. Box
5. Bag
6. Composite packaging
7. (reserved)
0. Light gauge metal packagings

6.1.2.6 The following capital letters shall be used for the types of material:

- A. Steel (all types and surface treatments)
- B. Aluminium
- C. Natural wood
- D. Plywood
- F. Reconstituted wood
- G. Fibreboard
- H. Plastics material
- L. Textile
- M. Paper, multiwall
- N. Metal (other than steel or aluminium)
- P. Glass, porcelain or stoneware

6.1.2.7

The following table indicates the codes to be used for designating types of packagings depending on the kind of packagings, the material used for their construction and their category; it also refers to the sub-sections to be consulted for the appropriate requirements:

Kind	Material	Category	Code	Sub-section
1. Drums	A. Steel	non-removable head	1A1	6.1.4.1
		removable head	1A2	
	B. Aluminium	non-removable head	1B1	6.1.4.2
		removable head	1B2	
	D. Plywood		1D	6.1.4.5
	G. Fibre		1G	6.1.4.7
	H. Plastics	non-removable head	1H1	6.1.4.8
		removable head	1H2	
	N. Metal, other than steel or aluminium	non-removable head	1N1	6.1.4.3
		removable head	1N2	
2. Barrels	C. Wooden	bung type	2C1	6.1.4.6
		removable head	2C2	
3. Jerricans	A. Steel	non-removable head	3A1	6.1.4.4
		removable head	3A2	
	B. Aluminium	non-removable head	3B1	6.1.4.4
		removable head	3B2	
	H. Plastics	non-removable head	3H1	6.1.4.8
		removable head	3H2	
4. Boxes	A. Steel		4A	6.1.4.14
	B. Aluminium		4B	6.1.4.14
	C. Natural wood	ordinary	4C1	6.1.4.9
		with sift-proof walls	4C2	
	D. Plywood		4D	6.1.4.10
	F. Reconstituted wood		4F	6.1.4.11
	G. Fibreboard		4G	6.1.4.12
	H. Plastics	expanded	4H1	6.1.4.13
solid		4H2		
5. Bags	H. Woven plastics	without inner liner or coating	5H1	6.1.4.16
		sift-proof	5H2	
		water resistant	5H3	
	H. Plastics film		5H4	6.1.4.17
	L. Textile	without inner liner or coating	5L1	6.1.4.15
		sift-proof	5L2	
		water resistant	5L3	
	M. Paper	multiwall	5M1	6.1.4.18
		multiwall, water resistant	5M2	

Kind	Material	Category	Code	Sub-section
6. Composite packagings	H. Plastics receptacle	with outer steel drum	6HA1	6.1.4.19
		with outer steel crate or box	6HA2	6.1.4.19
		with outer aluminium drum	6HB1	6.1.4.19
		with outer aluminium crate or box	6HB2	6.1.4.19
		with outer wooden box	6HC	6.1.4.19
		with outer plywood drum	6HD1	6.1.4.19
		with outer plywood box	6HD2	6.1.4.19
		with outer fibre drum	6HG1	6.1.4.19
		with outer fibreboard box	6HG2	6.1.4.19
		with outer plastics drum	6HH1	6.1.4.19
		with outer solid plastics box	6HH2	6.1.4.19
	P. Glass, porcelain or stoneware receptacle	with outer steel drum	6PA1	6.1.4.20
		with outer steel crate or box	6PA2	6.1.4.20
		with outer aluminium drum	6PB1	6.1.4.20
		with outer aluminium crate or box	6PB2	6.1.4.20
		with outer wooden box	6PC	6.1.4.20
		with outer plywood drum	6PD1	6.1.4.20
		with outer wickerwork hamper	6PD2	6.1.4.20
		with outer fibre drum	6PG1	6.1.4.20
		with outer fibreboard box	6PG2	6.1.4.20
		with outer expanded plastics packaging	6PH1	6.1.4.20
		with outer solid plastics packaging	6PH2	6.1.4.20
0. Light gauge metal packagings	A. Steel	non-removable head	0A1	6.1.4.22
		removable head	0A2	

6.1.3

Marking

NOTE 1: The marking indicates that the packaging which bears it corresponds to a successfully tested design type and that it complies with the requirements of this Chapter which are related to the manufacture, but not to the use, of the packaging. In itself, therefore, the mark does not necessarily confirm that the packaging may be used for any substance: generally the type of packaging (e.g. steel drum), its maximum capacity and/or mass, and any special requirements are specified for each substance in Table A of Chapter 3.2.

NOTE 2: The marking is intended to be of assistance to packaging manufacturers, reconditioners, packaging users, carriers and regulatory authorities. In relation to the use of a new packaging, the original marking is a means for its manufacturer(s) to identify the type and to indicate those performance test regulations that have been met.

NOTE 3: The marking does not always provide full details of the test levels, etc., and these may need to be taken further into account, e.g. by reference to a test certificate, to test reports or to a register of successfully tested packagings. For example, a packaging having an X or Y marking may be used for substances to which a packing group having a lesser degree of danger has been assigned with the relevant maximum permissible value of the relative density¹ determined by taking into account the factor 1.5 or 2.25 indicated in the packaging test requirements in 6.1.5 as appropriate, i.e. packing group I packaging tested for products of relative density 1.2 could be used as a packing group II packaging for products of relative density 1.8 or a packing group III packaging for products of relative density 2.7, provided of course that all the performance criteria can still be met with the higher relative density product.

6.1.3.1

Each packaging intended for use according to the ADR shall bear markings which are durable, legible and placed in a location and of such a size relative to the packaging as to be readily visible. For packages with a gross mass of more than 30 kg, the markings or a duplicate thereof shall appear on the top or on a side of the packaging. Letters, numerals and symbols shall be at least 12 mm high, except for packagings of 30 litres or 30 kg capacity or less, when they shall be at least 6 mm in height and for packagings of 5 litres or 5 kg or less when they shall be of an appropriate size.

The marking shall show:

- (a) (i) The United Nations packaging symbol



This shall not be used for any purpose other than certifying that a packaging complies with the relevant requirements in this Chapter. For embossed metal packagings the capital letters "UN" may be applied instead of the symbol; or

- (ii) The symbol "RID/ADR" for packagings approved for rail transport as well as road transport.

For composite packagings (glass, porcelain or stoneware) and light gauge metal packagings, conforming to simplified conditions (see 6.1.1.3, 6.1.5.3.1 (e), 6.1.5.3.4 (c), 6.1.5.4, 6.1.5.5.1 and 6.1.5.6);

- (b) The code designating the type of packaging according to 6.1.2;

¹ Relative density (*d*) is considered to be synonymous with Specific Gravity (*SG*) and is used throughout this text.

- (c) A code in two parts:
- (i) a letter designating the packing group(s) for which the design type has been successfully tested:

X for packing groups I, II and III;
 Y for packing groups II and III;
 Z for packing group III only;

- (ii) the relative density, rounded off to the first decimal, for which the design type has been tested for packagings without inner packagings intended to contain liquids; this may be omitted when the relative density does not exceed 1.2. For packagings intended to contain solids or inner packagings, the maximum gross mass in kilograms.

For light-gauge metal packagings, marked with the symbol "RID/ADR" according to 6.1.3.1 (a) (ii) intended to contain liquids having a viscosity at 23 °C exceeding 200 mm²/s, the maximum gross mass in kg;

- (d) Either the letter "S" denoting that the packaging is intended for the carriage of solids or inner packagings or, for packagings (other than combination packagings) intended to contain liquids, the hydraulic test pressure which the packaging was shown to withstand in kPa rounded down to the nearest 10 kPa.

For light-gauge metal packagings, marked with the symbol "RID/ADR, according to 6.1.3.1(a) (ii) intended to contain liquids having a viscosity at 23 °C exceeding 200 mm²/s, the letter "S";

NOTE: The requirements of subparagraph (d) do not apply to packagings intended for the carriage of substances classified under UN Nos. 2814 or 2900 of Class 6.2.

- (e) The last two digits of the year during which the packaging was manufactured. Packagings of types 1H and 3H shall also be appropriately marked with the month of manufacture; this may be marked on the packaging in a different place from the remainder of the marking. An appropriate method is:

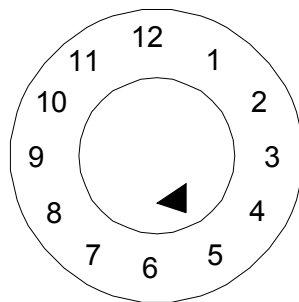

- (f) The State authorizing the allocation of the mark, indicated by the distinguishing sign for motor vehicles in international traffic ²
- (g) The name of the manufacturer or other identification of the packaging specified by the competent authority.

² Distinguishing sign for motor vehicles in international traffic prescribed in Vienna Convention on Road Traffic (1968).





- 6.1.3.2 In addition to the durable markings prescribed in 6.1.3.1, every new metal drum of a capacity greater than 100 litres shall bear the marks described in 6.1.3.1 (a) to (e) on the bottom, with an indication of the nominal thickness of at least the metal used in the body (in mm, to 0.1 mm), in permanent form (e.g. embossed). When the nominal thickness of either head of a metal drum is thinner than that of the body, the nominal thickness of the top head, body, and bottom head shall be marked on the bottom in permanent form (e.g. embossed), for example "1.0-1.2-1.0" or "0.9-1.0-1.0". Nominal thickness of metal shall be determined according to the appropriate ISO standard, for example ISO 3574:1999 for steel. The marks indicated in 6.1.3.1 (f) and (g) shall not be applied in a permanent form except as provided in 6.1.3.5.
- 6.1.3.3 Every packaging other than those referred to in 6.1.3.2 liable to undergo a reconditioning process shall bear the marks indicated in 6.1.3.1 (a) to (e) in a permanent form. Marks are permanent if they are able to withstand the reconditioning process (e.g. embossed). For packagings other than metal drums of a capacity greater than 100 litres, these permanent marks may replace the corresponding durable markings prescribed in 6.1.3.1.
- 6.1.3.4 For remanufactured metal drums, if there is no change to the packaging type and no replacement or removal of integral structural components, the required markings need not be permanent. Every other remanufactured metal drum shall bear the markings in 6.1.3.1 (a) to (e) in a permanent form (e.g. embossed) on the top head or side.
- 6.1.3.5 Metal drums made from materials (e.g. stainless steel) designed to be reused repeatedly may bear the markings indicated in 6.1.3.1 (f) and (g) in a permanent form (e.g. embossed).
- 6.1.3.6 The marking in accordance with 6.1.3.1 is valid for only one design type or series of design types. Different surface treatments may fall within the same design type.
- A "series of design types" means packagings of the same structural design, wall thickness, material and cross-section, which differ only in their lesser design heights from the design type approved.
- The closures of receptacles shall be identifiable as those referred to in the test report.
- 6.1.3.7 Marking shall be applied in the sequence of the sub-paragraphs in 6.1.3.1; each element of the marking required in these sub-paragraphs and when appropriate sub-paragraphs (h) to (j) of 6.1.3.8 shall be clearly separated, e.g. by a slash or space, so as to be easily identifiable. For examples, see 6.1.3.11.
- Any additional markings authorized by a competent authority shall still enable the parts of the mark to be correctly identified with reference to 6.1.3.1.
- 6.1.3.8 After reconditioning a packaging, the reconditioner shall apply to it a durable marking showing, in the following sequence:
- (h) The State in which the reconditioning was carried out, indicated by the distinguishing sign for motor vehicles in international traffic ²;
 - (i) The name of the reconditioner or other identification of the packaging specified by the competent authority;
 - (j) The year of reconditioning; the letter "R"; and, for every packaging successfully passing the leakproofness test in 6.1.1.3, the additional letter "L".

² *Distinguishing sign for motor vehicles in international traffic prescribed in Vienna Convention on Road Traffic (1968).*



6.1.3.9 When, after reconditioning, the markings required by 6.1.3.1 (a) to (d) no longer appear on the top head or the side of a metal drum, the reconditioner also shall apply them in a durable form followed by 6.1.3.8 (h), (i) and (j). These markings shall not identify a greater performance capability than that for which the original design type had been tested and marked.

6.1.3.10 Packagings manufactured with recycled plastics material as defined in 1.2.1 shall be marked "REC". This mark shall be placed near the mark prescribed in 6.1.3.1.

6.1.3.11 Examples of markings for NEW packagings

	4G/Y145/S/83 NL/VL823	as in 6.1.3.1 (a) (i), (b), (c), (d) and (e) as in 6.1.3.1 (f) and (g)	For a new fibreboard box
	1A1/Y1.4/150/83 NL/VL824	as in 6.1.3.1 (a) (i), (b), (c), (d) and (e) as in 6.1.3.1 (f) and (g)	For a new steel drum to contain liquids
	1A2/Y150/S/83 NL/VL825	as in 6.1.3.1 (a) (i), (b), (c), (d) and (e) as in 6.1.3.1 (f) and (g)	For a new steel drum to contain solids, or inner packagings
	4HW/Y136/S/83 NL/VL826	as in 6.1.3.1 (a) (i), (b), (c), (d) and (e) as in 6.1.3.1 (f) and (g)	For a new plastics box of equivalent specification
	1A2/Y/100/91 USA/MM5	as in 6.1.3.1 (a) (i), (b), (c), (d) and (e) as in 6.1.3.1 (f) and (g)	For a remanufactured steel drum to contain liquids
	RID/ADR/0A1/100/83 NL/VL123	as in 6.1.3.1 (a) (ii), (b), (c), (d) and (e) as in 6.1.3.1 (f) and (g)	For a new light gauge metal packaging, non-removable head
	RID/ADR/0A2/Y20/S/83 NL/VL124	as in 6.1.3.1 (a) (ii), (b), (c), (d) and (e) as in 6.1.3.1 (f) and (g)	For a new light gauge metal packaging, removable head, intended to contain solids, or liquids with a viscosity at 23 °C exceeding 200 mm ² /s.

6.1.3.12 Examples of markings for RECONDITIONED packagings

	1A1/Y1.4/150/83 NL/RB/85 RL	as in 6.1.3.1 (a) (i), (b), (c), (d) and (e) as in 6.1.3.8 (h), (i) and (j)
	1A2/Y150/S/83 USA/RB/85 R	as in 6.1.3.1 (a) (i), (b), (c), (d) and (e) as in 6.1.3.8 (h), (i) and (j)

6.1.3.13 Example of marking for SALVAGE packagings

	1A2T/Y300/S/94 USA/abc	as in 6.1.3.1 (a) (i), (b), (c), (d) and (e) as in 6.1.3.1 (f) and (g)
---	---------------------------	---

NOTE: The markings, for which examples are given in 6.1.3.11, 6.1.3.12 and 6.1.3.13 may be applied in a single line or in multiple lines provided the correct sequence is respected.

6.1.3.14 *Certification*

By affixing marking in accordance with 6.1.3.1, it is certified that mass-produced packagings correspond to the approved design type and that the requirements referred to in the approval have been met.

6.1.4 **Requirements for packagings**

6.1.4.1 *Steel drums*

- 1A1 non-removable head
- 1A2 removable head

6.1.4.1.1 Body and heads shall be constructed of steel sheet of a suitable type and of adequate thickness in relation to the capacity of the drum and to its intended use.

6.1.4.1.2 Body seams shall be welded on drums intended to contain more than 40 litres of liquid. Body seams shall be mechanically seamed or welded on drums intended to contain solids or 40 litres or less of liquids.

6.1.4.1.3 Chimes shall be mechanically seamed or welded. Separate reinforcing rings may be applied.

6.1.4.1.4 The body of a drum of a capacity greater than 60 litres shall, in general, have at least two expanded rolling hoops or, alternatively, at least two separate rolling hoops. If there are separate rolling hoops they shall be fitted tightly on the body and so secured that they cannot shift. Rolling hoops shall not be spot welded.

6.1.4.1.5 Openings for filling, emptying and venting in the bodies or heads of non-removable head (1A1) drums shall not exceed 7 cm in diameter. Drums with larger openings are considered to be of the removable head type (1A2). Closures for openings in the bodies and heads of drums shall be so designed and applied that they will remain secure and leakproof under normal conditions of carriage. Closure flanges may be mechanically seamed or welded in place. Gaskets or other sealing elements shall be used with closures, unless the closure is inherently leakproof.

6.1.4.1.6 Closure devices for removable head (1A2) drums shall be so designed and applied that they will remain secure and drums will remain leakproof under normal conditions of carriage. Gaskets or other sealing elements shall be used with all removable heads.

6.1.4.1.7 If materials used for body, heads, closures and fittings are not in themselves compatible with the contents to be carried, suitable internal protective coatings or treatments shall be applied. These coatings or treatments shall retain their protective properties under normal conditions of carriage.

6.1.4.1.8 Maximum capacity of drum: 450 litres.

6.1.4.1.9 Maximum net mass: 400 kg.

6.1.4.2 *Aluminium drums*

- 1B1 non-removable head
- 1B2 removable head

6.1.4.2.1 Body and heads shall be constructed of aluminium at least 99% pure or of an aluminium base alloy. Material shall be of a suitable type and of adequate thickness in relation to the capacity of the drum and to its intended use.

- 6.1.4.2.2 All seams shall be welded. Chime seams, if any, shall be reinforced by the application of separate reinforcing rings.
- 6.1.4.2.3 The body of a drum of a capacity greater than 60 litres shall, in general, have at least two expanded rolling hoops or, alternatively, at least two separate rolling hoops. If there are separate rolling hoops they shall be fitted tightly on the body and so secured that they cannot shift. Rolling hoops shall not be spot welded.
- 6.1.4.2.4 Openings for filling, emptying and venting in the bodies or heads of non-removable head (1B1) drums shall not exceed 7 cm in diameter. Drums with larger openings are considered to be of the removable head type (1B2). Closures for openings in the bodies and heads of drums shall be so designed and applied that they will remain secure and leakproof under normal conditions of carriage. Closure flanges shall be welded in place so that the weld provides a leakproof seam. Gaskets or other sealing elements shall be used with closures, unless the closure is inherently leakproof.
- 6.1.4.2.5 Closure devices for removable head (1B2) drums shall be so designed and applied that they will remain secure and drums will remain leakproof under normal conditions of carriage. Gaskets or other sealing elements shall be used with all removable heads.
- 6.1.4.2.6 Maximum capacity of drum: 450 litres.
- 6.1.4.2.7 Maximum net mass: 400 kg.
- 6.1.4.3 *Drums of metal other than aluminium or steel***
- 1N1 non-removable head
1N2 removable head
- 6.1.4.3.1 The body and heads shall be constructed of a metal or of a metal alloy other than steel or aluminium. Material shall be of a suitable type and of adequate thickness in relation to the capacity of the drum and to its intended use.
- 6.1.4.3.2 Chime seams, if any, shall be reinforced by the application of separate reinforcing rings. All seams, if any, shall be joined (welded, soldered, etc.) in accordance with the technical state of the art for the used metal or metal alloy.
- 6.1.4.3.3 The body of a drum of a capacity greater than 60 litres shall, in general, have at least two expanded rolling hoops or, alternatively, at least two separate rolling hoops. If there are separate rolling hoops they shall be fitted tightly on the body and so secured that they cannot shift. Rolling hoops shall not be spot welded.
- 6.1.4.3.4 Openings for filling, emptying and venting in the bodies or heads of non-removable head (1N1) drums shall not exceed 7 cm in diameter. Drums with larger openings are considered to be of the removable head type (1N2). Closures for openings in the bodies and heads of drums shall be so designed and applied that they will remain secure and leakproof under normal conditions of carriage. Closure flanges shall be joined in place (welded, soldered, etc.) in accordance with the technical state of the art for the used metal or metal alloy so that the seam join is leakproof. Gaskets or other sealing elements shall be used with closures, unless the closure is inherently leakproof.
- 6.1.4.3.5 Closure devices for removable head (1N2) drums shall be so designed and applied that they will remain secure and drums will remain leakproof under normal conditions of carriage. Gaskets or other sealing elements shall be used with all removable heads.

6.1.4.3.6 Maximum capacity of drum: 450 litres.

6.1.4.3.7 Maximum net mass: 400 kg.

6.1.4.4 *Steel or aluminium jerricans*

3A1 steel, non-removable head

3A2 steel, removable head

3B1 aluminium, non-removable head

3B2 aluminium, removable head

6.1.4.4.1 Body and heads shall be constructed of steel sheet, of aluminium at least 99% pure or of an aluminium base alloy. Material shall be of a suitable type and of adequate thickness in relation to the capacity of the jerrican and to its intended use.

6.1.4.4.2 Chimes of steel jerricans shall be mechanically seamed or welded. Body seams of steel jerricans intended to contain more than 40 litres of liquid shall be welded. Body seams of steel jerricans intended to contain 40 litres or less shall be mechanically seamed or welded. For aluminium jerricans, all seams shall be welded. Chime seams, if any, shall be reinforced by the application of a separate reinforcing ring.

6.1.4.4.3 Openings in non-removable head jerricans (3A1 and 3B1) shall not exceed 7 cm in diameter. Jerricans with larger openings are considered to be of the removable head type (3A2 and 3B2). Closures shall be so designed that they will remain secure and leakproof under normal conditions of carriage. Gaskets or other sealing elements shall be used with closures, unless the closure is inherently leakproof.

6.1.4.4.4 If materials used for body, heads, closures and fittings are not in themselves compatible with the contents to be carried, suitable internal protective coatings or treatments shall be applied. These coatings or treatments shall retain their protective properties under normal conditions of carriage.

6.1.4.4.5 Maximum capacity of jerrican: 60 litres.

6.1.4.4.6 Maximum net mass: 120 kg.

6.1.4.5 *Plywood drums*

1D

6.1.4.5.1 The wood used shall be well seasoned, commercially dry and free from any defect likely to lessen the effectiveness of the drum for the purpose intended. If a material other than plywood is used for the manufacture of the heads, it shall be of a quality equivalent to the plywood.

6.1.4.5.2 At least two-ply plywood shall be used for the body and at least three-ply plywood for the heads; the plies shall be firmly glued together by a water resistant adhesive with their grain crosswise.

6.1.4.5.3 The body and heads of the drum and their joints shall be of a design appropriate to the capacity of the drum and to its intended use.

6.1.4.5.4 In order to prevent sifting of the contents, lids shall be lined with kraft paper or some other equivalent material which shall be securely fastened to the lid and extend to the outside along its full circumference.

6.1.4.5.5 Maximum capacity of drum: 250 litres.

6.1.4.5.6 Maximum net mass: 400 kg.

6.1.4.6 *Wooden barrels*

2C1 bung type

2C2 removable head

6.1.4.6.1 The wood used shall be of good quality, straight grained, well seasoned and free from knots, bark, rotten wood, sapwood or other defects likely to lessen the effectiveness of the barrel for the purpose intended.

6.1.4.6.2 The body and heads shall be of a design appropriate to the capacity of the barrel and to its intended use.

6.1.4.6.3 Staves and heads shall be sawn or cleft with the grain so that no annual ring extends over more than half the thickness of a stave or head.

6.1.4.6.4 Barrel hoops shall be of steel or iron of good quality. The hoops of removable head (2C2) barrels may be of a suitable hardwood.

6.1.4.6.5 Wooden barrels 2C1: the diameter of the bunghole shall not exceed half the width of the stave in which it is placed.

6.1.4.6.6 Wooden barrels 2C2: heads shall fit tightly into the crozes.

6.1.4.6.7 Maximum capacity of barrel: 250 litres.

6.1.4.6.8 Maximum net mass: 400 kg.

6.1.4.7 *Fibre drums*

1G

6.1.4.7.1 The body of the drum shall consist of multiple plies of heavy paper or fibreboard (without corrugations) firmly glued or laminated together and may include one or more protective layers of bitumen, waxed kraft paper, metal foil, plastics material, etc.

6.1.4.7.2 Heads shall be of natural wood, fibreboard, metal, plywood, plastics or other suitable material and may include one or more protective layers of bitumen, waxed kraft paper, metal foil, plastics material, etc.

6.1.4.7.3 The body and heads of the drum and their joints shall be of a design appropriate to the capacity of the drum and to its intended use.

6.1.4.7.4 The assembled packaging shall be sufficiently water resistant so as not to delaminate under normal conditions of carriage.

6.1.4.7.5 Maximum capacity of drum: 450 litres.

6.1.4.7.6 Maximum net mass: 400 kg.

6.1.4.8 *Plastics drums and jerricans*

- 1H1 drums, non-removable head
- 1H2 drums, removable head
- 3H1 jerricans, non-removable head
- 3H2 jerricans, removable head

- 6.1.4.8.1 The packaging shall be manufactured from suitable plastics material and be of adequate strength in relation to its capacity and intended use. Except for recycled plastics material as defined in 1.2.1, no used material other than production residues or regrind from the same manufacturing process may be used. The packaging shall be adequately resistant to ageing and to degradation caused either by the substance contained or by ultra-violet radiation. Any permeation of the substance contained in the package, or recycled plastics material used to produce new packaging, shall not constitute a danger under normal conditions of carriage.
- 6.1.4.8.2 If protection against ultra-violet radiation is required, it shall be provided by the addition of carbon black or other suitable pigments or inhibitors. These additives shall be compatible with the contents and remain effective throughout the life of the packaging. Where use is made of carbon black, pigments or inhibitors other than those used in the manufacture of the tested design type, retesting may be waived if the carbon black content does not exceed 2% by mass or if the pigment content does not exceed 3% by mass; the content of inhibitors of ultra-violet radiation is not limited.
- 6.1.4.8.3 Additives serving purposes other than protection against ultra-violet radiation may be included in the composition of the plastics material provided that they do not adversely affect the chemical and physical properties of the material of the packaging. In such circumstances, retesting may be waived.
- 6.1.4.8.4 The wall thickness at every point of the packaging shall be appropriate to its capacity and intended use, taking into account the stresses to which each point is liable to be exposed.
- 6.1.4.8.5 Openings for filling, emptying and venting in the bodies or heads of non-removable head drums (1H1) and jerricans (3H1) shall not exceed 7 cm in diameter. Drums and jerricans with larger openings are considered to be of the removable head type (1H2 and 3H2). Closures for openings in the bodies or heads of drums and jerricans shall be so designed and applied that they will remain secure and leakproof under normal conditions of carriage. Gaskets or other sealing elements shall be used with closures unless the closure is inherently leakproof.
- 6.1.4.8.6 Closure devices for removable head drums and jerricans (1H2 and 3H2) shall be so designed and applied that they will remain secure and leakproof under normal conditions of carriage. Gaskets shall be used with all removable heads unless the drum or jerrican design is such that, where the removable head is properly secured, the drum or jerrican is inherently leakproof.
- 6.1.4.8.7 The maximum permissible permeability for flammable liquids shall be 0.008 g/l.h at 23 °C (see 6.1.5.8).
- 6.1.4.8.8 Where recycled plastics material is used for production of new packaging, the specific properties of the recycled material shall be assured and documented regularly as part of a quality assurance programme recognised by the competent authority. The quality assurance programme shall include a record of proper pre-sorting and verification that each batch of recycled plastics material has the proper melt flow rate, density, and tensile yield strength, consistent with that of the design type manufactured from such recycled material. This necessarily includes knowledge about the packaging material from which the recycled plastics have been derived, as well as the awareness of the prior contents of those packagings

if those prior contents might reduce the capability of new packaging produced using that material. In addition, the packaging manufacturer's quality assurance programme under 6.1.1.4 shall include performance of the mechanical design type test in 6.1.5 on packagings manufactured from each batch of recycled plastics material. In this testing, stacking performance may be verified by appropriate dynamic compression testing rather than static load testing.

6.1.4.8.9 Maximum capacity of drums and jerricans: 1H1, 1H2: 450 litres
3H1, 3H2: 60 litres.

6.1.4.8.10 Maximum net mass: 1H1, 1H2: 400 kg
3H1, 3H2: 120 kg.

6.1.4.9 *Boxes of natural wood*

4C1 ordinary
4C2 with sift-proof walls

6.1.4.9.1 The wood used shall be well seasoned, commercially dry and free from defects that would materially lessen the strength of any part of the box. The strength of the material used and the method of construction shall be appropriate to the capacity and intended use of the box. The tops and bottoms may be made of water resistant reconstituted wood such as hardboard, particle board or other suitable type.

6.1.4.9.2 Fastenings shall be resistant to vibration experienced under normal conditions of carriage. End grain nailing shall be avoided whenever practicable. Joins which are likely to be highly stressed shall be made using clenched or annular ring nails or equivalent fastenings.

6.1.4.9.3 Box 4C2: each part shall consist of one piece or be equivalent thereto. Parts are considered equivalent to one piece when one of the following methods of glued assembly is used: Lindermann joint, tongue and groove joint, ship lap or rabbet joint or butt joint with at least two corrugated metal fasteners at each joint.

6.1.4.9.4 Maximum net mass: 400 kg.

6.1.4.10 *Plywood boxes*

4D

6.1.4.10.1 Plywood used shall be at least 3-ply. It shall be made from well seasoned rotary cut, sliced or sawn veneer, commercially dry and free from defects that would materially lessen the strength of the box. The strength of the material used and the method of construction shall be appropriate to the capacity and intended use of the box. All adjacent plies shall be glued with water resistant adhesive. Other suitable materials may be used together with plywood in the construction of boxes. Boxes shall be firmly nailed or secured to corner posts or ends or be assembled by equally suitable devices.

6.1.4.10.2 Maximum net mass: 400 kg.

6.1.4.11 *Reconstituted wood boxes*

4F

6.1.4.11.1 The walls of boxes shall be made of water resistant reconstituted wood such as hardboard, particle board or other suitable type. The strength of the material used and the method of construction shall be appropriate to the capacity of the boxes and to their intended use.

6.1.4.11.2 Other parts of the boxes may be made of other suitable material.

6.1.4.11.3 Boxes shall be securely assembled by means of suitable devices.

6.1.4.11.4 Maximum net mass: 400 kg.

6.1.4.12 *Fibreboard boxes*

4G

6.1.4.12.1 Strong and good quality solid or double-faced corrugated fibreboard (single or multiwall) shall be used, appropriate to the capacity of the box and to its intended use. The water resistance of the outer surface shall be such that the increase in mass, as determined in a test carried out over a period of 30 minutes by the Cobb method of determining water absorption, is not greater than 155 g/m² - see ISO 535:1991. It shall have proper bending qualities. Fibreboard shall be cut, creased without scoring, and slotted so as to permit assembly without cracking, surface breaks or undue bending. The fluting of corrugated fibreboard shall be firmly glued to the facings.

6.1.4.12.2 The ends of boxes may have a wooden frame or be entirely of wood or other suitable material. Reinforcements of wooden battens or other suitable material may be used.

6.1.4.12.3 Manufacturing joints in the body of boxes shall be taped, lapped and glued, or lapped and stitched with metal staples. Lapped joints shall have an appropriate overlap.

6.1.4.12.4 Where closing is effected by gluing or taping, a water resistant adhesive shall be used.

6.1.4.12.5 Boxes shall be designed so as to provide a good fit to the contents.

6.1.4.12.6 Maximum net mass: 400 kg.

6.1.4.13 *Plastics boxes*

4H1 expanded plastics boxes

4H2 solid plastics boxes

6.1.4.13.1 The box shall be manufactured from suitable plastics material and be of adequate strength in relation to its capacity and intended use. The box shall be adequately resistant to ageing and to degradation caused either by the substance contained or by ultra-violet radiation.

6.1.4.13.2 An expanded plastics box shall comprise two parts made of a moulded expanded plastics material, a bottom section containing cavities for the inner packagings and a top section covering and interlocking with the bottom section. The top and bottom sections shall be designed so that the inner packagings fit snugly. The closure cap for any inner packaging shall not be in contact with the inside of the top section of this box.

6.1.4.13.3 For dispatch, an expanded plastics box shall be closed with a self-adhesive tape having sufficient tensile strength to prevent the box from opening. The adhesive tape shall be weather resistant and its adhesive compatible with the expanded plastics material of the box. Other closing devices at least equally effective may be used.

6.1.4.13.4 For solid plastics boxes, protection against ultra-violet radiation, if required, shall be provided by the addition of carbon black or other suitable pigments or inhibitors. These additives shall be compatible with the contents and remain effective throughout the life of the box. Where use is made of carbon black, pigments or inhibitors other than those used in the manufacture of the tested design type, retesting may be waived if the carbon black

content does not exceed 2% by mass or if the pigment content does not exceed 3% by mass; the content of inhibitors of ultra-violet radiation is not limited.

6.1.4.13.5 Additives serving purposes other than protection against ultra-violet radiation may be included in the composition of the plastics material provided that they do not adversely affect the chemical or physical properties of the material of the box. In such circumstances, retesting may be waived.

6.1.4.13.6 Solid plastics boxes shall have closure devices made of a suitable material of adequate strength and so designed as to prevent the box from unintentional opening.

6.1.4.13.7 Where recycled plastics material is used for production of new packaging, the specific properties of the recycled material shall be assured and documented regularly as part of a quality assurance programme recognised by the competent authority. The quality assurance programme shall include a record of proper pre-sorting and verification that each batch of recycled plastics material has the proper melt flow rate, density, and tensile yield strength, consistent with that of the design type manufactured from such recycled material. This necessarily includes knowledge about the packaging material from which the recycled plastics have been derived, as well as the awareness of the prior contents of those packagings if those prior contents might reduce the capability of new packaging produced using that material. In addition, the packaging manufacturer's quality assurance programme under 6.1.1.4 shall include performance of the mechanical design type test in 6.1.5 on packagings manufactured from each batch of recycled plastics material. In this testing, stacking performance may be verified by appropriate dynamic compression testing rather than static load testing.

6.1.4.13.8 Maximum net mass 4H1: 60 kg
 4H2: 400 kg.

6.1.4.14 *Steel or aluminium boxes*

4A steel
4B aluminium

6.1.4.14.1 The strength of the metal and the construction of the box shall be appropriate to the capacity of the box and to its intended use.

6.1.4.14.2 Boxes shall be lined with fibreboard or felt packing pieces or shall have an inner liner or coating of suitable material, as required. If a double seamed metal liner is used, steps shall be taken to prevent the ingress of substances, particularly explosives, into the recesses of the seams.

6.1.4.14.3 Closures may be of any suitable type; they shall remain secured under normal conditions of carriage.

6.1.4.14.4 Maximum net mass: 400 kg.

6.1.4.15 *Textile bags*

5L1 without inner liner or coating
5L2 sift-proof
5L3 water resistant

6.1.4.15.1 The textiles used shall be of good quality. The strength of the fabric and the construction of the bag shall be appropriate to the capacity of the bag and to its intended use.

- 6.1.4.15.2 Bags, sift-proof, 5L2: the bag shall be made sift-proof, for example by the use of:
- (a) paper bonded to the inner surface of the bag by a water resistant adhesive such as bitumen; or
 - (b) plastics film bonded to the inner surface of the bag; or
 - (c) one or more inner liners made of paper or plastics material.
- 6.1.4.15.3 Bags, water resistant, 5L3: to prevent the entry of moisture the bag shall be made waterproof, for example by the use of:
- (a) separate inner liners of water resistant paper (e.g. waxed kraft paper, tarred paper or plastics-coated kraft paper); or
 - (b) plastics film bonded to the inner surface of the bag; or
 - (c) one or more inner liners made of plastics material.
- 6.1.4.15.4 Maximum net mass: 50 kg.
- 6.1.4.16 *Woven plastics bags***
- 5H1 without inner liner or coating
5H2 sift-proof
5H3 water resistant
- 6.1.4.16.1 Bags shall be made from stretched tapes or monofilaments of a suitable plastics material. The strength of the material used and the construction of the bag shall be appropriate to the capacity of the bag and to its intended use.
- 6.1.4.16.2 If the fabric is woven flat, the bags shall be made by sewing or some other method ensuring closure of the bottom and one side. If the fabric is tubular, the bag shall be closed by sewing, weaving or some other equally strong method of closure.
- 6.1.4.16.3 Bags, sift-proof, 5H2: the bag shall be made sift-proof, for example by means of:
- (a) paper or a plastics film bonded to the inner surface of the bag; or
 - (b) one or more separate inner liners made of paper or plastics material.
- 6.1.4.16.4 Bags, water resistant, 5H3: to prevent the entry of moisture, the bag shall be made waterproof, for example by means of:
- (a) separate inner liners of water resistant paper (e.g. waxed kraft paper, double-tarred kraft paper or plastics-coated kraft paper); or
 - (b) plastics film bonded to the inner or outer surface of the bag; or
 - (c) one or more inner plastics liners.
- 6.1.4.16.5 Maximum net mass: 50 kg.

6.1.4.17 ***Plastics film bags***

5H4

6.1.4.17.1 Bags shall be made of a suitable plastics material. The strength of the material used and the construction of the bag shall be appropriate to the capacity of the bag and to its intended use. Joins and closures shall withstand pressures and impacts liable to occur under normal conditions of carriage.

6.1.4.17.2 Maximum net mass: 50 kg.

6.1.4.18 ***Paper bags***

5M1 multiwall

5M2 multiwall, water resistant

6.1.4.18.1 Bags shall be made of a suitable kraft paper or of an equivalent paper with at least three plies, the middle ply of which may be net-cloth and adhesive bonding to the outer paper plies. The strength of the paper and the construction of the bags shall be appropriate to the capacity of the bag and to its intended use. Joins and closures shall be sift-proof.

6.1.4.18.2 Bags 5M2: to prevent the entry of moisture, a bag of four plies or more shall be made waterproof by the use of either a water resistant ply as one of the two outermost plies or a water resistant barrier made of a suitable protective material between the two outermost plies; a bag of three plies shall be made waterproof by the use of a water resistant ply as the outermost ply. Where there is a danger of the substance contained reacting with moisture or where it is packed damp, a waterproof ply or barrier, such as double-tarred kraft paper, plastics-coated kraft paper, plastics film bonded to the inner surface of the bag, or one or more inner plastics liners, shall also be placed next to the substance. Joins and closures shall be waterproof.

6.1.4.18.3 Maximum net mass : 50 kg.

6.1.4.19 ***Composite packagings (plastics material)***

6HA1 plastics receptacle with outer steel drum

6HA2 plastics receptacle with outer steel crate or box

6HB1 plastics receptacle with outer aluminium drum

6HB2 plastics receptacle with outer aluminium crate or box

6HC plastics receptacle with outer wooden box

6HD1 plastics receptacle with outer plywood drum

6HD2 plastics receptacle with outer plywood box

6HG1 plastics receptacle with outer fibre drum

6HG2 plastics receptacle with outer fibreboard box

6HH1 plastics receptacle with outer plastics drum

6HH2 plastics receptacle with outer solid plastics box

6.1.4.19.1 ***Inner receptacle***

6.1.4.19.1.1 The requirements of 6.1.4.8.1 and 6.1.4.8.4 to 6.1.4.8.7 apply to plastics inner receptacles.

6.1.4.19.1.2 The plastics inner receptacle shall fit snugly inside the outer packaging, which shall be free of any projection that might abrade the plastics material.

- 6.1.4.19.1.3 Maximum capacity of inner receptacle:
- | | |
|------------------------------------|------------|
| 6HA1, 6HB1, 6HD1, 6HG1, 6HH1: | 250 litres |
| 6HA2, 6HB2, 6HC, 6HD2, 6HG2, 6HH2: | 60 litres. |
- 6.1.4.19.1.4 Maximum net mass:
- | | |
|------------------------------------|--------|
| 6HA1, 6HB1, 6HD1, 6HG1, 6HH1: | 400 kg |
| 6HA2, 6HB2, 6HC, 6HD2, 6HG2, 6HH2: | 75 kg. |
- 6.1.4.19.2 *Outer packaging*
- 6.1.4.19.2.1 Plastics receptacle with outer steel or aluminium drum 6HA1 or 6HB1; the relevant requirements of 6.1.4.1 or 6.1.4.2, as appropriate, apply to the construction of the outer packaging.
- 6.1.4.19.2.2 Plastics receptacle with outer steel or aluminium crate or box 6HA2 or 6HB2; the relevant requirements of 6.1.4.14 apply to the construction of the outer packaging.
- 6.1.4.19.2.3 Plastics receptacle with outer wooden box 6HC; the relevant requirements of 6.1.4.9 apply to the construction of the outer packaging.
- 6.1.4.19.2.4 Plastics receptacle with outer plywood drum 6HD1; the relevant requirements of 6.1.4.5 apply to the construction of the outer packaging.
- 6.1.4.19.2.5 Plastics receptacle with outer plywood box 6HD2; the relevant requirements of 6.1.4.10 apply to the construction of the outer packaging.
- 6.1.4.19.2.6 Plastics receptacle with outer fibre drum 6HG1; the requirements of 6.1.4.7.1 to 6.1.4.7.4 apply to the construction of the outer packaging.
- 6.1.4.19.2.7 Plastics receptacle with outer fibreboard box 6HG2; the relevant requirements of 6.1.4.12 apply to the construction of the outer packaging.
- 6.1.4.19.2.8 Plastics receptacle with outer plastics drum 6HH1; the requirements of 6.1.4.8.1 to 6.1.4.8.6 apply to the construction of the outer packaging.
- 6.1.4.19.2.9 Plastics receptacles with outer solid plastics box (including corrugated plastics material) 6HH2; the requirements of 6.1.4.13.1 and 6.1.4.13.4 to 6.1.4.13.6 apply to the construction of the outer packaging.

6.1.4.20 *Composite packagings (glass, porcelain or stoneware)*

- | | |
|------|---|
| 6PA1 | receptacle with outer steel drum |
| 6PA2 | receptacle with outer steel crate or box |
| 6PB1 | receptacle with outer aluminium drum |
| 6PB2 | receptacle with outer aluminium crate or box |
| 6PC | receptacle with outer wooden box |
| 6PD1 | receptacle with outer plywood drum |
| 6PD2 | receptacle with outer wickerwork hamper |
| 6PG1 | receptacle with outer fibre drum |
| 6PG2 | receptacle with outer fibreboard box |
| 6PH1 | receptacle with outer expanded plastics packaging |
| 6PH2 | receptacle with outer solid plastics packaging |

- 6.1.4.20.1 *Inner receptacle*
- 6.1.4.20.1.1 Receptacles shall be of a suitable form (cylindrical or pear-shaped) and be made of good quality material free from any defect that could impair their strength. The walls shall be sufficiently thick at every point and free from internal stresses.
- 6.1.4.20.1.2 Screw-threaded plastics closures, ground glass stoppers or closures at least equally effective shall be used as closures for receptacles. Any part of the closure likely to come into contact with the contents of the receptacle shall be resistant to those contents. Care shall be taken to ensure that the closures are so fitted as to be leakproof and are suitably secured to prevent any loosening during carriage. If vented closures are necessary, they shall comply with 4.1.1.8.
- 6.1.4.20.1.3 The receptacle shall be firmly secured in the outer packaging by means of cushioning and/or absorbent materials.
- 6.1.4.20.1.4 Maximum capacity of receptacle: 60 litres.
- 6.1.4.20.1.5 Maximum net mass: 75 kg.
- 6.1.4.20.2 *Outer packaging*
- 6.1.4.20.2.1 Receptacle with outer steel drum 6PA1; the relevant requirements of 6.1.4.1 apply to the construction of the outer packaging. The removable lid required for this type of packaging may nevertheless be in the form of a cap.
- 6.1.4.20.2.2 Receptacle with outer steel crate or box 6PA2; the relevant requirements of 6.1.4.14 apply to the construction of the outer packaging. For cylindrical receptacles the outer packaging shall, when upright, rise above the receptacle and its closure. If the crate surrounds a pear-shaped receptacle and is of matching shape, the outer packaging shall be fitted with a protective cover (cap).
- 6.1.4.20.2.3 Receptacle with outer aluminium drum 6PB1; the relevant requirements of 6.1.4.2 apply to the construction of the outer packaging.
- 6.1.4.20.2.4 Receptacle with outer aluminium crate or box 6PB2; the relevant requirements of 6.1.4.14 apply to the construction of the outer packaging.
- 6.1.4.20.2.5 Receptacle with outer wooden box 6PC; the relevant requirements of 6.1.4.9 apply to the construction of the outer packaging.
- 6.1.4.20.2.6 Receptacle with outer plywood drum 6PD1; the relevant requirements of 6.1.4.5 apply to the construction of the outer packaging.
- 6.1.4.20.2.7 Receptacle with outer wickerwork hamper 6PD2. The wickerwork hamper shall be properly made with material of good quality. It shall be fitted with a protective cover (cap) so as to prevent damage to the receptacle.
- 6.1.4.20.2.8 Receptacle with outer fibre drum 6PG1; the relevant requirements of 6.1.4.7.1 to 6.1.4.7.4 apply to the construction of the outer packaging.
- 6.1.4.20.2.9 Receptacle with outer fibreboard box 6PG2; the relevant requirements of 6.1.4.12 apply to the construction of the outer packaging.
- 6.1.4.20.2.10 Receptacle with outer expanded plastics or solid plastics packaging (6PH1 or 6PH2); the materials of both outer packagings shall meet the relevant requirements of 6.1.4.13. Outer

solid plastics packaging shall be manufactured from high density polyethylene or some other comparable plastics material. The removable lid for this type of packaging may nevertheless be in the form of a cap.

6.1.4.21 ***Combination packagings***

The relevant requirements of section 6.1.4 for the outer packagings to be used, are applicable.

NOTE: For the inner and outer packagings to be used, see the relevant packing instructions in Chapter 4.1.

6.1.4.22 ***Light gauge metal packagings***

0A1 non-removable-head
0A2 removable-head

6.1.4.22.1 The sheet metal for the body and ends shall be of suitable steel, and of a gauge appropriate to the capacity and intended use of the packaging.

6.1.4.22.2 The joints shall be welded, at least double-seamed by welting or produced by a method ensuring a similar degree of strength and leakproofness.

6.1.4.22.3 Inner coatings of zinc, tin, lacquer, etc. shall be tough and shall adhere to the steel at every point, including the closures.

6.1.4.22.4 Openings for filling, emptying and venting in the bodies or heads of non-removable head (0A1) packagings shall not exceed 7 cm in diameter. Packagings with larger openings shall be considered to be of the removable-head type (0A2).

6.1.4.22.5 The closures of non-removable-head packagings (0A1) shall either be of the screw-threaded type or be capable of being secured by a screwable device or a device at least equally effective. The closures of removable-head packagings (0A2) shall be so designed and fitted that they stay firmly closed and the packagings remain leakproof in normal conditions of carriage.

6.1.4.22.6 Maximum capacity of packagings: 40 litres.

6.1.4.22.7 Maximum net mass: 50 kg.

6.1.5 **Test requirements for packagings**

6.1.5.1 ***Performance and frequency of tests***

6.1.5.1.1 The design type of each packaging shall be tested as provided in 6.1.5 in accordance with procedures established and approved by the competent authority.

6.1.5.1.2 Tests shall be successfully performed on each packaging design type before such packaging is used. A packaging design type is defined by the design, size, material and thickness, manner of construction and packing, but may include various surface treatments. It also includes packagings which differ from the design type only in their lesser design height.

6.1.5.1.3 Tests shall be repeated on production samples at intervals established by the competent authority. For such tests on paper or fibreboard packagings, preparation at ambient conditions is considered equivalent to the requirements of 6.1.5.2.3.

- 6.1.5.1.4 Tests shall also be repeated after each modification which alters the design, material or manner of construction of a packaging.
- 6.1.5.1.5 The competent authority may permit the selective testing of packagings that differ only in minor respects from a tested type, e.g. smaller sizes of inner packagings or inner packagings of lower net mass; and packagings such as drums, bags and boxes which are produced with small reductions in external dimension(s).
- 6.1.5.1.6 Where an outer packaging of a combination packaging has been successfully tested with different types of inner packagings, a variety of such different inner packagings may also be assembled in this outer packaging. In addition, provided an equivalent level of performance is maintained, the following variations in inner packagings are allowed without further testing of the package:
- (a) Inner packagings of equivalent or smaller size may be used provided:
 - (i) the inner packagings are of similar design to the tested inner packagings (e.g. shape - round, rectangular, etc.);
 - (ii) the material of construction of the inner packagings (glass, plastics, metal, etc.) offers resistance to impact and stacking forces equal to or greater than that of the originally tested inner packaging;
 - (iii) the inner packagings have the same or smaller openings and the closure is of similar design (e.g. screw cap, friction lid, etc.);
 - (iv) sufficient additional cushioning material is used to take up void spaces and to prevent significant movement of the inner packagings; and
 - (v) inner packagings are oriented within the outer packaging in the same manner as in the tested package.
 - (b) A lesser number of the tested inner packagings, or of the alternative types of inner packagings identified in (a) above, may be used provided sufficient cushioning is added to fill the void space(s) and to prevent significant movement of the inner packagings.
- 6.1.5.1.7 Articles or inner packagings of any type for solids or liquids may be assembled and carried without testing in an outer packaging under the following conditions:
- (a) The outer packaging shall have been successfully tested in accordance with 6.1.5.3 with fragile (e.g. glass) inner packagings containing liquids using the packing group I drop height;
 - (b) The total combined gross mass of inner packagings shall not exceed one half the gross mass of inner packagings used for the drop test in (a) above;
 - (c) The thickness of cushioning material between inner packagings and between inner packagings and the outside of the packaging shall not be reduced below the corresponding thicknesses in the originally tested packaging; and if a single inner packaging was used in the original test, the thicknesses of cushioning between inner packagings shall not be less than the thickness of cushioning between the outside of the packaging and the inner packaging in the original test. If either fewer or smaller inner packagings are used (as compared to the inner packagings used in the drop test), sufficient additional cushioning material shall be used to take up void spaces;

- (d) The outer packaging shall have passed successfully the stacking test in 6.1.5.6 while empty. The total mass of identical packages shall be based on the combined mass of inner packagings used for the drop test in (a) above;
- (e) Inner packagings containing liquids shall be completely surrounded with a sufficient quantity of absorbent material to absorb the entire liquid contents of the inner packagings;
- (f) If the outer packaging is intended to contain inner packagings for liquids and is not leakproof, or is intended to contain inner packagings for solids and is not siftproof, a means of containing any liquid or solid contents in the event of leakage shall be provided in the form of a leakproof liner, plastics bag or other equally efficient means of containment. For packagings containing liquids, the absorbent material required in (e) above shall be placed inside the means of containing the liquid contents;
- (g) Packagings shall be marked in accordance with 6.1.3 as having been tested to packing group I performance for combination packagings. The marked gross mass in kilograms shall be the sum of the mass of the outer packaging plus one half of the mass of the inner packaging(s) as used for the drop test referred to in (a) above. Such a package mark shall also contain a letter "V" as described in 6.1.2.4.

6.1.5.1.8 The competent authority may at any time require proof, by tests in accordance with this section, that serially-produced packagings meet the requirements of the design type tests. For verification purposes records of such tests shall be maintained.

6.1.5.1.9 If an inner treatment or coating is required for safety reasons, it shall retain its protective properties even after the tests.

6.1.5.1.10 Provided the validity of the test results is not affected and with the approval of the competent authority, several tests may be made on one sample.

6.1.5.1.11 *Salvage packagings*

Salvage packagings (see 1.2.1) shall be tested and marked in accordance with the requirements applicable to packing group II packagings intended for the carriage of solids or inner packagings, except as follows:

- (a) The test substance used in performing the tests shall be water, and the packagings shall be filled to not less than 98% of their maximum capacity. It is permissible to use additives, such as bags of lead shot, to achieve the requisite total package mass so long as they are placed so that the test results are not affected. Alternatively, in performing the drop test, the drop height may be varied in accordance with 6.1.5.3.4 (b);
- (b) Packagings shall, in addition, have been successfully subjected to the leakproofness test at 30 kPa, with the results of this test reflected in the test report required by 6.1.5.9; and
- (c) Packagings shall be marked with the letter "T" as described in 6.1.2.4.

6.1.5.2 *Preparation of packagings for testing*

6.1.5.2.1 Tests shall be carried out on packagings prepared as for carriage including, with respect to combination packagings, the inner packagings used. Inner or single receptacles or packagings shall be filled to not less than 98% of their maximum capacity for liquids or 95% for solids. For combination packagings where the inner packaging is designed to carry liquids and solids, separate testing is required for both liquid and solid contents. The

substances or articles to be carried in the packagings may be replaced by other substances or articles except where this would invalidate the results of the tests. For solids, when another substance is used it shall have the same physical characteristics (mass, grain size, etc.) as the substance to be carried. It is permissible to use additives, such as bags of lead shot, to achieve the requisite total package mass, so long as they are placed so that the test results are not affected.

6.1.5.2.2 In the drop tests for liquids, when another substance is used, it shall be of similar relative density and viscosity to those of the substance being carried. Water may also be used for the liquid drop test under the conditions in 6.1.5.3.4.

6.1.5.2.3 Paper or fibreboard packagings shall be conditioned for at least 24 hours in an atmosphere having a controlled temperature and relative humidity (r.h.). There are three options, one of which shall be chosen. The preferred atmosphere is 23 ± 2 °C and $50\% \pm 2\%$ r.h. The two other options are 20 ± 2 °C and $65\% \pm 2\%$ r.h. or 27 ± 2 °C and $65\% \pm 2\%$ r.h.

NOTE: Average values shall fall within these limits. Short-term fluctuations and measurement limitations may cause individual measurements to vary by up to $\pm 5\%$ relative humidity without significant impairment of test reproducibility.

6.1.5.2.4 Bung-type barrels made of natural wood shall be left filled with water for at least 24 hours before the tests.

6.1.5.2.5 To check that their chemical compatibility with the liquids is sufficient, plastics drums and jerricans in accordance with 6.1.4.8 and if necessary composite packagings (plastics material) in accordance with 6.1.4.19 shall be subjected to storage at ambient temperature for six months, during which time the test samples shall be kept filled with the goods they are intended to carry.

For the first and last 24 hours of storage, the test samples shall be placed with the closure downwards. However, packagings fitted with a vent shall be so placed on each occasion for five minutes only. After this storage the test samples shall undergo the tests prescribed in 6.1.5.3 to 6.1.5.6.

When it is known that the strength properties of the plastics material of the inner receptacles of composite packagings (plastics material) are not significantly altered by the action of the filling substance, it shall not be necessary to check that the chemical compatibility is sufficient.

A significant alteration in strength properties means:

- (a) distinct embrittlement; or
- (b) a considerable decrease in elasticity, unless related to a not less than proportionate increase in the elongation under load.

Where the behaviour of the plastics material has been established by other means, the above compatibility test may be dispensed with. Such procedures shall be at least equivalent to the above compatibility test and be recognized by the competent authority.

NOTE: For plastics drums and jerricans and composite packagings (plastics material) made of high or average molecular mass polyethylene, see also 6.1.5.2.6 below.

6.1.5.2.6 For high molecular mass polyethylene drums and jerricans in accordance with 6.1.4.8 and if necessary composite packagings of high molecular mass polyethylene in accordance with 6.1.4.19, conforming to the following specifications:

- relative density at 23 °C after thermal conditioning for one hour at 100 °C ≥ 0.940 , in accordance with ISO Standard 1183,
- melt flow rate at 190 °C/21.6 kg load ≤ 12 g/10 min, in accordance with ISO Standard 1133,

for jerricans in accordance with 6.1.4.8 of packing groups II and III and, if necessary, for composite packagings in accordance with 6.1.4.19 in average molecular mass polyethylene meeting the following specifications:

- relative density at 23 °C after thermal conditioning for one hour at 100 °C ≥ 0.940 , in accordance with ISO Standard 1183,
- melt flow rate at 190 °C/2.16 kg load ≤ 0.5 g/10 min and ≥ 0.1 g/10 min, in accordance with ISO Standard 1133,
- melt flow rate at 190 °C/5 kg load ≤ 3 g/10 min and ≥ 0.5 g/10 min, in accordance with ISO Standard 1133,

chemical compatibility with the liquids listed in 6.1.6.2 may be verified as follows with standard liquids (see 6.1.6.1).

The sufficient chemical compatibility of these packagings may be verified by storage for three weeks at 40 °C with the appropriate standard liquid; where this standard liquid is water, proof of chemical compatibility is not required.

For the first and last 24 hours of storage, the test samples shall be placed with the closure downwards. However, packagings fitted with a vent shall be so placed on each occasion for five minutes only. After this storage, the test samples shall undergo the tests prescribed in 6.1.5.3 to 6.1.5.6.

When a packaging design-type has satisfied the approval tests with a standard liquid, the comparable filling substances listed in 6.1.6.2 may be accepted for carriage without further testing, subject to the following conditions:

- the relative densities of the filling substances shall not exceed that used to determine the height for the drop test and the mass for the stacking test;
- the vapour pressures of the filling substances at 50 °C or 55 °C shall not exceed that used to determine the pressure for the internal pressure test.

The compatibility test for tert-Butyl hydroperoxide with more than 40% peroxide content and peroxyacetic acids of Class 5.2, shall not be carried out using standard liquids. For these substances, proof of sufficient chemical compatibility of the test samples shall be provided during a storage period of six months at ambient temperature with the substances they are intended to carry.

The procedure in accordance with this paragraph also applies to high density, high or average molecular mass polyethylene packagings, the internal surface of which is fluorinated.

6.1.5.2.7 For drums and jerricans conforming to 6.1.4.8, and where necessary composite packagings conforming to 6.1.4.19, made of high or average molecular mass polyethylene, which have passed the test in 6.1.5.2.6, filling substances other than those listed in 6.1.6.2 may also be approved. Such approval shall be based on laboratory tests proving that the effect of such filling substances on the test specimens is less than that of the standard liquids. The processes of deterioration to be taken into account shall be the following: softening through swelling, cracking under stress and molecular degradation. The same conditions as those set out in 6.1.5.2.6 above shall apply with respect to relative density and vapour pressure.

6.1.5.2.8 Provided that the strength properties of the plastics inner packagings of a combination packaging are not significantly altered by the action of the filling substance, proof of chemical compatibility is not necessary. A significant alteration in strength properties means:

- (a) distinct embrittlement;
- (b) a considerable decrease in elasticity, unless related to a not less than proportionate increase in elastic elongation.

6.1.5.3 *Drop test*³

6.1.5.3.1 *Number of test samples (per design type and manufacturer) and drop orientation*

For other than flat drops the centre of gravity shall be vertically over the point of impact.

Where more than one orientation is possible for a given drop test, the orientation most likely to result in failure of the packaging shall be used.

Packaging	No. of test samples	Drop orientation
(a) Steel drums Aluminium drums Drums of metal other than steel or aluminium Steel jerricans Aluminium jerricans Plywood drums Wooden barrels Fibre drums Plastics drums and jerricans Composite packagings which are in the shape of a drum Light gauge metal packagings	Six (three for each drop)	First drop (using three samples): the packaging shall strike the target diagonally on the chime or, if the packaging has no chime, on a circumferential seam or an edge. Second drop (using the other three samples): the packaging shall strike the target on the weakest part not tested by the first drop, for example a closure or, for some cylindrical drums, the welded longitudinal seam of the drum body
(b) Boxes of natural wood Plywood boxes Reconstituted wood boxes Fibreboard boxes Plastics boxes Steel or aluminium boxes Composite packagings which are in the shape of a box	Five (one for each drop)	First drop: flat on the bottom Second drop: flat on the top Third drop: flat on the long side Fourth drop: flat on the short side Fifth drop: on a corner

³ See ISO Standard 2248.

Packaging	No. of test samples	Drop orientation
(c) Bags - single-ply with a side seam	Three (three drops per bag)	First drop: flat on a wide face Second drop: flat on a narrow face Third drop: on an end of the bag
(d) Bags - single-ply without a side seam, or multi-ply	Three (two drops per bag)	First drop: flat on a wide face Second drop: on an end of the bag
(e) Composite packagings (glass, stoneware or porcelain), marked with the symbol "RID/ADR" according to 6.1.3.1 (a) (ii) and which are in the shape of a drum or box	Three (one for each drop)	Diagonally on the bottom chime, or, if there is no chime, on a circumferential seam or the bottom edge

6.1.5.3.2 *Special preparation of test samples for the drop test*

The temperature of the test sample and its contents shall be reduced to $-18\text{ }^{\circ}\text{C}$ or lower for the following packagings:

- (a) plastics drums (see 6.1.4.8);
- (b) plastics jerricans (see 6.1.4.8);
- (c) plastics boxes other than expanded plastics boxes (see 6.1.4.13);
- (d) composite packagings (plastics material) (see 6.1.4.19) and;
- (e) combination packagings with plastics inner packagings, other than plastics bags intended to contain solids or articles.

Where test samples are prepared in this way, the conditioning in 6.1.5.2.3 may be waived. Test liquids shall be kept in the liquid state by the addition of anti-freeze if necessary.

6.1.5.3.3 *Target*

The target shall be a rigid, non-resilient, flat and horizontal surface.

6.1.5.3.4 *Drop height*

For solids and liquids, if the test is performed with the solid or liquid to be carried or with another substance having essentially the same physical characteristics:

Packing Group I	Packing Group II	Packing Group III
1.8 m	1.2 m	0.8 m

For liquids if the test is performed with water:

- (a) where the substances to be carried have a relative density not exceeding 1.2:

Packing Group I	Packing Group II	Packing Group III
1.8 m	1.2 m	0.8 m

- (b) where the substances to be carried have a relative density exceeding 1.2, the drop height shall be calculated on the basis of the relative density (d) of the substance to be carried, rounded up to the first decimal, as follows:

Packing Group I	Packing Group II	Packing Group III
$d \times 1.5$ (m)	$d \times 1.0$ (m)	$d \times 0.67$ (m)

- (c) for light-gauge metal packagings, marked with symbol "RID/ADR" according to 6.1.3.1(a) (ii) intended for the carriage of substances having a viscosity at 23 °C greater than 200 mm²/s (corresponding to a flow time of 30 seconds with an ISO flow cup having a jet orifice of 6 mm diameter in accordance with ISO Standard 2431:1993)

- (i) if the relative density does not exceed 1.2:

Packing group II	Packing group III
0.6 m	0.4 m

- (ii) where the substances to be carried have a relative density (d) exceeding 1.2 the drop height shall be calculated on the basis of the relative density (d) of the substance to be carried, rounded up to the first decimal place, as follows:

Packing group II	Packing group III
$d \times 0.5$ m	$d \times 0.33$ m

6.1.5.3.5 *Criteria for passing the test*

- 6.1.5.3.5.1 Each packaging containing liquid shall be leakproof when equilibrium has been reached between the internal and external pressures, however for inner packagings of combination packagings and except for inner receptacles of composite packagings (glass, porcelain or stoneware), marked with the symbol "RID/ADR" according to 6.1.3.1 (a) (ii) it is not necessary that the pressures be equalized.
- 6.1.5.3.5.2 Where a packaging for solids undergoes a drop test and its upper face strikes the target, the test sample passes the test if the entire contents are retained by an inner packaging or inner receptacle (e.g. a plastics bag), even if the closure is no longer sift-proof.
- 6.1.5.3.5.3 The packaging or outer packaging of a composite or combination packaging shall not exhibit any damage liable to affect safety during carriage. There shall be no leakage of the filling substance from the inner receptacle or inner packaging(s).
- 6.1.5.3.5.4 Neither the outermost ply of a bag nor an outer packaging may exhibit any damage liable to affect safety during carriage.
- 6.1.5.3.5.5 A slight discharge from the closure(s) upon impact is not considered to be a failure of the packaging provided that no further leakage occurs.
- 6.1.5.3.5.6 No rupture is permitted in packagings for goods of Class 1 which would permit the spillage of loose explosive substances or articles from the outer packaging.

6.1.5.4 **Leakproofness test**

The leakproofness test shall be performed on all design types of packagings intended to contain liquids; however, this test is not required for

- inner packagings of combination packagings;
- inner receptacles of composite packagings (glass, porcelain or stoneware), marked with the symbol "RID/ADR" according to 6.1.3.1 (a) (ii);
- light gauge metal packagings, marked with the symbol "RID/ADR" according to 6.1.3.1 (a) (ii) intended for substances with a viscosity at 23 °C exceeding 200 mm²/s.

6.1.5.4.1 *Number of test samples:* three test samples per design type and manufacturer.

6.1.5.4.2 *Special preparation of test samples for the test:* either vented closures shall be replaced by similar non-vented closures or the vent shall be sealed.

6.1.5.4.3 *Test method and pressure to be applied:* the packagings including their closures shall be restrained under water for 5 minutes while an internal air pressure is applied, the method of restraint shall not affect the results of the test.

The air pressure (gauge) to be applied shall be:

Packing Group I	Packing Group II	Packing Group III
Not less than 30 kPa (0.3 bar)	Not less than 20 kPa (0.2 bar)	Not less than 20 kPa (0.2 bar)

Other methods at least equally effective may be used.

6.1.5.4.4 *Criterion for passing the test:* there shall be no leakage.

6.1.5.5 **Internal pressure (hydraulic) test**

6.1.5.5.1 *Packagings to be tested*

The internal pressure (hydraulic) test shall be carried out on all design types of metal, plastics and composite packagings intended to contain liquids. This test is not required for:

- inner packagings of combination packagings;
- inner receptacles of composite packagings (glass, porcelain or stoneware), marked with the symbol "RID/ADR" according to 6.1.3.1 (a) (ii);
- light gauge metal packagings, marked with the symbol "RID/ADR" according to 6.1.3.1 (a) (ii) intended for substances with a viscosity at 23 °C exceeding 200 mm²/s.

6.1.5.5.2 *Number of test samples:* three test samples per design type and manufacturer.

6.1.5.5.3 *Special preparation of packagings for testing:* either vented closures shall be replaced by similar non-vented closures or the vent shall be sealed.

6.1.5.5.4 *Test method and pressure to be applied:* metal packagings and composite packagings (glass, porcelain or stoneware), including their closures, shall be subjected to the test pressure for 5 minutes. Plastics packagings and composite packagings (plastics material) including their closures shall be subjected to the test pressure for 30 minutes. This pressure is the one to be included in the marking required by 6.1.3.1 (d). The manner in which the packagings are supported shall not invalidate the test. The test pressure shall be applied continuously and evenly; it shall be kept constant throughout the test period. The hydraulic pressure (gauge) applied, as determined by any one of the following methods, shall be:

- (a) not less than the total gauge pressure measured in the packaging (i.e. the vapour pressure of the filling liquid and the partial pressure of the air or other inert gases, minus 100 kPa) at 55 °C, multiplied by a safety factor of 1.5; this total gauge pressure shall be determined on the basis of a maximum degree of filling in accordance with 4.1.1.4 and a filling temperature of 15 °C; or
- (b) not less than 1.75 times the vapour pressure at 50 °C of the liquid to be carried, minus 100 kPa but with a minimum test pressure of 100 kPa; or
- (c) not less than 1.5 times the vapour pressure at 55 °C of the liquid to be carried, minus 100 kPa but with a minimum test pressure of 100 kPa.

6.1.5.5.5 In addition, packagings intended to contain liquids of packing group I shall be tested to a minimum test pressure of 250 kPa (gauge) for a test period of 5 or 30 minutes depending upon the material of construction of the packaging.

6.1.5.5.6 *Criterion for passing the test:* no packaging may leak.

6.1.5.6 Stacking test

All design types of packagings other than bags and other than non-stackable composite packagings (glass, porcelain, or stoneware), marked with the symbol "RID/ADR" according to 6.1.3.1 (a) (ii) shall be subjected to a stacking test.

6.1.5.6.1 *Number of test samples:* three test samples per design type and manufacturer.

6.1.5.6.2 *Test method:* the test sample shall be subjected to a force applied to the top surface of the test sample equivalent to the total weight of identical packages which might be stacked on it during carriage; where the contents of the test sample are liquids with relative density different from that of the liquid to be carried, the force shall be calculated in relation to the latter. The minimum height of the stack including the test sample shall be 3 metres. The duration of the test shall be 24 hours except that plastics drums, jerricans, and composite packagings 6HH1 and 6HH2 intended for liquids shall be subjected to the stacking test for a period of 28 days at a temperature of not less than 40 °C.

For the test in accordance with 6.1.5.2.5, the original filling substance shall be used. For the test in accordance with 6.1.5.2.6, a stacking test shall be carried out with a standard liquid.

6.1.5.6.3 *Criteria for passing the test:* no test sample shall leak. In composite packagings or combination packagings, there shall be no leakage of the filling substance from the inner receptacle or inner packaging. No test sample shall show any deterioration which could adversely affect transport safety or any distortion liable to reduce its strength or cause instability in stacks of packages. Plastics packagings shall be cooled to ambient temperature before the assessment.

6.1.5.7 ***Cooperage test for bung type wooden barrels***

6.1.5.7.1 *Number of samples:* one barrel.

6.1.5.7.2 *Method of testing:* remove all hoops above the bilge of an empty barrel at least two days old.

6.1.5.7.3 *Criterion for passing test:* the diameter of the cross section of the upper part of the barrel shall not increase by more than 10 %.

6.1.5.8 ***Supplementary permeability test for plastics drums and jerricans in accordance with 6.1.4.8 and for composite packagings (plastics material) in accordance with 6.1.4.19 intended for the carriage of liquids having a flash-point ≤ 61 °C, other than 6HA1 packagings***

Polyethylene packagings need be subjected to this test only if they are to be approved for the carriage of benzene, toluene, xylene or mixtures and preparations containing those substances.

6.1.5.8.1 *Number of test samples:* three packagings per design type and manufacturer.

6.1.5.8.2 *Special preparation of the test sample for the test:* the test samples are to be pre-stored with the original filling substance in accordance with 6.1.5.2.5, or, for high molecular mass polyethylene packagings, with the standard liquid mixture of hydrocarbons (white spirit) in accordance with 6.1.5.2.6.

6.1.5.8.3 *Test method:* the test samples filled with the substance for which the packaging is to be approved shall be weighed before and after storage for 28 days at 23 °C and 50 % relative atmospheric humidity. For high molecular mass polyethylene packagings, the test may be carried out with the standard liquid mixture of hydrocarbons (white spirit) in place of benzene, toluene or xylene.

6.1.5.8.4 *Criterion for passing the test:* permeability shall not exceed 0.008 g/l.h.

6.1.5.9 ***Test Report***

6.1.5.9.1 A test report containing at least the following particulars shall be drawn up and shall be available to the users of the packaging:

1. Name and address of the test facility;
2. Name and address of applicant (where appropriate);
3. A unique test report identification;
4. Date of the test report;
5. Manufacturer of the packaging;
6. Description of the packaging design type (e.g. dimensions, materials, closures, thickness, etc.), including method of manufacture (e.g. blow moulding) and which may include drawing(s) and/or photograph(s);
7. Maximum capacity;
8. Characteristics of test contents, e.g. viscosity and relative density for liquids and particle size for solids;
9. Test descriptions and results;
10. The test report shall be signed with the name and status of the signatory.

6.1.5.9.2 The test report shall contain statements that the packaging prepared as for carriage was tested in accordance with the appropriate requirements of this section and that the use of other packaging methods or components may render it invalid. A copy of the test report shall be available to the competent authority.

6.1.6 Standard liquids for verifying the chemical compatibility of high or average molecular mass polyethylene packagings in accordance with 6.1.5.2.6 and list of substances to which the standard liquids may be regarded as equivalents

6.1.6.1 *Standard liquids for verifying the chemical compatibility of high or average molecular mass polyethylene packagings in accordance with 6.1.5.2.6*

The following standard liquids shall be used for this plastics material.

- (a) ***Wetting Solution*** for substances causing severe cracking in polyethylene under stress, in particular for all solutions and preparations containing wetting agents.

An aqueous solution of 1 to 10 % of a wetting agent shall be used. The surface tension of this solution shall be 31 to 35 mN/m at 23 °C.

The stacking test shall be carried out on the basis of a relative density of not less than 1.20.

A compatibility test with acetic acid is not required if adequate chemical compatibility is proved with a wetting solution.

For filling substances causing cracking in polyethylene under stress which is resistant to the wetting solution, adequate chemical compatibility may be proved after preliminary storing for three weeks at 40 °C in accordance with 6.1.5.2.6, but with the original filling matter.

- (b) ***Acetic acid*** for substances and preparations causing cracking in polyethylene under stress, in particular for monocarboxylic acids and monovalent alcohols.

Acetic acid in 98 to 100 % concentration shall be used.
Relative density = 1.05.

The stacking test shall be carried out on the basis of a relative density not less than 1.1.

In the case of filling substances causing polyethylene to swell more than acetic acid and to such an extent that the polyethylene mass is increased by up to 4 %, adequate chemical compatibility may be proved after preliminary storing for three weeks at 40 °C, in accordance with 6.1.5.2.6 but with the original filling matter.

- (c) ***Normal butyl acetate/normal butyl acetate-saturated wetting solution*** for substances and preparations causing polyethylene to swell to such an extent that the polyethylene mass is increased by about 4 % and at the same time causing cracking under stress, in particular for phyto-sanitary products, liquid paints and esters. Normal butyl acetate in 98 to 100 % concentration shall be used for preliminary storage in accordance with 6.1.5.2.6.

For the stacking test in accordance with 6.1.5.6, a test liquid consisting of a 1 to 10 % aqueous wetting solution mixed with 2 % normal butyl acetate conforming to (a) above shall be used.

The stacking test shall be carried out on the basis of a relative density not less than 1.0.

In the case of filling substances causing polyethylene to swell more than normal butyl acetate and to such an extent that the polyethylene mass is increased by up to 7.5 %, adequate chemical compatibility may be proved after preliminary storing for three weeks at 40 °C, in accordance with 6.1.5.2.6 but with the original filling matter.

- (d) **Mixture of hydrocarbons (white spirit)** for substances and preparations causing polyethylene to swell, in particular for hydrocarbons, esters and ketones.

A mixture of hydrocarbons having a boiling range 160 °C to 220 °C, relative density 0.78-0.80, flash-point > 50 °C and an aromatic content 16 % to 21 % shall be used.

The stacking test shall be carried out on the basis of a relative density not less than 1.0.

In the case of filling substances causing polyethylene to swell to such an extent that the polyethylene mass is increased by more than 7.5 %, adequate chemical compatibility may be proved after preliminary storing for three weeks at 40 °C, in accordance with 6.1.5.2.6 but with the original filling matter.

- (e) **Nitric acid** for all substances and preparations having an oxidizing effect on polyethylene and causing molecular degradation identical to or less than 55 % nitric acid.

Nitric acid in a concentration of not less than 55 % shall be used.

The stacking test shall be carried out on the basis of a relative density of not less than 1.4.

In the case of filling substances more strongly oxidizing than 55 % nitric acid or causing degradation of the molecular mass proceed in accordance with 6.1.5.2.5.

The period of use shall be determined in such cases by observing the degree of damage (e.g. two years for nitric acid in not less than 55% concentration).

- (f) **Water** for substances which do not attack polyethylene in any of the cases referred to under (a) to (e), in particular for inorganic acids and lyes, aqueous saline solutions, polyvalent alcohols and organic substances in aqueous solution.

The stacking test shall be carried out on the basis of a relative density of not less than 1.2.

6.1.6.2

List of substances to which the standard liquids may be regarded as equivalents for the purposes of 6.1.5.2.6

Class 3

<u>Substance</u>	<u>Standard Liquid</u>
Flammable liquids of packing group II, without subsidiary risk (classification code F1, packing group II)	
Substances having a vapour pressure at 50 °C of not more than 110 kPa (1.1 bar)	
- Crude petroleum and other crude oils	Mixture of hydrocarbons
- Hydrocarbons	Mixture of hydrocarbons
- Halogenated substances	Mixture of hydrocarbons
- Alcohols	Acetic acid
- Ethers	Mixture of hydrocarbons
- Aldehydes	Mixture of hydrocarbons
- Ketones	Mixture of hydrocarbons
- Esters	Normal butyl acetate where the swelling effect is up to 4 % (mass): other cases, mixture of hydrocarbons
Mixtures of above-mentioned substances having a boiling point or initial boiling point exceeding 35 °C, containing not more than 55 % nitrocellulose with a nitrogen content not exceeding 12.6 % (UN No. 2059).	Normal butyl acetate/normal butyl acetate-saturated wetting solution <u>and</u> mixture of hydrocarbons
Viscous substances that meet the classification criteria of 2.2.3.1.4	Mixture of hydrocarbons
Flammable liquids of packing group II, toxic (classification code FT1, packing group II)	
Methanol (UN No.1230)	Acetic acid
Flammable liquids of packing group III, without subsidiary risk (classification code F1, packing group III)	
- Petroleum, solvent naphtha	Mixture of hydrocarbons
- White spirit (turpentine substitute)	Mixture of hydrocarbons
- Hydrocarbons	Mixture of hydrocarbons
- Halogenated substances	Mixture of hydrocarbons
- Alcohols	Acetic acid
- Ethers	Mixture of hydrocarbons
- Aldehydes	Mixture of hydrocarbons
- Ketones	Mixture of hydrocarbons
- Esters	Normal butyl acetate where the swelling effect is up to 4 % (mass): other cases, mixture of hydrocarbons
- Nitrogenous substances	Mixture of hydrocarbons
Mixtures of above-mentioned substances containing not more than 55 % nitrocellulose with a nitrogen content not exceeding 12.6 % (UN No. 2059).	Normal butyl acetate/normal butyl acetate-saturated wetting solution <u>and</u> mixture of hydrocarbons

Class 5.1

Oxidizing liquids, corrosive (classification code OC1)	
Hydrogen peroxides, aqueous solutions with not less than 20 % but not more than 60 % hydrogen peroxide (UN No. 2014) ⁴	Water
Perchloric acid with more than 50 % but not more than 72 % acid (mass) (UN No. 1873)	Nitric acid
Oxidizing liquids, without subsidiary risk (classification code O1)	
Hydrogen peroxide, aqueous solutions with not less than 8 % but less than 20% hydrogen peroxide (UN No. 2984) ⁴	Water
Calcium chlorate solution (UN No.2429)	Water
Potassium chlorate solution (UN No. 2427)	Water
Sodium chlorate solution (UN No. 2428)	Water

Class 5.2

NOTE: <i>tert-butyl hydroperoxide with more than 40 % peroxide content and peroxyacetic acids are excluded.</i>	
All organic peroxides in a technically pure form or in solution in solvents which, as far as their compatibility is concerned, are covered by the standard liquid "mixture of hydrocarbons" in this list (UN Nos. 3101, 3103, 3105, 3107, 3109, 3111, 3113, 3115, 3117, 3119)	Normal butyl acetate/ wetting solution with 2% normal butyl acetate <u>and</u> mixture of hydrocarbons <u>and</u> nitric acid at 55%
Compatibility of vents and gaskets with organic peroxides may be verified, also independently of the design type test, by laboratory tests with nitric acid.	

Class 6.1

Toxic organic liquids without subsidiary risk (classification code T1)	
Aniline (UN No.1547)	Acetic acid
Furfuryl alcohol (UN No. 2874)	Acetic acid
Phenol solution (UN No. 2821, packing group III)	Acetic acid
Toxic organic liquids, corrosive (classification code TC1)	
Cresols (UN No. 2076) or cresylic acid (UN No. 2022)	Acetic acid

Class 6.2

All infectious substances (UN Nos. 2814 and 2900, risk group 2, and UN No.3291) considered to be liquids in accordance with 2.1.2.6	Water
---	-------

⁴ Test to be performed only with a vent.

Class 8

Corrosive acid inorganic liquids, without subsidiary risk (classification code C1)	
Sulphuric acid (UN Nos. 1830 and 2796)	Water
Sulphuric acid, spent (UN No. 1832)	Water
Nitric acid (UN No. 2031) with not more than 55 % acid	Nitric acid
Perchloric acid with not more than 50 % acid, by mass in aqueous solution (UN No. 1802)	Nitric acid
Hydrochloric acid (UN No. 1789) with not more than 36 % pure acid Hydrobromic acid (UN No. 1788) Hydriodic acid (UN No. 1787)	Water
Hydrofluoric acid (UN No. 1790) with not more than 60 % hydrogen fluoride ⁵	Water
Fluoroboric acid (UN No. 1775) with not more than 50 % pure acid	Water
Fluorosilicic acid (UN No. 1778)	Water
Chromic acid solution (UN No. 1755) with not more than 30 % pure acid	Nitric acid
Phosphoric acid (UN No. 1805)	Water
Corrosive acid organic liquids (classification code C3)	
Acrylic acid (UN No. 2218), formic acid (UN No. 1779), acetic acid (UN Nos. 2789 and 2790), thioglycolic acid (UN No. 1940)	Acetic acid
Methacrylic acid (UN No. 2531), propionic acid (UN No. 1848)	Acetic acid
Alkylphenols, liquid, n.o.s. (UN No. 3145, packing group III)	Acetic acid
Corrosive basic inorganic liquids, without subsidiary risk (classification code C5)	
Sodium hydroxide solution (UN No. 1824), potassium hydroxide solution (UN No. 1814)	Water
Ammonia solution (UN No. 2672)	Water
Other corrosive liquids (classification code C9)	
Chlorite solution (UN No. 1906) and hypochlorite solution ⁶ (UN No. 1791, packing group III)	Nitric acid
Formaldehyde solutions (UN No. 2209)	Water
Corrosive liquids toxic (classification code CT1)	
Hydrazine, aqueous solutions with more than 37 % hydrazine, by mass (UN No. 2030)	Water

⁵ Maximum 60 litres; permissible period of use two years.

⁶ Test to be carried out only with vent. If the test is carried out with nitric acid as the standard liquid, an acid-resistant vent and gasket shall be used. For hypochlorite solutions, vents and gaskets of the same design type, resistant to hypochlorite (e.g. of silicone rubber) but not resistant to nitric acid, are also permitted.

CHAPTER 6.2

REQUIREMENTS FOR THE CONSTRUCTION AND TESTING OF PRESSURE RECEPTACLES, AEROSOL DISPENSERS AND SMALL RECEPTACLES CONTAINING GAS (GAS CARTRIDGES)

6.2.1 General requirements

NOTE: For aerosol dispensers and small receptacles containing gas (gas cartridges) see 6.2.4.

6.2.1.1 Design and construction

6.2.1.1.1 Pressure receptacles and their closures shall be designed, calculated, manufactured, tested and equipped in such a way as to withstand all conditions to which they will be subjected during their normal use and during normal conditions of carriage.

In the design of pressure receptacles, all relevant factors shall be taken into account such as:

- internal pressure;
- ambient and operational temperatures, including during carriage;
- dynamic loads.

Normally the wall thickness shall be determined by calculation, accompanied, if needed, by experimental stress analysis. The wall thickness may be determined by experimental means.

Appropriate design calculations for the pressure envelope and supporting components shall be used to ensure the safety of the pressure receptacles concerned.

The minimum wall thickness to withstand pressure shall be calculated in particular with regard to:

- the calculation pressures, which shall not be less than the test pressure;
- the calculation temperatures allowing for appropriate safety margins;
- the maximum stresses and peak stress concentrations where necessary;
- factors inherent to the properties of the material.

Any additional thickness used for the purpose of providing a corrosion allowance shall not be taken into consideration in calculating the thickness of the walls.

For welded pressure receptacles, only metals of weldable quality whose adequate impact strength at an ambient temperature of - 20° C can be guaranteed shall be used.

The test pressure of pressure receptacles is prescribed in packing instruction P200 in 4.1.4.1 for cylinders, tubes, pressure drums and bundles of cylinders. The test pressure for cryogenic receptacles, closed, shall not be less than 1.3 times the maximum working pressure increased by 1 bar for vacuum insulated pressure receptacles.

Material characteristics to be considered are, when applicable:

- yield stress;
- tensile strength;
- time-dependent strength;
- fatigue data;
- Young's modulus (modulus of elasticity);
- appropriate amount of plastic strain;
- impact strength;
- fracture resistance.

6.2.1.1.2 Pressure receptacles for UN No.1001, acetylene, dissolved, shall be filled entirely with a porous material, uniformly distributed, of a type approved by the competent authority and which:

- (a) does not attack the pressure receptacles or form harmful or dangerous compounds either with the acetylene or with the solvent;
- (b) is capable of preventing the spread of decomposition of the acetylene in the mass.

The solvent shall not attack the pressure receptacles.

The above requirements, excluding those for the solvent, apply equally to pressure receptacles for UN No. 3374 acetylene, solvent free.

6.2.1.1.3 The following requirements apply to the construction of closed cryogenic receptacles for refrigerated liquefied gases:

- (a) The mechanical properties of the metal used shall be established for each pressure receptacle at the initial inspection, including the impact strength and the bending coefficient; with regard to the impact strength see 6.8.5.3;
- (b) The pressure receptacles shall be thermally insulated. The thermal insulation shall be protected against impact by means of continuous sheathing. If the space between the pressure receptacle and the sheathing is evacuated of air (vacuum-insulation), the protective sheathing shall be designed to withstand without permanent deformation an external pressure of at least 100 kPa (1 bar). If the sheathing is so closed as to be gas-tight (e.g. in the case of vacuum-insulation), a device shall be provided to prevent any dangerous pressure from developing in the insulating layer in the event of inadequate gas-tightness of the pressure receptacle or its fittings. The device shall prevent moisture from penetrating into the insulation.

6.2.1.1.4 Pressure receptacles assembled in bundles shall be structurally supported and held together as a unit. Pressure receptacles shall be secured in a manner that prevents movement in relation to the structural assembly and movement that would result in the concentration of harmful local stresses. Manifolds shall be designed such that they are protected from impact. For gases with a classification code of 2T, 2TF, 2TC, 2TO, 2TFC or 2TOC, means shall be provided to ensure that each pressure receptacle can be separately filled and that no interchange of pressure receptacle contents can occur during carriage.

6.2.1.2 *Materials of pressure receptacles*

The materials of which the pressure receptacles and their closures are made as well as all substances that might come into contact with the contents shall not be liable to attack the contents or form harmful or dangerous compounds therewith.

The following materials may be used:

- (a) carbon steel for compressed, liquefied, refrigerated liquefied gases and dissolved gases as well as for substances not in Class 2 listed in Table 3 of packing instruction P200 in 4.1.4.1;
- (b) alloy steel (special steels), nickel, nickel alloy (such as monel) for compressed, liquefied, refrigerated liquefied gases and dissolved gases as well as for substances not in Class 2 listed in Table 3 of packing instruction P200 in 4.1.4.1;
- (c) copper for:
 - (i) gases of classification codes 1A, 1O, 1F and 1TF, whose filling pressure referred to a temperature of 15 °C does not exceed 2 MPa (20 bar);
 - (ii) gases of classification code 2A and also UN No. 1033 dimethyl ether; UN No.1037 ethyl chloride; UN No.1063 methyl chloride; UN No.1079 sulphur dioxide; UN No.1085 vinyl bromide; UN No. 1086 vinyl chloride; and UN No.3300 ethylene oxide and carbon dioxide mixture with more than 87% ethylene oxide;
 - (iii) gases of classification codes 3A, 3O and 3F;
- (d) aluminium alloy: see special requirement "a" of packing instruction P200 (12) in 4.1.4.1;
- (e) composite material for compressed, liquefied, refrigerated liquefied gases and dissolved gases;
- (f) synthetic materials for refrigerated liquefied gases; and
- (g) glass for the refrigerated liquefied gases of classification code 3A other than UN No.2187 carbon dioxide, refrigerated, liquid or mixtures thereof, and gases of classification code 3O.

6.2.1.3 *Service equipment*

6.2.1.3.1 *Openings*

Pressure drums may be provided with openings for filling and discharge and with other openings intended for level gauges, pressure gauges or relief devices. The number of openings shall be kept to a minimum consistent with safe operations. Pressure drums may also be provided with an inspection opening, which shall be closed by an effective closure.

6.2.1.3.2 *Fittings*

- (a) If cylinders are fitted with a device to prevent rolling, this device shall not be integral with the valve cap;

- (b) Pressure drums which are capable of being rolled shall be equipped with rolling hoops or be otherwise protected against damage due to rolling (e.g. by corrosion resistant metal sprayed on to the pressure receptacle surface);
- (c) Pressure drums and cryogenic receptacles, which are not capable of being rolled, shall be fitted with devices (skids, rings, straps,) ensuring that they can be safely handled by mechanical means and so arranged as not to impair the strength of, nor cause undue stresses in, the wall of the pressure receptacle;
- (d) Bundles of cylinders shall be fitted with appropriate devices ensuring that they can be handled and carried safely. The manifold shall have at least the same test pressure as the cylinders. The manifold and the master cock shall be situated so as to be protected against any damage;
- (e) If level gauges, pressure gauges or relief devices are installed, they shall be protected in the same way as is required for valves in 4.1.6.4;
- (f) Pressure receptacles whose filling is measured by volume shall be provided with a level indicator.

6.2.1.3.3 *Safety valves*

Cryogenic receptacles, closed, shall be fitted with one or more pressure relief devices to protect the vessel against excess pressure. Excess pressure means a pressure in excess of 110% of the maximum working pressure due to normal heat leak or in excess of the test pressure due to the loss of vacuum for vacuum insulated pressure receptacles or due to the failure in the open position of a pressure build up system.

6.2.1.4 *Approval of pressure receptacles*

6.2.1.4.1 The conformity of pressure receptacles, having a test pressure capacity product of more than 150 MPa.litre (1 500 bar.litre) with the provisions of Class 2, shall be assessed by one of the following methods:

- (a) Single pressure receptacles shall be examined, tested and approved by a testing and certifying body approved by the competent authority of the country of approval¹, on the basis of the technical documentation and declaration of the manufacturer on compliance with the relevant provisions of Class 2.

The technical documentation shall include full specifications on design and construction, and full documentation on the manufacturing and testing; or

- (b) The construction of the pressure receptacles shall be tested and approved by a testing and certifying body approved by the competent authority of the country of approval¹ on the basis of the technical documentation with regard to their compliance with the relevant provisions of Class 2.

Pressure receptacles shall furthermore be designed, manufactured and tested according to a comprehensive quality assurance programme for design, manufacture, final inspection and testing. The quality assurance programme shall guarantee the conformity of the pressure receptacles with the relevant provisions of Class 2 and shall be approved and supervised by a testing and certifying body approved by the competent authority of the country of approval¹; or

¹ *If the country of approval is not a contracting party to ADR, the competent authority of a contracting party to ADR.*

- (c) The design type of the pressure receptacles shall be approved by a testing and certifying body approved by the competent authority of the country of approval¹. Any pressure receptacle of this design shall be manufactured and tested according to a quality assurance programme for production, final inspection and testing, which shall be approved and supervised by a testing and certifying body approved by the competent authority of the country of approval¹; or
- (d) The design type of the pressure receptacles shall be approved by a testing and certifying body approved by the competent authority of the country of approval¹. Any receptacle of this design shall be tested under the supervision of a testing and certifying body approved by the competent authority of the country of approval¹ on the basis of a declaration of the manufacturer on compliance with the approved design and the relevant provisions of Class 2.

6.2.1.4.2 The conformity of pressure receptacles having a test pressure capacity product of more than 30 MPa.litre (300 bar.litre) and not more than 150 MPa.litre (1 500 bar.litre) with the provisions of Class 2 shall be assessed by one of the methods described in 6.2.1.4.1 or by one of the following methods:

- (a) The pressure receptacles shall be designed, manufactured and tested according to a comprehensive quality assurance programme for their design, manufacture, final inspection and testing, approved and supervised by a testing and certifying body approved by the competent authority of the country of approval¹; or
- (b) The design type of the pressure receptacle shall be approved by a testing and certifying body approved by the competent authority of the country of approval¹. The compliance of any pressure receptacle with the approved design shall be declared in writing by the manufacturer on the basis of his quality assurance programme for final inspection and testing of pressure receptacles, approved and supervised by a testing and certifying body approved by the competent authority of the country of approval¹; or
- (c) The design type of the pressure receptacle shall be approved by a testing and certifying body approved by the competent authority of the country of approval¹. The compliance of any pressure receptacle with the approved design shall be declared in writing by the manufacturer and all pressure receptacles of this type shall be tested under the supervision of a testing and certifying body approved by the competent authority of the country of approval¹;

6.2.1.4.3 The conformity of pressure receptacles, having a test pressure capacity product of not more than 30 MPa.litre (300 bar.litre) with the provisions for Class 2 shall be assessed by one of the methods described in 6.2.1.4.1 or 6.2.1.4.2 or by one of the following methods:

- (a) The compliance of any pressure receptacle with a design, fully specified in technical documentation, shall be declared in writing by the manufacturer and pressure receptacles of this design shall be tested under the supervision of a testing and certifying body approved by the competent authority of the country of approval¹; or
- (b) The design type of the pressure receptacles shall be approved by a testing and certifying body approved by the competent authority of the country of approval¹. The compliance of all pressure receptacles with the approved design shall be declared in writing by the manufacturer and all pressure receptacles of this type shall be tested individually.

¹ If the country of approval is not a contracting party to ADR, the competent authority of a contracting party to ADR.

- 6.2.1.4.4 The requirements of 6.2.1.4.1 to 6.2.1.4.3 shall be deemed to be complied with:
- (a) as regards the quality assurance systems mentioned in 6.2.1.4.1 and 6.2.1.4.2, if they conform to the relevant European Standard of the EN ISO 9000 series;
 - (b) in their entirety, if the relevant conformity assessment procedures of Council Directive 99/36/EC² have been complied with as follows:
 - (i) for the pressure receptacles listed under 6.2.1.4.1, the modules G, or H1, or B in combination with D, or B in combination with F;
 - (ii) for the pressure receptacles listed under 6.2.1.4.2, the modules H, or B in combination with E, or B in combination C1, or B1 in combination with F, or B1 in combination with D;
 - (iii) for the pressure receptacles listed under 6.2.1.4.3, the modules A1, or D1, or E1.

6.2.1.4.5 *Requirements for manufacturers*

The manufacturer shall be technically competent and shall possess all suitable means required for the satisfactory manufacture of pressure receptacles; this relates in particular to qualified personnel:

- (a) to supervise the entire manufacturing process;
- (b) to carry out joining of materials;
- (c) to carry out the relevant tests.

The proficiency test of a manufacturer shall in all instances be carried out by a testing and certifying body approved by the competent authority of the country of approval¹. The particular certification process the manufacturer intends to apply shall be taken into consideration.

6.2.1.4.6 *Requirements for testing and certifying bodies*

Testing and certifying bodies shall be independent from manufacturing enterprises and technologically competent to the degree required. These requirements shall be deemed to be met if the bodies have been approved on the basis of an accreditation procedure in accordance with the relevant European standards of series EN 45000.

6.2.1.5 *Initial inspection and test*

6.2.1.5.1 New pressure receptacles shall be subjected to testing and inspection during and after manufacture in accordance with the following:

On an adequate sample of pressure receptacles:

- (a) Testing of the mechanical characteristics of the material of construction;

¹ If the country of approval is not a contracting party to ADR, the competent authority of a contracting party to ADR.

² Council Directive 99/36/EC concerning transportable pressure equipment (Official Journal of the European Communities, No. L 138 of 1.06.1999).

- (b) Verification of the minimum wall thickness;
- (c) Verification of the homogeneity of the material for each manufacturing batch, and inspection of the external and internal conditions of the pressure receptacles;
- (d) Inspection of the neck threads;
- (e) Verification of the conformance with the design standard;

For all pressure receptacles:

- (f) A hydraulic pressure test. Pressure receptacles shall withstand the test pressure without undergoing permanent deformation or exhibiting cracks;

NOTE : With the agreement of the inspection body, the hydraulic pressure test may be replaced by a test using a gas, where such an operation does not entail any danger.

- (g) Inspection and assessment of manufacturing defects and either repairing them or rendering the pressure receptacles unserviceable;
- (h) An inspection of the markings on the pressure receptacles;
- (i) In addition, pressure receptacles intended for the carriage of UN No. 1001 acetylene, dissolved, and UN No. 3374 acetylene, solvent free, shall be inspected to ensure proper installation and condition of the porous material and the quantity of solvent.

6.2.1.5.2 *Specific provisions applying to aluminium alloy pressure receptacles*

- (a) In addition to the initial inspection required by 6.2.1.5.1, it is necessary to test for possible intercrystalline corrosion of the inside wall of the pressure receptacles where use is made of an aluminium alloy containing copper, or where use is made of an aluminium alloy containing magnesium and manganese and the manganese content is greater than 3.5% or the manganese content lower than 0.5%.
- (b) In the case of an aluminium/copper alloy the test shall be carried out by the manufacturer at the time of approval of a new alloy by the competent authority; it shall thereafter be repeated in the course of production, for each pour of the alloy.
- (c) In the case of an aluminium/magnesium alloy the test shall be carried out by the manufacturer at the time of approval of a new alloy and of the manufacturing process by the competent authority. The test shall be repeated whenever a change is made in the composition of the alloy or in the manufacturing process.

6.2.1.6 *Periodic inspection and test*

6.2.1.6.1 Refillable pressure receptacles shall be subjected to periodic inspections under the supervision of a testing and certifying body approved by the competent authority of the country of approval¹, in accordance with the periodicities defined in the relevant packing instruction P200 or P203 in 4.1.4.1 and in accordance with the following specifications:

- (a) External examination of the pressure receptacle, equipment and markings;

¹ *If the country of approval is not a contracting party to ADR, the competent authority of a contracting party to ADR.*

- (b) Internal examination of the pressure receptacle (e.g. by weighing, examination of the internal condition, checks of wall thickness);
- (c) Checking of the neck threads if the fittings are removed;
- (d) The hydraulic pressure test and, if necessary, inspection of the characteristics of the material by suitable tests.

NOTE 1: *With the agreement of the testing and certifying body approved by the competent authority of the country of approval ¹, the hydraulic pressure test may be replaced by a test using a gas, where such operation does not entail any danger, or by an equivalent method based on ultrasound.*

NOTE 2: *With the agreement of the testing and certifying body approved by the competent authority of the country of approval ¹, the hydraulic pressure test of cylinders and tubes may be replaced by an equivalent method based on acoustic emission.*

NOTE 3: *With the agreement of the testing and certifying body approved by the competent authority of the country of approval ¹, the hydraulic pressure test of each welded steel cylinder intended for the carriage of gases of UN No.1965, hydrocarbon gas mixture liquefied, n.o.s., with a capacity below 6,5 l may be replaced by another test ensuring an equivalent level of safety.*

6.2.1.6.2 For pressure receptacles intended for the carriage of UN No. 1001 acetylene, dissolved, and UN No. 3374 acetylene, solvent free, only the external condition (corrosion, deformation) and the condition of the porous mass (loosening, settlement) shall be required to be examined.

6.2.1.6.3 By derogation from 6.2.1.6.1 (d) closed cryogenic receptacles shall be inspected to verify external conditions, condition and operation of pressure relief devices and subjected to a leakproofness test. The leakproofness test shall be carried out with the gas contained in the pressure receptacle or with an inert gas. Checking shall be performed by means of a pressure gauge or by vacuum measurement. The thermal insulation need not be removed.

6.2.1.7 *Marking of refillable pressure receptacles*

Refillable pressure receptacles shall be marked clearly and legibly with certification and gas or pressure receptacle specific marks. These marks shall be permanently affixed (e.g. stamped, engraved, or etched) on the pressure receptacle. The marks shall be on the shoulder, top end or neck of the pressure receptacle or on a permanently affixed component of the pressure receptacle (e.g. welded collar).

The minimum size of the marks shall be 5 mm for pressure receptacles with a diameter greater than or equal to 140 mm and 2.5 mm for pressure receptacles with a diameter less than 140 mm.

6.2.1.7.1 The following certification marks shall be applied:

- (a) The technical standard used for design, construction and testing, as listed in the table under 6.2.2 or the approval number;
- (b) The character(s) identifying the country of approval as indicated by the distinguishing signs of motor vehicles in international traffic;

¹ *If the country of approval is not a contracting party to ADR, the competent authority of a contracting party to ADR.*

- (c) The identity mark or stamp of the inspection body that is registered with the competent authority of the country authorizing the marking;
- (d) The date of the initial inspection, the year (four digits) followed by the month (two digits) separated by a slash (i.e. "/").

6.2.1.7.2 The following operational marks shall be applied:

- (e) The test pressure in bar, preceded by the letters "PH" and followed by the letters "BAR";
- (f) The empty mass of the pressure receptacle including all permanently attached integral parts (e.g. neck ring, foot ring, etc.) in kilograms, followed by the letters "KG". With the exception of pressure receptacles of UN No. 1965 hydrocarbon gas mixture, liquefied, n.o.s., this mass shall not include the mass of valve, valve cap or valve guard, any coating, or porous mass for acetylene. The empty mass shall be expressed to three significant figures rounded up to the last digit. For cylinders of less than 1 kg, the mass shall be expressed to two significant figures rounded up to the last digit;
- (g) The minimum guaranteed wall thickness of the pressure receptacle in millimetres followed by the letters "MM". This mark is not required for pressure receptacles of UN No. 1965 hydrocarbon gas mixture, liquefied, n.o.s., nor for pressure receptacles with a water capacity less than or equal to 1 l or for composite cylinders;
- (h) In the case of pressure receptacles intended for the carriage of compressed gases, UN No. 1001 acetylene, dissolved, and UN No. 3374 acetylene, solvent free, the working pressure in bar, preceded by the letters "PW";
- (i) In the case of liquefied gases, the water capacity in litres expressed to three significant digits rounded down to the last digit, followed by the letter "L". If the value of the minimum or nominal water capacity is an integer, the digits after the decimal point may be neglected;
- (j) In the case of UN No. 1001 acetylene, dissolved, the total of the mass of the empty receptacle, the fittings and accessories not removed during filling, the porous material, the solvent and the saturation gas expressed to two significant figures rounded down to the last digit followed by the letters "KG";
- (k) In the case of UN No. 3374 acetylene, solvent free, the total of the mass of the empty receptacle, the fittings and accessories not removed during filling and the porous material expressed to two significant figures rounded down to the last digit followed by the letters "KG".

6.2.1.7.3 The following manufacturing marks shall be applied:

- (l) Identification of the cylinder thread (e.g. 25E). This mark is not required for pressure receptacles of UN No. 1965 hydrocarbon gas mixture, liquefied, n.o.s.;
- (m) The manufacturer's mark registered by the competent authority. When the country of manufacture is not the same as the country of approval, then the manufacturer's mark shall be preceded by the character(s) identifying the country of manufacture as indicated by the distinguishing signs of motor vehicles in international traffic. The country mark and the manufacturer's mark shall be separated by a space or slash;
- (n) The serial number assigned by the manufacturer;

- (o) In the case of steel pressure receptacles and composite pressure receptacles with steel liner intended for the carriage of gases with a risk of hydrogen embrittlement, the letter "H" showing compatibility of the steel (see ISO 11114-1:1997).

6.2.1.7.4 The above marks shall be placed in three groups.

- Manufacturing marks shall be the top grouping and shall appear consecutively in the sequence given in 6.2.1.7.3.
- The middle grouping shall include the test pressure (e) which shall be immediately preceded by the working pressure (h) when the latter is required.
- Certification marks shall be the bottom grouping and shall appear in the sequence given in 6.2.1.7.1.

6.2.1.7.5 Other marks are allowed in areas other than the side wall, provided they are made in low stress areas and are not of a size and depth that will create harmful stress concentrations. Such marks shall not conflict with required marks.

6.2.1.7.6 In addition to the preceding marks, each refillable pressure receptacle shall be marked indicating the date (year (two digits) followed by the month (two digits) separated by a slash (i.e. "/")) of the last periodic inspection and the registered mark of the inspection body authorized by the competent authority of the country of use.

NOTE: The month need not be indicated for gases for which the interval between periodic inspections is ten years or more [see 4.1.4.1 packing instructions P200(8) and P203 (8)].

6.2.1.7.7 For acetylene cylinders, with the agreement of the competent authority, the date of the most recent periodic inspection and the stamp of the expert may be engraved on a ring affixed to the cylinder when the valve is installed and which is removable only by disconnecting the valve from the cylinder.

6.2.1.8 *Marking of non-refillable pressure receptacles*

Non-refillable pressure receptacles shall be marked clearly and legibly with certification and gas or pressure receptacle specific marks. These marks shall be permanently affixed (e.g. stencilled, stamped, engraved, or etched) on the pressure receptacle. Except when stencilled, the marks shall be on the shoulder, top end or neck of the pressure receptacle or on a permanently affixed component of the pressure receptacle (e.g. welded collar). Except for the "DO NOT REFILL" mark, the minimum size of the marks shall be 5mm for pressure receptacles with a diameter greater than or equal to 140 mm and 2.5 mm for pressure receptacles with a diameter less than 140 mm. The minimum size of the "DO NOT REFILL" mark shall be 5 mm.

6.2.1.8.1 The marks listed in 6.2.1.7.1 to 6.2.1.7.3 shall be applied with the exception of (f), (g), and (l). The serial number (n) may be replaced by the batch number. In addition, the words "DO NOT REFILL" in letters of at least 5 mm in height are required.

6.2.1.8.2 The requirements of 6.2.1.7.4 shall apply.

NOTE: Non-refillable pressure receptacles may, on account of their size, substitute this marking by a label (see 5.2.2.2.1.2).

6.2.1.8.3 Other marks are allowed provided they are made in low stress areas other than the side wall and are not of a size and depth that will create harmful stress concentrations. Such marks shall not conflict with required marks."

6.2.2 Pressure receptacles designed, constructed and tested according to standards

The requirements of 6.2.1 are considered to have been complied with if the following standards, as relevant, are applied:

Reference	Title of document	Applicable sub-sections and paragraphs
<i>for materials</i>		
EN 1797:2001	Cryogenic vessels - Gas/material compatibility	6.2.1.2
EN ISO 11114-1:1997	Transportable gas cylinders - Compatibility of cylinder and valve materials with gas contents-Part 1: Metallic materials.	6.2.1.2
EN ISO 11114-2:2000	Transportable gas cylinders - Compatibility of cylinder and valve materials with gas contents-Part 2: Non-metallic materials.	6.2.1.2
<i>for cylinders</i>		
Annex I, Parts 1 to 3 to 84/525/EEC	Council directive on the approximation of the laws of the Member States relating to seamless steel gas cylinders.	6.2.1.1 and 6.2.1.5
Annex I, Parts 1 to 3 to 84/526/EEC	Council directive on the approximation of the laws of the Member States relating to seamless, unalloyed aluminium and aluminium alloy gas cylinders.	6.2.1.1 and 6.2.1.5
Annex I, Parts 1 to 3 to 84/527/EEC	Council directive on the approximation of the laws of the Member States relating to welded unalloyed steel gas cylinders.	6.2.1.1 and 6.2.1.5
EN 1442:1998	Transportable refillable welded steel cylinders for liquefied petroleum gas (LPG) - Design and construction.	6.2.1.1 and 6.2.1.5
EN 1800:1998/AC: 1999	Transportable gas cylinders - Acetylene cylinders - Basic requirements and definitions.	6.2.1.1.2
EN 1964-1:1999	Transportable gas cylinders – Specifications for the design and construction of refillable transportable seamless steel gas cylinders of capacity from 0.5 litres up to 150 litres – Part 1: Cylinders made of seamless steel with a Rm value of less than 1 100 MPa.	6.2.1.1 and 6.2.1.5
EN 1975:1999 (except Annex G)	Transportable gas cylinders – Specifications for the design and construction of refillable transportable seamless aluminium and aluminium alloy gas cylinders of capacity from 0.5 litres up to 150 litres.	6.2.1.1 and 6.2.1.5
EN ISO 11120:1999	Gas cylinders – Refillable seamless steel tubes for compressed gas transport of water capacity between 150 litres and 3 000 litres – Design, construction and testing.	6.2.1.1 and 6.2.1.5
EN 1964-3: 2000	Transportable gas cylinders-Specifications for the design and construction of refillable transportable seamless steel gas cylinders of capacity from 0.5 litre up to 150 litres - Part 3: Cylinders made of stainless steel.	6.2.1.1 and 6.2.1.5
EN 12862: 2000	Transportable gas cylinders- Specifications for the design and construction of refillable transportable welded aluminium alloy gas cylinders.	6.2.1.1 and 6.2.1.5
EN 1251-2: 2000	Cryogenic vessels- Transportable, vacuum insulated, of not more than 1 000 litres volume- Part 2: Design, fabrication, inspection and testing	6.2.1.1 and 6.2.1.5
EN 1251-3: 2000	Cryogenic vessels- Transportable, vacuum insulated, of not more than 1 000 litres volume- Part 3: Operational requirements	6.2.1.6

Reference	Title of document	Applicable sub-sections and paragraphs
<i>for closures</i>		
EN 849:1996/A2:2001	Transportable gas cylinders - Cylinder valves: Specification and type testing	6.2.1.1

6.2.3 Requirements for pressure receptacles not designed, constructed and tested according to standards

Pressure receptacles not designed, constructed and tested according to standards listed in the table of 6.2.2 shall be designed, constructed and tested in accordance with the provisions of a technical code providing the same level of safety and recognised by the competent authority. The requirements of 6.2.1 and the following requirements however shall be met:

6.2.3.1 *Metal cylinders, tubes, pressure drums and bundles of cylinders*

At the test pressure, the stress in the metal at the most severely stressed point of the pressure receptacle shall not exceed 77% of the guaranteed minimum yield stress (Re).

"Yield stress" means the stress at which a permanent elongation of 2 per thousand (i.e. 0.2%) or, for austenitic steels, 1% of the gauge length on the test-piece, has been produced.

NOTE: In the case of sheet-metal the axis of the tensile test-piece shall be at right angles to the direction of rolling. The permanent elongation at fracture, shall be measured on a test-piece of circular cross-section in which the gauge length "l" is equal to five times the diameter "d" (l=5d); if test pieces of rectangular cross-section are used, the gauge length "l" shall be calculated by the formula:

$$l = 5.65 \sqrt{F_0}$$

where F_0 indicates the initial cross-sectional area of the test-piece.

Pressure receptacles and their closures shall be made of suitable materials which shall be resistant to brittle fracture and to stress corrosion cracking between -20 °C and +50 °C.

Welds shall be skilfully made and shall afford the fullest safety.

6.2.3.2 Additional provisions relating to aluminium-alloy pressure receptacles for compressed gases, liquefied gases, dissolved gases and non pressurized gases subject to special requirements (gas samples) as well as articles containing gas under pressure other than aerosol dispensers and small receptacles containing gas (gas cartridges)

6.2.3.2.1 *The materials of aluminium-alloy pressure receptacles which are to be accepted shall satisfy the following requirements:*

	A	B	C	D
Tensile strength, Rm, in MPa (=N/mm ²)	49 to 186	196 to 372	196 to 372	343 to 490
Yield stress, Re, in MPa (=N/mm ²) (permanent set λg = 0.2%)	10 to 167	59 to 314	137 to 334	206 to 412
Permanent elongation at fracture (l = 5d) in per cent	12 to 40	12 to 30	12 to 30	11 to 16
Bend test (diameter of former d = n × e, where e is the thickness of the test piece)	n=5(Rm ≤ 98) n=6(Rm > 98)	n=6(Rm ≤ 325) n=7(Rm > 325)	n=6(Rm ≤ 325) n=7(Rm > 325)	n=7(Rm ≤ 392) n=8(Rm > 392)
Aluminium Association Series Number ^a	1 000	5 000	6 000	2 000

^a See "Aluminium Standards and Data", Fifth edition, January 1976, published by the Aluminium Association, 750 Third Avenue, New York.

The actual properties will depend on the composition of the alloy concerned and on the final treatment of the pressure receptacle, but whatever alloy is used the thickness of the pressure receptacle shall be calculated by one of the following formulae:

$$e = \frac{P_{\text{MPa}} D}{\frac{2R_e}{1.3} + P_{\text{MPa}}} \quad \text{or} \quad e = \frac{P_{\text{bar}} D}{\frac{20R_e}{1.3} + P_{\text{bar}}}$$

where e = minimum thickness of pressure receptacle wall, in mm;
P_{MPa} = test pressure, in MPa
P_{bar} = test pressure, in bar
D = nominal external diameter of the pressure receptacle, in mm; and
Re = guaranteed minimum proof stress with 0.2% proof stress, in MPa (=N/mm²)

In addition, the value of the minimum guaranteed proof stress (Re) introduced into the formula is in no case to be greater than 0.85 times the guaranteed minimum tensile strength (Rm), whatever the type of alloy used.

NOTE 1: *The above characteristics are based on previous experience with the following materials used for pressure receptacles:*

Column A: Aluminium, unalloyed, 99.5 g pure;

Column B: Alloys of aluminium and magnesium;

Column C: Alloys of aluminium, silicon and magnesium, such as ISO/R209-Al-Si-Mg (Aluminium Association 6351);

Column D: Alloys of aluminium, copper and magnesium;

NOTE 2: The permanent elongation at fracture is measured by means of test-pieces of circular cross-section in which the gauge length "l" is equal to five times the diameter "d" ($l = 5d$); if test-pieces of rectangular section are used the gauge length shall be calculated by the formula:

$$l = 5.65 \sqrt{F_0}$$

where F_0 is the initial cross-section area of the test-piece.

- NOTE 3:**
- (a) The bend test (see diagram) shall be carried out on specimens obtained by cutting into two equal parts of width $3e$, but in no case less than 25 mm, an annular section of a cylinder. The specimens shall not be machined elsewhere than on the edges.
 - (b) The bend test shall be carried out between a mandrel of diameter (d) and two circular supports separated by a distance of $(d + 3e)$. During the test the inner faces shall be separated by a distance not greater than the diameter of the mandrel.
 - (c) The specimen shall not exhibit cracks when it has been bent inwards around the mandrel until the inner faces are separated by a distance not greater than the diameter of the mandrel.
 - (d) The ratio (n) between the diameter of the mandrel and the thickness of the specimen shall conform to the values given in the table.

Diagram of bend test

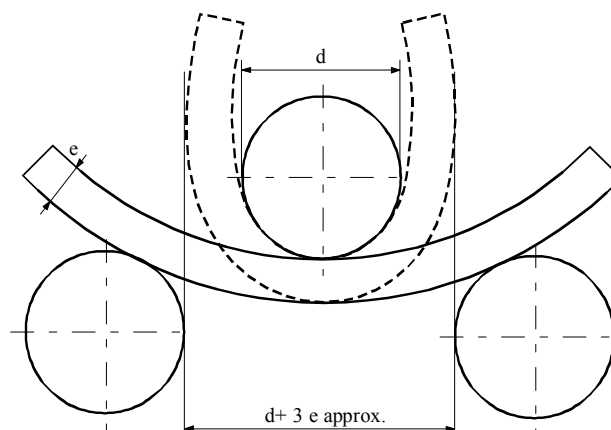

6.2.3.2.2

A lower minimum elongation value is acceptable on condition that an additional test approved by the competent authority of the country in which the pressure receptacles are made proves that safety of carriage is ensured to the same extent as in the case of pressure receptacles constructed to comply with the characteristics given in the table in 6.2.3.2.1 (see also annex G of EN 1975: 1999).

- 6.2.3.2.3 The wall thickness of the pressure receptacles at the thinnest point shall be the following:
- where the diameter of the pressure receptacle is less than 50 mm: not less than 1.5 mm;
 - where the diameter of the pressure receptacle is from 50 to 150 mm: not less than 2 mm; and
 - where the diameter of the pressure receptacle is more than 150 mm: not less than 3 mm.

6.2.3.2.4 The ends of the pressure receptacles shall have a semicircular, elliptical or "basket-handle" section; they shall afford the same degree of safety as the body of the pressure receptacle.

6.2.3.3 *Pressure receptacles in composite materials*

For composite cylinders, tubes, pressure drums and bundles of cylinders which make use of composite materials i.e. comprising a liner hoop wrapped or fully wrapped with reinforcement material, the construction shall be such that a minimum burst ratio (burst pressure divided by test pressure) is:

- 1.67 for hoop wrapped pressure receptacles;
- 2.00 for fully wrapped pressure receptacles.

6.2.3.4 *Closed cryogenic receptacles*

The following requirements apply to the construction of closed cryogenic receptacles for refrigerated liquefied gases:

- 6.2.3.4.1 If non-metallic materials are used, they shall resist brittle fracture at the lowest working temperature of the pressure receptacle and its fittings;
- 6.2.3.4.2 Pressure receptacles shall be fitted with a safety valve which shall be capable of opening at the working pressure shown on the pressure receptacle. The valves shall be so constructed as to work perfectly even at their lowest working temperature. Their reliability of functioning at that temperature shall be established and checked by testing each valve or a sample of valves of the same type of construction;
- 6.2.3.4.3 The vents and safety valves of pressure receptacles shall be so designed as to prevent the liquid from splashing out;

6.2.4 *General requirements for aerosol dispensers and small receptacles containing gas (gas cartridges)*

6.2.4.1 *Design and construction*

- 6.2.4.1.1 Aerosol dispensers (UN No.1950 aerosols) containing only a gas or a mixture of gases, and small receptacles containing gas (gas cartridges) (UN No. 2037), shall be made of metal. This requirement shall not apply to aerosols and small receptacles containing gas (gas cartridges) with a maximum capacity of 100 ml for UN No. 1011 butane. Other aerosol dispensers (UN No.1950 aerosols) shall be made of metal, synthetic material or glass. Receptacles made of metal and having an outside diameter of not less than 40 mm shall have a concave bottom.

- 6.2.4.1.2 The capacity of receptacles made of metal shall not exceed 1 000 ml; that of receptacles made of synthetic material or of glass shall not exceed 500 ml.
- 6.2.4.1.3 Each model of receptacles (aerosol dispensers or cartridges) shall, before being put into service, satisfy a hydraulic pressure test carried out in conformity with 6.2.4.2.
- 6.2.4.1.4 The release valves and dispersal devices of aerosol dispensers (UN No.1950 aerosols) and the valves of UN No. 2037 small receptacles containing gas (gas cartridges) shall ensure that the receptacles are so closed as to be leakproof and shall be protected against accidental opening. Valves and dispersal devices which close only by the action of the internal pressure are not to be accepted.

6.2.4.2 Initial testing

- 6.2.4.2.1 The internal pressure to be applied (test pressure) shall be 1.5 times the internal pressure at 50 °C, with a minimum pressure of 1 MPa (10 bar).
- 6.2.4.2.2 The hydraulic pressure tests shall be carried out on at least five empty receptacles of each model:
- (a) until the prescribed test pressure is reached, by which time no leakage or visible permanent deformation shall have occurred; and
 - (b) until leakage or bursting occurs; the dished end, if any, shall yield first and the receptacle shall not leak or burst until a pressure 1.2 times the test pressure has been reached or passed.

6.2.4.3 Reference to standards

The requirements of this section are deemed to be met if the following standards are complied with:

- for aerosol dispensers (UN No. 1950 aerosols): Annex to Council Directive 75/324/EEC³ as amended by Commission Directive 94/1/EC⁴;
- for UN No. 2037, small recipients containing gas (gas cartridges) containing UN No. 1965, hydrocarbon gas mixture n.o.s, liquefied: EN 417:1992 Non-refillable metallic gas cartridges for liquefied petroleum gases, with or without a valve, for use with portable appliances - Construction, inspection, testing and marking.

6.2.5 Requirements for UN certified pressure receptacles

In addition to the general requirements of 6.2.1.1, 6.2.1.2, 6.2.1.3, 6.2.1.5 and 6.2.1.6, UN certified pressure receptacles shall comply with the requirements of this section, including the standards, as applicable.

NOTE: *With the agreement of the competent authority, more recently published versions of the standards, if available, may be used.*

³ Council Directive 75/324/EEC of 20 May 1975 on the approximation of the laws of the Member States relating to aerosol dispensers, published in the Official Journal of the European Communities No. L 147 of 9.06.1975.

⁴ Commission Directive 94/1/EC of January 1994, adapting some technicalities of Council Directive 75/324/EEC on the approximation of the laws of the relating Member States to aerosol dispensers published in the Official Journal of the European Communities No. L 23 of 28.01.1994.

6.2.5.1 *General requirements*

6.2.5.1.1 *Service equipment*

Except for pressure relief devices, valves, piping, fittings and other equipment subjected to pressure, shall be designed and constructed to withstand at least 1.5 times the test pressure of the pressure receptacles.

Service equipment shall be configured or designed to prevent damage that could result in the release of the pressure receptacle contents during normal conditions of handling and carriage. Manifold piping leading to shut-off valves shall be sufficiently flexible to protect the valves and the piping from shearing or releasing the pressure receptacle contents. The filling and discharge valves and any protective caps shall be capable of being secured against unintended opening. Valves shall be protected as specified in 4.1.6.4 (a) to (e) or pressure receptacles are carried in an outer packaging, which as prepared for carriage shall be capable of meeting the drop test specified in 6.1.5.3 for the packing group I performance level.

6.2.5.1.2 *Pressure relief devices*

Each pressure receptacle used for the carriage of UN No. 1013 carbon dioxide and UN No. 1070 nitrous oxide shall be equipped with approved pressure relief devices or, for other gases, as specified by the competent authority of the country of use, except when forbidden by packing instruction P200 in 4.1.4.1. The type of pressure relief device, the set-to-discharge pressure and relief capacity of pressure relief devices, if required, shall be specified by the competent authority of the country of use.

When fitted, pressure relief devices on manifolded horizontal pressure receptacles filled with flammable gas shall be arranged to discharge freely to the open air in such a manner as to prevent any impingement of escaping gas upon the pressure receptacles under normal conditions of carriage.

6.2.5.2 *Design, construction and initial inspection and test*

6.2.5.2.1 The following standards apply for the design, construction, and initial inspection and test of UN certified cylinders:

ISO 9809-1:1999	Gas cylinders - Refillable seamless steel gas cylinders - Design, construction and testing - Part 1: Quenched and tempered steel cylinders with tensile strength less than 1100 MPa. <i>NOTE: The note concerning the F factor in section 7.3 of this standard shall not be applied for UN certified cylinders.</i>
ISO 9809-2:2000	Gas cylinders - Refillable seamless steel gas cylinders - Design, construction and testing - Part 2: Quenched and tempered steel cylinders with tensile strength greater than or equal to 1100 MPa.
ISO 9809-3:2000	Gas cylinders - Refillable seamless steel gas cylinders - Design, construction and testing - Part 3: Normalized steel cylinders.
ISO 7866:1999	Gas cylinders - Refillable seamless aluminium alloy gas cylinders - Design, construction and testing <i>NOTE: The note concerning the F factor in section 7.2 of this standard shall not be applied for UN certified cylinders. Aluminium alloy 6351A - T6 or equivalent shall not be authorized.</i>
ISO 11118:1999	Gas cylinders - Non-refillable metallic gas cylinders - Specification and test methods.

6.2.5.2.2 The following standards apply for the design, construction, and initial inspection and test of UN certified tubes:

ISO 11120:1999	Gas cylinders - Refillable seamless steel tubes for compressed gas transport, of water capacity between 150 l and 3000 l - Design, construction and testing. <i>NOTE: The note concerning the F factor in section 7.1 of this standard shall not be applied for UN certified tubes.</i>
----------------	--

6.2.5.2.3 The following standards apply for the design, construction and initial inspection and test of UN certified acetylene cylinders:

For the cylinder shell:

ISO 9809-1:1999	Gas cylinders - Refillable seamless steel gas cylinders - Design, construction and testing - Part 1: Quenched and tempered steel cylinders with tensile strength less than 1100 MPa. <i>NOTE: The note concerning the F factor in section 7.3 of this standard shall not be applied for UN certified cylinders.</i>
ISO 9809-3:2000	Gas cylinders - Refillable seamless steel gas cylinders - Design, construction and testing - Part 3: Normalized steel cylinders.
ISO 7866:1999	Gas cylinders - Refillable seamless aluminium alloy gas cylinders - Design, construction and testing. <i>NOTE: The note concerning the F factor in section 7.2 of this standard shall not be applied for UN certified cylinders. Aluminium alloy 6351A - T6 or equivalent shall not be authorized.</i>
ISO 11118:1999	Gas cylinders - Non-refillable metallic gas cylinders - Specification and test methods.

For the porous mass in the cylinder:

ISO 3807-1:2000	Cylinders for acetylene - Basic requirements - Part 1: Cylinders without fusible plugs.
ISO 3807-2:2000	Cylinders for acetylene - Basic requirements - Part 2: Cylinders with fusible plugs.

6.2.5.3 **Materials**

In addition to the material requirements specified in the pressure receptacle design and construction standards, and any restrictions specified in the applicable packing instruction for the gas(es) to be carried (e.g. packing instruction P200), the following standards apply to material compatibility:

ISO 11114-1:1997	Transportable gas cylinders - Compatibility of cylinder and valve materials with gas contents - Part 1: Metallic materials.
ISO 11114-2:2000	Transportable gas cylinders - Compatibility of cylinder and valve materials with gas contents - Part 2: Non-metallic materials.

6.2.5.4 *Service equipment*

The following standards apply to closures and their protection:

ISO 11117:1998	Gas cylinders - Valve protection caps and valve guards for industrial and medical gas cylinders - Design, construction and tests.
ISO 10297:1999	Gas cylinders - Refillable gas cylinder valves - Specification and type testing.

6.2.5.5 *Periodic inspection and test*

The following standards apply to the periodic inspection and testing of UN certified cylinders:

ISO 6406:1992	Periodic inspection and testing of seamless steel gas cylinders
ISO 10461:1993	Seamless aluminium - alloy gas cylinders - Periodic inspection and testing.
ISO 10462:1994	Cylinders for dissolved acetylene - Periodic inspection and maintenance.

6.2.5.6 *Conformity assessment system and approval of pressure receptacles*

6.2.5.6.1 *Definitions*

For the purposes of this sub-section:

Conformity assessment system means a system for competent authority approval of a manufacturer, by pressure receptacle design type approval, approval of manufacturer's quality system and approval of inspection bodies;

Design type means a pressure receptacle design as specified by a particular pressure receptacle standard;

Verify means confirm by examination or provision of objective evidence that specified requirements have been fulfilled.

6.2.5.6.2 *General requirements*

Competent Authority

6.2.5.6.2.1 The competent authority that approves the pressure receptacle shall approve the conformity assessment system for the purpose of ensuring that pressure receptacles conform to the requirements of ADR. In instances where the competent authority that approves a pressure receptacle is not the competent authority in the country of manufacture, the marks of the approval country and the country of manufacture shall be indicated in the pressure receptacle marking (see 6.2.5.7 and 6.2.5.8).

The competent authority of the country of approval shall supply, upon request, evidence demonstrating compliance to this conformity assessment system to its counterpart in a country of use.

6.2.5.6.2.2 The competent authority may delegate its functions in this conformity assessment system in whole or in part.

6.2.5.6.2.3 The competent authority shall ensure that a current list of approved inspection bodies and their identity marks and approved manufacturers and their identity marks is available.

Inspection body

6.2.5.6.2.4 The inspection body shall be approved by the competent authority for the inspection of pressure receptacles and shall:

- (a) have a staff with an organisational structure, capable, trained, competent, and skilled, to satisfactorily perform its technical functions;
- (b) have access to suitable and adequate facilities and equipment;
- (c) operate in an impartial manner and be free from any influence which could prevent it from doing so;
- (d) ensure confidentiality of the commercial and proprietary activities of the manufacturer and other bodies;
- (e) maintain clear demarcation between actual inspection body functions and unrelated functions;
- (f) operate a documented quality system;
- (g) ensure that the tests and inspections specified in the relevant pressure receptacle standard and in the ADR are performed; and
- (h) maintain an effective and appropriate report and record system in accordance with 6.2.5.6.6.

6.2.5.6.2.5 The inspection body shall perform design type approval, pressure receptacle production testing and inspection and certification to verify conformity with the relevant pressure receptacle standard (see 6.2.5.6.4 and 6.2.5.6.5).

Manufacturer

6.2.5.6.2.6 The manufacturer shall

- (a) operate a documented quality system in accordance with 6.2.5.6.3;
- (b) apply for design type approvals in accordance with 6.2.5.6.4;
- (c) select an inspection body from the list of approved inspection bodies maintained by the competent authority in the country of approval; and
- (d) maintain records in accordance with 6.2.5.6.6.

Testing laboratory

6.2.5.6.2.7 The testing laboratory shall have:

- (a) staff with an organisational structure, sufficient in number, competence, and skill; and
- (b) suitable and adequate facilities and equipment to perform the tests required by the manufacturing standard to the satisfaction of the inspection body.

6.2.5.6.3 *Manufacturer's quality system*

6.2.5.6.3.1 The quality system shall contain all the elements, requirements, and provisions adopted by the manufacturer. It shall be documented in a systematic and orderly manner in the form of written policies, procedures and instructions.

The contents shall in particular include adequate descriptions of:

- (a) the organisational structure, responsibilities, and power of the management with regard to design and product quality;
- (b) the design control and design verification techniques, processes, and systematic actions that will be used when designing the pressure receptacles;
- (c) the relevant pressure receptacle manufacturing, quality control, quality assurance, and process operation instructions that will be used;
- (d) quality records, such as inspection reports, test data, and calibration data;
- (e) management reviews to ensure the effective operation of the quality system arising from the audits in accordance with 6.2.5.6.3.2 ;
- (f) the process describing how customer requirements are met;
- (g) the process for control of documents and their revision;
- (h) the means for control of non-conforming pressure receptacles, purchased components, in-process and final materials; and
- (i) training programmes for relevant personnel.

6.2.5.6.3.2 Audit of the quality system

The quality system shall be initially assessed to determine whether it meets the requirements in 6.2.5.6.3.1 to the satisfaction of the competent authority.

The manufacturer shall be notified of the results of the audit. The notification shall contain the conclusions of the audit and any corrective actions required.

Periodic audits shall be carried out, to the satisfaction of the competent authority, to ensure that the manufacturer maintains and applies the quality system. Reports of the periodic audits shall be provided to the manufacturer.

6.2.5.6.3.3 Maintenance of the quality system

The manufacturer shall maintain the quality system as approved in order that it remains adequate and efficient.

The manufacturer shall notify the competent authority that approved the quality system, of any intended changes. The proposed changes shall be evaluated in order to determine whether the amended quality system will still satisfy the requirements in 6.2.5.6.3.1.

6.2.5.6.4 *Approval process*

Initial design type approval

- 6.2.5.6.4.1 The initial design type approval shall consist of approval of the manufacturer's quality system and approval of the pressure receptacle design to be produced. An application for an initial design type approval shall meet the requirements of 6.2.5.6.3, 6.2.5.6.4.2 to 6.2.5.6.4.6 and 6.2.5.6.4.9.
- 6.2.5.6.4.2 A manufacturer desiring to produce pressure receptacles in accordance with a pressure receptacle standard and with the ADR shall apply for, obtain, and retain a Design Type Approval Certificate issued by the competent authority in the country of approval for at least one pressure receptacle design type in accordance with the procedure given in 6.2.5.6.4.9. This certificate shall, on request, be submitted to the competent authority of the country of use.
- 6.2.5.6.4.3 An application shall be made for each manufacturing facility and shall include:
- (a) the name and registered address of the manufacturer and in addition, if the application is submitted by an authorised representative, its name and address;
 - (b) the address of the manufacturing facility (if different from the above);
 - (c) the name and title of the person(s) responsible for the quality system;
 - (d) the designation of the pressure receptacle and the relevant pressure receptacle standard;
 - (e) details of any refusal of approval of a similar application by any other competent authority;
 - (f) the identity of the inspection body for design type approval;
 - (g) documentation on the manufacturing facility as specified under 6.2.5.6.3.1 and
 - (h) the technical documentation required for design type approval, which shall enable verification of the conformity of the pressure receptacles with the requirements of the relevant pressure receptacle design standard. The technical documentation shall cover the design and method of manufacture and shall contain, as far as is relevant for assessment, at least the following:
 - (i) pressure receptacle design standard, design and manufacturing drawings, showing components and subassemblies, if any;
 - (ii) descriptions and explanations necessary for the understanding of the drawings and intended use of the pressure receptacles;
 - (iii) a list of the standards necessary to fully define the manufacturing process;
 - (iv) design calculations and material specifications; and
 - (v) design type approval test reports, describing the results of examinations and tests carried out in accordance with 6.2.5.6.4.9.
- 6.2.5.6.4.4 An initial audit in accordance with 6.2.5.6.3.2 shall be performed to the satisfaction of the competent authority.

- 6.2.5.6.4.5 If the manufacturer is denied approval, the competent authority shall provide written detailed reasons for such denial.
- 6.2.5.6.4.6 Following approval, changes to the information submitted under 6.2.5.6.4.3 relating to the initial approval shall be provided to the competent authority.

Subsequent design type approvals

- 6.2.5.6.4.7 An application for a subsequent design type approval shall meet the requirements of 6.2.5.6.4.8 and 6.2.5.6.4.9, provided a manufacturer is in the possession of an initial design type approval. In such a case, the manufacturer's quality system according to 6.2.5.6.3 shall have been approved during the initial design type approval and shall be applicable for the new design.
- 6.2.5.6.4.8 The application shall include:
- (a) the name and address of the manufacturer and in addition, if the application is submitted by an authorised representative, its name and address;
 - (b) details of any refusal of approval of a similar application by any other competent authority;
 - (c) evidence that initial design type approval has been granted; and
 - (d) the technical documentation, as described in 6.2.5.6.4.3 (h).

Procedure for design type approval

- 6.2.5.6.4.9 The inspection body shall:
- (a) examine the technical documentation to verify that:
 - (i) the design is in accordance with the relevant provisions of the standard, and
 - (ii) the prototype lot has been manufactured in conformity with the technical documentation and is representative of the design;
 - (b) verify that the production inspections have been carried out as required in accordance with 6.2.5.6.5;
 - (c) select pressure receptacles from a prototype production lot and supervise the tests of these pressure receptacles as required for design type approval;
 - (d) perform or have performed the examinations and tests specified in the pressure receptacle standard to determine that:
 - (i) the standard has been applied and fulfilled, and
 - (ii) the procedures adopted by the manufacturer meet the requirements of the standard; and
 - (e) ensure that the various type approval examinations and tests are correctly and competently carried out.

After prototype testing has been carried out with satisfactory results and all applicable requirements of 6.2.5.6.4 have been satisfied, a design type approval certificate shall be

issued which shall include the name and address of the manufacturer, results and conclusions of the examination, and the necessary data for identification of the design type.

If the manufacturer is denied a design type approval, the competent authority shall provide written detailed reasons for such denial.

6.2.5.6.4.10 Modifications to approved design types

The manufacturer shall inform the issuing competent authority of modifications to the approved design type as specified in the pressure receptacle standard. A subsequent design type approval shall be requested where such modifications constitute a new design according to the relevant pressure receptacle standard. This additional approval shall be given in the form of an amendment to the original Design Type Approval Certificate.

6.2.5.6.4.11 Upon request, the competent authority shall communicate to any other competent authority, information concerning design type approval, modifications of approvals, and withdrawn approvals.

6.2.5.6.5 *Production inspection and certification*

An inspection body, or its delegate, shall carry out the inspection and certification of each pressure receptacle. The inspection body selected by the manufacturer for inspection and testing during production may be different from the inspection body used for the design type approval testing.

Where it can be demonstrated to the satisfaction of the inspection body that the manufacturer has trained and competent inspectors, independent of the manufacturing operations, inspection may be performed by those inspectors. In such a case, the manufacturer shall maintain training records of the inspectors.

The inspection body shall verify that the inspections by the manufacturer and tests performed on those pressure receptacles, fully conform to the standard and the requirements of ADR. Should non-conformance in conjunction with this inspection and testing be determined, the permission to have inspection performed by the manufacturer's inspectors may be withdrawn.

The manufacturer shall, after approval by the inspection body, make a declaration of conformity with the certified design type. The application of the pressure receptacle certification marking shall be considered a declaration that the pressure receptacle complies with the applicable pressure receptacle standards and the requirements of this conformity assessment system and ADR. The inspection body shall affix or delegate the manufacturer to affix the pressure receptacle certification marking and the registered mark of the inspection body to each approved pressure receptacle.

A certificate of compliance, signed by the inspection body and the manufacturer, shall be issued before the pressure receptacles are filled.

6.2.5.6.6 *Records*

Design type approval and certificate of compliance records shall be retained by the manufacturer and the inspection body for not less than 20 years.

6.2.5.7 *Marking of UN certified refillable pressure receptacles*

UN certified refillable pressure receptacles shall be marked clearly and legibly with certification and gas and pressure receptacle specific marks. These marks shall be permanently affixed (e.g. stamped, engraved, or etched) on the pressure receptacle. The marks shall be on the shoulder, top end or neck of the pressure receptacle or on a permanently affixed component of the pressure receptacle (e.g. welded collar). Except for the "UN" mark, the minimum size of the marks shall be 5 mm for pressure receptacles with a diameter greater than or equal to 140 mm and 2.5 mm for pressure receptacles with a diameter less than 140 mm. The minimum size of the "UN" mark shall be 10 mm for pressure receptacles with a diameter greater than or equal to 140 mm and 5 mm for pressure receptacles with a diameter less than 140 mm.

6.2.5.7.1 The following certification marks shall be applied:

- (a) The UN packaging symbol



This symbol shall only be marked on pressure receptacles which conform to the requirements of ADR for UN certified pressure receptacles.

- (b) The technical standard (e.g. ISO 9809-1) used for design, construction and testing;
- (c) The character(s) identifying the country of approval as indicated by the distinguishing signs of motor vehicles in international traffic;
- (d) The identity mark or stamp of the inspection body that is registered with the competent authority of the country authorizing the marking;
- (e) The date of the initial inspection, the year (four digits) followed by the month (two digits) separated by a slash (i.e. "/").

6.2.5.7.2 The following operational marks shall be applied:

- (f) The test pressure in bar, preceded by the letters "PH" and followed by the letters "BAR";
- (g) The empty mass of the pressure receptacle including all permanently attached integral parts (e.g. neck ring, foot ring, etc.) in kilograms, followed by the letters "KG". This mass shall not include the mass of valve, valve cap or valve guard, any coating, or porous mass for acetylene. The empty mass shall be expressed to three significant figures rounded up to the last digit. For cylinders of less than 1 kg, the mass shall be expressed to two significant figures rounded up to the last digit;
- (h) The minimum guaranteed wall thickness of the pressure receptacle in millimetres followed by the letters "MM". This mark is not required for pressure receptacles with a water capacity less than or equal to 1 l or for composite cylinders;
- (i) In the case of pressure receptacles intended for the carriage of compressed gases, UN No. 1001 acetylene, dissolved, and UN No. 3374 acetylene, solvent free, the working pressure in bar, preceded by the letters "PW";
- (j) In the case of liquefied gases, the water capacity in litres expressed to three significant digits rounded down to the last digit, followed by the letter "L". If the value of the

minimum or nominal water capacity is an integer, the digits after the decimal point may be neglected;

- (k) In the case of UN No. 1001 acetylene, dissolved, the total of the mass of the empty pressure receptacle, the fittings and accessories not removed during filling, the porous material, the solvent and the saturation gas expressed to two significant figures rounded down to the last digit followed by the letters "KG";
- (l) In the case of UN No. 3374 acetylene, solvent free, the total of the mass of the empty pressure receptacle, the fittings and accessories not removed during filling and the porous material expressed to two significant figures rounded down to the last digit followed by the letters "KG".

6.2.5.7.3 The following manufacturing marks shall be applied

- (m) Identification of the cylinder thread (e.g. 25E);
- (n) The manufacturer's mark registered by the competent authority. When the country of manufacture is not the same as the country of approval, then the manufacturer's mark shall be preceded by the character(s) identifying the country of manufacture as indicated by the distinguishing signs of motor vehicles in international traffic. The country mark and the manufacturer's mark shall be separated by a space or slash;
- (o) The serial number assigned by the manufacturer;
- (p) In the case of steel pressure receptacles and composite pressure receptacles with steel liner intended for the carriage of gases with a risk of hydrogen embrittlement, the letter "H" showing compatibility of the steel (see ISO 11114-1:1997).

6.2.5.7.4 The above marks shall be placed in three groups as shown in the example below.

- Manufacturing marks shall be the top grouping and shall appear consecutively in the sequence given in 6.2.5.7.3.
- The middle grouping shall include the test pressure (f) which shall be immediately preceded by the working pressure (i) when the latter is required.
- Certification marks shall be the bottom grouping and shall appear in the sequence given in 6.2.5.7.1.

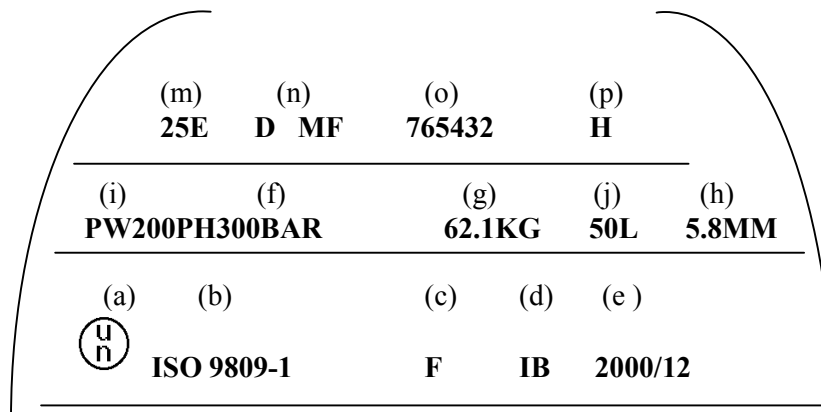

6.2.5.7.5 Other marks are allowed in areas other than the side wall, provided they are made in low stress areas and are not of a size and depth that will create harmful stress concentrations. Such marks shall not conflict with required marks.

6.2.5.7.6 In addition to the preceding marks, each refillable pressure receptacle shall be marked indicating the date (year and month) of the last periodic inspection and the registered mark of the inspection body authorized by the competent authority of the country of use.

6.2.5.8 *Marking of UN certified non-refillable pressure receptacles*

UN certified non-refillable pressure receptacles shall be marked clearly and legibly with certification and gas or pressure receptacle specific marks. These marks shall be permanently affixed (e.g. stencilled, stamped, engraved, or etched) on the pressure receptacle. Except when stencilled, the marks shall be on the shoulder, top end or neck of the pressure receptacle or on a permanently affixed component of the pressure receptacle (e.g. welded collar). Except for the "UN" mark and the "DO NOT REFILL" mark, the minimum size of the marks shall be 5 mm for pressure receptacles with a diameter greater than or equal to 140 mm and 2.5 mm for pressure receptacles with a diameter less than 140 mm.

The minimum size of the "UN" mark shall be 10 mm for pressure receptacles with a diameter greater than or equal to 140 mm and 5 mm for pressure receptacles with a diameter less than 140 mm.

The minimum size of the "DO NOT REFILL" mark shall be 5 mm.

6.2.5.8.1 The marks listed in 6.2.5.7.1 to 6.2.5.7.3 shall be applied with the exception of (g), (h), and (m). The serial number (o) may be replaced by the batch number. In addition, the words "DO NOT REFILL" in letters of at least 5 mm in height are required.

6.2.5.8.2 The requirements of 6.2.5.7.4 shall apply.

***NOTE:** Non-refillable pressure receptacles may, on account of their size, substitute this marking by a label (see 5.2.2.2.1.2).*

6.2.5.8.3 Other marks are allowed provided they are made in low stress areas other than the side wall and are not of a size and depth that will create harmful stress concentrations. Such marks shall not conflict with required marks.

CHAPTER 6.3

REQUIREMENTS FOR THE CONSTRUCTION AND TESTING OF PACKAGINGS FOR CLASS 6.2 SUBSTANCES

NOTE: *The requirements of this Chapter don't apply to packagings used for the carriage of Class 6.2 substances according to packing instruction P621 of 4.1.4.1.*

6.3.1 General

6.3.1.1 A packaging that meets the requirements of this section and of 6.3.2 shall be marked with:

- (a) the United Nations packaging symbol;



- (b) the code designating the type of packaging according to the requirements of 6.1.2;
- (c) the text "CLASS 6.2";
- (d) the last two digits of the year of manufacture of the packaging;
- (e) the state authorizing the allocation of the mark, indicated by the distinguishing sign for motor vehicles in international traffic ¹;
- (f) the name of the manufacturer or other identification of the packaging specified by the competent authority;
- (g) for packagings meeting the requirements of 6.3.2.9, the letter "U", inserted immediately following the marking required in (b) above.

Each element of the marking applied in accordance with (a) to (g) shall be clearly separated, e.g. by a slash or space, so as to be easily identifiable.

6.3.1.2 Example of marking



4G/CLASS 6.2/92
S/SP-9989-ERIKSSON

as in 6.3.1.1 (a), (b), (c) and (d)
as in 6.3.1.1 (e), (f)

6.3.1.3 Manufacturers and subsequent distributors of packagings shall provide information regarding procedures to be followed and a description of the types and dimensions of closures (including required gaskets) and any other components needed to ensure that packages as presented for carriage are capable of passing the applicable performance tests of this Chapter.

6.3.2 Test requirements for packagings

6.3.2.1 Other than for packagings for live animals and organisms, samples of each packaging shall be prepared for testing as described in 6.3.2.2 and then subjected to the tests in 6.3.2.4 to 6.3.2.6. If the nature of the packaging makes it necessary, equivalent preparation and tests are permitted, provided that these may be demonstrated to be at least as effective.

¹ *Distinguishing sign for motor vehicles in international traffic prescribed in Vienna Convention on Road Traffic (1968).*

6.3.2.2 Samples of each packaging shall be prepared as for carriage, except that a liquid or solid infectious substance shall be replaced by water or, where conditioning at –18 °C is specified, by water/antifreeze. Each primary receptacle shall be filled to 98% capacity.

6.3.2.3 Tests required

Material of					Tests required				
outer packaging			inner packaging		Refer to 6.3.2.5				Refer to 6.3.2.6
Fibre-board	Plastics	Other	Plastics	Other	(a)	(b)	(c)	(d)	
x			x			x	x	when dry ice is used	x
x				x		x			x
	x		x				x		x
	x			x			x		x
		x	x				x		x
		x		x	x				x

6.3.2.4 Packagings prepared as for carriage shall be subjected to the tests in 6.3.2.3, which - for test purposes - categorizes packagings according to their material characteristics. For outer packagings, the headings in the table relate to fibreboard or similar materials whose performance may be rapidly affected by moisture; plastics which may embrittle at low temperature; and other materials such as metal whose performance is not affected by moisture or temperature. If a primary receptacle and a secondary packaging are made of different materials, the material of the primary receptacle determines the appropriate test. In instances where a primary receptacle is made of two materials, the material most liable to damage shall determine the appropriate tests.

6.3.2.5 (a) Samples shall be subjected to free-fall drops on to a rigid, non-resilient, flat, horizontal surface from a height of 9 m. Where the samples are in the shape of a box, five shall be dropped in sequence:

- (i) one flat on to the base,
- (ii) one flat on to the top,
- (iii) one flat on to the long side,
- (iv) one flat on to the short side,
- (v) one on to a corner.

Where the samples are in the shape of a drum, three shall be dropped in sequence:

- (vi) one diagonally on to the top chime, with the centre of gravity directly above the point of impact,
- (vii) one diagonally on to the base chime,
- (viii) one flat on to the side.

Following the appropriate drop sequence, there shall be no leakage from the primary receptacle(s) which shall remain protected by absorbent material in the secondary packaging.

NOTE: While the sample shall be released in the required orientation, it is accepted that for aerodynamic reasons the impact may not take place in that orientation.

- (b) The samples shall be subjected to a water spray that simulates exposure to rainfall of approximately 5 cm per hour for at least one hour. It shall then be subjected to the test described in (a).
- (c) The samples shall be conditioned in an atmosphere of -18 °C or less for a period of at least 24 hours and within 15 minutes of removal from that atmosphere be subjected to the test described in (a). Where the samples contain dry ice, the conditioning period may be reduced to 4 hours.
- (d) Where the packaging is intended to contain dry ice, a test additional to that specified in (a) or (b) or (c) shall be carried out. One sample shall be stored so that all the dry ice dissipates and then be subjected to the test described in (a).

6.3.2.6 Packagings with a gross mass of 7 kg or less shall be subjected to the tests described in (a) below and packagings with a gross mass exceeding 7 kg to the tests in (b) below.

- (a) Samples shall be placed on a level hard surface. A cylindrical steel rod with a mass of at least 7 kg, a diameter not exceeding 38 mm and whose impact end edges have a radius not exceeding 6 mm, shall be dropped in a vertical free fall from a height of 1 m, measured from the impact end to the impact surface of the sample. One sample shall be placed on its base. A second sample shall be placed in an orientation perpendicular to that used for the first. In each instance the steel rod shall be aimed to impact the primary receptacle. Following each impact, penetration of the secondary packaging is acceptable, provided that there is no leakage from the primary receptacle(s).
- (b) Samples shall be dropped on to the end of a cylindrical steel rod. The rod shall be set vertically in a level hard surface. It shall have a diameter of 38 mm and the edges of the upper end a radius not exceeding 6 mm. The rod shall protrude from the surface a distance at least equal to that between the primary receptacle(s) and the outer surface of the outer packaging with a minimum of 200 mm. One sample shall be dropped in a vertical free fall from a height of 1 m, measured from the top of the steel rod. A second sample shall be dropped from the same height in an orientation perpendicular to that used for the first. In each instance, the packaging shall be so orientated that the steel rod could penetrate the primary receptacle(s). Following each impact, there shall be no leakage from the primary receptacle(s).

6.3.2.7 The competent authority may permit the selective testing of packagings that differ only in minor respects from a tested type, e.g. smaller sizes of inner packagings or inner packagings of lower net mass; and packagings such as drums, bags and boxes which are produced with small reductions in external dimension(s).

6.3.2.8 Provided an equivalent level of performance is maintained, the following variations in the primary receptacles placed within a secondary packaging are allowed without the need for further testing of the completed packaging:

- (a) Primary receptacles of equivalent or smaller size as compared to the tested primary receptacles may be used provided:
 - (i) the primary receptacles are of similar design to the primary receptacle tested (e.g. shape: round, rectangular, etc.);

- (ii) the material of construction of the primary receptacles (e.g. glass, plastics, metal) offers resistance to impact and stacking forces equivalent to or better than that of the primary receptacles originally tested;
 - (iii) the primary receptacles have the same or smaller openings and the closure is of equivalent design (e.g. screw cap, friction lid, etc.);
 - (iv) sufficient additional cushioning material is used to take up empty spaces and to prevent significant movement of the primary receptacles; and
 - (v) primary receptacles are oriented within the secondary packagings in the same manner as in the tested package.
- (b) A lesser number of the tested primary receptacles, or of the alternative types of primary receptacles identified in (a) above, may be used provided sufficient cushioning is added to fill the void space(s) and to prevent significant movement of the primary receptacles.

6.3.2.9

Inner receptacles of any type may be assembled within an intermediate (secondary) packaging and carried without testing in the outer packaging under the following conditions:

- (a) The intermediate/outer packaging combination shall have been successfully tested in accordance with 6.3.2.3 with fragile (e.g. glass) inner receptacles;
- (b) The total combined gross mass of inner receptacles shall not exceed one half the gross mass of inner receptacles used for the drop test in (a) above;
- (c) The thickness of cushioning between inner receptacles and between inner receptacles and the outside of the intermediate packaging shall not be reduced below the corresponding thicknesses in the originally tested packaging; and if a single inner receptacle was used in the original test, the thickness of cushioning between inner receptacles shall not be less than the thickness of cushioning between the outside of the intermediate packaging and the inner receptacle in the original test. When either fewer or smaller inner receptacles are used (as compared to the inner receptacles used in the drop test), sufficient additional cushioning material shall be used to take up the void;
- (d) The outer packaging shall have successfully passed the stacking test in 6.1.5.6 while empty. The total mass of identical packages shall be based on the combined mass of inner receptacles used in the drop test in (a) above;
- (e) For inner receptacles containing liquids, an adequate quantity of absorbent material to absorb the entire liquid content of the inner receptacles shall be present;
- (f) If the outer packaging is intended to contain inner receptacles for liquids and is not leakproof, or is intended to contain inner receptacles for solids and is not siftproof, a means of containing any liquid or solid contents in the event of leakage shall be provided in the form of a leakproof liner, plastics bag or other equally effective means of containment;
- (g) In addition to the markings prescribed in 6.3.1.1(a) to (f), packagings shall be marked in accordance with 6.3.1.1 (g).

6.3.3 Test report

6.3.3.1 A test report containing at least the following particulars shall be drawn up and shall be available to the users of the packaging:

1. Name and address of the test facility;
2. Name and address of applicant (where appropriate);
3. A unique test report identification;
4. Date of the test report;
5. Manufacturer of the packaging;
6. Description of the packaging design type (e.g. dimensions, materials, closures, thickness, etc.), including method of manufacture (e.g. blow moulding) and which may include drawing(s) and/or photograph(s);
7. Maximum capacity;
8. Characteristics of test contents, e.g. viscosity and relative density for liquids and particle size for solids;
9. Test descriptions and results;
10. The test report shall be signed with the name and status of the signatory.

6.3.3.2 The test report shall contain statements that the packaging prepared as for carriage was tested in accordance with the appropriate requirements of this Chapter and that the use of other packaging methods or components may render it invalid. A copy of the test report shall be available to the competent authority.

CHAPTER 6.4

REQUIREMENTS FOR THE CONSTRUCTION, TESTING AND APPROVAL OF PACKAGES AND MATERIAL OF CLASS 7

6.4.1 *(Reserved)*

6.4.2 **General requirements**

6.4.2.1 The package shall be so designed in relation to its mass, volume and shape that it can be easily and safely carried. In addition, the package shall be so designed that it can be properly secured in or on the vehicle during carriage.

6.4.2.2 The design shall be such that any lifting attachments on the package will not fail when used in the intended manner and that, if failure of the attachments should occur, the ability of the package to meet other requirements of this Annex would not be impaired. The design shall take account of appropriate safety factors to cover snatch lifting.

6.4.2.3 Attachments and any other features on the outer surface of the package which could be used to lift it shall be designed either to support its mass in accordance with the requirements of 6.4.2.2 or shall be removable or otherwise rendered incapable of being used during carriage.

6.4.2.4 As far as practicable, the packaging shall be so designed and finished that the external surfaces are free from protruding features and can be easily decontaminated.

6.4.2.5 As far as practicable, the outer layer of the package shall be so designed as to prevent the collection and the retention of water.

6.4.2.6 Any features added to the package at the time of carriage which are not part of the package shall not reduce its safety.

6.4.2.7 The package shall be capable of withstanding the effects of any acceleration, vibration or vibration resonance which may arise under routine conditions of carriage without any deterioration in the effectiveness of the closing devices on the various receptacles or in the integrity of the package as a whole. In particular, nuts, bolts and other securing devices shall be so designed as to prevent them from becoming loose or being released unintentionally, even after repeated use.

6.4.2.8 The materials of the packaging and any components or structures shall be physically and chemically compatible with each other and with the radioactive contents. Account shall be taken of their behaviour under irradiation.

6.4.2.9 All valves through which the radioactive contents could otherwise escape shall be protected against unauthorized operation.

6.4.2.10 The design of the package shall take into account ambient temperatures and pressures that are likely to be encountered in routine conditions of carriage.

6.4.2.11 For radioactive material having other dangerous properties the package design shall take into account those properties; see 2.1.3.5.3 and 4.1.9.1.5.

6.4.2.12 Manufacturers and subsequent distributors of packagings shall provide information regarding procedures to be followed and a description of the types and dimensions of closures (including required gaskets) and any other components needed to ensure that packages as

presented for carriage are capable of passing the applicable performance tests of this Chapter.

6.4.3 *(Reserved)*

6.4.4 **Requirements for excepted packages**

An excepted package shall be designed to meet the requirements specified in 6.4.2.

6.4.5 **Requirements for Industrial packages**

6.4.5.1 Industrial packages Types 1, 2, and 3 (Types IP-1, IP-2, and IP-3) shall meet the requirements specified in 6.4.2 and 6.4.7.2.

6.4.5.2 An Industrial package Type 2 (Type IP-2) shall, if it were subjected to the tests specified in 6.4.15.4 and 6.4.15.5, prevent:

- (a) Loss or dispersal of the radioactive contents; and
- (b) Loss of shielding integrity which would result in more than a 20% increase in the radiation level at any external surface of the package.

6.4.5.3 An Industrial package Type 3 (Type IP-3) shall meet all the requirements specified in 6.4.7.2 to 6.4.7.15.

6.4.5.4 *Alternative requirements for Industrial packages Types 2 and 3 (Types IP-2 and IP-3)*

6.4.5.4.1 Packages may be used as Industrial package Type 2 (Type IP-2) provided that:

- (a) They satisfy the requirements of 6.4.5.1;
- (b) They are designed to conform to the standards prescribed in Chapter 6.1 or other requirements at least equivalent to those standards; and
- (c) When subjected to the tests required for packing groups I or II in Chapter 6.1, they would prevent:
 - (i) loss or dispersal of the radioactive contents; and
 - (ii) loss of shielding integrity which would result in more than a 20% increase in the radiation level at any external surface of the package.

6.4.5.4.2 Tank-containers and portable tanks may also be used as Industrial package Types 2 or 3 (Types IP-2 or IP-3), provided that:

- (a) They satisfy the requirements of 6.4.5.1;
- (b) They are designed to conform to the standards prescribed in Chapter 6.7 or Chapter 6.8, or other requirements at least equivalent to those standards, and are capable of withstanding a test pressure of 265 kPa; and
- (c) They are designed so that any additional shielding which is provided shall be capable of withstanding the static and dynamic stresses resulting from handling and routine conditions of carriage and of preventing a loss of shielding integrity which would result in more than a 20% increase in the radiation level at any external surface of the portable tanks or tank-containers.

- 6.4.5.4.3 Tanks, other than portable tanks and tank-containers, may also be used as Industrial package Types 2 or 3 (Types IP-2 or IP-3) for carrying LSA-I and LSA-II liquids and gases as prescribed in Table 4.1.9.2.4, provided that they conform to standards at least equivalent to those prescribed in 6.4.5.4.2.
- 6.4.5.4.4 Containers may also be used as Industrial package Types 2 or 3 (Types IP-2 or IP-3), provided that:
- (a) The radioactive contents are restricted to solid materials;
 - (b) They satisfy the requirements of 6.4.5.1; and
 - (c) They are designed to conform to ISO 1496-1:1990: "Series 1 Containers - Specifications and Testing - Part 1: General Cargo Containers" excluding dimensions and ratings. They shall be designed such that if subjected to the tests prescribed in that document and the accelerations occurring during routine conditions of carriage they would prevent:
 - (i) loss or dispersal of the radioactive contents; and
 - (ii) loss of shielding integrity which would result in more than a 20% increase in the radiation level at any external surface of the containers.
- 6.4.5.4.5 Metal intermediate bulk containers may also be used as Industrial package Type 2 or 3 (Type IP-2 or IP-3) provided that:
- (a) They satisfy the requirements of 6.4.5.1; and
 - (b) They are designed to conform to the standards and tests prescribed in Chapter 6.5 for packing groups I or II, but with the drop test conducted in the most damaging orientation, they would prevent:
 - (i) loss or dispersal of the radioactive contents; and
 - (ii) loss of shielding integrity which would result in more than a 20% increase in the radiation level at any external surface of the intermediate bulk container.

6.4.6 Requirements for packages containing uranium hexafluoride

- 6.4.6.1 Except as allowed in 6.4.6.4, uranium hexafluoride shall be packaged and carried in accordance with the provisions of ISO 7195:1993 "Packaging of uranium hexafluoride (UF₆) for transport", and the requirements of 6.4.6.2 and 6.4.6.3. The package shall also meet the requirements prescribed elsewhere in ADR which pertain to the radioactive and fissile properties of the material.
- 6.4.6.2 Each package designed to contain 0.1 kg or more of uranium hexafluoride shall be designed so that it would meet the following requirements:
- (a) Withstand without leakage and without unacceptable stress, as specified in ISO 7195:1993, the structural test as specified in 6.4.21.5;
 - (b) Withstand without loss or dispersal of the uranium hexafluoride the test specified in 6.4.15.4; and
 - (c) Withstand without rupture of the containment system the test specified in 6.4.17.3.

- 6.4.6.3 Packages designed to contain 0.1 kg or more of uranium hexafluoride shall not be provided with pressure relief devices.
- 6.4.6.4 Subject to the approval of the competent authority, packages designed to contain 0.1 kg or more of uranium hexafluoride may be carried if:
- (a) The packages are designed to requirements other than those given in ISO 7195:1993 and 6.4.6.2 and 6.4.6.3 but, notwithstanding, the requirements of 6.4.6.2 and 6.4.6.3 are met as far as practicable;
 - (b) The packages are designed to withstand without leakage and without unacceptable stress a test pressure less than 2.76 MPa as specified in 6.4.21.5; or
 - (c) For packages designed to contain 9 000 kg or more of uranium hexafluoride, the packages do not meet the requirement of 6.4.6.2 (c).

6.4.7 Requirements for Type A packages

- 6.4.7.1 Type A packages shall be designed to meet the general requirements of 6.4.2 and of 6.4.7.2 to 6.4.7.17.
- 6.4.7.2 The smallest overall external dimension of the package shall not be less than 10 cm.
- 6.4.7.3 The outside of the package shall incorporate a feature such as a seal, which is not readily breakable and which, while intact, will be evidence that it has not been opened.
- 6.4.7.4 Any tie-down attachments on the package shall be so designed that, under normal and accident conditions of carriage, the forces in those attachments shall not impair the ability of the package to meet the requirements of ADR.
- 6.4.7.5 The design of the package shall take into account temperatures ranging from -40°C to +70°C for the components of the packaging. Attention shall be given to freezing temperatures for liquids and to the potential degradation of packaging materials within the given temperature range.
- 6.4.7.6 The design and manufacturing techniques shall be in accordance with national or international standards, or other requirements, acceptable to the competent authority.
- 6.4.7.7 The design shall include a containment system securely closed by a positive fastening device which cannot be opened unintentionally or by a pressure which may arise within the package.
- 6.4.7.8 Special form radioactive material may be considered as a component of the containment system.
- 6.4.7.9 If the containment system forms a separate unit of the package, it shall be capable of being securely closed by a positive fastening device which is independent of any other part of the packaging.
- 6.4.7.10 The design of any component of the containment system shall take into account, where applicable, the radiolytic decomposition of liquids and other vulnerable materials and the generation of gas by chemical reaction and radiolysis.
- 6.4.7.11 The containment system shall retain its radioactive contents under a reduction of ambient pressure to 60 kPa.

- 6.4.7.12 All valves, other than pressure relief valves, shall be provided with an enclosure to retain any leakage from the valve.
- 6.4.7.13 A radiation shield which encloses a component of the package specified as a part of the containment system shall be so designed as to prevent the unintentional release of that component from the shield. Where the radiation shield and such component within it form a separate unit, the radiation shield shall be capable of being securely closed by a positive fastening device which is independent of any other packaging structure.
- 6.4.7.14 A package shall be so designed that if it were subjected to the tests specified in 6.4.15, it would prevent:
- (a) Loss or dispersal of the radioactive contents; and
 - (b) Loss of shielding integrity which would result in more than a 20% increase in the radiation level at any external surface of the package.
- 6.4.7.15 The design of a package intended for liquid radioactive material shall make provision for ullage to accommodate variations in the temperature of the contents, dynamic effects and filling dynamics.

Type A packages to contain liquids

- 6.4.7.16 A Type A package designed to contain liquids shall, in addition:
- (a) Be adequate to meet the conditions specified in 6.4.7.14 above if the package is subjected to the tests specified in 6.4.16; and
 - (b) Either
 - (i) be provided with sufficient absorbent material to absorb twice the volume of the liquid contents. Such absorbent material shall be suitably positioned so as to contact the liquid in the event of leakage; or
 - (ii) be provided with a containment system composed of primary inner and secondary outer containment components designed to ensure retention of the liquid contents, within the secondary outer containment components, even if the primary inner components leak.

Type A packages to contain gas

- 6.4.7.17 A package designed for gases shall prevent loss or dispersal of the radioactive contents if the package were subjected to the tests specified in 6.4.16. A Type A package designed for tritium gas or for noble gases shall be excepted from this requirement.

6.4.8 Requirements for Type B(U) packages

- 6.4.8.1 Type B(U) packages shall be designed to meet the requirements specified in 6.4.2, and of 6.4.7.2 to 6.4.7.15, except as specified in 6.4.7.14 (a), and, in addition, the requirements specified in 6.4.8.2 to 6.4.8.15.
- 6.4.8.2 A package shall be so designed that, under the ambient conditions specified in 6.4.8.4 and 6.4.8.5 heat generated within the package by the radioactive contents shall not, under normal conditions of carriage, as demonstrated by the tests in 6.4.15, adversely affect the package in such a way that it would fail to meet the applicable requirements for containment

and shielding if left unattended for a period of one week. Particular attention shall be paid to the effects of heat, which may:

- (a) Alter the arrangement, the geometrical form or the physical state of the radioactive contents or, if the radioactive material is enclosed in a can or receptacle (for example, clad fuel elements), cause the can, receptacle or radioactive material to deform or melt; or
- (b) Lessen the efficiency of the packaging through differential thermal expansion or cracking or melting of the radiation shielding material; or
- (c) In combination with moisture, accelerate corrosion.

6.4.8.3 A package shall be so designed that, under the ambient condition specified in 6.4.8.4, the temperature of the accessible surfaces of a package shall not exceed 50 °C, unless the package is carried under exclusive use.

6.4.8.4 The ambient temperature shall be assumed to be 38 °C.

6.4.8.5 The solar insolation conditions shall be assumed to be as specified in Table 6.4.8.5.

Table 6.4.8.5: Insolation data

Form and location of surface	Insolation for 12 hours per day (W/m ²)
Flat surfaces carried horizontally:	
- base	none
- other surfaces	800
Flat surfaces not carried horizontally:	
- each surface	200 ^a
Curved surfaces	400 ^a

^a *Alternatively, a sine function may be used, with an absorption coefficient adopted and the effects of possible reflection from neighbouring objects neglected.*

6.4.8.6 A package which includes thermal protection for the purpose of satisfying the requirements of the thermal test specified in 6.4.17.3 shall be so designed that such protection will remain effective if the package is subjected to the tests specified in 6.4.15 and 6.4.17.2 (a) and (b) or 6.4.17.2 (b) and (c), as appropriate. Any such protection on the exterior of the package shall not be rendered ineffective by ripping, cutting, skidding, abrasion or rough handling.

6.4.8.7 A package shall be so designed that, if it were subjected to:

- (a) The tests specified in 6.4.15, it would restrict the loss of radioactive contents to not more than 10⁻⁶ A₂ per hour; and
- (b) The tests specified in 6.4.17.1, 6.4.17.2 (b), 6.4.17.3, and 6.4.17.4 and the tests in
 - (i) 6.4.17.2 (c), when the package has a mass not greater than 500 kg, an overall density not greater than 1 000 kg/m³ based on the external dimensions, and radioactive contents greater than 1 000 A₂ not as special form radioactive material, or
 - (ii) 6.4.17.2 (a), for all other packages,

it would meet the following requirements:

- retain sufficient shielding to ensure that the radiation level at 1 m from the surface of the package would not exceed 10 mSv/h with the maximum radioactive contents which the package is designed to contain; and
- restrict the accumulated loss of radioactive contents in a period of one week to not more than 10 A₂ for krypton-85 and not more than A₂ for all other radionuclides.

Where mixtures of different radionuclides are present, the provisions of 2.2.7.7.2.4 to 2.2.7.7.2.6 shall apply except that for krypton-85 an effective A₂(i) value equal to 10 A₂ may be used. For case (a) above, the assessment shall take into account the external contamination limits of 4.1.9.1.2.

- 6.4.8.8 A package for radioactive contents with activity greater than 10⁵ A₂ shall be so designed that if it were subjected to the enhanced water immersion test specified in 6.4.18, there would be no rupture of the containment system.
- 6.4.8.9 Compliance with the permitted activity release limits shall depend neither upon filters nor upon a mechanical cooling system.
- 6.4.8.10 A package shall not include a pressure relief system from the containment system which would allow the release of radioactive material to the environment under the conditions of the tests specified in 6.4.15 and 6.4.17.
- 6.4.8.11 A package shall be so designed that if it were at the maximum normal operating pressure and it were subjected to the tests specified in 6.4.15 and 6.4.17, the level of strains in the containment system would not attain values which would adversely affect the package in such a way that it would fail to meet the applicable requirements.
- 6.4.8.12 A package shall not have a maximum normal operating pressure in excess of a gauge pressure of 700 kPa.
- 6.4.8.13 The maximum temperature of any surface readily accessible during carriage of a package shall not exceed 85 °C in the absence of insolation under the ambient conditions specified in 6.4.8.4. The package shall be carried under exclusive use, as specified in 6.4.8.3, if this maximum temperature exceeds 50 °C. Account may be taken of barriers or screens intended to give protection to persons without the need for the barriers or screens being subject to any test.
- 6.4.8.14 *(Reserved)*
- 6.4.8.15 A package shall be designed for an ambient temperature range from -40 °C to +38 °C.

6.4.9 Requirements for Type B(M) packages

- 6.4.9.1 Type B(M) packages shall meet the requirements for Type B(U) packages specified in 6.4.8.1, except that for packages to be carried solely within a specified country or solely between specified countries, conditions other than those given in 6.4.7.5, 6.4.8.4, 6.4.8.5, and 6.4.8.8 to 6.4.8.15 above may be assumed with the approval of the competent authorities of these countries. Notwithstanding, the requirements for Type B(U) packages specified in 6.4.8.8 to 6.4.8.15 shall be met as far as practicable.

6.4.9.2 Intermittent venting of Type B(M) packages may be permitted during carriage, provided that the operational controls for venting are acceptable to the relevant competent authorities.

6.4.10 Requirements for Type C packages

6.4.10.1 Type C packages shall be designed to meet the requirements specified in 6.4.2 and of 6.4.7.2 to 6.4.7.15, except as specified in 6.4.7.14 (a), and of the requirements specified in 6.4.8.2 to 6.4.8.5, 6.4.8.9 to 6.4.8.15, and, in addition, of 6.4.10.2 to 6.4.10.4.

6.4.10.2 A package shall be capable of meeting the assessment criteria prescribed for tests in 6.4.8.7 (b) and 6.4.8.11 after burial in an environment defined by a thermal conductivity of $0.33 \text{ W.m}^{-1}.\text{K}^{-1}$ and a temperature of $38 \text{ }^\circ\text{C}$ in the steady state. Initial conditions for the assessment shall assume that any thermal insulation of the package remains intact, the package is at the maximum normal operating pressure and the ambient temperature is $38 \text{ }^\circ\text{C}$.

6.4.10.3 A package shall be so designed that, if it were at the maximum normal operating pressure and subjected to:

- (a) The tests specified in 6.4.15, it would restrict the loss of radioactive contents to not more than 10^{-6} A_2 per hour; and
- (b) The test sequences in 6.4.20.1, it would meet the following requirements:
 - (i) retain sufficient shielding to ensure that the radiation level at 1 m from the surface of the package would not exceed 10 mSv/h with the maximum radioactive contents which the package is designed to contain; and
 - (ii) restrict the accumulated loss of radioactive contents in a period of 1 week to not more than 10 A_2 for krypton-85 and not more than A_2 for all other radionuclides.

Where mixtures of different radionuclides are present, the provisions of 2.2.7.7.2.4 to 2.2.7.7.2.6 shall apply except that for krypton-85 an effective $\text{A}_2(\text{i})$ value equal to 10 A_2 may be used. For case (a) above, the assessment shall take into account the external contamination limits of 4.1.9.1.2.

6.4.10.4 A package shall be so designed that there will be no rupture of the containment system following performance of the enhanced water immersion test specified in 6.4.18.

6.4.11 Requirements for packages containing fissile material

6.4.11.1 Fissile material shall be carried so as to:

- (a) Maintain sub-criticality during normal and accident conditions of carriage; in particular, the following contingencies shall be considered:
 - (i) water leaking into or out of packages;
 - (ii) the loss of efficiency of built-in neutron absorbers or moderators;
 - (iii) rearrangement of the contents either within the package or as a result of loss from the package;
 - (iv) reduction of spaces within or between packages;

- (v) packages becoming immersed in water or buried in snow; and
 - (vi) temperature changes; and
- (b) Meet the requirements:
- (i) of 6.4.7.2 for fissile material contained in packages;
 - (ii) prescribed elsewhere in ADR which pertain to the radioactive properties of the material; and
 - (iii) specified in 6.4.11.3 to 6.4.11.12, unless excepted by 6.4.11.2.

6.4.11.2 Fissile material meeting one of the provisions (a) to (d) of this paragraph is excepted from the requirement to be carried in packages that comply with 6.4.11.3 to 6.4.11.12 as well as the other requirements of ADR that apply to fissile material. Only one type of exception is allowed per consignment.

- (a) A mass limit per consignment such that:

$$\frac{\text{mass of uranium - 235 (g)}}{X} + \frac{\text{mass of other fissile material (g)}}{Y}$$

where X and Y are the mass limits defined in Table 6.4.11.2, provided that either:

- (i) each individual package contains not more than 15 g of fissile material; for unpackaged material, this quantity limitation shall apply to the consignment being carried in or on the vehicle; or
- (ii) the fissile material is a homogeneous hydrogenous solution or mixture where the ratio of fissile nuclides to hydrogen is less than 5% by mass; or
- (iii) there is not more than 5 g of fissile material in any 10 litre volume of material.

Neither beryllium nor deuterium shall be present in quantities exceeding 0.1% of the fissile material mass;

- (b) Uranium enriched in uranium-235 to a maximum of 1% by mass, and with a total plutonium and uranium-233 content not exceeding 1% of the mass of uranium-235, provided that the fissile material is distributed essentially homogeneously throughout the material. In addition, if uranium-235 is present in metallic, oxide or carbide forms, it shall not form a lattice arrangement;
- (c) Liquid solutions of uranyl nitrate enriched in uranium-235 to a maximum of 2% by mass, with a total plutonium and uranium-233 content not exceeding 0.002% of the mass of uranium, and with a minimum nitrogen to uranium atomic ratio (N/U) of 2;
- (d) Packages containing, individually, a total plutonium mass not more than 1 kg, of which not more than 20% by mass may consist of plutonium-239, plutonium-241 or any combination of those radionuclides.

Table 6.4.11.2: Consignment mass limits for exceptions from the requirements for packages containing fissile material

Fissile material	Fissile material mass (g) mixed with substances having an average hydrogen density less than or equal to water	Fissile material mass (g) mixed with substances having an average hydrogen density greater than water
Uranium -235(X)	400	290
Other fissile material (Y)	250	180

6.4.11.3 Where the chemical or physical form, isotopic composition, mass or concentration, moderation ratio or density, or geometric configuration is not known, the assessments of 6.4.11.7 to 6.4.11.12 shall be performed assuming that each parameter that is not known has the value which gives the maximum neutron multiplication consistent with the known conditions and parameters in these assessments.

6.4.11.4 For irradiated nuclear fuel the assessments of 6.4.11.7 to 6.4.11.12 shall be based on an isotopic composition demonstrated to provide:

- (a) The maximum neutron multiplication during the irradiation history; or
- (b) A conservative estimate of the neutron multiplication for the package assessments. After irradiation but prior to shipment, a measurement shall be performed to confirm the conservatism of the isotopic composition.

6.4.11.5 The packaging, after being subjected to the tests specified in 6.4.15, must prevent the entry of a 10 cm cube.

6.4.11.6 The package shall be designed for an ambient temperature range of -40°C to + 38°C unless the competent authority specifies otherwise in the certificate of approval for the package design.

6.4.11.7 For a package in isolation, it shall be assumed that water can leak into or out of all void spaces of the package, including those within the containment system. However, if the design incorporates special features to prevent such leakage of water into or out of certain void spaces, even as a result of error, absence of leakage may be assumed in respect of those void spaces. Special features shall include the following:

- (a) Multiple high standard water barriers, each of which would remain watertight if the package were subject to the tests prescribed in 6.4.11.12 (b), a high degree of quality control in the manufacture, maintenance and repair of packagings and tests to demonstrate the closure of each package before each shipment; or
- (b) For packages containing uranium hexafluoride only:
 - (i) packages where, following the tests prescribed in 6.4.11.12 (b), there is no physical contact between the valve and any other component of the packaging other than at its original point of attachment and where, in addition, following the test prescribed in 6.4.17.3 the valves remain leaktight; and
 - (ii) a high degree of quality control in the manufacture, maintenance and repair of packagings coupled with tests to demonstrate closure of each package before each shipment.

- 6.4.11.8 It shall be assumed that the confinement system shall be closely reflected by at least 20 cm of water or such greater reflection as may additionally be provided by the surrounding material of the packaging. However, when it can be demonstrated that the confinement system remains within the packaging following the tests prescribed in 6.4.11.12 (b), close reflection of the package by at least 20 cm of water may be assumed in 6.4.11.9 (c).
- 6.4.11.9 The package shall be subcritical under the conditions of 6.4.11.7 and 6.4.11.8 with the package conditions that result in the maximum neutron multiplication consistent with:
- (a) Routine conditions of carriage (incident free);
 - (b) The tests specified in 6.4.11.11 (b);
 - (c) The tests specified in 6.4.11.12 (b).
- 6.4.11.10 *(Reserved)*
- 6.4.11.11 For normal conditions of carriage a number "N" shall be derived, such that five times "N" shall be sub-critical for the arrangement and package conditions that provide the maximum neutron multiplication consistent with the following:
- (a) There shall not be anything between the packages, and the package arrangement shall be reflected on all sides by at least 20 cm of water; and
 - (b) The state of the packages shall be their assessed or demonstrated condition if they had been subjected to the tests specified in 6.4.15.
- 6.4.11.12 For accident conditions of carriage a number "N" shall be derived, such that two times "N" shall be sub-critical for the arrangement and package conditions that provide the maximum neutron multiplication consistent with the following:
- (a) Hydrogenous moderation between packages, and the package arrangement reflected on all sides by at least 20 cm of water; and
 - (b) The tests specified in 6.4.15 followed by whichever of the following is the more limiting:
 - (i) the tests specified in 6.4.17.2 (b) and, either 6.4.17.2 (c) for packages having a mass not greater than 500 kg and an overall density not greater than 1 000 kg/m³ based on the external dimensions, or 6.4.17.2 (a) for all other packages; followed by the test specified in 6.4.17.3 and completed by the tests specified in 6.4.19.1 to 6.4.19.3; or
 - (ii) the test specified in 6.4.17.4; and
 - (c) Where any part of the fissile material escapes from the containment system following the tests specified in 6.4.11.12 (b), it shall be assumed that fissile material escapes from each package in the array and all of the fissile material shall be arranged in the configuration and moderation that results in the maximum neutron multiplication with close reflection by at least 20 cm of water.

6.4.12 Test procedures and demonstration of compliance

6.4.12.1 Demonstration of compliance with the performance standards required in 2.2.7.3.3, 2.2.7.3.4, 2.2.7.4.1, 2.2.7.4.2, and 6.4.2 to 6.4.11 must be accomplished by any of the methods listed below or by a combination thereof:

- (a) Performance of tests with specimens representing LSA-III material, or special form radioactive material, or with prototypes or samples of the packaging, where the contents of the specimen or the packaging for the tests shall simulate as closely as practicable the expected range of radioactive contents and the specimen or packaging to be tested shall be prepared as presented for carriage;
- (b) Reference to previous satisfactory demonstrations of a sufficiently similar nature;
- (c) Performance of tests with models of appropriate scale incorporating those features which are significant with respect to the item under investigation when engineering experience has shown results of such tests to be suitable for design purposes. When a scale model is used, the need for adjusting certain test parameters, such as penetrator diameter or compressive load, shall be taken into account;
- (d) Calculation, or reasoned argument, when the calculation procedures and parameters are generally agreed to be reliable or conservative.

6.4.12.2 After the specimen, prototype or sample has been subjected to the tests, appropriate methods of assessment shall be used to assure that the requirements for the test procedures have been fulfilled in compliance with the performance and acceptance standards prescribed in 2.2.7.3.3, 2.2.7.3.4, 2.2.7.4.1, 2.2.7.4.2, and 6.4.2 to 6.4.11.

6.4.12.3 All specimens shall be inspected before testing in order to identify and record faults or damage including the following:

- (a) Divergence from the design;
- (b) Defects in manufacture;
- (c) Corrosion or other deterioration; and
- (d) Distortion of features.

The containment system of the package shall be clearly specified. The external features of the specimen shall be clearly identified so that reference may be made simply and clearly to any part of such specimen.

6.4.13 Testing the integrity of the containment system and shielding and evaluating criticality safety

After each of the applicable tests specified in 6.4.15 to 6.4.21:

- (a) Faults and damage shall be identified and recorded;
- (b) It shall be determined whether the integrity of the containment system and shielding has been retained to the extent required in 6.4.2 to 6.4.11 for the package under test; and

- (c) For packages containing fissile material, it shall be determined whether the assumptions and conditions used in the assessments required by 6.4.11.1 to 6.4.11.12 for one or more packages are valid.

6.4.14 Target for drop tests

The target for the drop tests specified in 2.2.7.4.5 (a), 6.4.15.4, 6.4.16 (a), 6.4.17.2 shall be a flat, horizontal surface of such a character that any increase in its resistance to displacement or deformation upon impact by the specimen would not significantly increase the damage to the specimen.

6.4.15 Tests for demonstrating ability to withstand normal conditions of carriage

6.4.15.1 The tests are: the water spray test, the free drop test, the stacking test and the penetration test. Specimens of the package shall be subjected to the free drop test, the stacking test and the penetration test, preceded in each case by the water spray test. One specimen may be used for all the tests, provided that the requirements of 6.4.15.2 are fulfilled.

6.4.15.2 The time interval between the conclusion of the water spray test and the succeeding test shall be such that the water has soaked in to the maximum extent, without appreciable drying of the exterior of the specimen. In the absence of any evidence to the contrary, this interval shall be taken to be two hours if the water spray is applied from four directions simultaneously. No time interval shall elapse, however, if the water spray is applied from each of the four directions consecutively.

6.4.15.3 Water spray test: The specimen shall be subjected to a water spray test that simulates exposure to rainfall of approximately 5 cm per hour for at least one hour.

6.4.15.4 Free drop test: The specimen shall drop onto the target so as to suffer maximum damage in respect of the safety features to be tested.

- (a) The height of drop measured from the lowest point of the specimen to the upper surface of the target shall be not less than the distance specified in Table 6.4.15.4 for the applicable mass. The target shall be as defined in 6.4.14;
- (b) For rectangular fibreboard or wood packages not exceeding a mass of 50 kg, a separate specimen shall be subjected to a free drop onto each corner from a height of 0.3 m;
- (c) For cylindrical fibreboard packages not exceeding a mass of 100 kg, a separate specimen shall be subjected to a free drop onto each of the quarters of each rim from a height of 0.3 m.

Table 6.4.15.4: Free drop distance for testing packages to normal conditions of carriage

Package mass (kg)	Free drop distance (m)
Package mass < 5 000	1.2
5 000 ≤ Package mass < 10 000	0.9
10 000 ≤ Package mass < 15 000	0.6
15 000 ≤ Package mass	0.3

6.4.15.5 Stacking test: Unless the shape of the packaging effectively prevents stacking, the specimen shall be subjected, for a period of 24 h, to a compressive load equal to the greater of the following:

- (a) The equivalent of 5 times the mass of the actual package; and
- (b) The equivalent of 13 kPa multiplied by the vertically projected area of the package.

The load shall be applied uniformly to two opposite sides of the specimen, one of which shall be the base on which the package would typically rest.

6.4.15.6 Penetration test: The specimen shall be placed on a rigid, flat, horizontal surface which will not move significantly while the test is being carried out.

- (a) A bar of 3.2 cm in diameter with a hemispherical end and a mass of 6 kg shall be dropped and directed to fall, with its longitudinal axis vertical, onto the centre of the weakest part of the specimen, so that, if it penetrates sufficiently far, it will hit the containment system. The bar shall not be significantly deformed by the test performance;
- (b) The height of drop of the bar measured from its lower end to the intended point of impact on the upper surface of the specimen shall be 1 m.

6.4.16 Additional tests for Type A packages designed for liquids and gases

A specimen or separate specimens shall be subjected to each of the following tests unless it can be demonstrated that one test is more severe for the specimen in question than the other, in which case one specimen shall be subjected to the more severe test.

- (a) Free drop test: The specimen shall drop onto the target so as to suffer the maximum damage in respect of containment. The height of the drop measured from the lowest part of the specimen to the upper surface of the target shall be 9 m. The target shall be as defined in 6.4.14;
- (b) Penetration test: The specimen shall be subjected to the test specified in 6.4.15.6 except that the height of drop shall be increased to 1.7 m from the 1 m specified in 6.4.15.6 (b).

6.4.17 Tests for demonstrating ability to withstand accident conditions in carriage

6.4.17.1 The specimen shall be subjected to the cumulative effects of the tests specified in 6.4.17.2 and 6.4.17.3, in that order. Following these tests, either this specimen or a separate specimen shall be subjected to the effect(s) of the water immersion test(s) as specified in 6.4.17.4 and, if applicable, 6.4.18.

6.4.17.2 Mechanical test: The mechanical test consists of three different drop tests. Each specimen shall be subjected to the applicable drops as specified in 6.4.8.7 or 6.4.11.12. The order in which the specimen is subjected to the drops shall be such that, on completion of the mechanical test, the specimen shall have suffered such damage as will lead to the maximum damage in the thermal test which follows.

- (a) For drop I, the specimen shall drop onto the target so as to suffer the maximum damage, and the height of the drop measured from the lowest point of the specimen to the upper surface of the target shall be 9 m. The target shall be as defined in 6.4.14;

- (b) For drop II, the specimen shall drop so as to suffer the maximum damage onto a bar rigidly mounted perpendicularly on the target. The height of the drop measured from the intended point of impact of the specimen to the upper surface of the bar shall be 1 m. The bar shall be of solid mild steel of circular section, (15.0 cm ± 0.5 cm) in diameter and 20 cm long unless a longer bar would cause greater damage, in which case a bar of sufficient length to cause maximum damage shall be used. The upper end of the bar shall be flat and horizontal with its edges rounded off to a radius of not more than 6 mm. The target on which the bar is mounted shall be as described in 6.4.14;
- (c) For drop III, the specimen shall be subjected to a dynamic crush test by positioning the specimen on the target so as to suffer maximum damage by the drop of a 500 kg mass from 9 m onto the specimen. The mass shall consist of a solid mild steel plate 1 m by 1 m and shall fall in a horizontal attitude. The height of the drop shall be measured from the underside of the plate to the highest point of the specimen. The target on which the specimen rests shall be as defined in 6.4.14.

6.4.17.3 Thermal test: The specimen shall be in thermal equilibrium under conditions of an ambient temperature of 38 °C, subject to the solar insolation conditions specified in Table 6.4.8.5 and subject to the design maximum rate of internal heat generation within the package from the radioactive contents. Alternatively, any of these parameters are allowed to have different values prior to and during the test, providing due account is taken of them in the subsequent assessment of package response.

The thermal test shall then consist of:

- (a) Exposure of a specimen for a period of 30 minutes to a thermal environment which provides a heat flux at least equivalent to that of a hydrocarbon fuel/air fire in sufficiently quiescent ambient conditions to give a minimum average flame emissivity coefficient of 0.9 and an average temperature of at least 800 °C, fully engulfing the specimen, with a surface absorptivity coefficient of 0.8 or that value which the package may be demonstrated to possess if exposed to the fire specified, followed by,
- (b) Exposure of the specimen to an ambient temperature of 38 °C, subject to the solar insolation conditions specified in Table 6.4.8.5 and subject to the design maximum rate of internal heat generation within the package by the radioactive contents for a sufficient period to ensure that temperatures in the specimen are everywhere decreasing and/or are approaching initial steady state conditions. Alternatively, any of these parameters are allowed to have different values following cessation of heating, providing due account is taken of them in the subsequent assessment of package response.

During and following the test the specimen shall not be artificially cooled and any combustion of materials of the specimen shall be permitted to proceed naturally.

6.4.17.4 Water immersion test: The specimen shall be immersed under a head of water of at least 15 m for a period of not less than eight hours in the attitude which will lead to maximum damage. For demonstration purposes, an external gauge pressure of at least 150 kPa shall be considered to meet these conditions.

6.4.18 **Enhanced water immersion test for Type B(U) and Type B(M) packages containing more than 10⁵ A₂ and Type C packages**

Enhanced water immersion test: The specimen shall be immersed under a head of water of at least 200 m for a period of not less than one hour. For demonstration purposes, an external gauge pressure of at least 2 MPa shall be considered to meet these conditions.

6.4.19 Water leakage test for packages containing fissile material

- 6.4.19.1 Packages for which water in-leakage or out-leakage to the extent which results in greatest reactivity has been assumed for purposes of assessment under 6.4.11.7 to 6.4.11.12 shall be excepted from the test.
- 6.4.19.2 Before the specimen is subjected to the water leakage test specified below, it shall be subjected to the tests in 6.4.17.2 (b), and either 6.4.17.2 (a) or (c) as required by 6.4.11.12, and the test specified in 6.4.17.3.
- 6.4.19.3 The specimen shall be immersed under a head of water of at least 0.9 m for a period of not less than 8 hours and in the attitude for which maximum leakage is expected.

6.4.20 Tests for Type C packages

- 6.4.20.1 Specimens shall be subjected to the effects of each of the following test sequences in the orders specified:

- (a) The tests specified in 6.4.17.2 (a), 6.4.17.2 (c), 6.4.20.2 and 6.4.20.3; and
- (b) The test specified in 6.4.20.4.

Separate specimens are allowed to be used for each of the sequences (a) and (b).

- 6.4.20.2 Puncture/tearing test: The specimen shall be subjected to the damaging effects of a solid probe made of mild steel. The orientation of the probe to the surface of the specimen shall be as to cause maximum damage at the conclusion of the test sequence specified in 6.4.20.1 (a).

- (a) The specimen, representing a package having a mass less than 250 kg, shall be placed on a target and subjected to a probe having a mass of 250 kg falling from a height of 3 m above the intended impact point. For this test the probe shall be a 20 cm diameter cylindrical bar with the striking end forming a frustum of a right circular cone with the following dimensions: 30 cm height and 2.5 cm in diameter at the top. The target on which the specimen is placed shall be as specified in 6.4.14;
- (b) For packages having a mass of 250 kg or more, the base of the probe shall be placed on a target and the specimen dropped onto the probe. The height of the drop, measured from the point of impact with the specimen to the upper surface of the probe shall be 3 m. For this test the probe shall have the same properties and dimensions as specified in (a) above, except that the length and mass of the probe shall be such as to incur maximum damage to the specimen. The target on which the base of the probe is placed shall be as specified in 6.4.14.

- 6.4.20.3 Enhanced thermal test: The conditions for this test shall be as specified in 6.4.17.3, except that the exposure to the thermal environment shall be for a period of 60 minutes.

- 6.4.20.4 Impact test: The specimen shall be subject to an impact on a target at a velocity of not less than 90 m/s, at such an orientation as to suffer maximum damage. The target shall be as defined in 6.4.14.

- 6.4.21 Inspections for packagings designed to contain 0.1 kg or more of uranium hexafluoride**
- 6.4.21.1 Every manufactured packaging and its service and structural equipment shall, either jointly or separately, undergo an inspection initially before being put into service and periodically thereafter. These inspections shall be performed and certified by agreement with the competent authority.
- 6.4.21.2 The initial inspection shall consist of a check of the design characteristics, a structural test, a leakproofness test, a water capacity test and a check of satisfactory operation of the service equipment.
- 6.4.21.3 The periodic inspections shall consist of a visual examination, a structural test, a leakproofness test and a check of satisfactory operation of the service equipment. The maximum intervals for periodic inspections shall be five years. Packagings which have not been inspected within this five-year period shall be examined before carriage in accordance with a programme approved by the competent authority. They shall not be refilled before completion of the full programme for periodic inspections.
- 6.4.21.4 The check of design characteristics shall demonstrate compliance with the design type specifications and the manufacturing programme.
- 6.4.21.5 For the initial structural test, packagings designed to contain 0.1 kg or more of uranium hexafluoride shall be tested hydraulically at an internal pressure of at least 1.38 MPa but, when the test pressure is less than 2.76 MPa, the design shall require multilateral approval. For retesting packagings, any other equivalent non-destructive testing may be applied subject to multilateral approval.
- 6.4.21.6 The leakproofness test shall be performed in accordance with a procedure which is capable of indicating leakages in the containment system with a sensitivity of 0.1 Pa.l/s (10^{-6} bar.l/s).
- 6.4.21.7 The water capacity of the packagings shall be established with an accuracy of $\pm 0.25\%$ at a reference temperature of 15 °C. The volume shall be stated on the plate described in 6.4.21.8.
- 6.4.21.8 A plate made of non-corroding metal shall be durably attached to every packaging in a readily accessible place. The method of attaching the plate must not impair the strength of the packaging. The following particulars, at least, shall be marked on the plate by stamping or by any other equivalent method:
- Approval number;
 - Manufacturer's serial number;
 - Maximum working pressure (gauge pressure);
 - Test pressure (gauge pressure);
 - Contents: uranium hexafluoride;
 - Capacity in litres;
 - Maximum permissible filling mass of uranium hexafluoride;
 - Tare mass;
 - Date (month, year) of the initial test and the most recent periodic test;
 - Stamp of the expert who performed the tests.

6.4.22 Approvals of package designs and materials

6.4.22.1 The approval of designs for packages containing 0.1 kg or more of uranium hexafluoride requires that:

- (a) Each design that meets the requirements of 6.4.6.4 shall require multilateral approval;
- (b) After 31 December 2003, each design that meets the requirements of 6.4.6.1 to 6.4.6.3 shall require unilateral approval by the competent authority of the country of origin of the design.

6.4.22.2 Each Type B(U) and Type C package design shall require unilateral approval, except that:

- (a) A package design for fissile material, which is also subject to 6.4.22.4, 6.4.23.7, and 5.1.5.3.1 shall require multilateral approval; and
- (b) A Type B(U) package design for low dispersible radioactive material shall require multilateral approval.

6.4.22.3 Each Type B(M) package design, including those for fissile material which are also subject to the requirements of 6.4.22.4, 6.4.23.7, and 5.1.5.3.1 and those for low dispersible radioactive material, shall require multilateral approval.

6.4.22.4 Each package design for fissile material which is not excepted according to 6.4.11.2 from the requirements that apply specifically to packages containing fissile material shall require multilateral approval.

6.4.22.5 The design for special form radioactive material shall require unilateral approval. The design for low dispersible radioactive material shall require multilateral approval (see also 6.4.23.8).

6.4.22.6 Any design that requires unilateral approval originating in a country Contracting Party to ADR shall be approved by the competent authority of this country; if the country where the package has been designed is not a Contracting Party to ADR, carriage is possible on condition that:

- (a) a certificate has been supplied by this country, proving that the package satisfies the technical requirements of ADR, and that this certificate is countersigned by the competent authority of the first country Contracting Party to ADR reached by the consignment;
- (b) if no certificate and no existing package design approval by a country Contracting Party to ADR has been supplied, the package design is approved by the competent authority of the first country Contracting Party to ADR reached by the consignment.

6.4.22.7 For designs approved under the transitional measures see 1.6.6.

6.4.23 Applications and approvals for radioactive material carriage

6.4.23.1 *(Reserved)*

6.4.23.2 An application for shipment approval shall include:

- (a) The period of time, related to the shipment, for which the approval is sought;
- (b) The actual radioactive contents, the expected modes of carriage, the type of vehicle, and the probable or proposed route; and

- (c) The details of how the precautions and administrative or operational controls, referred to in the package design approval certificates issued under 5.1.5.3.1, are to be put into effect.

6.4.23.3 An application for approval of shipments under special arrangement shall include all the information necessary to satisfy the competent authority that the overall level of safety in carriage is at least equivalent to that which would be provided if all the applicable requirements of ADR had been met.

The application shall also include:

- (a) A statement of the respects in which, and of the reasons why, the consignment cannot be made in full accordance with the applicable requirements of ADR; and
- (b) A statement of any special precautions or special administrative or operational controls which are to be employed during carriage to compensate for the failure to meet the applicable requirements of ADR.

6.4.23.4 An application for approval of Type B(U) or Type C package design shall include:

- (a) A detailed description of the proposed radioactive contents with reference to their physical and chemical states and the nature of the radiation emitted;
- (b) A detailed statement of the design, including complete engineering drawings and schedules of materials and methods of manufacture;
- (c) A statement of the tests which have been done and their results, or evidence based on calculative methods or other evidence that the design is adequate to meet the applicable requirements;
- (d) The proposed operating and maintenance instructions for the use of the packaging;
- (e) If the package is designed to have a maximum normal operating pressure in excess of 100 kPa gauge, a specification of the materials of manufacture of the containment system, the samples to be taken, and the tests to be made;
- (f) Where the proposed radioactive contents are irradiated fuel, a statement and a justification of any assumption in the safety analysis relating to the characteristics of the fuel and a description of any pre-shipment measurement as required by 6.4.11.4 (b);
- (g) Any special stowage provisions necessary to ensure the safe dissipation of heat from the package considering the various modes of carriage to be used and type of vehicle or container;
- (h) A reproducible illustration, not larger than 21 cm by 30 cm, showing the make-up of the package; and
- (i) A specification of the applicable quality assurance programme as required 1.7.3.

6.4.23.5 An application for approval of a Type B(M) package design shall include, in addition to the general information required for package approval in 6.4.23.4 for Type B(U) packages:

- (a) A list of the requirements specified in 6.4.7.5, 6.4.8.4, 6.4.8.5 and 6.4.8.8 to 6.4.8.15 with which the package does not conform;

- (b) Any proposed supplementary operational controls to be applied during carriage not regularly provided for in this Annex, but which are necessary to ensure the safety of the package or to compensate for the deficiencies listed in (a) above;
- (c) A statement relative to any restrictions on the mode of carriage and to any special loading, carriage, unloading or handling procedures; and
- (d) The range of ambient conditions (temperature, solar radiation) which are expected to be encountered during carriage and which have been taken into account in the design.

6.4.23.6 The application for approval of designs for packages containing 0.1 kg or more of uranium hexafluoride shall include all information necessary to satisfy the competent authority that the design meets the applicable requirements of 6.4.6.1, and a description of the applicable quality assurance programme as required in 1.7.3.

6.4.23.7 An application for a fissile package approval shall include all information necessary to satisfy the competent authority that the design meets the applicable requirements of 6.4.11.1, and a specification of the applicable quality assurance programme as required by 1.7.3.

6.4.23.8 An application for approval of design for special form radioactive material and design for low dispersible radioactive material shall include:

- (a) A detailed description of the radioactive material or, if a capsule, the contents; particular reference shall be made to both physical and chemical states;
- (b) A detailed statement of the design of any capsule to be used;
- (c) A statement of the tests which have been done and their results, or evidence based on calculative methods to show that the radioactive material is capable of meeting the performance standards, or other evidence that the special form radioactive material or low dispersible radioactive material meets the applicable requirements of ADR;
- (d) A specification of the applicable quality assurance programme as required in 1.7.3; and
- (e) Any proposed pre-shipment actions for use in the consignment of special form radioactive material or low dispersible radioactive material.

6.4.23.9 Each approval certificate issued by a competent authority shall be assigned an identification mark. The identification mark shall be of the following generalized type:

VRI/Number/Type Code

- (a) Except as provided in 6.4.23.10 (b), VRI represents the international vehicle registration identification code of the country issuing the certificate ¹;
- (b) The number shall be assigned by the competent authority, and shall be unique and specific with regard to the particular design or shipment. The shipment approval identification mark shall be clearly related to the design approval identification mark;

¹ See *Vienna Convention on Road Traffic (1968)*.

- (c) The following type codes shall be used in the order listed to indicate the types of approval certificates issued:

AF	Type A package design for fissile material
B(U)	Type B(U) package design [B(U) F if for fissile material]
B(M)	Type B(M) package design [B(M) F if for fissile material]
C	Type C package design (CF if for fissile material)
IF	Industrial package design for fissile material
S	Special form radioactive material
LD	Low dispersible radioactive material
T	Shipment
X	Special arrangement

In the case of package designs for non-fissile or fissile excepted uranium hexafluoride, where none of the above codes apply, then the following type codes shall be used:

H(U)	Unilateral approval
H(M)	Multilateral approval;

- (d) For package design and special form radioactive material approval certificates, other than those issued under transitional packaging the provisions of 1.6.5.2 to 1.6.5.4, and for low dispersible radioactive material approval certificates, the symbols "-96" shall be added to the type code.

6.4.23.10 These type codes shall be applied as follows:

- (a) Each certificate and each package shall bear the appropriate identification mark, comprising the symbols prescribed in 6.4.23.9 (a), (b), (c) and (d) above, except that, for packages, only the applicable design type codes including, if applicable, the symbols "-96", shall appear following the second stroke, that is, the "T" or "X" shall not appear in the identification marking on the package. Where the design approval and shipment approval are combined, the applicable type codes do not need to be repeated. For example:

A/132/B(M)F-96: A Type B(M) package design approved for fissile material, requiring multilateral approval, for which the competent authority of Austria has assigned the design number 132 (to be marked on both the package and on the package design approval certificate);

A/132/B(M)F-96T: The shipment approval issued for a package bearing the identification mark elaborated above (to be marked on the certificate only);

A/137/X: A special arrangement approval issued by the competent authority of Austria, to which the number 137 has been assigned (to be marked on the certificate only);

A/139/IF-96: An industrial package design for fissile material approved by the competent authority of Austria, to which package design number 139 has been assigned (to be marked on both the package and on the package design approval certificate); and

A/145/H(U)-96: A package design for fissile excepted uranium hexafluoride approved by the competent authority of Austria, to which package design number 145 has been assigned (to be marked on

both the package and on the package design approval certificate);

- (b) Where multilateral approval is effected by validation according to 6.4.23.16, only the identification mark issued by the country of origin of the design or shipment shall be used. Where multilateral approval is effected by issue of certificates by successive countries, each certificate shall bear the appropriate identification mark and the package whose design was so approved shall bear all appropriate identification marks.

For example:

A/132/B(M)F-96
CH/28/B(M)F-96

would be the identification mark of a package which was originally approved by Austria and was subsequently approved, by separate certificate, by Switzerland. Additional identification marks would be tabulated in a similar manner on the package;

- (c) The revision of a certificate shall be indicated by a parenthetical expression following the identification mark on the certificate. For example, A/132/B(M)F-96 (Rev.2) would indicate revision 2 of the Austrian package design approval certificate; or A/132/B(M)F-96 (Rev.0) would indicate the original issuance of the Austrian package design approval certificate. For original issuances, the parenthetical entry is optional and other words such as "original issuance" may also be used in place of "Rev.0". Certificate revision numbers may only be issued by the country issuing the original approval certificate;
- (d) Additional symbols (as may be necessitated by national regulations) may be added in brackets to the end of the identification mark; for example, A/132/B(M)F-96(SP503);
- (e) It is not necessary to alter the identification mark on the packaging each time that a revision to the design certificate is made. Such re-marking shall be required only in those cases where the revision to the package design certificate involves a change in the letter type codes for the package design following the second stroke.

6.4.23.11

Each approval certificate issued by a competent authority for special form radioactive material or low dispersible radioactive material shall include the following information:

- (a) Type of certificate;
- (b) The competent authority identification mark;
- (c) The issue date and an expiry date;
- (d) List of applicable national and international regulations, including the edition of the IAEA Regulations for the Safe Transport of Radioactive Material under which the special form radioactive material or low dispersible radioactive material is approved;
- (e) The identification of the special form radioactive material or low dispersible radioactive material;
- (f) A description of the special form radioactive material or low dispersible radioactive material;

- (g) Design specifications for the special form radioactive material or low dispersible radioactive material which may include references to drawings;
- (h) A specification of the radioactive contents which includes the activities involved and which may include the physical and chemical form;
- (i) A specification of the applicable quality assurance programme as required in 1.7.3;
- (j) Reference to information provided by the applicant relating to specific actions to be taken prior to shipment;
- (k) If deemed appropriate by the competent authority, reference to the identity of the applicant;
- (l) Signature and identification of the certifying official.

6.4.23.12

Each approval certificate issued by a competent authority for a special arrangement shall include the following information:

- (a) Type of certificate;
- (b) The competent authority identification mark;
- (c) The issue date and an expiry date;
- (d) Mode(s) of carriage;
- (e) Any restrictions on the modes of carriage, type of vehicle, container, and any necessary routing instructions;
- (f) List of applicable national and international regulations, including the edition of the IAEA Regulations for the Safe Transport of Radioactive Material under which the special arrangement is approved;
- (g) The following statement:

"This certificate does not relieve the consignor from compliance with any requirement of the government of any country through or into which the package will be carried.";
- (h) References to certificates for alternative radioactive contents, other competent authority validation, or additional technical data or information, as deemed appropriate by the competent authority;
- (i) Description of the packaging by a reference to the drawings or a specification of the design. If deemed appropriate by the competent authority, a reproducible illustration, not larger than 21 cm by 30 cm, showing the make-up of the package shall also be provided, accompanied by a brief description of the packaging, including materials of manufacture, gross mass, general outside dimensions and appearance;
- (j) A specification of the authorized radioactive contents, including any restrictions on the radioactive contents which might not be obvious from the nature of the packaging. This shall include the physical and chemical forms, the activities involved (including those of the various isotopes, if appropriate), amounts in grams (for fissile material), and whether special form radioactive material or low dispersible radioactive material, if applicable;

- (k) Additionally, for packages containing fissile material:
 - (i) a detailed description of the authorized radioactive contents;
 - (ii) the value of the criticality safety index;
 - (iii) reference to the documentation that demonstrates the criticality safety of the contents;
 - (iv) any special features, on the basis of which the absence of water from certain void spaces has been assumed in the criticality assessment;
 - (v) any allowance (based on 6.4.11.4 (b)) for a change in neutron multiplication assumed in the criticality assessment as a result of actual irradiation experience; and
 - (vi) the ambient temperature range for which the special arrangement has been approved;
- (l) A detailed listing of any supplementary operational controls required for preparation, loading, carriage, unloading and handling of the consignment, including any special stowage provisions for the safe dissipation of heat;
- (m) If deemed appropriate by the competent authority, reasons for the special arrangement;
- (n) Description of the compensatory measures to be applied as a result of the shipment being under special arrangement;
- (o) Reference to information provided by the applicant relating to the use of the packaging or specific actions to be taken prior to the shipment;
- (p) A statement regarding the ambient conditions assumed for purposes of design if these are not in accordance with those specified in 6.4.8.4, 6.4.8.5, and 6.4.8.15, as applicable;
- (q) Any emergency arrangements deemed necessary by the competent authority;
- (r) A specification of the applicable quality assurance programme as required in 1.7.3;
- (s) If deemed appropriate by the competent authority, reference to the identity of the applicant and to the identity of the carrier;
- (t) Signature and identification of the certifying official.

6.4.23.13 Each approval certificate for a shipment issued by a competent authority shall include the following information:

- (a) Type of certificate;
- (b) The competent authority identification mark(s);
- (c) The issue date and an expiry date;
- (d) List of applicable national and international regulations, including the edition of the IAEA Regulations for the Safe Transport of Radioactive Material under which the shipment is approved;

- (e) Any restrictions on the modes of carriage, type of vehicle, container, and any necessary routing instructions;
- (f) The following statement:

"This certificate does not relieve the consignor from compliance with any requirement of the government of any country through or into which the package will be carried.";
- (g) A detailed listing of any supplementary operational controls required for preparation, loading, carriage, unloading and handling of the consignment, including any special stowage provisions for the safe dissipation of heat or maintenance of criticality safety;
- (h) Reference to information provided by the applicant relating to specific actions to be taken prior to shipment;
- (i) Reference to the applicable design approval certificate(s);
- (j) A specification of the actual radioactive contents, including any restrictions on the radioactive contents which might not be obvious from the nature of the packaging. This shall include the physical and chemical forms, the total activities involved (including those of the various isotopes, if appropriate), amounts in grams (for fissile material), and whether special form radioactive material or low dispersible radioactive material, if applicable;
- (k) Any emergency arrangements deemed necessary by the competent authority;
- (l) A specification of the applicable quality assurance programme as required in 1.7.3;
- (m) If deemed appropriate by the competent authority, reference to the identity of the applicant;
- (n) Signature and identification of the certifying official.

6.4.23.14 Each approval certificate of the design of a package issued by a competent authority shall include the following information:

- (a) Type of certificate;
- (b) The competent authority identification mark;
- (c) The issue date and an expiry date;
- (d) Any restriction on the modes of carriage, if appropriate;
- (e) List of applicable national and international regulations, including the edition of the IAEA Regulations for the Safe Transport of Radioactive Material under which the design is approved;
- (f) The following statement:

"This certificate does not relieve the consignor from compliance with any requirement of the government of any country through or into which the package will be carried.";
- (g) References to certificates for alternative radioactive contents, other competent authority validation, or additional technical data or information, as deemed appropriate by the competent authority;

- (h) A statement authorizing shipment where shipment approval is required under 5.1.5.2.2, if deemed appropriate;
- (i) Identification of the packaging;
- (j) Description of the packaging by a reference to the drawings or specification of the design. If deemed appropriate by the competent authority, a reproducible illustration, not larger than 21 cm by 30 cm, showing the make-up of the package should also be provided, accompanied by a brief description of the packaging, including materials of manufacture, gross mass, general outside dimensions and appearance;
- (k) Specification of the design by reference to the drawings;
- (l) A specification of the authorized radioactive content, including any restrictions on the radioactive contents which might not be obvious from the nature of the packaging. This shall include the physical and chemical forms, the activities involved (including those of the various isotopes, if appropriate), amounts in grams (for fissile material), and whether special form radioactive material or low dispersible radioactive material, if applicable;
- (m) Additionally, for packages containing fissile material:
 - (i) a detailed description of the authorized radioactive contents;
 - (ii) the value of the criticality safety index;
 - (iii) reference to the documentation that demonstrates the criticality safety of the contents;
 - (iv) any special features, on the basis of which the absence of water from certain void spaces has been assumed in the criticality assessment;
 - (v) any allowance (based on 6.4.11.4 (b)) for a change in neutron multiplication assumed in the criticality assessment as a result of actual irradiation experience; and
 - (vi) the ambient temperature range for which the package design has been approved;
- (n) For Type B(M) packages, a statement specifying those requirements of 6.4.7.5, 6.4.8.4, 6.4.8.5 and 6.4.8.8 to 6.4.8.15 with which the package does not conform and any amplifying information which may be useful to other competent authorities;
- (o) A detailed listing of any supplementary operational controls required for preparation, loading, carriage, unloading and handling of the consignment, including any special stowage provisions for the safe dissipation of heat;
- (p) Reference to information provided by the applicant relating to the use of the packaging or specific actions to be taken prior to shipment;
- (q) A statement regarding the ambient conditions assumed for purposes of design if these are not in accordance with those specified in 6.4.8.4, 6.4.8.5 and 6.4.8.15, as applicable;
- (r) A specification of the applicable quality assurance programme as required in 1.7.3;

- (s) Any emergency arrangements deemed necessary by the competent authority;
- (t) If deemed appropriate by the competent authority, reference to the identity of the applicant;
- (u) Signature and identification of the certifying official.

6.4.23.15 The competent authority shall be informed of the serial number of each packaging manufactured to a design approved by them. The competent authority shall maintain a register of such serial numbers.

6.4.23.16 Multilateral approval may be by validation of the original certificate issued by the competent authority of the country of origin of the design or shipment. Such validation may take the form of an endorsement on the original certificate or the issuance of a separate endorsement, annex, supplement, etc., by the competent authority of the country through or into which the shipment is made.

