

## **PART 5**

# **CONSIGNMENT PROCEDURES**



## CHAPTER 5.1

### GENERAL PROVISIONS

#### 5.1.1 Application and general provisions

5.1.1.1 This Part sets forth the provisions for dangerous goods consignments relative to authorization of consignments and advance notifications, marking, labelling, documentation (by manual, electronic data processing (EDP) or electronic data interchange (EDI) techniques) and placarding.

5.1.1.2 Except as otherwise provided in these Regulations, no person may offer dangerous goods for transport unless those goods are properly marked, labelled, placarded, described and certified on a transport document, and otherwise in a condition for transport as required by this Part.

#### 5.1.2 Use of overpacks

5.1.2.1 An overpack shall be marked with the proper shipping name and the UN Number and labelled, as required for packages by Chapter 5.2, for each item of dangerous goods contained in the overpack unless markings and labels representative of all dangerous goods in the overpack are visible.

5.1.2.2 Each package of dangerous goods contained in the overpack shall comply with all applicable provisions of these Regulations. The intended function of each package shall not be impaired by the overpack.

#### 5.1.3 Empty packagings

5.1.3.1 Other than for Class 7, a packaging which previously contained dangerous goods shall be identified, marked, labelled and placarded as required for those dangerous goods unless steps such as cleaning, purging of vapours or refilling with a non-dangerous substance are taken to nullify any hazard.

5.1.3.2 Tanks and intermediate bulk containers used for the transport of radioactive material shall not be used for the storage or transport of other goods unless decontaminated below the level of 0.4 Bq/cm<sup>2</sup> for beta and gamma emitters and low toxicity alpha emitters and 0.04 Bq/cm<sup>2</sup> for all other alpha emitters.

#### 5.1.4 Mixed packing

When two or more dangerous goods are packed within the same outer packaging, the package shall be labelled and marked as required for each substance. Secondary risk labels need not be applied if the hazard is already represented by a primary risk label.

## **5.1.5 General provisions for Class 7**

### **5.1.5.1 Requirements before shipments**

#### 5.1.5.1.1 First shipment of a package

Before the first shipment of any package, the following requirements shall be fulfilled:

- (a) If the design pressure of the containment system exceeds 35 kPa (gauge), it shall be ensured that the containment system of each package conforms to the approved design requirements relating to the capability of that system to maintain its integrity under that pressure;
- (b) For each Type B(U), Type B(M) and Type C package and for each package containing fissile material, it shall be ensured that the effectiveness of its shielding and containment and, where necessary, the heat transfer characteristics and the effectiveness of the confinement system, are within the limits applicable to or specified for the approved design;
- (c) For packages containing fissile material, where, in order to comply with the requirements of 6.4.11.1, neutron poisons are specifically included as components of the package, checks shall be performed to confirm the presence and distribution of those neutron poisons.

#### 5.1.5.1.2 Each shipment

Before each shipment of any package, the following requirements shall be fulfilled:

- (a) For any package it shall be ensured that all the requirements specified in the relevant provisions of these Regulations have been satisfied;
- (b) It shall be ensured that lifting attachments which do not meet the requirements of 6.4.2.2 have been removed or otherwise rendered incapable of being used for lifting the package, in accordance with 6.4.2.3;
- (c) For each Type B(U), Type B(M) and Type C package and for each package containing fissile material, it shall be ensured that all the requirements specified in the approval certificates have been satisfied;
- (d) Each Type B(U), Type B(M) and Type C package shall be held until equilibrium conditions have been approached closely enough to demonstrate compliance with the requirements for temperature and pressure unless an exemption from these requirements has received unilateral approval;
- (e) For each Type B(U), Type B(M) and Type C package, it shall be ensured by inspection and/or appropriate tests that all closures, valves, and other openings of the containment system through which the radioactive contents might escape are properly closed and, where appropriate, sealed in the manner for which the demonstrations of compliance with the requirements of 6.4.8.7 and 6.4.10.3 were made;
- (f) For each special form radioactive material, it shall be ensured that all the requirements specified in the special form approval certificate and the relevant provisions of these Regulations have been satisfied;

- (g) For packages containing fissile material the measurement specified in 6.4.11.4(b) and the tests to demonstrate closure of each package as specified in 6.4.11.7 shall be performed where applicable;
- (h) For each low dispersible radioactive material, it shall be ensured that all the requirements specified in the approval certificate and the relevant provisions of these Regulations have been satisfied.

### **5.1.5.2 Approval of shipments and notification**

#### **5.1.5.2.1 General**

In addition to the approval for package designs described in Chapter 6.4, multilateral shipment approval is also required in certain circumstances (5.1.5.2.2 and 5.1.5.2.3). In some circumstances it is also necessary to notify competent authorities of a shipment (5.1.5.2.4).

#### **5.1.5.2.2 Shipment approvals**

Multilateral approval shall be required for:

- (a) The shipment of Type B(M) packages not conforming with the requirements of 6.4.7.5 or designed to allow controlled intermittent venting;
- (b) The shipment of Type B(M) packages containing radioactive material with an activity greater than 3000 A<sub>1</sub> or 3000 A<sub>2</sub>, as appropriate, or 1000 TBq, whichever is the lower;
- (c) The shipment of packages containing fissile materials if the sum of the criticality safety indexes of the packages exceeds 50; and
- (d) Radiation protection programmes for shipments by special use vessels according to 7.2.3.2.2;

except that a competent authority may authorize transport into or through its country without shipment approval, by a specific provision in its design approval (see 5.1.5.3.1).

#### **5.1.5.2.3 Shipment approval by special arrangement**

Provisions may be approved by a competent authority under which a consignment, which does not satisfy all of the applicable requirements of these Regulations may be transported under special arrangement (see 1.1.2.4).

#### **5.1.5.2.4 Notifications**

Notification to competent authorities is required as follows:

- (a) Before the first shipment of any package requiring competent authority approval, the consignor shall ensure that copies of each applicable competent authority certificate applying to that package design have been submitted to the competent authority of each country through or into which the consignment is to be transported. The consignor is not required to await an acknowledgement from the competent authority, nor is the competent authority required to make such acknowledgement of receipt of the certificate;

- (b) For each of the following types of shipments:
  - (i) Type C packages containing radioactive material with an activity greater than 3000 A<sub>1</sub> or 3000 A<sub>2</sub>, as appropriate, or 1000 TBq, whichever is the lower;
  - (ii) Type B(U) packages containing radioactive material with an activity greater than 3000 A<sub>1</sub> or 3000 A<sub>2</sub>, as appropriate, or 1000 TBq, whichever is the lower;
  - (iii) Type B(M) packages;
  - (iv) Shipment under special arrangement,

the consignor shall notify the competent authority of each country through or into which the consignment is to be transported. This notification shall be in the hands of each competent authority prior to the commencement of the shipment, and preferably at least 7 days in advance;

- (c) The consignor is not required to send a separate notification if the required information has been included in the application for shipment approval;
- (d) The consignment notification shall include:
  - (i) sufficient information to enable the identification of the package or packages including all applicable certificate numbers and identification marks;
  - (ii) information on the date of shipment, the expected date of arrival and proposed routing;
  - (iii) the names of the radioactive material or nuclides;
  - (iv) descriptions of the physical and chemical forms of the radioactive material, or whether it is special form radioactive material or low dispersible radioactive material; and
  - (v) the maximum activity of the radioactive contents during transport expressed in units of becquerels (Bq) with an appropriate SI prefix (see 1.2.2.1). For fissile material, the mass of fissile material in units of grams (g), or multiples thereof, may be used in place of activity.

### **5.1.5.3 Certificates issued by Competent Authority**

5.1.5.3.1 Certificates issued by the competent authority are required for the following:

- (a) Designs for
  - (i) special form radioactive material;
  - (ii) low dispersible radioactive material;
  - (iii) packages containing 0.1 kg or more of uranium hexafluoride;
  - (iv) all packages containing fissile material unless excepted by 6.4.11.2;
  - (v) type B(U) packages and Type B(M) packages;
  - (vi) type C packages;
- (b) Special arrangements;
- (c) Certain shipments (see 5.1.5.2.2).

The certificates shall confirm that the applicable requirements are met, and for design approvals shall attribute to the design an identification mark.

The package design and shipment approval certificates may be combined into a single certificate.

Certificates and applications for these certificates shall be in accordance with the requirements in 6.4.23.

5.1.5.3.2 The consignor shall be in possession of a copy of each applicable certificate. The consignor shall also have a copy of any instructions with regard to the proper closing of the package and any preparation for shipment before making any shipment under the terms of the certificates.

5.1.5.3.3 For package designs where a competent authority issued certificate is not required, the consignor shall, on request, make available for inspection by the relevant competent authority, documentary evidence of the compliance of the package design with all the applicable requirements.





## CHAPTER 5.2

### MARKING AND LABELLING

#### 5.2.1 Marking

5.2.1.1 Unless provided otherwise in these Regulations, the proper shipping name for the dangerous goods as determined in accordance with 3.1.2 and the corresponding UN Number preceded by the letters "UN", shall be displayed on each package. In the case of unpackaged articles the marking shall be displayed on the article, on its cradle or on its handling, storage or launching device. For goods of Division 1.4, Compatibility Group S, the division and compatibility group letter shall also be marked unless the label for 1.4S is displayed. A typical package marking is:

Corrosive liquid, acidic, organic, n.o.s. (Caprylyl chloride) UN 3265.

5.2.1.2 All package markings required by 5.2.1.1:

- (a) Shall be readily visible and legible;
- (b) Shall be able to withstand open weather exposure without a substantial reduction in effectiveness;
- (c) Shall be displayed on a background of contrasting colour on the external surface of the package; and
- (d) Shall not be located with other package markings that could substantially reduce their effectiveness.

5.2.1.3 Salvage packagings shall additionally be marked with the word "SALVAGE".

5.2.1.4 Intermediate bulk containers of more than 450 litres capacity shall be marked on two opposing sides.

#### 5.2.1.5 *Special marking provisions for Class 7*

5.2.1.5.1 Each package shall be legibly and durably marked on the outside of the packaging with an identification of either the consignor or consignee, or both.

5.2.1.5.2 For each package, other than excepted packages, the United Nations number preceded by the letters AUN<sup>®</sup> and the proper shipping name shall be legibly and durably marked on the outside of the packaging. In the case of excepted packages only the United Nations number, preceded by the letters "UN", is required.

5.2.1.5.3 Each package of gross mass exceeding 50 kg shall have its permissible gross mass legibly and durably marked on the outside of the packaging.

5.2.1.5.4 Each package which conforms to:

- (a) an Industrial package Type 1, an Industrial package Type 2 or an Industrial package Type 3 design shall be legibly and durably marked on the outside of the packaging with "TYPE IP-1", "TYPE IP-2" or "TYPE IP-3" as appropriate;

- (b) a Type A package design shall be legibly and durably marked on the outside of the packaging with "TYPE A";
- (c) an Industrial package Type 2, an Industrial package Type 3 or a Type A package design shall be legibly and durably marked on the outside of the packaging with the international vehicle registration code (VRI Code) of the country of origin of design and the name of the manufacturers, or other identification of the packaging specified by the competent authority.

5.2.1.5.5 Each package which conforms to a design approved by the competent authority shall be legibly and durably marked on the outside of the packaging with:

- (a) the identification mark allocated to that design by the competent authority;
- (b) a serial number to uniquely identify each packaging which conforms to that design;
- (c) in the case of a Type B(U) or Type B(M) package design, with "TYPE B(U)" or "TYPE B(M)"; and
- (d) in the case of a Type C package design, with "TYPE C".

5.2.1.5.6 Each package which conforms to a Type B(U), Type B(M) or Type C package design shall have the outside of the outermost receptacle which is resistant to the effects of fire and water plainly marked by embossing, stamping or other means resistant to the effects of fire and water with the trefoil symbol shown in the figure below:

**Figure 5.2.1**

Basic trefoil symbol with proportions based on a central circle of radius  $X$ .  
The minimum allowable size of  $X$  shall be 4 mm.

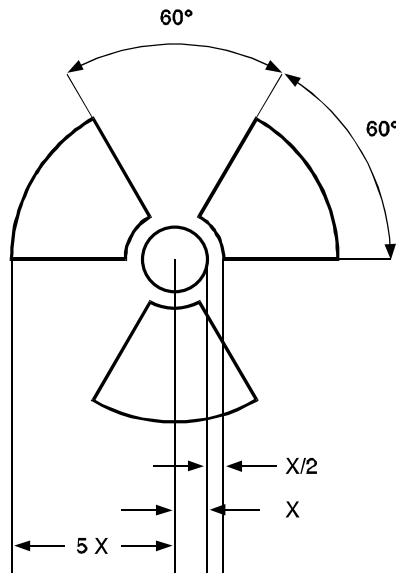

5.2.1.5.7 Where LSA-I or SCO-I material is contained in receptacles or wrapping materials and is transported under exclusive use as permitted by 4.1.9.2.3, the outer surface of these receptacles or wrapping materials may bear the marking 'RADIOACTIVE LSA-I' or 'RADIOACTIVE SCO-I', as appropriate.

## 5.2.2 Labelling

### 5.2.2.1 Labelling provisions

**NOTE:** These provisions relate essentially to danger labels. However, additional markings or symbols indicating precautions to be taken in handling or storing a package (e.g. a symbol representing an umbrella indicating that a package shall be kept dry) may be displayed on a package if appropriate.

5.2.2.1.1 Labels identifying primary and subsidiary risks shall conform to models Nos. 1 to 9 illustrated in 5.2.2.2.2. The "EXPLOSIVE" subsidiary risk label is model No. 1.

5.2.2.1.2 Where articles or substances are specifically listed in the Dangerous Goods List, a danger class label shall be affixed for the hazard shown in Column 3 of the List and a subsidiary risk label shall be affixed for any risk indicated by a class or division number in the Column 4 of the List, unless qualified by a special provision. In certain cases the need for using a subsidiary risk label may also be indicated by a special provision indicated in Column 6 of the List.

5.2.2.1.3 Except as provided in 5.2.2.1.3.1, if a substance which meets the definition of more than one class is not specifically listed by name in the Dangerous Goods List in Chapter 3.2, the provisions in Chapter 2.0 shall be used to determine the primary risk class of the goods. In addition to the label required for that primary risk class, subsidiary risk labels shall also be applied as specified in the Dangerous Goods List.

5.2.2.1.3.1 Packages containing substances of Class 8 need not bear subsidiary risk label model No. 6.1 if the toxicity arises solely from the destructive effect on tissue. Packages containing substances of Division 4.2 need not bear subsidiary risk label model No. 4.1.

#### 5.2.2.1.4 Labels for Class 2 gases with subsidiary risk(s)

Division	Subsidiary risk(s) shown in Chapter 2	Primary risk label	Subsidiary risk label(s)
2.1	None	2.1	None
2.2	None	2.2	None
	5.1	2.2	5.1
	None	2.3	None
2.3	2.1	2.3	2.1
	5.1	2.3	5.1
	5.1, 8	2.3	5.1, 8
	8	2.3	8
	2.1, 8	2.3	2.1, 8

5.2.2.1.5 Three separate labels have been provided for Class 2, one for flammable gases of Division 2.1 (red), one for non-flammable, non-toxic gases of Division 2.2 (green) and one for toxic gases of Division 2.3 (white). Where the Dangerous Goods List indicates that a Class 2 gas possesses single or multiple subsidiary risks, labels shall be used in accordance with the table in 5.2.2.1.4.

5.2.2.1.6 Each label shall:

- (a) Be located on the same surface of the package near the proper shipping name marking, if the package dimensions are adequate;
- (b) Be so placed on the packaging that they are not covered or obscured by any part or attachment to the packaging or any other label or marking; and
- (c) When primary and subsidiary risk labels are required, be displayed next to each other.

Where a package is of such an irregular shape or small size that a label cannot be satisfactorily affixed, the label may be attached to the package by a securely affixed tag or other suitable means.

5.2.2.1.7 Intermediate bulk containers of more than 450 litres capacity shall be labelled on two opposing sides.

5.2.2.1.8 Labels shall be affixed on a surface of contrasting colour.

5.2.2.1.9 *Special provisions for the labelling of self-reactive substances*

An "EXPLOSIVE" subsidiary risk label (Model No. 1) shall be applied for type B self-reactive substances, unless the competent authority has permitted this label to be dispensed with for a specific packaging because test data have proved that the self-reactive substance in such a packaging does not exhibit explosive behaviour.

5.2.2.1.10 *Special provisions for the labelling of organic peroxides*

The Division 5.2 label (model No. 5.2) shall be affixed to packages containing organic peroxides classified as types B, C, D, E or F. This label also implies that the product may be flammable and hence no "FLAMMABLE LIQUID", subsidiary risk label (model No. 3) is required. In addition, the following subsidiary risk labels shall be applied:

- (a) An "EXPLOSIVE" subsidiary risk label (model No. 1) for organic peroxides type B, unless the competent authority has permitted this label to be dispensed with for a specific packaging because test data have proved that the organic peroxide in such a packaging does not exhibit explosive behaviour;
- (b) A "CORROSIVE" subsidiary risk label (model No. 8) is required when Packing Group I or II criteria of Class 8 are met.

5.2.2.1.11 *Special provisions for the labelling of infectious substances packages*

In addition to the primary risk label (model No. 6.2), infectious substances packages shall bear any other label required by the nature of the contents.

5.2.2.1.12 *Special provisions for the labelling of radioactive material*

5.2.2.1.12.1 Except as provided for large freight containers and tanks in accordance with 5.3.1.1.5.1, each package, overpack and freight container containing radioactive material shall bear at least two labels which conform to the models Nos. 7A, 7B, and 7C as appropriate according to the category (see 2.7.8.4) of that package, overpack or freight container. Labels shall be affixed to two opposite sides on the outside of the package or on the outside of all four sides of the freight container. Each overpack containing radioactive material shall bear at least two labels on opposite sides of the outside of the overpack. In addition, each package, overpack and freight container containing fissile material, other than fissile material excepted under 6.4.11.2 shall bear labels which conform to model No. 7E; such labels, where applicable shall be affixed

adjacent to the labels for radioactive material. Labels shall not cover the markings specified in 5.2. Any labels which do not relate to the contents shall be removed or covered.

5.2.2.1.12.2 Each label conforming to models numbers 7A, 7B, and 7C shall be completed with the following information:

- (a) Contents:
  - (i) except for LSA-I material, the name(s) of the radionuclide(s) as taken from Table 2.7.7.2.1, using the symbols prescribed therein. For mixtures of radionuclides, the most restrictive nuclides shall be listed to the extent the space on the line permits. The group of LSA or SCO shall be shown following the name(s) of the radionuclide(s). The terms "LSA-II", "LSA-III", "SCO-I" and "SCO-II" shall be used for this purpose.
  - (ii) for LSA-I material, the term "LSA-I" is all that is necessary; the name of the radionuclide is not necessary;
- (b) Activity: The maximum activity of the radioactive contents during transport expressed in units of becquerels (Bq) with the appropriate SI prefix (see 1.2.2.1). For fissile material, the mass of fissile material in units of grams (g), or multiples thereof, may be used in place of activity;
- (c) For overpacks and freight containers the "contents" and "activity" entries on the label shall bear the information required in 5.2.2.1.12.2(a) and 5.2.2.1.12.2(b), respectively, totalled together for the entire contents of the overpack or freight container except that on labels for overpacks or freight containers containing mixed loads of packages containing different radionuclides, such entries may read "See Transport Documents";
- (d) Transport index: See 2.7.6.1.1 and 2.7.6.1.2. (No transport index entry is required for category I-WHITE.).

5.2.2.1.12.3 Each label conforming to the model No. 7E shall be completed with the criticality safety index (CSI) as stated in the certificate of approval for special arrangement or the certificate of approval for the package design issued by the competent authority.

5.2.2.1.12.4 For overpacks and freight containers, the criticality safety index (CSI) on the label shall bear the information required in 5.2.2.1.12.3 totalled together for the fissile contents of the overpack or freight container.

## **5.2.2.2 Provisions for labels**

5.2.2.2.1 Labels shall satisfy the provisions of this section and conform, in terms of colour, symbols and general format, to the specimen labels shown in 5.2.2.2.2.

5.2.2.2.1.1 Labels shall be in the form of a square set at an angle of 45° (diamond-shaped) with minimum dimensions of 100 mm by 100 mm, except in the case of packages of such dimensions that they can only bear smaller labels and as provided in 5.2.2.2.1.2. They have a line of the same colour as the symbol, 5 mm inside the edge and running parallel with it.

5.2.2.2.1.2 Cylinders for Class 2 may, on account of their shape, orientation and securing mechanisms for transport, bear labels representative of those specified in this section, which have been reduced in size, according to ISO 7225:1994, for display on the non-cylindrical part (shoulder) of such cylinders.

5.2.2.2.1.3 Labels are divided into halves. With the exception of Divisions 1.4, 1.5 and 1.6, the upper half of the label is reserved for the pictorial symbol and the lower half for texts and the class or division number and the compatibility group letter as appropriate.

5.2.2.2.1.4 Except for Divisions 1.4, 1.5 and 1.6, labels for Class 1 show in the lower half the division number and compatibility group letter for the substance or article. Labels for Divisions 1.4, 1.5 and 1.6 show in the upper half the division number and in the lower half the compatibility group letter. For Division 1.4, Compatibility Group S, no label is generally required. However, in cases where a label is considered necessary for such goods, it shall be based on model No. 1.4.

5.2.2.2.1.5 On labels other than those for material of Class 7, the insertion of any text (other than the class or division number) in the space below the symbol shall be confined to particulars indicating the nature of the risk and precautions to be taken in handling.

5.2.2.2.1.6 The symbols, text and numbers shall be shown in black on all labels except for:

- (a) the Class 8 label, where the text (if any) and class number shall appear in white;
- (b) labels with entirely green, red or blue backgrounds where they may be shown in white;  
and
- (c) the Division 2.1 label displayed on cylinders and gas cartridges for liquefied petroleum gases, where they may be shown in the background colour of the receptacle if adequate contrast is provided.

5.2.2.2.1.7 All labels shall be able to withstand open weather exposure without a substantial reduction in effectiveness.

5.2.2.2.2 Specimen labels

**CLASS 1**

**Explosive substances or articles**



(No.1)

Divisions 1.1, 1.2 and 1.3

Symbol (exploding bomb): black; Background: orange; Figure '1' in bottom corner



(No.1.4)

Division 1.4

Background: orange; Figures: black; Numerals shall be about 30 mm in height and be about 5 mm thick (for a label measuring 100 mm x 100 mm); Figure '1' in bottom corner



(No.1.5)

Division 1.5



(No.1.6)

Division 1.6

\*\* Place for division - to be left blank if explosive is the subsidiary risk

\* Place for compatibility group to be left blank if explosive is the subsidiary risk

**CLASS 2**

**Gases**



(No.2.1)

Division 2.1

Flammable gases

Symbol (flame): black or white; (except as provided for in 5.2.2.2.1.6 c))  
Background: red; Figure '2' in bottom corner

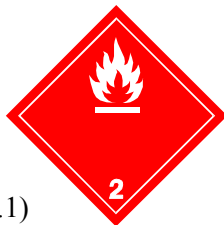

(No.2.2)

Division 2.2

Non flammable, non-toxic gases  
Symbol (gas cylinder): black or white;  
Background: green; Figure '2' in bottom corner

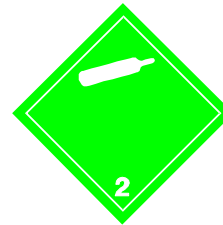

**CLASS 3**

**Flammable liquids**



(No.2.3)

Division 2.3

Toxic gases

Symbol (skull and crossbones): black;  
Background: white; Figure '2' in bottom corner



(No.3)

Symbol (flame): black or white;  
Background: red; Figure '3' in bottom corner



**CLASS 4**



(No.4.1)  
Division 4.1  
Flammable solids  
Symbol (flame): black;  
Background: white with  
seven vertical red stripes;  
Figure '4' in bottom corner



(No.4.2)  
Division 4.2  
Substances liable to  
spontaneous combustion  
Symbol (flame): black;  
Background: upper half white,  
lower half red;  
Figure '4' in bottom corner



(No.4.3)  
Division 4.3  
Substances which in contact  
with water emit flammable gases  
Symbol (flame): black or white;  
Background: blue;  
Figure '4' in bottom corner



**CLASS 5**



(No. 5.1)  
Division 5.1  
Oxidizing substances  
Symbol (flame over circle): black; Background: yellow;  
Figures '5.1' in bottom corner



(No. 5.2)  
Division 5.2  
Organic peroxides  
Background: yellow;  
Figures '5.2' in bottom corner

**CLASS 6**



(No. 6.1)  
Division 6.1  
Toxic substances  
Symbol (skull and crossbones): black;  
Background: white; Figure '6' in bottom corner



(No.6.2)  
Division 6.2  
Infectious substances  
The lower half of the label may bear the inscriptions: 'INFECTIOUS SUBSTANCE'  
and 'In the case of damage or leakage immediately notify Public Health Authority';  
Symbol (three crescents superimposed on a circle) and inscriptions: black;  
Background: white; Figure '6' in bottom corner



**CLASS 7**  
**Radioactive material**



(No. 7A)  
 Category I - White  
 Symbol (trefoil): black;  
 Background: white;  
 Text (mandatory): black in lower half of label:  
 'RADIOACTIVE'  
 'Contents .....'  
 'Activity .....'  
 One red bar shall follow the word 'Radioactive';  
 Figure '7' in bottom corner.



(No. 7B)  
 Category II - Yellow  
 Symbol (trefoil): black;  
 Background: upper half yellow with white border, lower half white;  
 Text (mandatory): black in lower half of label:  
 'RADIOACTIVE'  
 'Contents .....'  
 'Activity .....'  
 In a black outlined box: 'Transport Index';  
 Two red vertical bars shall follow the word 'Radioactive';  
 Figure '7' in bottom corner.



(No. 7C)  
 Category III - Yellow  
 Symbol (trefoil): black;  
 Background: upper half yellow with white border, lower half white;  
 Text (mandatory): black in lower half of label:  
 'RADIOACTIVE'  
 'Contents .....'  
 'Activity .....'  
 In a black outlined box: 'Transport Index';  
 Three red vertical bars shall follow the word 'Radioactive';  
 Figure '7' in bottom corner.

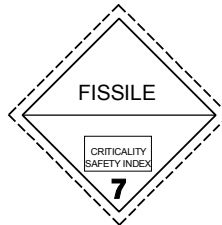

(No. 7E)  
 Class 7 fissile material  
 Background: white;  
 Text (mandatory): black in upper half of label: 'FISSILE';  
 In a black outlined box in the lower half of the label:  
 'CRITICALITY SAFETY INDEX'  
 Figure '7' in bottom corner.

**CLASS 8**  
**Corrosive substances**



(No. 8)  
 Symbol (liquids, spilling from two glass vessels and attacking a hand and a metal): black;  
 Background: upper half white;  
 lower half black with white border;  
 Figure '8' in bottom corner

**CLASS 9**  
**Miscellaneous dangerous substances and articles**

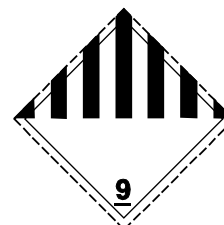

(No. 9)  
 Symbol (seven vertical stripes in upper half): black;  
 Background: white;  
 Figure '9' underlined in bottom corner



## CHAPTER 5.3

### PLACARDING AND MARKING OF TRANSPORT UNITS

#### 5.3.1 Placarding

##### 5.3.1.1 *Placarding provisions*

###### 5.3.1.1.1 *Definition*

For the purposes of this Chapter:

*Transport units* comprise road transport tank and freight vehicles, railway transport tank and freight wagons, and multimodal freight containers and portable tanks.

5.3.1.1.2 Placards shall be affixed to the exterior surface of transport units to provide a warning that the contents of the unit are dangerous goods and present risks. Placards shall correspond to the primary risk of the goods contained in the transport unit except that:

- (a) Placards are not required on transport units carrying any quantity of explosives of Division 1.4, Compatibility Group S, dangerous goods packed in limited quantities, or excepted packages of radioactive material (Class 7); and
- (b) Placards indicating the highest risk only need be affixed on transport units carrying substances and articles of more than one division in Class 1.

5.3.1.1.3 Placards shall be displayed for those subsidiary risks of substances or articles specified in Column 4 of the Dangerous Goods List. However, transport units containing goods of more than one class need not bear a subsidiary risk placard if the hazard represented by that placard is already indicated by a primary risk placard.

5.3.1.1.4 Transport units carrying dangerous goods or the residue of dangerous goods in unpurged tanks shall display placards clearly visible on at least two opposing sides of the units and in any case in such a position as may be seen by all those involved in the loading or unloading process. Where the transport unit has a multiple compartment tank which is carrying two or more dangerous goods and/or the residues of dangerous goods, appropriate placards shall be displayed along each side at the position of the relevant compartments.

###### 5.3.1.1.5 *Special provisions for Class 7*

5.3.1.1.5.1 Large freight containers carrying packages other than excepted packages, and tanks shall bear four placards which conform with the model 7D given in Figure 5.3.1. The placards shall be affixed in a vertical orientation to each side wall and each end wall of the large freight container or tank. Any placards which do not relate to the contents shall be removed. Instead of using both labels and placards, it is permitted as an alternative to use enlarged labels only, as shown in label model Nos. 7A, B and C, and where appropriate 7 E, with dimensions as required for the placard in Figure 5.3.1.

5.3.1.1.5.2 Rail and road vehicles carrying packages, overpacks or freight containers labelled with any of the labels shown in 5.2.2.2.1 as models No. 7A, 7B, 7C or 7E, or carrying consignments under exclusive use, shall display the placard shown in Figure 5.3.1 (Model 7D) on each of:

- (a) the two external lateral walls in the case of a rail vehicle;
- (b) the two external lateral walls and the external rear wall in the case of a road vehicle.

In the case of a vehicle without sides the placards may be affixed directly on the cargo-carrying unit provided that they are readily visible; in the case of physically large tanks or freight containers, the placards on the tanks or freight containers shall suffice. In the case of vehicles which have insufficient area to allow the fixing of larger placards, the dimensions of the placard as described in Figure 5.3.1 may be reduced to 100 mm. Any placards which do not relate to the contents shall be removed.

### 5.3.1.2 *Specifications for placards*

5.3.1.2.1 Except as provided in 5.3.1.2.2 for the Class 7 placard, a placard shall:

- (a) Be not less than 250 mm by 250 mm, with a line of the same colour as the symbol running 12.5 mm inside the edge and parallel with it;
- (b) Correspond to the label for the class of the dangerous goods in question with respect to colour and symbol; and
- (c) Display the number of the class or division (and for goods in Class 1, the compatibility group letter) of the dangerous goods in question in the manner prescribed in 5.2.2.2 for the corresponding label, in digits not less than 25 mm high.

5.3.1.2.2 For Class 7, the placard shall have minimum overall dimensions of 250 mm by 250 mm (except as permitted by 5.3.1.1.5.2) with a black line running 5 mm inside the edge and parallel with it, and shall be otherwise as shown in Figure 5.3.1 below. When different dimensions are used, the relative proportions shall be maintained. The number "7" shall not be less than 25 mm high. The background colour of the upper half of the placard shall be yellow and of the lower half white, the colour of the trefoil and the printing shall be black. The use of the word RADIOACTIVE® in the bottom half is optional to allow the use of this placard to display the appropriate United Nations number for the consignment.

**Figure 5.3.1**  
Placard for radioactive material of Class 7

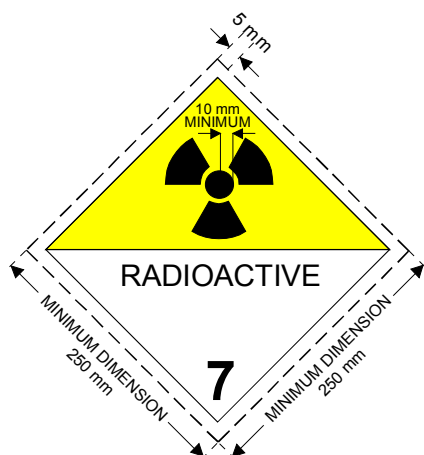

**(No. 7D)**

Symbol (trefoil): black; Background: upper half yellow with white border, lower half white; The lower half shall show the word RADIOACTIVE or alternatively, when required (see 5.3.2.1), the appropriate UN number; and the figure "7" in the bottom corner

## 5.3.2 Marking

### 5.3.2.1 *Display of UN numbers*

5.3.2.1.1 Except for goods of Class 1, the UN number shall be displayed as required by this section on consignments of:

- (a) Solids, liquids or gases transported in tank transport units including on each component of a multicompartment tank transport unit;
- (b) Packaged dangerous goods of a single commodity which constitute a full load for the transport unit;
- (c) Unpackaged LSA-1 or SCO-1 material of Class 7 in or on a vehicle, or in a freight container, or in a tank; and
- (d) Packaged radioactive material with a single UN number under exclusive use in or on a vehicle, or in a freight container.

5.3.2.1.2 The UN number for the goods shall be displayed in black digits not less than 65 mm high, either:

- (a) Against a white background in the lower half of each placard (see Figures 5.3.1 and 5.3.2); or
- (b) On an orange rectangular panel not less than 120 mm high and 300 mm wide, with a 10 mm black border, to be placed immediately adjacent to each placard (see Figure 5.3.3).

5.3.2.1.3 *Examples of display of UN numbers*

**Figure 5.3.2**

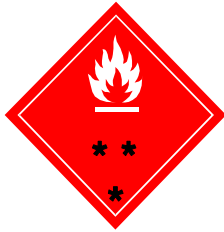

**Figure 5.3.3**



\* location of class or division number  
\*\* location of UN number

**5.3.2.2 *Elevated temperature substances***

Transport units containing a substance that is transported or offered for transport in a liquid state at a temperature equal to or exceeding 100 °C, in a solid state at a temperature equal to or exceeding 240 °C shall bear on each side and on each end the mark shown in Figure 5.3.4. The triangular shaped mark shall have sides of at least 250 mm and shall be shown in red.

**Figure 5.3.4**  
**Mark for carriage at elevated temperature**



## CHAPTER 5.4

### DOCUMENTATION

#### **Introductory note**

*NOTE: These Regulations do not preclude the use of electronic data processing (EDP) and electronic data interchange (EDI) transmission techniques as an aid to paper documentation.*

#### **5.4.1 Dangerous goods transport documentation**

##### **5.4.1.1 General**

Except as otherwise provided, the consignor who offers dangerous goods for transport shall describe the dangerous goods on a transport document and provide additional information and documentation as specified in these Regulations.

##### **5.4.1.2 Form of the transport document**

5.4.1.2.1 A dangerous goods transport document may be in any form, provided it contains all of the information required by these Regulations.

5.4.1.2.2 If both dangerous and non-dangerous goods are listed in one document, the dangerous goods shall be listed first, or otherwise be emphasised.

##### **5.4.1.2.3 Continuation page**

A dangerous goods transport document may consist of more than one page, provided pages are consecutively numbered.

5.4.1.2.4 The information on a dangerous goods transport document shall be easy to identify, legible and durable.

##### **5.4.1.2.5 Example of a dangerous goods transport document**

The form shown in Figure 5.4.1 at the end of this Chapter is an example of a dangerous goods transport document<sup>1</sup>.

---

<sup>1</sup> For standardized formats, see also the relevant recommendations of the UN/ECE Working Party on Facilitation of International Trade Procedures, in particular Recommendation No. 1 (United Nations Lay-out Key for Trade Documents) (ECE/TRADE/137, edition 96.1), Recommendation No. 11 (Documentary Aspects of the International Transport of Dangerous Goods) (ECE/TRADE/204, edition 96.1) and Recommendation No. 22 (Lay-out Key for standard Consignment Instructions) (ECE/TRADE/168, edition 96.1). Refer to the Trade Data Elements Directory, Volume III, Trade Facilitation Recommendations (ECE/TRADE/200)(United Nations publication sales No. E.96.II.E.13).

### 5.4.1.3 *Consignor, consignee and date*

The name and address of the consignor and the consignee of the dangerous goods shall be included on the dangerous goods transport document. The date the dangerous goods transport document or an electronic copy of it was prepared or given to the initial carrier shall be included.

### 5.4.1.4 *Information required on the dangerous goods transport document*

#### 5.4.1.4.1 *Dangerous goods description*

The dangerous goods transport document shall contain the following information for each dangerous substance, material or article offered for transport:

- (a) The UN number preceded by the letters "UN";
- (b) The proper shipping name, as determined according to 3.1.2;
- (c) The class or, when assigned, the Division of the goods, including for Class 1, the compatibility group letter. Any assigned subsidiary hazard class or division number(s) shall be entered following the numerical hazard class or Division and shall be enclosed in parenthesis. The words "Class" or "Division" may be included preceding the primary or subsidiary hazard class or Division numbers;
- (d) Where assigned, the packing group for the substance or article which may be preceded by "PG" (e.g. "PG II").

#### 5.4.1.4.2 *Sequence of the dangerous goods description*

The dangerous goods description specified in 5.4.1.4.1 shall be shown either in sequence (a), (b), (c), (d), or in sequence (b), (c), (a), (d), with no information interspersed, except as provided in these Regulations. Examples of such permitted dangerous goods descriptions are:

**"UN 1098 ALLYL ALCOHOL 6.1 (3) I" or  
"ALLYL ALCOHOL, 6.1 (3), UN 1098, I"**

**NOTE:** *In addition to the requirements of these Regulations, other elements of information may be required by the competent authority or for certain modes of transport (e.g. flash point for sea transport). Unless permitted or required by these Regulations, additional information shall be placed after the dangerous goods description.*

#### 5.4.1.4.3 *Information which supplements the proper shipping name in the dangerous goods description*

The proper shipping name in the dangerous goods description shall be supplemented as follows:

- (a) *Technical names for "n.o.s." and other generic descriptions:* Proper shipping names that are assigned special provision 274 in Column 6 of the Dangerous Goods List shall be supplemented with their technical or chemical group names as described in 3.1.2.8;
- (b) *Empty uncleaned packagings and tanks:* Empty means of containment (including packagings, IBCs, portable tanks, tank-vehicles and tank-wagons) which contain the residue of dangerous goods of classes other than Class 7 shall be described as such by, for example, placing the words **"EMPTY UNCLEARED"** or **"RESIDUE LAST CONTAINED"** before or after the proper shipping name;



- (c) *Wastes*: For waste dangerous goods (other than radioactive wastes) which are being transported for disposal, or for processing for disposal, the proper shipping name shall be preceded by the word "**WASTE**", unless this is already a part of the proper shipping name;
- (d) *Elevated temperature substances*: If the proper shipping name of a substance which is transported or offered for transport in a liquid state at a temperature equal to or exceeding 100 °C, or in a solid state at a temperature equal to or exceeding 240 °C, does not convey the elevated temperature condition (for example, by using the term "**MOLTEN**" or "**ELEVATED TEMPERATURE**" as part of the shipping name), the word "**HOT**" shall immediately precede the proper shipping name.

#### **5.4.1.5 Information required in addition to the dangerous goods description**

In addition to the dangerous goods description the following information shall be included after the dangerous goods description on the dangerous goods transport document.

##### *5.4.1.5.1 Total quantity of dangerous goods*

Except for empty uncleaned packagings, the total quantity of dangerous goods covered by the description (by volume or mass as appropriate) of each item of dangerous goods bearing a different proper shipping name, UN number or packing group shall be included. For Class 1 dangerous goods, the quantity shall be the net explosive mass. For dangerous goods transported in salvage packagings, an estimate of the quantity of dangerous goods shall be given. The number and kind (e.g. drum, box, etc.) of packagings shall also be indicated. Abbreviations may be used to specify the unit of measurement for the total quantity.

##### *5.4.1.5.2 Limited quantities*

When dangerous goods are transported according to the exceptions for dangerous goods packed in limited quantities provided for in Column 7 of the Dangerous Goods List and Chapter 3.4, the words "**limited quantity**" or "**LTD QTY**" shall be included.

##### *5.4.1.5.3 Salvage packagings*

For dangerous goods transported in salvage packagings, the words "**SALVAGE PACKAGE**" shall be included.

##### *5.4.1.5.4 Substances stabilized by temperature control*

If the word "STABILIZED" is part of the proper shipping name (see also 3.1.2.6), when stabilization is by means of temperature control, the control and emergency temperatures (see 7.1.4.3.1) shall be indicated in the transport document, as follows:

**"Control temperature: .... °C Emergency temperature: .... °C".**

##### *5.4.1.5.5 Self-reactive substances and organic peroxides*

For self-reactive substances of Division 4.1 and for organic peroxides which require temperature control during transport, the control and emergency temperatures (see 7.1.4.3.1) shall be indicated on the dangerous goods transport document, as follows:

**"Control temperature: .... °C Emergency temperature: .... °C".**

5.4.1.5.5.1 When for certain self-reactive substances of Division 4.1 and organic peroxides of Division 5.2 the competent authority has permitted the "EXPLOSIVE" subsidiary risk label (model No. 1) to be dispensed with for the specific package, a statement to this effect shall be included.

5.4.1.5.5.2 When organic peroxides and self-reactive substances are transported under conditions where approval is required (for organic peroxides, see 2.5.3.2.5, 4.1.7.2.2, 4.2.1.13.1 and 4.2.1.13.3; for self-reactive substances, see 2.4.2.3.2.4 and 4.1.7.2.2), a statement to this effect shall be included in the dangerous goods transport document. A copy of the classification approval and conditions of transport for non-listed organic peroxides and self-reactive substances shall be attached to the dangerous goods transport document.

5.4.1.5.5.3 When a sample of an organic peroxide (see 2.5.3.2.5.1) or a self-reactive substance (see 2.4.2.3.2.4(b)) is transported, a statement to this effect shall be included in the dangerous goods transport document.

#### 5.4.1.5.6 *Infectious substances*

The full address of the consignee shall be shown on the document, together with the name of a responsible person and his telephone number.

#### 5.4.1.5.7 *Radioactive material*

5.4.1.5.7.1 The following information shall be included for each consignment of Class 7 material, as applicable, in the order given:

- (a) The name or symbol of each radionuclide or, for mixtures of radionuclides, an appropriate general description or a list of the most restrictive nuclides;
- (b) A description of the physical and chemical form of the material, or a notation that the material is special form radioactive material or low dispersible radioactive material. A generic chemical description is acceptable for chemical form;
- (c) The maximum activity of the radioactive contents during transport expressed in units of becquerels (Bq) with an appropriate SI prefix (see 1.2.2.1). For fissile material, the mass of fissile material in units of grams (g), or appropriate multiples thereof, may be used in place of activity;
- (d) The category of the package, i.e. I-WHITE, II-YELLOW, III-YELLOW;
- (e) The transport index (categories II-YELLOW and III-YELLOW only);
- (f) For consignments including fissile material other than consignments excepted under 6.4.11.2, the criticality safety index;
- (g) The identification mark for each competent authority approval certificate (special form radioactive material, low dispersible radioactive material, special arrangement, package design, or shipment) applicable to the consignment;
- (h) For consignments of packages in an overpack or freight container, a detailed statement of the contents of each package within the overpack or freight container and, where appropriate, of each overpack or freight container in the consignment. If packages are to be removed from the overpack or freight container at a point of intermediate unloading, appropriate transport documents shall be made available;
- (i) Where a consignment is required to be shipped under exclusive use, the statement "EXCLUSIVE USE SHIPMENT"; and

- (j) For LSA-II, LSA-III, SCO-I and SCO-II, the total activity of the consignment as a multiple of A<sub>2</sub>.

5.4.1.5.7.2 The transport document shall include a statement regarding actions, if any, that are required to be taken by the carrier. The statement shall be in the languages deemed necessary by the carrier or the authorities concerned, and shall include at least the following points:

- (a) Supplementary requirements for loading, stowage, transport, handling and unloading of the package, overpack or freight container including any special stowage provisions for the safe dissipation of heat (see 7.1.7.3.2), or a statement that no such requirements are necessary;
- (b) Restrictions on the mode of transport or conveyance and any necessary routing instructions;
- (c) Emergency arrangements appropriate to the consignment.

5.4.1.5.7.3 The applicable competent authority certificates need not necessarily accompany the consignment. The consignor shall make them available to the carrier(s) before loading and unloading.

#### **5.4.1.6 Certification**

5.4.1.6.1 The dangerous goods transport document shall include a certification or declaration that the consignment is acceptable for transport and that the goods are properly packaged, marked and labelled, and in proper condition for transport in accordance with the applicable regulations. The text for this certification is:

"I hereby declare that the contents of this consignment are fully and accurately described above by the proper shipping name, and are classified, packaged, marked and labelled/placarded, and are in all respects in proper condition for transport according to applicable international and national governmental regulations."

The certification shall be signed and dated by the consignor. Facsimile signatures are acceptable where applicable laws and regulations recognize the legal validity of facsimile signatures.

5.4.1.6.2 If the dangerous goods documentation is presented to the carrier by means of electronic data processing (EDP) or electronic data interchange (EDI) transmission techniques, the signature(s) may be replaced by the name(s) (in capitals) of the person authorized to sign.

#### **5.4.2 Container/vehicle packing certificate**

5.4.2.1 When dangerous goods are packed or loaded into any container<sup>2</sup> or vehicle which will be transported by sea, those responsible for packing of the container or vehicle shall provide a "container/vehicle packing certificate" specifying the container/vehicle identification number(s) and certifying that the operation has been carried out in accordance with the following conditions:

---

<sup>2</sup> *Container means an article of transport equipment that is of a permanent character and accordingly strong enough to be suitable for repeated use; specially designed to facilitate the transport of goods, by one or more modes of transport, without intermediate reloading; designed to be secured and/or readily handled, having fittings for these purposes, and approved in accordance with the International Convention for Safe Containers (CSC), 1972, as amended. The term "container" includes neither vehicle nor packaging. However, a container that is transported on a chassis is included.*

- (a) The container/vehicle was clean, dry and apparently fit to receive the goods;
- (b) Packages, which need to be segregated in accordance with applicable segregation requirements, have not been packed together onto or in the container/vehicle;
- (c) All packages have been externally inspected for damage, and only sound packages have been loaded;
- (d) All goods have been properly loaded and, where necessary, adequately braced with securing material to suit the mode(s) of transport for the intended journey;
- (e) Goods loaded in bulk have been evenly distributed within the container/vehicle;
- (f) For consignments including goods of Class 1 other than Division 1.4, the container/vehicle is structurally serviceable in accordance with 7.1.3.2.1;
- (g) The container/vehicle and packages are properly marked, labelled and placarded, as appropriate;
- (h) When solid carbon dioxide (CO<sub>2</sub>-dry ice) is used for cooling purposes, the container/vehicle is externally marked or labelled in a conspicuous place, such as, at the door end, with the words: "DANGEROUS CO<sub>2</sub> (DRY ICE) INSIDE. VENTILATE THOROUGHLY BEFORE ENTERING"; and
- (i) A dangerous goods transport document, as indicated in 5.4.1.1, has been received for each dangerous goods consignment loaded in the container/vehicle.

**NOTE:** *The container/vehicle packing certificate is not required for tanks.*

5.4.2.2 The information required in the dangerous goods transport document and the container/vehicle packing certificate may be incorporated into a single document, if not, these documents shall be attached one to the other. If the information is incorporated into a single document, the document shall include a signed declaration such as "It is declared that the packing of the goods into the container/vehicle has been carried out in accordance with the applicable provisions". This declaration shall be dated and the person signing this declaration shall be identified on the document.

### **5.4.3 Emergency response information**

For consignments for which a dangerous goods transport document is required by these Regulations, appropriate information shall be immediately available at all times for use in emergency response to accidents and incidents involving dangerous goods in transport. The information shall be available away from the packages containing the dangerous goods and immediately accessible in the event of an accident or incident. Methods of compliance include:

- (a) Appropriate entries in the transport document; or
- (b) Provision of a separate document such as a safety data sheet; or
- (c) Provision of a separate document, such as the International Civil Aviation Organization (ICAO) "Emergency Response Guidance for Aircraft Incidents Involving Dangerous Goods" or the International Maritime Organization (IMO) "Emergency Procedures for Ships Carrying Dangerous Goods" and "Medical First Aid Guide in Accidents Involving Dangerous Goods", for use in conjunction with the transport document.





*(Reserved)*





## CHAPTER 5.5

### SPECIAL PROVISIONS

#### 5.5.1 Special provisions applicable to the consignment of infectious substances

5.5.1.1 Unless an infectious substance cannot be consigned by any other means, live vertebrate or invertebrate animals shall not be used to consign such a substance. Infected animals shall be consigned in accordance with conditions specified by the competent authority.

5.5.1.2 The transport of infectious substances requires co-ordinated action by the consignor, the carrier and the consignee to ensure safety and arrival on time and in proper condition. To this end, the following measures shall be taken.

- (a) *Advance arrangements between consignor, carrier and consignee.* Dispatch of infectious substances shall not take place before advance arrangements have been made between consignor, carrier and consignee or before the consignee has confirmed with his competent authorities that the substances can legally be imported and that no delay will be incurred in the delivery of the consignment to its destination;
- (b) *Preparation of dispatch documents.* In order to secure transmission without hindrance it is necessary to prepare all dispatch documents, including the transport document (see Chapter 5.4), in strict accordance with rules governing the acceptance of the goods to be dispatched;
- (c) *Routing.* Whatever the mode used, transport shall be by the quickest possible routing. If transshipment is necessary, precautions shall be taken to ensure special care, expeditious handling and monitoring of the substances in transit;
- (d) *Timely notification of all transport data by consignor to consignee.* The consignor shall notify the consignee in advance of transport details, such as: means of transport, flight or train number(s), transport document number and date and hour of expected arrival at the point of destination, so that the consignment can be collected promptly. The most rapid means of communication shall be used for this notification.

#### 5.5.2 Documentation and identification of fumigated units

5.5.2.1 Transport documents associated with the transport of units that have been fumigated shall show the date of fumigation and the type and amount of the fumigant used. In addition, instructions for disposal of any residual fumigant including fumigation devices (if used) shall be provided.

5.5.2.2 A warning sign as specified in 5.5.2.3 shall be placed on each fumigated unit in a location where it will be easily seen by persons attempting to enter the interior of the unit. When the fumigated unit has been ventilated to remove harmful concentrations of fumigant gas, the warning sign shall be removed.

5.5.2.3 The fumigation warning sign shall be rectangular and shall not be less than 300 mm wide and 250 mm high. The markings shall be black print on a white background with lettering not less than 25 mm high. An illustration of this sign is given in Figure 5.5.1.

**Figure 5.5.1: Fumigation warning sign**

