

Human Biomechanical Responses to Support the Design of a Pedestrian Leg Impactor

The design of a pedestrian leg impactor needs that parameters values are defined in the following areas:

- anthropometry and anthropomorphy,
- mechanical response of long bones in bending,
- human tolerance of long bones (injury risk curves) in bending,
- mechanical response of knee joint in bending and shearing,
- human tolerance to knee injuries in bending and shearing (injury risk curves).

Hereafter are discussed the present knowledge and their validity/limitations for inclusion in the specifications of a pedestrian leg impactor.

1. Anthropometry/anthropomorphy

This questions has already been discussed and an agreement has been reached. The values selected for the mechanical leg are solid enough and there is no reason to reconsider them.

The open issue is the question of the influence of the upper body mass.

In order to analyse the upper body mass, we need to separate the case where the initial impact is, at knee level or below, and the case where the initial impact is above the knee.

a) Impact at knee level or below

As indicated in Figure 1, full scale tests with cadavers show that, in this impact configuration, the knee is pushed inwards and, at the same time, the foot leaves the ground; the knee starts to deform and the femur rotates relative to the pelvis. As the hip joint allows a large motion (around 30 °) without producing injury and without resistance (free joint), the leg moves without the upper body until the upper leg is close to the horizontal. In that situation, the upper body is pulled by the leg through the hip joint; the injury to the knee, if there is one, occurs much earlier: at the time of the injury occurrence, the upper body has no influence on the leg kinematics.

b) Impact above the knee

If the initial impact point occurs above the knee, the thigh is directly in contact with the car front, and may be pushed by this contact, pulling on the pelvis; in that case, the contact force to the leg and the leg kinematics are affected by the upper body.

The influence of the upper body increases as the impact point moves upwards along the thigh. The principles of the motion in that impact condition are illustrated in Figure 2.

Figure 1: Impact below the knee

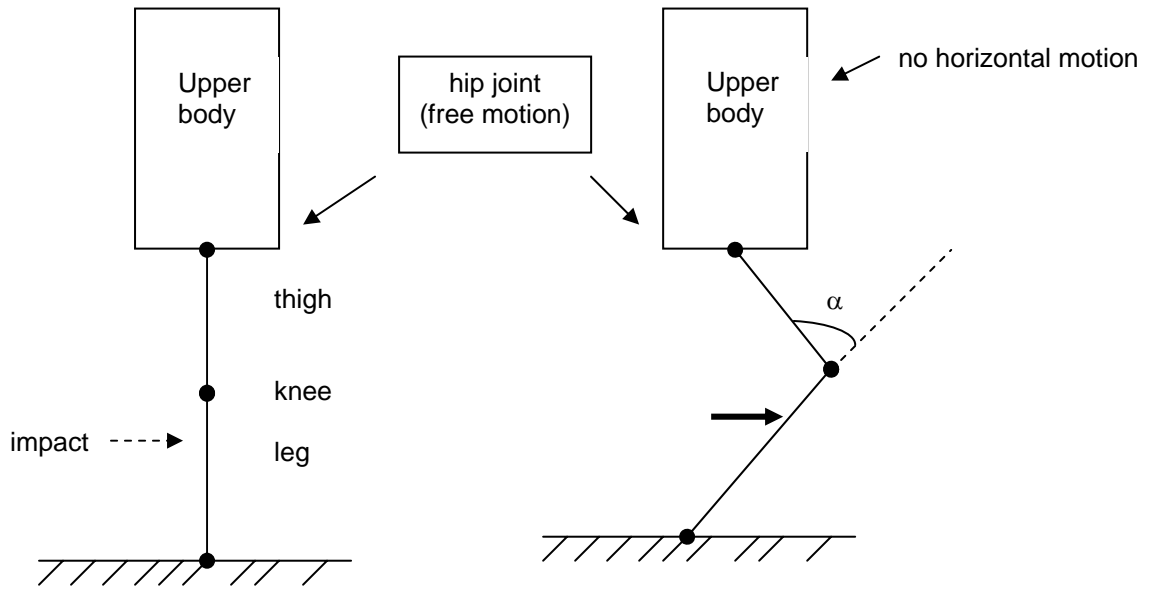
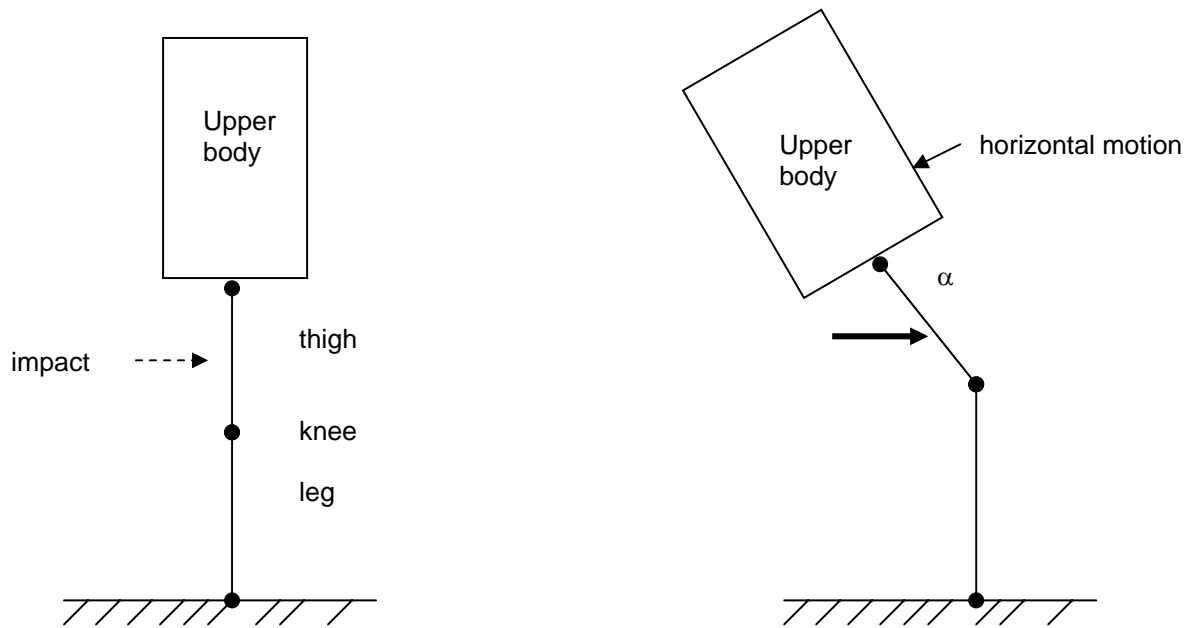

Figure 2: Impact above knee



2. Mechanical response of long bones in bending

There is a general agreement that the leg and the thigh have a certain level of compliance in

There is a general agreement that the leg and the thigh have a certain level of compliance in bending.

If the impactor is limited to test car fronts with initial impact at the knee level, or below, there is no reason to introduce a deformation capability in the upper leg.

Concerning the lower leg, the tests done at the University of Virginia are the most relevant to determine the leg stiffness. From these tests the mechanical response of the human leg in three points bending can be described as a two steps response : up to 10 mm deflexion the impact force stays almost equal to zero (this corresponds to initial flesh crush); then the force increases linearly with a end point at 40 mm and 3kN.

3. Human tolerance to leg fracture

The research indicated above performed by the University of Virginia could also be used as a reference for leg tolerance.

4. Mechanical response of the knee

The main results of knee loading in pedestrian like impacts are from kajzer and the University of Virginia. Beside these experimental studies, work done by Arnoux using validated numerical models of human leg.

These studies may give diverging results, first because the tests were not performed in the same boundaries conditions : as an example, Kajzer tests provide free axial and frontal rotations, whereas UVa tests control the axial rotation of the tibia relative to the femur.

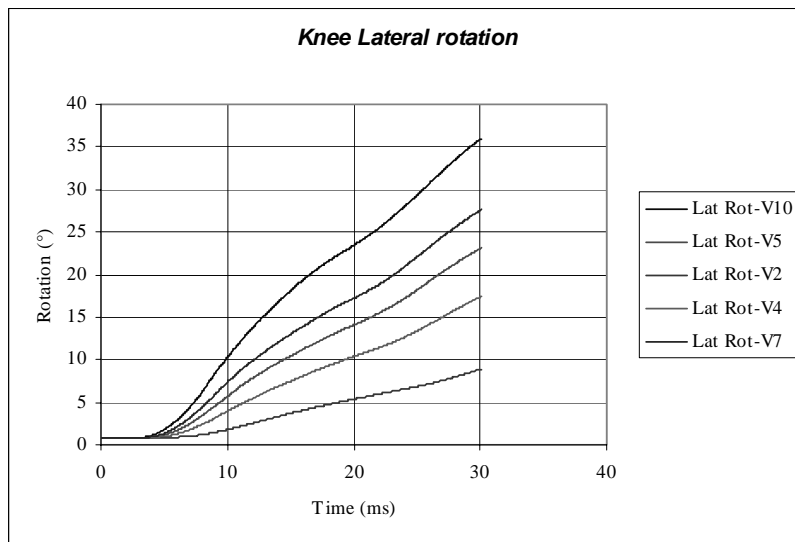
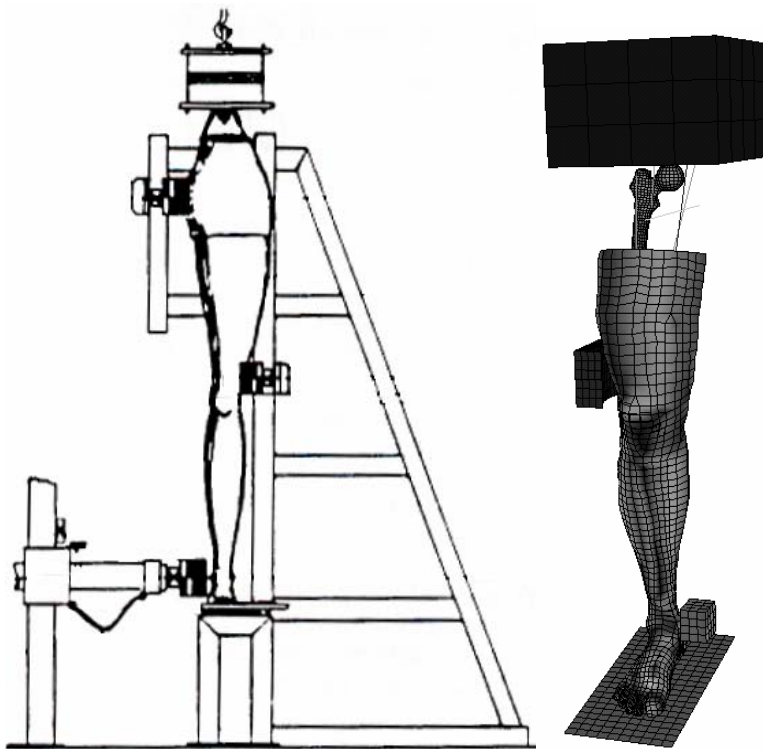

Figure 3 : Bending angle versus time in bending tests

The tests bending tests performed by Kajzer have been reanalysed in order to determine response corridors for the two impact speeds (15km/h and 20km/h).

These corridors are indicated on Figures 4 and 5

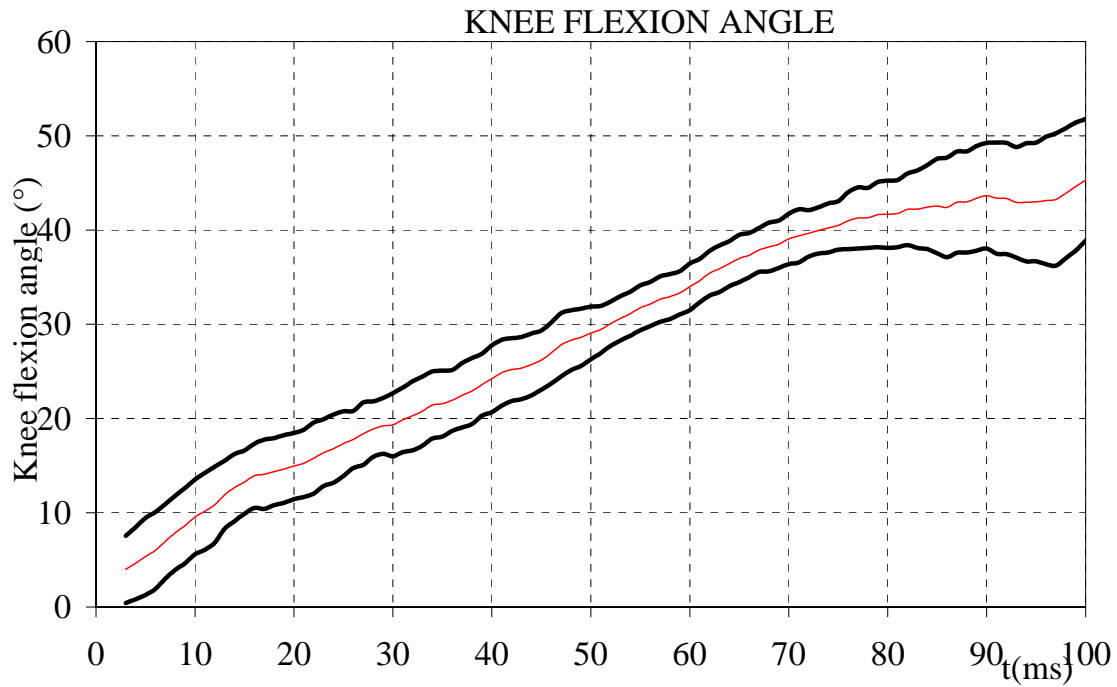

Figure 4 – Knee bending corridor for 15 km/h test

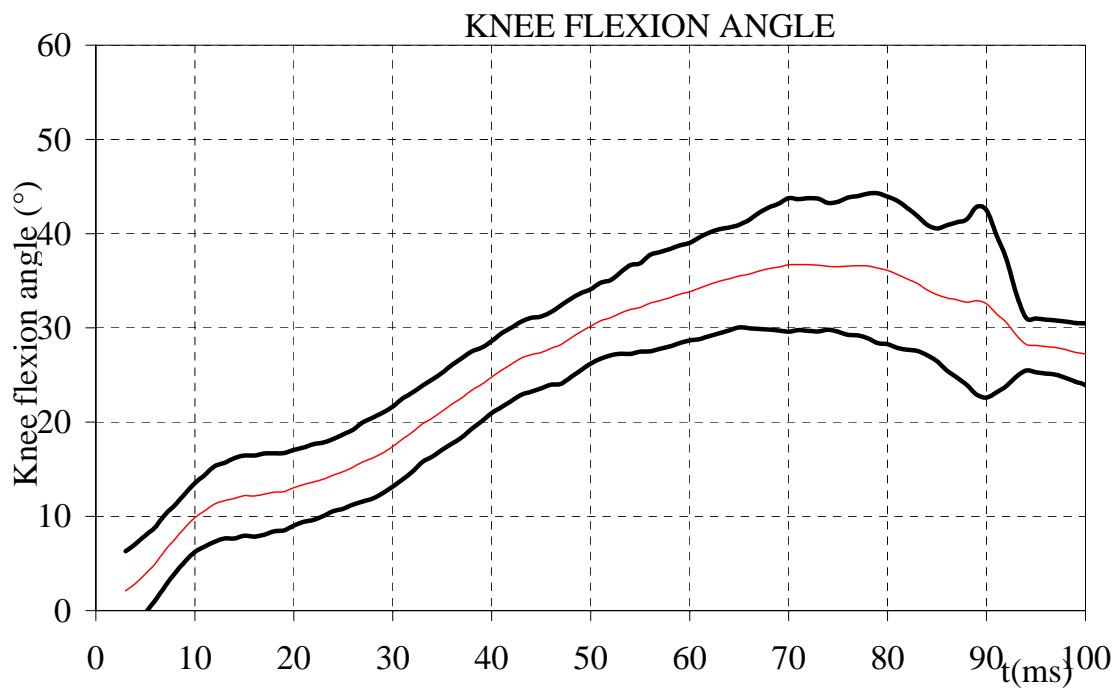

Figure 5 - Knee bending corridor for 20 km/h test

The reaction forces corridors (lower and upper transducers) have been also determined for the two impact speeds and are represented on figures 6 and 7 (15km/h impact speed), and on figures 8 and 9 (20 km/h impact speed)

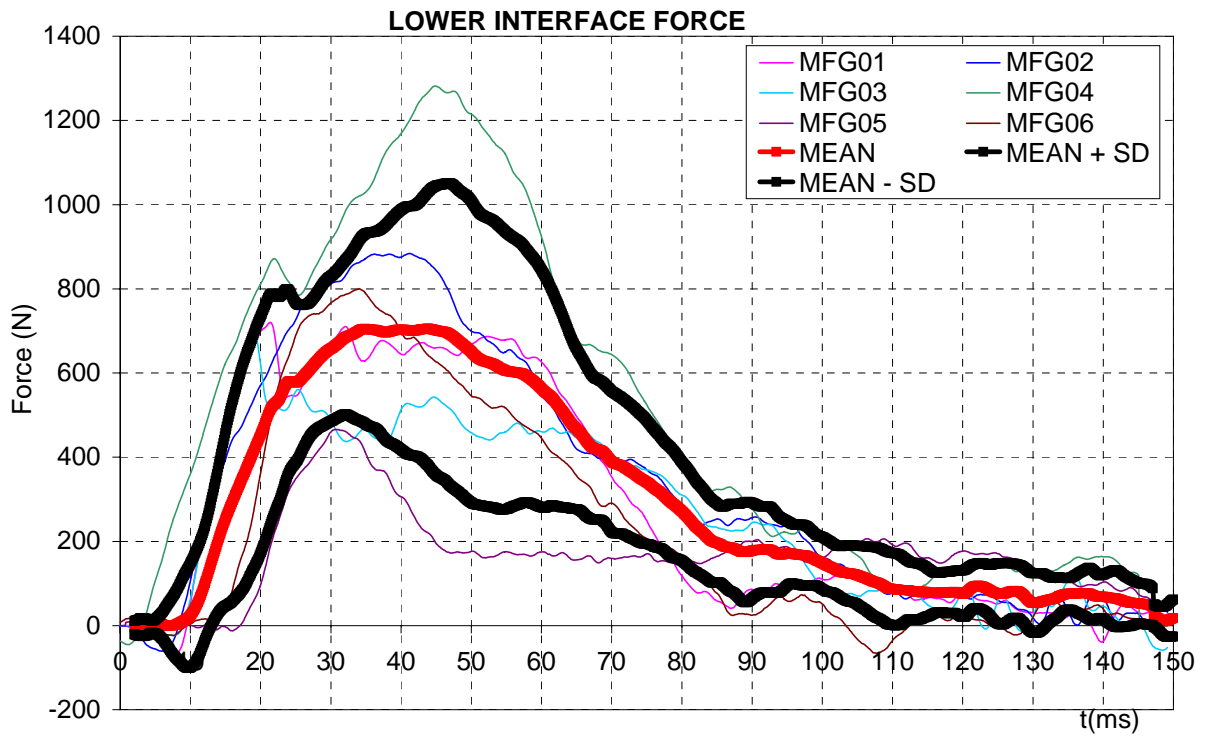

Figure 6 Lower reaction force corridor for 15 km/h tests

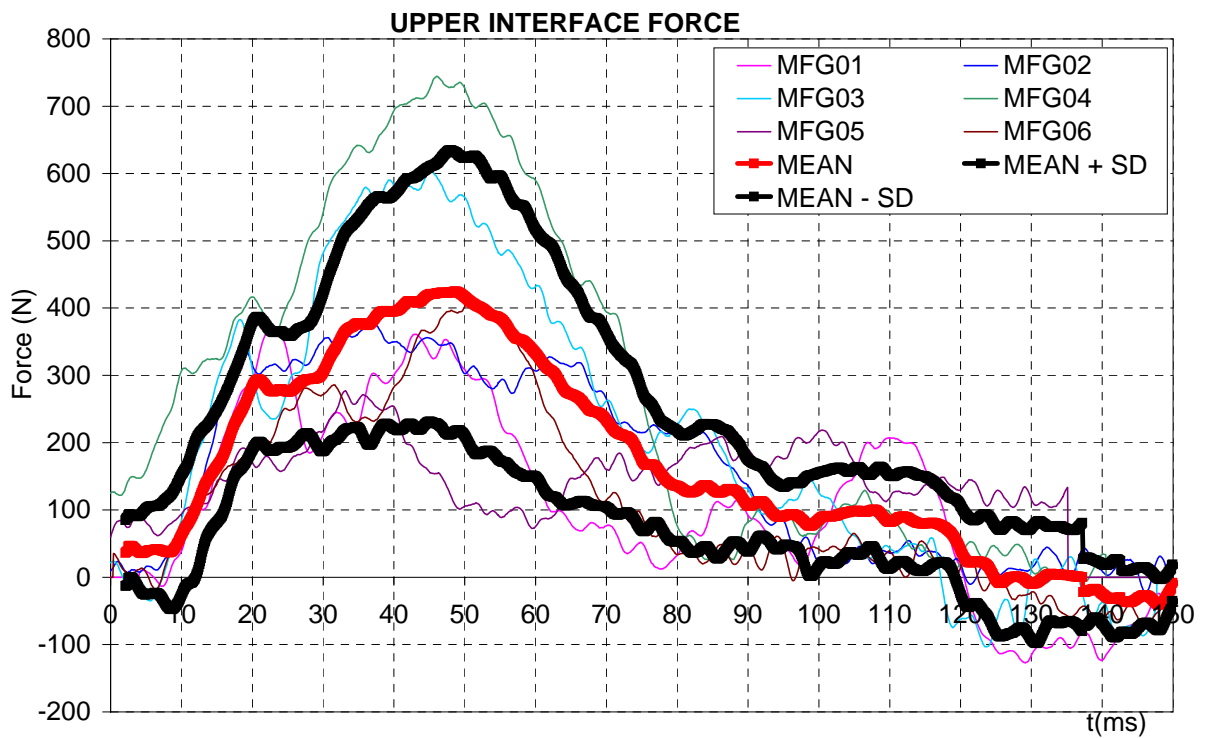

Figure 7 Upper reaction force corridor for 15 km/h tests

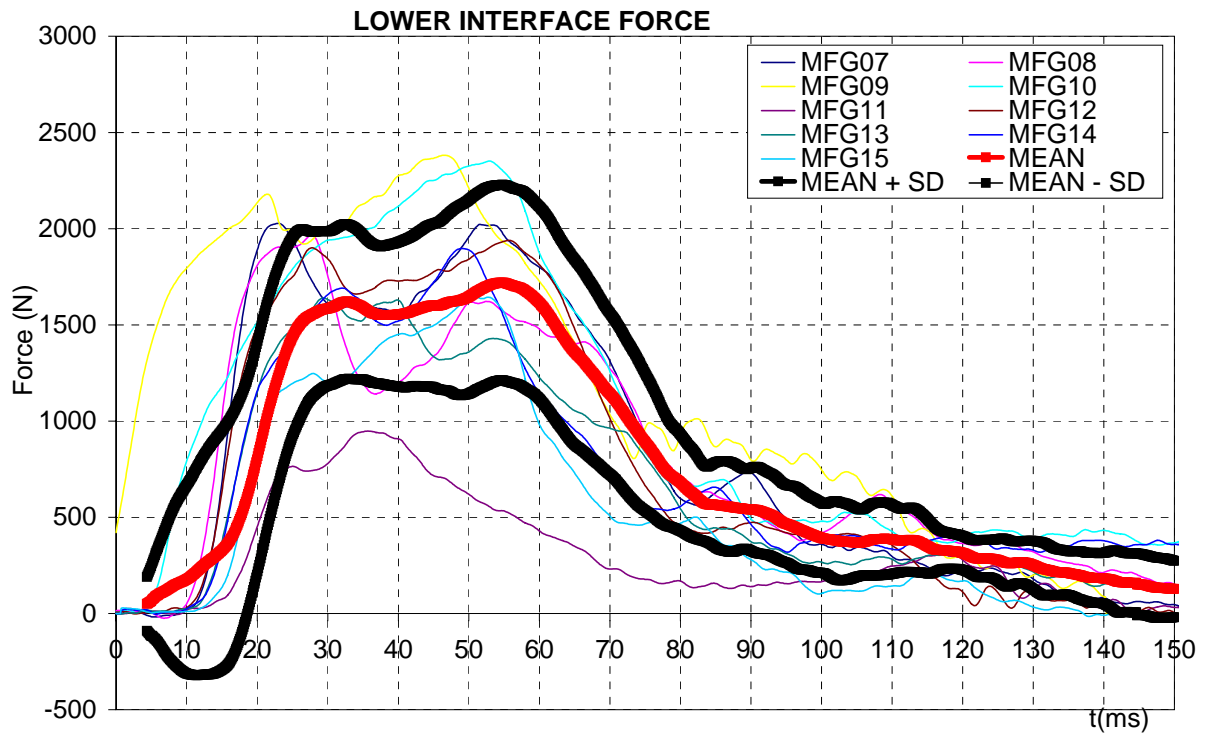

Figure 8 Lower reaction force corridor for 20 km/h tests

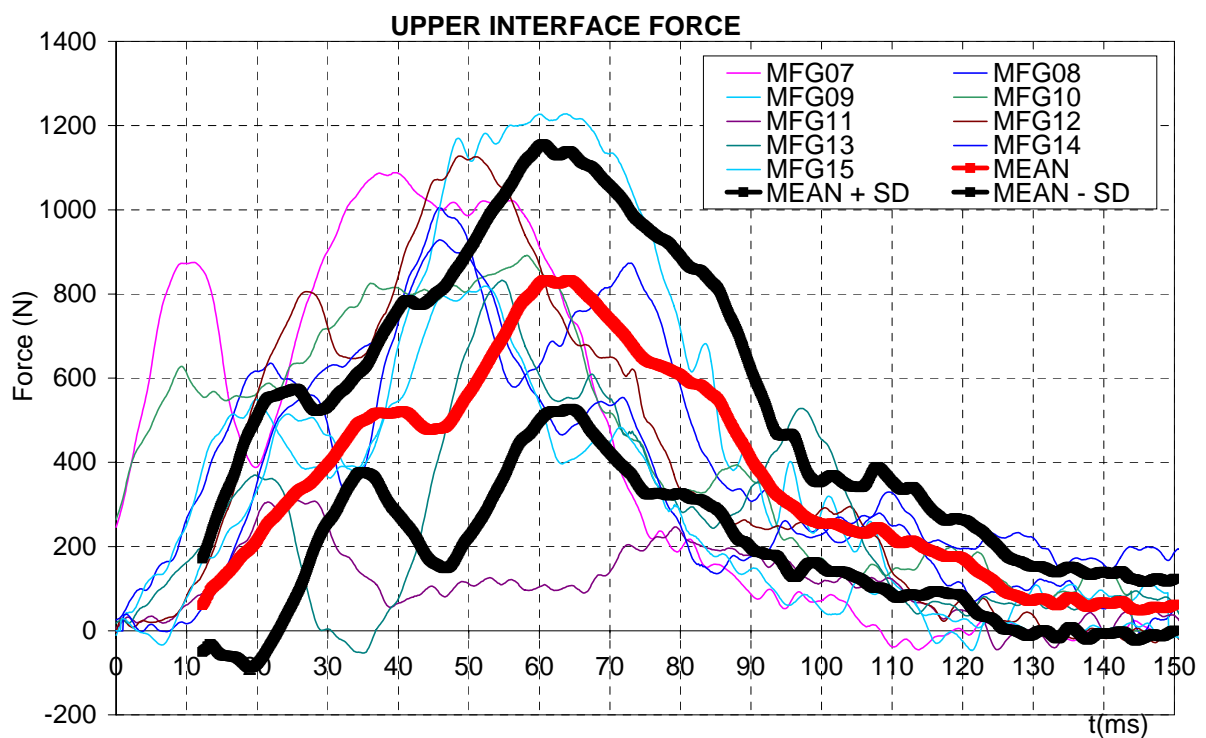

Figure 9 Upper reaction force corridor for 20 km/h tests

These curves are based on cadaver tests, which do not reproduce any muscle action, whereas on human being the muscles exert active and passive forces stiffening the knee

when laterally loaded. Considering a lateral pedestrian impact, MCL is “helped” by 3 muscles (#2, 3, 4 on fig. 10); this tends to support the idea to correct cadaver response when force (or moment) is considered.

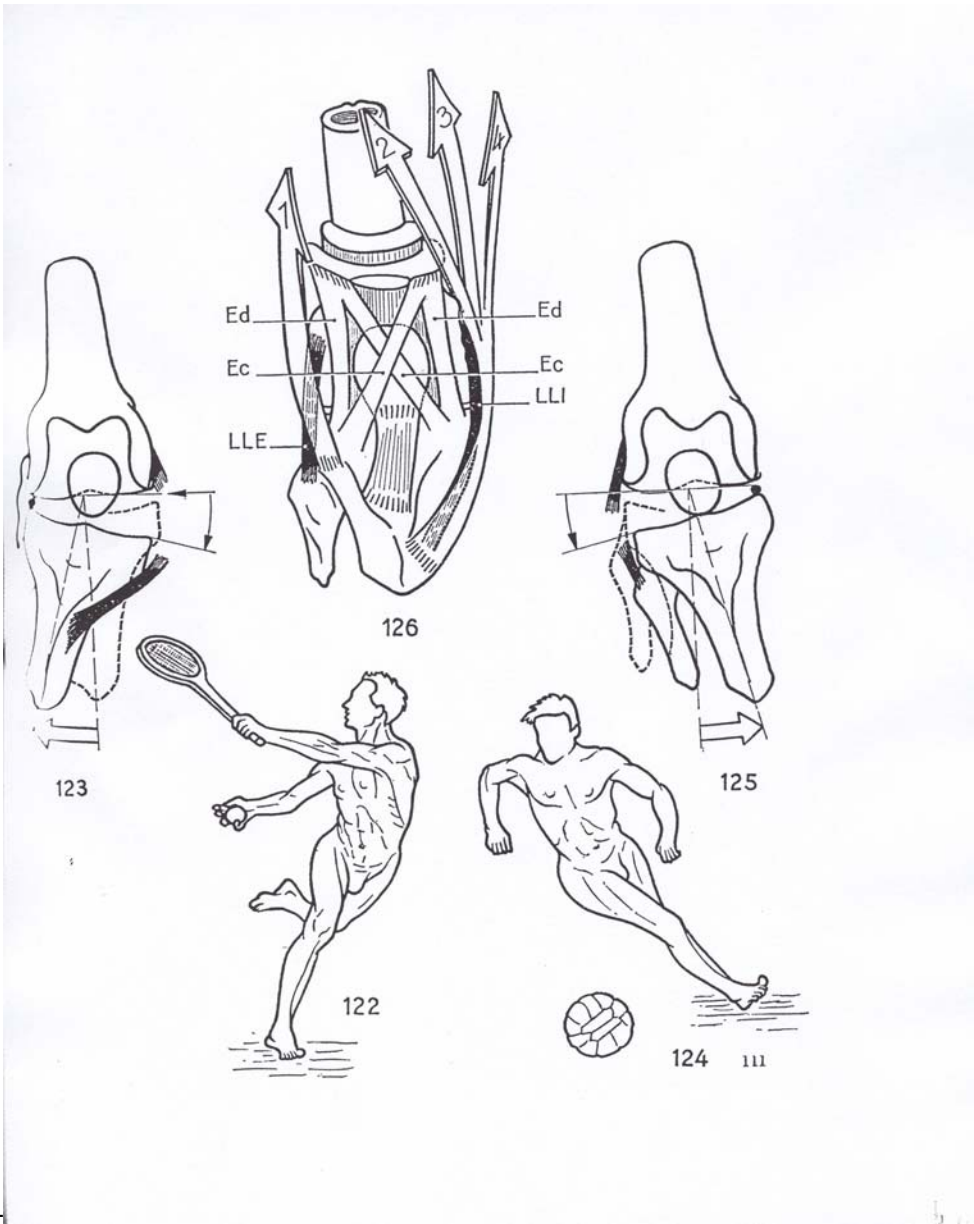

Figure 10 forces acting on the knee (Kapandji)

The response in shearing appears to be more complex: not only ligaments extension, but also internal contact force on the contact surfaces which are not flat control the motion.

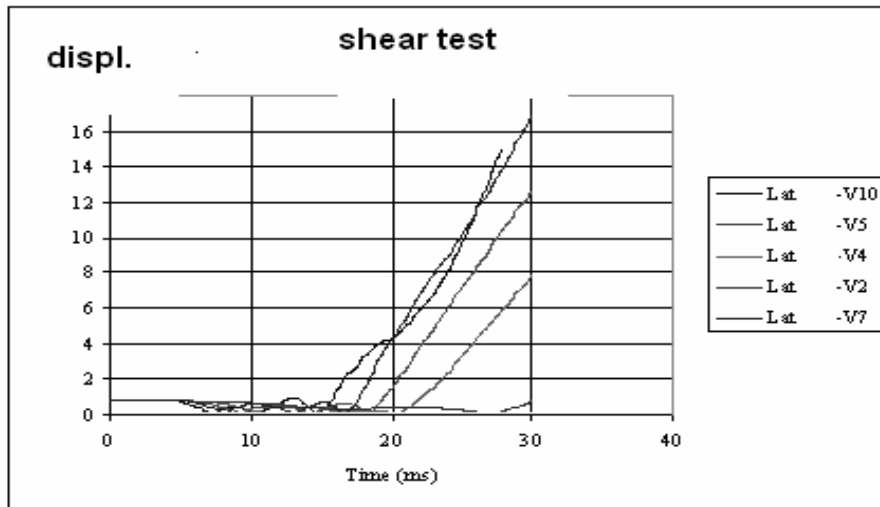

Fig. 11 Shear response

Fig 11 shows displacement time history for shearing tests at different speed. As for bending the shear knee response is based on cadaver tests results which do not take into account muscle effects. Due to the orientation of muscles and tendons, we can expect that muscle effect in stiffening the knee is less important in shearing than in bending due to the orientations of muscles fibres and tendons; nevertheless the knee stiffness values determined from cadaver tests need to be readjusted to take into account muscles effect

5. Knee tolerance

According to several analysis of available data, and in the absence of validated injury risk curve, the tolerance in bending should be around 20° bedding angle. This value corresponds to the peak of the reaction force at 20 km/h tests. Only UVa test give a lower value, apparently due to impact conditions.

Using the same methodology, a tolerance of about 14 mm can be found for the PCL; This would correspond to approximately 10 mm tibia to femur displacement when taking into account the orientation of the ligaments

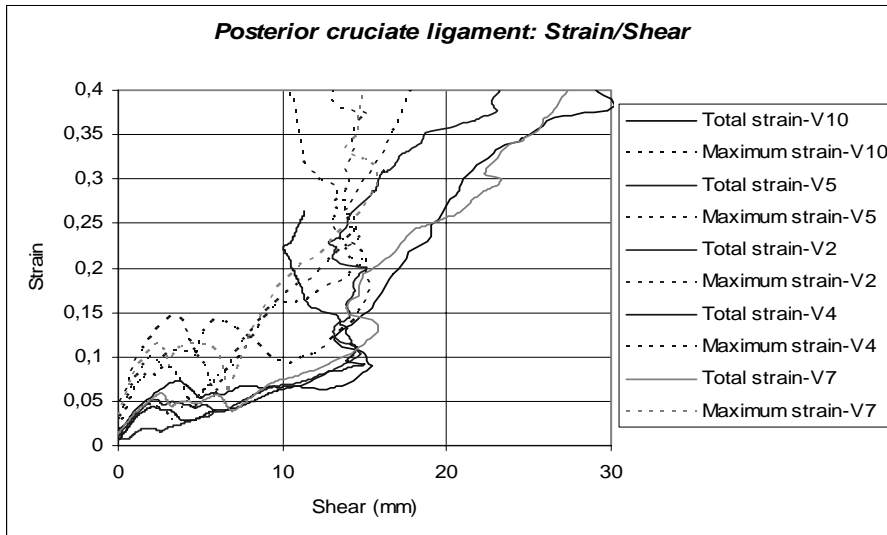

Fig. 12: Shear tolerance