

Note by the secretariat: As part of the secretariat's efforts to reduce expenditure, this voluminous informal document will not be reproduced and distributed during the 58th GRRF session. Delegates are kindly requested to bring their copies of the document to the session.

Informal document No. GRRF-58-3
(58th GRRF session, 20-23 September 2005
agenda item 1.)

UNECE Regulation No. 13 on braking of vehicles of categories M, N and O

(Transmitted by the expert from Hungary)

According to decision of WP.29 at its 136th session (see report TRANS/WP.29/1041, para 52.), GRRF was requested to revise, with the assistance of the representative of Hungary, Regulation No. 13 in order to use the correct units (bar versus kPa).

In this respect, the text of Regulation No. 13/Rev.5 and 13/Rev.5/Amend.3 have been revised by Hungarian experts. In the whole text and diagrams of the Regulation, the former unit of pressure "bar" has been amended to read "kPa", according to the unit of the International System.

The revised text is annexed to this informal document. The amendments to the existing text of the Regulation are marked in **red** characters.

Annexed:

Revised text of Regulation No. 13/Rev.5/Corr.1 and 13/Rev.5/Amend.3/Corr.1

Regulation No. 13

Revision 5 - Amendment 3 - Corr.1

Correction: bar versus kPa

(Transmitted by the expert from Hungary)

**UNIFORM PROVISIONS CONCERNING THE APPROVAL OF VEHICLES
OF CATEGORIES M, N AND O WITH REGARD TO BRAKING**

Paragraph 2.15., delete the reference to footnote 1/ and the corresponding footnote.

Paragraph 2.15.2.2., delete the reference to footnote 2/ and the corresponding footnote.

Through the Regulation, the references to footnotes 3/ to 9/ and their corresponding footnotes,
renumber as footnotes 1/ to 7/.

Paragraph 4.2., amend to read :

" ...its first two digits (at present 10) shall indicate... "

Paragraph 5.2.1.28.2., amend to read :

"5.2.1.28.2. The action of the coupling force control shall be to reduce the difference between the dynamic braking rates of towing and towed vehicles. The operation of the coupling force control shall be checked at the time of type approval. The method by which this check is carried out shall be agreed between the vehicle manufacturer and the technical service with the method of assessment and results being appended to the type approval report."

Paragraph 5.2.1.28.6., amend to read :

"5.2.1.28.6. A coupling force control system shall only control the coupling forces generated by the service braking system of the motor vehicle and the trailer. Coupling forces resulting from the performance of endurance braking systems shall not be compensated by the service braking systems of either the motor vehicle or trailer. It is considered that endurance braking systems are not part of the service braking systems."

Insert new paragraphs 12.1.1.2. and 12.1.1.3., to read:

"12.1.1.2. Unless otherwise stated, or unless the context requires otherwise, supplements to the 10 series of amendments shall also apply to the issuing and maintenance of 09 series approvals.

12.1.1.3. As from the official date of entry into force of the 10 series of amendments, no Contracting Party applying this Regulation shall refuse to grant approval under this Regulation as amended by the 10 series of amendments."

Insert new paragraphs 12.1.2.5. to 12.1.2.7., to read:

"12.1.2.5. As from 24 months after the date of entry into force of the 10 series of amendments, Contracting Parties applying this Regulation shall grant approvals only if the vehicle type to be approved meets the requirements of this Regulation as amended by the 10 series of amendments.

12.1.2.6. Until 48 months after the date of entry into force of the 10 series of amendments to this Regulation, no Contracting Party applying this Regulation shall refuse national

type approval of a vehicle type approved to the preceding series of amendments to this Regulation.

- 12.1.2.7. Starting 48 months after the entry into force of the 10 series of amendments to this Regulation, Contracting Parties applying this Regulation may refuse first national registration (first entry into service) of a vehicle which does not meet the requirements of the 10 series of amendments to this Regulation."

Annex 3, amend to read:

"Annex 3

ARRANGEMENTS OF APPROVAL MARKS

Model A

(See paragraph 4.4. of this Regulation)

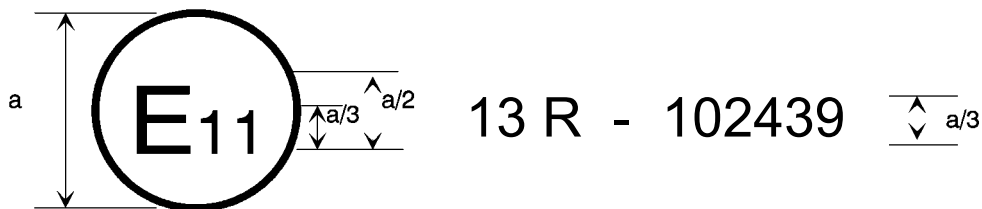

a = 8 mm min.

The above approval mark affixed to a vehicle shows that the vehicle type concerned has, with regard to braking, been approved in the United Kingdom (E 11) pursuant to Regulation No. 13 under approval number 102439. This number indicates that the approval was given in accordance with the requirements of Regulation No. 13 with the 10 series of amendments incorporated. For vehicles of categories M₂ and M₃, this mark means that that type of vehicle has undergone the Type-II test.

Model B

(See paragraph 4.5. of this Regulation)

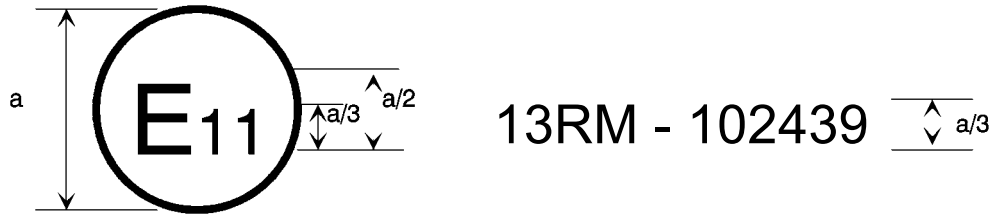

$a = 8 \text{ mm min.}$

The above approval mark affixed to a vehicle shows that the vehicle type concerned has, with regard to braking, been approved in the United Kingdom (E 11) pursuant to Regulation No. 13. For vehicles of categories M₂ and M₃, this mark means that the type of vehicle has undergone the Type-IIA test.

Model C

(See paragraph 4.6. of this Regulation)

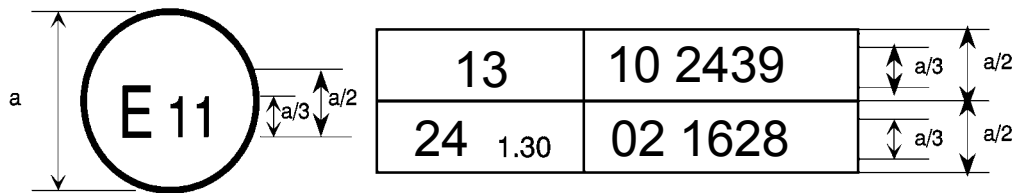

$a = 8 \text{ mm min}$

The above approval mark affixed to a vehicle shows that the vehicle type concerned has been approved in the United Kingdom (E 11) pursuant to Regulations Nos. 13 and 24 1/. (In the case of the latter Regulation the corrected absorption coefficient is 1.30 m⁻¹.)

1/ This number is given merely as an example."

Annex 10,

Paragraph 1.1., insert a reference to a new footnote */ and the corresponding footnote */ , to read:

" as defined in Annex 13 to this Regulation shall meet all the requirements of this annex. If a special device is used, this must operate automatically. */

However, vehicles - other than those of category M₁ –

*/ In the case of trailers with electronically controlled brake force distribution the requirements of this annex shall only apply when the trailer is electrically connected to a towing vehicle by the ISO 7638:1997 connector."

Insert a new paragraph 1.1.1., to read:

"1.1.1. Where a vehicle is installed with an endurance braking system the retarding force produced by that system shall not be taken into consideration when determining the vehicle performance with respect to the provisions of this annex."

Paragraph 1.2., amend to read:

" of this annex, are valid both for vehicles with a pneumatic control line according to paragraph 5.1.3.1.1. of this Regulation and for vehicles with an electric control line according to paragraph 5.1.3.1.3. of this Regulation. In both cases, ... in the electric control line, according to ISO 11992:2003. Vehicles equipped according ... "

Insert new paragraphs 1.3. to 1.3.1.1., and the corresponding footnote, to read:

"1.3.Validation of the development of braking force.

1.3.1. At the time of type approval it shall be checked that the development of braking on an axle of each independent axle group */ shall be within the following pressure ranges:

(a) Laden vehicles:

At least one axle shall commence to develop a braking force when the pressure at the coupling head is within the pressure range **20 to 100 kPa.**

At least one axle of every other axle group shall commence to develop a braking pressure at the coupling head is at a pressure \leq **120 kPa.**

(b) Unladen vehicles:

At least one axle shall commence to develop a braking force when the pressure at the coupling head is within the pressure range **20 to 100 kPa.**

*/ In the case of multiple axles, where the axle spread is greater than 2.0 m, each individual axle shall be considered as an independent axle group.

1.3.1.1. With the wheel(s) of the axle(s) raised off the ground and free to rotate, apply an increasing brake demand and measure the coupling head pressure corresponding to when the wheel(s) can no longer be rotated by hand. This condition is defined as the development of the braking force."

Paragraph 1.3. (former), renumber as paragraph 1.4.

Paragraph 7.5., amend to read:

"7.5. Electronically controlled brake force distribution systems that cannot fulfil the requirements of paragraphs 7.1., 7.2., 7.3. and 7.4. above shall have a self-checking procedure of the functions, which influence brake force distribution. In addition, when the vehicle is stationary, it must be possible to carry out the checks defined in paragraph 1.3.1. above by generating the nominal demand pressure value associated with the commencement of braking for both the laden and the unladen conditions."

Paragraph 8., amend to read:

"8. VEHICLE TESTING

At the time of type approval the technical service shall verify conformity with the requirements contained within this annex and carry out any further tests considered necessary to this end. The results of any further tests shall be recorded and appended to the type approval report."

Diagrams 2, 3 and 4A, amend to read:

"DIAGRAM 2

TOWING VEHICLES AND TRAILERS
 (except tractors for semi-trailers and semi-trailers)
 (see paragraph 3.1.5.1. of this annex)

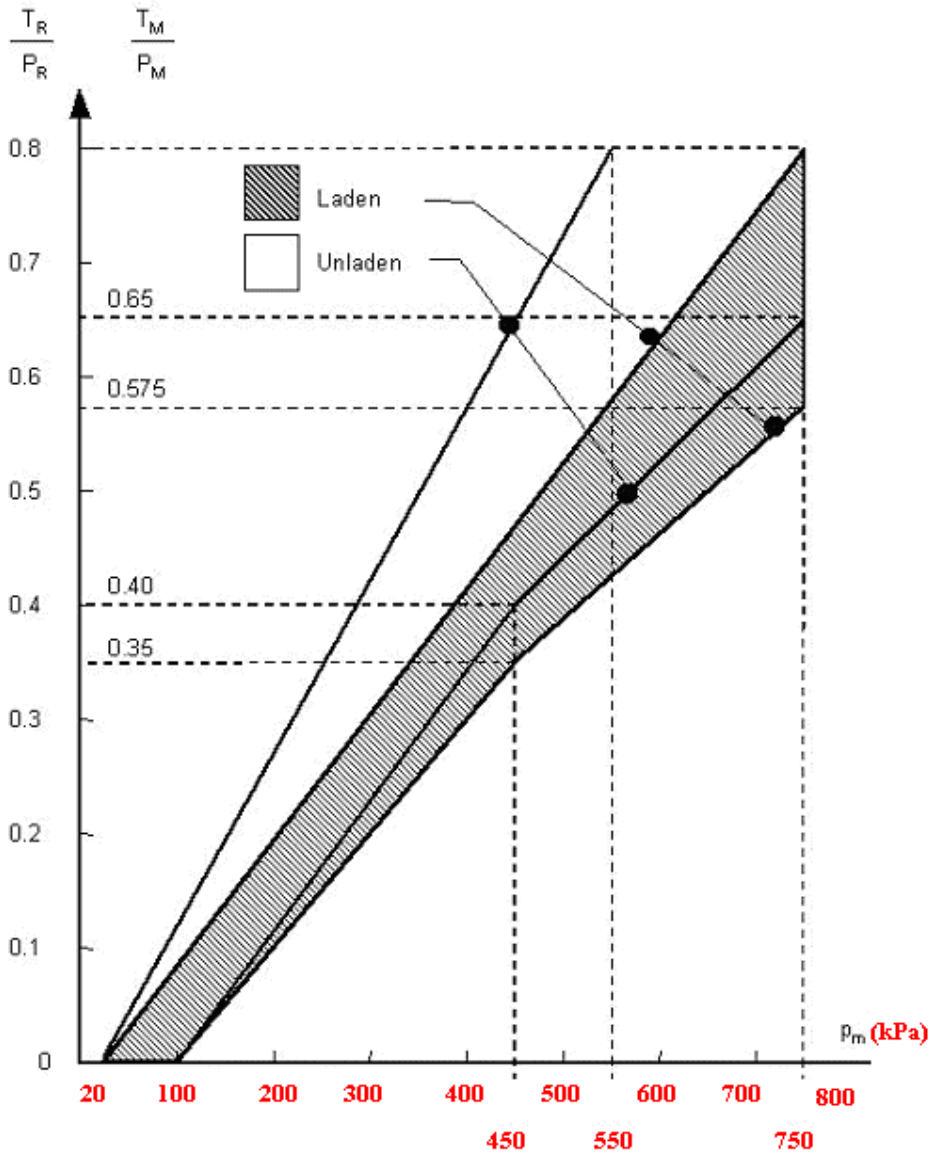

Note: The relationships required by the diagram shall apply progressively for intermediate states of loading between the laden and the unladen states and shall be achieved by automatic means.

DIAGRAM 3

TRACTORS FOR SEMI-TRAILERS
(see paragraph 3.1.6. of this annex)

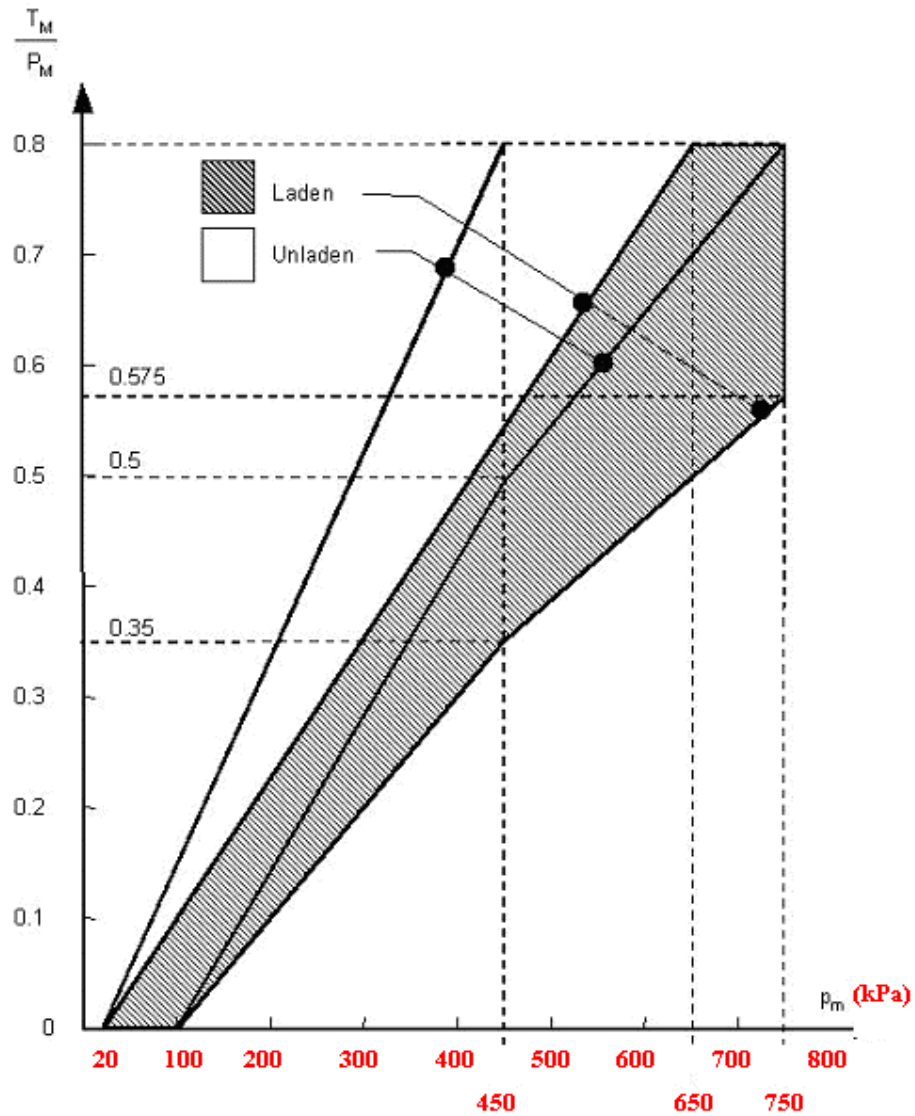

Note: The relationships required by the diagram shall apply progressively for intermediate states of loading between the laden and the unladen states and shall be achieved by automatic means.

DIAGRAM 4A

SEMI-TRAILERS
 (see paragraph 4. of this annex)

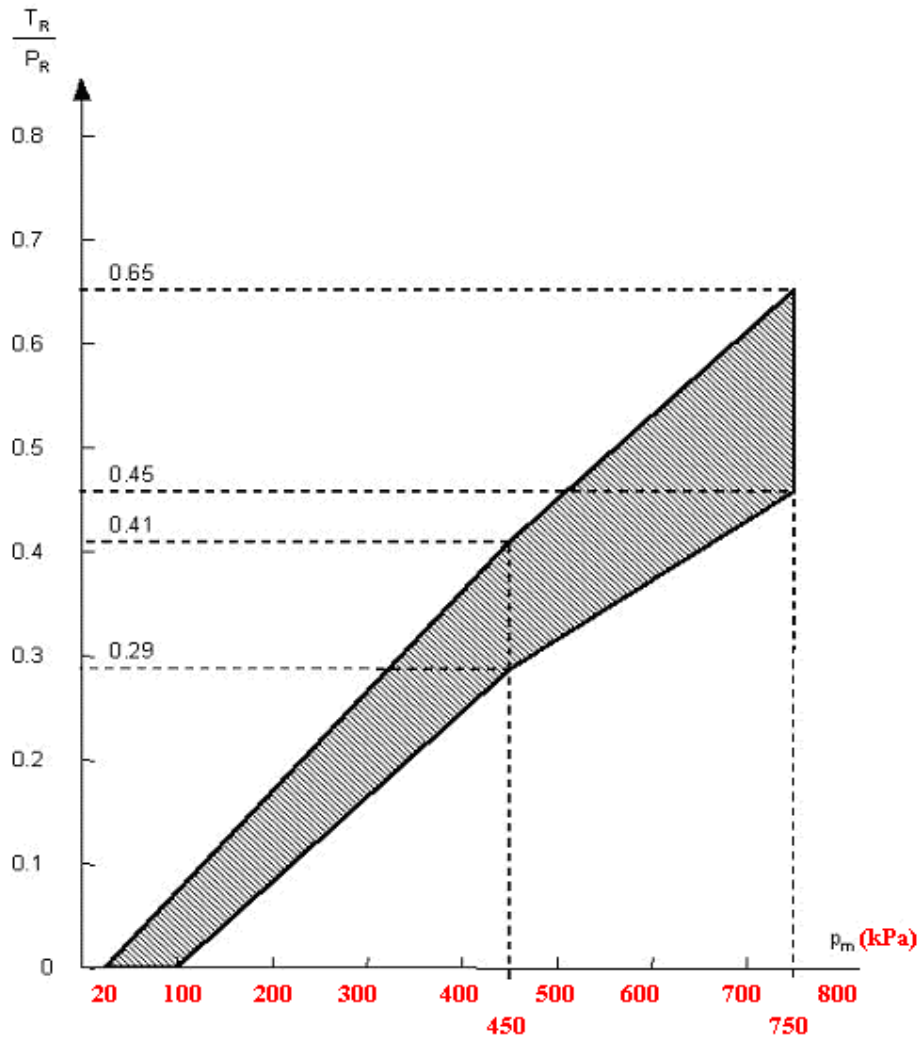

Note: The relation between the braking rate T_R/P_R and the control line pressure for the laden and unladen conditions is determined as follows:

The factors K_c (laden), K_v (unladen) are obtained by reference to diagram 4B. To determine the areas corresponding to the laden and unladen conditions, the values of the ordinates of the upper and lower limits of the hatched area in diagram 4A are multiplied by the factors K_c and K_v respectively."

Annex 13,

Paragraph 1.1., add at the end:

" for compatibility set out in Annex 10 to this Regulation. However, for all load conditions, a braking rate shall be developed between a pressure of 20 and 100 kPa or equivalent digital demand value at the coupling head of the control line(s)."

Add a new paragraph 4.6., to read:

"4.6. Vehicles equipped with an integrated endurance braking system must also be equipped with an anti-lock braking system acting at least on the service brakes of the endurance braking system's controlled axle and on the endurance braking system itself, and shall fulfill the relevant requirements of this annex."

Regulation No. 13

Revision 5-Correction. 1

Correction: bar versus kPa

(Transmitted by the expert from Hungary)

Incorporating all valid text up to:

Supplement 5 to the 09 series of amendments - Date of entry into force: 27 December 2000
Supplement 6 to the 09 series of amendments - Date of entry into force: 20 February 2000 **/
Corrigendum 1 to Supplement 5 to the 09 series of amendments, subject of Depositary Notification
C.N.810.2001.TREATIES-2 dated 11 August 2001
Corrigendum 1 to Supplement 3 to the 09 series of amendments, subject of Depositary Notification
C.N.598.2002.TREATIES-1 dated 13 June 2002
Corrigendum 1 to Supplement 6 to the 09 series of amendments, subject of Depositary Notification
C.N.599.2002.TREATIES-1 dated 13 June 2002
Supplement 7 to the 09 series of amendments - Date of entry into force: 30 January 2003
Corrigendum 2 to Supplement 5 to the 09 series of amendments, subject of Depositary Notification
C.N.788.2002.TREATIES-1 dated 1 August 2002 (French only)
Corrigendum 2 to Supplement 6 to the 09 series of amendments, subject of Depositary Notification
C.N.359.2003.TREATIES-1 dated 6 May 2003
Supplement 8 to the 09 series of amendments - Date of entry into force: 26 February 2004
Corrigendum 1 to Supplement 8 to the 09 series of amendments, subject of Depositary Notification
C.N.163.2004.TREATIES-1 dated 4 March 2004
Corrigendum 3 to Supplement 6 to the 09 series of amendments, subject of Depositary Notification
C.N.441.2004.TREATIES-1 dated 13 May 2004
Corrigendum 1 to Supplement 7 to the 09 series of amendments, subject of Depositary Notification
C.N.442.2004.TREATIES-1 dated 13 May 2004

**UNIFORM PROVISIONS CONCERNING THE APPROVAL OF VEHICLES
OF CATEGORIES M, N AND O WITH REGARD TO BRAKING**

Regulation No. 13

UNIFORM PROVISIONS CONCERNING THE APPROVAL OF VEHICLES
OF CATEGORIES M, N AND O WITH REGARD TO BRAKING

CONTENTS

REGULATION	<u>Page</u>
1. Scope	7
2. Definitions	7
3. Application for approval.....	14
4. Approval	14
5. Specifications	16
6. Tests.....	47
7. Modification of vehicle type or braking system and extension of approval.....	48
8. Conformity of production.....	48
9. Penalties for non-conformity of production	49
10. Production definitely discontinued.....	50
11. Names and addresses of Technical Services responsible for conducting approval tests, and of administrative departments.....	50
12. Transitional provisions	50
ANNEXES	
<u>Annex 1</u> : Braking equipment, devices, methods and conditions not covered by this Regulation	
<u>Annex 2</u> : Communication concerning the approval or extension or refusal or withdrawal of approval or production definitely discontinued of a vehicle type with regard to braking, pursuant to Regulation No. 13	
<u>Annex 2 - Appendix 1</u> - List of vehicle data for the purpose of Regulation No. 90 approvals	

CONTENTS (continued)

- Annex 3: Arrangements of approval marks
- Annex 4: Braking tests and performance of braking systems
- Annex 4 - Appendix - Procedure for monitoring the state of battery charge
- Annex 5: Additional provisions applicable to vehicles subject to marginal 10221 of annex B of ADR */
- Annex 6: Method of measuring the response time on vehicles equipped with compressed-air braking systems
- Annex 6 - Appendix - Example of a simulator
- Annex 7: Provisions relating to energy sources and energy storage devices (Energy accumulators)
- Annex 8: Provisions relating to specific conditions for spring braking systems
- Annex 9: Provisions relating to parking braking systems equipped with a mechanical brake-cylinder locking device (Lock actuators)
- Annex 10: Distribution of braking among the axles of vehicles and requirements for compatibility between towing vehicles and trailers
- Annex 11: Cases in which Type-I and/or Type-II (or Type-II A) tests do not have to be carried out
- Annex 11 - Appendix 1 - Tables I, II and III
- Annex 11 - Appendix 2 - Alternative procedures for Type-I and Type-II tests for trailer brakes
- Annex 11 - Appendix 3 - Model test report form as prescribed in paragraph 3.6. of appendix 2 to this annex

*/ European Agreement concerning the International Carriage of Dangerous Goods by Road, as amended.

CONTENTS (continued)

- Annex 12: Conditions governing the testing of vehicles equipped with inertia (overrun) braking systems
- Annex 12 - Appendix 1 - Figures 1-8
 - Annex 12 - Appendix 2 - Test report on inertia-braking system control device
 - Annex 12 - Appendix 3 - Brake test report
 - Annex 12 - Appendix 4 - Test report on the compatibility of the inertia brake control device, the transmission and the brakes on the trailer
- Annex 13: Test requirements for vehicles fitted with anti-lock systems
- Annex 13 - Appendix 1 - Symbols and definitions
 - Annex 13 - Appendix 2 - Utilization of adhesion
 - Annex 13 - Appendix 3 - Performance on differing adhesion surfaces
 - Annex 13 - Appendix 4 - Method of selection of the low-adhesion surfaces
- Annex 14: Test conditions for trailers with electrical braking systems
- Annex 14 - Appendix - Compatibility of the braking rate of the trailer and the mean fully developed deceleration of the tractor/trailer combination (trailer laden and unladen)
- Annex 15: Inertia dynamometer test method for brake linings
- Annex 16: (Reserved)
- Annex 17: Test procedure to assess the functional compatibility of vehicles equipped with electric control lines
- Annex 18: Special requirements to be applied to the safety aspects of complex electronic vehicle control systems
- Annex 19: Performance testing of braking components
- Annex 19 - Appendix 1 - Model verification report form for diaphragm brake chambers

CONTENTS (continued)

- Annex 19 - Appendix 2 - Model reference record of test results for diaphragm brake chambers
- Annex 19 - Appendix 3 - Model verification report form for spring brakes
- Annex 19 - Appendix 4 - Model reference record of test results for spring brakes
- Annex 19 - Appendix 5 - Trailer anti-lock braking system information document
- Annex 19 - Appendix 6 - Trailer anti-lock braking system test report
- Annex 19 - Appendix 7 - Symbols and definitions
- Annex 20: Alternative procedure for the type approval of trailers
- Annex 20 - Appendix 1 - Method of calculating the centre of gravity height
- Annex 20 - Appendix 2 - Verification graph for paragraph 3.2.1.5. - semi-trailers
- Annex 20 - Appendix 3 - Verification graph for paragraph 3.2.1.6. - central axle trailers
- Annex 20 - Appendix 4 - Verification graph for paragraph 3.2.1.7. - full trailers
- Annex 20 - Appendix 5 - Symbols and definitions

* * *

1. SCOPE

- 1.1. This Regulation applies to the braking of power-driven vehicles individually and of trailers individually of categories M, N and O as defined in annex 7 to the Consolidated Resolution on the Construction of Vehicles (R.E.3) (TRANS/WP.29/78/Rev.1/Amend.2). */
- 1.2. This Regulation does not cover:
- 1.2.1. vehicles with a design speed not exceeding 25 km/h;
- 1.2.2. trailers which may not be coupled to power-driven vehicles with a design speed exceeding 25 km/h;
- 1.2.3. vehicles fitted for invalid drivers;
- 1.3. Subject to the applicable provisions of this Regulation, the equipment, devices, methods and conditions enumerated in annex 1 are not covered by this Regulation.

2. DEFINITIONS

For the purposes of this Regulation,

- 2.1. "Approval of a vehicle" means the approval of a vehicle type with regard to braking;
- 2.2. "Vehicle type" means a category of vehicles which do not differ in such essential respects as:
- 2.2.1. in the case of power-driven vehicle,
- 2.2.1.1. the vehicle category, (see paragraph 1.1. above);
- 2.2.1.2. the maximum mass, as defined in paragraph 2.16. below;
- 2.2.1.3. the distribution of mass among the axles;
- 2.2.1.4. the maximum design speed;

*/ An alternative set of requirements for category M₁ vehicles is offered in Regulation No. 13-H. Contracting Parties that are signatories both to Regulation No. 13-H and this Regulation recognize approvals to either Regulation as equally valid.

- 2.2.1.5. a different type of braking equipment, with more particular reference to the presence or otherwise of equipment for braking a trailer, or any presence of an electric regenerative braking system;
- 2.2.1.6. the number and arrangement of the axles;
- 2.2.1.7. the engine type;
- 2.2.1.8. the number and ratios of gears;
- 2.2.1.9. the final drive ratios;
- 2.2.1.10. the tyre dimensions;
- 2.2.2. in the case of trailers,
 - 2.2.2.1. the vehicle category (see paragraph 1.1. above);
 - 2.2.2.2. the maximum mass, as defined in paragraph 2.16. below;
 - 2.2.2.3. the distribution of mass among the axles;
 - 2.2.2.4. a different type of braking equipment;
 - 2.2.2.5. the number and arrangement of the axles;
 - 2.2.2.6. the tyre dimensions;
- 2.3. "Braking system" means the combination of parts whose function is progressively to reduce the speed of a moving vehicle or bring it to a halt, or to keep it stationary if it is already halted; these functions are specified in paragraph 5.1.2. The system consists of the control, the transmission, and the brake proper;
- 2.4. "Control" means the part actuated directly by the driver (or in the case of some trailers, by an assistant) to furnish to the transmission the energy required for braking or controlling it. This energy may be the muscular energy of the driver, or energy from another source controlled by the driver, or in appropriate cases the kinetic energy of a trailer, or a combination of these various kinds of energy;
 - 2.4.1. "Actuation" means both application and release of the control.
- 2.5. "Transmission" means the combination of components comprised between the control and the brake and linking them functionally. The transmission may be mechanical, hydraulic, pneumatic, electric or mixed. Where the braking power is

derived from or assisted by a source of energy independent of the driver, the reserve of energy in the system is likewise part of the transmission.

The transmission is divided into two independent functions: the control transmission and the energy transmission. Whenever the term "transmission" is used alone in this Regulation, it means both the "control transmission" and the "energy transmission". The control and supply lines between towing vehicles and trailers shall not be considered as parts of the transmission.

- 2.5.1. "Control transmission" means the combination of the components of the transmission which control the operation of the brakes, including the control function and the necessary reserve(s) of energy.
- 2.5.2. "Energy transmission" means the combination of the components which supply to the brakes the necessary energy for their function, including the reserve(s) of energy necessary for the operation of the brakes.
- 2.6. "Brake" means the part in which the forces opposing the movement of the vehicle develop. It may be a friction brake (when the forces are generated by friction between two parts of the vehicle moving relatively to one another); an electrical brake (when the forces are generated by electro-magnetic action between two parts of the vehicle moving relatively to but not in contact with one another); a fluid brake (when the forces are generated by the action of a fluid situated between two parts of the vehicle moving relatively to one another); or an engine brake (when the forces are derived from an artificial increase in the braking action, transmitted to the wheels, of the engine);
- 2.7. "Different types of braking systems" means systems which differ in such essential respects as:
- 2.7.1. components having different characteristics;
- 2.7.2. a component made of materials having different characteristics, or a component differing in shape or size;
- 2.7.3. a different assembly of the components;
- 2.8. "Component of a braking system" means one of the individual parts which, when assembled, constitute the braking system;
- 2.9. "Continuous braking" means the braking of a combination of vehicles through an installation having the following characteristics:
- 2.9.1. a single control which the driver actuates progressively, by a single movement, from his driving seat;

- 2.9.2. the energy used for braking the vehicles constituting the combination is furnished by the same source (which may be the muscular energy of the driver);
- 2.9.3. the braking installation ensures simultaneous or suitably-phased braking of each of the constituent vehicles of the combination, whatever their relative positions;
- 2.10. "Semi-continuous braking" means the braking of a combination of vehicles through an installation having the following characteristics:
 - 2.10.1. a single control which the driver actuates progressively, by a single movement, from his driving seat;
 - 2.10.2. the energy used for braking the vehicles constituting the combination is furnished by two different sources (one of which may be the muscular energy of the driver);
 - 2.10.3. the braking installation ensures simultaneous or suitably-phased braking of each of the constituent vehicles of the combination, whatever their relative positions;
- 2.11. "Automatic braking" means braking of the trailer or trailers occurring automatically in the event of separation of components of the combination of coupled vehicles, including such separation through the breakage of a coupling, the effectiveness of the braking of the remainder of the combination not being thereby destroyed;
- 2.12. "Inertia (or overrun) braking" means braking by utilizing the forces generated by the trailer's moving up on the towing vehicle;
- 2.13. "Progressive and graduated braking" means braking during which, within the normal operating range of the equipment, and during actuation of the brakes (see paragraph 2.4.1. above);
 - 2.13.1. the driver can at any moment increase or decrease the braking force by acting on the control;
 - 2.13.2. the braking force varies proportionally as the action on the control (monotonic function); and
 - 2.13.3. the braking force can be easily regulated with sufficient precision;
- 2.14. "Phased braking" is a means which may be used where two or more sources of braking are operated from a common control, whereby one source may be given priority by phasing back the other source(s) so as to make increased control movement necessary before they begin to be brought into operation.

- 2.15. "Endurance braking system" ^{1/} means an additional braking system having the capability to provide and to maintain a braking effect over a long period of time without a significant reduction in performance. The term "endurance braking system" covers the complete system including the control device,
- 2.15.1. The endurance braking system may comprise a single device or a combination of several devices. Each device may have its own control.
- 2.15.2. Control configurations for endurance braking systems:
- 2.15.2.1. "Independent endurance braking system" means an endurance braking system whose control device is separated from that of the service and other braking systems,
- 2.15.2.2. "Integrated endurance braking system" ^{2/} means an endurance braking system whose control device is integrated with that of the service braking system in such a way that both endurance and service braking systems are applied simultaneously or suitably phased by operation of the combined control device,
- 2.15.2.3. "Combined endurance braking system" means an integrated endurance braking system, which in addition has a cut-out device, which allows the combined control to apply the service braking system alone.
- 2.16. "Laden vehicle" means, except where otherwise stated, a vehicle so laden as to attain its "maximum mass";
- 2.17. "Maximum mass" means the maximum mass stated by the vehicle manufacturer to be technically permissible (this mass may be higher than the "permissible maximum mass" laid down by the national administration);
- 2.18. "The distribution of mass among the axles" means the distribution of the effect of the gravity on the mass of the vehicle and/or its contents among the axles;

^{1/} Until uniform procedures have been agreed to calculate the effects of endurance braking systems on the provisions in annex 10 to this Regulation, this definition does not cover vehicles fitted with regenerative braking systems.

^{2/} Until uniform procedures have been agreed to calculate the effects of endurance braking systems on the provisions in annex 10 to this Regulation, vehicles equipped with an integrated endurance braking system must also be equipped with an anti-lock system acting at least on the service brakes of the endurance braking system controlled axle and on the endurance braking system itself, and tested according to the provisions of annex 13 to this Regulation.

- 2.19. "Wheel/axle load" means the vertical static reaction (force) of the road surface in the contact area on the wheel/wheels of the axle;
- 2.20. "Maximum stationary wheel/axle load" means the stationary wheel/axle load achieved under the condition of the laden vehicle;
- 2.21. "Electric regenerative braking" means a braking system which, during deceleration, provides for the conversion of vehicle kinetic energy into electrical energy.
- 2.21.1. "Electric regenerative braking control" means a device which modulates the action of the electric regenerative braking system.
- 2.21.2. "Electric regenerative braking system of category A" means an electric regenerative braking system which is not part of the service braking system.
- 2.21.3. "Electric regenerative braking systems of category B" means an electric regenerative braking system which is part of the service braking system.
- 2.21.4. "Electric state of charge" means the instantaneous ratio of electric quantity of energy stored in the traction battery relative to the maximum quantity of electric energy which could be stored in this battery.
- 2.21.5. "Traction battery" means an assembly of accumulators constituting the storage of energy used for powering the traction motor(s) of the vehicle.
- 2.22. "Hydraulic braking system with stored energy" means a braking system where energy is supplied by a hydraulic fluid under pressure, stored in one or more accumulators fed from one or more pressure pumps, each fitted with a means of limiting the pressure to a maximum value. This value shall be specified by the manufacturer;
- 2.23. "Simultaneous lockup of the front and rear wheels" refers to the condition when the time interval between the first occurrence of lockup of the last (second) wheel on the rear axle and the first occurrence of lockup on the last (second) wheel on the front axle is less than 0.1 second.
- 2.24. "Electric control line" means the electrical connection between power-driven vehicle and trailer which provides the braking control function to the trailer. It comprises the electrical wiring and connector and includes the parts for data communication and the electrical energy supply for the trailer control transmission.

- 2.25. "Data communication" means the transfer of digital data under the rules of a protocol.
- 2.26. "Point-to-point" means a topology of a communication network with only two units. Each unit has an integrated termination resistor for the communication line.
- 2.27. "Coupling force control" means a system/function to balance automatically the braking rate of towing vehicle and trailer.
- 2.28. "Nominal value" definitions for braking reference performance are required to put a value on the transfer function of the braking system, relating output to input for vehicles individually and when used in combination.
- 2.28.1. "Nominal value" is defined, for a power-driven vehicle, as the characteristic which can be demonstrated at Type Approval and which relates the braking rate of the vehicle on its own to the level of the braking input variable.
- 2.28.2. "Nominal value" is defined, for a trailer, as the characteristic which can be demonstrated at Type Approval and which relates the braking rate to the coupling head signal.
- 2.28.3. "Nominal demand value" is defined, for coupling force control, as the characteristic which relates the coupling head signal to the braking rate and which can be demonstrated at Type Approval, within the limits of the compatibility bands of annex 10.
- 2.29. "Automatically commanded braking" means a function within a complex electronic control system where actuation of the braking system(s) or brakes of certain axles is made for the purpose of generating vehicle retardation with or without a direct action of the driver, resulting from the automatic evaluation of on-board initiated information.
- 2.30. "Selective braking" means a function within a complex electronic control system where actuation of individual brakes is made by automatic means in which vehicle retardation is secondary to vehicle behaviour modification.
- 2.31. "Reference braking forces" means the braking forces of one axle generated at the circumference of the tyre on a roller brake tester, relative to brake actuator pressure and declared at the time of type approval.

3. APPLICATION FOR APPROVAL

- 3.1. The application for approval of a vehicle type with regard to braking shall be submitted by the vehicle manufacturer or by his duly accredited representative.
- 3.2. It shall be accompanied by the undermentioned documents in triplicate and by the following particulars:
- 3.2.1. a description of the vehicle type with regard to the items specified in paragraph 2.2. above. The numbers and/or symbols identifying the vehicle type and, in the case of power-driven vehicles, the engine type shall be specified;
- 3.2.2. a list of the components, duly identified, constituting the braking system;
- 3.2.3. a diagram of assembled braking system and an indication of the position of its components on the vehicle;
- 3.2.4. detailed drawings of each component to enable it to be easily located and identified.
- 3.3. A vehicle, representative of the vehicle type to be approved, shall be submitted to the Technical Service conducting the approval tests.
- 3.4. The competent authority shall verify the existence of satisfactory arrangements for ensuring effective control of the conformity of production before type approval is granted.

4. APPROVAL

- 4.1. If the vehicle type submitted for approval pursuant to this Regulation meets the requirements of paragraphs 5. and 6. below, approval of that vehicle type shall be granted.
- 4.2. An approval number shall be assigned to each type approved, its first two digits (at present 09) shall indicate the series of amendments incorporating the most recent major technical amendments made to the Regulation at the time of issue of the approval. The same Contracting Party shall not assign the same number to the same vehicle type equipped with another type of braking system, or to another vehicle type.
- 4.3. Notice of approval or of refusal of approval of a vehicle type pursuant to this Regulation shall be communicated to the Parties to the Agreement applying this Regulation by means of a form conforming to the model in annex 2 to this Regulation and of a summary of the information contained in the documents referred to in paragraphs 3.2.1. to 3.2.4. above, the drawings supplied by the

applicant being in a format not exceeding A4 (210 x 297 mm), or folded to that format, and on an appropriate scale.

- 4.4. There shall be affixed, conspicuously and in a readily accessible place specified on the approval form, to every vehicle conforming to a vehicle type approved under this Regulation, an international approval mark consisting of:
- 4.4.1. a circle surrounding the letter "E" followed by the distinguishing number of the country which has granted approval, 3/ and
- 4.4.2. the number of this Regulation, followed by the letter "R", a dash and the approval number to the right of the circle prescribed in paragraph 4.4.1. above.
- 4.5. However, if a vehicle of categories M₂ or M₃ has been approved pursuant to the provisions of annex 4, paragraph 1.8. to this Regulation, the number of the Regulation shall be followed by the letter M.
- 4.6. If the vehicle conforms to a vehicle type approved under one or more other Regulations, annexed to the Agreement, in the country which has granted approval under this Regulation, the symbol prescribed in paragraph 4.4.1. need not be repeated; in such a case, the Regulation and approval numbers and the additional symbols of all the Regulations under which approval has been granted in the country which has granted approval under this Regulation shall be placed in vertical columns to the right of the symbol prescribed in paragraph 4.4.1. above.
- 4.7. The approval mark shall be clearly legible and be indelible.

3/ 1 for Germany, 2 for France, 3 for Italy, 4 for the Netherlands, 5 for Sweden, 6 for Belgium, 7 for Hungary, 8 for the Czech Republic, 9 for Spain, 10 for Serbia and Montenegro, 11 for the United Kingdom, 12 for Austria, 13 for Luxembourg, 14 for Switzerland, 15 (vacant), 16 for Norway, 17 for Finland, 18 for Denmark, 19 for Romania, 20 for Poland, 21 for Portugal, 22 for the Russian Federation, 23 for Greece, 24 for Ireland, 25 for Croatia, 26 for Slovenia, 27 for Slovakia, 28 for Belarus, 29 for Estonia, 30 (vacant), 31 for Bosnia and Herzegovina, 32 for Latvia, 33 (vacant), 34 for Bulgaria, 35 (vacant), 36 for Lithuania, 37 for Turkey, 38 (vacant), 39 for Azerbaijan, 40 for The former Yugoslav Republic of Macedonia, 41 (vacant), 42 for the European Community (Approvals are granted by its Member States using their respective ECE symbol), 43 for Japan, 44 (vacant), 45 for Australia, 46 for Ukraine, 47 for South Africa, 48 for New Zealand, 49 for Cyprus and 50 for Malta. Subsequent numbers shall be assigned to other countries in the chronological order in which they ratify or accede to the Agreement Concerning the Adoption of Uniform Technical Prescriptions for Wheeled Vehicles, Equipment and Parts which can be Fitted and/or be Used on Wheeled Vehicles and the Conditions for Reciprocal Recognition of Approvals Granted on the Basis of these Prescriptions, and the numbers thus assigned shall be communicated by the Secretary-General of the United Nations to the Contracting Parties to the Agreement.

- 4.8. The approval mark shall be placed close to or on the vehicle data plate.
- 4.9. Annex 3 to this Regulation gives examples of arrangements of approval marks.

5. SPECIFICATIONS

5.1. General

5.1.1. Braking system

5.1.1.1. The braking system shall be so designed, constructed and fitted as to enable the vehicle in normal use, despite the vibration to which it may be subjected, to comply with the provisions of this Regulation.

5.1.1.2. In particular, the braking system shall be so designed, constructed and fitted as to be able to resist the corroding and ageing phenomena to which it is exposed.

5.1.1.3. Brake linings shall not contain asbestos.

5.1.1.4. The effectiveness of the braking systems, including the electric control line, shall not be adversely affected by magnetic or electrical fields. This shall be demonstrated by compliance with Regulation No. 10, 02 series of amendments.

5.1.1.5. A failure detection signal may interrupt momentarily (< 10 ms) the demand signal in the control transmission, provided that the braking performance is thereby not reduced.

5.1.2. Functions of the braking system

The braking system defined in paragraph 2.3. of this Regulation must fulfil the following functions:

5.1.2.1. Service braking system

The service braking system must make it possible to control the movement of the vehicle and to halt it safely, speedily and effectively, whatever its speed and load, on any up or down gradient. It must be possible to graduate this braking action. The driver must be able to achieve this braking action from his driving seat without removing his hands from the steering control.

5.1.2.2. Secondary braking system

The secondary braking system must make it possible to halt the vehicle within a reasonable distance in the event of failure of the service braking system. It must be possible to graduate this braking action. The driver must be able to obtain this

braking action from his driving seat while keeping at least one hand on the steering control. For the purposes of these provisions it is assumed that not more than one failure of the service braking system can occur at one time.

5.1.2.3. Parking braking system

The parking braking system must make it possible to hold the vehicle stationary on an up or down gradient even in the absence of the driver, the working parts being then held in the locked position by a purely mechanical device. The driver must be able to achieve this braking action from his driving seat, subject, in the case of a trailer, to the provisions of paragraph 5.2.2.10. of this Regulation. The trailer air brake and the parking braking system of the towing vehicle may be operated simultaneously provided that the driver is able to check, at any time, that the parking brake performance of the vehicle combination, obtained by the purely mechanical action of the parking braking system, is sufficient.

5.1.3. Connections, for compressed-air braking systems, between power-driven vehicles and trailers

5.1.3.1. The connections of the compressed-air braking systems between power-driven vehicles and trailers shall be provided according to paragraphs 5.1.3.1.1., 5.1.3.1.2. or 5.1.3.1.3.:

5.1.3.1.1. One pneumatic supply line and one pneumatic control line;

5.1.3.1.2. One pneumatic supply line, one pneumatic control line and one electric control line;

5.1.3.1.3. One pneumatic supply line and one electric control line; this option is subject to footnote 4/.

5.1.3.2. The electric control line of the power-driven vehicle shall provide information as to whether the requirements of paragraph 5.2.1.18.2. can be satisfied by the electric control line, without assistance from the pneumatic control line. It shall also provide information as to whether it is equipped according to paragraph 5.1.3.1.2. with two control lines or according to paragraph 5.1.3.1.3. with only an electric control line.

5.1.3.3. A power-driven vehicle equipped according to paragraph 5.1.3.1.3. shall recognize that the coupling of a trailer equipped according to paragraph 5.1.3.1.1. is not

4/ Until uniform technical standards have been agreed, which ensure compatibility and safety, connections between power-driven vehicles and trailers conforming to paragraph 5.1.3.1.3. shall not be permitted.

compatible. When such vehicles are electrically connected via the electric control line of the towing vehicle, the driver shall be warned by the red optical warning signal specified in paragraph 5.2.1.29.1.1. and when the system is energized, the brakes on the towing vehicle shall be automatically applied. This brake application shall provide at least the prescribed parking braking performance required by paragraph 2.3.1. of annex 4 to this Regulation.

- 5.1.3.4. In the case of a power-driven vehicle equipped with two control lines as defined in paragraph 5.1.3.1.2., when electrically connected to a trailer which is also equipped with two control lines, the following provisions shall be fulfilled:
- 5.1.3.4.1. both signals shall be present at the coupling head and the trailer shall use the electric control signal unless this signal is deemed to have failed. In this case the trailer shall automatically switch to the pneumatic control line;
- 5.1.3.4.2. each vehicle shall conform to the relevant provisions of annex 10 to this Regulation for both electric and pneumatic control lines; and
- 5.1.3.4.3. when the electric control signal has exceeded the equivalent of 1 kPa for more than 1 second, the trailer shall verify that a pneumatic signal is present; should no pneumatic signal be present, the driver shall be warned from the trailer by the separate yellow warning signal specified in paragraph 5.2.1.29.2. below.
- 5.1.3.5. A trailer may be equipped as defined in paragraph 5.1.3.1.3., provided that it can only be operated in conjunction with a power-driven vehicle with an electric control line which satisfies the requirements of paragraph 5.2.1.18.2. In any other case, the trailer, when electrically connected, shall automatically apply the brakes or remain braked. The driver shall be warned by the separate yellow warning signal specified in paragraph 5.2.1.28.2.
- 5.1.3.6. The electric control line shall conform to ISO 11992-1 and ISO 11992-2:2003 and be a point-to-point type using the seven pin connector according to ISO 7638-1 or 7638-2:1997. The data contacts of the ISO 7638 connector shall be used to transfer information exclusively for braking (including ABS) and running gear (steering, tyres and suspension) functions as specified in ISO 11992-2:2003. The braking functions have priority and shall be maintained in the normal and failed modes. The transmission of running gear information shall not delay braking functions. The power supply, provided by the ISO 7638 connector, shall be used exclusively for braking and running gear functions and that required for the transfer of trailer related information not transmitted via the electric control line. However, in all cases the provisions of paragraph 5.2.2.18. of this Regulation shall apply. The power supply for all other functions shall use other measures.

- 5.1.3.6.1. The functional compatibility of towing and towed vehicles equipped with electric control lines as defined above shall be assessed at the time of type approval by checking that the relevant provisions of ISO 11992:2003 parts 1 and 2 are fulfilled. Annex 17 of this Regulation provides an example of tests that may be used to perform this assessment.
- 5.1.3.6.2. When a power-driven vehicle is equipped with an electric control line and electrically connected to a trailer equipped with an electric control line, a continuous failure (> 40 ms) within the electric control line shall be detected in the power-driven vehicle and shall be signalled to the driver by the yellow warning signal specified in paragraph 5.2.1.29.1.2., when such vehicles are connected via the electric control line.
- 5.1.3.7. If the operation of the parking braking system on the power-driven vehicle also operates a braking system on the trailer, as permitted by paragraph 5.1.2.3., then the following additional requirements shall be met:
- 5.1.3.7.1. When the power-driven vehicle is equipped according to paragraph 5.1.3.1.1., the actuation of the parking brake system of the power-driven vehicle shall actuate a braking system on the trailer via the pneumatic control line.
- 5.1.3.7.2. When the power-driven vehicle is equipped according to paragraph 5.1.3.1.2., the actuation of the parking brake system on the power-driven vehicle shall actuate a braking system on the trailer as prescribed in paragraph 5.1.3.7.1. In addition, the actuation of the parking brake system may also actuate a braking system on the trailer via the electric control line.
- 5.1.3.7.3. When the power-driven vehicle is equipped according to paragraph 5.1.3.1.3. or, if it satisfies the requirements of paragraph 5.2.1.18.2. without assistance from the pneumatic control line, paragraph 5.1.3.1.2., the actuation of the parking braking system on the power-driven vehicle shall actuate a braking system on the trailer via the electric control line. When the electrical energy for the braking equipment of the power-driven vehicle is switched off, the braking of the trailer shall be effected by evacuation of the supply line (in addition, the pneumatic control line may remain pressurised); the supply line may only remain evacuated until the electrical energy for the braking equipment of the power-driven vehicle is restored and simultaneously the braking of the trailer via the electric control line is restored.
- 5.1.3.8. Shut-off devices which are not automatically actuated shall not be permitted. In the case of articulated vehicle combinations, the flexible hoses and cables shall be a part of the power-driven vehicle. In all other cases, the flexible hoses and cables shall be a part of the trailer.

- 5.1.4. Provisions for the periodic technical inspection of braking systems
- 5.1.4.1. It shall be possible to assess the wear condition of the components of the service brake that are subject to wear e.g. friction linings and drums/discs (in the case of drums or discs, wear assessment may not necessarily be carried out at the time of periodic technical inspection). The method by which this may be realized is defined in paragraphs 5.2.1.11.2 and 5.2.2.8.2. of this Regulation.
- 5.1.4.2. For the purpose of determining the in-use braking forces of each axle of the vehicle, with a compressed-air braking system, air pressure test connections are required:
- 5.1.4.2.1. In each independent circuit of the braking system, at the closest readily accessible position to the brake cylinder which is the least favourably placed as far as the response time described in annex 6 is concerned.
- 5.1.4.2.2. In a braking system which incorporates a pressure modulation device as referred to in paragraph 7.2. of annex 10, located in the pressure line upstream and downstream of this device at the closest accessible position. If this device is pneumatically controlled an additional test connection is required to simulate the laden condition. Where no such device is fitted, a single pressure test connection, equivalent to the downstream connector mentioned above, shall be provided. These test connections shall be so located as to be easily accessible from the ground or within the vehicle.
- 5.1.4.2.3. At the closest readily accessible position to the least favourably placed energy storage device within the meaning of paragraph 2.4. of annex 7, Section A.
- 5.1.4.2.4. In each independent circuit of the braking system so it is possible to check the input and output pressure of the complete transmission line.
- 5.1.4.2.5. The pressure test connections shall comply with clause 4 of ISO Standard 3583:1984.
- 5.1.4.3. The accessibility of required pressure test connections shall not be obstructed by modifications and assembly of accessories or the vehicle body.
- 5.1.4.4. It shall be possible to generate maximum braking forces under static conditions on a rolling road or roller brake tester.
- 5.1.4.5. Data for braking systems:
- 5.1.4.5.1. The data of the compressed-air braking system for the functional and efficiency test must be specified at the vehicle in a visible position in indelible form, or made freely available in another way (e.g. handbook, electronic data recorder).

5.1.4.5.2. for vehicles equipped with compressed-air braking systems at least the following data are required:

Pneumatic characteristic data:

Compressor/unloader valve ⁽¹⁾	Max. cut-out pressure = 100 kPa.....	Min. cut-in pressure = 100 kPa
Four-circuit protection valve	Static closing pressure = 100 kPa	
Trailer control valve or relay ⁽⁴⁾ emergency valve, as appropriate	Corresponding delivery pressure for a control pressure of 150 kPa = 100 kPa	
Minimum design pressure in the service braking system for calculation ⁽¹⁾⁽²⁾		

	Axle(s)		
Brake cylinder type ⁽³⁾ Service / Parking	/	/	/
Maximum stroke ⁽³⁾ s _{max} = mm			
Lever length ⁽³⁾ = mm			

- Notes:
- (1) Not applicable for trailers;
 - (2) When different from minimum cut-in pressure;
 - (3) Only applicable for trailers;
 - (4) Not applicable for vehicles with electronic control of braking systems.

5.1.4.6. Reference braking forces

5.1.4.6.1. Reference braking forces shall be defined for vehicles with compressed air operated brakes using a roller brake tester.

5.1.4.6.2. Reference braking forces are to be determined for a brake actuator pressure range from 100 kPa to the pressure generated under Type-0 conditions for each axle. The applicant for type approval shall nominate reference-braking forces for a brake activator pressure range from 100 kPa. These data shall be made available, by the vehicle manufacturer, according to paragraph 5.1.4.5.1. above.

5.1.4.6.3. The reference braking forces shall be declared such that the vehicle is capable of generating a braking rate equivalent to that defined in annex 4 of this Regulation

for the relevant vehicle (50 per cent in the case of vehicles of category M₂, M₃, N₂, N₃, O₃ and O₄ except semi-trailers, 45 per cent in the case of semi-trailers), whenever the measured roller braking force, for each axle irrespective of load, is not less than the reference braking force for a given brake actuator pressure within the declared operating pressure range. */

5.1.4.7. It shall be possible to verify, in a simple way, the correct operational status of those complex electronic systems which have control over braking. If special information is needed, this shall be made freely available.

5.1.4.7.1. At the time of type approval, the means implemented to protect against simple unauthorized modification of the operation to the verification means chosen by the manufacturer (e.g. warning signal) shall be confidentially outlined.

Alternatively, this protection requirement is fulfilled when a secondary means of checking the correct operational status is available.

5.1.5. The requirements of annex 18 shall be applied to the safety aspects of all complex electronic vehicle control systems which provide or form part of the control transmission of the braking function included those which utilise the braking system(s) for automatically commanded braking or selective braking.

However, systems or functions, which use the braking system as the means of achieving a higher level objective, are subject to annex 18 only insofar as they have a direct effect on the braking system. If such systems are provided, they must not be deactivated during type approval testing of the braking system.

5.2. Characteristics of braking systems

5.2.1. Vehicles of categories M and N

5.2.1.1. The set of braking systems with which a vehicle is equipped must satisfy the requirements laid down for service, secondary and parking braking systems.

5.2.1.2. The systems providing service, secondary and parking braking may have common components so long as they fulfil the following conditions:

5.2.1.2.1. there must be at least two controls, independent of each other and readily accessible to the driver from his normal driving position.

*/ For the purpose of periodic technical inspection, the minimum limit braking rate values defined for the whole vehicle may need adjustment to reflect national or international in-service requirements.

For all categories of vehicles, except M₂ and M₃, every brake control (excluding an endurance braking system control) shall be designed such that it returns to the fully off position when released. This requirement shall not apply to a parking brake control (or that part of a combined control) when it is mechanically locked in an applied position;

- 5.2.1.2.2. the control of the service braking system must be independent of the control of the parking braking system;
- 5.2.1.2.3. if the service braking system and the secondary braking system have the same control, the effectiveness of the linkage between that control and the different components of the transmission systems must not be liable to diminish after a certain period of use;
- 5.2.1.2.4. if the service braking system and the secondary braking system have the same control, the parking braking system must be so designed that it can be actuated when the vehicle is in motion. This requirement shall not apply if the vehicle's service braking system can be actuated, even partially, by means of an auxiliary control;
- 5.2.1.2.5. Without prejudice to the requirements of paragraph 5.1.2.3. of this Regulation, the service braking system and the parking braking system may use common components in their transmission(s), provided that in the event of a failure in any part of the transmission(s) the requirements for secondary braking are still ensured;
- 5.2.1.2.6. in the event of breakage of any component other than the brakes (as defined in paragraph 2.6. of this Regulation) or the components referred to in paragraph 5.2.1.2.8. below, or of any other failure of the service braking system (malfunction, partial or total exhaustion of an energy reserve), the secondary braking system or that part of the service braking system which is not affected by the failure, must be able to bring the vehicle to a halt in the conditions prescribed for secondary braking;
- 5.2.1.2.7. In particular, where the secondary braking system and the service braking system have a common control and a common transmission:
 - 5.2.1.2.7.1. if service braking is ensured by the action of the driver's muscular energy assisted by one or more energy reserves, secondary braking must, in the event of failure of that assistance, be capable of being ensured by the driver's muscular energy assisted by the energy reserves, if any, which are unaffected by the failure, the force applied to the control not exceeding the prescribed maxima;
 - 5.2.1.2.7.2. if the service braking force and transmission depend exclusively on the use, controlled by the driver, of an energy reserve, there must be at least two

completely independent energy reserves, each provided with its own transmission likewise independent; each of them may act on the brakes of only two or more wheels so selected as to be capable of ensuring by themselves the prescribed degree of secondary braking without endangering the stability of the vehicle during braking; in addition, each of the aforesaid energy reserves must be equipped with a warning device as defined in paragraph 5.2.1.13. below. In each service braking circuit in at least one of the air reservoirs a device for draining and exhausting is required in an adequate and easily accessible position;

- 5.2.1.2.7.3. If the service braking force and transmission depend exclusively on the use of an energy reserve, one energy reserve for the transmission is deemed to be sufficient, provided that the prescribed secondary braking is ensured by the action of the driver's muscular energy acting on the service brake control and the requirements of paragraph 5.2.1.6. are met.
- 5.2.1.2.8. certain parts, such as the pedal and its bearing, the master cylinder and its piston or pistons (hydraulic systems), the control valve (hydraulic and/or pneumatic systems), the linkage between the pedal and the master cylinder or the control valve, the brake cylinders and their pistons (hydraulic and/or pneumatic systems), and the lever-and-cam assemblies of brakes, shall not be regarded as liable to breakage if they are amply dimensioned, are readily accessible for maintenance, and exhibit safety features at least equal to those prescribed for other essential components (such as the steering linkage) of the vehicle. Any such part as aforesaid whose failure would make it impossible to brake the vehicle with a degree of effectiveness at least equal to that prescribed for secondary braking must be made of metal or of a material with equivalent characteristics and must not undergo notable distortion in normal operation of the braking systems.
- 5.2.1.3. Where there are separate controls for the service braking system and the secondary braking system, simultaneous actuation of the two controls must not render both the service braking system and the secondary braking system inoperative, either when both braking systems are in good working order or when one of them is faulty.
- 5.2.1.4. The service braking system must, whether or not it is combined with the secondary braking system, be such that in the event of failure in a part of its transmission a sufficient number of wheels are still braked by actuation of the service brake control; these wheels must be so selected that the residual performance of the service braking system satisfies the requirements laid down in paragraph 2.4. of annex 4 to this Regulation.
- 5.2.1.4.1. However, the foregoing provisions shall not apply to tractor vehicles for semi-trailers when the transmission of the semi-trailer's service braking system is independent of that of the tractor vehicle's service braking system;

- 5.2.1.4.2. The failure of a part of a hydraulic transmission system shall be signalled to the driver by a device comprising a red warning signal, as specified in paragraph 5.2.1.29.1.1. Alternatively, the lighting up of this device when the fluid in the reservoir is below a certain level specified by the manufacturer shall be permitted.
- 5.2.1.5. Where use is made of energy other than the muscular energy of the driver, there need not be more than one source of such energy (hydraulic pump, air compressor, etc.), but the means by which the device constituting that source is driven must be as safe as practicable.
- 5.2.1.5.1. In the event of failure in any part of the transmission of a braking system, the feed to the part not affected by the failure must continue to be ensured if required for the purpose of halting the vehicle with the degree of effectiveness prescribed for residual and/or secondary braking. This condition must be met by means of devices which can be easily actuated when the vehicle is stationary, or by automatic means.
- 5.2.1.5.2. Furthermore, storage devices located down-circuit of this device must be such that in the case of a failure in the energy supply after four full-stroke actuations of the service brake control, under the conditions prescribed in paragraph 1.2. of annex 7 to this Regulation, it is still possible to halt the vehicle at the fifth application, with the degree of effectiveness prescribed for secondary braking.
- 5.2.1.5.3. However, for hydraulic braking systems with stored energy, these provisions can be considered to be met provided that the requirements of paragraph 1.2.2. of Part C of annex 7 to this Regulation, are satisfied.
- 5.2.1.6. The requirements of paragraphs 5.2.1.2., 5.2.1.4. and 5.2.1.5. of this Regulation must be met without the use of any automatic device of a kind such that its ineffectiveness might pass unnoticed through the fact that parts normally in a position of rest come into action only in the event of failure in the braking system.
- 5.2.1.7. The service braking system shall act on all wheels of the vehicle and shall distribute its action appropriately among the axles.
- 5.2.1.7.1. In the case of vehicles with more than two axles, in order to avoid wheel-locking or glazing of the brake linings, the brake force on certain axles may be reduced to zero automatically when carrying a much reduced load, provided that the vehicle meets all the performance requirements prescribed in annex 4 to this Regulation.

- 5.2.1.7.2. In the case of M₁ and N₁ category vehicles with electric regenerative braking systems of category B, the braking input from other sources of braking, may be suitably phased to allow the electric regenerative braking system alone to be applied, provided that both the following conditions are met:
- 5.2.1.7.2.1. Intrinsic variations in the torque output of the electrical regenerative braking system (e.g. as a result of changes in the electric state of charge in the traction batteries) are automatically compensated by appropriate variation in the phasing relationship as long as the requirements 5/ of one of the following annexes to this Regulation are satisfied:
- Annex 4, paragraph 1.3.2., or
Annex 13, paragraph 5.3. (including the case with the electric motor engaged),
and
- 5.2.1.7.2.2. Wherever necessary, to ensure that braking rate 5/ remains related to the driver's braking demand, having regard to the available tyre/road adhesion, braking shall automatically be caused to act on all wheels of the vehicle.
- 5.2.1.8. The action of the service braking system shall be distributed between the wheels of one and the same axle symmetrically in relation to the longitudinal median plane of the vehicle. Compensation and functions, such as anti-lock, which may cause deviations from this symmetrical distribution, shall be declared.
- 5.2.1.8.1. Compensation by the electric control transmission for deterioration or defect within the braking system shall be indicated to the driver by means of the yellow warning signal specified in paragraph 5.2.1.29.1.2. This requirement shall apply for all conditions of loading when compensation exceeds the following limits:
- 5.2.1.8.1.1. a difference in transverse braking pressures on any axle:
- (a) of 25 per cent of the higher value for vehicle decelerations $\geq 2\text{m/sec}^2$,
 - (b) a value corresponding to 25 per cent at 2m/sec^2 for decelerations below this rate.
- 5.2.1.8.1.2. an individual compensating value on any axle:
- (a) > 50 per cent of the nominal value for vehicle decelerations $\geq 2\text{m/s}^2$,
 - (b) a value corresponding to 50 per cent of the nominal value at 2m/s^2 for decelerations below this rate.

5/ The Authority, which is to grant approval, shall have the right to check the service braking system by additional vehicle test procedures.

- 5.2.1.8.2. Compensation as defined above, is permitted only when the initial brake application is made at vehicle speeds greater than 10 km/h.
- 5.2.1.9. Malfunctions of the electric control transmission shall not apply the brakes contrary to the driver's intentions.
- 5.2.1.10. The service, secondary and parking braking systems must act on braking surfaces connected to the wheels through components of adequate strength.

Where braking torque for a particular axle or axles is provided by both a friction braking system and an electrical regenerative braking system of category B, disconnection of the latter source is permitted, providing that the friction braking source remains permanently connected and able to provide the compensation referred to in paragraph 5.2.1.7.2.1.

However in the case of short disconnection transients, incomplete compensation is accepted, but within 1 s, this compensation shall have attained at least 75 per cent of its final value.

Nevertheless, in all cases the permanently connected friction braking source shall ensure that both the service and secondary braking systems continue to operate with the prescribed degree of effectiveness.

Disconnection of the braking surfaces of the parking braking system shall be permitted only on condition that the disconnection is controlled exclusively by the driver from his driving seat, by a system incapable of being brought into action by a leak.

- 5.2.1.11. Wear of the brakes must be capable of being easily taken up by means of a system of manual or automatic adjustment. In addition, the control and the components of the transmission and of the brakes must possess a reserve of travel and, if necessary, suitable means of compensation such that, when the brakes become heated, or the brake linings have reached a certain degree of wear, effective braking is ensured without immediate adjustment being necessary.
- 5.2.1.11.1. Wear adjustment shall be automatic for the service brakes. However, the fitting of automatic brake adjustment devices is optional for off road vehicles of categories N₂ and N₃ and for the rear brakes of vehicles of categories M₁ and N₁. Brakes equipped with automatic brake adjustment devices shall, after heating followed by cooling, be capable of free running as defined in paragraph 1.5.4. of annex 4 following the Type-I test also defined in that annex.

5.2.1.11.2. Checking the wear of the service brake friction components

5.2.1.11.2.1. It shall be possible to easily check this wear on service brake linings from the outside or underside of the vehicle utilizing only the tools or equipment normally supplied with the vehicle, for instance by the provision of appropriate inspection holes or by some other means. Alternatively, acoustic or optical devices warning the driver at his driving position when lining replacement is necessary are acceptable. The yellow warning signal specified in paragraph 5.2.1.29.1.2. below may be used as the optical warning signal.

5.2.1.11.2.2. Assessment of the wear condition of the friction surfaces of brake discs or drums may only be performed by direct measurement of the actual components, which may necessitate some level of disassembly. Therefore, at the time of type approval, the vehicle manufacturer shall define the following:

- (a) The method by which wear of the friction surfaces of drums and discs may be assessed, including the level of disassembly required and tools and process required to achieve this.
- (b) Information defining the maximum acceptable wear limit at the point at which replacement becomes necessary.

This information shall be made freely available e.g. vehicle handbook or electronic data record.

5.2.1.12. In hydraulic-transmission braking systems, the filling ports of the fluid reservoirs must be readily accessible; in addition, the receptacles containing the reserve fluid must be so designed and constructed that the level of the reserve fluid can be easily checked without the receptacles having to be opened. If this latter condition is not fulfilled, the red warning signal specified in paragraph 5.2.1.29.1.1. shall draw the driver's attention to any fall in the level of reserve fluid liable to cause a failure of the braking system. The type of fluid to be used in the hydraulic transmission braking systems shall be identified by the symbol in accordance with figure 1 or 2 of Standard ISO 9128:1987. The symbol must be affixed in a visible position in indelible form within 100 mm of the filling ports of the fluid reservoirs; additional information may be provided by the manufacturer.

5.2.1.13. Warning device

5.2.1.13.1. Any vehicle fitted with a service brake actuated from an energy reservoir must, where the prescribed secondary braking performance cannot be obtained by means of this braking system without the use of the stored energy, be provided with a warning device, in addition to a pressure gauge, where fitted, giving an optical or acoustic signal when the stored energy, in any part of the system, falls

to a value at which without re-charging of the reservoir and irrespective of the load conditions of the vehicle, it is possible to apply the service brake control a fifth time after four full-stroke actuations and obtain the prescribed secondary braking performance (without faults in the service brake transmission and with the brakes adjusted as closely as possible). This warning device must be directly and permanently connected to the circuit. When the engine is running under normal operating conditions and there are no faults in the braking system, as is the case in approval tests for this type, the warning device must give no signal except during the time required for charging the energy reservoir(s) after start-up of the engine. The red warning signal specified in paragraph 5.2.1.29.1.1. shall be used as the optical warning signal.

- 5.2.1.13.1.1. However, in the case of vehicles which are only considered to comply with the requirements of paragraph 5.2.1.5.1. of this Regulation by virtue of meeting the requirements of paragraph 1.2.2. of Part C of annex 7 to this Regulation, the warning device shall consist of an acoustic signal in addition to an optical signal. These devices need not operate simultaneously, provided that each of them meet the above requirements and the acoustic signal is not actuated before the optical signal. The red warning signal specified in paragraph 5.2.1.29.1.1. shall be used as the optical warning signal.
- 5.2.1.13.1.2. This acoustic device may be rendered inoperative while the handbrake is applied and/or, at the choice of the manufacturer, in the case of automatic transmission the selector is in the "Park" position.
- 5.2.1.14. Without prejudice to the requirements of paragraph 5.1.2.3. of this Regulation, where an auxiliary source of energy is essential to the functioning of a braking system, the reserve of energy must be such as to ensure that, if the engine stops or in the event of a failure of the means by which the energy source is driven, the braking performance remains adequate to bring the vehicle to a halt in the prescribed conditions. In addition, if the muscular effort applied by the driver to the parking braking system is reinforced by a servo device, the actuation of the parking braking system must be ensured in the event of a failure of the servo device, if necessary by using a reserve of energy independent of that normally supplying the servo device. This reserve of energy may be that intended for the service braking system.
- 5.2.1.15. In the case of a power-driven vehicle to which the coupling of a trailer equipped with a brake controlled by the driver of the towing vehicle is authorized, the service braking system of the towing vehicle must be equipped with a device so designed that in the event of failure of the trailer's braking system, or in the event of an interruption in the air supply pipe (or of such other type of connection as may be adopted) between the towing vehicle and its trailer, it shall still be possible to brake the towing vehicle with the effectiveness prescribed for

secondary braking; it is accordingly prescribed, in particular, that this device shall be situated on the towing vehicle.

- 5.2.1.16. If the pneumatic/hydraulic auxiliary equipment must be supplied with energy in such a way that during its operation the prescribed deceleration values can be reached and that even in the event of damage to the source of energy the operation of the auxiliary equipment cannot cause the reserves of energy feeding the braking systems to fall below the level indicated in paragraph 5.2.1.13. above.
- 5.2.1.17. If the trailer is of category O₃ or O₄, the service braking system must be of the continuous or semi-continuous type.
- 5.2.1.18. In the case of a vehicle authorized to tow a trailer of category O₃ or O₄, its braking systems must satisfy the following conditions:
- 5.2.1.18.1. when the towing vehicle's secondary braking system comes into action, there must also be a graduated braking action in the trailer;
- 5.2.1.18.2. in the event of failure of the towing vehicle's service braking system, where that system consists of at least two independent parts, the part or parts not affected by the failure should be capable of partially or fully actuating the brakes of the trailer. It must be possible to graduate this braking action. If this operation is achieved by a valve which is normally at rest, then such a valve may only be incorporated if its correct functioning can easily be checked by the driver, either from within the cab or from outside the vehicle, without the use of tools;
- 5.2.1.18.3. in the event of a failure (e.g. breakage of or leak) in one of the pneumatic connecting lines, interruption or defect in the electric control line, it shall nevertheless be possible for the driver fully or partially to actuate the brakes of the trailer by means either of the service braking control or of the secondary braking control or of the parking braking control, unless the failure automatically causes the trailer to be braked with the performance prescribed in paragraph 3.3. of annex 4 to this Regulation.
- 5.2.1.18.4. the automatic braking in paragraph 5.2.1.18.3. above shall be considered to be met when the following conditions are fulfilled:
- 5.2.1.18.4.1. when the designated brake control of the controls mentioned in paragraph 5.2.1.18.3. above, is fully actuated, the pressure in the supply line must fall to 150 kPa within the following two seconds; in addition, when the brake control is released, the supply line shall be re-pressurised.

- 5.2.1.18.4.2. when the supply line is evacuated at the rate of at least 100 kPa per second the automatic braking of the trailer must start to operate before the pressure in the supply line falls to 200 kPa.
- 5.2.1.18.5. in the event of a failure in one of the control lines connecting two vehicles equipped according to paragraph 5.1.3.1.2., the control line not affected by the failure shall automatically ensure the braking performance prescribed for the trailer in paragraph 3.1. of annex 4.
- 5.2.1.19. In the case of a power-driven vehicle equipped to draw a trailer with electrical braking system, according to paragraph 1.1. of annex 14 to this Regulation, the following requirements shall be met:
- 5.2.1.19.1. the power supply (generator and battery) of the power-driven vehicle shall have a sufficient capacity to provide the current for an electrical braking system. With the engine running at the idling speed recommended by the manufacturer and all electrical devices supplied by the manufacturer as standard equipment of the vehicle switched on, the voltage in the electrical lines shall at maximum current consumption of the electrical braking system (15 A) not fall below the value of 9.6 V measured at the connection. The electrical lines shall not be capable of short circuiting even when overloaded;
- 5.2.1.19.2. in the event of a failure in the towing vehicle's service braking system, where that system consists of at least two independent parts, the part or parts not affected by the failure should be capable of partially or fully actuating the brakes of the trailer;
- 5.2.1.19.3. the use of the stop-lamp switch and circuit for actuating the electrical braking system is permissible only if the actuating line is connected in parallel with the stop-lamp and the existing stop-lamp switch and circuit are capable of taking the extra load.
- 5.2.1.20. In the case of a pneumatic service braking system comprising two or more independent sections, any leakage between those sections at or downstream of the control shall be continuously vented to atmosphere.
- 5.2.1.21. In the case of a power-driven vehicle authorized to tow a trailer of categories O₃ or O₄, the service braking system of the trailer may only be operated in conjunction with the service, secondary or parking braking system of the towing vehicle. However, automatic application of the trailer brakes alone is permitted for the purpose of vehicle stabilisation.
- 5.2.1.22. Power-driven vehicles of categories M₂, M₃, N₂ and N₃ with not more than four axles shall be equipped with anti-lock systems of category 1 in accordance with annex 13 to this Regulation.

- 5.2.1.23. Power-driven vehicles of category M₁ equipped with temporary-use spare wheels/tyres shall satisfy the technical requirements of annex 3 to Regulation No. 64.
- 5.2.1.24. Power-driven vehicles authorized to tow a trailer equipped with an anti-lock system shall also be equipped with a special electrical connector, conforming to ISO 7638:1997 */, for the electric control transmission and/or the anti-lock systems of trailers.
- 5.2.1.25. Additional requirements for vehicles of categories M₁, M₂, N₁ and category N₂ < 5 tonnes equipped with an electric regenerative braking system.
- 5.2.1.25.1. Vehicles fitted with an electric regenerative braking system of category A.
- 5.2.1.25.1.1. The electric regenerative braking shall only be actuated by the accelerator control and/or the gear selector neutral position for vehicles of category M₁ or N₁.
- 5.2.1.25.1.2. In addition, for vehicles of categories M₂ and N₂ (< 5 tonnes), the electric regenerative braking control can be a separate switch or lever.
- 5.2.1.25.2. Vehicles fitted with an electric regenerative braking system of category B.
- 5.2.1.25.2.1. It shall not be possible to disconnect, partially or totally, one part of the service braking system other than by automatic means. This should not be construed as a departure from the requirements of paragraph 5.2.1.10.
- 5.2.1.25.2.2. The service braking system shall have only one control device.
- 5.2.1.25.2.3. For vehicles fitted with an electric regenerative braking system of both categories, all the relevant prescriptions shall apply except paragraph 5.2.1.25.1.1.
- In this case, the electric regenerative braking may be actuated by the accelerator control and/or the gear selector neutral position for vehicles of category M₁ or N₁.
- Additionally, the action on the service braking control must not reduce the above braking effect generated by the release of accelerator control.

*/ The ISO 7638:1997 connector may be used for 5 pin or 7 pin applications, as appropriate.

- 5.2.1.25.2.4. The service braking system shall not be adversely affected by the disengagement of the motor(s) or by the gear ratio used.
- 5.2.1.25.2.5. If the operation of the electric component of braking is ensured by a relation established between the information coming from the control of the service brake and the braking force at the respective wheels, a failure of this relation leading to the modification of the braking distribution among the axles (annex 10 or 13, whichever is applicable) must be signalled to the driver by an optical warning signal at the latest at the moment when the control is actuated and this signal shall remain lit as long as this defect exists and that the vehicle control switch (key) is in the "ON" position.
- 5.2.1.25.3. The operation of the electric regenerative braking must not be adversely affected by magnetic or electric fields.
- 5.2.1.25.4. For vehicles equipped with an anti-lock device, the anti-lock device shall control the electric regenerative braking system.
- 5.2.1.26. Special additional requirements for the electric transmission of the parking braking system
- 5.2.1.26.1. In the case of a failure within the electric transmission, any unintended actuation of the parking braking system shall be prevented.
- 5.2.1.26.2. In the case of a break in the wiring within the electric control transmission external to the electronic control unit(s) and excluding the energy supply, or a failure in the control, it shall remain possible to apply the parking braking system from the driver's seat and thereby be capable of holding the laden vehicle stationary on an 8 per cent up or down gradient. Alternatively, in this case, an automatic actuation of the parking brake is allowed when the vehicle is stationary, provided that the above performance is achieved and, once applied, the parking brake remains engaged independently of the status of the ignition (start) switch. In this alternative, the parking brake shall be automatically released as soon as the driver starts to set the vehicle in motion again. In the case of vehicles of categories M₁ and N₁, the engine/manual transmission or the automatic transmission (park position) may be used to achieve or assist in achieving the above performance. It shall also be possible to release the parking braking system, if necessary by the use of tools and/or an auxiliary device carried/fitted on the vehicle.
- 5.2.1.26.2.1. A break in the wiring within the electric transmission, or a failure in the control of the parking braking system shall be signalled to the driver by the yellow warning signal specified in paragraph 5.2.1.29.1.2. When caused by a break in the wiring within the electric control transmission of the parking braking system, this yellow warning signal shall be signalled as soon as the break occurs. In

addition, such a failure in the control or break in the wiring external to the electronic control unit(s) and excluding the energy supply shall be signalled to the driver by flashing the red warning signal specified in paragraph 5.2.1.29.1.1. as long as the ignition (start) switch is in the "on" (run) position including a period of not less than 10 seconds thereafter and the control is in the "on" (activated) position. Where actuation of the parking brake is normally indicated by a separate red warning signal, satisfying all the requirements of 5.2.1.29.3., this signal shall be used to satisfy the above requirement for a red signal.

- 5.2.1.26.3. Auxiliary equipment may be supplied with energy from the electric transmission of the parking braking system provided that the supply of energy is sufficient to allow the actuation of the parking braking system in addition to the vehicle electrical load under non-fault conditions. In addition, where the energy reserve is also used by the service braking system, the requirements of paragraph 5.2.1.27.7. shall apply.
- 5.2.1.26.4. After the ignition/start switch which controls the electrical energy for the braking equipment has been switched off and/or the key removed, it shall remain possible to apply the parking braking system, whereas releasing shall be prevented.
- 5.2.1.27. Special additional requirements for service braking systems with electric control transmission
- 5.2.1.27.1. With the parking brake released, the service braking system shall be able to generate a static total braking force at least equivalent to that required by the prescribed Type-0 test, even when the ignition/start switch has been switched off and/or the key has been removed. In the case of power-driven vehicles authorized to tow trailers of category O₃ or O₄, such vehicles shall provide a full control signal for the service braking system of the trailer. It should be understood that sufficient energy is available in the energy transmission of the service braking system.
- 5.2.1.27.2. In the case of a single temporary failure (< 40 ms) within the electric control transmission, excluding its energy supply, (e.g. non-transmitted signal or data error) there shall be no distinguishable effect on the service braking performance.
- 5.2.1.27.3. A failure within the electric control transmission 6/, not including its energy reserve, that affects the function and performance of systems addressed in this Regulation shall be indicated to the driver by the red or yellow warning signal

6/ Until uniform test procedures have been agreed, the manufacturer shall provide the Technical Service with an analysis of potential failures within the control transmission and their effects. This information shall be subject to discussion and agreement between the Technical Service and the vehicle manufacturer.

specified in paragraphs 5.2.1.29.1.1. and 5.2.1.29.1.2., respectively, as appropriate. When the prescribed service braking performance can no longer be achieved (red warning signal), failures resulting from a loss of electrical continuity (eg. breakage, disconnection) shall be signalled to the driver as soon as they occur, and the prescribed residual braking performance shall be fulfilled by operating the service braking control in accordance with paragraph 2.4. of annex 4 to this Regulation. These requirements shall not be construed as a departure from the requirements concerning secondary braking.

- 5.2.1.27.4. A power-driven vehicle, electrically connected to a trailer via an electric control line, shall provide a clear warning to the driver whenever the trailer provides the failure information that the stored energy in any part of the service braking system on the trailer falls below the warning level, as specified in paragraph 5.2.2.16. below. A similar warning shall also be provided when a continuous failure (> 40 ms) within the electric control transmission of the trailer, excluding its energy reserve, precludes achievement of the prescribed service braking performance of the trailer, as specified in paragraph 5.2.2.15.2.1. below. The red warning signal specified in paragraph 5.2.1.29.2.1. shall be used for this purpose.
- 5.2.1.27.5. In the event of a failure of the energy source of the electric control transmission, starting from the nominal value of the energy level, the full control range of the service braking system shall be guaranteed after twenty consecutive full stroke actuations of the service braking control. During the test, the braking control shall be fully applied for 20 seconds and released for 5 seconds on each actuation. It should be understood that during the above test sufficient energy is available in the energy transmission to ensure full actuation of the service braking system. This requirement shall not be construed as a departure from the requirements of annex 7.
- 5.2.1.27.6. When the battery voltage falls below a value nominated by the manufacturer at which the prescribed service braking performance can no longer be guaranteed and/or which precludes at least two independent service braking circuits from each achieving the prescribed secondary or residual braking performance, the red warning signal specified in paragraph 5.2.1.29.1.1. shall be activated. After the warning signal has been activated, it shall be possible to apply the service braking control and obtain at least the residual performance prescribed in paragraph 2.4. of annex 4 to this Regulation. It should be understood that sufficient energy is available in the energy transmission of the service braking system. This requirement shall not be construed as a departure from the requirement concerning secondary braking.
- 5.2.1.27.7. If auxiliary equipment is supplied with energy from the same reserve as the electric control transmission, it shall be ensured that, with the engine running at a speed not greater than 80 per cent of the maximum power speed, the supply of

energy is sufficient to fulfil the prescribed deceleration values by either provision of an energy supply which is able to prevent discharge of this reserve when all auxiliary equipment is functioning or by automatically switching off pre-selected parts of the auxiliary equipment at a voltage above the critical level referred to in paragraph 5.2.1.27.6. of this Regulation such that further discharge of this reserve is prevented. Compliance may be demonstrated by calculation or by a practical test. For vehicles authorized to tow a trailer of category O₃ or O₄ the energy consumption of the trailer shall be taken into account by a load of 400 W. This paragraph does not apply to vehicles where the prescribed deceleration values can be reached without the use of electrical energy.

- 5.2.1.27.8. If the auxiliary equipment is supplied with energy from the electric control transmission, the following requirements shall be fulfilled.
 - 5.2.1.27.8.1. In the event of a failure in the energy source, whilst the vehicle is in motion, the energy in the reservoir shall be sufficient to actuate the brakes when the control is applied.
 - 5.2.1.27.8.2. In the event of a failure in the energy source, whilst the vehicle is stationary and the parking braking system applied, the energy in the reservoir shall be sufficient to actuate the lights even when the brakes are applied.
- 5.2.1.27.9. In the case of a failure in the electric control transmission of the service braking system of a towing vehicle equipped with an electric control line according to paragraph 5.1.3.1.2. or 5.1.3.1.3., the full actuation of the brakes of the trailer shall remain ensured.
- 5.2.1.27.10. In the case of a failure in the electric control transmission of a trailer, electrically connected via an electric control line only, according to paragraph 5.1.3.1.3., braking of the trailer shall be ensured according to paragraph 5.2.1.18.4.1. This shall be the case whenever the trailer provides the "supply line braking request" signal via the data communication part of the electric control line or in the event of the continuous absence of this data communication. This paragraph shall not apply to power-driven vehicles which cannot be operated with trailers connected via an electric control line only, as described in paragraph 5.1.3.5.
- 5.2.1.28. Special requirements for coupling force control
 - 5.2.1.28.1. Coupling force control shall only be permitted in the towing vehicle.
 - 5.2.1.28.2. The action of the coupling force control shall be to reduce the difference between the dynamic braking rates of towing and towed vehicles.
 - 5.2.1.28.2.1. The coupling force control may control the braking rate T_M/P_M and/or the brake demand value(s) for the trailer. In the case of a towing vehicle equipped with

two control lines according to paragraph 5.1.3.1.2. above, both signals shall be subject to similar control adjustments.

- 5.2.1.28.2.2. The coupling force control shall not prevent the maximum possible braking pressure(s) from being applied.
- 5.2.1.28.3. The vehicle shall fulfil the laden compatibility requirements of annex 10, but to achieve the objectives of paragraph 5.2.1.28.2. the vehicle may deviate from these requirements when the coupling force control is in operation.
- 5.2.1.28.4. A coupling force control failure shall be detected and indicated to the driver by a yellow warning signal such as that specified in paragraph 5.2.1.29.1.2. In the event of a failure the relevant requirements of annex 10 shall be fulfilled.
- 5.2.1.28.5. Compensation by the coupling force control system shall be indicated by means of the yellow warning signal specified in paragraph 5.2.1.29.1.2. if this compensation exceeds 150 kPa away from the nominal demand value defined in paragraph 2.27.3. up to a limit, in p_m , of 650 kPa (or the equivalent digital demand). Above the level of 650 kPa the warning shall be given if the compensation causes the operating point to lie outside the laden compatibility band as specified in annex 10 for the motor vehicle.

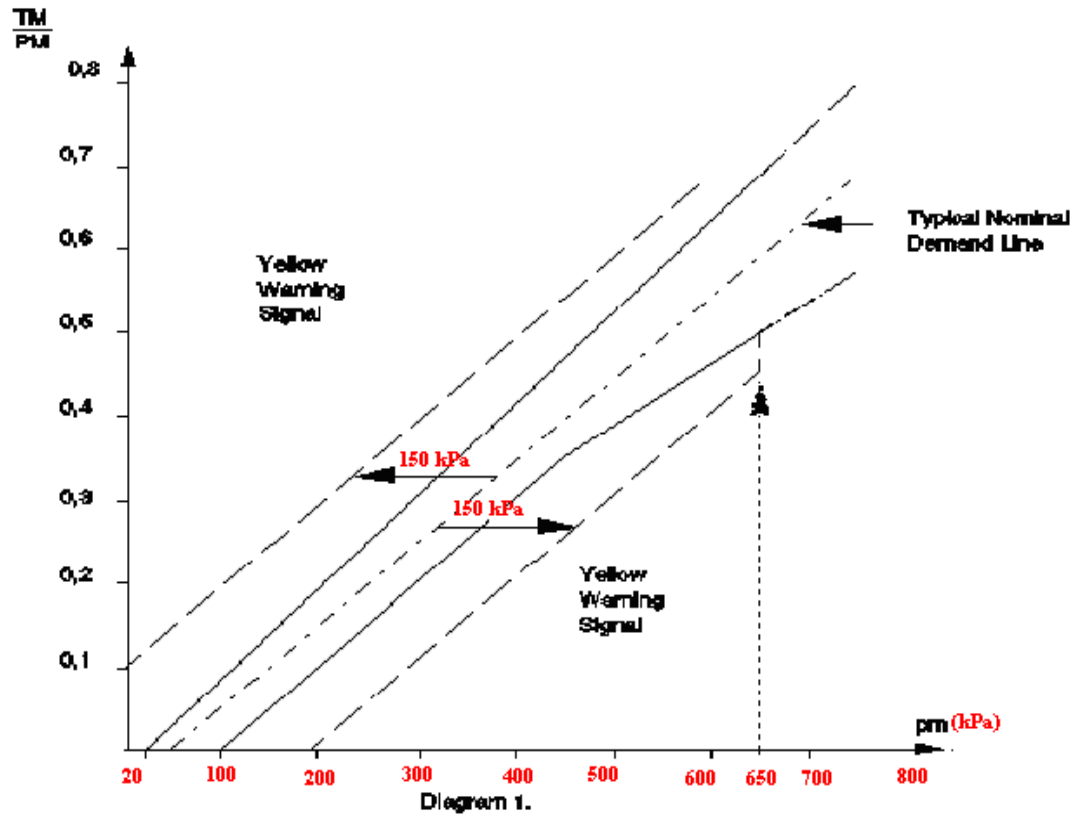

Towing Vehicles for Trailers (except semi-trailers)

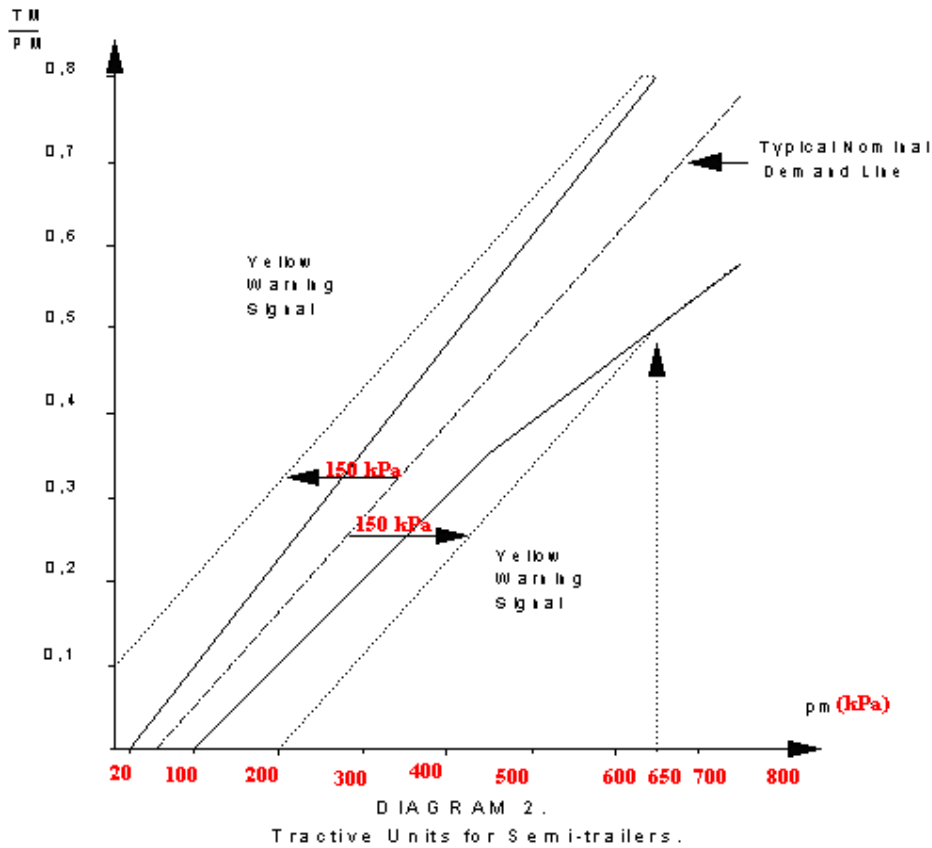

- 5.2.1.28.6. A coupling force control system shall control only the coupling forces generated by the service braking system of the motor vehicle and the trailer, excluding endurance braking systems. Coupling forces resulting from the performance of endurance braking systems shall not be compensated by the service braking system. It is considered that endurance braking systems are not part of the service braking systems.
- 5.2.1.29. The general requirements for optical warning signals whose function is to indicate to the driver certain specified failures (or defects) within the braking equipment of the power-driven vehicle or, where appropriate, its trailer, are set out in the following sub-paragraphs. Other than as described in paragraph 5.2.1.29.6. below, these signals shall be used exclusively for the purposes prescribed by this Regulation.

- 5.2.1.29.1. Power-driven vehicles shall be capable of providing optical brake failure and defect warning signals, as follows:
- 5.2.1.29.1.1. a red warning signal, indicating failures defined elsewhere in this Regulation within the vehicle braking equipment which preclude achievement of the prescribed service braking performance and/or which preclude the functioning of at least one of two independent service braking circuits;
- 5.2.1.29.1.2. where applicable, a yellow warning signal indicating an electrically detected defect within the vehicle braking equipment, which is not indicated by the red warning signal described in paragraph 5.2.1.29.1.1. above.
- 5.2.1.29.2. With the exception of vehicles of categories M₁ and N₁, power-driven vehicles equipped with an electric control line and/or authorised to tow a trailer equipped with an electric control transmission and/or anti-lock braking system, shall be capable of providing a separate yellow warning signal to indicate a defect within the anti-lock braking system and/or electric control transmission of the braking equipment of the trailer. The signal shall be activated from the trailer via pin 5 of the electric connector conforming to ISO 7638:1997 */ and in all cases the signal transmitted by the trailer shall be displayed without significant delay or modification by the towing vehicle. This warning signal shall not light up when coupled to a trailer without an electric control line and/or electric control transmission and/or anti-lock braking system or when no trailer is coupled. This function shall be automatic.
- 5.2.1.29.2.1. In the case of a power-driven vehicle equipped with an electric control line, when electrically connected to a trailer with an electric control line, the red warning signal specified in paragraph 5.2.1.29.1.1. above shall also be used to indicate certain specified failures within the braking equipment of the trailer, whenever the trailer provides corresponding failure information via the data communication part of the electric control line. This indication shall be in addition to the yellow warning signal specified in paragraph 5.2.1.29.2. above. Alternatively, instead of utilizing the red warning signal specified in paragraph 5.2.1.29.1.1. and the accompanying yellow warning signal above, a separate red warning signal may be provided in the towing vehicle to indicate such a failure within the braking equipment of the trailer.
- 5.2.1.29.3. The warning signals shall be visible, even by daylight; the satisfactory condition of the signals shall be easily verifiable by the driver from the driver's seat; the failure of a component of the warning devices shall not entail any loss of the braking system's performance.

*/ The ISO 7638:1997 connector may be used for 5 pin or 7 pin applications, as appropriate.

- 5.2.1.29.4. Except where stated otherwise:
- 5.2.1.29.4.1. a specified failure or defect shall be signalled to the driver by the above-mentioned warning signal(s) not later than on actuation of the relevant braking control;
- 5.2.1.29.4.2. the warning signal(s) shall remain displayed as long as the failure/defect persists and the ignition (start) switch is in the "on" (run) position; and
- 5.2.1.29.4.3. the warning signal shall be constant (not flashing).
- 5.2.1.29.5. The warning signal(s) mentioned above shall light up when the electrical equipment of the vehicle (and the braking system) is energized. With the vehicle stationary, the braking system shall verify that none of the specified failures or defects are present before extinguishing the signals. Specified failures or defects which should activate the warning signals mentioned above, but which are not detected under static conditions, shall be stored upon detection and be displayed at start-up and at all times when the ignition (start) switch is in the "on" (run) position, as long as the failure or defect persists.
- 5.2.1.29.6. Non-specified failures (or defects), or other information concerning the brakes and/or running gear of the power-driven vehicle, may be indicated by the yellow signal specified in paragraph 5.2.1.29.1.2. above, provided that all the following conditions are fulfilled:
- 5.2.1.29.6.1. the vehicle is stationary;
- 5.2.1.29.6.2. after the braking equipment is first energised and the signal has indicated that, following the procedures detailed in paragraph 5.2.1.29.5. above, no specified failures (or defects) have been identified; and
- 5.2.1.29.6.3. non-specified faults or other information shall be indicated only by the flashing of the warning signal. However, the warning signal shall be extinguished by the time when the vehicle first exceeds 10 km/h.
- 5.2.2. Vehicles of category O
- 5.2.2.1. Trailers of category O₁ need not be equipped with a service braking system; however, if a trailer of this category is equipped with a service braking system, it must satisfy the same requirements as a trailer of category O₂.
- 5.2.2.2. Trailers of category O₂ must be equipped with a service braking system either of the continuous or semi-continuous or of the inertia (overrun) type. The latter type shall be authorized only for trailers other than semi-trailers. However,

electrical braking systems conforming to the requirements of annex 14 to this Regulation shall be permitted.

- 5.2.2.3. Trailers of categories O₃ and O₄ must be equipped with a service braking system of the continuous or semi-continuous type.
- 5.2.2.4. The service braking system:
- 5.2.2.4.1. shall act on all the wheels of the vehicle;
- 5.2.2.4.2. shall distribute its action appropriately among the axles;
- 5.2.2.4.3. shall contain in at least one of the air reservoirs a device for draining and exhausting in an adequate and easily accessible position.
- 5.2.2.5. The action of the service braking system shall be distributed between the wheels of one and the same axle symmetrically in relation to the longitudinal median plane of the vehicle. Compensation and functions, such as anti-lock, which may cause deviations from this symmetrical distribution, shall be declared.
- 5.2.2.5.1. Compensation by the electric control transmission for deterioration or defect within the braking system shall be indicated to the driver by means of the separate yellow optical warning signal specified in paragraph 5.2.1.29.2. This requirement shall apply for all conditions of loading when compensation exceeds the following limits:
- 5.2.2.5.1.1. a difference in transverse braking pressures on any axle:
- (a) of 25 per cent of the higher value for vehicle decelerations $\geq 2\text{m/sec}^2$,
- (b) a value corresponding to 25 per cent at 2m/sec^2 for decelerations below this rate.
- 5.2.2.5.1.2. an individual compensating value on any axle:
- (a) > 50 per cent of the nominal value for vehicle decelerations $\geq 2\text{m/sec}^2$,
- (b) a value corresponding to 50 per cent of the nominal value at 2m/sec^2 for decelerations below this rate.
- 5.2.2.5.2. Compensation as defined above, is permitted only when the initial brake application is made at vehicle speeds greater than 10 km/h.
- 5.2.2.6. Malfunctions of the electric control transmission shall not apply the brakes contrary to the driver's intentions.

- 5.2.2.7. The braking surfaces required to attain the prescribed degree of effectiveness must be in constant connection with the wheels, either rigidly or through components not liable to failure.
- 5.2.2.8. Wear of the brakes must be capable of being easily taken up by means of a system of manual or automatic adjustment. In addition, the control and the components of the transmission and of the brakes must possess a reserve of travel and, if necessary, suitable means of compensation such that, when the brakes become heated, or the brake linings have reached a certain degree of wear, effective braking is ensured without immediate adjustment being necessary.
- 5.2.2.8.1. Wear adjustment shall be automatic for the service brakes. However, the fitting of automatic adjustment devices is optional for vehicles of categories O₁ and O₂. Brakes equipped with automatic brake adjustment devices shall, after heating followed by cooling, be capable of free running as defined in paragraph 1.7.3. of annex 4 following the Type-I or Type-III test also defined in that annex as appropriate.
- 5.2.2.8.1.1. In the case of trailers of category O₄ the performance requirements of paragraph 5.2.2.8.1. above shall be deemed to be satisfied by fulfilling the requirements of paragraph 1.7.3. of annex 4.
- 5.2.2.8.1.2. In the case of trailers of categories O₂ and O₃ the performance requirements of paragraph 5.2.2.8.1. above shall be deemed to be satisfied by fulfilling the requirements of paragraph 1.7.3. ^{7/} of annex 4.
- 5.2.2.8.2. Checking the wear of the service brake friction components
- 5.2.2.8.2.1. It shall be possible to easily check this wear on service brake linings from the outside or underside of the vehicle utilizing only the tools or equipment normally supplied with the vehicle, for instance, by the provision of appropriate inspection holes or by some other means.
- 5.2.2.8.2.2. Assessment of the wear condition of the friction surfaces of brake discs or drums may only be performed by direct measurement of the actual components, which may necessitate some level of disassembly. Therefore, at the time of type approval, the vehicle manufacturer shall define the following:

^{7/} Until uniform technical provisions have been agreed that correctly assess the function of the automatic brake adjustment device, the free running requirement shall be deemed to be fulfilled when free running is observed during all brake tests prescribed for the relevant trailer.

- (a) The method by which wear of the friction surfaces of drums and discs may be assessed, including the level of disassembly required and tools and process required to achieve this.
- (b) Information defining the maximum acceptable wear limit at the point at which replacement becomes necessary.

This information shall be made freely available e.g. vehicle handbook or electronic data record.

- 5.2.2.9. The braking systems must be such that the trailer is stopped automatically if the coupling separates while the trailer is in motion. However, this provision shall not apply to trailers with a maximum mass not exceeding 1.5 tonnes, on the condition that the trailers are equipped with, in addition to the coupling device, a secondary coupling (chain, wire rope, etc.) capable, in the event of separation of the main coupling, of preventing the drawbar from touching the ground and providing some residual steering action on the trailer.
- 5.2.2.10. On every trailer which is required to be equipped with a service braking system, parking braking must be assured even when the trailer is separated from the towing vehicle. The parking braking device must be capable of being actuated by a person standing on the ground; however, in the case of a trailer used for the carriage of passengers, this brake must be capable of being actuated from inside the trailer.
- 5.2.2.11. If the trailer is fitted with a device enabling compressed-air actuation of the braking system other than the parking braking system to be cut out, the first-mentioned system must be so designed and constructed that it is positively restored to the position of rest not later than on resumption of the supply of compressed-air to the trailer.
- 5.2.2.12. Trailers of categories O₃ and O₄ shall satisfy the conditions specified in paragraph 5.2.1.18.4.2. An easily accessible pressure test connection is required downstream of the coupling head of the control line.
- 5.2.2.12.1. In the case of trailers equipped with an electric control line and electrically connected to a towing vehicle with an electric control line the automatic braking action specified in paragraph 5.2.1.18.4.2. may be suppressed as long as the pressure in the compressed air reservoirs of the trailer is sufficient to ensure the braking performance specified in paragraph 3.3 of annex 4 to this Regulation.
- 5.2.2.13. Trailers of categories O₃ and O₄ shall be equipped with anti-lock systems in accordance with the requirements of annex 13 to this Regulation.

- 5.2.2.14. Where the auxiliary equipment is supplied with energy from the service braking system, the service braking system shall be protected to ensure that the sum of the braking forces exerted at the periphery of the wheels shall be at least 80 percent of the value prescribed for the relevant trailer as defined in paragraph 3.1.2.1. of annex 4 to this Regulation. This requirement shall be fulfilled under both of the following operating conditions:

During operation of the auxiliary equipment; and

In the event of breakage or leakage from the auxiliary equipment, unless such breakage or leakage affects the control signal referred to in paragraph 6. to annex 10 to this Regulation, in which case the performance requirements of that paragraph shall apply.

- 5.2.2.14.1. The above provisions are deemed to be fulfilled when the pressure in the service brake storage device(s) is maintained at a pressure of at least 80 percent of the control line demand pressure or equivalent digital demand as defined in paragraph 3.1.2.2. of annex 4 to this Regulation.
- 5.2.2.15. Special additional requirements for service braking systems with electric control transmission
- 5.2.2.15.1. In the case of a single temporary failure (< 40 ms) within the electric control transmission, excluding its energy supply, (e.g. non-transmitted signal or data error) there shall be no distinguishable effect on the service braking performance.
- 5.2.2.15.2. In the case of a failure within the electric control transmission (e.g. breakage, disconnection), a braking performance of at least 30 per cent of the prescribed performance for the service braking system of the relevant trailer shall be maintained. For trailers, electrically connected via an electric control line only, according to paragraph 5.1.3.1.3., and fulfilling 5.2.1.18.4.2. with the performance prescribed in paragraph 3.3. of annex 4 to this Regulation, it is sufficient that the provisions of paragraph 5.2.1.27.10. are invoked, when a braking performance of at least 30 per cent of the prescribed performance for the service braking system of the trailer can no longer be ensured, by either providing the "supply line braking request" signal via the data communication part of the electric control line or by the continuous absence of this data communication.
- 5.2.2.15.2.1. A failure within the electric control transmission of the trailer, not including its energy reserve, that affects the function and performance of systems addressed in this Regulation, shall be indicated to the driver by the separate warning signal specified in paragraph 5.2.1.29.2. via pin 5 of the electrical connector

conforming to ISO 7638:1997 8/. In addition, trailers equipped with an electric control line, when electrically connected to a towing vehicle with an electric control line, shall provide the failure information for activation of the red warning signal specified in paragraph 5.2.1.29.2.1. via the data communication part of the electric control line, when the prescribed service braking performance of the trailer can no longer be ensured.

- 5.2.2.16. When the stored energy in any part of the service braking system of a trailer equipped with an electric control line and electrically connected to a towing vehicle with an electronic control line falls to the value determined in accordance with paragraph 5.2.2.16.1. below, a warning shall be provided to the driver of the towing vehicle. The warning shall be provided by activation of the red signal specified in paragraph 5.2.1.29.2.1. and the trailer shall provide the failure information via the data communication part of the electric control line. The separate yellow warning signal specified in paragraph 5.2.1.29.2. shall also be activated via pin 5 of the electrical connector conforming to ISO 7638:1997 */, to indicate to the driver that the low-energy situation is on the trailer.
- 5.2.2.16.1. The low energy value referred to in paragraph 5.2.2.16. above shall be that at which, without re-charging of the energy reservoir and irrespective of the load condition of the trailer, it is not possible to apply the service braking control a fifth time after four full-stroke actuations and obtain at least 50 per cent of the prescribed performance of the service braking system of the relevant trailer.
- 5.2.2.17. Trailers equipped with an electric control line and O₃ and O₄ category trailers equipped with an anti-lock system, shall be fitted with a special electrical connector for the braking system and/or anti-lock system, conforming to ISO 7638:1997 9/ */. Failure warning signals required from the trailer by this Regulation shall be activated via the above connector. The requirement to be applied to trailers with respect to the transmission of failure warning signals shall be those, as appropriate, which are prescribed for motor vehicles in paragraphs 5.2.1.29.4., 5.2.1.29.5. and 5.2.1.29.6.

8/ Until uniform test procedures have been agreed, the manufacturer shall provide the Technical Service with an analysis of potential failures within the control transmission, and their effects. This information shall be subject to discussion and agreement between the Technical Service and the vehicle manufacturer. The ISO 7638:1997 connector may be used for 5 pin or 7 pin applications, as appropriate.

*/ The ISO 7638:1997 connector may be used for 5 pin or 7 pin applications, as appropriate.

9/ The wiring specifications of ISO 7638:1997 for the trailer not equipped with an electric control transmission may be reduced if the trailer is installed with its own independent fuse. The rating of the fuse shall be such that the current rating of the conductors is not exceeded.

5.2.2.17.1. Trailers that utilize selective braking as a means to enhance vehicle stability shall in the event of a failure within the electric control transmission of the stability system indicate the failure by the separate yellow warning signal specified in paragraph 5.2.1.29.2. above via pin 5 of the ISO 7638:1997 connector.

Note: This requirement shall be kept under review during subsequent amendments to Regulation No. 13 pending:

- (i) an amendment to the ISO 11992 data communication standard that includes a message to indicate a failure within the electric control transmission of the trailer stability control system; and
- (ii) vehicles equipped to that standard are in general use.

5.2.2.18. Whenever power supplied by the ISO 7638:1997 connector is used for the functions defined in paragraph 5.1.3.6. above, the braking system shall have priority and be protected from an overload external to the braking system. This protection shall be a function of the braking system.

5.2.2.19. In the case of a failure in one of the control lines connecting two vehicles equipped according to paragraph 5.1.3.1.2. the trailer shall use the control line not affected by the failure to ensure, automatically, the braking performance prescribed for the trailer in paragraph 3.1. of annex 4.

5.2.2.20. When the supply voltage to the trailer falls below a value nominated by the manufacturer at which the prescribed service braking performance can no longer be guaranteed, the separate yellow warning signal specified in paragraph 5.2.1.29.2. shall be activated via pin 5 of the ISO 7638:1997 */ connector. In addition, trailers equipped with an electrical control line, when electrically connected to a towing vehicle with an electric control line, shall provide the failure information for actuation of the red warning signal specified in paragraph 5.2.1.29.2.1. via the data communication part of the electric control line.

6. TESTS

Braking tests which the vehicles submitted for approval are required to undergo, and the braking performance required, are described in annex 4 to this Regulation.

*/ The ISO 7638:1997 connector may be used for a 5 pin or 7 pin applications, as appropriate.

7. MODIFICATION OF VEHICLE TYPE OR BRAKING SYSTEM AND EXTENSION OF APPROVAL
- 7.1. Every modification of the vehicle type or of its braking equipment with regard to the characteristics in annex 2 to this Regulation shall be notified to the administrative department which approved the vehicle type. That department may then either:
- 7.1.1. consider that the modifications made are unlikely to have an appreciable adverse effect and that in any case the vehicle still meets the requirements; or
- 7.1.2. require a further report from the Technical Service responsible for carrying out the tests.
- 7.2. Confirmation or refusal of approval, specifying the alterations, shall be communicated by the procedure specified in paragraph 4.3. above, to the Parties to the Agreement which apply this Regulation.
- 7.3. The competent authority issuing the extension of approval shall assign a series number to each communication form drawn up for such an extension and inform thereof the other Contracting Parties to the 1958 Agreement by means of a communication form conforming to the model in annex 2 to this Regulation.
8. CONFORMITY OF PRODUCTION
- 8.1. A vehicle approved to this Regulation shall be so manufactured as to conform to the type approved by meeting the requirements set forth in paragraph 5 above.
- 8.2. In order to verify that the requirements of paragraph 8.1. above, are met, suitable controls of the production shall be carried out.
- 8.3. The holder of the approval shall in particular:
- 8.3.1. ensure existence of procedures for the effective control of the quality of products;
- 8.3.2. have access to the control equipment necessary for checking the conformity to each approved type;
- 8.3.3. ensure that data of test results are recorded and that annexed documents shall remain available for a period to be determined in accordance with the Administrative Service;
- 8.3.4. analyse the results of each type of test, in order to verify and ensure the stability of the product characteristics making allowance for variation of an industrial production;

- 8.3.5. ensure that for each type of product the tests, or some of them, prescribed in this Regulation are carried out;
- 8.3.6. ensure that any samples or test pieces giving evidence of non-conformity with the type of test considered shall give rise to another sampling and another test. All the necessary steps shall be taken to re-establish the conformity of the corresponding production.
- 8.4. The competent authority which has granted type approval may at any time verify the conformity control methods applicable to each production unit.
- 8.4.1. At every inspection, the test books and production survey records shall be presented to the visiting inspector.
- 8.4.2. The inspector may take samples at random which will be tested in the manufacturer's laboratory. The minimum number of samples may be determined according to the results of the manufacturer's own verification.
- 8.4.3. When the quality level appears unsatisfactory or when it seems necessary to verify the validity of the tests carried out in application of paragraph 8.4.2. above, the inspector shall select samples to be sent to the Technical Service which has conducted the type approval tests.
- 8.4.4. The competent authority may carry out any test prescribed in this Regulation.
- 8.4.5. The normal frequency of inspections by the competent authority shall be one every two years. If unsatisfactory results are recorded during one of these visits, the competent authority shall ensure that all necessary steps are taken to re-establish the conformity of production as rapidly as possible.
9. PENALTIES FOR NON-CONFORMITY OF PRODUCTION
- 9.1. The approval granted in respect of a vehicle type pursuant to this Regulation may be withdrawn if the requirements laid down in paragraph 8.1. above are not complied with.
- 9.2. If a Contracting Party to the Agreement which applies this Regulation withdraws an approval it has previously granted, it shall forthwith so notify the other Contracting Parties applying this Regulation by means of a copy of a communication form conforming to the model in annex 2 to this Regulation.

10. PRODUCTION DEFINITELY DISCONTINUED

If the holder of the approval completely ceases to manufacture a type of vehicle approved in accordance with this Regulation, he shall so inform the authority which granted the approval. Upon receiving the relevant communication, that authority shall inform thereof the other Contracting Parties to the Agreement applying this Regulation by means a communication form conforming to the model in annex 2 to this Regulation.

11. NAMES AND ADDRESSES OF THE TECHNICAL SERVICES CONDUCTING APPROVAL TESTS AND OF ADMINISTRATIVE DEPARTMENTS

The Parties to the Agreement applying this Regulation shall communicate to the United Nations Secretariat the names and addresses of the Technical Services responsible for conducting approval tests and of the administrative departments which grant approval and to which forms certifying approval or extension or refusal or withdrawal of approval, issued in other countries, are to be sent.

12. TRANSITIONAL PROVISIONS

12.1. General

12.1.1. As from the official date of entry into force of the 09 series of amendments, no Contracting Party applying this Regulation shall refuse to grant approval under this Regulation as amended by the 09 series of amendments.

12.1.1.1. As from the official date of entry into force of Supplement 8 to the 09 series of amendments, no Contracting Party applying this Regulation shall refuse to grant ECE approval under this Regulation as amended by Supplement 8 to the 09 series of amendments.

12.1.2. New type approvals

12.1.2.1. Subject to the provisions of paragraph 12.2., as from 1 October 1996 Contracting Parties applying this Regulation shall grant approvals only if the vehicle type to be approved meets the requirements of this Regulation as amended by the 08 or 09 series of amendments.

12.1.2.2. Subject to the provisions of paragraph 12.2., as from 1 October 1998 Contracting Parties applying this Regulation shall grant approvals only if the vehicle type to be approved meets the requirements of this Regulation as amended by the 09 series of amendments.

- 12.1.2.3. During the 24 months' period that follows the date of entry into force of Supplement 8 to the 09 series of amendments, Contracting Parties applying this Regulation shall grant ECE approvals only if the vehicle type to be approved meets either:
- 12.1.2.3.1. the requirements of this Regulation as amended by Supplement 8 to the 09 series of amendments, or
- 12.1.2.3.2. the requirements of paragraphs 5.2.1.11.2. and 5.2.2.8.2. of this Regulation as amended by Supplement 7 to the 09 series of amendments, together with all other requirements of this Regulation as amended by Supplement 8 to the 09 series of amendments.
- 12.1.2.4. As from 24 months after the official date of entry into force of Supplement 8 to the 09 series of amendments, Contracting Parties applying this Regulation shall grant ECE approvals only if the vehicle type to be approved meets the requirements of this Regulation as amended by Supplement 8 to the 09 series of amendments.
- 12.1.3. Limit of validity of old type approvals
- 12.1.3.1. Subject to the provisions of paragraphs 12.1.3.3. and 12.2., approvals granted to this Regulation, as amended by the 06 or 07 series of amendments, shall cease to be valid on 1 October 1998 unless the Contracting Party which granted the approval notifies the other Contracting Parties applying this Regulation that the vehicle type approved meets the requirements of this Regulation as amended by the 08 or 09 series of amendments.
- 12.1.3.2. Subject to the provisions of paragraphs 12.1.3.3. and 12.2., approvals granted to this Regulation, as amended by the 08 series of amendments, shall cease to be valid on 1 October 2000 unless the Contracting Party which granted the approval notifies the other Contracting Parties applying this Regulation that the vehicle type approved meets the requirements of this Regulation as amended by the 09 series of amendments.
- 12.1.3.3. For vehicles of category M₁ and N₁, approvals granted to the 06 series of amendments to this Regulation before 1 July 1995 and any extensions of approvals issued subsequently shall remain valid until 1 April 2001. However this derogation does not extend to the requirements contained in paragraph 5.1.1.3. of this Regulation which shall apply to all new vehicles from 1 October 1998.

12.2. Anti-lock braking devices

In place of the dates specified in paragraphs 12.1.2. and 12.1.3., the requirement for anti-lock braking devices mentioned in paragraphs 5.2.1.22. and 5.2.2.13., as amended by the 08 series of amendments, shall be applied as follows:

Vehicle category	New type approvals (paragraph 12.1.2.)	Limit of validity of old type approvals (paragraph 12.1.3.)
N ₃	1 October 1996	1 October 1998
M ₂ , M ₃ , N ₂ > 7,5 tonnes maximum mass O ₃ > 5 tonnes maximum mass	1 April 1998	1 April 2000
N ₂ ≤ 7,5 tonnes maximum mass O ₃ ≤ 5 tonnes maximum mass	1 April 1999	1 April 2001

12.3. Method of selection of the low adhesion surface for anti-lock testing

By way of derogation, Contracting Parties may grant approvals to this Regulation, as amended by the 08 or 09 series of amendments, before 1 January 1998, even if the requirements of annex 13 - appendix 4 to this Regulation are not fulfilled.

Annex 1

BRAKING EQUIPMENT, DEVICES, METHODS AND CONDITIONS
NOT COVERED BY THIS REGULATION

1. Method of measuring reaction ("response") times in brakes other than compressed-air brakes.

Annex 2

COMMUNICATION */

(maximum format: A4 (210 x 297 mm))



issued by :

Name of administration:

.....
.....
.....

concerning: 2/

- APPROVAL GRANTED
- APPROVAL EXTENDED
- APPROVAL REFUSED
- APPROVAL WITHDRAWN
- PRODUCTION DEFINITELY DISCONTINUED

of a type of vehicle with regard to braking pursuant to Regulation No. 13.

Approval No.:.....

Extension No.:.....

1. Trade name or mark of the vehicle:
2. Vehicle category:
3. Vehicle type:
4. Manufacturer's name and address :
5. If applicable, name and address of manufacturer's representative:
6. Mass of vehicle:
 - 6.1. Maximum mass of vehicle:
 - 6.2. Minimum mass of vehicle:
7. Distribution of mass of each axle (maximum value):
8. Make and type of brake linings:

- 8.1. Brake linings tested to all relevant prescriptions of annex 4
- 8.2. Alternative brake linings tested in annex 15.....
- 9. In the case of a power-driven vehicle:
 - 9.1. Engine type:
 - 9.2. Number and ratios of gears:.....
 - 9.3. Final drive ratio(s):
 - 9.4. If applicable, 2/ maximum mass of trailer which may be coupled:
 - 9.4.1. Full trailer:
 - 9.4.2. Semi-trailer:
 - 9.4.3. Centre-axle trailer
(indicate also the maximum ratio of the coupling overhang 3/ to the wheelbase):
 - 9.4.4. Unbraked trailer:.....
 - 9.4.5. Maximum mass of combination:
- 10. Tyre dimensions:
- 10.1. Temporary-use spare wheel/tyre dimensions:
- 10.2. Vehicle meets the technical requirements of annex 3 to Regulation No. 64: Yes/No 2/
- 11. Number and arrangement of axles:.....
- 12. Brief description of braking equipment:.....
.....

13. Mass of vehicle when tested:

	Unladen [kg]	Laden [kg]
king pin/supporting load <u>4/</u>		
axle No. 1		
axle No. 2		
axle No. 3		
axle No. 4		
Total		

14. Results of the tests and vehicle characteristics

TEST RESULTS		Test speed [km/h]	Measured performance	Measured force applied to control [daN]
14.1. Type-0 tests, engine disconnected	service braking			
	secondary braking			
14.2. Type-0 tests, engine connected:	service braking in accordance with paragraph 2.1.1. of annex 4			
14.3. Type-I tests:	with repeated braking <u>5/</u>			
	with continuous braking <u>4/</u>			
	Free running, in accordance with annex 4, paragraph 1.5.4. <u>5/</u> and annex 4, paragraph 1.7.3. <u>4/</u>			
14.4. Type-II or IIA <u>2/</u> tests, as appropriate:	service braking			
14.5. Type-III tests <u>6/</u>	Free running, in accordance with annex 4, paragraph 1.7.3.			

- 14.6. Braking system(s) used during the Type-II/IIA 2/ test:
- 14.7. Reaction time and dimensions of flexible pipes:
- 14.7.1. Reaction time at the brake actuator: s
- 14.7.2. Reaction time at the control line coupling head: s
- 14.7.3. Flexible pipes of tractors for semi-trailers:
length (m):.....
internal diameter (mm):
- 14.8. Information required under paragraph 7.3. of annex 10 to this Regulation.
- 14.9. Vehicle is/is not 2/ equipped to tow a trailer with electrical braking systems
- 14.10. Vehicle is/is not 2/ equipped with an anti-lock system
- 14.10.1. The vehicle fulfils the requirements of annex 13: Yes / No 2/
- 14.10.2. Category of anti-lock system: category 1/2/3 2/ 5/
category A/B 2/ 6/
- 14.10.3. Vehicle is/is not 2/ equipped to tow trailers equipped with anti-lock systems
- 14.10.4. Where an annex 19 anti-lock test report has been utilized, the test report number(s) shall be stated:
- 14.11. The vehicle is subject to the requirements of annex 5 (ADR): Yes / No 2/
- 14.11.1. The vehicle fulfils the endurance braking performance requirements according to the Type-IIA test up to a total maximum mass of tonnes: Yes / No 2/
- 14.11.2. The power-driven vehicle is fitted with a control device for the endurance braking system on the trailer: Yes / No 2/
- 14.11.3. In the case of trailers, the vehicle is equipped with an endurance braking system: Yes / No 2/
- 14.12. Vehicle is equipped with a control line(s) according to paragraphs 5.1.3.1.1./5.1.3.1.2./5.1.3.1.3. 2/
- 14.13. Adequate documentation according to annex 18 was supplied in respect of the following system(s):

-Yes / No / Not applicable 2/
15. Additional information for use with the annex 20 alternative type approval procedure.
- 15.1. Description of suspension:
- 15.1.1. Manufacturer:
- 15.1.2. Make:
- 15.1.3. Type:
- 15.1.4. Model:
- 15.2. Wheelbase of vehicle tested:
- 15.3. Actuation differential (if any) within bogie:
16. Trailer approved utilising annex 20 procedure: Yes / No 2/
(If yes, appendix 2 to this annex shall be completed)
17. Vehicle submitted for approval on.....
18. Technical Service responsible for conducting approval tests
-
19. Date of report issued by that service
20. Number of report issued by that service
21. Approval granted/refused/extended/withdrawn 2/
22. Position of approval mark on the vehicle
23. Place
24. Date
25. Signature
26. The summary referred to in paragraph 4.3. of this Regulation is annexed to this communication.
-

*/ At the request of (an) applicant(s) for Regulation No. 90 approval, the information shall be provided by the Type Approval Authority as contained in appendix 1 to this annex. However, this information shall not be provided for purposes other than Regulation No. 90 approvals.

1/ Distinguishing number of the country which has granted/extended/refused/withdrawn approval (see approval provisions in the Regulation).

2/ Strike out what does not apply.

3/ "Coupling overhang" is the horizontal distance between the coupling for centre-axle trailers and the centreline of the rear axle(s).

4/ Applies only to vehicles of categories O₂ and O₃.

5/ Applies only to power-driven vehicles.

6/ Applies only to vehicles of category O₄.

Annex 2 - Appendix 1

LIST OF VEHICLE DATA FOR THE PURPOSE OF REGULATION No. 90 APPROVALS

1. Description of the vehicle type.....
- 1.1. Trade name or mark of the vehicle, if available.....
- 1.2. Vehicle category.....
- 1.3. Vehicle type according to Regulation No. 13 approval.....
.....
- 1.4. Models or trade names of vehicles constituting the vehicle type, if available.....
.....
- 1.5. Manufacturer's name and address.....
2. Make and type of brake linings
- 2.1. Brake linings tested to all relevant prescriptions of annex 4.....
.....
- 2.2. Brake linings tested to annex 15.....
3. Minimum mass of vehicle.....
- 3.1. Distribution of mass of each axle (maximum value).....
.....
4. Maximum mass of vehicle.....
- 4.1. Distribution of mass of each axle (maximum value).....
.....
5. Maximum vehicle speed.....
6. Tyre and wheel dimensions.....
7. Brake circuit configuration (e.g. front/rear or diagonal split).....
.....
8. Declaration of which is the secondary braking system.....
.....
9. Specifications of brake valves (if applicable).....
.....

- 9.1. Adjustment specifications of the load sensing valve.....
.....
 - 9.2. Setting of pressure valve.....
 - 10. Designed brake force distribution.....
 - 11. Specification of brake.....
 - 11.1. Disc brake type (e.g. number of pistons with diameter(s), ventilated or solid disc)
.....
 - 11.2. Drum brake type (e.g. duo servo, with piston size and drum dimensions)
 - 11.3. In the case of compressed air brake systems, e.g. type and size of chambers, levers, etc.
 - 12. Master cylinder type and size
 - 13. Booster type and size
-

Annex 2 - Appendix 2

TYPE APPROVAL CERTIFICATE CONCERNING THE
VEHICLE BRAKING EQUIPMENT

1. General

The following additional items are to be recorded when the trailer has been approved utilising the alternative procedure defined in annex 21 to this Regulation.

2. Annex 19 test reports

2.1. Diaphragm brake chambers: Report No.

2.2. Spring Brakes: Report No.

2.3. Trailer brake cold performance characteristics: Report No.

2.4. Anti-lock braking system: Report No.

3. Performance checks

3.1. The trailer fulfils the requirements of annex 4, paragraphs 3.1.2. and 1.2.7 (service braking cold performance) Yes / No

3.2. The trailer fulfils the requirements of annex 4, paragraph 3.2. (parking braking cold performance) Yes / No

3.3. The trailer fulfils the requirements of annex 4, paragraph 3.3. (emergency/automatic braking performance) Yes / No

3.4. The trailer fulfils the requirements of annex 10, paragraph 6. (braking performance in the case a failure in the braking distribution system) Yes / No

3.5. The trailer fulfils the requirements of paragraph 5.2.2.14.1. to this Regulation (braking performance in the event of leakage from auxiliary equipment) Yes / No

3.6. The trailer fulfils the requirements of annex 13
(anti-lock braking)

Yes / No 2/

2/ Strike out what does not apply.

Annex 3

ARRANGEMENTS OF APPROVAL MARKS

Model A

(See paragraph 4.4. of this Regulation)

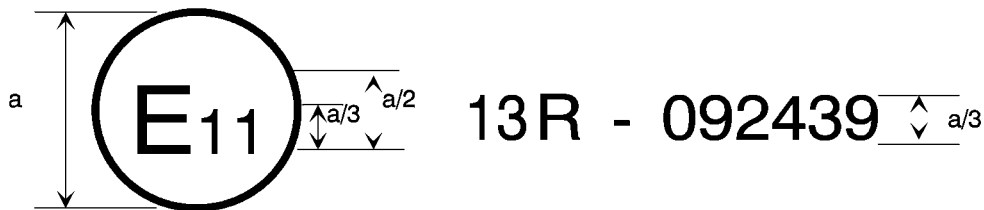

a = 8 mm min.

The above approval mark affixed to a vehicle shows that the vehicle type concerned has, with regard to braking, been approved in the United Kingdom (E 11) pursuant to Regulation No. 13 under approval number 092439. This number indicates that the approval was given in accordance with the requirements of Regulation No. 13 with the 09 series of amendments incorporated. For vehicles of categories M₂ and M₃, this mark means that that type of vehicle has undergone the Type-II test.

Model B

(See paragraph 4.5. of this Regulation)

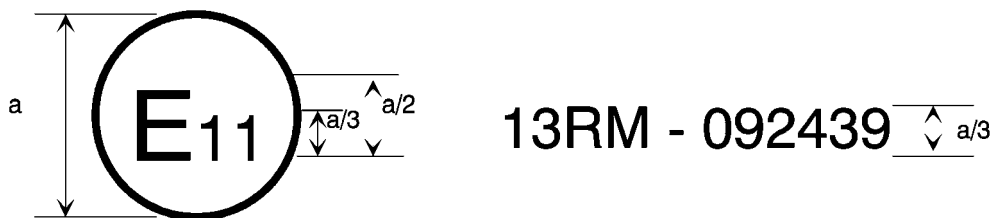

a = 8 mm min.

The above approval mark affixed to a vehicle shows that the vehicle type concerned has, with regard to braking, been approved in the United Kingdom (E 11) pursuant to Regulation No. 13. For vehicles of categories M₂ and M₃, this mark means that the type of vehicle has undergone the Type-IIA test.

Model C

(See paragraph 4.6. of this Regulation)

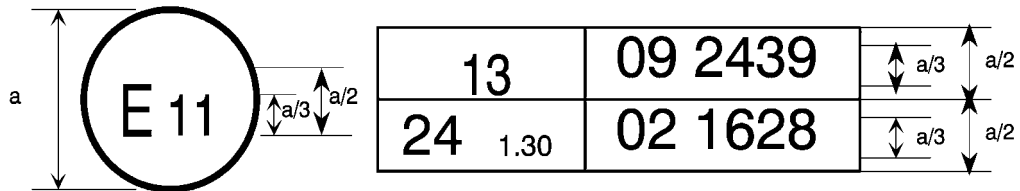

a = 8mm min.

The above approval mark affixed to a vehicle shows that the vehicle type concerned has been approved in the United Kingdom (E 11) pursuant to Regulations Nos. 13 and 24 1/. (In the case of the latter Regulation the corrected absorption coefficient is 1.30 m⁻¹.)

1/ This number is given merely as an example.

Annex 4

BRAKING TESTS AND PERFORMANCE OF BRAKING SYSTEMS

1. BRAKING TESTS

1.1. General

1.1.1. The performance prescribed for braking systems is based on the stopping distance and/or the mean fully developed deceleration. The performance of a braking system shall be determined by measuring the stopping distance in relation to the initial speed of the vehicle and/or by measuring the mean fully developed deceleration during the test.

1.1.2. The stopping distance shall be the distance covered by the vehicle from the moment when the driver begins to actuate the control of the braking system until the moment when the vehicle stops; the initial speed shall be the speed at the moment when the driver begins to actuate the control of the braking system; the initial speed shall not be less than 98 per cent of the prescribed speed for the test in question.

The mean fully developed deceleration (d_m) shall be calculated as the deceleration averaged with respect to distance over the interval v_b to v_e , according to the following formula:

$$d_m = \frac{v_b^2 - v_e^2}{25.92 (s_e - s_b)} \quad [\text{m/s}^2]$$

where:

v_o = initial vehicle speed in km/h,

v_b = vehicle speed at 0.8 v_o in km/h,

v_e = vehicle speed at 0.1 v_o in km/h,

s_b = distance travelled between v_o and v_b in metres,

s_e = distance travelled between v_o and v_e in metres.

The speed and the distance shall be determined using instrumentation having an accuracy of ± 1 per cent at the prescribed speed for the test. The mean fully developed deceleration may be determined by other methods than the measurement

of speed and distance; in this case, the accuracy of the mean fully developed deceleration shall be within ± 3 per cent.

- 1.2. For the approval of any vehicle, the braking performance shall be measured during road tests conducted in the following conditions:
 - 1.2.1. the vehicle's condition as regards mass must be as prescribed for each type of test and be specified in the test report;
 - 1.2.2. the test must be carried out at the speeds prescribed for each type of test; if the maximum design speed of a vehicle is lower than the speed prescribed for a test, the test shall be performed at the vehicle's maximum speed;
 - 1.2.3. during the tests, the force applied to the control of the braking system in order to obtain the prescribed performance must not exceed the maximum force laid down for the test vehicle's category;
 - 1.2.4. the road must have a surface affording good adhesion, unless specified otherwise in the relevant annexes;
 - 1.2.5. the tests must be performed when there is no wind liable to affect the results;
 - 1.2.6. at the start of the tests, the tyres must be cold and at the pressure prescribed for the load actually borne by the wheels when the vehicle is stationary;
 - 1.2.7. the prescribed performance must be obtained without locking of the wheels, without deviation of the vehicle from its course, and without abnormal vibration. 1/
 - 1.2.8. For vehicles powered completely or partially by an electric motor (or motors), permanently connected to the wheels, all tests must be carried out with the motor(s) connected.
 - 1.2.9. For vehicles as described in paragraph 1.2.8., fitted with an electric regenerative braking system of category A, behaviour tests defined in paragraph 1.4.3.1. of this annex shall be carried out on a track with a low adhesion coefficient (as defined in paragraph 5.2.2. of annex 13).
 - 1.2.9.1. Moreover, for vehicles fitted with an electric regenerative braking system of category A, transient conditions as gear changes or accelerator control release shall not affect the behaviour of the vehicle in condition of tests described in paragraph 1.2.9.

1/ Wheel-locking is permitted where specifically mentioned.

- 1.2.10. During the tests specified in paragraphs 1.2.9. and 1.2.9.1., wheel locking is not allowed. However, steering correction is permitted if the angular rotation of the steering control is within 120° during the initial 2 seconds and not more than 240° in total.
- 1.2.11. For a vehicle with electrically actuated service brakes powered from traction batteries (or an auxiliary battery) which receive(s) energy only from an independent external charging system, these batteries shall, during braking performance testing, be at an average of not more than 5 per cent above that state of charge at which the brake failure warning prescribed in paragraph 5.2.1.27.6. is required to be given.
- If this warning is given, the batteries may receive some recharge during the tests, to keep them in the required state of charge range.
- 1.3. Behaviour of the vehicle during braking
- 1.3.1. In braking tests, and in particular in those at high speed, the general behaviour of the vehicle during braking must be checked.
- 1.3.2. Behaviour of the vehicle during braking on a road on which adhesion is reduced. The behaviour of vehicles of categories M₁, M₂, M₃, N₁, N₂, N₃, O₃ and O₄ on a road on which adhesion is reduced, must meet the relevant requirements of annex 10 and/or annex 13 to this Regulation.
- 1.3.2.1. In the case of a braking system according to paragraph 5.2.1.7.2., where the braking for a particular axle (or axles) is comprised of more than one source of braking torque, and any individual source can be varied with respect to the other(s), the vehicle shall satisfy the requirements of annex 10, or alternatively, annex 13 under all relationships permitted by its control strategy. 2/
- 1.4. Type-0 test (ordinary performance test with brakes cold)
- 1.4.1. General
- 1.4.1.1. The brakes must be cold; a brake is deemed to be cold when the temperature measured on the disc or on the outside of the drum is below 100°C.
- 1.4.1.2. The test must be conducted in the following conditions:

2/ The manufacturer shall provide the Technical Service with the family of braking curves permitted by the automatic control strategy employed. These curves may be verified by the Technical Service.

1.4.1.2.1. the vehicle must be laden, the distribution of its mass among the axles being that stated by the manufacturer; where provision is made for several arrangements of the load on the axles the distribution of the maximum mass among the axles must be such that the load on each axle is proportional to the maximum permissible load for each axle. In the case of tractors for semi-trailers, the load may be re-positioned approximately half-way between the kingpin position resulting from the above loading conditions and the centreline of the rear axle(s);

1.4.1.2.2. every test must be repeated on the unladen vehicle. In the case of a power-driven vehicle there may be, in addition to the driver, a second person on the front seat who is responsible for noting the results of the test;

in the case of a tractor for a semi-trailer, the unladen tests will be conducted with the vehicle in its solo condition, including a mass representing the fifth wheel. It will also include a mass representing a spare wheel, if this is included in the standard specification of the vehicle;

in the case of a vehicle presented as a drawbar chassis-cab, a supplementary load may be added to simulate the mass of the body, not exceeding the minimum mass declared by the manufacturer in annex 2 to this Regulation;

In the case of a vehicle equipped with an electric regenerative braking system, the requirements depend on the category of this system:

Category A. Any separate electric regenerative braking control which is provided, shall not be used during the Type-0 tests.

Category B. The contribution of the electric regenerative braking system to the braking force generated shall not exceed that minimum level guaranteed by the system design.

This requirement is deemed to be satisfied if the batteries are at one of the following state of charge conditions where state of charge 3/ is determined by the method set out in appendix 1 to this annex:

at the maximum charge level as recommended by the manufacturer in the vehicle specification, or

3/ By agreement with the technical service, state of charge assessment will not be required for vehicles, which have an on-board energy source for charging the traction batteries and the means for regulating their state of charge.

at a level not less than 95 per cent of the full charge level, where the manufacturer has made no specific recommendation, or

at the maximum level which results from automatic charge control on the vehicle.

1.4.1.2.3. the limits prescribed for minimum performance, both for tests with the vehicle unladen and for tests with the vehicle laden, shall be those laid down hereunder for each category of vehicles; the vehicle must satisfy both the prescribed stopping distance and the prescribed mean fully developed deceleration for the relevant vehicle category, but it may not be necessary to actually measure both parameters.

1.4.1.2.4. The road must be level.

1.4.2. Type-0 test with engine disconnected

The test must be carried out at the speed prescribed for the category to which the vehicle belongs, the figures prescribed in this connection being subject to a certain margin of tolerance. The minimum performance prescribed for each category must be attained.

1.4.3. Type-0 test with engine connected

1.4.3.1. Tests must also be carried out at various speeds, the lowest being equal to 30 per cent of the maximum speed of the vehicle and the highest being equal to 80 per cent of that speed. In the case of vehicles equipped with a speed limiter, this limiter speed shall be taken as the maximum speed of the vehicle. The maximum practical performance figures shall be measured and the behaviour of the vehicle shall be recorded in the test report. Tractors for semi-trailers, artificially loaded to simulate the effects of a laden semi-trailer shall not be tested beyond 80 km/h.

1.4.3.2. Further tests shall be carried out with the engine connected, from the speed prescribed for the category to which the vehicle belongs. The minimum performance prescribed for each category must be attained. Tractive units for semi-trailers, artificially loaded to simulate the effects of a laden semi-trailer shall not be tested beyond 80 km/h.

1.4.4. Type-0 test for vehicles of category O, equipped with compressed-air brakes.

1.4.4.1. The braking performance of the trailer can be calculated either from the braking rate of the towing vehicle plus the trailer and the measured thrust on the coupling or, in certain cases, from the braking rate of the towing vehicle

plus the trailer with only the trailer being braked. The engine of the towing vehicle must be disconnected during the braking test.

In the case where only the trailer is braked, to take account of the extra mass being retarded, the performance will be taken to be the mean fully developed deceleration.

- 1.4.4.2. With the exception of cases according to paragraphs 1.4.4.3. and 1.4.4.4. of this annex, it is necessary for the determination of the braking rate of the trailer to measure the braking rate of the towing vehicle plus the trailer and the thrust on the coupling. The towing vehicle has to meet the requirements laid down in annex 10 to this Regulation with regard to the relationship between the ratio T_M/P_M and the pressure p_m . The braking rate of the trailer is calculated according to the following formula:

$$z_R = z_{R+M} + \frac{D}{P_R}$$

where:

z_R = braking rate of the trailer,

z_{R+M} = braking rate of the towing vehicle plus the trailer,

D = thrust on the coupling,
(tractive force: +D),
(compressive force: -D)

P_R = total normal static reaction between road surface and wheels of trailer (annex 10).

- 1.4.4.3. If a trailer has a continuous or semi-continuous braking system where the pressure in the brake actuators does not change during braking despite the dynamic axle load shifting and in the case of semi-trailers the trailer alone may be braked. The braking rate of the trailer is calculated according to the following formula:

$$z_R = (z_{R+M} - R) \cdot \frac{P_M + P_R}{P_R} + R$$

where:

R = rolling resistance value = 0.01

P_M = total normal static reaction between road surface and wheels of towing vehicles for trailers (annex 10)

1.4.4.4. Alternatively, the evaluation of the braking rate of the trailer may be done by braking the trailer alone. In this case the pressure used shall be the same as that measured in the brake actuators during the braking of the combination.

1.5. Type-I test (fade test)

1.5.1. With repeated braking

1.5.1.1. The service braking systems of all power-driven vehicles must be tested by successively applying and releasing the brakes a number of times, the vehicle being laden, in the conditions shown in the table below:

Category of vehicles	Conditions			
	v_1 [km/h]	v_2 [km/h]	Δt [sec]	n
M_1	80 % v_{max} ≤ 120	1/2 v_1	45	15
M_2	80 % v_{max} ≤ 100	1/2 v_1	55	15
N_1	80 % v_{max} ≤ 120	1/2 v_1	55	15
M_3, N_2, N_3	80 % v_{max} ≤ 60	1/2 v_1	60	20

where:

v_1 = initial speed, at beginning of braking

v_2 = speed at end of braking

v_{max} = maximum speed of vehicle

n = number of brake applications

Δt = duration of a braking cycle: time elapsing between the initiation of one brake application and the initiation of the next.

- 1.5.1.2. If the characteristics of the vehicle make it impossible to abide by the duration prescribed for Δt , the duration may be increased; in any event, in addition to the time necessary for braking and accelerating the vehicle, a period of 10 seconds must be allowed in each cycle for stabilizing the speed v_1 .
- 1.5.1.3. In these tests, the force applied to the control must be so adjusted as to attain the mean fully developed deceleration of 3 m/s^2 at the first brake application; this force must remain constant throughout the succeeding brake applications.
- 1.5.1.4. During brake applications, the highest gear ratio (excluding overdrive, etc.) must be continuously engaged.
- 1.5.1.5. For regaining speed after braking, the gearbox must be used in such a way as to attain the speed v_1 in the shortest possible time (maximum acceleration allowed by the engine and gearbox).
- 1.5.1.6. For vehicles not having sufficient autonomy to carry out the cycles of heating of the brakes, the tests shall be carried out by achieving the prescribed speed before the first braking application and thereafter by using the maximum acceleration available to regain speed and then braking successively at the speed reached at the end of each time cycle duration as specified, for the appropriate vehicle category, in paragraph 1.5.1.1. above.
- 1.5.1.7. In the case of vehicles equipped with automatic brake adjustment devices the adjustment of the brakes shall, prior to the Type-I test above, be set according to the following procedures as appropriate:
- 1.5.1.7.1. In the case of vehicles equipped with air operated brakes the adjustment of the brakes shall be such as to enable the automatic brake adjustment device to function. For this purpose the actuator stroke shall be adjusted to

$s_0 \geq 1.1 \cdot s_{\text{re-adjust}}$ (the upper limit shall not exceed a value recommended by the manufacturer)

where:

$s_{\text{re-adjust}}$ is the re-adjustment stroke according to the specification of the manufacturer of the automatic brake adjustment device, i.e. the stroke, where it starts to readjust the running clearance of the brake

with an actuator pressure of 15 per cent of the brake system operating pressure but not less than 100 kPa

Where, by agreement with the Technical Service, it is impractical to measure the actuator stroke, the initial setting shall be agreed with the Technical Service.

From the above condition the brake shall be operated with an actuator pressure of 30 per cent of the brake system operating pressure but not less than 200 kPa 50 times in succession. This shall be followed by a single brake application with an actuator pressure of \geq 650 kPa.

1.5.1.7.2. In the case of vehicles equipped with hydraulically operated disc brakes no setting requirements are deemed necessary.

1.5.1.7.3. In the case of vehicles equipped with hydraulically operated drum brakes the adjustment of the brakes shall be as specified by the manufacturer.

1.5.1.8. For vehicles equipped with an electric regenerative braking system of category B, the condition of the vehicle batteries at the start of the test, shall be such that the braking force contribution provided by the electric regenerative braking system does not exceed the minimum guaranteed by the system design.

This requirement is deemed to be satisfied if the batteries are at one of the state of charge conditions listed in the fourth clause of paragraph 1.4.1.2.2. above.

1.5.2. With continuous braking

1.5.2.1. The service brakes of trailers of categories O₂ and O₃ must be tested in such a manner that, the vehicle being laden, the energy input to the brakes is equivalent to that recorded in the same period of time with a laden vehicle driven at a steady speed of 40 km/h on a 7 per cent down-gradient for a distance of 1.7 km.

1.5.2.2. The test may be carried out on a level road, the trailer being drawn by a towing vehicle; during the test, the force applied to the control must be adjusted so as to keep the resistance of the trailer constant (7 per cent of the maximum total stationary axle load of the trailer). If the power available for hauling is insufficient, the test can be conducted at a lower speed but over a greater distance as shown in the table below:

Speed [km/h]	Distance [metres]
40	1,700
30	1,950
20	2,500
15	3,100

1.5.2.3. In the case of trailers equipped with automatic brake adjustment devices the adjustment of the brakes shall, prior to the Type-I test prescribed above, be set according to the procedure as laid down in paragraph 1.7.1.1. of this annex.

1.5.3. Hot performance

1.5.3.1. At the end of the Type-I test (test described in paragraph 1.5.1. or test described in paragraph 1.5.2. of this annex) the hot performance of the service braking system must be measured in the same conditions (and in particular at a constant control force no greater than the mean force actually used) as for the Type-0 test with the engine disconnected (the temperature conditions may be different).

1.5.3.1.1. For power-driven vehicles this hot performance must not be less than 80 per cent of that prescribed for the category in question, nor less than 60 per cent of the figure recorded in the Type-0 test with the engine disconnected.

1.5.3.1.2. For vehicles fitted with an electric regenerative braking system of category A, during brake applications, the highest gear shall be continuously engaged and the separate electric regenerative braking control, if any, shall not be used.

1.5.3.1.3. In the case of vehicles equipped with an electric regenerative braking system of category B, having carried out the heating cycles according to paragraph 1.5.1.6. of this annex, the hot performance test shall be carried out at the maximum speed which can be reached by the vehicle at the end of the brake heating cycles, unless the speed specified in paragraph 1.4.2. of this annex can be reached.

For comparison, the Type-0 test with cold brakes shall be repeated from this same speed and with a similar electric regenerative braking contribution, as set by an appropriate state of battery charge, as was available during the hot performance test.

Reconditioning of the linings shall be permitted before the test is made to compare this second Type-0 cold performance with that achieved in the hot test, against the criteria of paragraphs 1.5.3.1.1. and 1.5.3.2. of this annex.

1.5.3.1.4. However, in the case of trailers, the hot brake force at the periphery of the wheels when tested at 40 km/h must not be less than 36 per cent of the maximum stationary wheel load, nor less than 60 per cent of the figure recorded in the Type-0 test at the same speed.

1.5.3.2. In the case of a power-driven vehicle which satisfies the 60 per cent requirement specified in paragraph 1.5.3.1.1. above, but which cannot comply with the 80 per cent requirement of paragraph 1.5.3.1.1. above, a further hot performance test may be carried out using a control force not exceeding that specified in paragraph 2 of this annex for the relevant vehicle category. The results of both tests shall be entered in the report.

1.5.4. Free running test

In the case of motor vehicles equipped with automatic brake adjustment devices, the brakes after completing the tests defined in paragraph 1.5.3 above will be allowed to cool to a temperature representative of a cold brake (i.e. ≤ 100 °C) and it shall be verified that the vehicle is capable of free running by fulfilling one of the following conditions:

- a) Wheels are running freely (i.e. may be rotated by hand)
- b) It is ascertained that when the vehicle is driven at a constant speed of $v = 60$ km/h with the brakes released the asymptotic temperatures shall not exceed a drum/disc temperature increase of 80 °C, then the residual brake moments are regarded as acceptable.

1.6. Type-II test (downhill behaviour test)

1.6.1. Laden power-driven vehicles must be tested in such a manner that the energy input is equivalent to that recorded in the same period of time with a laden vehicle driven at an average speed of 30 km/h on a 6 per cent down-gradient for a distance of 6 km, with the appropriate gear engaged and the endurance braking system, if the vehicle is equipped with one, being used. The gear engaged must be such that the speed of the engine (min^{-1}) does not exceed the maximum value prescribed by the manufacturer.

1.6.2. For vehicles in which the energy is absorbed by the braking action of the engine alone, a tolerance of ± 5 km/h on the average speed shall be permitted, and the gear enabling the speed to be stabilized at the value closest to 30 km/h

on the 6 per cent down-gradient shall be engaged. If the performance of the braking action of the engine alone is determined by a measurement of deceleration, it shall be sufficient if the mean deceleration measured is at least 0.5 m/s^2 .

- 1.6.3. At the end of the test, the hot performance of the service braking system must be measured in the same conditions as for the Type-0 test with the engine disconnected (the temperature conditions may be different). This hot performance must give a stopping distance not exceeding the following values and a mean fully developed deceleration not less than the following values, using a control force not exceeding 70 daN,

category M_3 $0.15v + (1.33 v^2/130)$ (the second term corresponds to a mean fully developed deceleration $d_m = 3.75 \text{ m/s}^2$),

category N_3 $0.15v + (1.33 v^2/115)$ (the second term corresponds to a mean fully developed deceleration $d_m = 3.3 \text{ m/s}^2$).

- 1.6.4. Vehicles cited in paragraphs 1.8.1.1., 1.8.1.2. and 1.8.1.3. below must satisfy the Type-IIA test described in paragraph 1.8. below instead of the Type-II test.

- 1.7. Type-III test (fade test for vehicles of category O_4)

- 1.7.1. Track test

- 1.7.1.1. The adjustment of the brakes shall, prior to the Type-III test below, be set according to the following procedures as appropriate:

- 1.7.1.1.1. In the case of trailers equipped with air operated brakes the adjustment of the brakes shall be such as to enable the automatic brake adjustment device to function. For this purpose the actuator stroke shall be adjusted to $s_0 \geq 1.1 \cdot s_{re-adjust}$ (the upper limit shall not exceed a value recommended by the manufacturer)

where:

$s_{re-adjust}$ is the re-adjustment stroke according to the specification of the manufacturer of the automatic brake adjustment device, i.e. the stroke, where it starts to re-adjust the running clearance of the brake with an actuator pressure of **100 kPa**.

Where, by agreement with the Technical Service, it is impractical to measure the actuator stroke, the initial setting shall be agreed with the Technical Service.

From the above condition the brake shall be operated with an actuator pressure of ,200 kPa 50 times in succession. This shall be followed by a single brake application with an actuator pressure of ≥ 650 kPa.

1.7.1.1.2. In the case of trailers equipped with hydraulically operated disc brakes no setting requirements are deemed necessary.

1.7.1.1.3. In the case of trailers equipped with hydraulically operated drum brakes the adjustment of the brakes shall be as specified by the manufacturer.

1.7.1.2. For the road test the conditions shall be as follows:

Number of brake applications	20
Duration of a braking cycle	60 s
Initial speed at the beginning of braking	60 km/h
Braking applications	In these tests, the force applied to the control must be so adjusted as to attain the mean fully developed deceleration of 3 m/s^2 in respect to the trailer mass P_R at the first brake application; this force must remain constant throughout the succeeding brake applications.

The braking rate of a trailer is calculated according to the formula given in paragraph 1.4.4.3. of this annex:

$$z_R = (z_{R+M} - R) \cdot \frac{(P_M + P_R)}{P_R} + R$$

The speed at the end of braking (annex 11, appendix 2, paragraph 3.1.5.):

$$v_2 = v_1 \cdot \sqrt{\frac{P_M + P_1 + P_2/4}{P_M + P_1 + P_2}}$$

where:

- z_R - braking rate of the trailer
- z_{R+M} - braking rate of the vehicle combination (motor vehicle and trailer)
- R - rolling resistance value = 0,01
- P_M - total normal static reaction between the road surface and the wheels of towing vehicle for trailer (kg)

- P_R - total normal static reaction between the road surface and the wheels of trailer (kg)
- P_1 - part of the mass of the trailer borne by the unbraked axle(s) (kg)
- P_2 - part of the mass of the trailer borne by the braked axle(s) (kg)
- v_1 - initial speed (km/h)
- v_2 - final speed (km/h)

1.7.2. Hot performance

At the end of the test according to paragraph 1.7.1., the hot performance of the service braking system must be measured under the same conditions as for the Type-0 test with, however, different temperature conditions and starting from an initial speed of 60 km/h. The hot brake-force at the periphery of the wheels must then not be less than 40 per cent of the maximum stationary wheel load, and not less than 60 per cent of the figure recorded in the Type-0 test at the same speed.

1.7.3. Free running test

After completing the tests defined in paragraph 1.7.2, above, the brakes will be allowed to cool to a temperature representative of a cold brake (i.e. ≤ 100 °C) and it shall be verified that the trailer is capable of free running by fulfilling one of the following conditions:

- a) Wheels are running freely (i.e. may be rotated by hand)
- b) It is ascertained that when the trailer is driven at a constant speed of $v = 60$ km/h with the brakes released the asymptotic temperatures shall not exceed a drum/disc temperature increase of 80 °C, then the residual brake moments are regarded as acceptable.

1.8. Type-IIA test (endurance braking performance)

1.8.1. Vehicles of the following categories shall be subject to the Type-IIA test:

1.8.1.1. Interurban motor coaches and long distance touring motor coaches of category M_3 .

1.8.1.2. Vehicles of category N_3 which are authorized to tow a trailer of category O_4 . If the maximum mass exceeds 26 tonnes, the test mass is limited to 26 tonnes or, in the case where the unladen mass exceeds 26 tonnes, this mass is to be taken into account by calculation.

- 1.8.1.3. Certain vehicles subject to ADR (see annex 5).
- 1.8.2. Test conditions and performance requirements
- 1.8.2.1. The performance of the endurance braking system shall be tested at the maximum mass of the vehicle or of the vehicle combination.
- 1.8.2.2. Laden vehicles must be tested in such a manner that the energy input is equivalent to that recorded in the same period of time with a laden vehicle driven at an average speed of 30 km/h on a 7 per cent down-gradient for a distance of 6 km. During the test, the service, secondary and parking braking systems must not be engaged. The gear engaged must be such that the speed of the engine does not exceed the maximum value prescribed by the manufacturer. An integrated endurance braking system may be used, provided that it is suitably phased such that the service braking system is not applied; this may be verified by checking that its brakes remain cold, as defined in paragraph 1.4.1.1. of this annex.
- 1.8.2.3. For vehicles in which the energy is absorbed by the braking action of the engine alone, a tolerance of 5 km/h on the average speed shall be permitted, and the gear enabling the speed to be stabilized at a value closest to 30 km/h on a 7 per cent down-gradient shall be engaged. If the performance of the braking action of the engine alone is determined by measuring the deceleration, it shall be sufficient if the mean deceleration measured is at least 0.6 m/s².
2. PERFORMANCE OF BRAKING SYSTEMS OF VEHICLES OF CATEGORIES M AND N
- 2.1. Service braking system
- 2.1.1. The service brakes of vehicles of categories M and N shall be tested under the conditions shown in the following table:

Category	M ₁	M ₂	M ₃	N ₁	N ₂	N ₃	
Type of test	0-I	0-I	0-I-II or IIA	0-I	0-I	0-I-II	
v	80 km/h	60 km/h	60 km/h	80 km/h	60 km/h	60 km/h	
Type-0 test with engine disconnected	$s \leq 0.1v + \frac{v^2}{150}$	$0.15v + \frac{v^2}{130}$					
	$d_m \geq 5.8 \text{ m/s}^2$	5.0 m/s^2					
Type-0 test with engine connected	$v = 0.80 v_{\max}$ but not exceeding	160 km/h	100 km/h	90 km/h	120 km/h	100 km/h	90 km/h
	$s \leq 0.1v + \frac{v^2}{130}$	$0.15v + \frac{v^2}{103} \cdot 5$					
	$d_m \geq 5.0 \text{ m/s}^2$	4.0 m/s^2					
	$F \leq 50 \text{ daN}$	70 daN					

where:

- v = prescribed test speed, in km/h
s = stopping distance, in metres,
d_m = mean fully developed deceleration, in m/s²
F = force applied to foot control, in daN
v_{max} = maximum speed of the vehicle, in km/h

2.1.2. In the case of a power-driven vehicle authorized to tow an unbraked trailer, the minimum performance prescribed for the corresponding power-driven vehicle category (for the Type-0 test with engine disconnected) must be attained with the unbraked trailer coupled to the power-driven vehicle and with the unbraked trailer laden to the maximum mass declared by the power-driven vehicle manufacturer. However, in the case of category M₁ vehicles, the minimum combination performance shall be not less than 5.4 m/s² both in laden and unladen conditions.

The combination performance shall be verified by calculations referring to the maximum braking performance actually achieved by the power-driven vehicle alone (laden) during the Type-0 test with the engine disconnected, using the following formula (no practical tests with a coupled unbraked trailer are required):

$$d_{M+R} = d_M \cdot \frac{PM}{PM + PR}$$

where:

d_{M+R} = calculated mean fully developed deceleration of the power-driven vehicle when coupled to an unbraked trailer, in m/s^2 ,

d_M = maximum mean fully developed deceleration of the power-driven vehicle alone achieved during the Type-0 test with engine disconnected, in m/s^2 ,

PM = mass of the power-driven vehicle (laden),

PR = maximum mass of an unbraked trailer which may be coupled, as declared by the power-driven vehicle manufacturer.

2.2. Secondary braking system

2.2.1. The secondary braking system, even if the control which actuates it is also used for other braking functions, must give a stopping distance not exceeding the following values and a mean fully developed deceleration not less than the following values:

Category M_1 $0.1 v + (2v^2/150)$ (the second term corresponds to a mean fully developed deceleration $d_m = 2.9 m/s^2$)

Category M_2, M_3 $0.15 v + (2v^2/130)$ (the second term corresponds to a mean fully developed deceleration $d_m = 2.5 m/s^2$)

Category N $0.15 v + (2v^2/115)$ (the second term corresponds to a mean fully developed deceleration $d_m = 2.2 m/s^2$)

2.2.2. If the control is manual, the prescribed performance must be obtained by applying to the control a force not exceeding 40 daN in the case of vehicles of category M_1 , and 60 daN in the case of other vehicles, and the control must be so placed that it can be easily and quickly grasped by the driver.

2.2.3. If it is a foot control, the prescribed performance must be obtained by applying to the control a force not exceeding 50 daN in the case of vehicles of category M_1 , and 70 daN in the case of other vehicles, and the control must be so placed that it can be easily and quickly actuated by the driver.

2.2.4. The performance of the secondary braking system must be checked by the Type-0 test with engine disconnected from the following initial speeds:

M₁: 80 km/h M₂: 60 km/h M₃: 60 km/h

N₁: 70 km/h N₂: 50 km/h N₃: 40 km/h

- 2.2.5. The secondary braking effectiveness test shall be conducted by simulating the actual failure conditions in the service braking system.
- 2.2.6. For vehicles employing electric regenerative braking systems, the braking performance shall additionally be checked under the two following failure conditions:
- 2.2.6.1. For a total failure of the electric component of the service braking output.
- 2.2.6.2. In the case where the failure condition causes the electric component to deliver its maximum braking force.
- 2.3. Parking braking system
- 2.3.1. The parking braking system must, even if it is combined with one of the other braking systems, be capable of holding the laden vehicle stationary on an 18 per cent up or down-gradient.
- 2.3.2. On vehicles to which the coupling of a trailer is authorized, the parking braking system of the towing vehicle must be capable of holding the combination of vehicles stationary on a 12 per cent up or down-gradient.
- 2.3.3. If the control is manual, the force applied to it must not exceed 40 daN in the case of vehicles of category M₁, and 60 daN in the case of all other vehicles.
- 2.3.4. If it is a foot control, the force exerted on the control must not exceed 50 daN in the case of vehicles of category M₁, and 70 daN in the case of all other vehicles.
- 2.3.5. A parking braking system which has to be actuated several times before it attains the prescribed performance is admissible.
- 2.3.6. To check compliance with the requirement specified in paragraph 5.2.1.2.4. of this Regulation, a Type-0 test must be carried out with the engine disconnected at an initial test speed of 30 km/h. The mean fully developed deceleration on application of the control of the parking brake system and the deceleration immediately before the vehicle stops shall not be less than 1.5 m/s². The test shall be carried out with the laden vehicle.

The force exerted on the braking control device shall not exceed the specified values.

2.4. Residual braking after transmission failure

2.4.1. The residual performance of the service braking system, in the event of failure in a part of its transmission, must give a stopping distance not exceeding the following values and a mean fully developed deceleration not less than the following values, using a control force not exceeding 70 daN, when checked by the Type-0 test with the engine disconnected from the following initial speeds for the relevant vehicle category:

Stopping distance (m) and mean fully developed deceleration (d_m) [m/s^2]

Veh. Cat.	v [km/h]	Stopping dist. LADEN [m]	d_m [m/s^2]	Stopping dist. UNLADEN [m]	d_m [m/s^2]
M ₁	80	$0.10v + (100/30) \cdot (v^2/150)$	1.7	$0.10v + (100/25) \cdot (v^2/150)$	1.5
M ₂	60	$0.15v + (100/30) \cdot (v^2/130)$	1.5	$0.15v + (100/25) \cdot (v^2/130)$	1.3
M ₃	60	$0.15v + (100/30) \cdot (v^2/130)$	1.5	$0.15v + (100/30) \cdot (v^2/130)$	1.5
N ₁	70	$0.15v + (100/30) \cdot (v^2/115)$	1.3	$0.15v + (100/25) \cdot (v^2/115)$	1.1
N ₂	50	$0.15v + (100/30) \cdot (v^2/115)$	1.3	$0.15v + (100/25) \cdot (v^2/115)$	1.1
N ₃	40	$0.15v + (100/30) \cdot (v^2/115)$	1.3	$0.15v + (100/30) \cdot (v^2/115)$	1.3

2.4.2. The residual braking effectiveness test shall be conducted by simulating the actual failure conditions in the service braking system.

3. PERFORMANCE OF BRAKING SYSTEMS OF VEHICLES OF CATEGORY O

3.1. Service braking system

3.1.1. Provision relating to tests of vehicles of category O₁:

Where the provision of a service braking system is mandatory, the performance of the system must meet the requirements laid down for vehicles of categories O₂ and O₃.

3.1.2. Provisions relating to tests of vehicles of categories O₂ and O₃:

- 3.1.2.1. If the service braking system is of the continuous or semi-continuous type, the sum of the forces exerted on the periphery of the braked wheels shall be at least x per cent of the maximum stationary wheel load, x having the following values:

	<u>x [%]</u>
full trailer, laden and unladen	50
semi-trailer, laden and unladen	45
centre-axle trailer, laden and unladen	50

- 3.1.2.2. If the trailer is fitted with a compressed-air braking system, the pressure in the supply line shall not exceed 700 kPa during the brake test and the signal value in the control line shall not exceed the following values, depending on the installation:

- (a) 650 kPa in the pneumatic control line;
- (b) a digital demand value corresponding to 650 kPa (as defined in ISO 11992:2003 in the electric control line).

The test speed is 60 km/h. A supplementary test at 40 km/h shall be carried out with the laden trailer for comparison with the Type-I test result.

- 3.1.2.3. If the braking system is of the inertia type, it must comply with the requirements of annex 12 to this Regulation.

- 3.1.2.4. In addition, the vehicles must undergo the Type-I test.

- 3.1.2.5. In the Type-I test of a semi-trailer, the mass braked by the latter's axle(s) must correspond to the maximum axle load(s) (not including the king pin load).

- 3.1.3. Provisions relating to tests of vehicles of category O₄:

- 3.1.3.1. If the service braking system is of the continuous or semi-continuous type, the sum of the forces exerted on the periphery of the braked wheels shall be at least x per cent of the maximum stationary wheel load, x having the following values:

	<u>x [%]</u>
full trailer, laden and unladen	50
semi-trailer, laden and unladen	45
centre-axle trailer, laden and unladen	50

- 3.1.3.2. If the trailer is fitted with a compressed air braking system, the pressure in the control line must not exceed 650 kPa and the pressure in the supply line must not exceed 700 kPa during the brake test. The test speed is 60 km/h.

- 3.1.3.3. In addition, the vehicles must undergo the Type-III test.
- 3.1.3.4. In the Type-III test of a semi-trailer, the mass braked by the latter's axle(s) must correspond to the maximum axle load(s).
- 3.2. Parking braking system
- 3.2.1. The parking braking system with which the trailer is equipped must be capable of holding the laden trailer stationary, when separated from the towing vehicle, on an 18 per cent up or down-gradient. The force applied to the control device must not exceed 60 daN.
- 3.3. Automatic braking system
- 3.3.1. The automatic braking performance in the event of a failure, as described in paragraph 5.2.1.18.3. of this Regulation, when testing the laden vehicle from a speed of 40 km/h, shall not be less than 13.5 per cent of the maximum stationary wheel load. Wheel-locking at performance levels above 13.5 per cent is permitted.
4. RESPONSE TIME
- 4.1. Where a vehicle is equipped with a service braking system which is totally or partially dependent on a source of energy other than the muscular effort of the driver, the following requirements must be satisfied:
- 4.1.1. In an emergency manoeuvre, the time elapsing between the moment when the control device begins to be actuated and the moment when the braking force on the least favourably placed axle reaches the level corresponding to the prescribed performance must not exceed 0.6 seconds.
- 4.1.2. In the case of vehicles fitted with compressed-air braking systems, the requirements of paragraph 4.1.1. above are considered to be satisfied if the vehicle complies with the provisions of annex 6 to this Regulation.
- 4.1.3. In the case of vehicles fitted with hydraulic braking systems, the requirements of paragraph 4.1.1. above are considered to be satisfied if, in an emergency manoeuvre, the deceleration of the vehicle or the pressure at the least favourable brake cylinder, reaches a level corresponding to the prescribed performance within 0.6 seconds.
-

Annex 4 - Appendix

PROCEDURE FOR MONITORING THE STATE OF BATTERY CHARGE

This procedure is applicable to vehicle batteries used for traction and regenerative braking.

The procedure requires the use of a bi-directional DC Watt-hour meter.

1. Procedure
 - 1.1. If the batteries are new or have been subject to extended storage, they shall be cycled as recommended by the manufacturer. A minimum 8-hour soak period at ambient temperature shall be allowed after completion of cycling.
 - 1.2. A full charge shall be established using the manufacturer's recommended charging procedure.
 - 1.3. When the braking tests of paragraphs 1.2.11., 1.4.1.2.2., 1.5.1.6., and 1.5.3.1.3. of annex 4 are conducted the watt-hours consumed by the traction motors and supplied by the regenerative braking system shall be recorded as a running total which shall then be used to determine the state of charge existing at the beginning or end of a particular test.
 - 1.4. To replicate a level of state of charge in the batteries for comparative tests, such as those of paragraph 1.5.3.1.3., the batteries shall be either recharged to that level or charged to above that level and discharged into a fixed load at approximately constant power until the required state of charge is reached. Alternatively, for vehicles with battery powered electric traction only, the state of charge may be adjusted by running the vehicle. Tests conducted with a battery partially charged at their start shall be commenced as soon as possible after the desired state of charge has been reached.
-

Annex 5

ADDITIONAL PROVISIONS APPLICABLE TO CERTAIN VEHICLES
AS SPECIFIED IN THE ADR

1. SCOPE

This annex applies to certain vehicles for which the European Agreement concerning the International Carriage of Dangerous Goods by Road (ADR) contains specific requirements as concerns anti-lock and endurance braking performance.

2. REQUIREMENTS

2.1. General provisions

Power-driven vehicles and trailers intended for use as transport units for dangerous goods shall fulfil all relevant technical requirements of this Regulation. In addition, the following technical provisions shall apply as appropriate.

2.2. Anti-lock braking system of trailers

2.2.1. Trailers of category O₄ shall be equipped with category A anti-lock systems as defined in annex 13 of this Regulation.

2.3. Endurance braking system

2.3.1. Power-driven vehicles having a maximum mass exceeding 16 tonnes, or authorized to tow a trailer of category O₄ shall be fitted with an endurance braking system according to paragraph 2.14. of this Regulation which complies with the following requirements:

2.3.1.1. The endurance braking control configurations shall be from a type described in paragraphs 2.14.2.1. to 2.14.2.3. of this Regulation.

2.3.1.2. In the case of an electrical failure of the anti-lock system, integrated or combined endurance braking systems shall be switched off automatically.

2.3.1.3. The effectiveness of the endurance braking system shall be controlled by the anti-lock braking system such that the axle(s) braked by the endurance braking system cannot be locked by that system at speeds above 15 km/h. However, this requirement shall not apply to that part of the braking system constituted by the natural engine braking.

- 2.3.1.4. The endurance braking system shall comprise several stages of effectiveness, including a low stage appropriate for the unladen condition. Where the endurance braking system of a power-driven vehicle is constituted by its engine, the different gear ratios shall be considered to provide the different stages of effectiveness.
- 2.3.1.5. The performance of the endurance braking system must be such that it fulfils the requirements of paragraph 1.8. of annex 4 to this Regulation (Type-II A test), with a laden vehicle mass comprising the laden mass of the motor vehicle and its authorized maximum towed mass but not exceeding a total of 44 tonnes.
- 2.3.2. If a trailer is equipped with an endurance braking system it shall fulfil the requirements of paragraphs 2.3.1.1. to 2.3.1.4. above as appropriate.
-

Annex 6

METHOD OF MEASURING THE RESPONSE TIME ON VEHICLES EQUIPPED WITH COMPRESSED-AIR BRAKING SYSTEMS

1. GENERAL

- 1.1. The response times of the service braking system shall be determined on the stationary vehicle, the pressure being measured at the intake to the cylinder of the least favourably placed brake. In the case of vehicles fitted with combined compressed-air/hydraulic braking systems, the pressure may be measured at the opening of the least favourably placed pneumatic unit. For vehicles equipped with load sensing valves, these devices must be set in the "laden" position.
- 1.2. During the test, the stroke of the brake cylinders of the various axles shall be that required for brakes adjusted as closely as possible.
- 1.3. The response times determined in accordance with the provisions of this annex shall be rounded to the nearest tenth of a second. If the figure representing the hundredth is five or more, the response time shall be rounded up to the next higher tenth.

2. POWER-DRIVEN VEHICLES

- 2.1. At the beginning of each test, the pressure in the energy storage device shall be equal to the pressure at which the governor restores the feed to the system. In systems not equipped with a governor (e.g., pressure-limited compressors) the pressure in the energy storage device at the beginning of each test shall be 90 per cent of the pressure specified by the manufacturer and defined in paragraph 1.2.2.1. of Part A of annex 7 to this Regulation, used for the tests prescribed in this annex.
- 2.2. The response times as a function of the actuating time (t_f) shall be obtained by a succession of full actuations, beginning with the shortest possible actuating time and increasing to a time of about 0.4 seconds. The measured values shall be plotted on a graph.
- 2.3. The response time to be taken into consideration for the purpose of the test is that corresponding to an actuating time of 0.2 seconds. This response time can be obtained from the graph by interpolation.
- 2.4. For an actuating time of 0.2 seconds, the time elapsing from the initiation of the braking system control actuation to the moment when the pressure in the brake cylinder reaches 75 per cent of its asymptotic value shall not exceed 0.6 seconds.

2.5. In the case of power-driven vehicles having a pneumatic control line for trailers, in addition to the requirements of paragraph 1.1. of this annex, the response time must be measured at the extremity of a pipe 2.5 m long with an internal diameter of 13 mm which shall be joined to the coupling head of the control line of the service braking system. During this test, a volume of $385 \pm 5 \text{ cm}^3$ (which is deemed to be equivalent to the volume of a pipe 2.5 m long with an internal diameter of 13 mm and under a pressure of 650 kPa) shall be connected to the coupling head of the supply line. Tractors for semi-trailers must be equipped with flexible pipes for making the connection to semi-trailers. The coupling heads will, therefore, be at the extremity of those flexible pipes. The length and internal diameter of the pipes shall be entered at item 14.6. of the form conforming to the model in annex 2 to this Regulation.

2.6. The time elapsing from the initiation of brake-pedal actuation to the moment when

- (a) the pressure measured at the coupling head of the pneumatic control line,
- (b) the digital demand value in the electric control line measured according to ISO 11992:2003.

reaches x per cent of its asymptotic, respectively final, value shall not exceed the times shown in the table below:

x [%]	t [s]
10	0.2
75	0.4

2.7. In the case of power-driven vehicles authorized to tow trailers of category O₃ or O₄ fitted with compressed-air braking systems, in addition to the above-mentioned requirements, the prescriptions in paragraph 5.2.1.18.4.1 of this Regulation shall be verified by conducting the following test:

- (a) by measuring the pressure at the extremity of a pipe 2.5 m long with an internal diameter of 13 mm which shall be joined to the coupling head of the supply line;
- (b) by simulating a failure of the control line at the coupling head;
- (c) by actuating the service braking control device in 0.2 seconds, as described in paragraph 2.3. above.

3. TRAILERS

3.1. The trailer's response times shall be measured without the power-driven vehicle. To replace the power-driven vehicle, it is necessary to provide a simulator to which the

coupling heads of the supply line, the pneumatic control line and/or the connector of the electric control line are connected.

- 3.2. The pressure in the supply line shall be **650 kPa**.
- 3.3. The simulator for pneumatic control lines shall have the following characteristics:
 - 3.3.1. It must have a reservoir with a capacity of 30 litres which shall be charged to a pressure of **650 kPa** before each test and which must not be recharged during each test. At the outlet of the braking control device, the simulator must incorporate an orifice with a diameter of from 4.0 to 4.3 mm inclusive. The volume of the pipe measured from the orifice up to and including the coupling head shall be $385 \pm 5 \text{ cm}^3$ (which is deemed to be equivalent to the volume of a pipe 2.5 m long with an internal diameter of 13 mm and under a pressure of **650 kPa**). The control line pressures referred to in paragraph 3.3.3. of this annex shall be measured immediately downstream of the orifice.
 - 3.3.2. The braking system control must be so designed that its performance in use is not affected by the tester.
 - 3.3.3. The simulator must be set, e.g. through the choice of orifice in accordance with paragraph 3.3.1. of this annex in such a way that, if a reservoir of $385 \pm 5 \text{ cm}^3$ is joined to it, the time taken for the pressure to increase from **65 to 490 kPa** (10 and 75 per cent respectively of the nominal pressure of **650 kPa**) shall be 0.2 ± 0.01 seconds. If a reservoir of $1155 \pm 15 \text{ cm}^3$ is substituted for the above-mentioned reservoir, the time taken for the pressure to increase from **65 to 490 kPa** without further adjustment shall be 0.38 ± 0.02 seconds. Between these two pressure values, the pressure must increase in an approximately linear way. These reservoirs shall be connected to the coupling head without using flexible pipes and the connection shall have an internal diameter of not less than 10 mm.
 - 3.3.4. The diagrams in the appendix to this annex give an example of the correct configuration of the simulator for setting and use.
- 3.4. The simulator for checking the response to signals transmitted via the electric control line shall have the following characteristics:
 - 3.4.1. The simulator shall produce a digital demand signal in the electric control line according to ISO 11992-2:2003 and shall provide the appropriate information to the trailer via pins 6 and 7 of the ISO 7638:1997 connector. For the purpose of response time measurement the simulator may at the manufacturer's request transmit to the trailer information that no pneumatic control line is present and that the electric control line demand signal is generated from two independent circuits (see paragraphs 6.4.2.2.24. and 6.4.2.2.25 of ISO 11992-2:2003).

- 3.4.2. The braking system control must be so designed that its performance in use is not affected by the tester.
- 3.4.3. For the purpose of response time measurement the signal produced by the electric simulator shall be equivalent to a linear pneumatic pressure increase from **0.0 to 650 kPa** in 0.2 ± 0.01 seconds.
- 3.4.4. The diagrams in the appendix to this annex give an example of the correct configuration of the simulator for setting and use.
- 3.5. Performance requirements
- 3.5.1. For trailers with a pneumatic control line the time elapsing between the moment when the pressure produced in the control line by the simulator reaches **65 kPa** and the moment when the pressure in the brake actuator of the trailer reaches 75 per cent of its asymptotic value must not exceed 0.4 seconds.
- 3.5.1.1. Trailers equipped with a pneumatic control line and having electric control transmission shall be checked with the electrical power supplied to the trailer via the ISO 7638:1997 connector (5 or 7 pin).
- 3.5.2. For trailers with an electric control line the time elapsing between the moment when the signal produced by the simulator exceeds the equivalent of **65 kPa** and the moment when the pressure in the brake actuator of the trailer reaches 75 per cent of its asymptotic value must not exceed 0.4 seconds.
- 3.5.3. In the case of trailers equipped with a pneumatic and an electric control line, the response time measurement for each control line shall be determined independently according to the relevant procedure defined above.
-

Annex 6 - Appendix

EXAMPLE OF A SIMULATOR
(see annex 6, paragraph 3)

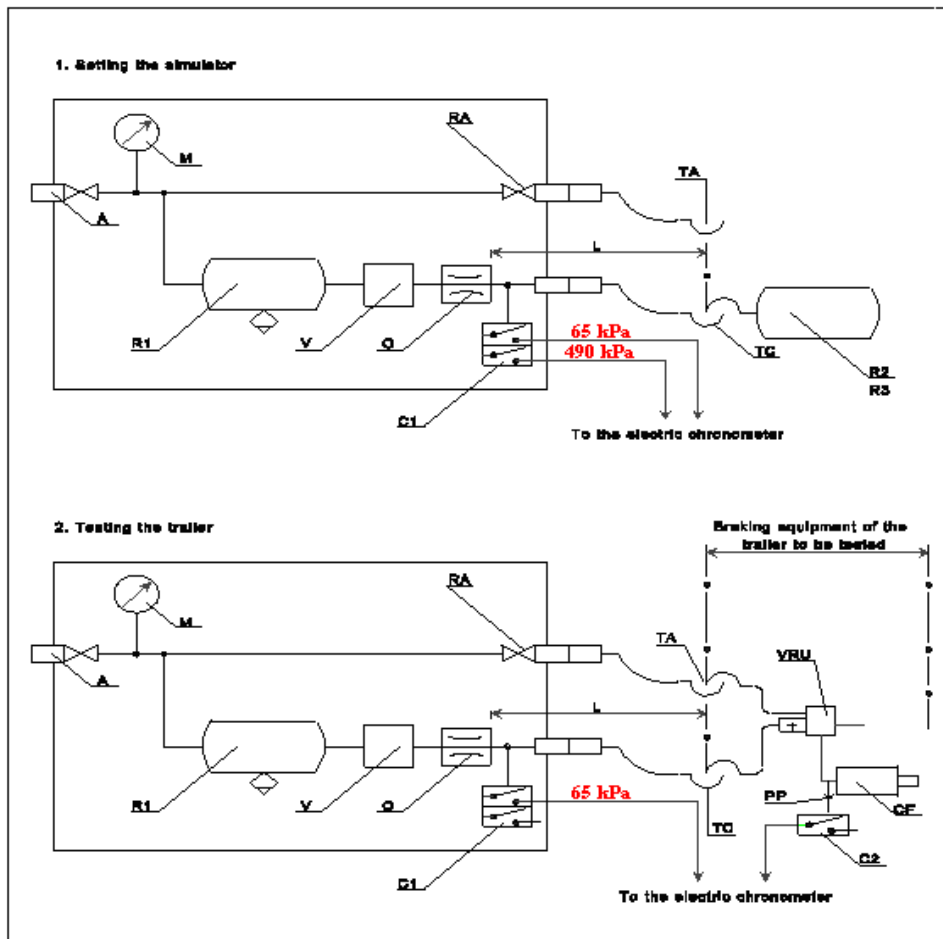

3. Example of a simulator for electric control lines

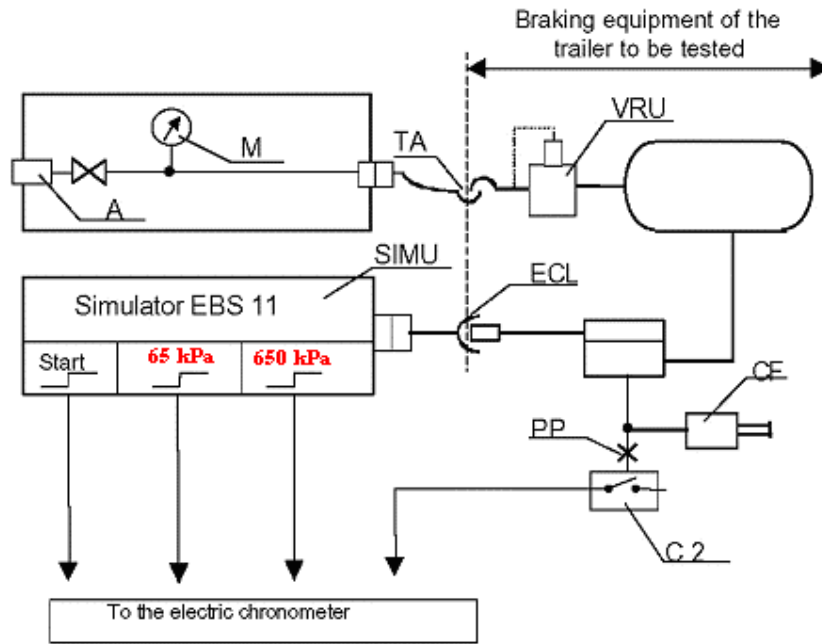

- ECL = electric control line corresponding to ISO 7638
- SIMU = simulator of Byte 3,4 of EBS 11 according to ISO 11992 with output signals at start, 65 kPa and 650 kPa.
- A = supply connection with shut-off valve
- C1 = pressure switch in the simulator, set at 65 kPa and at 490 kPa
- C2 = pressure switch to be connected to the brake actuator of the trailer, to operate at 75 per cent of the asymptotic pressure in the brake actuator CF
- CF = brake cylinder
- L = line from orifice O up to and including its coupling head TC, having an inner volume of $385 \pm 5 \text{ cm}^3$ under a pressure of 650 kPa
- M = pressure gauge
- O = orifice with a diameter of not less than 4 mm and not more than 4.3 mm

PP	=	pressure test connection
R1	=	30-litre air reservoir with drain valve
R2	=	calibrating reservoir, including its coupling head TC, to be $385 \pm 5 \text{ cm}^3$
R3	=	calibrating reservoir, including its coupling head TC, to be $1155 \pm 15 \text{ cm}^3$
RA	=	shut-off valve
TA	=	coupling head, supply line
TC	=	coupling head, control line
V	=	braking system control device
VRU	=	emergency relay valve

Annex 7

PROVISIONS RELATING TO ENERGY SOURCES AND ENERGY STORAGE DEVICES
(ENERGY ACCUMULATORS)

A. COMPRESSED-AIR BRAKING SYSTEMS

1. CAPACITY OF ENERGY STORAGE DEVICES (ENERGY ACCUMULATORS)
 - 1.1. General
 - 1.1.1. Vehicles on which the operation of the braking system requires the use of compressed-air shall be equipped with energy storage devices (energy accumulators) of a capacity meeting the requirements of paragraphs 1.2. and 1.3. of this annex (Part A).
 - 1.1.2. It must be possible to easily identify the reservoirs of the different circuits.
 - 1.1.3. However, the energy storage devices shall not be required to be of a prescribed capacity if the braking system is such that in the absence of any energy reserve it is possible to achieve a braking performance at least equal to that prescribed for the secondary braking system.
 - 1.1.4. In verifying compliance with the requirements of paragraphs 1.2. and 1.3. of this annex, the brakes shall be adjusted as closely as possible.
 - 1.2. Power-driven vehicles
 - 1.2.1. The energy storage devices (energy accumulators) of power-driven vehicles shall be such that after eight full-stroke actuations of the service braking system control the pressure remaining in the energy storage device(s) shall be not less than the pressure required to obtain the specified secondary braking performance.
 - 1.2.2. Testing shall be performed in conformity with the following requirements:
 - 1.2.2.1. the initial energy level in the energy storage device(s) shall be that specified by the manufacturer 1/. It shall be such as to enable the prescribed performance of the service braking system to be achieved;
 - 1.2.2.2. the energy storage device(s) shall not be fed; in addition, any energy storage device(s) for auxiliary equipment shall be isolated;

1/ The initial energy level shall be stated in the approval document.

1.2.2.3. In the case of power-driven vehicle to which the coupling of a trailer is authorized and with a pneumatic control line, the supply line shall be stopped and a compressed-air reservoir of 0.5 litre capacity shall be connected directly to the coupling head of the pneumatic control line. Before each braking operation, the pressure in this compressed-air reservoir shall be completely eliminated. After the test referred to in paragraph 1.2.1. above, the energy level supplied to the pneumatic control line shall not fall below a level equivalent to one-half the figure obtained at the first brake application.

1.3. Trailers

1.3.1. The energy storage devices (energy accumulators) with which trailers are equipped shall be such that, after eight full-stroke actuations of the towing vehicle's service braking system, the energy level supplied to the operating members using the energy does not fall below a level equivalent to one-half of the figure obtained at the first brake application and without actuating either the automatic or the parking braking system of the trailer.

1.3.2. Testing shall be performed in conformity with the following requirements:

1.3.2.1. the pressure in the energy storage devices at the beginning of each test shall be 850 kPa;

1.3.2.2. the supply line shall be stopped; in addition, any energy storage device(s) for auxiliary equipment shall be isolated;

1.3.2.3. the energy storage devices shall not be replenished during the test;

1.3.2.4. at each brake application, the pressure in the pneumatic control line shall be 750 kPa.

1.3.2.5. at each brake application, the digital demand value in the electric control line shall be corresponding to a pressure of 750 kPa.

2. CAPACITY OF ENERGY SOURCES

2.1. General

The compressors shall meet the requirements set forth in the following paragraphs.

2.2. Definitions

2.2.1. "p₁" is the pressure corresponding to 65 per cent of the pressure p₂ defined in paragraph 2.2.2. below.

- 2.2.2. "p₂" is the value specified by the manufacturer and referred to in paragraph 1.2.2.1. above.
- 2.2.3. "t₁" is the time required for the relative pressure to rise from 0 to p₁, and "t₂" is the time required for the relative pressure to rise from 0 to p₂.
- 2.3. Conditions of measurement
- 2.3.1. In all cases, the speed of the compressor shall be that obtained when the engine is running at the speed corresponding to its maximum power or at the speed allowed by the governor.
- 2.3.2. During the tests to determine the time t₁ and the time t₂, the energy storage device(s) for auxiliary equipment shall be isolated.
- 2.3.3. If it is intended to attach a trailer to a power-driven vehicle, the trailer shall be represented by an energy storage device whose maximum relative pressure p (expressed in kPa) is that which can be supplied through the towing vehicle's supply circuit and whose volume V, expressed in litres, is given by the formula $p \cdot V = 20 R$ (R being the permissible maximum mass, in tonnes, on the axles of the trailer).
- 2.4. Interpretation of results
- 2.4.1. The time t₁ recorded for the least-favoured energy storage device shall not exceed:
- 2.4.1.1. Three minutes in the case of vehicles to which the coupling of a trailer is not authorized; or
- 2.4.1.2. Six minutes in the case of vehicles to which the coupling of a trailer is authorized.
- 2.4.2. The time t₂ recorded for the least-favoured energy storage device shall not exceed:
- 2.4.2.1. Six minutes in the case of vehicles to which the coupling of a trailer is not authorized; or
- 2.4.2.2. Nine minutes in the case of vehicles to which the coupling of a trailer is authorized.
- 2.5. Additional test
- 2.5.1. If the power-driven vehicle is equipped with one or more energy storage devices for auxiliary equipment having a total capacity exceeding 20 per cent of the total capacity of the braking energy storage devices, an additional test shall be performed

during which no irregularity shall occur in the operation of the valves controlling the filling of the energy storage device(s) for auxiliary equipment.

- 2.5.2. It shall be verified during the aforesaid test that the time t_3 necessary to raise the pressure from 0 to p_2 in the least-favoured braking energy storage device is less than:
- 2.5.2.1. Eight minutes in the case of vehicles to which the coupling of a trailer is not authorized; or
- 2.5.2.2. Eleven minutes in the case of vehicles to which the coupling of a trailer is authorized.
- 2.5.3. The test shall be performed in the conditions prescribed in paragraphs 2.3.1. and 2.3.3. above.
- 2.6. Towing vehicles
- 2.6.1. Power-driven vehicles to which the coupling of a trailer is authorized shall also comply with the above requirements for vehicles not so authorized. In that case, the tests in paragraphs 2.4.1. and 2.4.2. (and 2.5.2.) of this annex will be conducted without the energy storage device mentioned in paragraph 2.3.3. above.

B. VACUUM BRAKING SYSTEMS

1. CAPACITY OF ENERGY STORAGE DEVICES (ENERGY ACCUMULATORS)
- 1.1. General
- 1.1.1. Vehicles on which operation of the braking system requires the use of a vacuum shall be equipped with energy storage devices (energy accumulators) of a capacity meeting the requirements of paragraphs 1.2. and 1.3. of this annex (Part B).
- 1.1.2. However, the energy storage devices shall not be required to be of a prescribed capacity if the braking system is such that in the absence of any energy reserve it is possible to achieve a braking performance at least equal to that prescribed for the secondary braking system.
- 1.1.3. In verifying compliance with the requirements of paragraphs 1.2. and 1.3. of this annex, the brakes shall be adjusted as closely as possible.
- 1.2. Power-driven vehicles

- 1.2.1. The energy storage devices (energy accumulators) of power-driven vehicles shall be such that it is still possible to achieve the performance prescribed for the secondary braking system:
- 1.2.1.1. after eight full-stroke actuations of the service braking system control where the energy source is a vacuum pump; and
- 1.2.1.2. after four full-stroke actuations of the service brake control where the energy source is the engine.
- 1.2.2. Testing shall be performed in conformity with the following requirements:
- 1.2.2.1. the initial energy level in the energy storage device(s) shall be that specified by the manufacturer. 1/ It shall be such as to enable the prescribed performance of the service braking system to be achieved and shall correspond to a vacuum not exceeding 90 per cent of the maximum vacuum furnished by the energy source;
- 1.2.2.2. the energy storage device(s) shall not be fed; in addition any energy storage device(s) for auxiliary equipment shall be isolated;
- 1.2.2.3. in the case of a power-driven vehicle authorized to tow a trailer, the supply line shall be stopped and an energy storage device of 0.5 litre capacity shall be connected to the control line. After the test referred to in paragraph 1.2.1. above, the vacuum level provided at the control line shall not have fallen below a level equivalent to one-half of the figure obtained at the first brake application.
- 1.3. Trailers (categories O₁ and O₂ only)
- 1.3.1. The energy storage devices (energy accumulators) with which trailers are equipped shall be such that the vacuum level provided at the user points shall not have fallen below a level equivalent to one-half of the value obtained at the first brake application after a test comprising four full-stroke actuations of the trailer's service braking system.
- 1.3.2. Testing shall be performed in conformity with the following requirements:
- 1.3.2.1. the initial energy level in the energy storage device(s) shall be that specified by the manufacturer. 1/ It shall be such as to enable the prescribed performance of the service braking system to be achieved;
- 1.3.2.2. the energy storage device(s) shall not be fed; in addition, any energy storage device(s) for auxiliary equipment shall be isolated.

1/ The initial energy level shall be stated in the approval document.

2. CAPACITY OF ENERGY SOURCES

2.1. General

2.1.1. Starting from the ambient atmospheric pressure, the energy source shall be capable of achieving in the energy storage device(s), in 3 minutes, the initial level specified in paragraph 1.2.2.1. above. In the case of a power-driven vehicle to which the coupling of a trailer is authorized, the time taken to achieve that level in the conditions specified in paragraph 2.2. below shall not exceed 6 minutes.

2.2. Conditions of measurement

2.2.1. The speed of the vacuum source shall be:

2.2.1.1. where the vacuum source is the vehicle engine, the engine speed obtained with the vehicle stationary, the neutral gear engaged and the engine idling;

2.2.1.2. where the vacuum source is a pump, the speed obtained with the engine running at 65 per cent of the speed corresponding to its maximum power output; and

2.2.1.3. where the vacuum source is a pump and the engine is equipped with a governor, the speed obtained with the engine running at 65 per cent of the maximum speed allowed by the governor.

2.2.2. Where it is intended to couple to the power-driven vehicle a trailer whose service braking system is vacuum-operated, the trailer shall be represented by an energy storage device having a capacity V in litres determined by the formula $V = 15 R$, where R is the maximum permissible mass, in tonnes, on the axles of the trailer.

C. HYDRAULIC BRAKING SYSTEMS WITH STORED ENERGY

1. CAPACITY OF ENERGY STORAGE DEVICES (ENERGY ACCUMULATORS)

1.1. General

1.1.1. Vehicles on which operation of the braking system requires the use of stored energy provided by hydraulic fluid under pressure shall be equipped with energy storage devices (energy accumulators) of a capacity meeting the requirements of paragraph 1.2. of this annex (Part C).

- 1.1.2. However, the energy storage devices shall not be required to be of a prescribed capacity if the braking system is such that in the absence of any energy reserve it is possible with the service braking system control to achieve a braking performance at least equal to that prescribed for the secondary braking system.
- 1.1.3. In verifying compliance with the requirements of paragraphs 1.2.1., 1.2.2. and 2.1. of this annex, the brakes shall be adjusted as closely as possible and, for paragraph 1.2.1., the rate of full-stroke actuations must be such as to provide an interval of at least 60 seconds between each actuation.
- 1.2. Power-driven vehicles
- 1.2.1. Power-driven vehicles equipped with a hydraulic braking system with stored energy shall meet the following requirements:
- 1.2.1.1. After eight full-stroke actuations of the service braking system control, it shall still be possible to achieve, on the ninth application, the performance prescribed for the secondary braking system.
- 1.2.1.2. Testing shall be performed in conformity with the following requirements:
- 1.2.1.2.1. testing shall commence at a pressure that may be specified by the manufacturer but is not higher than the cut-in pressure;
- 1.2.1.2.2. the energy storage device(s) shall not be fed; in addition, any energy storage device(s) for auxiliary equipment shall be isolated.
- 1.2.2. Power-driven vehicles equipped with a hydraulic braking system with stored energy which cannot meet the requirements of paragraph 5.2.1.5.1. of this Regulation shall be deemed to satisfy that paragraph if the following requirements are met:
- 1.2.2.1. After any single transmission failure it shall still be possible after eight full-stroke actuations of the service braking system control, to achieve, at the ninth application, at least the performance prescribed for the secondary braking system or, where secondary performance requiring the use of stored energy is achieved by a separate control, it shall still be possible after eight full-stroke actuations to achieve, at the ninth application, the residual performance prescribed in paragraph 5.2.1.4. of this Regulation.

1.2.2.2. Testing shall be performed in conformity with the following requirements:

1.2.2.2.1. with the energy source stationary or operating at a speed corresponding to the engine idling speed, any transmission failure may be induced. Before inducing such a failure, the energy storage device(s) shall be at a pressure that may be specified by the manufacturer but not exceeding the cut-in pressure;

1.2.2.2.2. the auxiliary equipment and its energy storage devices, if any, shall be isolated.

2. CAPACITY OF HYDRAULIC FLUID ENERGY SOURCES

2.1. The energy sources shall meet the requirements set out in the following paragraphs:

2.1.1. Definitions

2.1.1.1. "p₁" represents the maximum system operational pressure (cut-out pressure) in the energy storage device(s) specified by the manufacturer.

2.1.1.2. "p₂" represents the pressure after four full-stroke actuations with the service braking system control, starting at p₁, without having fed the energy storage device(s).

2.1.1.3. "t" represents the time required for the pressure to rise from p₂ to p₁ in the energy storage device(s) without application of the service braking system control.

2.1.2. Conditions of measurement

2.1.2.1. During the test to determine the time t, the feed rate of the energy source shall be that obtained when the engine is running at the speed corresponding to its maximum power or at the speed allowed by the over-speed governor.

2.1.2.2. During the test to determine the time t, energy storage device(s) for auxiliary equipment shall not be isolated other than automatically.

2.1.3. Interpretation of results

2.1.3.1. In the case of all vehicles except those of categories M₃, N₂ and N₃, the time t shall not exceed 20 seconds.

2.1.3.2. In the case of vehicles of categories M₃, N₂ and N₃, the time t shall not exceed 30 seconds.

3. CHARACTERISTICS OF WARNING DEVICES

With the engine stationary and commencing at a pressure that may be specified by the manufacturer but does not exceed the cut-in pressure, the warning device shall not operate following two full-stroke actuations of the service braking system control.

Annex 8

PROVISIONS RELATING TO SPECIFIC CONDITIONS FOR SPRING BRAKING SYSTEMS

1. DEFINITION

- 1.1. "Spring braking systems" are braking systems in which the energy required for braking is supplied by one or more springs acting as an energy storage device (energy accumulator).
- 1.1.1. The energy necessary to compress the spring in order to release the brake is supplied and controlled by the "control" actuated by the driver (see definition in paragraph 2.4. of this Regulation).
- 1.2. "Spring compression chamber" means the chamber where the pressure variation that induces the compression of the spring is actually produced.
- 1.3. If the compression of the springs is obtained by means of a vacuum device, "pressure" shall mean negative pressure everywhere in this annex.

2. GENERAL

- 2.1. A spring braking system shall not be used as a service braking system. However, in the event of a failure in a part of the transmission of the service braking system, a spring braking system may be used to achieve the residual performance prescribed in paragraph 5.2.1.4. of this Regulation provided that the driver can graduate this action. In the case of power-driven vehicles, with the exception of tractors for semi-trailers meeting the requirements specified in paragraph 5.2.1.4.1 of this Regulation, the spring braking system shall not be the sole source of residual braking. Vacuum spring braking systems shall not be used for trailers.
- 2.2. A small variation in any of the pressure limits which may occur in the spring compression chamber feed circuit shall not cause a significant variation in the braking force.
- 2.3. The feed circuit to the spring compression chamber must either include an own energy reserve or must be fed from at least two independent energy reserves. The trailer supply line may be branched from this feed line under the condition that a pressure drop in the trailer supply line must not be able to apply the spring brake actuators. Auxiliary equipment may only draw its energy from the feed line for the spring brake actuators under the condition that its operation, even in the event of damage to the energy source, cannot cause the energy reserve for the spring brake actuators to fall below a level from which one release of the spring brake actuators is

possible. In any case, during re-charging of the braking system from zero pressure, the spring brakes must not release until the pressure in the service braking system is sufficient to ensure at least the prescribed secondary braking performance of the laden vehicle, using the service braking system control. Similarly, once applied, the spring brakes must not release unless there is sufficient pressure in the service braking system to at least provide the prescribed residual braking performance of the laden vehicle by application of the service braking control. This paragraph does not apply to trailers.

- 2.4. In power-driven vehicles, the system must be so designed that it is possible to apply and release the brakes at least three times if the initial pressure in the spring compression chamber is equal to the maximum design pressure. In the case of trailers, it must be possible to release the brakes at least three times after the trailer has been uncoupled, the pressure in the supply line being 750 kPa before the uncoupling. However, prior to the check the emergency brake shall be released. These conditions must be satisfied when the brakes are adjusted as closely as possible. In addition, it must be possible to apply and release the parking braking system as specified in paragraph 5.2.2.10. of this Regulation when the trailer is coupled to the towing vehicle.
- 2.5. For power-driven vehicles, the pressure in the spring compression chamber beyond which the springs begin to actuate the brakes, the latter being adjusted as closely as possible, shall not be greater than 80 per cent of the minimum level of the normal available pressure.
- In the case of trailers, the pressure in the spring compression chamber beyond which the springs begin to actuate the brakes must not be greater than that obtained after four full-stroke actuations of the service braking system in accordance with paragraph 1.3 of Part A of annex 7 to this Regulation. The initial pressure is fixed at 700 kPa.
- 2.6. When the pressure in the line feeding energy to the spring compression chamber - excluding lines of an auxiliary release device using a fluid under pressure - falls to the level at which the brake parts begin to move, an optical or audible warning device shall be actuated. Provided this requirement is met, the warning device may comprise the red warning signal specified in paragraph 5.2.1.29.1.1. of this Regulation. This provision does not apply to trailers.
- 2.7. If a power-driven vehicle authorized to tow a trailer with a continuous or semi-continuous braking system is fitted with a spring braking system, automatic application of the said system shall cause application of the trailer's brakes.

3. RELEASE SYSTEM

- 3.1. A spring braking system must be so designed that, in the event of a failure in that system, it is still possible to release the brakes. This may be achieved by the use of an auxiliary release device (pneumatic, mechanical, etc.).

Auxiliary release devices using an energy reserve for releasing must draw their energy from an energy reserve which is independent from the energy reserve normally used for the spring braking system. The pneumatic or hydraulic fluid in such an auxiliary release device may act on the same piston surface in the spring compression chamber which is used for the normal spring braking system under the condition that the auxiliary release device uses a separate line. The junction of this line with the normal line connecting the control device with the spring brake actuators shall be at each spring brake actuator immediately before the port to the spring compression chamber, if not integrated in the body of the actuator. This junction shall include a device which prevents an influence of one line on the other. The requirements of paragraph 5.2.1.6. of this Regulation also apply to this device.

- 3.1.1. For the purposes of the requirement of paragraph 3.1. above, components of the braking system transmission shall not be regarded as subject to failure if under the terms of paragraph 5.2.1.2.7. of this Regulation they are not regarded as liable to breakage, provided that they are made of metal or of a material having similar characteristics and do not undergo significant distortion in normal braking.
- 3.2. If the operation of the auxiliary device referred to in paragraph 3.1. above requires the use of a tool or spanner, the tool or spanner shall be kept on the vehicle.
-

Annex 9

PROVISIONS RELATING TO PARKING BRAKING SYSTEMS EQUIPPED WITH A
MECHANICAL BRAKE-CYLINDER LOCKING DEVICE (Lock actuators)

1. DEFINITION

"Mechanical brake-cylinder locking device" means a device which ensures braking operation of the parking braking system by mechanically locking the brake piston rod. Mechanical locking is effected by exhausting the compressed fluid held in the locking chamber; it is so designed that unlocking can be effected by restoring pressure in the locking chamber.

2. SPECIAL REQUIREMENTS

- 2.1. When the pressure in the locking chamber approaches the level at which mechanical locking occurs, an optical or audible warning device shall come into action. Provided this requirement is met, the warning device may comprise the red warning signal specified in paragraph 5.2.1.29.1.1. of this Regulation. This provision shall not apply to trailers.

In the case of trailers, the pressure corresponding to mechanical locking must not exceed **400 kPa**. It must be possible to achieve parking braking performance after any single failure of the trailer service braking system. In addition, it must be possible to release the brakes at least three times after the trailer has been uncoupled, the pressure in the supply line being **650 kPa** before the uncoupling. These conditions must be satisfied when the brakes are adjusted as closely as possible. It must also be possible to apply and release the parking braking system as specified in paragraph 5.2.2.10. of this Regulation when the trailer is coupled to the towing vehicle.

- 2.2. In cylinders equipped with a mechanical locking device, movement of the brake piston shall be ensured by energy from either of two independent energy storage devices.
- 2.3. It shall not be possible to release the locked brake cylinder unless it is certain that after such release the brake can be applied again.
- 2.4. In the event of a failure of the energy source feeding the locking chamber, an auxiliary release device (e.g. mechanical, or pneumatic which may use the air contained in one of the vehicle's tyres) shall be available.

- 2.5. The control must be such that, when actuated, it performs the following operations in sequence: it applies the brakes so as to provide the degree of efficiency required for parking braking, locks the brakes in that position and then cancels out the brake application force.
-

Annex 10

DISTRIBUTION OF BRAKING AMONG THE AXLES OF VEHICLES
AND REQUIREMENTS FOR COMPATIBILITY BETWEEN
TOWING VEHICLES AND TRAILERS

1. GENERAL REQUIREMENTS

- 1.1. Vehicles of categories M, N, O₃ and O₄ which are not equipped with an anti-lock system as defined in annex 13 to this Regulation shall meet all the requirements of this annex. If a special device is used, this must operate automatically.

However, vehicles - other than those of category M₁ - which are equipped with an anti-lock system as defined in annex 13, shall also meet the requirements of paragraphs 7. and 8. of this annex if they are in addition fitted with a special automatic device which controls the distribution of braking among the axles. In the event of failure of its control, it shall be possible to stop the vehicle as stipulated under paragraph 6. of this annex.

- 1.2. The requirements relating to the diagrams specified in paragraphs 3.1.5., 3.1.6., 4.1., 5.1. and 5.2. of this annex, are valid both for power-driven vehicles with a pneumatic control line according to paragraph 5.1.3.1.1. of this Regulation and for power-driven vehicles with an electric control line according to paragraph 5.1.3.1.3. of this Regulation. In both cases, the reference value (abscissa of the diagrams) will be the value of the transmitted pressure in the control line: for vehicles equipped according to paragraph 5.1.3.1.1. of this Regulation, this will be the actual pneumatic pressure in the control line (p_m); for vehicles equipped according to paragraph 5.1.3.1.3. of this Regulation, this will be the pressure corresponding to the transmitted digital demand value in the electric control line, according to ISO/DIS 11992:[1996]. Vehicles equipped according to paragraph 5.1.3.1.2. of this Regulation (with both pneumatic and electric control lines) shall satisfy the requirements of the diagrams related to both control lines. However, identical braking characteristic curves related to both control lines are not required.
- 1.3. In the case of vehicles of category O with pneumatic braking systems, when the alternative type approval procedure defined in annex 20 is utilised, the relevant calculations required in this annex shall be made using the performance characteristics obtained from the relevant annex 19 verification reports and the centre of gravity height determined by the method defined in annex 20, appendix 1.

2. SYMBOLS

i	=	axle index ($i = 1$, front axle; $i = 2$, second axle; etc.)
P_i	=	normal reaction of road surface on axle i under static conditions
N_i	=	normal reaction of road surface on axle i under braking
T_i	=	force exerted by the brakes on axle i under normal braking conditions on the road
f_i	=	T_i/N_i , adhesion utilized by axle i <u>1/</u>
J	=	deceleration of vehicle
g	=	acceleration due to gravity: $g = 10 \text{ m/s}^2$
z	=	braking rate of vehicle = J/g <u>2/</u>
P	=	mass of vehicle
h	=	height above ground of centre of gravity specified by the manufacturer and agreed by the Technical Services conducting the approval test
E	=	wheelbase
k	=	theoretical coefficient of adhesion between tyre and road
K_c	=	correction factor: semi-trailer laden
K_v	=	correction factor: semi-trailer unladen
T_M	=	sum of braking forces at the periphery of all wheels of towing vehicles for trailers
P_M	=	total normal static reaction of road surface on wheels of towing vehicles for trailers <u>3/</u>

1/ "Adhesion utilization curves" of a vehicle means curves showing, for specified load conditions, the adhesion utilized by each axle i plotted against the braking rate of the vehicle.

2/ For semi-trailers, z is the braking force divided by the static load on the semi-trailer axle(s).

3/ As referred to in paragraph 1.4.4.3. of annex 4 to this Regulation.

- p_m = pressure at coupling head of control line
- T_R = sum of braking forces at periphery of all wheels of trailer
- P_R = total normal static reaction of road surface on all wheels of trailer 4/
- $P_{R\max}$ = value of P_R at maximum mass of trailer
- E_R = distance between king-pin and centre of axle or axles of semi-trailer
- h_R = height above ground of centre of gravity of semi-trailer specified by the manufacturer and agreed by the technical services conducting the approval test

3. REQUIREMENTS FOR POWER-DRIVEN VEHICLES

3.1. Two-axled vehicles

3.1.1. For all categories of vehicles for k values between 0.2 and 0.8: 5/

$$z \geq 0.10 + 0.85 (k - 0.20)$$

3.1.2. For all states of load of the vehicle, the adhesion utilization curve of the rear axle shall not be situated above that for the front axle:

3.1.2.1. for all braking rates between 0.15 and 0.80 in the case of vehicles of category M_1 .

However, for vehicles of this category in the range of z values between 0.30 and 0.45, an inversion of the adhesion utilization curves is permitted provided that the adhesion utilization curve of the rear axle does not exceed by more than 0.05 the line defined by the formula $k = z$ (line of ideal adhesion utilization - see diagram 1A of this annex);

4/ As referred to in paragraph 1.4.4.2. of annex 4 to this Regulation.

5/ The provisions of paragraph 3.1.1. do not affect the requirements of annex 4 to this Regulation relating to the braking performance. However, if, in tests made under the provisions of paragraph 3.1.1., braking performances are obtained which are higher than those prescribed in annex 4, the provisions relating to the adhesion utilization curves shall be applied within the areas of diagrams 1A, 1B and 1C of this annex defined by the straight lines $k = 0.8$ and $z = 0.8$.

- 3.1.2.2. for all braking rates between 0.15 and 0.50 in the case of vehicles of category N₁. 6/

This condition is also considered satisfied if, for braking rates between 0.15 and 0.30, the adhesion utilization curves for each axle are situated between two lines parallel to the line of ideal adhesion utilization given by the equation $k = z \pm 0.08$ as shown in diagram 1C of this annex where the adhesion utilization curve for the rear axle may cross the line $k = z - 0.08$; and complies for a braking rate between 0.30 and 0.50, with the relation $z \geq k - 0.08$; and between 0.50 and 0.61 with the relation $z \geq 0.5k + 0.21$.

- 3.1.2.3. for all braking rates between 0.15 and 0.30 in the case of vehicles of other categories.

This condition is also considered satisfied if, for braking rates between 0.15 and 0.30, the adhesion utilization curves for each axle are situated between two lines parallel to the line of ideal adhesion utilization given by the equation $k = z \pm 0.08$ as shown in diagram 1B of this annex and the adhesion utilization curve for the rear axle for braking rates $z \geq 0.3$ complies with the relation

$$z \geq 0.3 + 0.74 (k - 0.38).$$

- 3.1.3. In the case of a power-driven vehicle authorized to tow trailers of category O₃ or O₄ fitted with compressed-air braking systems.

- 3.1.3.1. When tested with the energy source stopped, the supply line blocked off, a reservoir of 0.5 litre capacity connected to the pneumatic control line, and the system at cut-in and cut-out pressures, the pressure at full application of the braking control shall be between 650 and 850 kPa at the coupling heads of the supply line and the pneumatic control line, irrespective of the load condition of the vehicle.

- 3.1.3.2. For vehicles equipped with an electric control line; a full application of the control of the service braking system shall provide a digital demand value corresponding to a pressure between 650 and 850 kPa (see ISO 11992:2003).

- 3.1.3.3. These values shall be demonstrably present in the power-driven vehicle when uncoupled from the trailer. The compatibility bands in the diagrams specified in paragraphs 3.1.5., 3.1.6., 4.1., 5.1. and 5.2. of this annex, should not be extended beyond 750 kPa and/or the corresponding digital demand value (see ISO 11992:2003).

6/ Vehicles of category N₁ with a laden/unladen rear axle loading ratio not exceeding 1.5 or having a maximum mass of less than 2 tonnes will have to comply with the requirements for category M₁ vehicles laid down in paragraph 3.1.2.1. of this annex as from 1 October 1990.

3.1.3.4. It must be ensured that at the coupling head of the supply line a pressure of at least **700 kPa** is available when the system is at cut-in pressure. This pressure shall be demonstrated without applying the service brakes.

3.1.4. Verification of the requirements of paragraphs 3.1.1. and 3.1.2.

3.1.4.1. In order to verify the requirements of paragraphs 3.1.1. and 3.1.2. of this annex, the manufacturer shall provide the adhesion utilization curves for the front and rear axles calculated by the formulae:

$$f_1 = \frac{T_1}{N_1} = \frac{T_1}{P_1 + z \cdot \frac{h}{E} \cdot P \cdot g}$$

$$f_2 = \frac{T_2}{N_2} = \frac{T_2}{P_2 - z \cdot \frac{h}{E} \cdot P \cdot g}$$

The curves shall be plotted for both the following load conditions:

3.1.4.1.1. unladen, in running order with the driver on board; in the case of a vehicle presented as a chassis-cab, a supplementary load may be added to simulate the mass of the body, not exceeding the minimum mass declared by the manufacturer in annex 2 to this Regulation,

3.1.4.1.2. laden; where provision is made for several possibilities of load distribution, the one whereby the front axle is the most heavily laden shall be the one considered.

3.1.4.2. If it is not possible, for vehicles with (permanent) all-wheel drive, to carry out the mathematical verification pursuant to paragraph 3.1.4.1., the manufacturer may instead verify by means of a wheel lock sequence test that, for all braking rates between 0.15 and 0.8, lockup of the front wheels occurs either simultaneously with or before the lockup of the rear wheels.

3.1.4.3. Procedure to verify the requirements of paragraph 3.1.4.2.

3.1.4.3.1. The wheel lock sequence test shall be conducted on road surfaces with a coefficient of adhesion of not more than 0.3 and of about 0.8 (dry road) from the initial test speeds specified in paragraph 3.1.4.3.2.

3.1.4.3.2. Test speeds:

60 km/h, but not exceeding $0.8 v_{\max}$ for decelerations on low coefficient of friction road surfaces;

80 km/h, but not exceeding v_{\max} for decelerations on high coefficient of friction road surfaces.

3.1.4.3.3. The pedal force applied may exceed the permissible actuation forces pursuant to annex 4, paragraph 2.1.1.

3.1.4.3.4. Pedal force is applied and increased such that the second wheel on the vehicle will reach lockup between 0.5 and 1 s after initiating the brake application, until lockup of both wheels on one axle occurs (additional wheels may also lock during the test, e.g. in the case of simultaneous lockup).

3.1.4.4. The tests prescribed in paragraph 3.1.4.2. shall be carried out twice on each road surface. If the result of one test fails, a third, hence decisive test shall be carried out.

3.1.4.5. For vehicles fitted with an electric regenerative braking system of category B, where the electric regenerative braking capacity is influenced by the electric state of charge, the curves shall be plotted by taking account of the electric regenerative braking component under the minimum and maximum conditions of delivered braking force. This requirement is not applicable if the vehicle is equipped with an anti-lock device which controls the wheels connected to the electric regenerative braking and shall be replaced by the requirements of annex 13.

3.1.5. Towing vehicles other than tractors for semi-trailers

3.1.5.1. In the case of a power-driven vehicle authorized to tow trailers of category O₃ or O₄ fitted with a compressed air braking system, the permissible relationship between the braking rate T_M/P_M and the pressure p_m shall lie within the areas shown on diagram 2 of this annex for all pressures between 20 and 750 kPa.

3.1.6. Tractors for semi-trailers

3.1.6.1. Tractors with unladen semi-trailer. An unladen combination is understood to be a tractor in running order, with the driver on board, coupled to an unladen semi-trailer. The dynamic load of the semi-trailer on the tractor shall be represented by a static mass P_s mounted at the fifth wheel coupling equal to 15 per cent of the maximum mass on the coupling. The braking forces must continue to be regulated between the state of the "tractor with unladen semi-trailer" and that of the "tractor alone"; the braking forces relating to the "tractor alone" shall be verified.

- 3.1.6.2. Tractors with laden semi-trailer. A laden combination is understood to be a tractor in running order, with the driver on board, coupled to a laden semi-trailer. The dynamic load of the semi-trailer on the tractor shall be represented by a static mass P_s mounted at the fifth wheel coupling equal to:

$$P_s = P_{so} (1 + 0.45z)$$

where:

P_{so} represents the difference between the maximum laden mass of the tractor and its unladen mass.

For h the following value shall be taken:

$$h = \frac{h_o \cdot P_o + h_s \cdot P_s}{P}$$

where:

h_o is the height of the centre of gravity of the tractor;

h_s is the height of the coupling on which the semi-trailer rests;

P_o is the unladen mass of the tractor alone

$$P = P_o + P_s = \frac{P_1 + P_2}{g}$$

- 3.1.6.3. In the case of a vehicle fitted with a compressed air braking system, the permissible relationship between the braking rate T_M/P_M and the pressure p_m shall be within the areas shown on diagram 3 of this annex for all pressures between 20 and 750kPa.

- 3.2. Vehicles with more than two axles.

The requirements of paragraph 3.1. of this annex shall apply to vehicles with more than two axles. The requirements of paragraph 3.1.2. of this annex with respect to wheel lock sequence shall be considered to be met if, in the case of braking rates between 0.15 and 0.30, the adhesion utilized by at least one of the front axles is greater than that utilized by at least one of the rear axles.

4. REQUIREMENTS FOR SEMI-TRAILERS

4.1. For semi-trailers fitted with compressed-air braking systems:

4.1.1. The permissible relationship between the braking rate T_R/P_R and the pressure p_m shall lie within two areas derived from diagrams 4A and 4B for all pressures between 20 and 750 kPa, in both the laden and unladen states of load. This requirement shall be met for all permissible load conditions of the semi-trailer axles.

4.1.2. If the requirements of paragraph 4.1.1. of this annex cannot be satisfied in conjunction with the requirements of paragraph 3.1.2.1. of annex 4 to this Regulation for semi-trailers with a K_c factor less than 0.80, then the semi-trailer must meet the minimum braking performance specified in paragraph 3.1.2.1. of annex 4 to this Regulation and be fitted with an anti-lock system complying with annex 13 to this Regulation, except the compatibility requirement in paragraph 1 of that annex.

5. REQUIREMENTS FOR FULL AND CENTRE-AXLE TRAILERS

5.1. For full trailers fitted with compressed-air braking systems:

5.1.1. The requirements set out in paragraph 3.1. of this annex shall apply to twin-axle trailers (except where the axle spread is less than 2 metres).

5.1.2. Full trailers with more than two axles shall be subject to the requirements of paragraph 3.2. of this annex.

5.1.3. The permissible relationship between the braking rate T_R/P_R and the pressure p_m shall lie within the designated areas in diagram 2 of this annex for all pressures between 20 and 750 kPa, in both the laden and unladen states of load.

5.2. For centre-axle trailers fitted with compressed-air braking systems:

5.2.1. The permissible relationship between the braking rate T_R/P_R and the pressure p_m shall lie within two areas derived from diagram 2 of this annex, by multiplying the vertical scale by 0.95. This requirement shall be met at all pressures between 20 and 750 kPa, in both the laden and unladen states of load.

5.2.2. If the requirements of paragraph 3.1.2.1. of annex 4 to this Regulation cannot be satisfied due to lack of adhesion, then the centre-axle trailer must be fitted with an anti-lock system complying with annex 13 to this Regulation.

6. REQUIREMENTS TO BE MET IN CASE OF FAILURE OF THE BRAKING DISTRIBUTION SYSTEM

When the requirements of this annex are fulfilled by means of a special device (e.g. controlled mechanically by the suspension of the vehicle), it shall be possible, in the event of the failure of its control, to stop the vehicle under the conditions specified for secondary braking in the case of power-driven vehicles; for those power-driven vehicles authorized to tow a trailer fitted with compressed-air braking systems, it must be possible to achieve a pressure at the coupling head of the control line within the range specified in paragraph 3.1.3. of this annex. In the event of failure of the control of the device on trailers, a service braking performance of at least 30 per cent of that prescribed for the vehicle in question shall be attained.

7. MARKINGS

7.1. Vehicles, other than those of category M₁, which meet the requirements of this annex by means of a device mechanically controlled by the suspension of the vehicle, shall be marked to show the useful travel of the device between the positions corresponding to vehicle unladen and laden states, respectively, and any further information to enable the setting of the device to be checked.

7.1.1. When a brake load sensing device is controlled via the suspension of the vehicle by any other means, the vehicle must be marked with information to enable the setting of the device to be checked.

7.2. When the requirements of this annex are met by means of a device which modulates the air pressure in the brake transmission, the vehicle must be marked to show the axle loads at the ground, the nominal outlet pressures of the device and an inlet pressure of not less than 80 per cent of the maximum design inlet pressure, as declared by the vehicle manufacturer, for the following states of load:

7.2.1. technically permissible maximum axle load for the axle(s) which control(s) the device;

7.2.2. axle load(s) corresponding to the unladen mass of the vehicle in running order as stated in paragraph 13 of annex 2 to this Regulation;

7.2.3. The axle load(s) approximating to the vehicle with proposed bodywork in running order where the axle load(s) mentioned in paragraph 7.2.2. of this annex relate(s) to the vehicle chassis with cab;

7.2.4. The axle load(s) designated by the manufacturer to enable the setting of the device to be checked in service if this is (these are) different from the loads specified in paragraphs 7.2.1. to 7.2.3. of this annex.

- 7.3. Paragraph 14.7. of annex 2 to this Regulation must include information to enable compliance with the requirements of paragraphs 7.1. and 7.2. of this annex to be checked.
- 7.4. The markings referred to in paragraphs 7.1. and 7.2. of this annex must be affixed in a visible position in indelible form. An example of the markings for a mechanically controlled device in a vehicle fitted with compressed-air braking system is shown in diagram 5 of this annex.
- 7.5. Electronically controlled brake force distribution systems that cannot fulfil the requirements of paragraphs 7.1., 7.2., 7.3. and 7.4. above shall have a self checking procedure of the functions which influence brake force distribution.

8. VEHICLE TESTING

During the type approval testing of a vehicle, the technical inspection authority shall verify conformity with the requirements contained in the present annex and carry out any further tests considered necessary to this end. The report on the additional tests shall be appended to the type approval form.

DIAGRAM 1A

VEHICLES OF CATEGORY M₁
(and certain vehicles of category N₁ after 1 October 1990)
(see paragraph 3.1.2.1. of this annex)

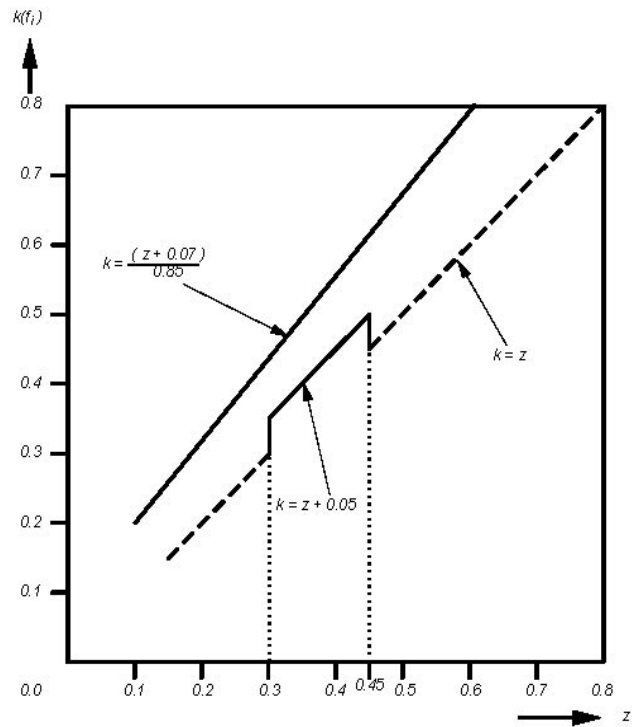
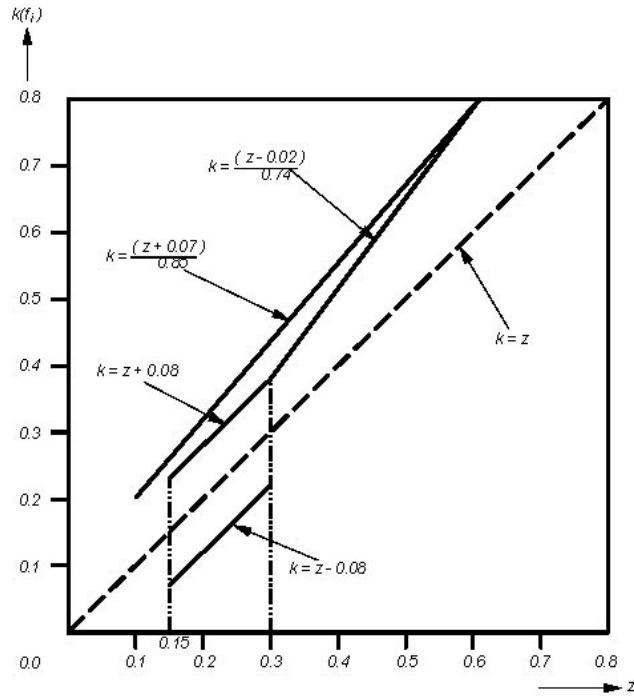

DIAGRAM 1B

POWER-DRIVEN VEHICLES OTHER THAN THOSE OF CATEGORIES M₁ AND N₁
 (see paragraph 3.1.2.3. of this annex)



Note: The lower limit $k = z - 0.08$ is not applicable for the adhesion utilization of the rear axle.

DIAGRAM 1C

VEHICLES OF CATEGORY N₁
(with certain exceptions after 1 October 1990)
(see paragraph 3.1.2.2. of this annex)

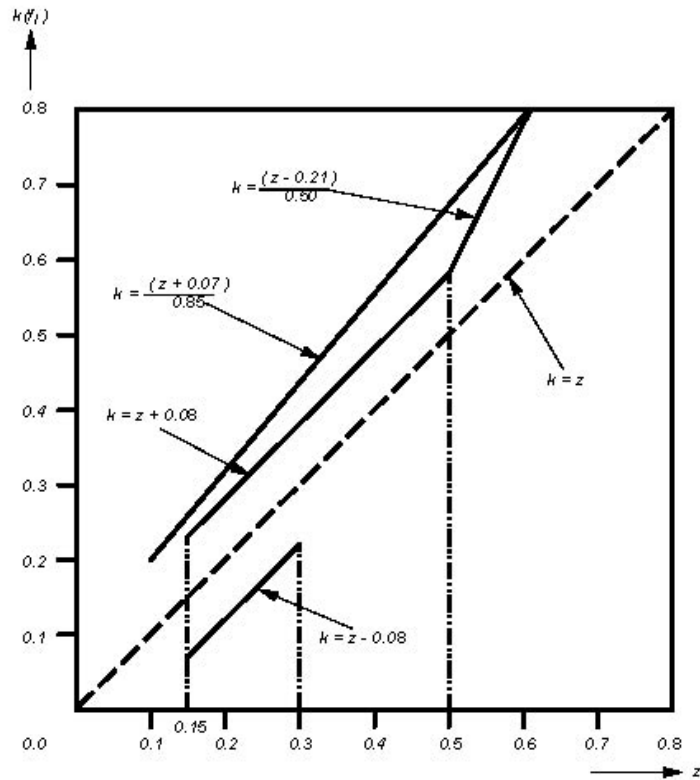

Note: The lower limit $k = z - 0.08$ is not applicable for the adhesion utilization of the rear axle.

DIAGRAM 2

TOWING VEHICLES AND TRAILERS
 (except tractors for semi-trailers and semi-trailers)
 (see paragraph 3.1.5.1. of this annex)

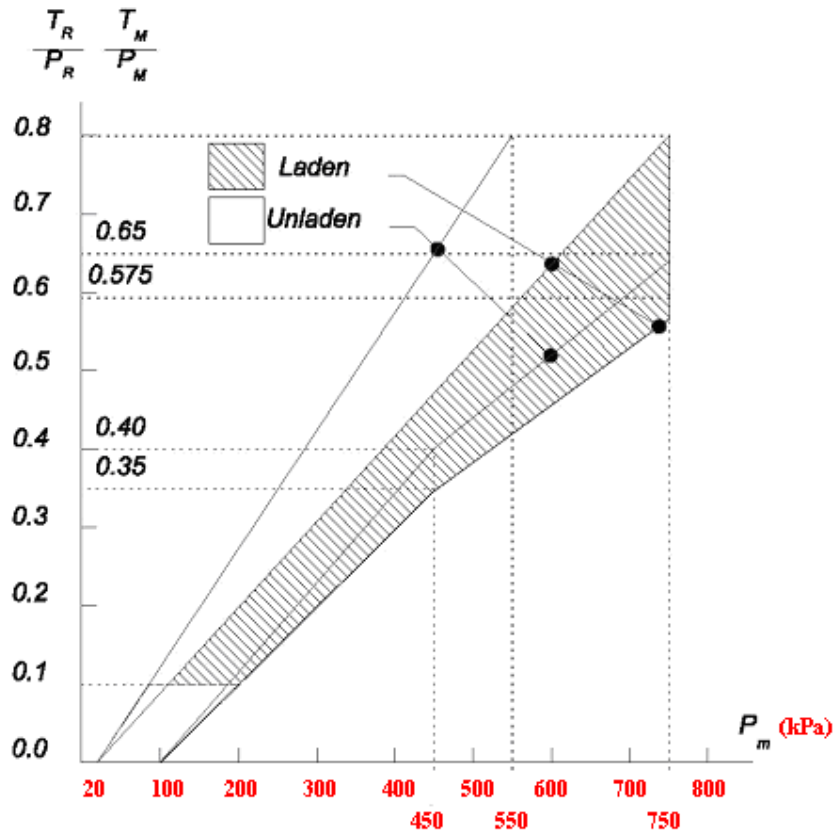

Note: The relationships required by the diagram shall apply progressively for intermediate states of loading between the laden and the unladen states and shall be achieved by automatic means.

DIAGRAM 3

TRACTORS FOR SEMI-TRAILERS
 (see paragraph 3.1.6. of this annex)

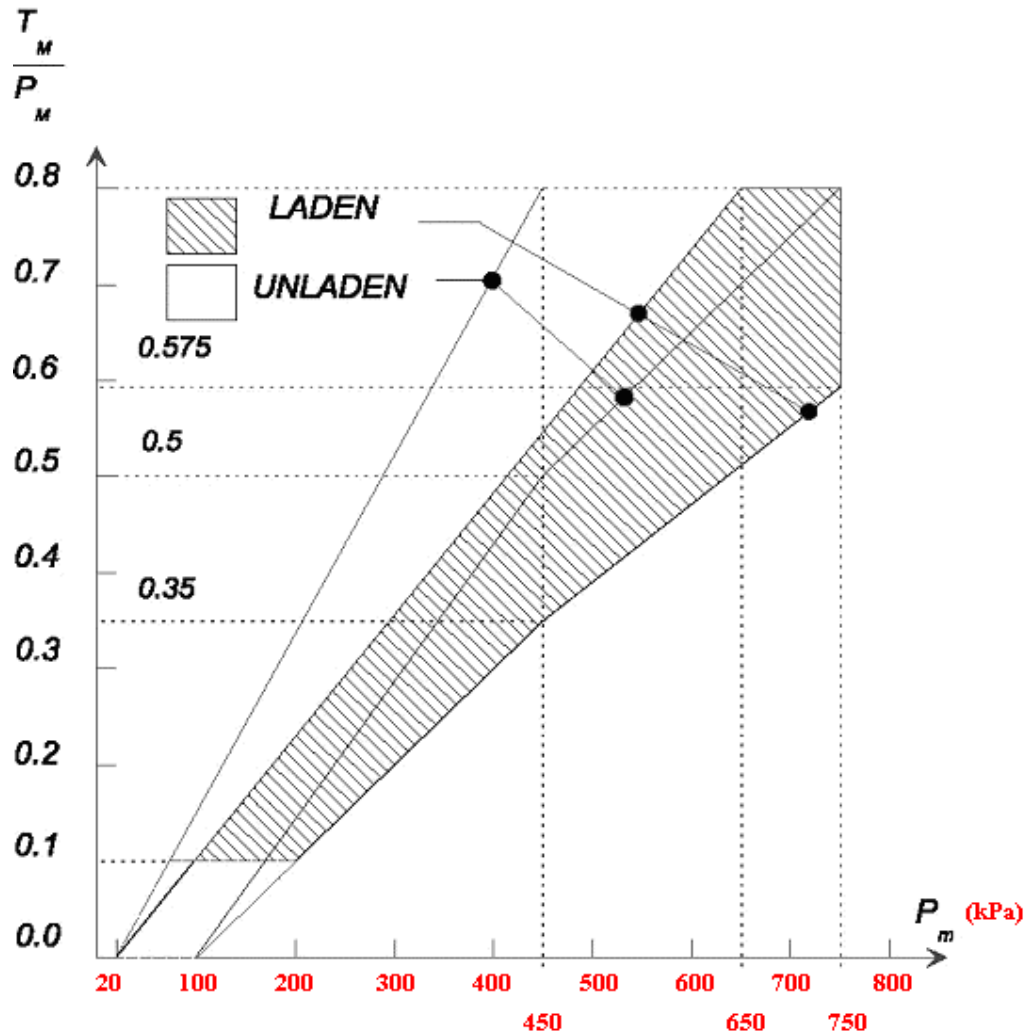

Note: The relationships required by the diagram shall apply progressively for intermediate states of loading between the laden and the unladen states and shall be achieved by automatic means.

DIAGRAM 4A
 SEMI-TRAILERS
 (see paragraph 4. of this annex)

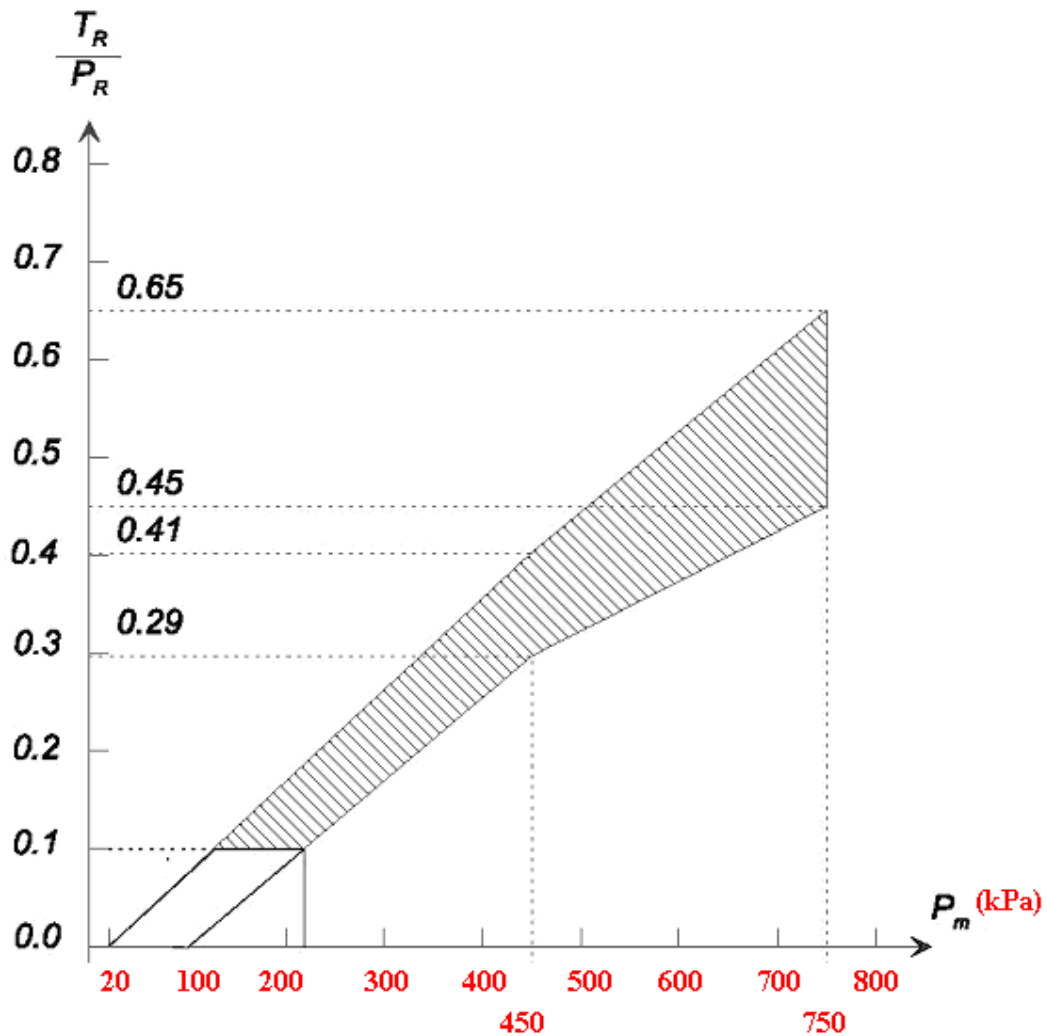

Note: The relation between the braking rate T_R/P_R and the control line pressure for the laden and unladen conditions is determined as follows:

The factors K_c (laden), K_v (unladen) are obtained by reference to diagram 4B. To determine the areas corresponding to the laden and unladen conditions, the values of the ordinates of the upper and lower limits of the hatched area in diagram 4A are multiplied by the factors K_c and K_v respectively.

DIAGRAM 4B

(see paragraph 4. and diagram 4A of this annex)

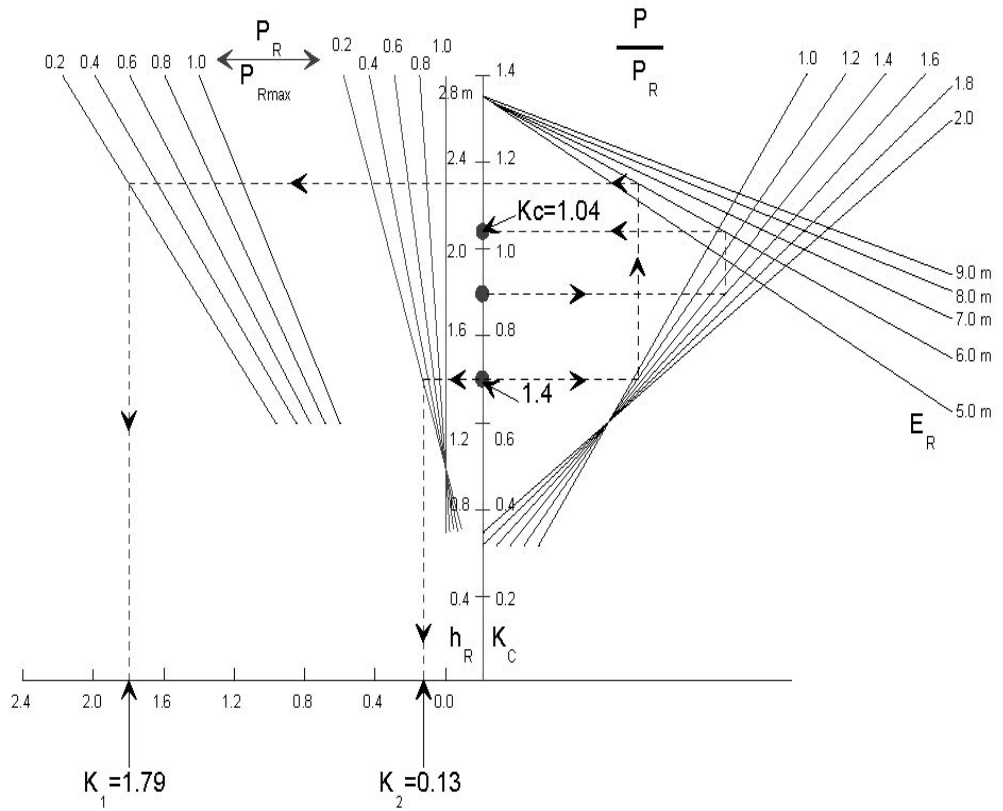

EXPLANATORY NOTE ON THE USE OF DIAGRAM 4B

1. Formula from which diagram 4B is derived:

$$K = \left[1.7 - \frac{0.7P_R}{P_{Rmax}} \right] \left[1.35 - \frac{0.96}{E_R} \left(1.0 + (h_R - 1.2) \frac{g \cdot P}{P_R} \right) \right] - \left[1.0 - \frac{P_R}{P_{Rmax}} \right] \left[\frac{h_R - 1.0}{2.5} \right]$$

2. Description of method of use with practical example.

- 2.1. The broken lines shown on diagram 4B refer to the determination of the factors K_c and K_v for the following vehicle, where:

	Laden	Unladen
P	24 tonnes (240 kN)	4.2 tonnes (42 kN)
P_R	150 kN	30 kN
P_{Rmax}	150 kN	150 kN
h_R	1.8 m	1.4 m
E_R	6.0 m	6.0 m

In the following paragraphs the figures in parentheses relate only to the vehicle being used for the purpose of illustrating the method of using diagram 4B.

- 2.2. Calculation of ratios

(a) $\left[\frac{g \cdot P}{P_R} \right]$ laden (= 1.6)

(b) $\left[\frac{g \cdot P}{P_R} \right]$ unladen (= 1.4)

(c) $\left[\frac{P_R}{P_{Rmax}} \right]$ unladen (= 0.2)

2.3. Determination of the correction factor when laden, K_C :

- (a) Start at the appropriate value of h_R ($h_R = 1.8$ m)
- (b) Move horizontally to the appropriate $g \cdot P/P_R$ line ($g \cdot P/P_R = 1.6$)
- (c) Move vertically to the appropriate E_R line ($E_R = 6.0$ m)
- (d) Move horizontally to the K_C scale; K_C is the laden correction factor required ($K_C = 1.04$)

2.4. Determination of the correction factor when unladen, K_V :

2.4.1. Determination of the factor K_2 :

- (a) Start at appropriate h_R ($h_R = 1.4$ m)
- (b) Move horizontally to the appropriate P_R/P_{Rmax} line in the group of curves nearest to vertical axis ($P_R/P_{Rmax} = 0.2$)
- (c) Move vertically to the horizontal axis and read off the value of K_2 ($K_2 = 0.13$ m).

2.4.2. Determination of the factor K_1 :

- (a) Start at the appropriate value of h_R ($h_R = 1.4$ m)
- (b) Move horizontally to the appropriate $g \cdot P/P_R$ line ($g \cdot P/P_R = 1.4$)
- (c) Move vertically to the appropriate E_R line ($E_R = 6.0$ m)
- (d) Move horizontally to the appropriate P_R/P_{Rmax} line in the group of curves furthest from the vertical axis ($P_R/P_{Rmax} = 0.2$)
- (e) Move vertically to the horizontal axis and read off the value of K_1 ($K_1 = 1.79$).

2.4.3. Determination of the factor K_V :

The unladen correction factor K_V is obtained from the following expression:

$$K_V = K_1 - K_2 \cdot (K_V = 1.66)$$

DIAGRAM 5

BRAKE LOAD SENSING DEVICE
 (see paragraph 7.4. of this annex)

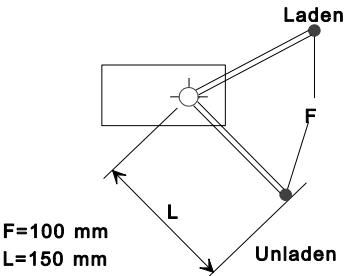
Control data	Vehicle loading	Axle No. 2 load at the ground [daN]	Inlet pressure [kPa]	Nominal outlet pressure [kPa]
 <p>F=100 mm L=150 mm</p>	Laden	10 000	600	600
	Unladen	1 500	600	240

Annex 11

CASES IN WHICH TYPE-I AND/OR TYPE-II (OR TYPE-IIA) OR TYPE-III TESTS
DO NOT HAVE TO BE CARRIED OUT

1. Type-I and/or Type-II (or Type-IIA) or Type-III tests need not be performed on a vehicle submitted for approval in the following cases:
 - 1.1. The vehicle concerned is a power-driven vehicle or a trailer which, as regards tyres, braking energy absorbed per axle, and mode of tyre fitting and brake assembly, is identical with respect to braking with a power-driven vehicle or a trailer which:
 - 1.1.1. has passed the Type-I and/or Type-II (or Type-IIA) or Type-III test; and
 - 1.1.2. has been approved, with regard to the braking energy absorbed, for mass per axle not lower than that of the vehicle concerned.
 - 1.2. The vehicle concerned is a power-driven vehicle or a trailer whose axle or axles are, as regards tyres, braking energy absorbed per axle, and mode of tyre fitting and brake assembly, identical with respect to braking with an axle or axles which have individually passed the Type-I and/or Type-II (or Type-IIA) or Type-III test for masses per axle not lower than that of the vehicle concerned, provided that the braking energy absorbed per axle does not exceed the energy absorbed per axle in the reference test or tests carried out on the individual axle.
 - 1.3. The vehicle concerned is equipped with an endurance braking system, other than the engine brake, identical with an endurance braking system already tested under the following conditions:
 - 1.3.1. the endurance braking system shall, by itself, in a test carried out on a gradient of at least 6 per cent (Type-II test) or of at least 7 per cent (Type-IIA test), have stabilized a vehicle whose maximum mass at the time of the test was not less than the maximum mass of the vehicle submitted for approval;
 - 1.3.2. it shall be verified in the above test that the rotational speed of the rotating parts of the endurance braking system, when the vehicle submitted for approval reaches a road speed of 30 km/h, is such that the retarding torque is not less than that corresponding to the test referred to in paragraph 1.3.1. above.

- 1.4. The vehicle concerned is a trailer equipped with air operated S-cam or disc brakes 1/ which satisfies the verification requirements of appendix 2 to this annex relative to the control of characteristics compared to the characteristics given in a report of a reference axle test as shown in appendix 3 to this annex.
2. The term "identical", as used in paragraphs 1.1., 1.2. and 1.3. above, means identical as regards the geometric and mechanical characteristics and the materials used for the components of the vehicle referred to in those paragraphs.
3. Where the foregoing requirements are applied, the communication concerning approval (annex 2 to this Regulation) shall include the following particulars:
 - 3.1. In the case under paragraph 1.1., the approval number of the vehicle subjected to the Type-I and/or Type-II (or Type-IIA) or Type-III test of reference shall be entered.
 - 3.2. In the case under paragraph 1.2., Table I in appendix 1 to this annex shall be completed;
 - 3.3. In the case under paragraph 1.3., Table II in appendix 1 to this annex shall be completed.
 - 3.4. If paragraph 1.4. is applicable, Table III in appendix 1 to this annex shall be completed.
4. Where the applicant for approval in a country Party to the Agreement applying this Regulation refers to an approval granted in another country Party to the Agreement applying this Regulation, he shall submit the documentation relating to that approval.

1/ Other brake designs may be approved upon presentation of equivalent information.

Annex 11 - Appendix 1

Table I

	Axles of the vehicle			Reference axles		
	Mass per axle <u>1/</u>	Braking force needed at wheels	Speed	Mass per axle <u>1/</u>	Braking force developed at wheels	Speed
	kg	N	km/h	kg	N	km/h
Axle 1						
Axle 2						
Axle 3						
Axle 4						

Table II

Total mass of the vehicle submitted for approval	kg
Braking force needed at wheels.....	N
Retarding torque needed at main shaft of endurance braking system	Nm
Retarding torque obtained at main shaft of endurance braking system (according to diagram)	Nm

1/ Technically permissible maximum mass per axle.

Table III

Reference axle	Report No.	Date	
		(copy attached)	
		Type-I	Type-III
Energy absorbed per axle (N) (see paragraph 4.2.1., appendix 2)			
Axle 1	$T_1 = \dots \% P_e$	$T_1 = \dots \% P_e$	
Axle 2	$T_2 = \dots \% P_e$	$T_2 = \dots \% P_e$	
Axle 3	$T_3 = \dots \% P_e$	$T_3 = \dots \% P_e$	
Predicted actuator stroke (mm) (see paragraph 4.3.2., appendix 2)			
Axle 1	$S_1 = \dots$	$S_1 = \dots$	
Axle 2	$S_2 = \dots$	$S_2 = \dots$	
Axle 3	$S_3 = \dots$	$S_3 = \dots$	
Average output thrust (N) (see paragraph 4.3.3., appendix 2)			
Axle 1	$Th_{A1} = \dots$	$Th_{A1} = \dots$	
Axle 2	$Th_{A2} = \dots$	$Th_{A2} = \dots$	
Axle 3	$Th_{A3} = \dots$	$Th_{A3} = \dots$	
Braking performance (N) (see paragraph 4.3.5., appendix 2)			
Axle 1	$T_1 = \dots$	$T_1 = \dots$	
Axle 2	$T_2 = \dots$	$T_2 = \dots$	
Axle 3	$T_3 = \dots$	$T_3 = \dots$	
Braking performance of vehicle (see paragraph 4.3.6., appendix 2)	Type-0 subject trailer test result (E)	Type-I hot (predicted)	Type-III hot (predicted)
Hot braking requirements (see paragraphs 1.5.3., 1.6.3. and 1.7.2. of annex 4)		≥ 0.36 and $\geq 0.60 E$	≥ 0.40 and $\geq 0.60 E$

Annex 11 - Appendix 2

ALTERNATIVE PROCEDURES FOR TYPE-I AND TYPE-III TESTS
FOR TRAILER BRAKES

1. GENERAL

- 1.1. In accordance with paragraph 1.4. of this annex, the Type-I or Type-III test may be waived at the time of type approval of the vehicle provided that the braking system components comply with the requirements of this appendix and that the resulting predicted braking performance meets the requirements of this Regulation for the appropriate vehicle category.
- 1.2. Tests carried out in accordance with the methods detailed in this appendix shall be deemed to meet the above requirements.
- 1.3. Tests carried out in accordance with paragraph 3.6. of this appendix and the results reported in section 2 of Appendix 3 or Appendix 4 shall be acceptable as a means of proving compliance with the requirements of paragraph 5.2.2.8.1. of this Regulation.
- 1.4. The adjustment of the brake(s) shall, prior to the Type-III test below, be set according to the following procedures as appropriate:
- 1.4.1. In the case of air operated trailer brake(s), the adjustment of the brakes shall be such as to enable the automatic brake adjustment device to function. For this purpose the actuator stroke shall be adjusted to

$s_0 \geq 1.1 \cdot s_{\text{re-adjust}}$ (the upper limit shall not exceed a value recommended by the manufacturer),

where:

$s_{\text{re-adjust}}$ is the re-adjustment stroke according to the specification of the manufacturer of the automatic brake adjustment device, i.e. the stroke, where it starts to re-adjust the running clearance of the brake with an actuator pressure of **100 kPa**.

Where, by agreement with the Technical Service, it is impractical to measure the actuator stroke, the initial setting shall be agreed with the Technical Service.

From the above condition the brake shall be operated with an actuator pressure of **200 kPa**, 50 times in succession. This shall be followed by a single brake application with an actuator pressure of \geq **650 kPa**.

- 1.4.2. In the case of hydraulically operated trailer disc brakes no setting requirements are deemed necessary.
- 1.4.3. In the case of hydraulically operated trailer drum brakes the adjustment of the brakes shall be as specified by the manufacturer.
- 1.5. In the case of trailers equipped with automatic brake adjustment devices the adjustment of the brakes shall, prior to the Type-I test below, be set according to the procedure as laid down in paragraph 1.4. above.

2. SYMBOLS AND DEFINITIONS

Note: The reference brake symbols shall have the suffix "e"

- P = normal reaction of road surface on the axle under static conditions
- C = brake input torque
- C_{max} = maximum permissible brake input torque
- C_O = threshold brake input torque, i.e., minimum input torque necessary to produce a measurable output torque
- R = tyre rolling radius (dynamic)
- T = brake force at tyre/road interface
- M = brake torque = T.R
- z = braking rate = T/P or M/RP
- s = actuator stroke (working stroke plus free stroke)
- s_p = see annex 19, appendix 7
- Th_A = see annex 19, appendix 7
- l = lever length
- r = radius of brake drums
- p = brake actuation pressure

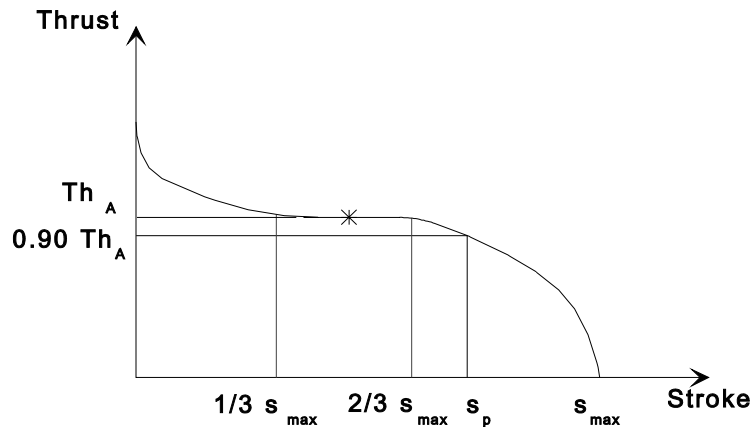

3. TEST METHODS

3.1. Track tests

3.1.1. The brake performance tests should preferably be carried out on a single axle only.

3.1.2. The results of tests on a combination of axles may be used in accordance with paragraph 1.1. of this annex provided that each axle contributes equal braking energy input during the drag and hot brake tests.

3.1.2.1. This is ensured if the following are identical for each axle: braking geometry, lining, wheel mounting, tyres, actuation and pressure distribution in the actuators.

3.1.2.2. The documented result for a combination of axles will be the average for the number of axles, as though a single axle had been used.

3.1.3. The axle(s) should preferably be loaded with the maximum static axle load, though this is not essential provided that due allowance is made during the tests for the difference in rolling resistance caused by a different load on the test axle(s).

3.1.4. Allowance shall be made for the effect of the increased rolling resistance resulting from a combination of vehicles being used to carry out the tests.

3.1.5. The initial speed of the test shall be that prescribed. The final speed shall be calculated by the following formula:

$$v_2 = v_1 \sqrt{\frac{P_0 + P_1}{P_0 + P_1 + P_2}}$$

where

v_1 = initial speed (km/h)

v_2 = final speed (km/h)

P_0 = mass of the towing vehicle (kg) under test conditions

P_1 = part of the mass of the trailer borne by the unbraked axle(s) (kg)

P_2 = part of the mass of the trailer borne by the braked axle(s) (kg).

3.2. Inertia dynamometer tests

3.2.1. The test machine shall have a rotary inertia simulating that part of the linear inertia of the vehicle mass acting upon one wheel, necessary for the cold performance and hot performance tests, and capable of being operated at constant speed for the purpose of the test described in paragraphs 3.5.2. and 3.5.3. of this appendix.

3.2.2. The test shall be carried out with a complete wheel, including the tyre, mounted on the moving part of the brake, as it would be on the vehicle. The inertia mass may be connected to the brake either directly or via the tyres and wheels.

3.2.3. Air cooling at a velocity and air flow direction simulating actual conditions may be used during the heating runs, the speed of the air flow being

$$v_{\text{air}} = 0.33 v$$

where:

v = vehicle test speed at initiation of braking.

The temperature of the cooling air shall be the ambient temperature.

3.2.4. Where the tyre rolling resistance is not automatically compensated for in the test, the torque applied to the brake shall be modified by subtracting a torque equivalent to a rolling resistance coefficient of 0.01.

- 3.3. Rolling road dynamometer tests
- 3.3.1. The axle should preferably be loaded with the maximum static axle mass though this is not essential provided that due allowance is made during the tests for the difference in rolling resistance caused by a different mass on the test axle.
- 3.3.2. Air cooling at a velocity and air flow direction simulating actual conditions may be used during the heating runs, the speed of the air flow being
- $$v_{\text{air}} = 0.33 v$$
- where:
 v = vehicle test speed at initiation of braking.
- The temperature of the cooling air shall be the ambient temperature.
- 3.3.3. The braking time shall be 1 second after a maximum build-up time of 0.6 second.
- 3.4. Test conditions
- 3.4.1. The test brake(s) shall be instrumented so that the following measurements can be taken:
- 3.4.1.1. A continuous recording to enable the brake torque or force at the periphery of the tyre to be determined.
- 3.4.1.2. A continuous recording of air pressure in the brake actuator.
- 3.4.1.3. Vehicle speed during the test.
- 3.4.1.4. Initial temperature on the outside of the brake drum or brake disc.
- 3.4.1.5. Brake actuator stroke used during Type-0 and Type-I or Type-III tests.
- 3.5. Test procedures
- 3.5.1. Supplementary cold performance test
- 3.5.1.1. This test is carried out at an initial speed equivalent to 40 km/h in the case of Type-I test and 60 km/h in the case of Type-III test in order to evaluate the hot braking performance at the end of Type-I and Type-III tests.
- 3.5.1.2. Three brake applications are made at the same pressure (p) and at an initial speed equivalent to 40 km/h (in the case of Type-I test) or 60 km/h (in the case of Type-III test), with an approximately equal initial brake temperature not

exceeding 100°C, measured at the outside surface of the drums or discs. The applications shall be at the brake actuator pressure required to give a brake torque or force equivalent to a braking rate (z) of at least 50 per cent. The brake actuator pressure shall not exceed 650 kPa, and the brake input torque (C) shall not exceed the maximum permissible brake input torque (C_{max}). The average of the three results shall be taken as the cold performance.

3.5.2. Fade test (Type-I test)

3.5.2.1. This test is carried out at a speed equivalent to 40 km/h with an initial brake temperature not exceeding 100°C, measured at the outside surface of the drum or brake disc.

3.5.2.2. A braking rate is maintained at 7 per cent, including the rolling resistance (see paragraph 3.2.4. of this appendix).

3.5.2.3. The test is made during 2 minutes and 33 seconds or during 1.7 km at a vehicle speed of 40 km/h. If the test velocity cannot be achieved, then the duration of the test can be lengthened according to paragraph 1.5.2.2. of annex 4 to this Regulation.

3.5.2.4. Not later than 60 seconds after the end of the Type-I test, a hot performance test is carried out in accordance with paragraph 1.5.3. of annex 4 to this Regulation at an initial speed equivalent to 40 km/h. The brake actuator pressure shall be that used during the Type-0 test.

3.5.3. Fade test (Type-III test)

3.5.3.1. Test methods for repeated braking

3.5.3.1.1. Track tests (see annex 4, paragraph 1.7)

3.5.3.1.2. Inertia dynamometer test

For the bench test as in annex 11, appendix 2, paragraph 3.2., the conditions may be as for the road test according to paragraph 1.7.1. with:

$$v_2 = \frac{v_1}{2}$$

3.5.3.1.3. Rolling road dynamometer test

For the bench test as in annex 11, appendix 2, paragraph 3.3., the conditions shall be as follows:

Number of brake applications	20
Duration of braking cycle (braking time 25 s and recovery time 35 s)	60 s
Test speed	30 km/h
Braking rate	0.06
Rolling resistance	0.01

3.5.3.2. Not later than 60 seconds after the end of the Type-III test a hot performance test is carried out in accordance with paragraph 1.7.2. of annex 4 to this Regulation. The brake actuator pressure shall be that used during the Type-0 test.

3.6. Performance requirements for automatic brake adjustment devices

3.6.1. The following requirements shall apply to an automatic brake adjustment device which is installed on a brake, the performance of which is being verified according to the provisions of this appendix.

On completion of the tests defined in paragraphs 3.5.2.4. (Type-I test) or 3.5.3.2 (Type-III test) above, the requirements of paragraph 3.6.3. below shall be verified.

3.6.2. The following requirements shall apply to an alternative automatic brake adjustment device installed on a brake for which an appendix 3 test report already exists.

3.6.2.1. Brake performance

Following heating of the brake(s) carried out in accordance with the procedures defined in paragraphs 3.5.2. (Type-I test) or 3.5.3 (Type-III test), as appropriate, one of the following provisions shall apply:

- a) The hot performance of the service braking system shall be ≥ 80 per cent of the prescribed Type-0 performance; or
- b) The brake shall be applied with a brake actuator pressure as used during the Type-0 test; at this pressure the total actuator stroke (s_A) shall be measured and shall be $\leq 0.9 s_p$ value of the brake chamber.

s_p = The effective stroke means the stroke at which the output thrust is 90 per cent of the average thrust (Th_A) - see paragraph 2. of annex 11 - appendix 2 to this Regulation.

3.6.2.2. On completion of the tests defined in paragraph 3.6.2.1. above the requirements of paragraph 3.6.3. below shall be verified.

3.6.3. Free running test

After completing the tests defined in paragraphs 3.6.1. or 3.6.2. above, as applicable, the brake(s) shall be allowed to cool to a temperature representative of a cold brake (i.e. $\leq 100^{\circ}\text{C}$) and it should be verified that the trailer/wheel(s) is capable of free running by fulfilling one of the following conditions:

- a) Wheels are running freely (i.e. wheels can be rotated by hand).
- b) It is ascertained that at a constant speed equivalent to $v = 60\text{ km/h}$ with the brake(s) released the asymptotic temperature shall not exceed a drum/disc temperature increase of 80°C , then this residual brake moment is regarded as acceptable."

3.7. Test report

3.7.1. The result of tests carried out in accordance with paragraphs 3.5. and 3.6.1. of this appendix shall be reported on a form, a model of which is shown in appendix 3 to this annex.

3.7.2. The brake and the axle shall be identified. Particulars of the brakes, the axle, the technically permissible mass and the number of the corresponding appendix 3 test report shall be marked on the axle.

3.7.3. In the case of a brake installed with an alternative brake adjustment device the results of tests carried out in accordance with paragraph 3.6.2. of this appendix shall be reported on a form a model of which is shown in appendix 4 to this annex.

4. VERIFICATION

4.1. Verification of components

The brake specification of the vehicle to be type approved shall be verified by satisfying each of the following design criteria:

Item	Criteria
4.1.1. <ul style="list-style-type: none"> a) Brake drum cylindrical section b) Brake drum or brake disc material c) Brake drum or brake disc mass 	No change allowed No change allowed May increase up to + 20 per cent from the reference drum or disc mass

Item	Criteria
4.1.2. a) Proximity of wheel to outside surface of brake drum or outside diameter of brake disc (dimension E) b) Part of brake drum or brake disc not covered by wheel (dimension F)	Tolerances to be determined by the Technical Service conducting the tests.
4.1.3. a) Brake lining or brake pad material b) Brake lining or brake pad width c) Brake lining or brake pad thickness d) Brake lining or brake pad actual surface area e) Brake lining or brake pad method of attachment)))) No change allowed)))
4.1.4. Brake geometry (As in Fig.2A or 2B of appendix 3 as appropriate)	No change allowed
4.1.5. Tyre rolling radius (R)	May change subject to the requirements of para. 4.3.5. of this appendix
4.1.6. a) Average thrust (TH_A) b) Actuation stroke (s) c) Actuation lever length (l) d) Actuation pressure (p)	May change provided that the predicted performance meets the requirements of para. 4.3. of this appendix
4.1.7. Static mass (P)	P shall not exceed P_e , (see para. 2)

4.2. Verification of brake energy absorbed

4.2.1. The brake forces (T) for each subject brake (for the same control line pressure p_m) necessary to produce the drag force specified for both Type-I and Type-III test conditions must not exceed the values T_e as stated in annex 11 - appendix 3, paragraphs 2.1. and 2.2., which were taken as a basis for the test of the reference brake.

4.3. Verification of hot performance

4.3.1. The brake force (T) for each subject brake for a specified pressure (p) in the actuators and for a control line pressure (p_m) used during the Type-0 test of the subject trailer is determined as follows:

4.3.1.1. The predicted actuator stroke (s) of the subject brake is calculated as follows:

$$s = 1 \cdot \frac{S_e}{l_e}$$

This value shall not exceed s_p . Where s_p has been verified and reported in accordance with the procedure defined in item 2 of annex 19 to this Regulation and may only be applied within the pressure range recorded in paragraph 3.3.1. of the test report defined in appendix 1 of annex 19.

4.3.1.2. The average thrust output (Th_A) of the actuator fitted to the subject brake at the pressure specified in paragraph 4.3.1. above is measured.

4.3.1.3. The brake input torque (C) is then calculated as follows:

$$C = Th_A \cdot l$$

C shall not exceed C_{max} .

4.3.1.4. The predicted brake performance for the subject brake is given by:

$$T = (T_e - 0.01 \cdot P_e) \frac{(C - C_o)}{(C_e - C_{oe})} \cdot \frac{R_e}{R} + 0.01 \cdot P$$

R shall not be less than $0.8 R_e$.

4.3.2. The predicted brake performance for the subject trailer is given by:

$$\frac{T_R}{P_R} = \frac{\Sigma T}{\Sigma P}$$

4.3.3. The hot performances following the Type-I or Type-III tests shall be determined in accordance with paragraphs 4.3.1.1. to 4.3.1.4. The resulting predictions given by paragraph 4.3.2. above must satisfy the requirements of this Regulation for the subject trailer. The value used for "the figure recorded in the Type-0 test as prescribed in paragraph 1.5.3. or 1.7.2. of annex 4", shall be the figure recorded in the Type-0 test of the subject trailer.

Annex 11 - Appendix 3

MODEL TEST REPORT FORM AS PRESCRIBED IN PARAGRAPHS 3.7.1. AND 3.7.2.
OF APPENDIX 2 TO THIS ANNEX

TEST REPORT NO.

1. IDENTIFICATION

1.1. Axle:

Manufacturer (name and address)

Make

Type

Model

Technically permissible axle load (P_e) daN

1.2. Brake:

Manufacturer (name and address)

Make

Type

Model

Technically permissible brake input torque C_{max}

Automatic brake adjustment drive: integrated/non-integrated 1/

Brake drum or brake disc 1/

Internal diameter of drum or outside diameter of disc 1/

Effective radius

Thickness 2/

Mass

Material

1/ Strike out what does not apply.

2/ Applies to disc brakes only

Brake lining or pad 1/:

Manufacturer.....
Type.....
Identification (must be visible when the lining /pad is mounted
on the brake shoe / backing plate)
Width
Thickness
Surface area.....
Method of attachment.....

Brake geometry, attach dimension drawing as follows:

Drum brakes see fig. 2A of this appendix
Disc brakes see fig. 2B of this appendix

1.3. Wheel(s):

Single/Twin 1/
Rim diameter (D).....
(Attach dimensioned drawing as in fig. 1A or fig. 1B of this appendix, as
appropriate)

1.4. Tyres:

Reference rolling radius (R_e) at reference reaction (P_e)

1.5. Actuator:

Manufacturer.....
Type (cylinder/diaphragm) 1/
Model.....
Lever length (l_e)

1.6. 3/ Automatic brake adjustment device (not applicable in the case of integrated
automatic brake adjustment device)

Manufacturer (name and address):
Make:
Type:
Version:

3/ Only to be completed when an automatic brake wear adjustment device is installed.

2. RECORD OF TEST RESULTS 4/
(corrected to take account of rolling resistance $\Rightarrow 0,01 \cdot P_e$)

2.1. In the case of vehicles of categories O₂ and O₃:

Test type:		0	I	
Annex 11, appendix 2, para.:		3.5.1.2.	3.5.2.2./3.	3.5.2.4.
Test speed	km/h	40	40	40
Brake actuator pressure p _e	kPa	-	-	-
Braking time	min	-	2.55	-
Brake force developed T _e	N	-	-	-
Brake efficiency T _e /9,81P _e	-	-	-	-
Actuator stroke s _e	mm	-	-	-
Brake input torque C _e	Nm	-	-	-
C _{o,e}	Nm	-	-	-

2.2. In the case of vehicles of category O₄:

Test type:		0	III	
Annex 11, appendix 2, para.:		3.5.1.2.	3.5.3.1.	3.5.3.2.
Test speed initial	km/h	60	-	60
final	km/h	-	-	-
Brake actuator pressure p _e	kPa	-	-	-
Number of brake applications	-	-	20	-
Duration of braking cycle	s	-	60	-
Brake force developed T _e	N	-	-	-
Brake efficiency T _e /9,81P _e	-	-	-	-
Actuator stroke s _e	mm	-	-	-
Brake input torque C _e	Nm	-	-	-
C _{o,e}	Nm	-	-	-

2.3. This item is to be completed only when the brake has been subject to the test procedure defined in paragraph 4. of annex 19 to this Regulation to verify the cold performance characteristics of the brake by means of the brake factor (B_F). Where the brake factor is defined as input to output amplification ratio of the brake.

2.3.1. Brake factor B_F:

4/ To be signed by different persons even when the Technical Service and Approval Authority are the same or alternatively, a separate Approval Authority authorisation issued with the report.

3. Performance of the automatic brake adjustment device (if applicable)
- 3.1. Free running according to paragraph 3.6.3. of annex 11, appendix 2: yes / no 1/
4. This test has been carried out and the results reported in accordance with appendix 2 to annex 11 and where appropriate paragraph 4. of annex 19 to ECE Regulation No. 13 as last amended by the series of amendments

Technical Service 4/ carrying out the test

Signed: Date:

5. Approval Authority 4/

Signed: Date:

6. 3/ At the end of test defined in paragraph 3.6. of annex 11, appendix 2, the requirements of paragraph 5.2.2.8.1. of Regulation No. 13 were deemed to be fulfilled / not fulfilled 1/

Signed: Date:

Figure 1B

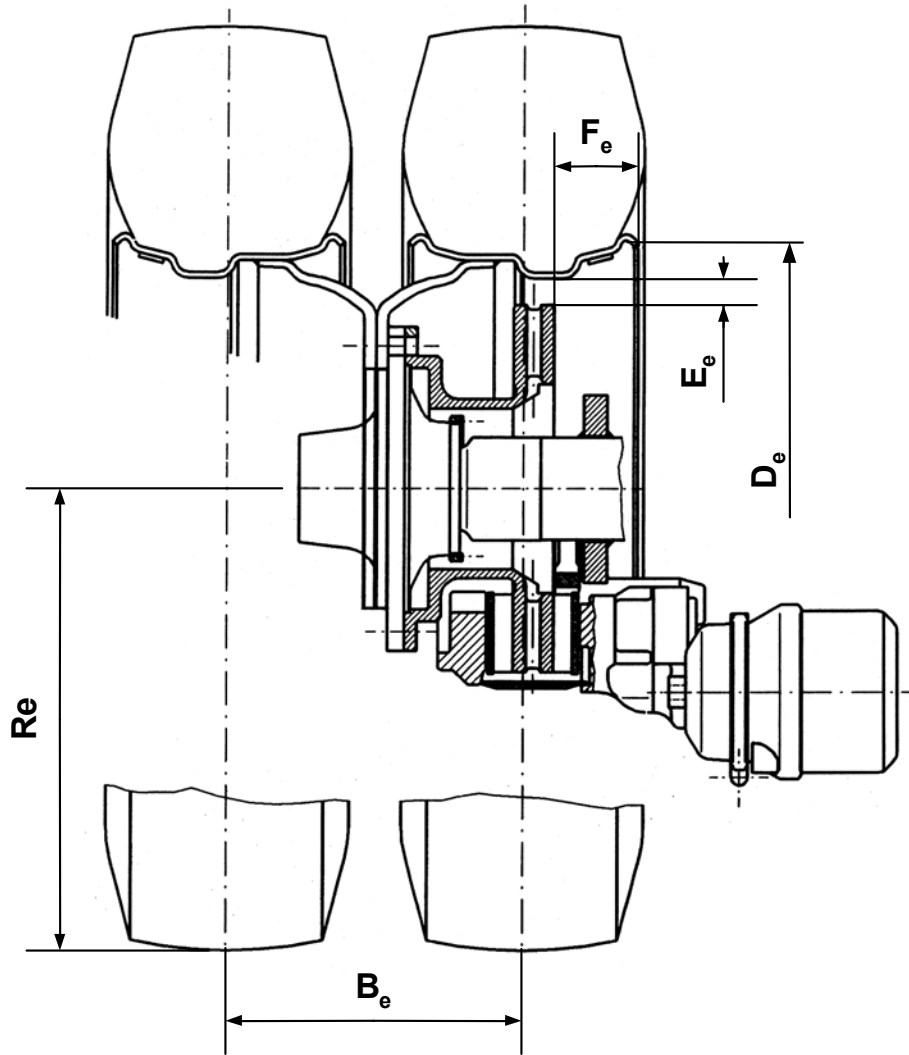

Be (mm)	De (mm)	Ee (mm)	Fe (mm)	Re (mm)

Figure 2B

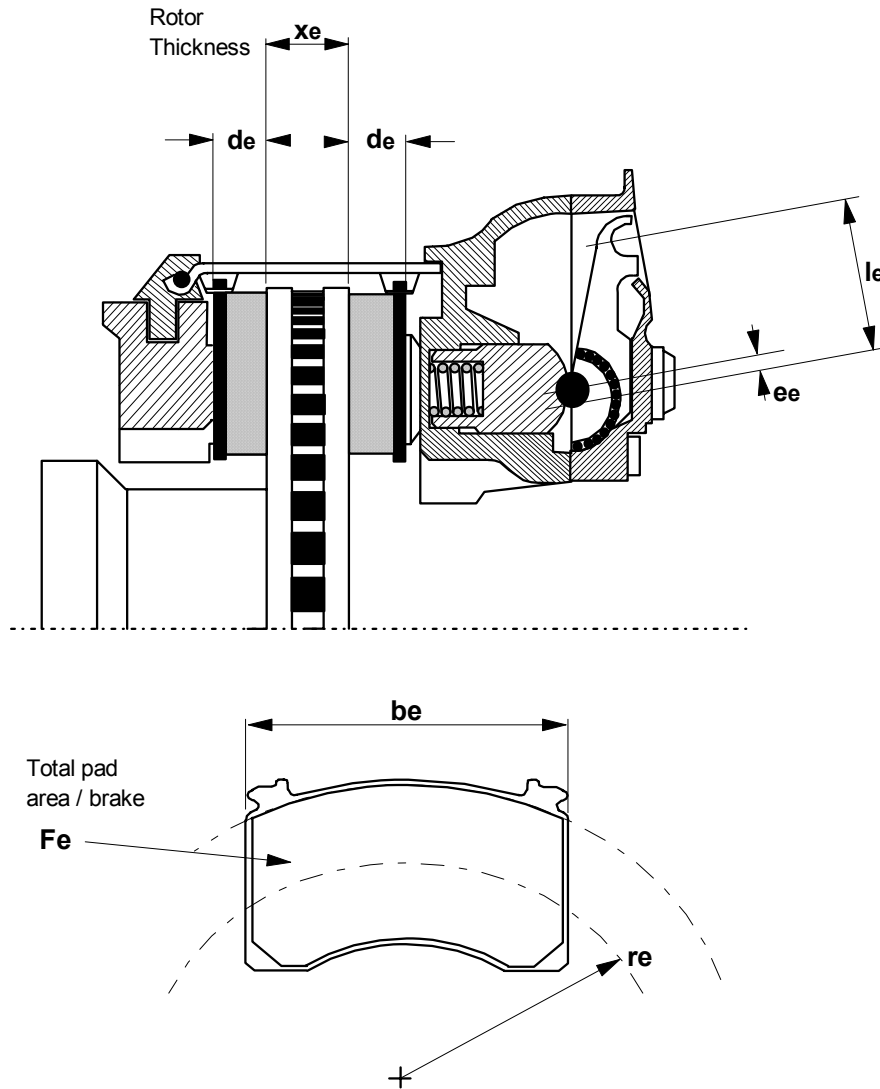

l_e (mm)	e_e (mm)	d_e (mm)	x_e (mm)	r_e (mm)	b_e (mm)	Fe (cm^2)

Annex 11 - Appendix 4

MODEL TEST FOR AN ALTERNATIVE AUTOMATIC BRAKE ADJUSTMENT
DEVICE FORM AS PRESCRIBED IN PARAGRAPH 3.7.3. OF APPENDIX 2
TO THIS ANNEX

TEST REPORT No.

1. IDENTIFICATION

1.1. Axle:

Make:
Type:
Model:
Technically permissible axle load (P_e) daN
Annex 11 Appendix 3 Test Report No.

1.2 .Brake:

Make:
Type:
Model:
Brake lining:
Make/Type:

1.3. Actuation:

Manufacturer:
Type (cylinder/diaphragm) 1/:
Model:
Lever length (l): mm

1.4. Automatic brake adjustment device:

Manufacturer (name and address):
Make:
Type:
Version:

2. RECORD OF TEST RESULTS

2.1. Performance of the automatic brake adjustment device

2.1.1. Hot performance of service braking systems determined according to the test defined in paragraph 3.6.2.1. (a) of annex 11, appendix 2:%
or
Actuator stroke s_A determined according to the test defined in paragraph 3.6.2.1. (b) of annex 11, appendix 2:..... mm

2.1.2. Free running according to paragraph 3.6.3. of annex 11, appendix 2: yes / no 1/

3. Name of Technical Service/Type Approval Authority 1/ conducting the test:
.....

4. Date of test:

5. This test has been carried out and the results reported in accordance with annex 11, appendix 2, paragraph 3.6.2. to ECE Regulation No. 13 as last amended by the series of amendments.

6. At the end of test defined in item 5 above the requirements of paragraph 5.2.2.8.1. of Regulation No. 13 were deemed to be Fulfilled / Not fulfilled 1/

Signed: Date:

7. Technical Service 2/ carrying out the test

Signed: Date:

8. Approval Authority 2/

Signed: Date:

1/ Strike out what does not apply.

2/ To be signed by different persons even when the Technical Service and Approval Authority are the same or alternatively a separate Approval Authority authorisation issued with the report.

Annex 12

CONDITIONS GOVERNING THE TESTING OF VEHICLES EQUIPPED
WITH INERTIA (OVERRUN) BRAKING SYSTEMS

1. GENERAL PROVISIONS

- 1.1. The inertia (overrun) braking system of a trailer comprises the control device, the transmission and the wheel brakes, hereinafter called "brakes".
- 1.2. The control device is the aggregate of the components integral with the traction device (coupling head).
- 1.3. The transmission is the aggregate of the components comprised between the last part of the coupling head and the first part of the brake.
- 1.4. The "brake" is the part in which the forces opposing the movement of the vehicle develop. The first part of the brake is either the lever actuating the brake cam or similar components (mechanical-transmission inertia braking system), or the brake cylinder (hydraulic-transmission inertia braking system).
- 1.5. Braking systems in which accumulated energy (e.g. electric, pneumatic or hydraulic energy) is transmitted to the trailer by the towing vehicle and is controlled only by the thrust on the coupling do not constitute inertia braking systems within the meaning of this Regulation.
- 1.6. Tests
 - 1.6.1. Determination of essential components of the brake.
 - 1.6.2. Determination of essential components of the control device and verification of the latter's conformity with the provisions of this Regulation.
 - 1.6.3. Checking on the vehicle:
 - (a) the compatibility of the control device and the brake; and
 - (b) the transmission.

2. SYMBOLS AND DEFINITIONS

2.1. Units used

- 2.1.1. Mass: kg;

2.1.2. Force: N;

2.1.3. Acceleration due to gravity: $g = 10 \text{ m/s}^2$

2.1.4. Torques and moments: Nm;

2.1.5. Areas: cm^2 ;

2.1.6. Pressures: kPa;

2.1.7. Lengths: unit specified in each case.

2.2. Symbols valid for all types of brakes (see Figure 1 of appendix 1 to this annex)

2.2.1. G_A : trailer's technically permissible "maximum mass" as declared by the manufacturer;

2.2.2. G'_A : trailer's "maximum mass" capable of being braked by the control device, as declared by the manufacturer;

2.2.3. G_B : trailer's "maximum mass" capable of being braked by joint operation of all of the trailer's brakes

$$G_B = n \cdot G_{B0};$$

2.2.4. G_{B0} : fraction of trailer's permissible "maximum mass" capable of being braked by one brake, as declared by the manufacturer;

2.2.5. B^* : required braking force;

2.2.6. B : required braking force taking account of rolling resistance;

2.2.7. D^* : permissible thrust on coupling;

2.2.8. D : thrust on coupling;

2.2.9. P' : control device output force;

2.2.10. K : supplementary force of control device, conventionally designated by the force D corresponding to the point of intersection with the axis of the abscissae of the extrapolated curve expressing P' in terms of D , measured with the device in the mid-travel position (see Figures 2 and 3 of appendix 1 to this annex);

- 2.2.11. K_A : stress threshold of control device, i.e., the maximum thrust on the coupling head which can be applied for a short time without placing any stress on the output side of the control device. The symbol K_A is conventionally applied to the force measured when the coupling head begins to be pushed home at a speed of 10 to 15 mm/s, the control device transmission being uncoupled;
- 2.2.12. D_1 : the maximum force applied to the coupling head when it is being pushed home at a speed of s mm/s \pm 10 per cent, the transmission being uncoupled;
- 2.2.13. D_2 : the maximum force applied to the coupling head when it is being pulled at a speed of s mm/s \pm 10 per cent out of the position of maximum compression, the transmission being uncoupled;
- 2.2.14. η_{H0} : efficiency of inertia control device;
- 2.2.15. η_{H1} : efficiency of transmission system;
- 2.2.16. η_H : overall efficiency of control device and transmission $\eta_H = \eta_{H0} \cdot \eta_{H1}$;
- 2.2.17. s : travel of control in millimetres;
- 2.2.18. s' : effective (useful) travel of control in millimetres, determined as required by paragraph 9.4. of this annex;
- 2.2.19. s'' : spare travel of master cylinder, measured in millimetres at coupling head;
- 2.2.19.1. s_{HZ} : stroke of the master cylinder in millimetres according to figure 8 of appendix 1 to this annex;
- 2.2.19.2. s''_{HZ} : spare travel of the master cylinder in millimetres at piston rod, according to figure 8;
- 2.2.20. s_0 : loss of travel, i.e., travel in millimetres of the coupling head when the latter is so actuated as to move from 300 mm above to 300 mm below the horizontal, the transmission remaining stationary;
- 2.2.21. 2_{SB} : brake-shoe lift (brake-shoe application travel), in millimetres, measured on diameter parallel to applying device, the brakes not being adjusted during the test;
- 2.2.22. 2_{SB}^* : minimum brake shoe centre lift (minimum brake shoe application travel) (in millimetres) for wheel brakes with drum brakes

$$2_{SB}^* = 2.4 + \frac{4}{1000} \cdot 2r$$

$2r$ being the diameter of the brake drum in millimetres; (see appendix 1, Figure 4, to this annex)

for wheel brakes with disc brakes with hydraulic transmission

$$2s_B^* = 1.1 \cdot \frac{10 \cdot V_{60}}{F_{RZ}} + \frac{1}{1000} \cdot 2r_A$$

where:

V_{60} = fluid volume absorbed by one wheel brake at a pressure corresponding to a braking force of $1.2 B^* = 0.6 \cdot G_{B0}$ and a max. tyre radius.

and

$2r_A$ = outer diameter of brake disc.

(V_{60} in cm^3 , F_{RZ} in cm^2 and r_A in mm)

- 2.2.23. M^* : Braking torque as specified by the manufacturer in paragraph 5. of appendix 3. This braking torque shall produce at least the prescribed braking force B^* ;
- 2.2.23.1. M_T : Test braking torque in the case when no overload protector is fitted (according to paragraph 6.2.1. below);
- 2.2.24. R : dynamic tyre rolling radius (m);
- 2.2.25. n : number of brakes.
- 2.2.26. M_r : Maximum braking torque resulting from the maximum permissible travel s_r or the maximum permissible fluid volume V_r when the trailer moves rearward (including rolling resistance = $0.01 \cdot g \cdot G_{B0}$);
- 2.2.27. s_r : Maximum permissible travel at the brake control lever when the trailer moves rearward;
- 2.2.28. V_r : Maximum permissible fluid volume absorbed by one braking wheel when the trailer moves rearward;
- 2.2.29. D_A : Application force at input side of the control device, at which the overload protector is activated.
- 2.2.30. M_A : Braking torque at which the overload protector is activated.

2.3. Symbols valid for mechanical-transmission braking systems (see Figure 5 of appendix 1 to this annex);

2.3.1. i_{H0} : reduction ratio between travel of coupling head and travel of lever at output side of control device;

2.3.2. i_{H1} : reduction ratio between travel of lever at output side of control device and travel of brake lever (gearing down of transmission);

2.3.3. i_H : reduction ratio between travel of coupling head and travel of brake lever

$$i_H = i_{H0} \cdot i_{H1}$$

2.3.4. i_g : reduction ratio between travel of brake lever and lift (application travel) at brake-shoe centre (see Figure 4 of appendix 1 to this annex);

2.3.5. P : force applied to the brake control lever; (see Figure 4 of appendix 1 to this annex);

2.3.6. P_o : Brake-retraction force when the trailer moves forward; i.e., in graph $M = f(P)$, the value of the force P at the point of intersection of the extrapolation of this function with the abscissa (see Figure 6 of appendix 1 to this annex);

2.3.6.1. P_{or} : brake-retraction force when the trailer moves rearward (see Figure 6 of appendix 1 to this annex);

2.3.7. P^* : Force applied to the brake control lever to produce the braking force B^* ;

2.3.8. P_T : test force according to paragraph 6.2.1.;

2.3.9. ρ : characteristic of the brake when the trailer moves forward as defined from:

$$M = \rho (P - P_o)$$

2.3.9.1. ρ_r : characteristic of the brake when the trailer moves rearward as defined from:

$$M_r = \rho_r (P_r - P_{or})$$

2.4. Symbols valid for hydraulic-transmission braking systems (see Figure 8 of appendix 1 to this annex)

2.4.1. i_h : reduction ratio between travel of coupling head and travel of piston in master cylinder;

- 2.4.2. i'_g : reduction ratio between travel of cylinder thrust point and lift (application travel) of brake-shoe centre;
- 2.4.3. F_{RZ} : Surface area of piston of one wheel cylinder for drum brake(s); for disc brake(s), sum of the surface area of the caliper piston(s) on one side of the disc.
- 2.4.4. F_{HZ} : surface area of piston in master cylinder;
- 2.4.5. p : hydraulic pressure in brake cylinder;
- 2.4.6. p_o : retraction pressure in the brake cylinder when the trailer moves forward; i.e., in graph of $M = f(p)$, the value of the pressure p at the point of intersection of the extrapolation of this function with the abscissa (see Figure 7 of appendix 1 to this annex);
- 2.4.6.1. p_{or} : brake retraction pressure when the trailer moves rearward (see Figure 7 of appendix 1 to this annex);
- 2.4.7. p^* : Hydraulic pressure in the brake cylinder to produce the braking force B^* ;
- 2.4.8. p_T : Test pressure according to paragraph 6.2.1.:
- 2.4.9. ρ' : characteristic of the brake when the trailer moves forward as defined from:

$$M = \rho' (p - p_o)$$
- 2.4.9.1. ρ'_r : characteristic of the brake when the trailer moves rearward as defined from:

$$M_r = \rho'_r (p_r - p_{or})$$
- 2.5. Symbols with respect to the braking requirements relating to overload protectors
- 2.5.1. D_{op} : Application force at the input side of the control device, at which the overload protector is activated
- 2.5.2. M_{op} : Brake torque at which the overload protector is activated (as declared by the manufacturer)
- 2.5.3. M_{Top} : Minimum test braking torque in the case when an overload protector is fitted (according to paragraph 6.2.2.2.)
- 2.5.4. P_{op_min} : Force applied to the brake at which the overload protector is activated (according to paragraph 6.2.2.1.)

- 2.5.5. P_{op_max} : Maximum force (when the coupling head is pushed fully home) which is applied by the overload protector to the brake (according to paragraph 6.2.2.3.)
- 2.5.6. p_{op_min} : Pressure applied to the brake at which the overload protector is activated (according to paragraph 6.2.2.1.)
- 2.5.7. p_{op_max} : Maximum hydraulic pressure (when the coupling head is pushed fully home) which is applied by the overload protector to the brake actuator (according to paragraph 6.2.2.3.)
- 2.5.8. P_{Top} : Minimum test brake force in the case when an overload protector is fitted (according to paragraph 6.2.2.2.)
- 2.5.9. p_{Top} : Minimum test brake pressure in the case when an overload protector is fitted (according to paragraph 6.2.2.2.)

3. GENERAL REQUIREMENTS

- 3.1. The transmission of force from the coupling head to the trailer's brakes must be effected either by rod linkage or by one or more fluids. However, a sheathed cable (Bowden cable) may provide part of the transmission; this part must be as short as possible.
- 3.2. All bolts at joints must be adequately protected. In addition, these joints must be either self-lubricating or readily accessible for lubrication.
- 3.3. Inertia braking devices must be so arranged that in the case when the coupling head travels to its fullest extent, no part of the transmission seizes, undergoes permanent distortion, or breaks. This must be checked by uncoupling the end of the transmission from the brake control levers.
- 3.4. The inertia braking system must allow the trailer to be reversed with the towing vehicle without imposing a sustained drag force exceeding $0.08 g \cdot G_A$. Devices used for this purpose must act automatically and disengage automatically when the trailer moves forward.
- 3.5. Any special device incorporated for the purpose of paragraph 3.4. of this annex shall be such that the parking performance when facing up a gradient shall not be adversely affected.
- 3.6. Inertia braking systems may incorporate overload protectors. They must not be activated at a force of less than $D_{op} = 1.2 \cdot D^*$ (when fitted at the control device) or at a

force of less than $P_{op} = 1.2 \cdot P^*$ or at a pressure of less than $p_{op} = 1.2 \cdot p^*$ (when fitted at the wheel brake) where the force P^* or the pressure p^* corresponds to a braking force of $B^* = 0,5 \cdot g \cdot G_{B0}$.

4. REQUIREMENTS FOR CONTROL DEVICES

- 4.1. The sliding members of the control device must be long enough to enable the full travel to be used even when the trailer is coupled.
- 4.2. The sliding members must be protected by a bellows or some equivalent device. They must either be lubricated or be constructed of self-lubricating materials. The surfaces in frictional contact must be made of a material such that there is neither electrochemical torque nor any mechanical incompatibility liable to cause the sliding members to seize.
- 4.3. The stress threshold (K_A) of the control device must be not less than $0.02 g G'_A$ and not more than $0.04 g G'_A$.
- 4.4. The maximum insertion force D_1 may not exceed $0.10 g G'_A$ in trailers with rigid drawbars and $0.067 g G'_A$ in multi-axled trailers with pivoted drawbars.
- 4.5. The maximum tractive force D_2 must be not less than $0.1 g G'_A$ and not more than $0.5 g G'_A$.

5. TESTS AND MEASUREMENTS TO BE CARRIED OUT ON THE CONTROL DEVICES

- 5.1. Control devices submitted to the Technical Service conducting the tests must be checked for conformity with the requirements of paragraphs 3 and 4 of this annex.
- 5.2. The following shall be measured in respect of all types of brakes:
 - 5.2.1. travel s and effective travel s' ;
 - 5.2.2. supplementary force K ;
 - 5.2.3. stress threshold K_A ;
 - 5.2.4. insertion force D_1 ;
 - 5.2.5. tractive force D_2 .
- 5.3. In the case of mechanical-transmission inertia braking systems, the following should be determined:

- 5.3.1. the reduction ratio i_{H0} measured at the mid-travel position of the control;
- 5.3.2. the control-device output force P' as a function of the thrust D on the drawbars.

The supplementary force K and the efficiency are derived from the representative curve obtained from these measurements

$$\eta_{H0} = \frac{1}{i_{H0}} \cdot \frac{P'}{D - K}$$

(see Figure 2 of appendix 1 to this annex)

- 5.4. In the case of hydraulic-transmission inertia braking systems, the following should be determined:

- 5.4.1. the reduction ratio i_h measured at the mid-travel position of the control;
- 5.4.2. the master cylinder output pressure p as a function of the thrust D on the drawbars and of the surface area F_{HZ} of the master-cylinder piston, as specified by the manufacturer. The supplementary force K and the efficiency are derived from the representative curve obtained from these measurements

$$\eta_H = \frac{1}{i_h} \cdot \frac{p \cdot F_{HZ}}{D - K}$$

(see Figure 3 of appendix 1 to this annex);

- 5.4.3. the spare travel of the master cylinder s'' , as referred to in paragraph 2.2.19. of this annex.
- 5.4.4. surface area F_{HZ} of the piston in the master cylinder.
- 5.4.5. stroke s_{HZ} of the master cylinder (in millimetres).
- 5.4.6. spare travel s''_{HZ} of the master cylinder (in millimetres).
- 5.5. In the case of inertia braking system on multi-axled trailers with pivoted drawbars, the loss of travel s_0 referred to in paragraph 9.4.1. of this annex should be measured.

6. REQUIREMENTS FOR BRAKES

- 6.1. In addition to the brakes to be checked, the manufacturer shall submit to the Technical Service conducting the tests, drawings of the brakes showing the type, dimensions and

material of the essential components and the make and type of the linings. In the case of hydraulic brakes, these drawings shall show the surface area F_{RZ} of the brake cylinders. The manufacturer shall also specify the braking torque M^* and the mass G_{Bo} defined in paragraph 2.2.4. of this annex.

6.2. Testing conditions

6.2.1. In the case when an overload protector is neither fitted nor intended to be fitted within the inertia (overrun) braking system, the wheel brake shall be tested with the following test forces or pressures:

$$P_T = 1.8 P^* \text{ or } p_T = 1.8 p^* \text{ and } M_T = 1.8 M^* \text{ as appropriate.}$$

6.2.2. In the case when an overload protector is fitted or intended to be fitted within the inertia (overrun) braking system, the wheel brake shall be tested with the following test forces or pressures:

6.2.2.1. The minimum design values for overload protector shall be specified by the manufacturer and shall not be less than

$$P_{op} = 1.2 P^* \text{ or } p_{op} = 1.2 p^*$$

6.2.2.2. The ranges of minimum test force P_{Top} or minimum test pressure p_{Top} and the minimum test torque M_{Top} are:

$$P_{Top} = 1.1 \text{ to } 1.2 P^* \text{ or } p_{Top} = 1.1 \text{ to } 1.2 p^* \quad \text{and} \\ M_{Top} = 1.1 \text{ to } 1.2 M^*$$

6.2.2.3. The maximum values (P_{op_max} or p_{op_max}) for the overload protector shall be specified by the manufacturer and shall not be more than P_T or p_T respectively.

7. TESTS AND MEASUREMENTS TO BE CARRIED OUT ON THE BRAKES

7.1. Brakes and components submitted to the Technical Service conducting the tests must be tested for conformity with the requirements of paragraph 6 of this annex.

7.2. The following should be determined:

7.2.1. The minimum brake-shoe lift (minimum brake-shoe application travel), $2S_{B^*}$;

7.2.2. The brake-shoe lift (brake-shoe application travel) $2S_B$ (which must be greater than $2S_{B^*}$);

7.3. In the case of mechanical brakes, the following shall be determined:

- 7.3.1. Reduction ratio i_g (see Figure 4 of appendix 1 to this annex)
- 7.3.2. Force P^* for braking torque M^*
- 7.3.3. Torque M^* as a function of the force P^* applied to the control lever in mechanical-transmission systems. The rotational speed of the braking surfaces shall correspond to an initial vehicle speed of 60 km/h when the trailer moves forward and 6 km/h when the trailer moves rearward. The following shall be derived from the curve obtained from these measurements (see Figure 6 of appendix 1 to this annex):
- 7.3.3.1. The brake-retraction force P_o and the characteristic value ρ when the trailer moves forward
- 7.3.3.2. The brake-retraction force P_{or} and the characteristic value ρ_r when the trailer moves rearward
- 7.3.3.3. Maximum braking torque M_r up to the maximum permissible travel s_r when the trailer moves rearward (see Figure 6 of appendix 1 to this annex)
- 7.3.3.4. Maximum permissible travel at the brake control lever when the trailer moves rearward (see Figure 6 of appendix 1 to this annex).
- 7.4. In the case of hydraulic brakes, the following should be determined:
- 7.4.1. Reduction ratio i_g' (see Figure 8 of appendix 1 to this annex)
- 7.4.2. Pressure p^* for braking torque M^*
- 7.4.3. Torque M^* as a function of the pressure p^* applied to the brake cylinder in hydraulic transmission systems.
- The rotational speed of the braking surfaces shall correspond to an initial vehicle speed of 60 km/h when the trailer moves forward and 6 km/h when the trailer moves rearward. The following shall be derived from the curve obtained from these measurements (see Figure 7 of appendix 1 to this annex):
- 7.4.3.1. The retraction pressure p_o and the characteristic ρ' when the trailer moves forward
- 7.4.3.2. The retraction pressure p_{or} and the characteristic ρ_r' when the trailer moves rearward

- 7.4.3.3. Maximum braking torque M_r up to the maximum permissible fluid volume V_r when the trailer moves rearward (see Figure 7 of appendix 1 to this annex)
- 7.4.3.4. Maximum permissible fluid volume V_r absorbed by one braking wheel when the trailer moves rearward (see figure 7 of appendix 1).
- 7.4.4. Surface area F_{RZ} of the piston in the brake cylinder.
- 7.5. Alternative procedure for the Type-I test
- 7.5.1. The Type-I test according to annex 4, paragraph 1.5. does not have to be carried out on a vehicle submitted for type approval, if the braking system components are tested on an inertia test bench to meet the prescriptions of annex 4, paragraphs 1.5.2. and 1.5.3.
- 7.5.2. The alternative procedure for the Type-I test shall be carried out in accordance with the provisions laid down in annex 11, appendix 2, paragraph 3.5.2. (in analogy also applicable for disc brakes).

8. TEST REPORTS

Applications for the approval of trailers equipped with inertia braking systems shall be accompanied by the test reports relating to the control device and the brakes and the test report on the compatibility of the inertia type control device, the transmission device and the brakes of the trailer, these reports including at least the particulars prescribed in appendices 2, 3, and 4 to this annex.

9. COMPATIBILITY BETWEEN THE CONTROL DEVICE AND THE BRAKES OF A VEHICLE

- 9.1. A check must be made on the vehicle to verify in the light of the characteristics of the control device (appendix 2), the characteristics of the brakes (appendix 3), and the trailer characteristics referred to in paragraph 4 of appendix 4 to this annex, whether the trailer's inertia braking system meets the prescribed requirements.
- 9.2. General checks for all types of brakes
- 9.2.1. Any parts of the transmission not checked at the same time as the control device or the brakes must be checked on the vehicle. The results of the check must be entered in appendix 4 to this annex (e.g., i_{H1} and η_{H1}).

9.2.2. Mass

9.2.2.1. The maximum mass G_A of the trailer must not exceed the maximum mass G'_A for which the control device is authorized.

9.2.2.2. The maximum mass G_A of the trailer must not exceed the maximum mass G_B which can be braked by joint operation of all of the trailer's brakes.

9.2.3. Forces

9.2.3.1. The stress threshold K_A must not be below $0.02 g G_A$ and not above $0.04 g G_A$.

9.2.3.2. The maximum insertion force D_1 may not exceed $0.100 g G_A$ in trailers with rigid drawbar and $0.067 g G_A$ in multi-axled trailers with pivoted drawbar.

9.2.3.3. The maximum tractive force D_2 must be between $0.1 g G_A$ and $0.5 g G_A$.

9.3. Check of braking efficiency

9.3.1. The sum of the braking forces exerted on the circumference of the trailer wheels must not be less than $B^* = 0.50 g G_A$, including a rolling resistance of $0.01 g G_A$: this corresponds to a braking force B of $0.49 g G_A$. In this case, the maximum permissible thrust on the coupling shall be:

$D^* = 0.067 g G_A$ in the case of multi-axled trailers with pivoted drawbar;
and

$D^* = 0.100 g G_A$ in the case of trailers with rigid drawbar.

To check whether these conditions are complied with the following inequalities must be applied:

9.3.1.1. In mechanical-transmission inertia braking systems:

$$\left[\frac{B.R}{\rho} + n P_o \right] \frac{1}{(D^* - K) \cdot \eta_H} \leq i_H$$

9.3.1.2. In hydraulic-transmission inertia braking systems:

$$\left[\frac{B.R}{n \cdot \rho'} + p_o \right] \frac{1}{(D^* - K) \cdot \eta_H} \leq \frac{i_h}{F_{HZ}}$$

9.4. Check of control travel

9.4.1. In control devices for multi-axled trailers with pivoted drawbars where the brake rod linkage depends on the position of the towing device, the control travel s must be longer than the effective (useful) control travel s' , the difference being at least equivalent to the loss of travel s_0 . The travel loss of s_0 must not exceed 10 per cent of the effective travel s' .

9.4.2. The effective (useful) travel of control s' shall be determined for single and multi-axle trailers as follows:

9.4.2.1. if the brake rod linkage is affected by the angular position of the towing device, then:

$$s' = s - s_0 ;$$

9.4.2.2. if there is no loss of travel, then:

$$s' = s ;$$

9.4.2.3. in hydraulic braking systems:

$$s' = s - s''.$$

9.4.3. The following inequalities shall be applied to check whether control travel is adequate;

9.4.3.1. In mechanical-transmission inertia braking systems:

$$i_H \leq \frac{s'}{S_B^* \cdot i_g}$$

9.4.3.2. in hydraulic-transmission inertia braking systems:

$$\frac{i_h}{F_{HZ}} \leq \frac{s'}{2 S_B^* \cdot n F_{RZ} \cdot i'_g}$$

9.5. Additional checks

9.5.1. In mechanical-transmission inertia braking systems a check shall be made to verify that the rod linkage by which the forces are transmitted from the control device to the brakes is correctly fitted.

9.5.2. In hydraulic-transmission inertia braking systems a check shall be made to verify that the travel of the master cylinder is not less than s/i_h . A lower level shall not be permitted.

9.5.3. The general behaviour of the vehicle when braking shall be the subject of a road test carried out at different road speeds with different levels of brake effort and rates of application. Self-excited, undamped oscillations shall not be permitted.

10. GENERAL COMMENTS

The above requirements apply to the most usual embodiments of mechanical-transmission or hydraulic-transmission inertia braking systems where, in particular, all of the trailer's wheels are equipped with the same type of brake and the same type of tyre. For checking less usual embodiments, the above requirements must be adapted to the circumstances of the particular case.

Annex 12 - Appendix 1

Figure 1: SYMBOLS VALID FOR ALL TYPES OF BRAKES
(See paragraph 2.2. of this annex)

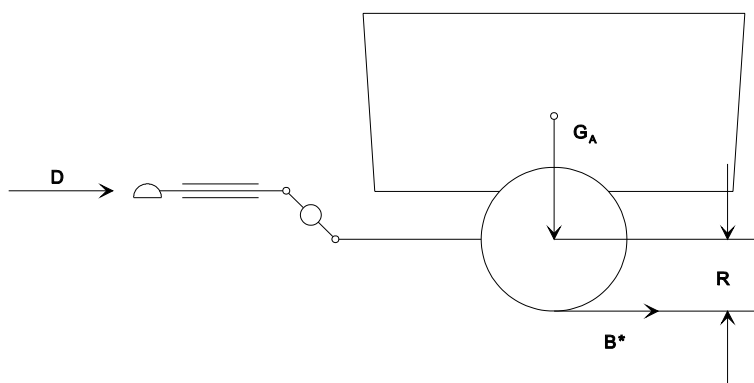
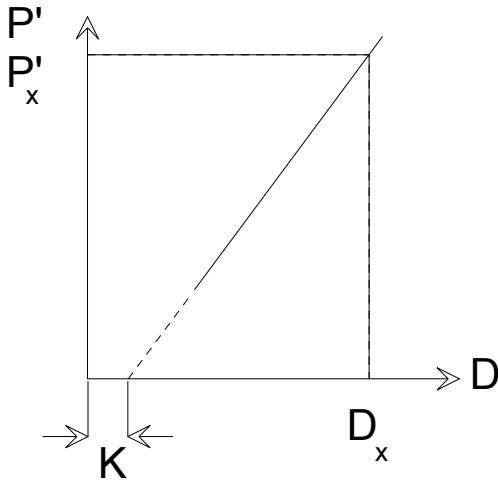
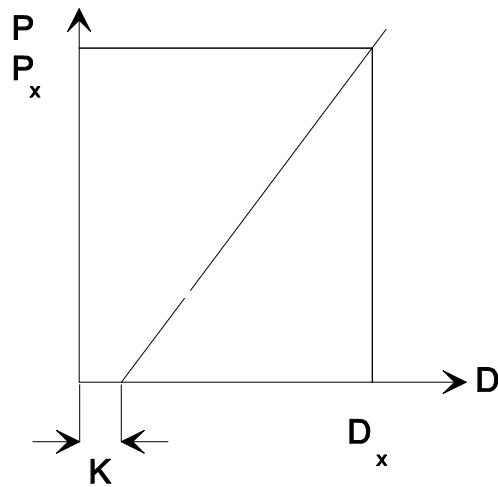

Figure 2: MECHANICAL-TRANSMISSION
 (See paragraphs 2.2.10. and 5.3.2. of this annex)



$$\eta_{H0} = \frac{P'_x}{D_x - K} \cdot \frac{1}{i_H}$$

Figure 3: HYDRAULIC-TRANSMISSION
 (See paragraphs 2.2.10. and 5.4.2. of this annex)



$$\eta_{H0} = \frac{P_x}{D_x - K} \cdot \frac{F_{Hz}}{i_H}$$

Figure 4: BRAKE CHECKS
 (See paragraphs 2.2.22. and 2.3.4. of this annex)

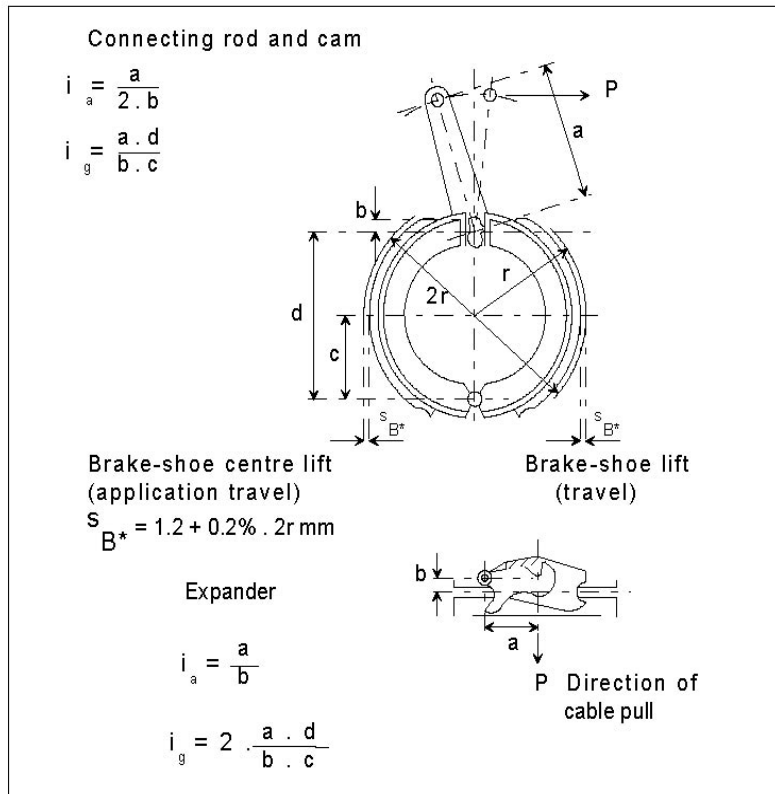
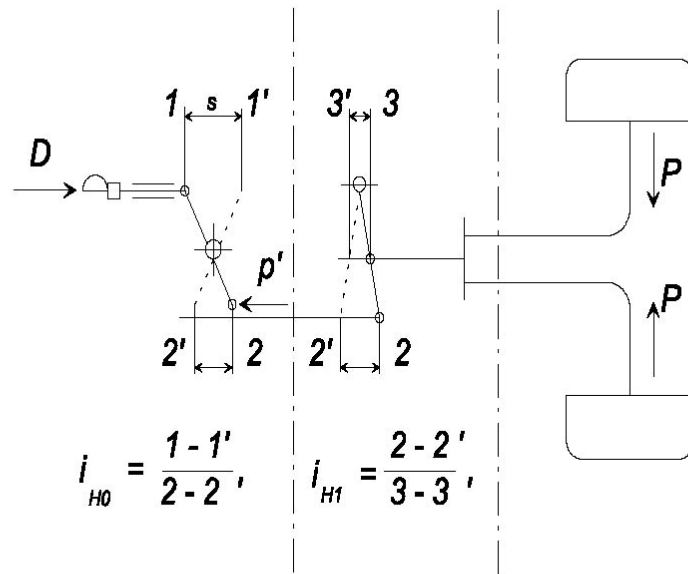

Figure 5: MECHANICAL-TRANSMISSION BRAKING SYSTEM
 (See paragraph 2.3. of this annex)



1.2 Control device 1.3 Transmission 1.4 Brakes

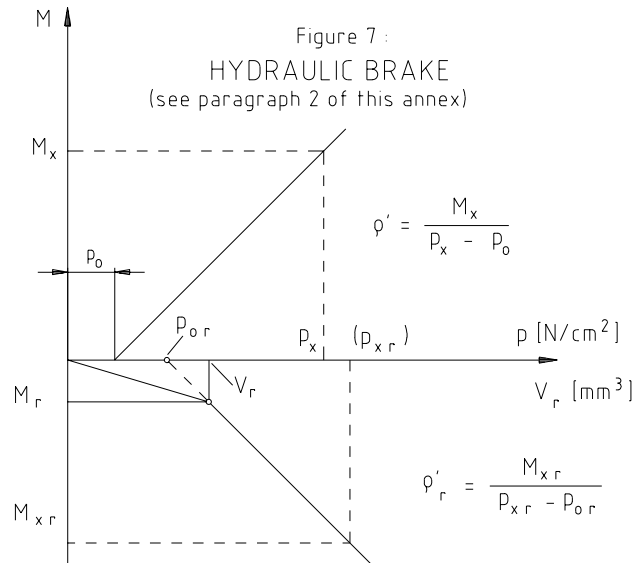
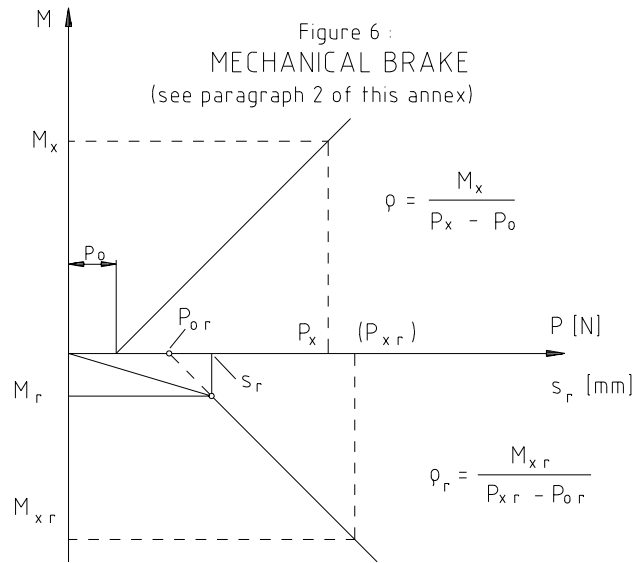
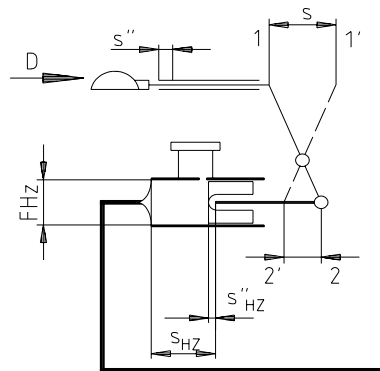

Figure 8: HYDRAULIC-TRANSMISSION BRAKING SYSTEM

(see paragraph 2 of this annex)

1.2 Control device



$$i_h = \frac{1 - 1'}{2 - 2'}$$

1.4 Brakes

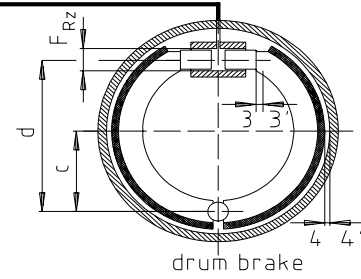

drum brake

$$i_g' = \frac{d}{c} = \frac{3 - 3'}{4 - 4'}$$

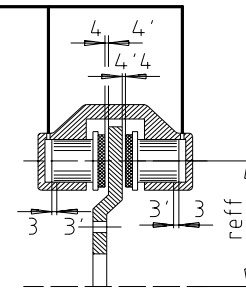

disc brake

$$i_g' = \frac{r_{eff}}{r_{eff}} = \frac{3 - 3'}{4 - 4'} = 1$$

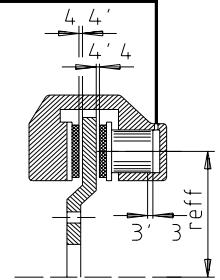

disc brake

$$i_g' = \frac{r_{eff}}{r_{eff}} = \frac{3 - 3'}{2(4 - 4')} = 1$$

Annex 12 - Appendix 2

TEST REPORT ON INERTIA-BRAKING SYSTEM CONTROL DEVICE

1. Manufacturer
2. Make
3. Type
4. Characteristics of trailers for which control device intended by manufacturer:
 - 4.1. mass $G'_A =$ kg
 - 4.2. permissible static vertical force at towing-device head N
 - 4.3. trailer with rigid drawbar/multi-axled trailer with pivoted drawbar 1/
5. Brief description
(List of attached plans and dimensioned drawings)
6. Diagram showing principle of control
7. Travel $s =$ mm
8. Reduction ratio of control device:
 - 8.1. with mechanical transmission device 1/
 $i_{H0} =$ from to2/
 - 8.2. with hydraulic transmission device 1/
 $i_h =$ from to2/
 $F_{HZ} =$ cm^2
travel of master cylinder s_{HZ} mm
spare travel of master cylinder s''_{HZ} mm

9. Test results:
- 9.1. Efficiency
- with mechanical transmission device $\underline{1/}$ $\eta_H = \dots\dots\dots$
- with hydraulic transmission device $\underline{1/}$ $\eta_H = \dots\dots\dots$
- 9.2. Supplementary force $K = \dots\dots\dots$ N
- 9.3. Maximum compressive force $D_1 = \dots\dots\dots$ N
- 9.4. Maximum tractive force $D_2 = \dots\dots\dots$ N
- 9.5. Stress threshold $K_A = \dots\dots\dots$ N
- 9.6. Loss of travel and spare travel:
where the position of the drawing device
has an effect $s_o \underline{1/} = \dots\dots\dots$ mm
- with a hydraulic-transmission device $s'' \underline{1/} = s''_{Hz} \cdot i_h = \dots\dots\dots$ mm
- 9.7. Effective (useful) travel of control $s' = \dots\dots\dots$ mm
- 9.8. An overload protector according to paragraph 3.6. of this annex is provided / not provided $\underline{1/}$
- 9.8.1. If the overload protector is fitted before the transmission lever of the control device
- 9.8.1.1. Threshold force of the overload protector
 $D_{op} = \dots\dots\dots$ N
- 9.8.1.2. Where the overload protector is mechanical $\underline{1/}$
max. force which the inertia control device can develop
 $P'_{max}/i_{Ho} = P_{op_max} = \dots\dots\dots$ N
- 9.8.1.3. Where the overload protector is hydraulic $\underline{1/}$
the pressure which the inertia control device can develop
 $p'_{max}/i_h = p_{op_max} = \dots\dots\dots$ N/cm²

9.8.2. If the overload protector is fitted after the transmission lever of the control device

9.8.2.1. Threshold force on the overload protector

where the overload protector is mechanical 1/

$D_{op.i_{H0}} = \dots\dots\dots N$

where the overload protector is hydraulic 1/

$D_{op.i_h} = \dots\dots\dots N$

9.8.2.2. Where the overload protector is mechanical 1/

max force which the inertia control device can develop

$P'_{max} = P_{op_max} = \dots\dots\dots N$

9.8.2.3. Where the overload protector is hydraulic 1/

the pressure which the inertia control device can develop

$P'_{max} = P_{op_max} = \dots\dots\dots N/cm^2$

10. The control device described above complies/does not comply 1/ with the requirements of paragraphs 3, 4 and 5 of this annex.

Date.....

Signature.....

11. This test has been carried out and the results reported in accordance with relevant provisions of annex 12 to ECE Regulation No. 13 as last amended by the series of amendments.

Technical Service 3/ carrying out the test

Signed:

Date:

12. Approval Authority 3/

Signed:

Date:

1/ Strike out what does not apply.

2/ State lengths whose ratio was used to determine i_{H0} or i_h .

3/ To be signed by different persons even when the Technical Service and Approval Authority are the same or alternatively, a separate Approval Authority authorisation issued with the report.

Annex 12 - Appendix 3

TEST REPORT ON THE BRAKE

1. Manufacturer
2. Make
3. Type
4. Permissible "maximum mass" per wheel $G_{Bo} =$ kg
5. Braking torque M^* (as specified by the manufacturer according to paragraph 2.2.23. of this annex) = Nm
6. Dynamic tyre rolling radius
 $R_{min} =$ m; $R_{max} =$ m
7. Brief description
(List of plans and dimensioned drawings)
8. Diagram showing principle of brake
9. Test result:

<u>mechanical brake 1/</u>	<u>hydraulic brake 1/</u>
9.1. Reduction ratio $i_g =$ <u>2/</u>	9.1.A. Reduction ratio $i'_g =$ <u>2/</u>
9.2. Lift (application travel) $s_B =$ mm	9.2.A. Lift (application travel) $s_B =$ m
9.3. Prescribed lift (prescribed application travel) $s_{B^*} =$ mm	9.3.A. Prescribed lift (prescribed application travel) $s_{B^*} =$ mm
9.4. Retraction force $P_o =$ N	9.4.A. Retraction pressure $p_o =$ N/cm ²
9.5. Coefficient (characteristic) $\rho =$ m	9.5.A. Coefficient (characteristic) $\rho' =$ m
9.6. An overload protector according to paragraph 3.6. of this annex is/is not provided <u>1/</u>	9.6.A. An overload protector according to paragraph 3.6. of this annex is/is not provided <u>1/</u>

- | | | | |
|-----------|---|----------|--|
| 9.6.1. | Braking torque activating the overload protector
$M_{op} = \dots\dots\dots \text{Nm}$ | 9.6.1.A. | Braking torque activating the overload protector
$M_{op} = \dots\dots\dots \text{Nm}$ |
| 9.7. | Force for M^*
$P^* = \dots\dots\dots \text{N}$ | 9.7.A. | Pressure for M^*
$P^* = \dots\dots\dots \text{N/cm}^2$ |
| | | 9.8.A. | Surface area of wheel cylinder
$F_{RZ} = \dots\dots\dots \text{cm}^2$ |
| | | 9.9.A. | (for disk brakes)
Fluid volume absorption
$V_{60} = \dots\dots\dots \text{cm}^3$ |
| 9.10. | Service brake performance when the trailer moves rearwards (see figures 6 and 7 of appendix 1 to this annex) | | |
| 9.10.1. | Maximum Fig 6 braking torque $M_r = \dots\dots\dots \text{Nm}$ | | |
| 9.10.1.A. | Maximum Fig 7 braking torque $M_r = \dots\dots\dots \text{Nm}$ | | |
| 9.10.2. | Maximum permissible travel $s_r = \dots\dots\dots \text{mm}$ | | |
| 9.10.2.A. | Maximum permissible fluid volume absorbed $V_r = \dots\dots\dots \text{cm}^3$ | | |
| 9.11. | Further brake characteristics when the trailer moves rearwards (see figures 6 and 7 of appendix 1 to this annex) | | |
| 9.11.1. | Brake-retraction force $P_{or} = \dots\dots\dots \text{N}$ | | |
| 9.11.1.A. | Brake-retraction pressure $p_{or} = \dots\dots\dots \text{N/cm}^2$ | | |
| 9.11.2. | Brake characteristic $\rho_r = \dots\dots\dots \text{m}$ | | |
| 9.11.2.A. | Brake characteristic $\rho'_r = \dots\dots\dots \text{m}$ | | |
| 9.12. | Tests according to paragraph 7.5. of this annex (if applicable) (corrected to take account of the rolling resistance corresponding to $0.01 \cdot g \cdot G_{Bo}$) | | |

9.12.1. Brake test Type-0
Test speed = km/h
Braking ratio = %
Control force = N

9.12.2. Brake test Type-I
Test speed = km/h
Sustained braking ratio = %
Braking time = minutes
Hot performance = %
(expressed as a % of the above Type-0 test result in item 9.12.1.)
Control force = N

10. The above brake does / does not 1/ conform to the requirements of paragraphs 3 and 6 of the testing conditions for vehicles fitted with inertia braking systems described in this annex.
The brake may / may not 1/ be used for an inertia braking system without an overload protector.

Date:

Signature:.....

11. This test has been carried out and the results reported in accordance with relevant provisions of annex 12 to ECE Regulation No. 13 as last amended by the series of amendments.

Technical Service 3/ carrying out the test

Date:

Signature:.....

12. Approval Authority 3/

Date:

Signature:.....

1/ Strike out what does not apply.

2/ State lengths used to determine i_g or i'_g

3/ To be signed by different persons even when the Technical Service and Approval Authority are the same or alternatively, a separate Approval Authority authorisation issued with the report.

Annex 12 - Appendix 4

TEST REPORT ON THE COMPATIBILITY OF THE INERTIA BRAKE CONTROL DEVICE,
THE TRANSMISSION AND THE BRAKES ON THE TRAILER

1. Control device
described in the attached test report (see appendix 2 to this annex)
Reduction ratio selected:
 i_{H0} 1/ = 2/ or i_h 1/ = 2/

(must be within the limits specified in paragraphs 8.1. or 8.2. of appendix 2 to this annex)
2. Brakes
described in the attached test report (see appendix 3 to this annex)
3. Transmission devices on the trailer
 - 3.1. Brief description with diagram showing principle
 - 3.2. Reduction ratio and efficiency of the mechanical-transmission device on the trailer
 i_{H1} 1/ = 2/
 η_{H1} 1/ =
4. Trailer
 - 4.1. Manufacturer
 - 4.2. Make
 - 4.3. Type
 - 4.4. Type of drawbar connection: trailer with rigid drawbar/multi-axled trailer with pivoted drawbar 1/
 - 4.5. Number of brakes n =
 - 4.6. Technically permissible maximum mass G_A = kg

1/ Strike out what does not apply.

2/ State lengths used to determine i_{H0} , i_h , i_{H1} .

- 4.7. Dynamic tyre rolling radius $R = \dots\dots\dots$ m
- 4.8. Permissible thrust on coupling
 $D^* = 0.100 \text{ g } G_A \underline{1}/ = \dots\dots\dots$ N
or
 $D^* = 0.067 \text{ g } G_A \underline{1}/ = \dots\dots\dots$ N
- 4.9. Required braking force $B^* = 0.50 \text{ g } G_A = \dots\dots\dots$ N
- 4.10. Brake force $B = 0.49 \text{ g } G_A = \dots\dots\dots$ N
5. Compatibility - Test results
- 5.1. Stress threshold $100 \cdot K_A / (\text{g} \cdot G_A) = \dots\dots\dots$
(must be between 2 and 4)
- 5.2. Maximum compressive force $100 \cdot D_1 / (\text{g} \cdot G_A) = \dots\dots\dots$
(must not exceed 10 for trailers with rigid drawbar, or 6.7 for multi-axled trailers with pivoted drawbar)
- 5.3. Maximum tractive force $100 \cdot D_2 / (\text{g} \cdot G_A) = \dots\dots\dots$
(must be between 10 and 50)
- 5.4. Technically permissible maximum mass for inertia control device
 $G'_A = \dots\dots\dots$ kg
(must not be less than G_A)
- 5.5. Technically permissible maximum mass for all of trailer's brakes
 $G_B = n \cdot G_{Bo} = \dots\dots\dots$ kg
(must not be less than G_A)
- 5.6. Braking torque of the brakes
 $n \cdot M_{\max} / (B \cdot R) = \dots\dots\dots$
(must be equal or greater than 1.0)
- 5.6.1. An overload protector within the meaning of paragraph 3.6. of this annex is / is not 1/
fitted on the inertia control device / on the brakes 1/
- 5.6.1.1. where the overload protector is mechanical on the inertia control device 1/
 $n \cdot P^* / (i_{HI} \cdot \eta_{HI} \cdot P'_{\max}) = \dots\dots\dots$
(must be equal or greater than 1.2)

5.6.1.2. where the overload protector is hydraulic on the inertia control device 1/
 $p^* / p'_{max} = \dots\dots\dots$
 (must be equal or greater than 1.2)

5.6.1.3. if the overload protector is on the inertia control device:
 threshold force $D_{op}/D^* = \dots\dots\dots$
 (must be equal or greater than 1.2)

5.6.1.4. if the overload protector is fitted on the brake:
 threshold torque $n \cdot M_{op}/(B \cdot R) = \dots\dots\dots$
 (must be equal or greater than 1.2)

5.7. Inertia braking system with mechanical transmission device 1/

5.7.1. $i_H = i_{H0} \cdot i_{H1} = \dots\dots\dots$

5.7.2. $\eta_H = \eta_{H0} \cdot \eta_{H1} = \dots\dots\dots$

5.7.3.

$$\left[\frac{B \cdot R}{\rho} + n \cdot P_o \right] \cdot \frac{1}{(D^* - K) \cdot \eta_H} = \dots\dots$$

(must not be greater than i_H)

5.7.4.

$$\frac{s'}{s_B^* \cdot i_g} = \dots\dots\dots$$

(must not be less than i_H)

5.7.5. Ratio $s'/i_H = \dots\dots\dots$
 when the trailer moves rearward (shall not exceed s_r)

5.7.6. Braking torque when the trailer moves rearward including rolling resistance
 $0.08 \cdot g \cdot G_A \cdot R = \dots\dots\dots$
 Nm (shall not exceed $n \cdot M_r$)

5.8. Inertia braking system with hydraulic transmission device 1/

5.8.1. $i_H/F_{HZ} = \dots\dots\dots$

5.8.2.

$$\left[\frac{B.R}{n \cdot \rho'} + p_o \right] \cdot \frac{1}{(D^* - K) \cdot \eta_H} = \dots\dots\dots$$

(must not be greater than i_h/F_{HZ})

5.8.3.

$$\frac{s'}{2 S_B \cdot n \cdot F_{RZ} \cdot i_{g'}} = \dots\dots\dots$$

(must not be less than i_h/F_{HZ})

5.8.4.

$s/i_h = \dots\dots\dots$
(must not be greater than travel of master cylinder actuator as specified in paragraph 8.2. of appendix 2 to this annex)

5.8.5.

Ratio $s'/F_{HZ} = \dots\dots\dots$
when the trailer moves rearward (shall not exceed V_T)

5.8.6.

Braking torque when the trailer moves rearward including rolling resistance
 $0.08 \cdot g \cdot G_A \cdot R = \dots\dots\dots$ Nm
(shall not exceed $n \cdot M_T$)

6. The inertia braking system described above complies/does not comply 1/ with the requirements of paragraphs 3 to 9 of this annex.

Date
Signature

7. This test has been carried out and the results reported in accordance with relevant provisions of annex 12 to ECE Regulation No. 13 as last amended by the series of amendments.

Technical Service 3/ carrying out the test

Date:
Signature:.....

3/ To be signed by different persons even when the Technical Service and Approval Authority are the same or alternatively, a separate Approval Authority authorization issued with the report.

E/ECE/324
E/ECE/TRANS/505 } ~~Rev.1/Add.12/Rev.5~~
Regulation No. 13
page 186
Annex 12 - Appendix 4

8. Approval Authority 3/

Date:
Signature:.....

Annex 13

TEST REQUIREMENTS FOR VEHICLES FITTED WITH
ANTI-LOCK SYSTEMS

1. GENERAL

- 1.1. This annex defines the required braking performance for road vehicles fitted with anti-lock systems. In addition, power-driven vehicles which are authorized to tow a trailer, and trailers equipped with compressed-air braking systems, shall, when the vehicles are laden, meet the requirements for compatibility set out in annex 10 to this Regulation.
- 1.2. The anti-lock systems known at present comprise a sensor or sensors, a controller or controllers and a modulator or modulators. Any device of a different design which may be introduced in the future, or where an anti-lock braking function is integrated into another system, shall be deemed to be an anti-lock braking system within the meaning of this annex and annex 10 to this Regulation, if it provides performance equal to that prescribed by this annex.

2. DEFINITIONS

- 2.1. An "anti-lock system" is a part of a service braking system which automatically controls the degree of slip, in the direction of rotation of the wheel(s), on one or more wheels of the vehicle during braking.
- 2.2. "Sensor" means a component designed to identify and transmit to the controller the conditions of rotation of the wheel(s) or the dynamic conditions of the vehicle.
- 2.3. "Controller" means a component designed to evaluate the data transmitted by the sensor(s) and to transmit a signal to the modulator.
- 2.4. "Modulator" means a component designed to vary the braking force(s) in accordance with the signal received from the controller.
- 2.5. "Directly controlled wheel" means a wheel whose braking force is modulated according to data provided at least by its own sensor. 1/
- 2.6. "Indirectly controlled wheel" means a wheel whose braking force is modulated according to data provided by the sensor(s) of other wheel(s). 1/

1/ Anti-lock systems with select-high control are deemed to include both directly and indirectly controlled wheels; in systems with select-low control, all sensed wheels are deemed to be directly controlled wheels.

- 2.7. "Full cycling" means that the anti-lock system is repeatedly modulating the brake force to prevent the directly controlled wheels from locking. Brake applications where modulation only occurs once during the stop shall not be considered to meet this definition.

In the case of trailers with pneumatic braking systems, full cycling of the anti-lock braking system is only assured when the pressure available at any brake actuator of a directly controlled wheel is more than **100 kPa** above the maximum cycling pressure throughout a given test. The supply pressure available may not be increased above **800 kPa**.

3. TYPES OF ANTI-LOCK SYSTEMS

- 3.1. A power-driven vehicle is deemed to be equipped with an anti-lock system within the meaning of paragraph 1 of annex 10 to this Regulation, if one of the following systems is fitted:

3.1.1. Category 1 anti-lock system

A vehicle equipped with a category 1 anti-lock system shall meet all the relevant requirements of this annex.

3.1.2. Category 2 anti-lock system

A vehicle equipped with a category 2 anti-lock system shall meet all the relevant requirements of this annex, except those of paragraph 5.3.5.

3.1.3. Category 3 anti-lock system

A vehicle equipped with a category 3 anti-lock system shall meet all the relevant requirements of this annex, except those of paragraphs 5.3.4. and 5.3.5. On such vehicles, any individual axle (or bogie) which does not include at least one directly controlled wheel must fulfil the conditions of adhesion utilization and the wheel-locking sequence of annex 10 to this Regulation, with regard to the braking rate and the load respectively. These requirements may be checked on high- and low-adhesion road surfaces (about 0.8 and 0.3 maximum) by modulating the service braking control force.

- 3.2. A trailer is deemed to be equipped with an anti-lock system within the meaning of paragraph 1 of annex 10 to this Regulation when at least two wheels on opposite sides of the vehicle are directly controlled and all remaining wheels are either directly or indirectly controlled by the anti-lock system. In the case of full trailers, at least two wheels on one front axle and two wheels on one rear axle are directly controlled with each of these axles having at least one independent modulator and

all remaining wheels are either directly or indirectly controlled. In addition, the anti-lock equipped trailer shall meet one of the following conditions:

3.2.1. Category A anti-lock system

A trailer equipped with a category A anti-lock system shall meet all the relevant requirements of this annex.

3.2.2. Category B anti-lock system

A trailer equipped with a category B anti-lock system shall meet all the relevant requirements of this annex, except paragraph 6.3.2.

4. GENERAL REQUIREMENTS

4.1. Any electrical failure or sensor anomaly that affects the system with respect to the functional and performance requirements in this annex, including those in the supply of electricity, the external wiring to the controller(s), the controller(s) 2/ and the modulator(s) shall be signalled to the driver by a specific optical warning signal. The yellow warning signal specified in paragraph 5.2.1.29.1.2. shall be used for this purpose.

4.1.1. Sensor anomalies, which cannot be detected under static conditions, shall be detected not later than when the vehicle speed exceeds 10 km/h 3/. However, to prevent erroneous fault indication when a sensor is not generating a vehicle speed output, due to non-rotation of a wheel, verification may be delayed but detected not later than when the vehicle speed exceeds 15 km/h.

4.1.2. When the anti-lock braking system is energized with the vehicle stationary, electrically controlled pneumatic modulator valve(s) shall cycle at least once.

4.2. Power-driven vehicles equipped with an anti-lock system and authorized to tow a trailer equipped with such a system, with the exception of vehicles of categories M₁ and N₁, shall be fitted with a separate optical warning signal for the anti-lock system of the trailer, meeting the requirements of paragraph 4.1. of this annex. The separate yellow warning signals specified in paragraph 5.2.1.29.2. shall be used for

2/ The manufacturer shall provide the Technical Service with documentation relating to the controller(s) which follows the format set out in annex 18.

3/ The warning signal may light up again while the vehicle is stationary, provided that it is extinguished before the vehicle speed reaches 10 km/h or 15 km/h, as appropriate, when no defect is present.

this purpose, activated via pin 5 of the electrical connector conforming to ISO 7638:1997 4/.

- 4.3. In the event of a failure in the anti-lock system, the residual braking performance shall be that prescribed for the vehicle in question in the event of a failure of part of the transmission of the service braking system (see paragraph 5.2.1.4. of this Regulation). This requirement shall not be construed as a departure from the requirements concerning secondary braking. In the case of trailers the residual braking performance in the event of a defect in the anti-lock system according to paragraph 4.1. shall be at least 80 per cent of the prescribed laden performance for the service braking system of the relevant trailer.
- 4.4. The operation of the anti-lock system shall not be adversely affected by magnetic or electrical fields. This shall be demonstrated by compliance with Regulation No. 10, 02 series of amendments.
- 4.5. A manual device may not be provided to disconnect or change the control mode 5/ of the anti-lock system, except on off-road power-driven vehicles of categories N₂ and N₃ as defined in annex 7 to the Consolidated Resolution on the Construction of Vehicles (R.E.3); where a device is fitted to N₂ or N₃ category vehicles, the following conditions must be met:
- 4.5.1. the power-driven vehicle with the anti-lock system disconnected or the control mode changed by the device referred to in paragraph 4.5. above must satisfy all the relevant requirements in annex 10 to this Regulation;
- 4.5.2. an optical warning signal shall inform the driver that the anti-lock system has been disconnected or the control mode changed; the yellow anti-lock failure warning signal specified in paragraph 5.2.1.29.1.2. may be used for this purpose. The warning signal may be constant or flashing;
- 4.5.3. the anti-lock system must automatically be reconnected/returned to on-road mode when the ignition (start) device is again set to the "ON" (run) position;
- 4.5.4. the vehicle user's handbook provided by the manufacturer should warn the driver of the consequences of manual disconnection or mode change of the anti-lock system;

4/ The ISO 7638:1997 connector may be used for 5 pin or 7 pin applications, as appropriate.

5/ It is understood that devices changing the control mode of the anti-lock system are not subject to paragraph 4.5. of this annex if in the changed control mode condition all requirements for the category of anti-lock systems, with which the vehicle is equipped, are fulfilled. However, in this case, paragraphs 4.5.2., 4.5.3. and 4.5.4. of this annex shall be met.

4.5.5. the device referred to in paragraph 4.5. above may, in conjunction with the towing vehicle, disconnect/change the control mode of the anti-lock system of the trailer. A separate device for the trailer alone is not permitted.

5. SPECIAL PROVISIONS CONCERNING POWER-DRIVEN VEHICLES

5.1. Energy consumption

Power-driven vehicles equipped with anti-lock systems must maintain their performance when the service braking control device is fully applied for long periods. Compliance with this requirement shall be verified by means of the following tests:

5.1.1. Test procedure

5.1.1.1. The initial energy level in the energy storage device(s) shall be that specified by the manufacturer. This level shall be at least such as to ensure the efficiency prescribed for service braking when the vehicle is laden. The energy storage device(s) for pneumatic auxiliary equipment must be isolated.

5.1.1.2. From an initial speed of not less than 50 km/h, on a surface with a coefficient of adhesion of 0.3 ^{6/} or less, the brakes of the laden vehicle shall be fully applied for a time t , during which time the energy consumed by the indirectly controlled wheels shall be taken into consideration and all directly controlled wheels must remain under control of the anti-lock system.

5.1.1.3. The vehicle's engine shall then be stopped or the supply to the energy transmission storage device(s) cut off.

5.1.1.4. The service braking control device shall then be fully actuated four times in succession with the vehicle stationary.

5.1.1.5. When the control device is applied for the fifth time, it must be possible to brake the vehicle with at least the performance prescribed for secondary braking of the laden vehicle.

5.1.1.6. During the tests, in the case of a power-driven vehicle authorized to draw a trailer equipped with a compressed-air braking system, the supply line shall be stopped and an energy storage device of 0.5 litre capacity shall be connected to the pneumatic control line - if fitted - (in accordance with paragraph 1.2.2.3. of Part A of annex 7

^{6/} Until such test surfaces become generally available, tyres at the limit of wear, and higher values up to 0.4 may be used at the discretion of the Technical Service. The actual value obtained and the type of tyres and surface shall be recorded.

to this Regulation). When the brakes are applied for the fifth time, as provided in paragraph 5.1.1.5. above, the energy level supplied to the pneumatic control line shall not be below half the level obtained at a full application starting with the initial energy level.

5.1.2. Additional requirements

5.1.2.1. The coefficient of adhesion of the road surface shall be measured with the vehicle under test, by the method described in paragraph 1.1. of appendix 2 to this annex.

5.1.2.2. The braking test shall be conducted with the engine disconnected and idling, and with the vehicle laden.

5.1.2.3. The braking time t shall be determined by the formula:

$$t = \frac{v_{\max}}{7} \text{ (but not less than 15 seconds)}$$

where t is expressed in seconds and v_{\max} represents the maximum design speed of the vehicle expressed in km/h, with an upper limit of 160 km/h.

5.1.2.4. If the time t cannot be completed in a single braking phase, further phases may be used, up to a maximum of four in all.

5.1.2.5. If the test is conducted in several phases, no fresh energy shall be supplied between the phases of the test.

From the second phase, the energy consumption corresponding to the initial brake application may be taken into account, by subtracting one full brake application from the four full applications prescribed in paragraph 5.1.1.4. (and 5.1.1.5., 5.1.1.6. and 5.1.2.6.) of this annex for each of the second, third and fourth phases used in the test prescribed in paragraph 5.1.1. of this annex as applicable.

5.1.2.6. The performance prescribed in paragraph 5.1.1.5. of this annex shall be deemed to be satisfied if, at the end of the fourth application, with the vehicle stationary, the energy level in the storage device(s) is at or above that required for secondary braking with the laden vehicle.

5.2. Utilization of adhesion

5.2.1. The utilization of adhesion by the anti-lock system takes into account the actual increase in braking distance beyond the theoretical minimum. The anti-lock system shall be deemed to be satisfactory when the condition $\varepsilon \geq 0.75$ is satisfied, where ε

represents the adhesion utilized, as defined in paragraph 1.2. of appendix 2 to this annex.

- 5.2.2. The adhesion utilization ϵ shall be measured on road surfaces with a coefficient of adhesion of 0.3 6/ or less, and of about 0.8 (dry road), with an initial speed of 50 km/h. To eliminate the effects of differential brake temperatures it is recommended that z_{AL} be determined prior to the determination of k .
- 5.2.3. The test procedure to determine the coefficient of adhesion (k) and the formulae for calculation of the adhesion utilization (ϵ) shall be those laid down in appendix 2 to this annex.
- 5.2.4. The utilization of adhesion by the anti-lock system shall be checked on complete vehicles equipped with anti-lock systems of categories 1 or 2. In the case of vehicles equipped with category 3 anti-lock systems, only the axle(s) with at least one directly controlled wheel must satisfy this requirement.
- 5.2.5. The condition $\epsilon \geq 0.75$ shall be checked with the vehicle both laden and unladen. 7/

The laden test on the high adhesion surface may be omitted if the prescribed force on the control device does not achieve full cycling of the anti-lock system.

For the unladen test, the control force may be increased up to 100 daN if no cycling is achieved with its full force value 8/. If 100 daN is insufficient to make the system cycle, then this test may be omitted. For air braking systems the air pressure may not be increased above the cut-out pressure for the purpose of this test.

5.3. Additional checks

The following additional checks shall be carried out, engine disconnected, with the vehicle laden and unladen:

- 5.3.1. The wheels directly controlled by an anti-lock system must not lock when the full force 8/ is suddenly applied on the control device, on the road surfaces specified in

7/ Until a uniform test procedure is established, the tests required by this paragraph may have to be repeated for vehicles equipped with electrical regenerative braking systems, in order to determine the effect of different braking distribution values provided by automatic functions on the vehicle.

8/ "Full force" means the maximum force laid down in annex 4 to this Regulation for the category of vehicle; a higher force may be used if required to activate the anti-lock system.

paragraph 5.2.2. of this annex, at an initial speed of 40 km/h and at a high initial speed as indicated on the table below: 9/ 10/

	Vehicle category	Maximum test speed
High-adhesion surface	All categories except N ₂ , N ₃ laden	0.8 v _{max} ≤ 120 km/h
	N ₂ , N ₃ laden	0.8 v _{max} ≤ 80 km/h
Low-adhesion surface	M ₁ , N ₁	0.8 v _{max} ≤ 120 km/h
	M ₂ , M ₃ , N ₂ except tractors for semi-trailers	0.8 v _{max} ≤ 80 km/h
	N ₃ and N ₂ tractors for semi-trailers	0.8 v _{max} ≤ 70 km/h

- 5.3.2. When an axle passes from a high-adhesion surface (k_H) to a low-adhesion surface (k_L) where $k_H \geq 0.5$ and $k_H/k_L \geq 2$, 11/ with the full force 8/ applied on the control device, the directly controlled wheels must not lock. The running speed and the instant of applying the brakes shall be so calculated that, with the anti-lock system fully cycling on the high-adhesion surface, the passage from one surface to the other is made at high and at low speed, under the conditions laid down in paragraph 5.3.1. of this annex 10/.
- 5.3.3. When a vehicle passes from a low-adhesion surface (k_L) to a high-adhesion surface (k_H) where $k_H \geq 0.5$ and $k_H/k_L \geq 2$, 11/ with the full force 8/ applied on the control device, the deceleration of the vehicle must rise to the appropriate high value within a reasonable time and the vehicle must not deviate from its initial course. The running speed and the instant of applying the brakes shall be so calculated that, with the anti-lock system fully cycling on the low-adhesion surface, the passage from one surface to the other occurs at approximately 50 km/h.

9/ The provisions of this paragraph apply as of 13 March 1992 (Decision of the Working Party on the Construction of Vehicles, TRANS/SC1/WP29/341, para. 23).

10/ The purpose of these tests is to check that the wheels do not lock and that the vehicle remains stable; it is not necessary, therefore, to make complete stops and bring the vehicle to a halt on the low-adhesion surface.

11/ k_H is the high-adhesion surface coefficient.
 k_L is the low-adhesion surface coefficient.
 k_H and k_L are measured as laid down in appendix 2 to this annex.

- 5.3.4. In the case of vehicles equipped with anti-lock systems of categories 1 or 2, when the right and left wheels of the vehicle are situated on surfaces with differing coefficients of adhesion (k_H and k_L), where $k_H \geq 0.5$ and $k_H/k_L \geq 2$, 11/ the directly controlled wheels must not lock when the full force 8/ is suddenly applied on the control device at a speed of 50 km/h.
- 5.3.5. Furthermore, laden vehicles equipped with anti-lock systems of category 1 shall, under the conditions of paragraph 5.3.4. of this annex satisfy the prescribed braking rate in appendix 3 to this annex.
- 5.3.6. However, in the tests provided in paragraphs 5.3.1., 5.3.2., 5.3.3., 5.3.4. and 5.3.5. of this annex, brief periods of wheel-locking shall be allowed. Furthermore, wheel-locking is permitted when the vehicle speed is less than 15 km/h; likewise, locking of indirectly controlled wheels is permitted at any speed, but stability and steerability must not be affected.
- 5.3.7. During the tests provided in paragraphs 5.3.4. and 5.3.5. of this annex, steering correction is permitted, if the angular rotation of the steering control is within 120° during the initial two seconds, and not more than 240° in all. Furthermore, at the beginning of these tests the longitudinal median plane of the vehicle must pass over the boundary between the high- and low-adhesion surfaces and during these tests no part of the (outer) tyres must cross this boundary. 7/
6. SPECIAL PROVISIONS CONCERNING TRAILERS
- 6.1. Energy consumption
- Trailers equipped with anti-lock systems shall be so designed that, even after the service braking control device has been fully applied for some time, the vehicle retains sufficient energy to bring it to a halt within a reasonable distance.
- 6.1.1. Compliance with the above requirement shall be checked by the procedure specified below, with the vehicle unladen, on a straight and level road with a surface having a good coefficient of adhesion 12/ and with the brakes adjusted as closely as possible and with the proportioning/load-sensing valve (if fitted) held in the "laden" position throughout the test.
- 6.1.2. In the case of compressed-air braking systems, the initial energy level in the energy transmission storage device(s) shall be equivalent to a pressure of **800 kPa** at the coupling head of the trailer's supply line.

12/ If the coefficient of adhesion of the test track is too high, preventing the anti-lock braking system from full cycling, then the test may be carried out on a surface with a lower coefficient of adhesion.

- 6.1.3. With an initial vehicle speed of at least 30 km/h the brakes shall be fully applied for a time $t = 15$ s, during which all wheels must remain under control of the anti-lock system. During this test, the supply to the energy transmission storage device(s) shall be cut off.

If the time $t = 15$ s cannot be completed in a single braking phase, further phases may be used. During these phases no fresh energy shall be supplied to the energy transmission storage device(s) and, as from the second phase, the additional energy consumption for filling the actuators is to be taken into account, e.g. by the following test procedure.

The pressure in the reservoir(s) when starting the first phase is to be that stated in paragraph 6.1.2. of this annex. At the beginning of the following phase(s) the pressure in the reservoir(s) after application of the brakes must be not less than the pressure in the reservoir(s) at the end of the preceding phase.

At the subsequent phase(s), the only time to be taken into account is from the point at which the pressure in the reservoir(s) is equal to that at the end of the preceding phase.

- 6.1.4. At the end of the braking, with the vehicle stationary, the service braking control device shall be fully actuated four times. During the fifth application, the pressure in the operating circuit must be sufficient to provide a total braking force at the periphery of the wheels equal to not less than 22.5 per cent of the maximum stationary wheel load and without causing an automatic application of any braking system not being under the control of the anti-lock system.

6.2. Utilisation of adhesion

- 6.2.1. Braking systems equipped with an anti-lock system shall be deemed acceptable when the condition $\varepsilon \geq 0.75$ is satisfied, where ε represents the adhesion utilized, as defined in paragraph 2 of appendix 2 to this annex. This condition shall be verified with the vehicle unladen, on a straight and level road with a surface having a good coefficient of adhesion. 12/ 13/
- 6.2.2. To eliminate the effects of differential brake temperatures, it is recommended to determine z_{RAL} prior to the determination of k_R .

13/ In the case of trailers equipped with a brake load sensing device, the pressure setting of the device may be increased to ensure full cycling.

6.3. Additional checks

6.3.1. At speeds exceeding 15 km/h, the wheels directly controlled by an anti-lock system must not lock when the full force $g/$ is suddenly applied on the control device of the towing vehicle. This shall be checked, under the conditions prescribed in paragraph 6.2. of this annex, at initial speeds of 40 km/h and 80 km/h.

6.3.2. The provisions of this paragraph shall only apply to trailers equipped with an anti-lock system of category A. When the right and left wheels are situated on surfaces which produce differing maximum braking rates (Z_{RALH} and Z_{RALL}), where

$$\frac{Z_{RALH}}{\varepsilon_H} \geq 0.5 \text{ and } \frac{Z_{RALH}}{Z_{RALL}} \geq 2$$

the directly controlled wheels must not lock when the full force $g/$ is suddenly applied on the control device of the towing vehicle at a speed of 50 km/h. The ratio Z_{RALH}/Z_{RALL} may be ascertained by the procedure in paragraph 2 of appendix 2 of this annex or by calculating the ratio Z_{RALH}/Z_{RALL} . Under this condition the unladen vehicle shall satisfy the prescribed braking rate in appendix 3 to this annex. 13/

6.3.3. At vehicle speeds ≥ 15 km/h the directly controlled wheels are permitted to lock for brief periods, but at speeds < 15 km/h any locking is permissible. Indirectly controlled wheels are permitted to lock at any speed but in all cases stability must not be affected.

Annex 13 - Appendix 1

SYMBOLS AND DEFINITIONS

TABLE: SYMBOLS AND DEFINITIONS	
SYMBOL	NOTES
E	wheelbase
E_R	distance between king-pin and centre of axle or axles of semi-trailer (or distance between drawbar coupling and centre of axle or axles of centre-axle trailer)
ε	the adhesion utilized of the vehicle: quotient of the maximum braking rate with the anti-lock system operative (z_{AL}) and the coefficient of adhesion (k)
ε_i	the ε -value measured on axle i (in the case of a power-driven vehicle with a category 3 anti-lock system)
ε_H	the ε -value on the high-adhesion surface
ε_L	the ε -value on the low-adhesion surface
F	force [N]
F_{bR}	braking force of the trailer with the anti-lock system inoperative
F_{bRmax}	maximum value of F_{bR}
F_{bRmaxi}	value of F_{bRmax} with only axle i of the trailer braked
F_{bRAL}	braking force of the trailer with the anti-lock system operative
F_{Cnd}	total normal reaction of road surface on the unbraked and non-driven axles of the vehicle combination under static conditions
F_{Cd}	total normal reaction of road surface on the unbraked and driven axles of the vehicle combination under static conditions
F_{dyn}	normal reaction of road surface under dynamic conditions with the anti-lock system operative
F_{idyn}	F_{dyn} on axle i in case of power-driven vehicles or full trailers
F_i	normal reaction of road surface on axle i under static conditions
F_M	total normal static reaction of road surface on all wheels of power-driven (towing) vehicle

TABLE: SYMBOLS AND DEFINITIONS	
SYMBOL	NOTES
F_{Mnd} ^{1/}	total normal static reaction of road surface on the unbraked and non-driven axles of the power-driven vehicle
F_{Md} ^{1/}	total normal static reaction of road surface on the unbraked and driven axles of the power-driven vehicle
F_R	total normal static reaction of road surface on all wheels of trailer
F_{Rdyn}	total normal dynamic reaction of road surface on the axle(s) of semi-trailer or centre-axle trailer
F_{WM} ^{1/}	$0.01 F_{Mnd} + 0.015 F_{Md}$
g	acceleration due to gravity (9.81 m/s^2)
h	height of centre of gravity specified by the manufacturer and agreed by the Technical Service conducting the approval test
h_D	height of drawbar (hinge point on trailer)
h_K	height of fifth wheel coupling (king pin)
h_R	height of centre of gravity of the trailer
k	coefficient of adhesion between tyre and road
k_f	k-factor of one front axle
k_H	k-value determined on the high-adhesion surface
k_i	k-value determined on axle i for a vehicle with a category 3 anti-lock system
k_L	k-value determined on the low-adhesion surface
k_{lock}	value of adhesion for 100 % slip
k_M	k-factor of the power-driven vehicle
k_{peak}	maximum value of the curve "adhesion versus slip"
k_r	k-factor of one rear axle

^{1/} F_{Mnd} and F_{Md} in case of two-axled power-driven vehicles: these symbols may be simplified to corresponding F_i -symbols.

TABLE: SYMBOLS AND DEFINITIONS	
SYMBOL	NOTES
k_R	k-factor of the trailer
P	mass of individual vehicle [kg]
R	ratio of k_{peak} to k_{lock}
t	time interval [s]
t_m	mean value of t
t_{min}	minimum value of t
z	braking rate
Z_{AL}	braking rate z of the vehicle with the anti-lock system operative
Z_C	braking rate z of the vehicle combination, with the trailer only braked and the anti-lock system inoperative
Z_{CAL}	braking rate z of the vehicle combination, with the trailer only braked and the anti-lock system operative
Z_{Cmax}	maximum value of Z_C
Z_{Cmaxi}	maximum value of Z_C with only axle i of the trailer braked
Z_m	mean braking rate
Z_{max}	maximum value of z
Z_{MALS}	Z_{AL} of the power-driven vehicle on a "split surface"
Z_R	braking rate z of the trailer with the anti-lock system inoperative
Z_{RAL}	Z_{AL} of the trailer obtained by braking all the axles, the towing vehicle unbraked and its engine disengaged
Z_{RALH}	Z_{RAL} on the surface with the high coefficient of adhesion
Z_{RALL}	Z_{RAL} on the surface with the low coefficient of adhesion
Z_{RALS}	Z_{RAL} on the split-surface
Z_{RH}	Z_R on the surface with the high coefficient of adhesion
Z_{RL}	Z_R on the surface with the low coefficient of adhesion

TABLE: SYMBOLS AND DEFINITIONS	
SYMBOL	NOTES
Z_{RHmax}	maximum value of Z_{RH}
Z_{RLmax}	maximum value of Z_{RL}
Z_{Rmax}	maximum value of Z_R

Annex 13 - Appendix 2

UTILIZATION OF ADHESION

1. METHOD OF MEASUREMENT FOR POWER-DRIVEN VEHICLES

1.1. Determination of the coefficient of adhesion (k)

1.1.1. The coefficient of adhesion (k) shall be determined as the quotient of the maximum braking forces without locking the wheels and the corresponding dynamic load on the axle being braked.

1.1.2. The brakes shall be applied on only one axle of the vehicle under test, at an initial speed of 50 km/h. The braking forces shall be distributed between the wheels of the axle to reach maximum performance. The anti-lock system shall be disconnected, or inoperative, between 40 km/h and 20 km/h.

1.1.3. A number of tests at increments of line pressure shall be carried out to determine the maximum braking rate of the vehicle (z_{\max}). During each test, a constant input force shall be maintained and the braking rate will be determined by reference to the time taken (t) for the speed to reduce from 40 km/h to 20 km/h using the formula:

$$z = \frac{0.566}{t}$$

z_{\max} is the maximum value of z; t is in seconds.

1.1.3.1. Wheel lock may occur below 20 km/h.

1.1.3.2. Starting from the minimum measured value of t, called t_{\min} , then select three values of t comprised within t_{\min} and $1.05 t_{\min}$ and calculate their arithmetical mean value t_m , then calculate

$$z_m = \frac{0.566}{t_m}$$

If it is demonstrated that for practical reasons the three values defined above cannot be obtained, then the minimum time t_{\min} may be utilized. However, the requirements of paragraph 1.3. below shall still apply.

1.1.4. The braking forces shall be calculated from the measured braking rate and the rolling resistance of the unbraked axle(s) which is equal to 0.015 and 0.010 of the static axle load for a driven axle and a non-driven axle, respectively.

- 1.1.5. The dynamic load on the axle shall be that given by the formulae in annex 10 to this Regulation.
- 1.1.6. The value of k shall be rounded to three decimal places.
- 1.1.7. Then, the test will be repeated for the other axle(s) as defined in paragraphs 1.1.1. to 1.1.6. above (for exemptions see paragraphs 1.4. and 1.5. below).
- 1.1.8. For example, in the case of a two-axle rear-wheel drive vehicle, with the front axle (1) being braked, the coefficient of adhesion (k) is given by:

$$k_f = \frac{z_m \cdot P \cdot g - 0.015 \cdot F_2}{F_1 + \frac{h}{E} \cdot z_m \cdot P \cdot g}$$

- 1.1.9. One coefficient will be determined for the front axle k_f and one for the rear axle k_r .

1.2. Determination of the adhesion utilized (ϵ)

- 1.2.1. The adhesion utilized (ϵ) is defined as the quotient of the maximum braking rate with the anti-lock system operative (z_{AL}) and the coefficient of adhesion (k_M) i.e.,

$$\epsilon = \frac{z_{AL}}{k_M}$$

- 1.2.2. From an initial vehicle speed of 55 km/h, the maximum braking rate (z_{AL}) shall be measured with full cycling of the anti-lock braking system and based on the average value of three tests, as in paragraph 1.1.3. of this appendix, using the time taken for the speed to reduce from 45 km/h to 15 km/h, according to the following formula:

$$z_{AL} = \frac{0.849}{t_m}$$

- 1.2.3. The coefficient of adhesion k_M shall be determined by weighting with the dynamic axle loads.

$$k_M = \frac{k_f \cdot F_{fdyn} + k_r \cdot F_{rdyn}}{P \cdot g}$$

where:

$$F_{fdyn} = F_f + \frac{h}{E} \cdot z_{AL} \cdot P \cdot g$$

$$F_{rdyn} = F_r - \frac{h}{E} \cdot z_{AL} \cdot P \cdot g$$

- 1.2.4. The value of ε shall be rounded to two decimal places.
- 1.2.5. In the case of a vehicle equipped with an anti-lock system of categories 1 or 2, the value of z_{AL} will be based on the whole vehicle, with the anti-lock system operative, and the adhesion utilized (ε) is given by the same formula quoted in paragraph 1.2.1. of this appendix.
- 1.2.6. In the case of a vehicle equipped with an anti-lock system of category 3, the value of z_{AL} will be measured on each axle which has at least one directly controlled wheel. For example, for a two-axle rear-wheel drive vehicle with an anti-lock system acting only on the rear axle (2), the adhesion utilized (ε) is given by:

$$\varepsilon_2 = \frac{z_{AL} \cdot P \cdot g - 0.010 \cdot F_1}{k_2 \left(F_2 - \frac{h}{E} \cdot z_{AL} \cdot P \cdot g \right)}$$

This calculation shall be made for each axle having at least one directly controlled wheel.

- 1.3. If $\varepsilon > 1.00$ the measurements of coefficients of adhesion shall be repeated. A tolerance of 10 per cent is accepted.
- 1.4. For power-driven vehicles equipped with three axles, only the axle not associated with a close-coupled bogie will be used to establish a k value for the vehicle. 1/
- 1.5. For vehicles of categories N_2 and N_3 with a wheelbase less than 3.80 m and with $h/E \geq 0.25$ the determination of the coefficient of adhesion for the rear axle will be omitted.
- 1.5.1. In that case the adhesion utilized (ε) is defined as the quotient of the maximum braking rate with the anti-lock system operative (z_{AL}) and the coefficient of adhesion (k_f) i.e.

$$\varepsilon = \frac{z_{AL}}{k_f}$$

1/ Until a uniform test procedure is agreed, vehicles with more than three axles and special vehicles will be subject to consultation with the Technical Service.

2. METHOD OF MEASUREMENT FOR TRAILERS

2.1. General

2.1.1. The coefficient of adhesion (k) shall be determined as the quotient of the maximum braking forces without locking the wheels and the corresponding dynamic load on the axle being braked.

2.1.2. The brakes shall be applied on only one axle of the trailer under test, at an initial speed of 50 km/h. The braking forces shall be distributed between the wheels of the axle to reach maximum performance. The anti-lock system shall be disconnected or inoperative, between 40 km/h and 20 km/h.

2.1.3. A number of tests at increments of line pressure shall be carried out to determine the maximum braking rate of the vehicle combination (z_{Cmax}) with the trailer only braked. During each test, a constant input force shall be maintained and the braking rate will be determined by reference to the time taken (t) for the speed to reduce from 40 km/h to 20 km/h using the formula:

$$z_c = \frac{0.566}{t}$$

2.1.3.1. Wheel lock may occur below 20 km/h.

2.1.3.2. Starting from the minimum measured value of t, called t_{min} , then select three values of t comprised within t_{min} and $1.05 t_{min}$ and calculate their arithmetical mean value t_m , then calculate

$$z_{Cmax} = \frac{0.566}{t_m}$$

If it is demonstrated that for practical reasons the three values defined above cannot be obtained, then the minimum time t_{min} may be utilized.

2.1.4. The adhesion utilized (ϵ) shall be calculated by means of the formula:

$$\epsilon = \frac{Z_{RAL}}{k_R}$$

The k value has to be determined according to paragraph 2.2.3. of this appendix for full trailers or paragraph 2.3.1. of this appendix for semi-trailers respectively.

2.1.5. If $\epsilon > 1.00$ the measurements of coefficients of adhesion shall be repeated. A tolerance of 10 per cent is accepted.

2.1.6. The maximum braking rate (z_{RAL}) shall be measured with full cycling of the anti-lock braking system and the towing vehicle unbraked, based on the average value of three tests, as in paragraph 2.1.3. of this appendix.

2.2. Full trailers

2.2.1. The measurement of k (with the anti-lock system being disconnected, or inoperative, between 40 km/h and 20 km/h) will be performed for the front and the rear axles.

For one front axle i :

$$F_{bRmaxi} = z_{Cmaxi} (F_M + F_R) - 0.01F_{Cnd} - 0.015F_{Cd}$$

$$F_{idyn} = F_i + \frac{z_{Cmax} (F_M \cdot h_D + g \cdot P \cdot h_R) - F_{WM} \cdot h_D}{E}$$

$$k_f = \frac{F_{bRmaxi}}{F_{idyn}}$$

For one rear axle i :

$$F_{bRmaxi} = z_{Cmaxi} \cdot (F_M + F_R) - 0.01F_{Cnd} - 0.015F_{Cd}$$

$$F_{idyn} = F_i - \frac{z_{Cmax} (F_M \cdot h_D + g \cdot P \cdot h_R) - F_{WM} \cdot h_D}{E}$$

$$k_r = \frac{F_{bRmaxi}}{F_{idyn}}$$

2.2.2. The values of k_f and k_r will be rounded to three decimal places.

2.2.3. The coefficient of adhesion k_R shall be determined proportionally according to the dynamic axle loads.

$$k_R = \frac{k_f \cdot F_{fdyn} + k_r \cdot F_{rdyn}}{P \cdot g}$$

2.2.4. Measurement of Z_{RAL} (with the anti-lock system operative)

$$Z_{RAL} = \frac{Z_{CAL} \cdot (F_M + F_R) - 0.01 F_{Cnd} - 0.015 F_{Cd}}{F_R}$$

Z_{RAL} is to be determined on a surface with a high coefficient of adhesion and, for vehicles with a category A anti-lock system, also on a surface with a low coefficient of adhesion.

2.3. Semi-trailers and centre-axle trailers

2.3.1. The measurement of k (with the anti-lock system being disconnected or inoperative, between 40 km/h and 20 km/h) shall be carried out with wheels fitted only on one axle, the wheels of the other axle(s) are removed.

$$F_{bRmax} = Z_{Cmax} \cdot (F_M + F_R) - F_{WM}$$

$$F_{Rdyn} = F_R - \frac{F_{bRmax} \cdot h_K + z_c \cdot g \cdot P \cdot (h_R - h_K)}{E_R}$$

$$k = \frac{F_{bRmax}}{F_{Rdyn}}$$

2.3.2. The measurement of Z_{RAL} (with the anti-lock system operative) shall be carried out with all wheels fitted.

$$F_{bRAL} = Z_{CAL} \cdot (F_M + F_R) - F_{WM}$$

$$F_{Rdyn} = F_R - \frac{F_{bRAL} \cdot h_K + z_c \cdot g \cdot P \cdot (h_R - h_K)}{E_R}$$

$$Z_{RAL} = \frac{F_{bRAL}}{F_{Rdyn}}$$

Z_{RAL} is to be determined on a surface with a high coefficient of adhesion and, for vehicles with a category A anti-lock system, also on a surface with a low coefficient of adhesion.

Annex 13 - Appendix 3

PERFORMANCE ON DIFFERING ADHESION SURFACES

1. Power-driven vehicles

- 1.1. The prescribed braking rate referred to in paragraph 5.3.5. of this annex may be calculated by reference to the measured coefficient of adhesion of the two surfaces on which this test is carried out. These two surfaces must satisfy the conditions prescribed in paragraph 5.3.4. of this annex.
- 1.2. The coefficient of adhesion (k_H and k_L) of the high- and low- adhesion surfaces, respectively, shall be determined in accordance with the provisions in paragraph 1.1. of appendix 2 to this annex.
- 1.3. The braking rate (Z_{MALS}) for laden power-driven vehicles shall be:

$$Z_{MALS} \geq 0.75 \frac{4k_L + k_H}{5} \text{ and } Z_{MALS} \geq k_L$$

2. Trailers

- 2.1. The braking rate referred to in paragraph 6.3.2. of this annex may be calculated by reference to the measured braking rates Z_{RALH} and Z_{RALL} on the two surfaces on which the tests are carried out with the anti-lock system operative. These two surfaces must satisfy the conditions prescribed in paragraph 6.3.2. of this annex.
- 2.2. The braking rate Z_{RALS} shall be:

$$Z_{RALS} \geq \frac{0.75}{\epsilon_H} \cdot \frac{4Z_{RALL} + Z_{RALH}}{5}$$

and

$$Z_{RALS} > \frac{Z_{RALL}}{\epsilon_H}$$

If $\epsilon_H > 0.95$, use $\epsilon_H = 0.95$

Annex 13 - Appendix 4

METHOD OF SELECTION OF THE LOW-ADHESION SURFACES

1. Details of the coefficient of adhesion of the surface selected, as defined in paragraph 5.1.1.2. of this annex, must be given to the Technical Service.
 - 1.1. These data must include a curve of the coefficient of adhesion versus slip (from 0 to 100 per cent slip) for a speed of approximately 40 km/h. 1/
 - 1.1.1. The maximum value of the curve will represent k_{peak} and the value at 100 per cent slip will represent k_{lock} .
 - 1.1.2. The ratio R shall be determined as the quotient of the k_{peak} and k_{lock} .

$$R = \frac{k_{\text{peak}}}{k_{\text{lock}}}$$

- 1.1.3. The value of R shall be rounded to one decimal place.
 - 1.1.4. The surface to be used must have a ratio R between 1.0 and 2.0. 2/
2. Prior to the tests, the Technical Service shall ensure that the selected surface meets the specified requirements and shall be informed of the following:
 - (a) test method to determine R,
 - (b) type of vehicle (power-driven vehicle, trailer, ...),
 - (c) axle load and tyres (different loads and different tyres have to be tested and the results shown to the Technical Service which will decide if they are representative for the vehicle to be approved).

1/ Until a uniform test procedure is established for the determination of the adhesion curve for vehicles with a maximum mass exceeding 3.5 tonnes, the curve established for passenger cars may be used. In this case, for such vehicles, the ratio k_{peak} to k_{lock} shall be established using a value of k_{peak} as defined in appendix 2 to this annex. With the consent of the Technical Service, the coefficient of adhesion described in this paragraph may be determined by another method provided that the equivalence of the values of k_{peak} and k_{lock} are demonstrated.

2/ Until such test surfaces become generally available, a ratio R up to 2.5 is acceptable, subject to discussion with the Technical Service.

2.1. The value of R shall be mentioned in the test report.

The calibration of the surface has to be carried out at least once a year with a representative vehicle to verify the stability of R.

Annex 14

TEST CONDITIONS FOR TRAILERS WITH ELECTRICAL BRAKING SYSTEMS

1. GENERAL

- 1.1. For the purposes of the following provisions electrical braking systems are service braking systems consisting of a control device, an electromechanical transmission device, and friction brakes. The electrical control device regulating the voltage for the trailer must be situated on the trailer.
- 1.2. The electrical energy required for the electrical braking system is supplied to the trailer by the towing vehicle.
- 1.3. Electrical braking systems shall be actuated by operating the service braking system of the towing vehicle.
- 1.4. The nominal voltage rating shall be 12 V.
- 1.5. The maximum current consumption shall not exceed 15 A.
- 1.6. The electrical connection of the electrical braking system to the towing vehicle shall be effected by means of a special plug and socket connection corresponding to ..., 1/ the plug of which shall not be compatible with the sockets of the lighting equipment of the vehicle. The plug together with the cable shall be situated on the trailer.

2. CONDITIONS CONCERNING THE TRAILER

- 2.1. If there is a battery on the trailer fed by the power supply unit of the towing vehicle, it shall be separated from its supply line during service braking of the trailer.
- 2.2. With trailers whose unladen mass is less than 75 per cent of their maximum mass, the braking force shall be automatically regulated as a function of the loading condition of the trailer.
- 2.3. Electrical braking systems shall be such that even when the voltage in the connection lines is reduced to a value of 7 V, a braking effect of 20 per cent of the (sum of the) maximum stationary axle load(s) is maintained.
- 2.4. Control devices for regulating the braking force, which react to the inclination in the direction of travel (pendulum, spring-mass-system, liquid-inertia-switch) shall, if the

1/ Under study. Until the characteristics of this special connection have been determined, the type to be used will be indicated by the national authority granting the approval.

trailer has more than one axle and a vertically adjustable towing device, be attached to the chassis. In the case of single-axle trailers and trailers with close-coupled axles where the axle spread is less than 1 metre, these control devices shall be equipped with a mechanism indicating its horizontal position (e.g., spirit level) and shall be manually adjustable to allow the mechanism to be set in the horizontal plane in line with the direction of travel of the vehicle.

- 2.5. The relay for actuating the braking current in accordance with paragraph 5.2.1.19.2. of this Regulation, which is connected to the actuating line, shall be situated on the trailer.
- 2.6. A dummy socket shall be provided for the plug.
- 2.7. A tell-tale shall be provided at the control device, lighting up at any brake application and indicating the proper functioning of the trailer electrical braking system.

3. PERFORMANCE

- 3.1. Electrical braking systems shall respond at a deceleration of the tractor/trailer combination of not more than 0.4 m/s^2 .
- 3.2. The braking effect may commence with an initial braking force, which shall not be higher than 10 per cent of the (sum of the) maximum stationary axle load(s) nor higher than 13 per cent of the (sum of the) stationary axle load(s) of the unladen trailer.
- 3.3. The braking forces may also be increased in steps. At higher levels of the braking forces than those referred to in paragraph 3.2. of this annex these steps shall not be higher than 6 per cent of the (sum of the) maximum stationary axle load(s) nor higher than 8 per cent of the (sum of the) stationary axle load(s) of the unladen trailer. However, in the case of single-axle trailers having a maximum mass not exceeding 1.5 tonnes, the first step must not exceed 7 per cent of the (sum of the) maximum stationary axle load(s) of the trailer. An increase of 1 per cent of this value is permitted for the subsequent steps (example: first step 7 per cent, second step 8 per cent, third step 9 per cent, etc; any further step should not exceed 10 per cent). For the purpose of these provisions a two-axle trailer having a wheelbase shorter than 1 m will be considered as a single axle trailer.
- 3.4. The prescribed braking force of the trailer of at least 50 per cent of the maximum total axle load shall be attained - with maximum mass - in the case of a mean fully developed deceleration of the tractor/trailer combination of not more than 5.9 m/s^2 with single-axle trailers and of not more than 5.6 m/s^2 with multi-axle trailers. Trailers with close-coupled axles where the axle spread is less than 1 m are also considered as single-axle trailers within the meaning of this provision. Moreover, the limits as defined in the appendix to this annex must be observed. If the braking force is regulated in steps, they shall lie within the range shown in the appendix to this annex.

- 3.5. The test shall be carried out with an initial speed of 60 km/h.
- 3.6. Automatic braking of the trailer shall be provided in accordance with the conditions of paragraph 5.2.2.9. of this Regulation. If this automatic braking action requires electrical energy, a trailer braking force of at least 25 per cent of the maximum total axle load shall be achieved for at least 15 minutes to satisfy the above-mentioned conditions.
-

Annex 14 - Appendix

Compatibility of the braking rate of the trailer and the mean fully developed deceleration of the tractor/trailer combination (trailer laden and unladen).

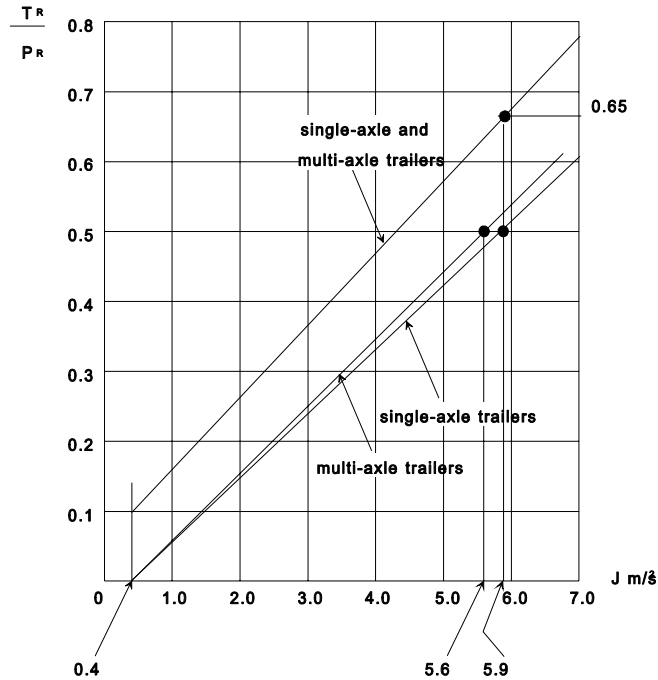

Notes:

1. Limits indicated in the diagram refer to laden and unladen trailers. When the trailer unladen mass exceeds 75 per cent of its maximum mass, limits shall be applied only to "laden" conditions.
2. Limits indicated in the diagram do not affect the provisions of this annex regarding the minimum braking performances required. However, if braking performances obtained during test - in accordance with provisions indicated in paragraph 3.4. of this annex - are greater than those required, said performances shall not exceed the limits indicated in the above diagram.

T_R = sum of braking forces at periphery of all wheels of trailer.

P_R = total normal static reaction of road surface on wheels of trailer.

J = mean fully developed deceleration of tractor/trailer combination.

Annex 15

INERTIA DYNAMOMETER TEST METHOD FOR BRAKE LININGS

1. GENERAL

- 1.1. The procedure described in this annex may be applied in the event of a modification of vehicle type resulting from the fitting of brake linings of another type to vehicles which have been approved in accordance with this Regulation.
- 1.2. The alternative types of brake linings shall be checked by comparing their performance with that obtained from the brake linings with which the vehicle was equipped at the time of approval and conforming to the components identified in the relevant information document, a model of which is given in annex 2 to this Regulation.
- 1.3. The Technical Service responsible for conducting approval tests may at its discretion require comparison of the performance of the brake linings to be carried out in accordance with the relevant provisions contained in annex 4 to this Regulation.
- 1.4. Application for approval by comparison shall be made by the vehicle manufacturer or by his duly accredited representative.
- 1.5. In the context of this annex, "vehicle" shall mean the vehicle-type approved according to this Regulation and for which it is requested that the comparison shall be considered satisfactory.

2. TEST EQUIPMENT

- 2.1. A dynamometer having the following characteristics shall be used for the tests:
 - 2.1.1. It shall be capable of generating the inertia required by paragraph 3.1. of this annex, and have the capacity to meet the requirements prescribed by paragraphs 1.5., 1.6. and 1.7. of annex 4 to this Regulation with respect to Type-I, Type-II and Type-III tests.
 - 2.1.2. The brakes fitted shall be identical with those of the original vehicle-type concerned.
 - 2.1.3. Air cooling, if provided, shall be in accordance with paragraph 3.4. of this annex.
 - 2.1.4. The instrumentation for the test shall be capable of providing at least the following data:

- 2.1.4.1. a continuous recording of disc or drum rotational speed;
- 2.1.4.2. number of revolutions completed during a stop, to a resolution not greater than one eighth of a revolution;
- 2.1.4.3. stop time;
- 2.1.4.4. a continuous recording of the temperature measured in the centre of the path swept by the lining or at mid-thickness of the disc or drum or lining;
- 2.1.4.5. a continuous recording of brake application control line pressure or force;
- 2.1.4.6. a continuous recording of brake output torque.

3. TEST CONDITIONS

- 3.1. The dynamometer shall be set as close as possible, with 5 per cent tolerance, to the rotary inertia equivalent to that part of the total inertia of the vehicle braked by the appropriate wheel(s) according to the following formula:

$$I = MR^2$$

where

I = rotational inertia [kgm²]

R = dynamic tyre rolling radius [m]

M = that part of the maximum mass of the vehicle braked by the appropriate wheel(s). In the case of a single-ended dynamometer, this part shall be calculated from the design braking distribution in the case of vehicles of categories M and N when deceleration corresponds to the appropriate value given in paragraph 2.1. of annex 4 to this Regulation; in the case of vehicles of category O (trailers) the value of M will correspond to the load on the ground for the appropriate wheel when the vehicle is stationary and loaded to its maximum mass.

- 3.2. The initial rotational speed of the inertia dynamometer shall correspond to the linear speed of the vehicle as prescribed in annex 4 to this Regulation and shall be based on the dynamic rolling radius of the tyre.
- 3.3. Brake linings shall be at least 80 per cent bedded and shall not have exceeded a temperature of 180 °C during the bedding procedure, or alternatively, at the vehicle manufacturer's request, be bedded in accordance with his recommendations.

- 3.4. Cooling air may be used, flowing over the brake in a direction perpendicular to its axis of rotation. The velocity of the cooling air over the brake shall be:

$$v_{\text{air}} = 0.33 v$$

where

v = vehicle test speed at initiation of braking.

The temperature of the cooling air shall be the ambient temperature.

4. TEST PROCEDURE

- 4.1. Five sample sets of the brake lining shall be subjected to the comparison test; they shall be compared with five sets of linings conforming to the original components identified in the information document concerning the first approval of the vehicle type concerned.
- 4.2. Brake lining equivalence shall be based on a comparison of the results achieved using the test procedures prescribed in this annex and in accordance with the following requirements.
- 4.3. Type-0 cold performance test
- 4.3.1. Three brake applications shall be made when the initial temperature is below 100 °C. The temperature shall be measured in accordance with the provisions of paragraph 2.1.4.4. of this annex.
- 4.3.2. In the case of brake linings intended for use on vehicles of categories M and N, brake applications shall be made from an initial rotational speed equivalent to that given in paragraph 2.1. of annex 4 to this Regulation, and the brake shall be applied to achieve a mean torque equivalent to the deceleration prescribed in that paragraph. In addition, tests shall also be carried out at several rotational speeds, the lowest being equivalent to 30 per cent of the maximum speed of the vehicle and the highest being equivalent to 80 per cent of that speed.
- 4.3.3. In the case of brake linings intended for use on vehicles of category O, brake applications shall be made from an initial rotational speed equivalent to 60 km/h, and the brake shall be applied to achieve a mean torque equivalent to that prescribed in paragraph 3.1. of annex 4 to this Regulation. A supplementary cold performance test from an initial rotational speed equivalent to 40 km/h shall be carried out for comparison with the Type-I test results as described in paragraph 3.1.2.2. of annex 4 to this Regulation.
- 4.3.4. The mean braking torque recorded during the above cold performance tests on the linings being tested for the purpose of comparison shall, for the same input measurement, be within the test limits, 15 per cent of the mean braking torque

recorded with the brake linings conforming to the component identified in the relevant application for vehicle type approval.

4.4. Type-I test (fade test)

4.4.1. With repeated braking

4.4.1.1. Brake linings for vehicles of categories M and N shall be tested according to the procedure given in paragraph 1.5.1. of annex 4 to this Regulation.

4.4.2. With continuous braking

4.4.2.1. Brake linings for trailers (category O) shall be tested in accordance with paragraph 1.5.2. of annex 4 to this Regulation.

4.4.3. Hot performance

4.4.3.1. On completion of the tests required under paragraphs 4.4.1. and 4.4.2. of this annex, the hot braking performance test specified in paragraph 1.5.3. of annex 4 to this Regulation shall be carried out.

4.4.3.2. The mean braking torque recorded during the above hot performance tests on the linings being tested for the purpose of comparison shall, for the same input measurement, be within the test limits, 15 per cent of the mean braking torque recorded with the brake linings conforming to the component identified in the relevant application for vehicle type approval.

4.5. Type-II test (downhill behaviour test):

4.5.1. This test is required only if, on the vehicle-type in question, the friction brakes are used for the Type-II test.

4.5.2. Brake linings for power-driven vehicles of category M₃ (except for those vehicles required to undergo a Type-IIA test according to paragraph 1.6.4. of annex 4 to this Regulation) and category N₃, and trailers of category O₄ shall be tested according to the procedure set out in paragraph 1.6.1. of annex 4 to this Regulation.

4.5.3. Hot performance

4.5.3.1. On completion of the test required under paragraph 4.5.1. of this annex, the hot performance test specified in paragraph 1.6.3. of annex 4 to this Regulation shall be carried out.

- 4.5.3.2. The mean braking torque recorded during the above hot performance tests on the linings being tested for the purpose of comparison shall, for the same input measurement, be within the test limits 15 per cent of the mean braking torque recorded with the brake linings conforming to the component identified in the relevant application for vehicle type approval.
- 4.6. Type-III test (fade test)
- 4.6.1. Test with repeated braking
- 4.6.1.1. Brake linings for trailers of category O₄, shall be tested according to the procedure given in paragraphs 1.7.1. and 1.7.2. of annex 4 to this Regulation.
- 4.6.2. Test with continuous braking
- 4.6.2.1. Brake linings for trailers of category O₄ shall be tested according to the procedure given in paragraph 1.7. of annex 4 to this Regulation.
- 4.6.3. Hot performance
- 4.6.3.1. On completion of the tests required under paragraphs 4.6.1. and 4.6.2. of this annex, the hot braking performance test specified in paragraph 1.7.2. of annex 4 to this Regulation shall be carried out.
- 4.6.3.2. The mean braking torque during the above hot performance tests on the linings being tested for the purpose of comparison shall, for the same input measurement, be within the test limits 15 per cent of the mean braking torque recorded with the brake linings conforming to the component identified in the relevant application for vehicle type approval.
5. INSPECTION OF BRAKE LININGS
- 5.1. Brake linings shall be visually inspected on completion of the above tests to check that they are in satisfactory condition for continued use in normal service.
-

E/ECE/324
E/ECE/TRANS/505 } ~~Rev.1/Add.12/Rev.5~~
Regulation No. 13
page 220
Annex 16

Annex 16

(Reserved)

Annex 17

TEST PROCEDURE TO ASSESS THE FUNCTIONAL COMPATIBILITY OF VEHICLES
EQUIPPED WITH ELECTRIC CONTROL LINES

1. GENERAL

1.1. This annex defines a procedure that may be used to check towing and towed vehicles equipped with an electric control line against the functional and performance requirements referred to in paragraph 5.1.3.6.1. of this Regulation. Alternative procedures may be used at the discretion of the Technical Service if an equivalent level of checking integrity can be established.

1.2. The references to ISO 7638 within this annex apply to ISO 7638-1:1997 for 24V applications and ISO 7638-2:1997 for 12V applications.

2. INFORMATION DOCUMENT

2.1. The vehicle manufacturer/system supplier shall supply to the Technical Service an Information Document that contains at least the following:

2.1.1. a schematic of the vehicle braking system;

2.1.2. evidence that the interface, including the physical layer, data link layer and the application layer and the respective position of supported messages and parameters, complies with ISO 11992;

2.1.3. a list of supported messages and parameters; and

2.1.4. the specification of the motor vehicle with respect to the number of control circuits that signal the pneumatic and/or electric control lines.

3. TOWING VEHICLES

3.1. ISO 11992 trailer simulator

The simulator shall:

3.1.1. have a connector meeting ISO 7638:1997 (7 pin) to connect to the vehicle under test. Pins 6 and 7 of the connector shall be used to transmit and receive messages complying with ISO 11992;

- 3.1.2. be capable of receiving all of the messages transmitted by the motor vehicle to be type approved and be capable of transmitting all trailer messages defined within ISO 11992-2:2003;
- 3.1.3. provide a direct or indirect readout of messages, with the parameters in the data field shown in the correct order relative to time; and
- 3.1.4. include a facility to measure coupling head response time in accordance with paragraph 2.6. of annex 6 to this Regulation.
- 3.2. Checking procedure
- 3.2.1. Confirm that the manufacturer's/supplier's information document demonstrates compliance with the provisions of ISO 11992 with respect to the physical layer, data link layer and application layer.
- 3.2.2. Check the following, with the simulator connected to the motor vehicle via the ISO 7638 interface and whilst all trailer messages relevant to the interface are being transmitted:
- 3.2.2.1. Control line signalling:
- 3.2.2.1.1. The parameters defined in EBS 12 byte 3 of ISO 11992-2 shall be checked against the specification of the vehicle as follows:

Control Line Signalling	EBS 12 Byte 3	
	Bits 1 - 2	Bits 5 - 6
Service braking demand generated from one electrical circuit	00b	
Service braking demand generated from two electrical circuits	01b	
Vehicle is not equipped with a pneumatic control line <u>1/</u>		00b
Vehicle is equipped with a pneumatic control line		01b

- 3.2.2.2. Service/Secondary brake demand:
- 3.2.2.2.1 The parameters defined in EBS 11 of ISO 11992-2 shall be checked as follows:

1/ This specification of vehicle is prohibited by footnote 1/ to paragraph 5.1.3.1.3. of this Regulation.

Test condition	Byte reference	Electrical control line signal value
Service brake pedal and secondary brake control released	3 - 4	0
Service brake pedal fully applied	3 - 4	33280d to 43520d (650 to 850 kPa)
Secondary brake fully applied <u>2/</u>	3 - 4	33280d to 43520d (650 to 850 kPa)

3.2.2.3. Failure warning:

3.2.2.3.1. Simulate a permanent failure in the communication line to pin 6 of the ISO 7638 connector and check that the yellow warning signal specified in paragraph 5.2.1.29.1.2. of this Regulation is displayed.

3.2.2.3.2. Simulate a permanent failure in the communication line to pin 7 of the ISO 7638 connector and check that the yellow warning signal specified in paragraph 5.2.1.29.1.2. of this Regulation is displayed.

3.2.2.3.3. Simulate message EBS 22, byte 2 with bits 3 - 4 set to 01b and check that the red warning signal specified in paragraph 5.2.1.29.1.1. of this Regulation is displayed.

3.2.2.4. Supply line braking request:

For power-driven vehicles which can be operated with trailers connected via an electric control line only:

Only the electric control line shall be connected.

Simulate message EBS 22, byte 4 with bits 3 - 4 set to 01b and check that when the service brake, secondary brake or parking brake is fully actuated the pressure in the supply line falls to **150 kPa** within the following two seconds.

Simulate a continuous absence of data communication and check that when the service brake, secondary brake or parking brake is fully actuated the pressure in the supply line falls to **150 kPa** within the following two seconds.

3.2.2.5. Response time:

3.2.2.5.1. Check that, with no faults present, the control line response requirements defined in item 2.6. of annex 6 to this Regulation are met.

2/ Optional on towing vehicles with electric and pneumatic control lines when the pneumatic control line fulfils the relevant requirements for secondary braking.

3.2.3. Additional checks

3.2.3.1. At the discretion of the Technical Service the checking procedures defined above may be repeated with the non-braking functions relevant to the interface in different states or switched off.

4. TRAILERS

4.1. ISO 11992 towing vehicle simulator

The simulator shall:

4.1.1. have a connector meeting ISO 7638:1997 (7 pin) to connect to the vehicle under test. Pins 6 and 7 of the connector shall be used to transmit and receive messages complying with ISO 11992;

4.1.2. have a failure warning display and an electrical power supply for the trailer;

4.1.3. shall be capable of receiving all of the messages transmitted by the trailer to be type approved and be capable of transmitting all motor vehicle messages defined within ISO 11992-2:2003.

4.1.4. provide a direct or indirect readout of messages with the parameters in the data field shown in the correct order relative to time; and

4.1.5. include a facility to measure brake system response time in accordance with paragraph 3.5.2. of annex 6 to this Regulation.

4.2. Checking procedure

4.2.1. Confirm that the manufacturer's/supplier's Information Document demonstrates compliance with the provisions of ISO 11992 with respect to the physical layer, data link layer and application layer.

4.2.2. Check the following, with the simulator connected to the trailer via the ISO 7638 interface and whilst all towing vehicle messages relevant to the interface are being transmitted:

4.2.2.1. Service brake system function:

4.2.2.1.1. The trailer response to the parameters defined in EBS 11 of ISO 11992-2 shall be checked as follows:

The pressure in the supply line at the start of each test shall be ≥ 700 kPa and the vehicle shall be laden (the loading condition may be simulated for the purpose of this check).

4.2.2.1.1.1. For trailers equipped with pneumatic and electric control lines:

both control lines shall be connected
both control lines shall be signalled simultaneously
the simulator shall transmit message byte 3, bits 5 - 6
of EBS 12 set to 01b to indicate to the trailer that a pneumatic control line should be connected

Parameters to be checked:

Message transmitted by the simulator		Pressure at the brake chambers
Byte reference	Digital demand value	
3 - 4	0	0 kPa
3 - 4	33280d (650 kPa)	As defined in the vehicle manufacturer's brake calculation

4.2.2.1.1.2. Trailers equipped with pneumatic and electric control lines or an electric control line only:

Only the electric control line shall be connected
The simulator shall transmit the following messages:
Byte 3, bits 5 - 6 of EBS 12 set to 00b to indicate to the trailer that a pneumatic control line is not available, and byte 3, bits 1 - 2 of EBS 12 set to 01b to indicate to the trailer that the electric control line signal is generated from two electric circuits.

Parameters to be checked:

Message transmitted by the simulator		Pressure at the brake chambers
Byte reference	Digital demand value	
3 - 4	0	0 kPa
3 - 4	33280d (650 kPa)	As defined in the vehicle manufacturer's brake calculation

4.2.2.1.2. For trailers equipped with only an electric control line, the response to messages defined in EBS 12 of ISO 11992-2 shall be checked as follows:

The pneumatic supply line at the start of each test shall be ≥ 700 kPa.

The electric control line shall be connected to the simulator.

The simulator shall transmit the following messages:

Byte 3, bits 5 - 6 of EBS 12 set to 01b to indicate to the trailer that a pneumatic control line is available.

Byte 3-4 of EBS 11 shall be set to 0 (no service brake demand)

The response to the following messages shall be checked:

EBS 12, Byte 3, Bit 1-2	Pressure in the brake chambers or reaction of the trailer
01b	0 kPa (service brake released)
00b	The trailer is automatically braked to demonstrate that the combination is not compatible. A signal should also be transmitted via Pin 5 of the ISO 7638:1997 connector (yellow warning).

4.2.2.1.3. For trailers connected with only an electrical control line, the response of the trailer to a failure in the electric control transmission of the trailer which results in a reduction in braking performance to at least 30 per cent of the prescribed value shall be checked by the following procedure:

The pneumatic supply line at the start of each test shall be ≥ 7.0 kPa.

The electric control line shall be connected to the simulator.

Byte 3, bits 5-6 of EBS 12 set to 00b to indicate to the trailer that a pneumatic control line is not available.

Byte 3, bits 1-2 of EBS 12 set to 01b to indicate to the trailer that the electric control line signal is generated from two independent circuits.

The following shall be checked:

Test condition	Braking system response
With no faults present in the trailer braking system	Check that the braking system is communicating with the simulator and that Byte 4, bits 3-4 of EBS 22 is set to 00b.
Introduce a failure in the electric control transmission of the trailer braking system that prevents at least 30 per cent of the prescribed braking performance from being maintained	Check that Byte 4, bits 3-4 of EBS 22 is set to 01b Or The data communications to the simulator has been terminated

4.2.2.2. Failure warning

4.2.2.2.1. Check that the appropriate warning message or signal is transmitted under the following conditions:

4.2.2.2.1.1. Where a permanent failure within the electric control transmission of the trailer braking system precludes the service braking performance being met, simulate such a failure and check that byte 2, bits 3 - 4 of EBS 22 transmitted by the trailer is set to 01b. A signal should also be transmitted via pin 5 of the ISO 7638 connector (yellow warning).

4.2.2.2.1.2. Reduce the voltage on pins 1 and 2 of the ISO 7638 connector to below a value nominated by the manufacturer which precludes the service braking system performance from being fulfilled and check that byte 2, bits 3 - 4 of EBS 22 transmitted by the trailer are set to 01b. A signal should also be transmitted via pin 5 of the ISO 7638 connector (yellow warning).

4.2.2.2.1.3. Check compliance with the provisions of paragraph 5.2.2.16. of this Regulation by isolating the supply line. Reduce the pressure in the trailer pressure storage system to the value nominated by the manufacturer. Check that byte 2, bits 3 - 4 of EBS 22 transmitted by the trailer is set to 01b and that byte 1, bits 7 - 8 of EBS 23 is set to 00. A signal should also be transmitted via pin 5 of the ISO 7638 connector (yellow warning).

4.2.2.2.1.4. When the electrical part of the braking equipment is first energised check that byte 2, bits 3 - 4 of EBS 22 transmitted by the trailer is set to 01b. After the braking system has checked that no defects that require identification by the red warning signal are present the above message should be set to 00b.

4.2.2.3. Response time checking

4.2.2.3.1. Check that, with no faults present, the braking system response time requirements defined in paragraph 3.5.2. of annex 6 to this Regulation are met.

4.2.3. Additional checks

4.2.3.1. At the discretion of the Technical Service the checking procedures defined above may be repeated with the non-braking messages relevant to the interface in different states or switched off.

Where repeat measurements of the brake system response time are carried out, variations in the value recorded may occur due to the reaction of the vehicle pneumatics. In all cases the prescribed response time requirements shall be met.

Annex 18

SPECIAL REQUIREMENTS TO BE APPLIED TO THE SAFETY ASPECTS OF
COMPLEX ELECTRONIC VEHICLE CONTROL SYSTEMS

1. GENERAL

This annex defines the special requirements for documentation, fault strategy and verification with respect to the safety aspects of complex electronic vehicle control systems (paragraph 2.3. below) as far as this Regulation is concerned.

This annex may also be called, by special paragraphs in this Regulation, for safety related functions which are controlled by electronic system(s).

This annex does not specify the performance criteria for "The System" but covers the methodology applied to the design process and the information which must be disclosed to the technical service, for type approval purposes.

This information shall show that "The System" respects, under normal and fault conditions, all the appropriate performance requirements specified elsewhere in this Regulation.

2. DEFINITIONS

For the purposes of this annex,

- 2.1. "Safety concept" is a description of the measures designed into the system, for example within the electronic units, so as to address system integrity and thereby ensure safe operation even in the event of an electrical failure.

The possibility of a fall-back to partial operation or even to a back-up system for vital vehicle functions may be a part of the safety concept.

- 2.2. "Electronic control system" means a combination of units, designed to co-operate in the production of the stated vehicle control function by electronic data processing.

Such systems, often controlled by software, are built from discrete functional components such as sensors, electronic control units and actuators and connected by transmission links. They may include mechanical, electro-pneumatic or electro-hydraulic elements.

"The System", referred to herein, is the one for which type approval is being sought.

- 2.3. "Complex electronic vehicle control systems" are those electronic control systems which are subject to a hierarchy of control in which a controlled function may be over-ridden by a higher level electronic control system/function.

A function which is over-ridden becomes part of the complex system.

- 2.4. "Higher-level control" systems/functions are those which employ additional processing and/or sensing provisions to modify vehicle behaviour by commanding variations in the normal function(s) of the vehicle control system.

This allows complex systems to automatically change their objectives with a priority which depends on the sensed circumstances.

- 2.5. "Units" are the smallest divisions of system components which will be considered in this annex, since these combinations of components will be treated as single entities for purposes of identification, analysis or replacement.

- 2.6. "Transmission links" are the means used for inter-connecting distributed units for the purpose of conveying signals, operating data or an energy supply.

This equipment is generally electrical but may, in some part, be mechanical, pneumatic, hydraulic or optical.

- 2.7. "Range of control" refers to an output variable and defines the range over which the system is likely to exercise control.

- 2.8. "Boundary of functional operation" defines the boundaries of the external physical limits within which the system is able to maintain control.

3. DOCUMENTATION

3.1. Requirements

The manufacturer shall provide a documentation package which gives access to the basic design of "The System" and the means by which it is linked to other vehicle systems or by which it directly controls output variables.

The function(s) of "The System" and the safety concept, as laid down by the manufacturer, shall be explained.

Documentation shall be brief, yet provide evidence that the design and development has had the benefit of expertise from all the system fields which are involved.

For periodic technical inspections, the documentation shall describe how the current operational status of "The System" can be checked.

3.1.1. Documentation shall be made available in two parts:

- (a) The formal documentation package for the approval, containing the material listed in paragraph 3 (with the exception of that of paragraph 3.4.4.) which shall be supplied to the technical service at the time of submission of the type approval application. This will be taken as the basic reference for the verification process set out in paragraph 4. of this annex.
- (b) Additional material and analysis data of paragraph 3.4.4., which shall be retained by the manufacturer, but made open for inspection at the time of type approval.

3.2. Description of the functions of "The System"

A description shall be provided which gives a simple explanation of all the control functions of "The System" and the methods employed to achieve the objectives, including a statement of the mechanism(s) by which control is exercised.

3.2.1. A list of all input and sensed variables shall be provided and the working range of these defined.

3.2.2. A list of all output variables which are controlled by "The System" shall be provided and an indication given, in each case, of whether the control is direct or via another vehicle system. The range of control (paragraph 2.7.) exercised on each such variable shall be defined.

3.2.3. Limits defining the boundaries of functional operation (paragraph 2.8.) shall be stated where appropriate to system performance.

3.3. System layout and schematics

3.3.1. Inventory of components

A list shall be provided, collating all the units of "The System" and mentioning the other vehicle systems which are needed to achieve the control function in question.

An outline schematic showing these units in combination, shall be provided with both the equipment distribution and the interconnections made clear.

3.3.2. Functions of the units

The function of each unit of "The System" shall be outlined and the signals linking it with other units or with other vehicle systems shall be shown. This may be provided by a labelled block diagram or other schematic, or by a description aided by such a diagram.

3.3.3. Interconnections

Interconnections within "The System" shall be shown by a circuit diagram for the electrical transmission links, by an optical-fiber diagram for optical links, by a piping diagram for pneumatic or hydraulic transmission equipment and by a simplified diagrammatic layout for mechanical linkages.

3.3.4. Signal flow and priorities

There shall be a clear correspondence between these transmission links and the signals carried between units.

Priorities of signals on multiplexed data paths shall be stated, wherever priority may be an issue affecting performance or safety as far as this Regulation is concerned.

3.3.5. Identification of units

Each unit shall be clearly and unambiguously identifiable (e.g. by marking for hardware and marking or software output for software content) to provide corresponding hardware and documentation association.

Where functions are combined within a single unit or indeed within a single computer, but shown in multiple blocks in the block diagram for clarity and ease of explanation, only a single hardware identification marking shall be used.

The manufacturer shall, by the use of this identification, affirm that the equipment supplied conforms to the corresponding document.

3.3.5.1. The identification defines the hardware and software version and, where the latter changes such as to alter the function of the Unit as far as this Regulation is concerned, this identification shall also be changed.

3.4. Safety concept of the manufacturer

3.4.1. The manufacturer shall provide a statement which affirms that the strategy chosen to achieve "The System" objectives will not, under non-fault conditions, prejudice

the safe operation of systems which are subject to the prescriptions of this Regulation.

- 3.4.2. In respect of software employed in "The System", the outline architecture shall be explained and the design methods and tools used shall be identified. The manufacturer shall be prepared, if required, to show some evidence of the means by which they determined the realisation of the system logic, during the design and development process.
- 3.4.3. The Manufacturer shall provide the technical authorities with an explanation of the design provisions built into "The System" so as to generate safe operation under fault conditions. Possible design provisions for failure in "The System" are for example:
- (a) Fall-back to operation using a partial system.
 - (b) Change-over to a separate back-up system.
 - (c) Removal of the high level function.

In case of a failure, the driver shall be warned for example by warning signal or message display. When the system is not deactivated by the driver, e.g. by turning the ignition (run) switch to "off", or by switching off that particular function if a special switch is provided for that purpose, the warning shall be present as long as the fault condition persists.

- 3.4.3.1. If the chosen provision selects a partial performance mode of operation under certain fault conditions, then these conditions shall be stated and the resulting limits of effectiveness defined.
- 3.4.3.2. If the chosen provision selects a second (back-up) means to realise the vehicle control system objective, the principles of the change-over mechanism, the logic and level of redundancy and any built in back-up checking features shall be explained and the resulting limits of back-up effectiveness defined.
- 3.4.3.3. If the chosen provision selects the removal of the Higher Level Function, all the corresponding output control signals associated with this function shall be inhibited, and in such a manner as to limit the transition disturbance.
- 3.4.4. The documentation shall be supported, by an analysis which shows, in overall terms, how the system will behave on the occurrence of any one of those specified faults which will have a bearing on vehicle control performance or safety.

This may be based on a Failure Mode and Effect Analysis (FMEA), a Fault Tree Analysis (FTA) or any similar process appropriate to system safety considerations.

The chosen analytical approach(es) shall be established and maintained by the Manufacturer and shall be made open for inspection by the technical service at the time of the type approval.

3.4.4.1. This documentation shall itemise the parameters being monitored and shall set out, for each fault condition of the type defined in paragraph 3.4.4. above, the warning signal to be given to the driver and/or to service/technical inspection personnel.

4. VERIFICATION AND TEST

4.1. The functional operation of "The System", as laid out in the documents required in paragraph 3., shall be tested as follows:

4.1.1. Verification of the function of "The System"

As the means of establishing the normal operational levels, verification of the performance of the vehicle system under non-fault conditions shall be conducted against the manufacturer's basic benchmark specification unless this is subject to a specified performance test as part of the approval procedure of this or another Regulation.

4.1.2. Verification of the safety concept of paragraph 3.4.

The reaction of "The System" shall, at the discretion of the type approval authority, be checked under the influence of a failure in any individual unit by applying corresponding output signals to electrical units or mechanical elements in order to simulate the effects of internal faults within the unit.

4.1.2.1. The verification results shall correspond with the documented summary of the failure analysis, to a level of overall effect such that the safety concept and execution are confirmed as being adequate.

Annex 19

PERFORMANCE TESTING OF BRAKING COMPONENTS

1. General

This annex defines the test procedures applicable in defining the performance of the following:

- 1.1.1. Diaphragm brakes chambers (refer to paragraph 2).
- 1.1.2. Spring brakes (refer to item 3).
- 1.1.3. Trailer brakes - cold performance characteristics (refer to paragraph 4.).
- 1.1.4. Anti-lock braking systems (refer to paragraph 5.)

(NOTE: Procedures for determining the fade test performance for trailer brakes and automatic brake wear adjustment devices are defined in annex 11 of this Regulation).

- 1.2. The above test reports may be used in conjunction with the procedures defined in annex 20 to this Regulation or at the time of evaluating a trailer which is being subject to actual performance requirements defined for the respective trailer.

2. Performance characteristics for diaphragm brake chambers

2.1. General

- 2.1.1. This section defines the procedure by which the thrust/stroke/pressure characteristics are determined for diaphragm brake chambers which are used in compressed air braking systems 1/ to generate forces required in brakes with mechanical actuation.
- 2.1.2. The verified performance characteristics declared by the manufacturer shall be used in all calculations relating to the brake compatibility requirements of annex 10, the Type-0 cold service braking performance requirements of annex 20 and the determination of the available actuator stroke with respect to the verification of the hot performance of annex 11.

1/ Other brake chamber designs may be approved upon presentation of equivalent information.

2.2. Test procedure:

2.2.1. Zero datum position of the brake chamber is to be taken as the non-pressurised position.

2.2.2. In nominal pressure increments of ≤ 100 kPa, through a pressure range of 1 to ≥ 800 kPa, the corresponding thrust generated is to be monitored over the full stroke range available for a stroke displacement of ≤ 10 mm/s or a stroke increment of ≤ 10 mm and whilst not permitting the applied pressure to deviate ± 5 kPa.

2.2.3. For each pressure increment the corresponding average thrust (T_{hA}) and the effective stroke (s_p) will be determined as per appendix 7 of this annex.

2.3. Verification

2.3.1. With reference to appendix 1 of this annex, paragraphs 3.1., 3.2. and 3.3., a minimum of 6 samples are to be tested, with a verification report being issued, providing no one result deviates by more than 4 per cent of the declared characteristics. However, with respect to the verification of the s_p characteristics the pressure range over which the 4 per cent tolerance is fulfilled shall be recorded and specified in paragraph 3.3.1. of appendix 1 of this annex. Outside of this pressure range the tolerance may exceed 4 per cent.

2.3.2. The test results recorded shall be reported on a form, a model of which is shown in appendix 2 to this annex and shall be included with the verification report detailed within paragraph 2.4.

2.4. Verification report:

2.4.1. The manufacturer's declared performance characteristics, verified by the test results recorded in accordance with paragraph 2.3.2., shall be reported on a form, a model of which is shown in appendix 1 to this annex.

- 3. Performance characteristics for spring brakes
 - 3.1. General:
 - 3.1.1. This section defines the procedure by which the thrust/stroke/pressure characteristics are determined for spring brakes 2/ that are used in compressed air braking systems to generate forces required in brakes with mechanical actuation.
 - 3.1.2. The performance characteristics declared by the manufacturer shall be used in all calculations relating to the parking braking performance requirements of annex 20.
 - 3.2. Test procedure:
 - 3.2.1. Zero datum position of the spring brake chamber is to be taken as the fully pressurised position.
 - 3.2.2. In nominal stroke increments of ≤ 10 mm, the corresponding thrust generated is to be monitored over the full stroke range available at zero pressure.
 - 3.2.3. The pressure shall then be gradually increased until the stroke is 10 mm from the zero datum position, and this pressure, defined as the release pressure, shall be recorded.
 - 3.2.4. The pressure shall then be increased to **850 kPa**, or the maximum working pressure declared by the manufacturer, whichever is lower.
 - 3.3. Verification:
 - 3.3.1. With reference to appendix 3, items 2.1., 3.1., 3.2. and 3.3., a minimum of 6 samples shall be tested, with a verification report being issued providing the following conditions are met:
 - 3.3.1.1. Over a range of stroke from 10 mm to 2/3 of the maximum stroke, no one result, measured in accordance with item 3.2.2., deviates by more than 6 per cent from the declared characteristics.
 - 3.3.1.2. No one result, measured in accordance with paragraph 3.2.3., exceeds the declared value.

2/ Other spring brake designs may be approved upon presentation of equivalent information.

- 3.3.1.3. Each spring brake continues to function correctly after completion of the test in accordance with paragraph 3.2.4.
- 3.3.2. The test results recorded shall be reported on a form, a model of which is shown in appendix 4 to this annex, and shall be included with the verification report detailed within paragraph 3.4.
- 3.4. Verification report:
- 3.4.1. The manufacturer's declared performance characteristics, verified by the test results recorded in accordance with paragraph 3.3.2., shall be reported on a form, a model of which is shown in appendix 3 to this annex.
4. Cold performance characteristics for trailer brakes
- 4.1. General:
- 4.1.1. This procedure covers the testing of the "cold" performance characteristics of air operated S cam and disc brakes 3/ fitted to trailers.
- 4.1.2. The performance characteristics declared by the manufacturer shall be used for all calculations relating to the braking compatibility requirements of annex 10 and to the Type-0 cold service braking and parking braking performance requirements of annex 20.
- 4.2. Brake factor and brake threshold torque
- 4.2.1. The preparation of the brake shall be in accordance with paragraph 4.4.2. of this annex.
- 4.2.2. The brake factor is the resultant amplification factor achieved through the friction forces generated by the individual components comprising the brake assembly, and is expressed as a ratio between the output torque and the input torque. This brake factor is denoted by the symbol B_F and shall be verified for each of the lining or pad materials specified in paragraph 4.3.1.3.
- 4.2.3. The brake threshold torque shall be expressed in a manner that remains valid for variations of brake actuation and is denoted by the symbol C_0 .
- 4.2.4. The values of B_F shall remain valid for variations of the following parameters:

3/ Other brake designs may be approved upon presentation of equivalent information.

- 4.2.4.1. Mass per brake up to that defined in paragraph 4.3.1.5.
- 4.2.4.2. Dimensions and characteristics of external components used to actuate the brake.
- 4.2.4.3. Wheel size/tyre dimensions.
- 4.3. Information document
 - 4.3.1. The brake manufacturer shall provide the Technical Service with at least the following information:
 - 4.3.1.1. A description of the brake type, model, size etc.
 - 4.3.1.2. Details of the brake geometry
 - 4.3.1.3. The make and type of brake lining(s) or brake pad(s)
 - 4.3.1.4. The brake drum or brake disc material
 - 4.3.1.5. The maximum technically permitted mass for the brake
 - 4.3.2. Additional information
 - 4.3.2.1. Wheel and tyre sizes to be used for the test
 - 4.3.2.2. The declared brake factor B_F
 - 4.3.2.3. The declared threshold torque C_o
- 4.4. Test procedure
 - 4.4.1. Preparation
 - 4.4.1.1. A graph defining the acceptable performance variation shall be constructed, following the model shown in Diagram 1, using the manufacturers declared brake factor.
 - 4.4.1.2. The performance of the device used to actuate the brake shall be calibrated within an accuracy of 1 per cent.
 - 4.4.1.3. The dynamic tyre radius at the test loading shall be determined as prescribed for the test method.

- 4.4.2. Bedding in (burnishing) procedure
- 4.4.2.1. In the case of drum brakes the tests shall start with new brake linings and new drum(s), the brake linings shall be machined to achieve the best possible initial contact between the linings and drum(s).
- 4.4.2.2. In the case of disc brakes the tests shall start with new brake pads and new disc(s), machining of the pad material shall be at the discretion of the brake manufacturer.
- 4.4.2.3. Make 20 brake applications from an initial speed of 60 km/h with an input to the brake theoretically equal to 0.3 TR/Test Mass. The initial temperature at the lining/drum or pad/disc interface shall not exceed 100 °C before each brake application.
- 4.4.2.4. Carry out 30 brake applications from 60 km/h to 30 km/h with an input to the brake equal to 0.3 TR/Test Mass and with a time interval between applications of 60 s 4/. The initial temperature at the lining/drum or pad/disc interface on the first brake application shall not exceed 100 °C.
- 4.4.2.5. On completion of the 30 brake applications defined in paragraph 4.4.2.4. above and after an interval of 120 s carry out 5 brake applications from 60 km/h to 30 km/h with an input to the brake equal to 0.3 TR/Test Mass and with an interval of 120 s between applications 4/.
- 4.4.2.6. Make 20 brake applications from an initial speed of 60 km/h with an input to the brake equal to 0.3 TR/Test Mass. The initial temperature at the lining/drum or pad/disc interface shall not exceed 150 °C before each brake application.
- 4.4.2.7. Carry out a performance check as follows:
- 4.4.2.7.1. Determine the input torque to produce theoretical performance values equivalent to 0.2, 0.35 and 0.5 ± 0.05 TR/Test Mass.
- 4.4.2.7.2. Once the input torque value has been determined for each braking rate, this value shall remain constant throughout each and subsequent brake applications (e.g. constant pressure).

4/ If the track test method or the rolling road test methods are to be utilised, energy inputs equivalent to those specified shall be used.

- 4.4.2.7.3. Make a brake application with each of the input torques determined in paragraph 4.4.2.7.1. from an initial speed of 60 km/h. The initial temperature at the lining/drum or pad/disc interfaces shall not exceed 100 °C before each application.
- 4.4.2.8. Repeat the procedures defined in paragraphs 4.4.2.6. and 4.4.2.7.3. above until the performance of five consecutive non monotonic measurements at each constant input value has stabilised within a tolerance of ± 5 per cent.
- 4.4.2.9. In the case of this procedure being carried out on an inertia dynamometer or rolling road, unlimited use of cooling air is permitted.
- 4.4.3. Verification test
- 4.4.3.1. The temperature measured at the lining/drum or pad/disc interface shall not exceed 100 °C, at the start of each brake application.
- 4.4.3.2. The brake threshold torque shall be determined from the measured value of brake input by reference to a calibrated input device.
- 4.4.3.3. The initial speed for all brake applications is 60 ± 2 km/h.
- 4.4.3.4. A minimum of six consecutive brake applications shall be made from 0.15 to 0.55 TR/Test Mass at ascending increments of application pressure, following by six brake applications made with the same application pressures in descending increments.
- 4.4.3.5. For each of the brake applications in paragraph 4.4.3.4. the braking rate is calculated, corrected to take account of rolling resistance, and plotted on the graph specified in paragraph 4.4.1.1. of this annex.
- 4.5. Test methods
- 4.5.1. Track test
- 4.5.1.1. The brake performance test shall be carried out on a single axle only.
- 4.5.1.2. The tests shall be carried out on a straight level track, with a surface affording good adhesion, and performed when there is no wind liable to affect the results.
- 4.5.1.3. The trailer shall be loaded (as closely as possible) to the maximum technically permitted mass for each brake, however, additional mass may be added if required to ensure that sufficient mass is over the axle under test to achieve a

braking rate of 0.55 TR/(maximum technically permitted mass per brake) without wheel lock.

- 4.5.1.4. The dynamic rolling radius of the tyre may be verified at low speed, < 10 km/h, by measuring the distance travelled as a function wheel revolutions, the minimum number of revolutions required to determine the dynamic rolling radius is 10.
- 4.5.1.5. The rolling resistance of the vehicle combination is to be determined by measuring the time taken for the vehicle speed to reduce from 55 to 45 km/h and the distance covered, when tested in the same direction in which the verification test will be carried out and with the engine disconnected and any endurance brake system disengaged.
- 4.5.1.6. Only the brakes of the axle under test shall be actuated and reach an input pressure at the brake input device of 90 ± 3 per cent (after maximum build up time of 0.7 s) of its asymptotic value. The test shall be carried out with the engine disconnected and any endurance braking system disengaged.
- 4.5.1.7. The brakes shall be closely adjusted at the start of the test.
- 4.5.1.8. The brake input for the purpose of calculating the brake threshold torque shall be determined by lifting the wheel and gradually applying the brake whilst the wheel is rotated by hand until resistance is detected.
- 4.5.1.9. The final speed v_2 shall be determined in accordance with annex 11, appendix 2, paragraph 3.1.5.
- 4.5.1.10. The braking performance of the axle under test shall be determined by calculating the deceleration determined from a direct measurement of velocity and distance between $0.8 v_1$ and v_2 , where v_2 shall not be less than $0.1 v_1$. This shall be deemed to be equivalent to the mean fully developed deceleration (MFDD) as defined in annex 4 above.
- 4.5.2. Inertia dynamometer test
- 4.5.2.1. The test shall be carried out on a single brake assembly.
- 4.5.2.2. The test machine shall be capable of generating the inertia required by paragraph 4.5.2.5. of this annex.
- 4.5.2.3. The test machine shall be calibrated for speed and brake output torque within an accuracy of 2 per cent.

- 4.5.2.4. The instrumentation for the test shall be capable of providing at least the following data:
- 4.5.2.4.1. A continuous recording of brake application pressure or force.
- 4.5.2.4.2. A continuous recording of brake output torque.
- 4.5.2.4.3. A continuous recording of the temperature measured at the lining/drum or pad/disc interface.
- 4.5.2.4.4. Speed during the test.
- 4.5.2.5. The inertia (I_T) of the dynamometer shall be set as close as possible, with ± 5 per cent tolerance, including the internal friction of the dynamometer, to that part of the linear inertia of the vehicle acting upon one wheel necessary for a performance of 0.55TR/maximum technically permitted mass according to the following formula:

$$I_T = Pd R^2$$

where

- I_T = actual rotary inertia (kgm^2)
 R = tyre rolling radius defined by the formula $0.485 D$
 D = $d + 2H$ 5/
 d = rim diameter conventional number (mm)
 H = Nominal section height (mm) = $S_1 \times 0.01 Ra$
 S_1 = Section width (mm)
 Ra = nominal aspect ratio
 Pd = Maximum technically permitted mass/brake as defined in paragraph 4.3.1.5.

- 4.5.2.6. Cooling air at ambient temperature may be used, flowing at a velocity not exceeding $0.33 v$ over the brake in a direction perpendicular to its axis of rotation.
- 4.5.2.7. The brake shall be closely adjusted at the start of the test.

5/ Outer diameter of tyre, as defined in Regulation No. 54.

- 4.5.2.8. The brake input for the purpose of calculating the brake threshold torque shall be determined by gradually applying the brake until the onset of brake torque generation is observed.
- 4.5.2.9. The brake performance shall be determined by applying the following formula to the measured brake output torque

$$\text{braking rate} = \frac{M_t R}{I g}$$

where:

M_t = Average brake output torque (Nm) - based on distance
 g = deceleration due to gravity (m/s/s)

The average brake output torque (M_t) shall be calculated from the deceleration determined from a direct measurement of velocity and distance between $0.8 v_1$ and $0.1 v_1$. This shall be deemed to be equivalent to the mean fully developed deceleration (MFDD) as defined in annex 4 above.

- 4.5.3. Rolling road test
- 4.5.3.1. The test will be carried out on single axle with one or two brakes.
- 4.5.3.2. The test machine shall have a calibrated means of imposing load to simulate the required mass for the brake(s) to be tested.
- 4.5.3.3. The test machine shall be calibrated for speed and brake torque within an accuracy of 2 per cent taking into account the internal friction characteristics. The dynamic rolling radius of the tyre (R) shall be determined by measuring the rotational speed of the rolling road and the unbraked wheels of the axle under test at a speed equivalent to 60 km/h, and calculated by the formula

$$R = R_R \frac{n_D}{n_W}$$

where:

R_R = radius of the rolling road
 n_D = rotational speed of rolling road
 n_W = rotational speed of the unbraked wheels of the axle

- 4.5.3.4. Cooling air at ambient temperature may be used, flowing at a velocity not exceeding 0.33 v over the brake(s).
- 4.5.3.5. The brake(s) shall be closely adjusted at the start of the test.
- 4.5.3.6. The brake input for the purpose of calculating the brake threshold torque shall be determined by gradually applying brake(s) until the onset of brake torque generation is observed.
- 4.5.3.7. The brake performance shall be determined by measuring the brake force at the periphery of the tyre calculated to braking rate, taking into account the rolling resistance. The rolling resistance of the loaded axle will be determined by measuring the force at the periphery of the tyre at a speed of 60 km/h.
- The average brake output torque (M_t) shall be based on the measured values between the moment the application pressure/force reaches its asymptotic value from the onset of pressure rise at the brake input device and when the energy input has reached the value W_{60} that is defined in paragraph 4.5.3.8.
- 4.5.3.8. For determining the braking rate an energy input W_{60} equivalent to the kinetic energy of the corresponding mass for the brake under test when braked from 60 km/h to standstill, must be taken into account.

where:

$$W_{60} = \int_0^{t(W_{60})} F_B \cdot v \cdot dt$$

- 4.5.3.8.1. If the test speed v cannot be maintained at 60 ± 2 km/h during the measurement of the braking rate according to paragraph 4.5.3.8., the braking rate shall be determined from the direct measurement of brake force F_B and/or brake output torque M_t , so that the measurement of this/these parameter(s) are not affected by the dynamic forces of the inertia mass of the rolling road test machine.
- 4.6. Verification report
- 4.6.1. The manufacturer's declared performance characteristics, verified by the test results recorded in accordance with paragraph 4.4.3. above, shall be reported on a form, a model of which is shown in appendix 3 to annex 11.

- 5. Anti-lock braking systems (ABS)
- 5.1. General
- 5.1.1. This paragraph defines the procedure to determine the performance of a trailer anti-lock braking system.
- 5.2. Information document
- 5.2.1. The manufacturer of the ABS shall supply to the Technical Service an Information Document of the system(s) requiring performance verification. This document shall contain at least the information defined in appendix 5 to this annex.
- 5.3. Definition of test vehicles
- 5.3.1. Based on the information supplied in the information document, in particular the trailer applications defined in paragraph 2.1. of appendix 5, the Technical Service shall carry out tests on representative trailers having up to three axles and equipped with the respective anti-lock braking system/configuration. Additionally, when selecting trailers for evaluation consideration shall also be given to the parameters defined in the following paragraphs.
 - 5.3.1.1. Suspension type: the method of evaluating the performance of the anti-lock braking system relative to the suspension type will be selected in the following way:
 - Semi-trailers: for each suspension group e.g. balanced mechanical etc. a representative trailer shall be evaluated.
 - Full trailers: Evaluation to be carried out on a representative trailer equipped with any one suspension type.
 - 5.3.1.2. Wheelbase: for semi-trailers the wheelbase shall not be a limiting factor, but for full trailers the shortest wheelbase shall be evaluated.
 - 5.3.1.3. Brake type: approval shall be limited to S cam or disc brakes but should other types become available then comparative testing may be required.
 - 5.3.1.4. Load sensing device: The utilisation of adhesion shall be determined with the load sensing valve set to laden and unladen conditions. In all cases the requirements of paragraph 2.7. of annex 13 to this Regulation shall apply.

- 5.3.1.5. Brake actuation: differentials in the level of actuation shall be recorded for evaluation during the tests to determine the utilisation of adhesion. Results obtained from tests for one trailer may be applied to other trailers of the same type.
- 5.3.2. For each type of trailer under test, documentation showing brake compatibility as defined in annex 10 to this Regulation (diagrams 2 and 4) shall be made available to demonstrate conformity.
- 5.3.3. For the purpose of the approval, semi-trailers and centre axle trailers shall be deemed to be of the same vehicle type.
- 5.4. Test schedule
- 5.4.1. The following tests shall be conducted by the Technical Service on the vehicle(s) defined in paragraph 5.3. of this annex for each ABS configuration taking into consideration the application list defined in paragraph 2.1. of appendix 5 to this annex. However, worst case cross referencing may eliminate certain tests. If worst case testing is actually used, this should be stated in the test report.
- 5.4.1.1. Utilisation of adhesion - Tests shall be carried out according to the procedure defined in paragraph 6.2. of annex 13 to this Regulation for each ABS configuration and trailer type, as defined in the manufacturer's information document (see paragraph 2.1. of appendix 5 to this annex).
- 5.4.1.2. Energy consumption
- 5.4.1.2.1. Axle loading - The trailer(s) to be tested shall be loaded so that the axle load is 2,500 kg or 25 per cent of the permissible axle load whichever is the lower.
- 5.4.1.2.2. It shall be ensured that anti-lock cycling can be achieved throughout the dynamic tests defined in paragraph 6.1.3. of annex 13 to this Regulation.
- 5.4.1.2.3. Energy consumption test - The test shall be carried out according to the procedure defined in paragraph 6.1. of annex 13 to this Regulation for each ABS configuration.
- 5.4.1.2.4. To enable trailers submitted for approval to be checked for conformity to the anti-lock energy consumption requirements (see paragraph 6.1. of annex 13), the following checks shall be carried out:

- 5.4.1.2.4.1. Prior to the commencement of the energy consumption test (paragraph 5.4.1.2.3.) in the case of brakes with non integrated brake wear adjustment the brakes shall be set to a condition where the relationship (R_l) of brake chamber push rod travel (s_T) against lever length (l_T) is 0.2. This relationship shall be determined for a brake chamber pressure of **650 kPa**.

Example $l_T = 130$ mm,
 s_T at **650 kPa** brake chamber pressure = 26 mm

$$R_l = s_T / l_T = 26 / 130 = 0.2$$

In the case of brakes with integrated automatic brake wear adjustment the brakes shall be set to the normal running clearance specified by the manufacturer.

Setting of the brakes as defined above shall be carried out when the brakes are cold (< 100 °C).

- 5.4.1.2.4.2. With the load sensing valve set to the laden condition and the initial energy level set according to paragraph 6.1.2. of annex 13 to this Regulation the energy storage device(s) shall be isolated from further supply of air. The brakes shall be applied with a control pressure of **650 kPa** at the coupling head and then released. Further applications shall be made until the pressure in the brake chambers is the same as that obtained after following the test procedure defined in paragraphs 5.4.1.2.1 and 5.4.1.2.2 above. The number of equivalent brake applications (n_{er}) shall be noted.

The equivalent number of static brake applications (n_e) is to be recorded in the test report.

Where $n_e = 1.2 \cdot n_{er}$ and is to be rounded up to the nearest whole integer

- 5.4.1.3. Split Friction Test - Where an anti-lock braking system is to be defined as category A system then all such ABS configurations shall be subject to the performance requirements of paragraph 6.3.2. of annex 13 to this Regulation.

- 5.4.1.4. Low and high speed performance

- 5.4.1.4.1. With the trailer set as for utilisation of adhesion evaluation, verification of the low and high speed performance shall be carried out according to paragraph 6.3.1. of annex 13 to this Regulation.

- 5.4.1.4.2. Where a tolerance exists between the number of exciter teeth and tyre circumference, functional checks shall be carried out at the extremes of tolerance in accordance with paragraph 6.3. of annex 13 to this Regulation. This may be achieved by utilising different tyre sizes or by producing special exciters to simulate frequency extremes.
- 5.4.1.5. Additional checks
- The following additional checks shall be carried out with the towing vehicle unbraked and the trailer unladen.
- 5.4.1.5.1. When the axle bogie passes from a high adhesion surface (k_H) to a low adhesion surface (k_L) where $k_H \geq 0.5$ and $k_H / k_L \geq 2$, with a control pressure at the coupling head of **650 kPa**, the directly controlled wheels shall not lock. The running speed and the instant of applying the trailer brakes is so calculated that with the anti-lock braking system full cycling on the high adhesion surface, the passage from one surface to the other being made at approximately 80 km/h and at 40 km/h.
- 5.4.1.5.2. When the trailer passes from a low adhesion surface (k_L) to a high adhesion surface (k_H) where $k_H \geq 0.5$ and $k_H / k_L \geq 2$, with a control pressure at the coupling head of **650 kPa**, the pressure at the brake chambers shall rise to an appropriate high value within a reasonable time and the trailer shall not deviate from its initial course. The running speed and the instant of applying the brakes is so calculated that, with the anti-lock braking system full cycling on the low adhesion surface, the passage from one surface to the other occurs at approximately 50 km/h.
- 5.4.1.6. Documentation relating to the controller(s) shall be made available as required by paragraph 5.1.5 of the Regulation and paragraph 4.1. of annex 13 to this Regulation, including footnote 12.
- 5.5. Approval report
- 5.5.1. An approval report shall be produced, the content of which is defined in appendix 6 to this annex.

DIAGRAM 1

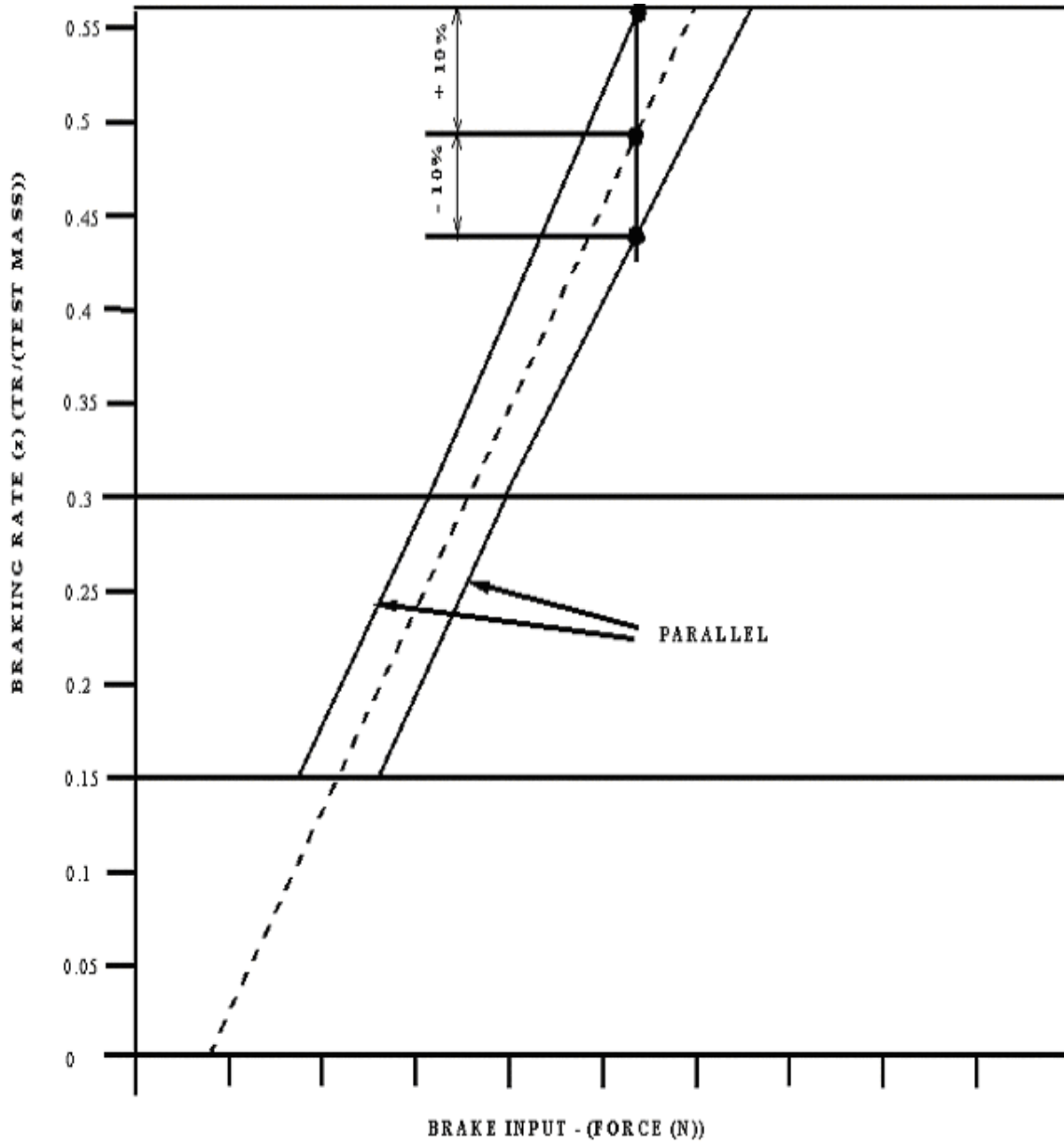

Annex 19 - Appendix 1

MODEL VERIFICATION REPORT FORM FOR DIAPHRAGM BRAKE CHAMBERS

Report No

1. Identification

1.1. Manufacturer: (Name and address)

1.2. Make: 1/

1.3. Type: 1/

1.4. Part number: 1/

2. Operating conditions:

2.1. Maximum working pressure:

3. Performance characteristics declared by the manufacturer:

3.1. Maximum stroke (s_{max}) at 6.5 kPa 2/

3.2. Average thrust (Th_A) - $f(p)$ 2/

3.3. Effective stroke (s_p) - $f(p)$ 2/

3.3.1. Pressure range over which the above affected stroke is valid: (compare paragraph 2.3.1. of annex 19)

4. Name of Technical Service/Approval Authority 3/ conducting the test:

5. Date of test:

6. This test has been carried out and the results reported in accordance with annex 19 to ECE Regulation No. 13 as last amended by the series of amendments.

Technical Service 4/ conducting the test

Signed: Date:

7. Approval Authority 4/

Signed: Date:

8. Test documents:

Appendix 2,,

1/ To be marked on brake chamber, however for inclusion within the test report only the parent part number is required, model variants need not be indicated.

2/ Identification must be amended when changes are made which have an influence on the performance characteristics, paragraphs 3.1., 3.2. and 3.3.

3/ Delete as appropriate.

4/ To be signed by different persons even when the Technical Service and Approval Authority are the same or alternatively, a separate Approval Authority authorization issued with the report.

Annex 19 - Appendix 2

MODEL REFERENCE RECORD OF TEST RESULTS
 FOR DIAPHRAGM BRAKE CHAMBERS

Report No.

1. Record of test results 1/ for part number

Pressure <u>2/</u> p - (kPa)	Average thrust Th _A - (N)	Effective stroke S _p - (mm)

1/ To be created for each of the 6 samples tested.

2/ Pressure "p" will be actual pressure values used in the test as defined in paragraph 2.2.2. of this annex.

Annex 19 - Appendix 3

MODEL VERIFICATION REPORT FORM FOR SPRING BRAKES

Report No

1. Identification:

- 1.1. Manufacturer: (Name and address)
- 1.2. Make: 1/
- 1.3. Type: 1/
- 1.4. Part number: 1/

2. Operating conditions:

- 2.1. Maximum working pressure:

3. Performance characteristics declared by the manufacturer:

- 3.1. Maximum stroke (s_{max}) 2/
- 3.2. Spring thrust (Th_s) - $f(s)$ 2/
- 3.3. Release pressure (at 10 mm stroke) 2/

4. Date of test:

- 5. This test has been carried out and the results reported in accordance with annex 19 to ECE Regulation No. 13 as last amended by the series of amendments.

Technical Service 3/ conducting the test

Signed : Date:

6. Approval Authority 3/

Signed: Date:

7. Test documents:

Appendix 4, ,

1/ To be marked on the spring brake, however for inclusion within the test report only the parent part number is required, model variants need not be indicated.

2/ Identification must be amended when changes are made which have an influence on the performance characteristics, paragraphs 3.1., 3.2. and 3.3.

3/ To be signed by different persons even when the Technical Service and Approval Authority are the same or alternatively, a separate Approval Authority authorization issued with the report.

Annex 19 - Appendix 4

MODEL REFERENCE RECORD OF TEST RESULTS FOR SPRING BRAKES

Report No

1. Record of test results 1/ for part number:

Stroke <u>2/</u> s - (mm)	Thrust Th _s - (N)

Release pressure (at 10 mm stroke) kPa

1/ To be created for each of the 6 samples tested.

2/ Stroke "s" will be the actual stroke values used in the test as defined in paragraph 3.2.2. of this annex.

Annex 19 - Appendix 5

TRAILER ANTI-LOCK BRAKING SYSTEM INFORMATION DOCUMENT

1. General
 - 1.1. Name of manufacturer
 - 1.2. System name
 - 1.3. System variations
 - 1.4. System configurations (e.g. 2S/1M, 2S/2M etc.)
 - 1.5. Explanation of the basic function and/or philosophy of the system.
2. Applications
 - 2.1. List of trailer types and ABS configurations for which approval is required.
 - 2.2. Schematic diagrams of the system configurations installed on the trailers defined in item 2.1. above with consideration given to the following parameters:
 - Sensor locations
 - Modulator locations
 - Lift axles
 - Steering axles
 - Tube: type - bore size(s) and lengths
 - 2.3. Relationship of tyre circumference to the resolution of the exciter, including tolerances.
 - 2.4. Tolerance of tyre circumference between one axle and another fitted with the same exciter.
 - 2.5. Scope of application with respect to suspension type e.g. balanced mechanical etc. with reference to the manufacturer and model/type.
 - 2.6. Recommendations on differential brake input torque (if any) in relation to the ABS configuration and trailer bogie.
 - 2.7. Additional information (if applicable) to the application of the anti-lock braking system.

- 3. Component description
 - 3.1. Sensor(s)
Function
Identification (e.g. part number(s))
 - 3.2. Controller(s)
General description and function
Identification (e.g. part number(s))
Safety aspects of controller(s)
Additional features (e.g. retarder control, automatic configuration, variable parameters, diagnostics)
 - 3.3. Modulator(s)
General description and function
Identification (e.g. part number(s))
Limitations (e.g. maximum delivery volumes to be controlled)
 - 3.4. Electrical Equipment
Circuit diagram(s)
Powering methods
Warning lamp sequence(s)
 - 3.5. Pneumatic Circuits
Braking schematics covering the ABS configurations as applied to the trailer types defined in paragraph 5.2.1.2.1.
Limitations on pipe, tube sizes and associated lengths that have an effect on system performance (e.g. between modulator and brake chamber)
 - 3.6. Electro Magnetic Compatibility
 - 3.6.1. Documentation demonstrating compliance with the provisions of paragraph 4.4. of annex 13 to this Regulation.
-

Annex 19 - Appendix 6

TRAILER ANTI-LOCK BRAKING SYSTEM TEST REPORT

Test Report No:

1. Identification
 - 1.1. Manufacturer of the anti-lock braking system (name and address)
 - 1.2. System name/model
2. System(s) and Installation(s) approved
 - 2.1. ABS configuration(s) approved (e.g. 2S/1M, 2S/2M etc.):
 - 2.2. Range of application (type of trailer and number of axles):
 - 2.3. Methods of powering: ISO 7638, ISO 1185 etc.
 - 2.4. Identification of approved sensor(s), controller(s) and modulator(s):
 - 2.5. Energy consumption - equivalent number of static brake applications.
 - 2.6. Additional features e.g. retarder control, lift axle configuration etc.
3. Test Data and Results
 - 3.1. Test vehicle data:
 - 3.2. Test surface information:
 - 3.3. Test results:
 - 3.3.1. Utilisation of adhesion:
 - 3.3.2. Energy consumption:
 - 3.3.3. Split friction test:
 - 3.3.4. Low speed performance:
 - 3.3.5. High-speed performance:

3.3.6. Additional checks:

3.3.6.1. Transition from high to low adhesion surfaces:

3.3.6.2. Transition from low to high adhesion surfaces:

3.3.7. Failure mode simulation:

3.3.8. Functional checks of optional power connections:

3.3.9. Electro-magnetic compatibility

4. Limits of installation.

4.1. Relationship of tyre circumference to the resolution of the exciter:

4.2. Tolerance on tyre circumference between one axle and another fitted with the same exciter:

4.3. Suspension type:

4.4. Differential(s) in brake input torque within the trailer bogie:

4.5. Wheel base of full trailer:

4.6. Brake type:

4.7. Tube sizes and lengths

4.8. Load sensing device application:

4.9. Warning lamp sequence:

4.10. System configurations and applications that comply with the category A requirements.

4.11. Other recommendations/limitations (e.g. location of sensors, modulator(s), lift axle(s), steering axle(s)):

5. Date of Test:

This test has been carried out and the results reported in accordance with annex 19 to ECE Regulation No. 13 as last amended by the series of amendments.

Technical Service 1/ conducting the test

Signed: Date:

6. Approval Authority 1/

Signed: Date:

Attachment: Manufacturer's information document

1/ To be signed by different persons even when the Technical Service and Approval Authority are the same or alternatively, a separate Approval Authority authorisation issued with the report.

Annex 19 - Appendix 7

SYMBOLS AND DEFINITIONS

SYMBOL	DEFINITION
B_F	Brake factor (input torque to output torque amplification ratio)
C_O	Threshold input torque (minimum torque necessary to produce a measurable brake torque)
D	Outer tyre diameter (overall diameter of an inflated new tyre)
d	A conventional number denoting the nominal rim diameter and corresponding to the diameter of the rim expressed either in inches or mm
F_B	Brake force
H	Nominal tyre section height (the distance equal to half the difference between the outer diameter of the tyre and the nominal rim diameter)
I	Rotary inertia
l_T	Brake lever length of reference test trailer
M_t	Average brake output torque
n_e	Equivalent number of static brake applications for the purpose of type approval
n_{er}	Equivalent number of static applications obtained during testing
n_D	Rotational speed of the rolling road
n_W	Rotational speed of the unbraked wheels of the axle
P_d	Maximum technically permitted mass for the brake
p	Pressure
R	Dynamic tyre rolling radius (calculated using $0.485D$)

SYMBOL	DEFINITION
R _a	Nominal aspect ratio of the tyre (one hundred times the number obtained by dividing the number expressing the nominal section height of the tyre in mm by the number expressing the nominal section width in mm).
R _l	Ratio of S_T / l_T
R _R	Radius of the rolling road
S ₁	Section width of the tyre (linear distance between the outsides of the sidewalls of an inflated tyre, excluding elevations due to labelling (marking), decorations or protective bands or ribs).
s	Actuator stroke (working stroke plus free stroke)
S _{max}	Total actuator stroke
S _p	Effective stroke (the stroke at which the output thrust is 90per cent of the average thrust Th _A)
S _T	Brake chamber push rod travel of reference test trailer in mm
Th _A	Average thrust (the average thrust is determined by integrating the values between 1/3 and 2/3 of the total stroke S _{max})
Th _s	Spring thrust of the spring brake
TR	Sum of braking forces at periphery of all wheels of trailer or semi-trailer
V	Rolling road test speed
v ₁	Initial speed, when braking starts
v ₂	Speed at end of braking
W ₆₀	Energy input, equivalent to the kinetic energy of the corresponding mass for the brake under test when braked from 60 km/h to standstill
Z	Braking rate of vehicle

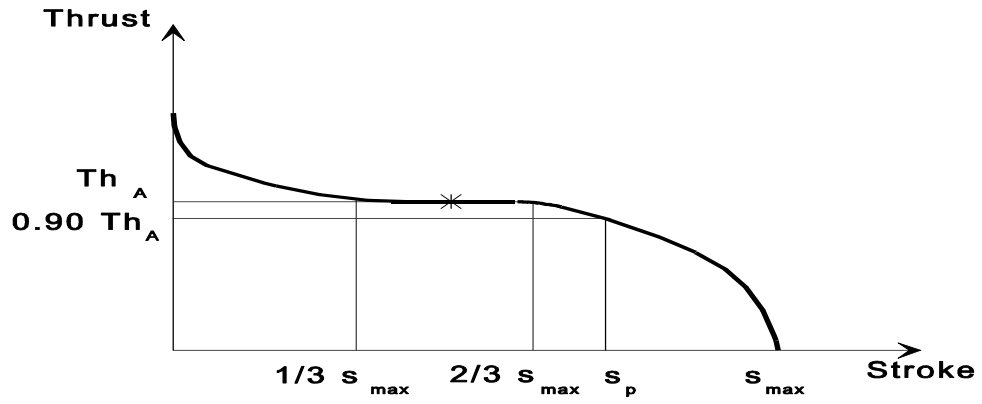

Annex 20

ALTERNATIVE PROCEDURE FOR THE TYPE APPROVAL OF TRAILERS

1. General
 - 1.1. This annex defines an alternative procedure for type approving trailers, utilising information from test reports issued in accordance with annexes 11 and 19.
 - 1.2. On completion of the verification procedures described in paragraphs 3., 4., 5., 6., 7. and 8. of this annex, the Technical Service / Approval Authority shall issue an ECE type approval certificate conforming to the model specified in annex 2, appendix 1 to this Regulation.
 - 1.3. For the purposes of the calculations defined within this annex the centre of gravity height shall be determined in accordance with the method defined in appendix 1 to this annex.
2. Application for type approval
 - 2.1. The application for ECE type approval of a trailer type with regard to the braking equipment shall be submitted by the trailer manufacturer. In support of the approval the trailer manufacturer shall supply to the Technical Service at least the following:
 - 2.1.1. A copy of the ECE or EU Type Approval Certificate and an Information Document of a trailer hereafter referred to as the "reference trailer" on which the service braking performance comparison is to be based. This trailer will have been subject to the actual tests defined in annex 4 to this Regulation for the appropriate trailer or equivalent EU Directive. A trailer that has been approved to the alternative procedure defined in this annex shall not be used as a reference trailer.
 - 2.1.2. Copies of the annex 11 and annex 19 test reports.
 - 2.1.3. A documentation package that contains the relevant verification information including the relevant calculations for the following:

Performance Requirements	Annex 20 reference
Cold service braking performance	3.0
Parking brake performance	4.0
Emergency brake performance	5.0
Failure of brake distribution system	6.0
Anti-lock braking	7.0

- 2.1.4. A trailer, representative of the trailer type to be approved hereafter referred to as the "subject trailer".
- 2.2. The manufacturer of the "reference trailer" and "subject trailer" shall be the same.
3. Alternative procedure for demonstrating the Type-0 service braking cold performance.
- 3.1. To demonstrate compliance with the Type-0 service braking cold performance it shall be verified, by calculation, that the "subject trailer" has sufficient brake force (TR) available to achieve the prescribed service braking performance and that there is sufficient adhesion available on a dry road surface (assumed to have a coefficient of adhesion of 0.8) to utilise this brake force.
- 3.2. Verification
- 3.2.1. The requirements of annex 4, paragraph 1.2.7. and 3.1.2. (cold performance requirement and achievement without wheel lock, deviation or abnormal vibration) are considered to be satisfied by the subject trailer if it meets the verification criteria described in the following paragraphs, in both the laden and unladen conditions:
- 3.2.1.1. The wheelbase of the subject trailer shall not be less than 0.8 times the reference trailer wheelbase.
- 3.2.1.2. Any difference in the brake input torque between one axle and another within a bogie of the "subject trailer" shall not differ from that of the "reference trailer".
- 3.2.1.3. The number and arrangement of axles i.e. lifting, steering etc. of the "subject trailer" shall not differ from that of the reference trailer.
- 3.2.1.4. The percentage distribution of the laden static axle load of the subject trailer shall not differ from that of the reference trailer by more than 10 per cent.

- 3.2.1.5. For semi trailers, a graph, in accordance with appendix 2, shall be constructed and, from this graph, it shall be verified that:
- $TR_{max} \geq TR_{pr}$ (i.e. line (1) shall not be below line (3)), and
- $TR_L \geq TR_{pr}$ (i.e. line (2) shall not be below line (3)).
- 3.2.1.6. For centre axle trailers, a graph, in accordance with appendix 3, shall be constructed and, from this graph, it shall be verified that:
- $TR_{max} \geq TR_{pr}$ (i.e. line (1) shall not be below line (3)), and
- $TR_L \geq TR_{pr}$ (i.e. line (2) shall not be below line (3)).
- 3.2.1.7. For full trailers, a graph, in accordance with appendix 4, shall be constructed and, from this graph, it shall be verified that:
- $TR_{max} \geq TR_{pr}$ (i.e. line (1) shall not be below line (2)), and
- $TR_{Lf} \geq TR_{prf}$ (i.e. line (4) shall not be below line (3)), and
- $TR_{Lr} \geq TR_{prr}$ (i.e. line (6) shall not be below line (5)).
4. Alternative procedure for demonstrating the parking brake performance.
- 4.1. General
- 4.1.1. This procedure provides an alternative to physically testing trailers on a gradient and ensures that trailers fitted with spring brake actuated parking mechanisms can meet the prescribed parking brake performance. This procedure shall not be applied to trailers fitted with parking mechanisms operated by means other than spring brakes. Such trailers shall be subjected to the physical test prescribed in annex 4.
- 4.1.2. The prescribed parking braking performance shall be demonstrated by calculation, using the formulae contained in paragraphs 4.2. and 4.3.
- 4.2. Parking performance
- 4.2.1. The parking brake force at the periphery of the tyres of axle(s) braked by the spring brake actuated parking mechanism shall be calculated using the following formula:

$$T_{pi} = (Th_s \cdot 1 - C_o) \cdot n \cdot B_F / R_s$$

4.2.2. The normal reaction of the road surface on the axles of a stationary trailer facing uphill and downhill on an 18 per cent gradient shall be calculated using the following formulae:

4.2.2.1. In the case of full trailers:

4.2.2.1.1. Facing uphill

$$N_{FU} = PR_F - \frac{\tan P \times h \times P}{E_L} \cos P$$

$$N_{FU_i} = \frac{N_{FU}}{i_F}$$

$$N_{RU} = PR_R + \frac{\tan P \times h \times P}{E_L} \cos P$$

$$N_{RU_i} = \frac{N_{RU}}{i_R}$$

4.2.2.1.2. Facing downhill

$$N_{FD} = PR_F + \frac{\tan P \times h \times P}{E_L} \cos P$$

$$N_{FD_i} = \frac{N_{FD}}{i_F}$$

$$N_{RD} = PR_R - \frac{\tan P \times h \times P}{E_L} \cos P$$

$$N_{RD_i} = \frac{N_{RD}}{i_R}$$

4.2.2.2. In the case of centre axle trailers:

4.2.2.1. Facing uphill

$$N_{RU} = P + \frac{\tan P \times h \times P}{E_L} \cos P$$

$$N_{RU_i} = \frac{N_{RU}}{i_R}$$

4.2.2.2.2. Facing downhill

$$N_{RD} = P - \frac{\tan P \times h \times P}{E_L} \cos P$$

$$N_{RD_i} = \frac{N_{RD}}{i_R}$$

4.2.2.3. In the case of semi-trailers:

4.2.2.3.1. Facing uphill

$$N_{RU} = P - \frac{P_s \times E_R}{E_L} + \frac{\tan P \times h \times P}{E_L} \cos P$$

$$N_{RU_i} = \frac{N_{RU}}{i_R}$$

4.2.2.3.2. Facing downhill

$$N_{RD} = P - \frac{P_s \times E_R}{E_L} - \frac{\tan P \times h \times P}{E_L} \cos P$$

$$N_{RD_i} = \frac{N_{RD}}{i_R}$$

4.3. Verification

4.3.1. The parking brake performance of the trailer shall be verified using the following formulae:

$$\left(\frac{\sum A_{Di} + \sum B_{Di}}{P} + 0.01 \right) \times 100 \geq 18\%$$

and:

$$\left(\frac{\sum A_{Ui} + \sum B_{Ui}}{P} + 0.01 \right) \times 100 \geq 18\%$$

5. Alternative procedure for demonstrating the emergency/automatic braking performance

5.1. General

5.1.1. To demonstrate compliance with the automatic braking performance requirements, either a comparison is made between the chamber pressure required to achieve the specified performance and the asymptotic chamber pressure after disconnection of the supply line, as defined in paragraph 5.2.1., or it shall be verified that the brake force provided by the axle(s) fitted with spring brakes is sufficient to achieve the specified performance, as defined in paragraph 5.2.2.

5.2. Verification

5.2.1. The requirements of annex 4, paragraph 3.3., are considered to be satisfied by a subject trailer if the asymptotic chamber pressure (p_c) after disconnection of the supply line is greater than the chamber pressure (p_c) to achieve a performance of 13.5 per cent of the maximum stationary wheel load. The supply line pressure being stabilised at **700 kPa** prior to disconnection.

5.2.2. The requirements of annex 4, paragraph 3.3., are considered to be satisfied by a spring brake equipped subject trailer if:

$$s T_{pi} \geq 0.135 \cdot PR \cdot g$$

where T_{pi} is calculated in accordance with paragraph 4.2.1.

6. Alternative procedure for demonstrating braking performance in the case of failure of the braking distribution system
 - 6.1. General
 - 6.1.1. To demonstrate compliance with the braking performance requirements in the case of a failure of the braking distribution system, a comparison is made between the chamber pressure required to achieve the specified performance and the chamber pressure available when a failure in the braking distribution system exists.
 - 6.2. Verification
 - 6.2.1. The requirements of annex 10, appendix, paragraph 6., are considered to be satisfied by the subject trailer if the pressure defined in paragraph 6.2.1.1. is greater than or equal to the pressure defined in paragraph 6.2.1.2., in both laden and unladen conditions.
 - 6.2.1.1. The chamber pressure (p_c) of the subject trailer, when $p_m = 6.5$ kPa, the supply line pressure = 7.0 kPa and a failure in the braking distribution system exists.
 - 6.2.1.2. The chamber pressure (p_c) to achieve a braking rate of 30 per cent of the service braking performance prescribed for the subject trailer.
7. Alternative procedure for demonstrating the anti-lock braking performance
 - 7.1. General
 - 7.1.1. Testing of a trailer in accordance with annex 13 to this Regulation may be waived at the time of type approval of the trailer provided that the anti-lock braking system (ABS) complies with the requirements of annex 19 to this Regulation.
 - 7.2. Verification
 - 7.2.1. Verification of components and installation
The specification of the ABS installed on the trailer to be type approved shall be verified by satisfying each of the following criteria:

Paragraph		CRITERIA
7.2.1.1.	(a) Sensor(s)	No change allowed
	(b) Controller(s)	No change allowed
	(c) Modulator(s)	No change allowed
7.2.1.2.	Tube size(s) and lengths	
	(a) Reservoir supply to modulator(s)	
	Minimum inside diameter	May be increased
	Maximum overall length	May be reduced
	(b) Modulator delivery to brake chambers	
	Inside diameter	No change allowed
	Maximum overall length	May be reduced
7.2.1.3.	Warning signal sequence	No change allowed
7.2.1.4.	Differentials in brake input torque within a bogie	Only approved differentials (if any) permitted
7.2.1.5.	For other limitations refer to paragraph 4. of the test report as described in appendix 6 of annex 19 to this Regulation	Installation to be within the scope of the limitations defined - No deviations allowed

7.3. Verification of reservoir capacity

7.3.1. As the range of braking systems and auxiliary equipment used on trailers is diverse it is not possible to have a table of recommended reservoir capacities. To verify that adequate storage capacity is installed, testing may be conducted according to paragraph 6.1. of annex 13 to this Regulation or by the procedure defined below:

- 7.3.1.1. In the case of brakes with non integrated brake wear adjustment the brakes on the subject trailer shall be set to a condition where the relationship (R_l) of brake chamber push rod travel (s_T) against lever length (l_T) is 0.2.

Example:

$$l_t = 130 \text{ mm}$$

$$R_e = s_T/l_T = s_T/130 = 0.2$$

$$\begin{aligned} s_T &= \text{Push rod travel at } 650 \text{ kPa brake chamber pressure} \\ &= 130 \times 0.2 = 26 \text{ mm} \end{aligned}$$

- 7.3.1.2. In the case of brakes with integrated automatic brake wear adjustment the brakes shall be set to a normal running clearance.

- 7.3.1.3. Setting of the brakes as defined above shall be carried out when the brakes are cold (≤ 100 °C).

- 7.3.1.4. With the brakes adjusted according to relevant procedure defined above and the load sensing device(s) set to the laden condition and the initial energy level set according to paragraph 6.1.2. of annex 13 to this Regulation, the energy storage device(s) shall be isolated from further supply. The brakes shall be applied with a control pressure of 650 kPa at the coupling head and then fully released. Further brake applications shall be made up to the number n_e determined from the test conducted in accordance with paragraph 5.4.1.2.4.2. of annex 19 to this Regulation and defined in paragraph 2.5. of the anti-lock braking system Approval Report. During this application, the pressure in the operating circuit shall be sufficient to provide a total braking force at the periphery of the wheels equal to not less than 22.5 per cent of the maximum stationary wheel load and without causing automatic application of any braking system not under the control of the anti-lock braking system.

8. Functional and installation checks

- 8.1. The Technical Service / Approval Authority shall carry out functional and installation checks covering the following paragraphs:

8.1.1. Anti-lock function

- 8.1.1.1. This shall be limited to a dynamic check of the anti-lock braking system. To ensure full cycling it may be necessary to adjust the load sensing device or

utilise a surface having a low tyre to road adhesion. If the anti-lock system does not have an annex 19 approval, the trailer shall be tested in accordance with annex 13 and comply with the relevant requirements contained in that annex.

- 8.1.2. Response time measurement
 - 8.1.2.1. The Technical Service shall verify that the subject trailer conforms to the requirements of annex 6.
 - 8.1.3. Static energy consumption
 - 8.1.3.1. The Technical Service shall verify that the subject trailer conforms to the requirements of annex 7 and annex 8 as appropriate.
 - 8.1.4. Service brake function
 - 8.1.4.1. The Technical Service shall verify that there are no abnormal vibrations during braking.
 - 8.1.5. Parking brake function
 - 8.1.5.1. The Technical Service shall apply and release the park brake to ensure correct function.
 - 8.1.6. Emergency/automatic braking function
 - 8.1.6.1. The Technical Service shall verify that the subject trailer complies with the requirements of paragraph 5.2.1.18.4.2. of this Regulation.
 - 8.1.7. Vehicle and component identification verification
 - 8.1.7.1. The Technical Service shall check the subject trailer against the details contained in the type approval certificate.
 - 8.1.8. Additional checks
 - 8.1.8.1. The Technical Service may request additional checks to be carried out, if necessary.
-

Annex 20 - Appendix 1

METHOD OF CALCULATING THE CENTRE OF GRAVITY HEIGHT

The centre of gravity height for the complete vehicle (laden and unladen) can be calculated as follows:

$$h1 = \text{centre of gravity height of axle(s) assembly (inc. tyres, springs, etc.)} = R \cdot 1.1$$

$$h2 = \text{centre of gravity height of frame (laden)} = (h6 + h8) \cdot 0.5$$

$$h3 = \text{centre of gravity height of payload and bodywork (laden)} \\ = (h7 \cdot 0.3) + h6$$

$$h4 = \text{centre of gravity height of frame (unladen)} = h2 + s$$

$$h5 = \text{centre of gravity height of bodywork (unladen)} = (h7 \cdot 0.5) + h6 + s$$

where:

h6 = frame height, top

h7 = body dimensions, inside

h8 = frame height, bottom

P = total mass of the trailer

PR = total mass on all wheels of a semi trailer or centre axle trailer

R = radius of the tyre

s = spring deflection between laden and unladen

W1 = mass of axle(s) assembly (inc. tyres, springs, etc.) = $P \cdot 0.1$

W2 = mass of the frame = $(P_{\text{unl}} - W1) \cdot 0.8$

W3 = mass of payload and bodywork

W4 = mass of bodywork = $(P_{\text{unl}} - W1) \cdot 0.2$

LADEN:

$$h_{Rlad} = \frac{h1.W1 + h2.W2 + h3.W3}{P_{lad}}$$

UNLADEN:

$$h_{Runl} = \frac{h1.W1 + h4.W2 + h5.W4}{P_{unl}}$$

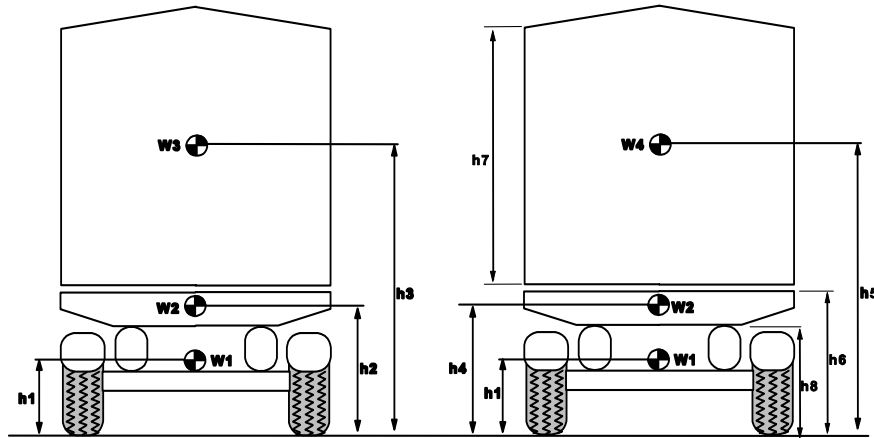

NOTES:

- (1) For flat bed type trailers, a maximum height of 4 m shall be used.
- (2) For trailers where the exact centre of gravity height of the payload is not known, it shall be taken as 0.3 times the inside dimensions of the body.
- (3) For trailers with air suspension, the value of s shall be taken as zero.
- (4) For semi-trailers and centre axle trailers, replace P with PR wherever it occurs.

Annex 20 - Appendix 2

VERIFICATION GRAPH FOR PARAGRAPH 3.2.1.5. - SEMI-TRAILERS

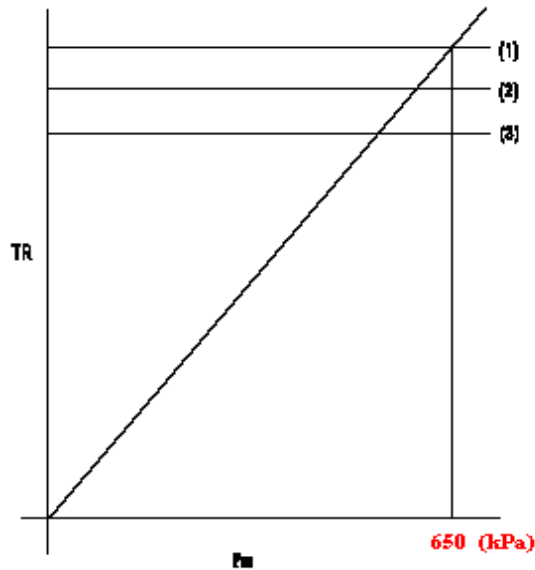

- (1) = TR_{max} , when $p_m = 650$ kPa and supply line = 700 kPa.
 (2) = $F_{Rdyn} \cdot 0.8 = TR_L$
 (3) = $0.45 \cdot F_R = TR_{pr}$

where:

$$F_{Rdyn} = F_R - \frac{(TR_{pr} \times h_k) + (p \times g \times z_c (h_R - h_k))}{E_R}$$

the value of z_c being calculated using the following formula:

$$z_c = 0.45 + 0.01 \left(\frac{F_R}{(P + 7000) g} \right) + 0.01$$

NOTES:

- (1) The value of 7,000 above represents the mass of a towing vehicle with no trailer attached.
 (2) For the purpose of these calculations, closely spaced axles (having an axle spread of less than 2 metres) may be treated as one axle.

Annex 20 - Appendix 3

VERIFICATION GRAPH FOR PARAGRAPH 3.2.1.6 - CENTRE AXLE TRAILERS

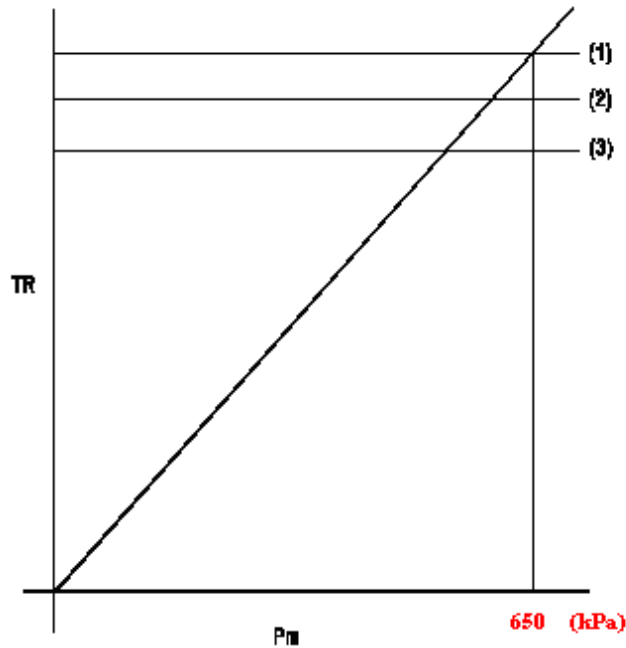

(1) = TR_{max} , when $p_m = 650 \text{ kPa}$ and supply line = 700 kPa .

(2) = $F_{Rdyn} \cdot 0.8 = TR_L$

(3) = $0.5 \cdot F_R = TR_{pr}$

where:

$$F_{Rdyn} = F_R - \frac{(TR_{pr} \times h_k) + (p \times g \times z_c (h_R - h_k))}{E_R}$$

the value of z_c being calculated using the following formula:

$$z_c = 0.5 - 0.01 \left(\frac{F_R}{(P + 7000) g} \right) + 0.01$$

NOTES:

- (1) The value of 7,000 above represents the mass of a towing vehicle with no trailer attached.
- (2) For the purpose of these calculations, closely spaced axles (having an axle spread of less than 2 metres) may be treated as one axle.

Annex 20 - Appendix 4

VERIFICATION GRAPH FOR PARAGRAPH 3.2.1.7. - FULL TRAILERS

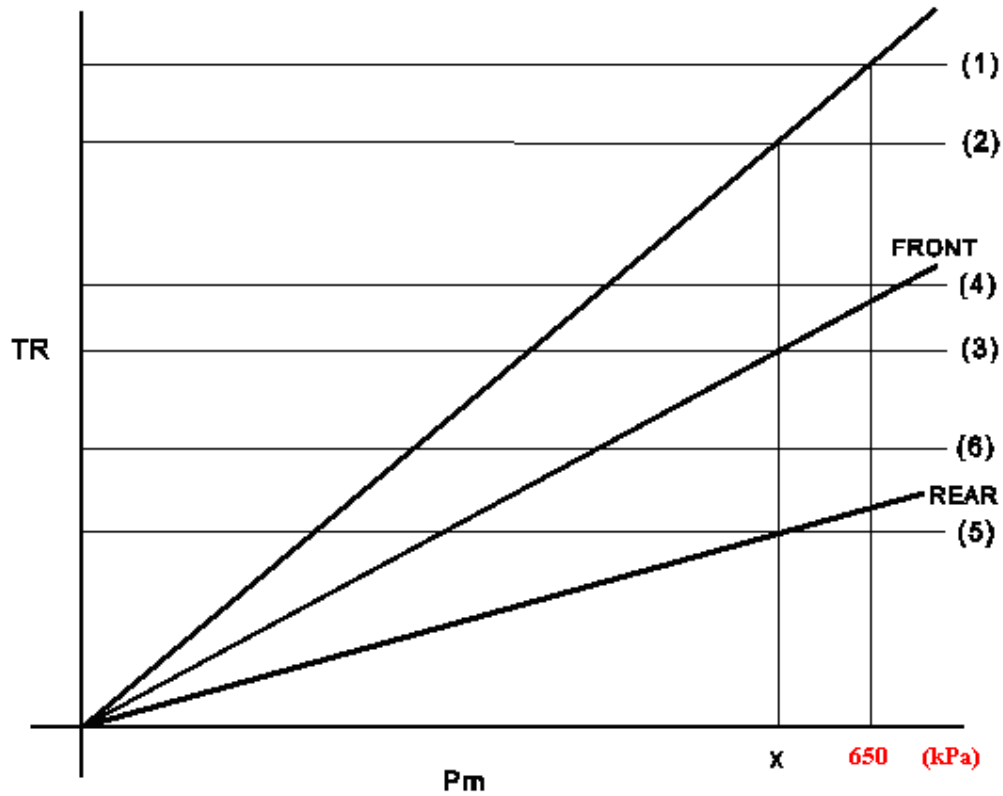

(1) = TR_{\max} , when $p_m = 650 \text{ kPa}$ and supply line = 700 kPa .

(2) = $0.5 \cdot F_R = TR_{pr}$

(3) = $TR_{prf} = TR_f$, when $p_m = x$

(4) = $F_{fdyn} \cdot 0.8 = TR_{Lf}$

(5) = $TR_{prr} = TR_r$, when $p_m = x$

(6) = $F_{rdyn} \cdot 0.8 = TR_{Lr}$

where:

$$F_{fgdyn} = F_f + \frac{P \times g \times z_c \times h_R}{E}$$

and

$$F_{rdyn} = F_r - \frac{P \times g \times z_c \times h_R}{E}$$

the value of z_c being calculated using the following formula:

$$z_c = 0.5 - 0.01 \left(\frac{F_R}{(p + 7000) g} \right) + 0.01$$

NOTES:

- (1) The value of 7,000 above represents the mass of a towing vehicle with no trailer attached.
 - (2) For the purpose of these calculations, closely spaced axles (having an axle spread of less than 2 metres) may be treated as one axle.
-

Annex 20 - Appendix 5

SYMBOLS AND DEFINITIONS

SYMBOL	DEFINITION
A_{Di}	T_{pi} when $T_{pi} \leq 0.8 N_{FDi}$ for front axles, or $0.8 N_{FDi}$ when $T_{pi} > 0.8 N_{FDi}$ for front axles
B_{Di}	T_{pi} when $T_{pi} \leq 0.8 N_{RDi}$ for rear axles, or $0.8 N_{RDi}$ when $T_{pi} > 0.8 N_{RDi}$ for rear axles
A_{Ui}	T_{pi} when $T_{pi} \leq 0.8 N_{FU_i}$ for front axles, or $0.8 N_{FU_i}$ when $T_{pi} > 0.8 N_{FU_i}$ for front axles
B_{Ui}	T_{pi} when $T_{pi} \leq 0.8 N_{RU_i}$ for rear axles, or $0.8 N_{RU_i}$ when $T_{pi} > 0.8 N_{RU_i}$ for rear axles
B_F	brake factor
C_o	threshold camshaft input torque (minimum camshaft torque necessary to produce a measurable brake torque)
E	wheelbase
E_L	distance between the coupling support leg or landing legs to the centre of the axle(s) of a centre axle trailer or semi-trailer
E_R	distance between king-pin and centre of axle or axles of semi-trailer
F	force (N)
F_f	total normal static reaction of road surface on front axle(s)
F_{fdyn}	total normal dynamic reaction of road surface on front axles(s)
F_r	total normal static reaction of road surface on rear axle(s)
F_{rdyn}	total normal dynamic reaction of road surface on rear axle(s)

SYMBOL	DEFINITION
F_R	total normal static reaction of road surface on all wheels of the trailer or semi-trailer
F_{Rdyn}	total normal dynamic reaction of road surface on all wheels of the trailer or semi-trailer
g	acceleration due to gravity (9.81 m/s ²)
h	height above ground of centre of gravity
h_K	height of fifth wheel coupling (king pin)
h_r	height of centre of gravity of trailer
i	axle index
i_F	number of front axles
i_R	number of rear axles
l	lever length
n	number of spring brake actuators per axle
N_{FD}	total normal reaction of road surface on front axle(s) when facing downhill on an 18 per cent gradient
N_{FDi}	normal reaction of road surface on front axle i when facing downhill on an 18 per cent gradient
N_{FU}	total normal reaction of road surface on front axle(s) when facing uphill on an 18 per cent gradient
N_{FUi}	normal reaction of road surface on front axle i when facing uphill on an 18 per cent gradient
N_{RD}	total normal reaction of road surface on rear axle(s) when facing downhill on an 18 per cent gradient

SYMBOL	DEFINITION
N_{RD_i}	normal reaction of road surface on rear axle i when facing downhill on an 18 per cent gradient
N_{RU}	total normal reaction of road surface on rear axle(s) when facing uphill on an 18 per cent gradient
N_{RU_i}	normal reaction of road surface on rear axle i when facing uphill on an 18 per cent gradient
p_m	pressure at coupling head of control line
p_c	pressure in the brake chamber
P	mass of individual vehicle
P_s	static mass at fifth wheel coupling at trailer mass P
PR	total normal static reaction of road surface on wheels of trailer or semi-trailer
PR_F	total normal static reaction of road surface on the front axles on level ground
PR_R	total normal static reaction of road surface on the rear axles on level ground
R_s	static laden radius of the tyre, calculated using the following formula: $R_s = 1/2 dr + F_R \cdot H$ where: dr = nominal rim diameter H = design section height = 1/2 (d - dr) d = rim diameter convention number F_R = factor, as defined by ETRTO (Engineering Design Information 1994, page CV.11)
T_{p_i}	brake force at periphery of all wheels of axle i provided by the spring brake(s)
Th_s	spring thrust of the spring brake
TR	sum of braking forces at periphery of all wheels of the trailer or semi-trailer

SYMBOL	DEFINITION
TR_f	sum of braking forces at periphery of all wheels of the front axle(s)
TR_r	sum of braking forces at periphery of all wheels of the rear axle(s)
TR_{max}	sum of maximum available braking forces at periphery of all wheels of the trailer or semi-trailer
TR_L	sum of braking forces at periphery of all wheels of the trailer or semi-trailer at which the limit of adhesion is reached
TR_{Lf}	sum of braking forces at periphery of all wheels of the front axle(s) at which the limit of adhesion is reached
TR_{Lr}	sum of braking forces at periphery of all wheels of the rear axle(s) at which the limit of adhesion is reached.
TR_{pr}	sum of braking forces at periphery of all wheels of the trailer or semi-trailer required to achieve the prescribed performance
TR_{prf}	sum of braking forces at periphery of all wheels of the front axle(s) required to achieve the prescribed performance
TR_{prr}	sum of braking forces at periphery of all wheels of the rear axle(s) required to achieve the prescribed performance
Z_c	braking rate of the vehicle combination, with the trailer only braked
$\cos P$	cosine of angle subtended by slope of 18 per cent and horizontal plane = 0.98418
$\tan P$	tangent of angle subtended by slop of 18 per cent and horizontal plane = 0.18