



NHTSA's Initial Evaluation of Child Side Impact Protection – Update

Susan Meyerson

March 11, 2008

Takata Side Impact Sled

- Sled pulse – ½ sine with pk~28g
- Reach pk. velocity in 250 mm
- Sled velocity – 20 mph, based on small vehicle FMVSS 214 tests (door accelerometers)
- Honeycomb stiffness
- Door padding stiffness
 - Takata's foam (stiffer)
 - Ethafoam type (softer)
- Lateral (0°) impact angle; option to change impact angle

Takata setup

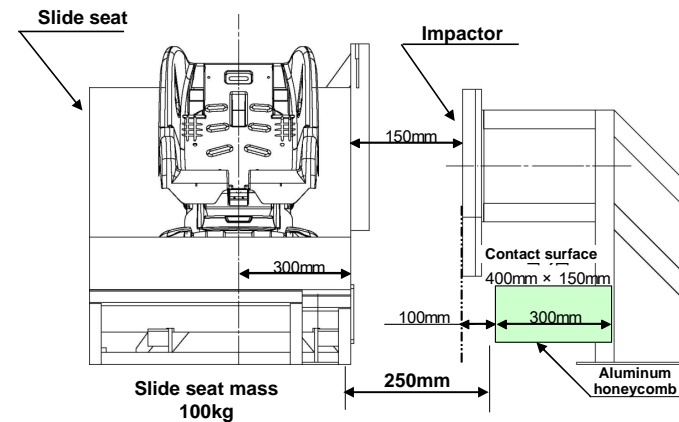

Initial CRS SI Sled Testing

- Previously presented at the May 2008 GRSP meeting
 - Two series of tests with Q3s dummy
 - Sled at two impact angles – 0° and 10°
 - Five different CRS models
- Takata sled exhibited good repeatability
- Able to distinguish between carseat models using injury levels

Sled Tests at Varying Impact Angles

- Test at 0°, 10°, 15° and 20° Impact Angle
 - Rotated Takata sled buck relative to HYGE impactor



Sled Tests at Various Impact Angles

- Selected 3 of previous 5 CRS models tested
 - Graco SafeSeat Step2
 - Evenflo Triumph
 - Maxi-Cosi Priori
 - Did not select Graco Logico M (lack of availability) nor Safety 1st All-in-One CRS (due to head contact at 10° impact angle)
- Selection primarily based on side wing design
 - SafeSeat Step2 and Maxi-Cosi Priori – wings essentially perpendicular to the CRS seatback
 - Evenflo Triumph – wings slightly more angled outward from seat back

CRS Side Wing Designs



Graco SafeSeat Step2



Evenflo Triumph

15° Impact Angle

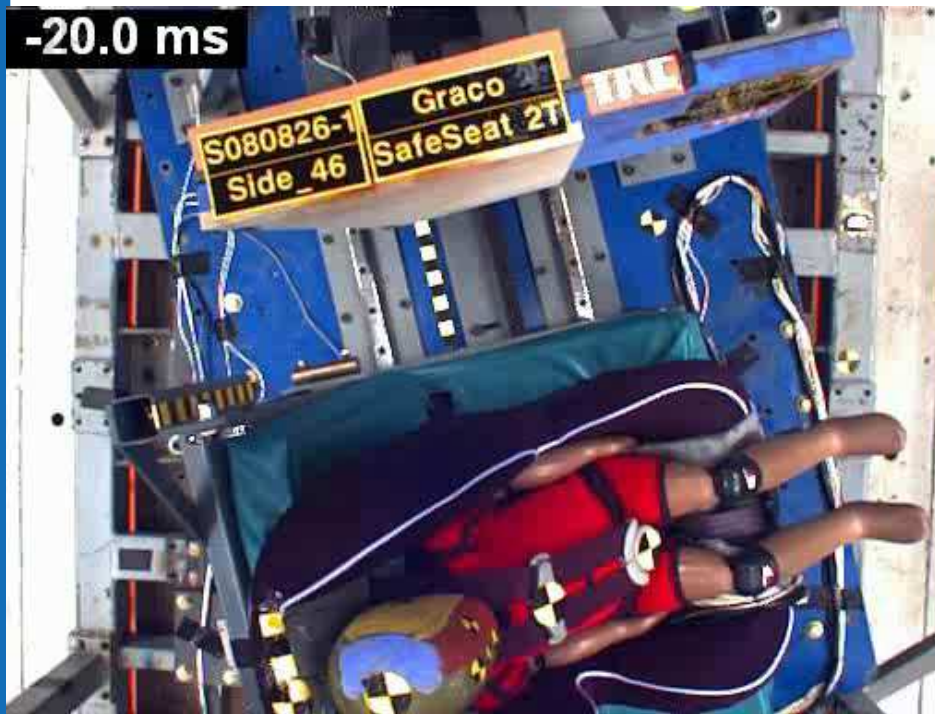

Graco SafeSeat Step2

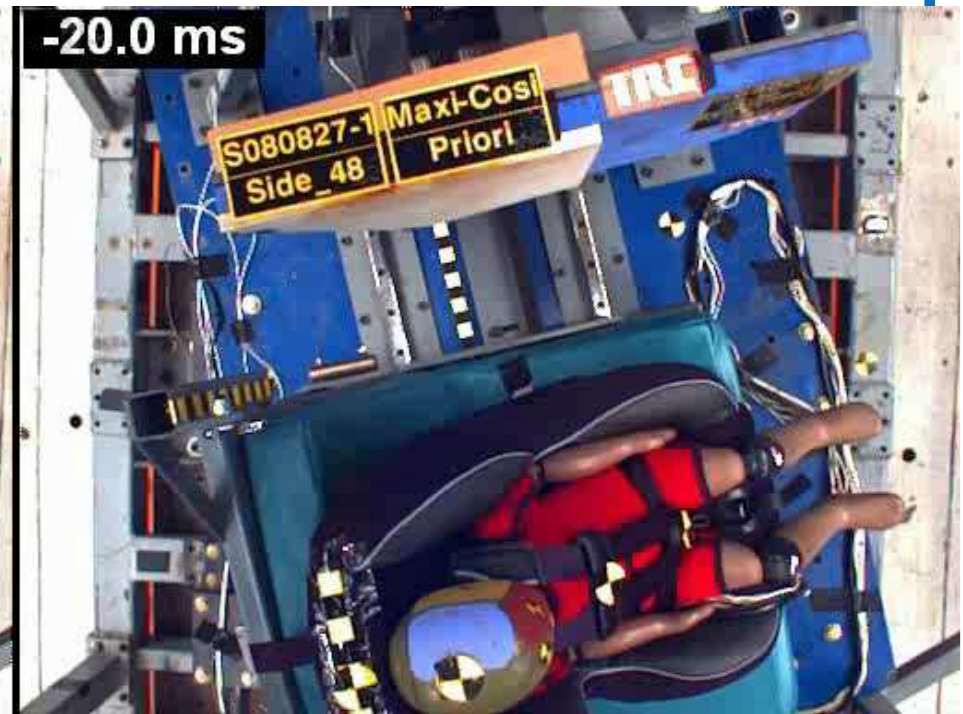

Maxi-Cosi Priori

20° Impact Angle

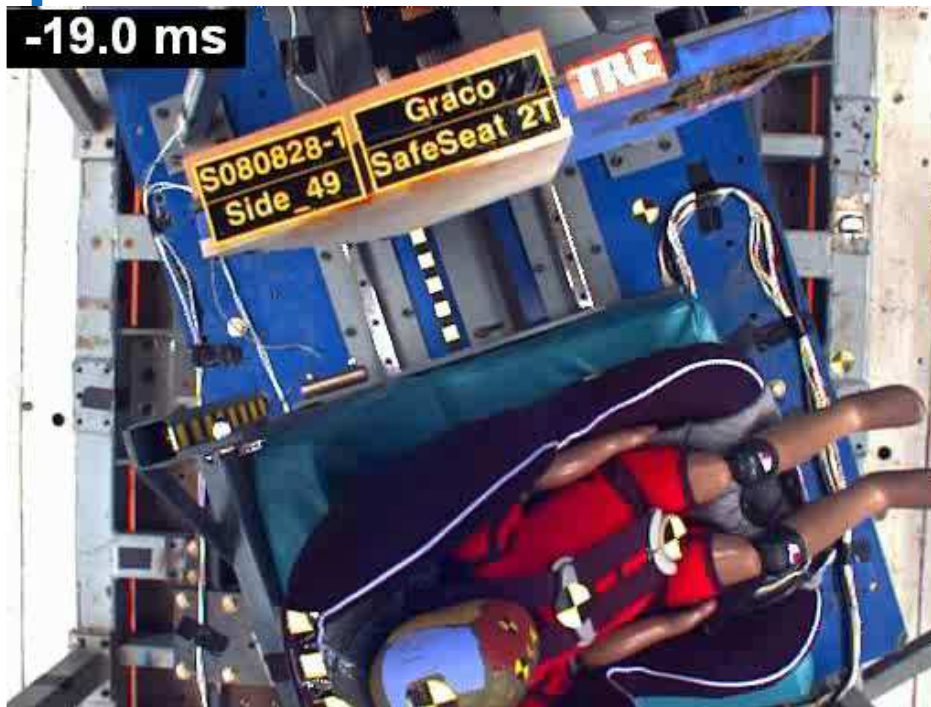

Graco SafeSeat Step2

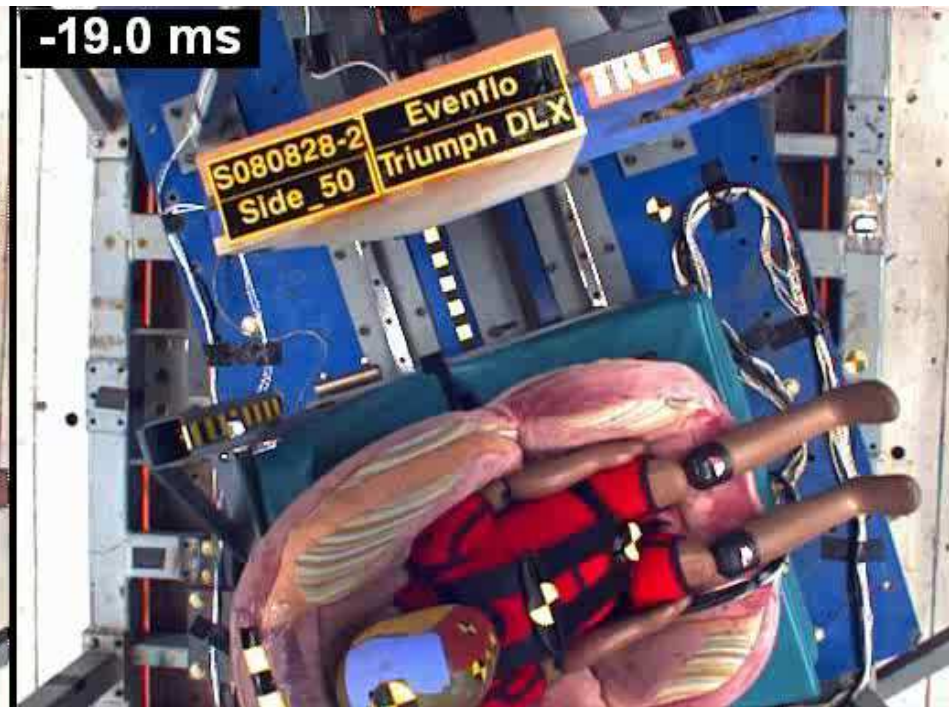

Evenflo Triumph

HIC₁₅ Values for Angled Sled Tests

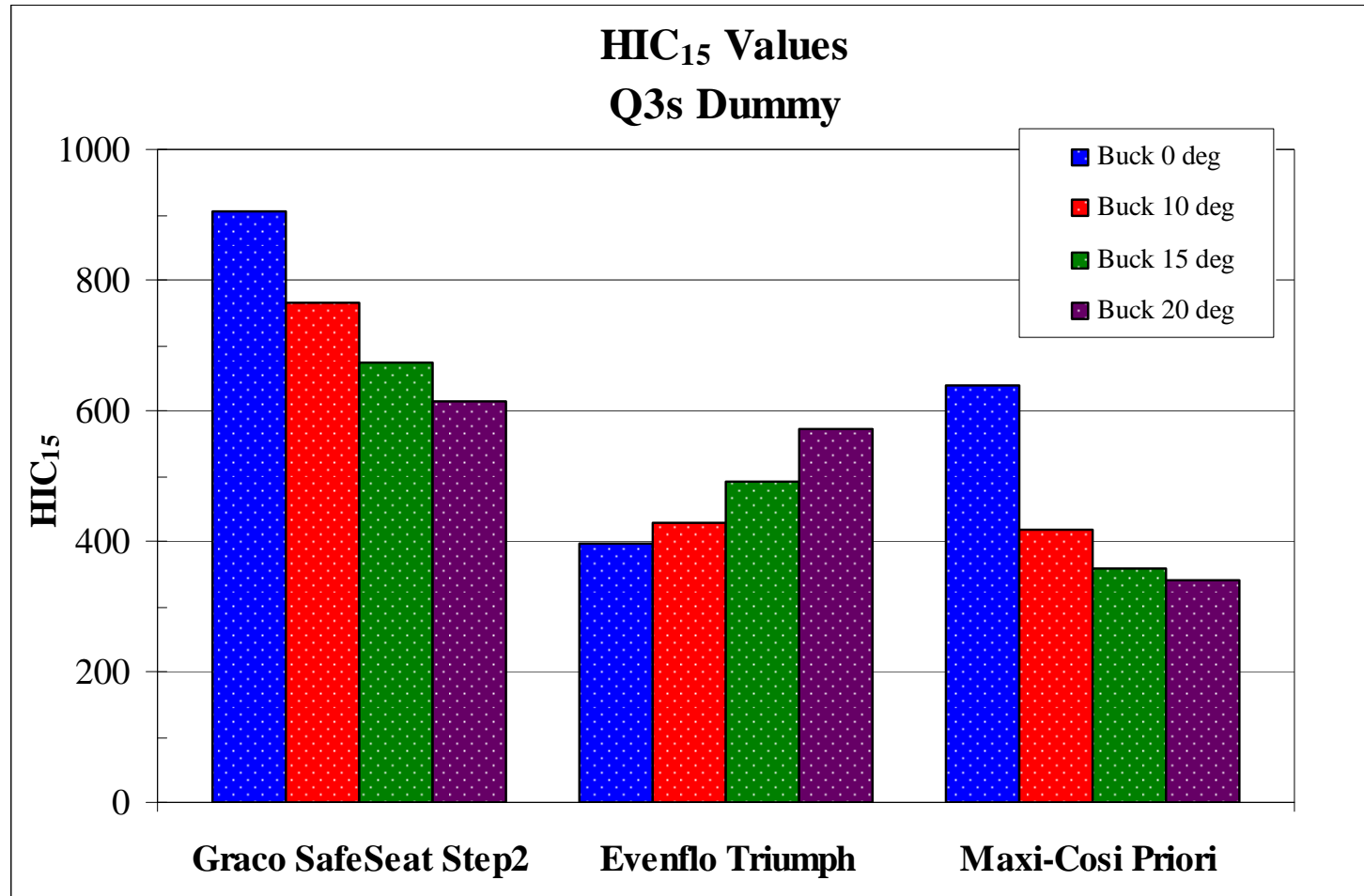

Neck Tension for Angled Sled Tests

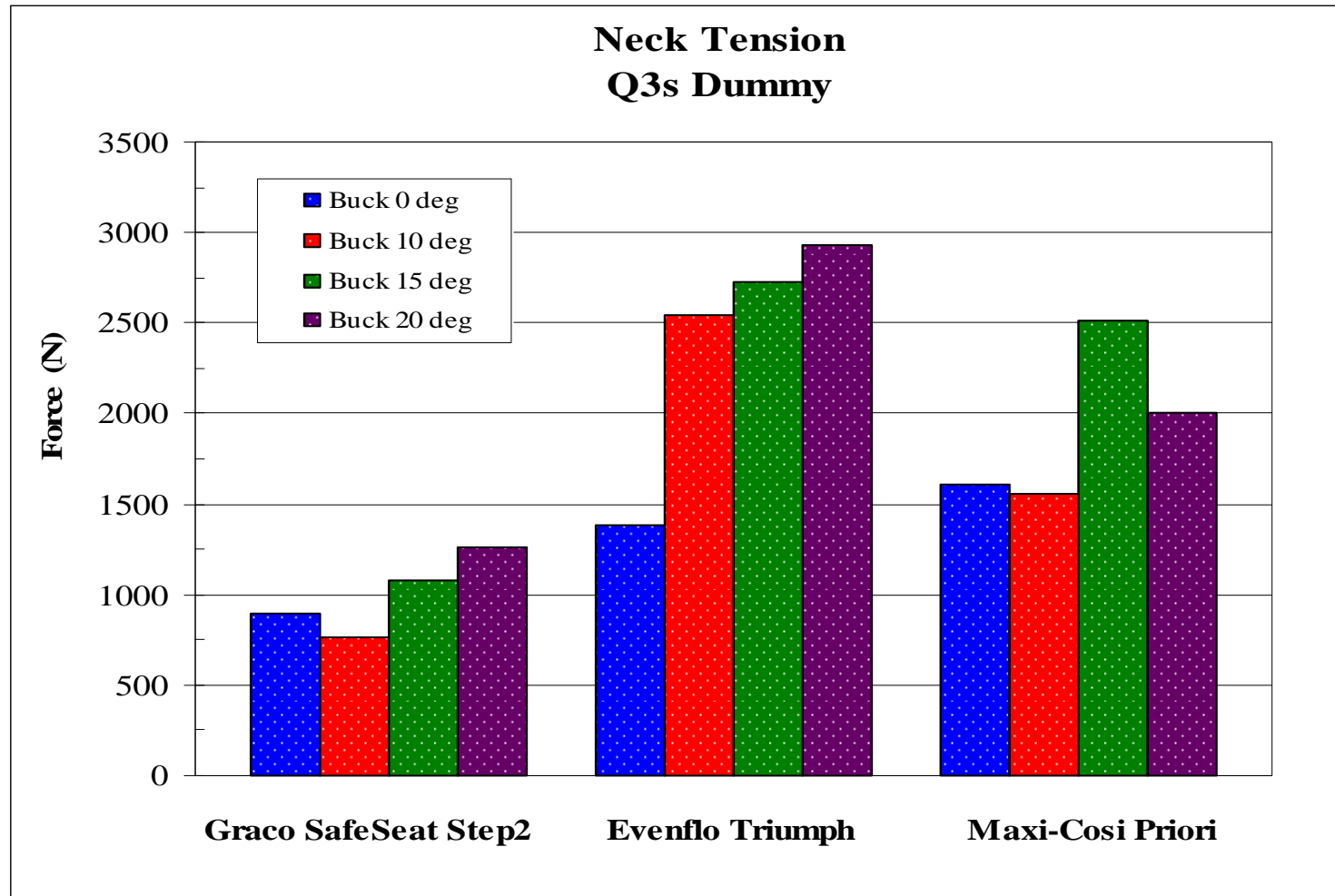

Spine y-axis Acceleration for Angled Sled Tests

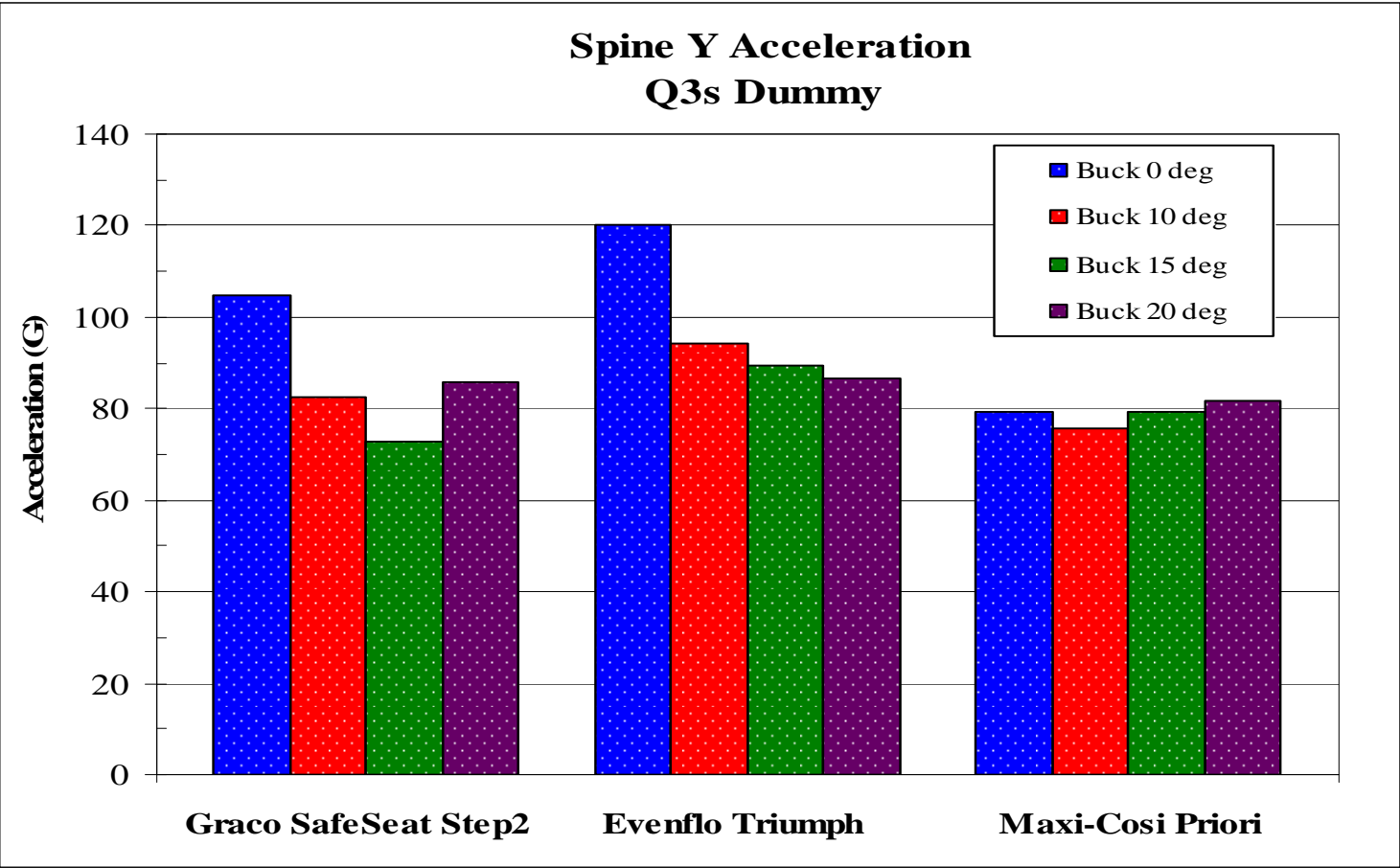

Pelvis y-axis Acceleration for Angled Sled Tests

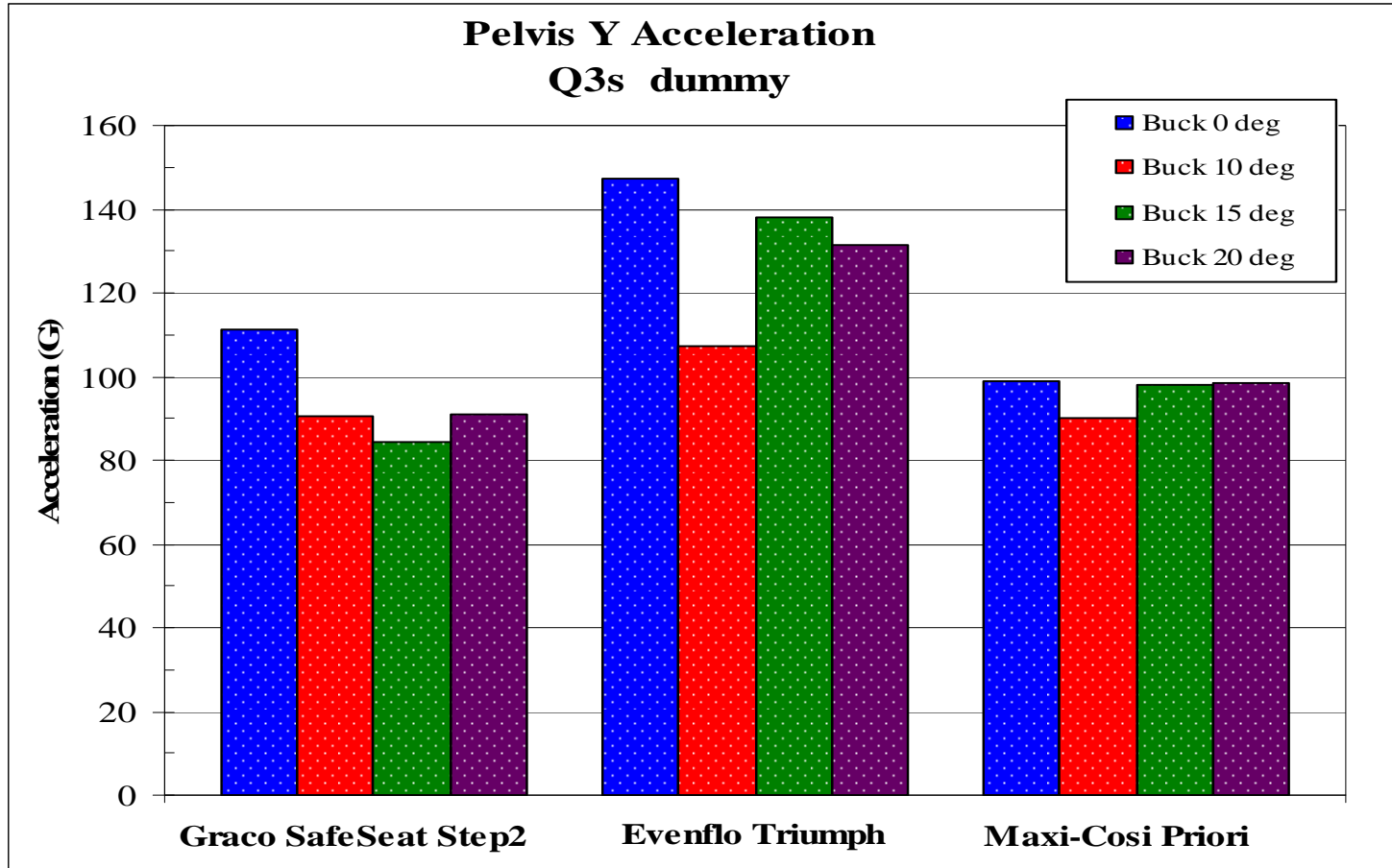

Chest Displacement for Angled Sled Tests

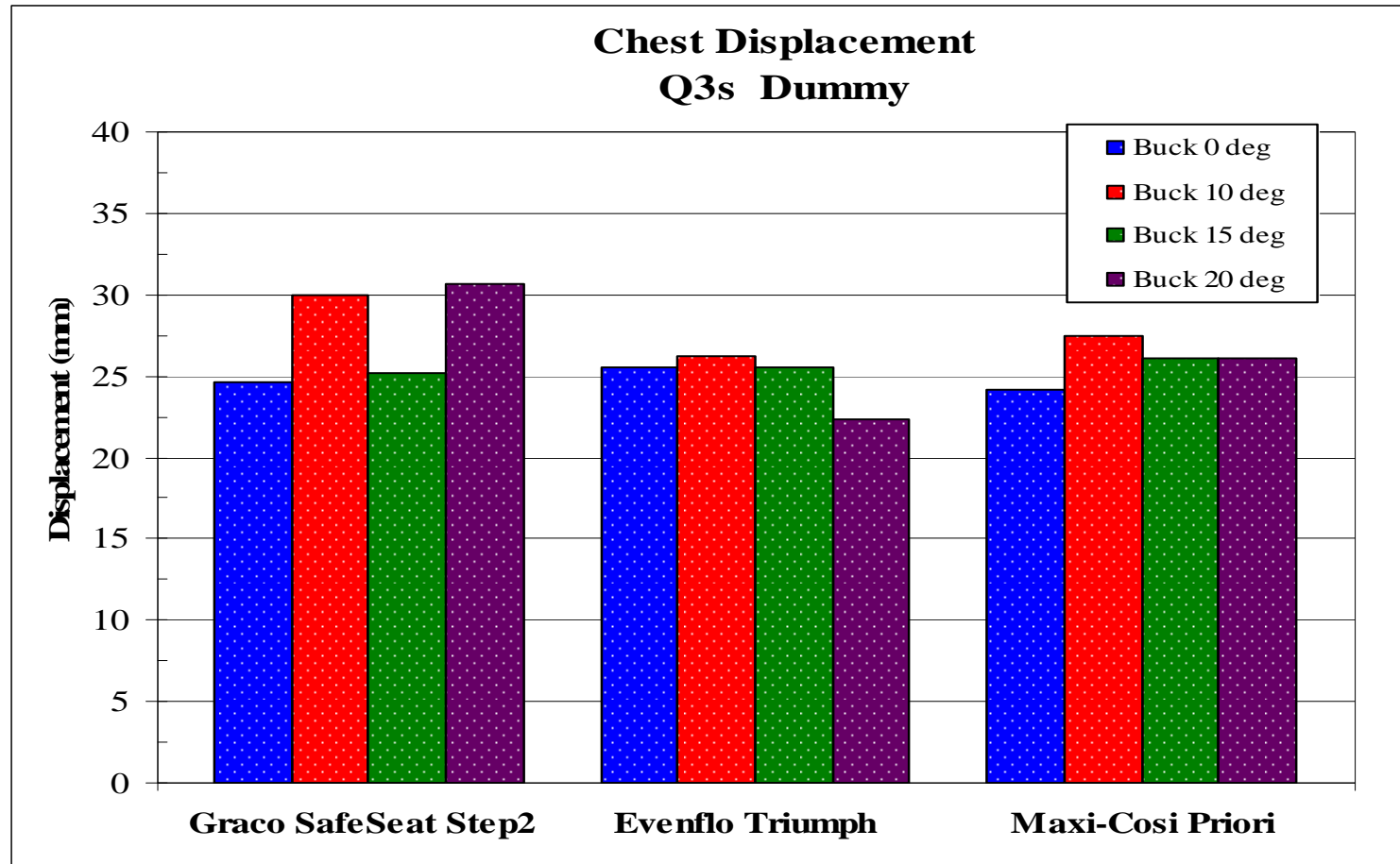

Angled Sled Test Summary

- Upper torso and head increasingly rotated forward in CRS as impact angle increased
- Increased neck tension appeared to be due to
 - increased impact angle
 - CRSs' wing design
- Spine and pelvis y-axis accelerations
 - highest at 0° impact angle for the SafeSeat Step2 and Triumph
 - virtually identical across the impact angle range for Maxi-Cosi Priori
- Impact angle appeared to have minimal effect on lateral chest displacement for the 3 CRS models

CRS SI Crash Test Objectives

- Conduct CRS near-side full-scale FMVSS No. 214 side impacts to obtain more accurate info:
 - Amount of door intrusion
 - Door velocity at time of CRS/dummy contact
 - Amount of vehicle rotation at CRS/dummy location
 - Dummy responses to evaluate sled test severity and parameters
- Determine similarities between crash tests and sled tests

CRS SI Crash Tests

- '08 Nissan Sentra & '08 Nissan Versa
 - One Sentra test
 - FMVSS No. 214D test conditions
 - One Sentra and two Versa tests
 - impact point 228.6 mm (9 inches) rearward of that specified in FMVSS No. 214D in effort to more directly load door at occupant location
- Graco SafeSeat Step2 and Maxi-Cosi Priori seats
- Q3s (near-side) and Hybrid III 3Cs (far-side)

Crash Tests Compared to Sled Tests

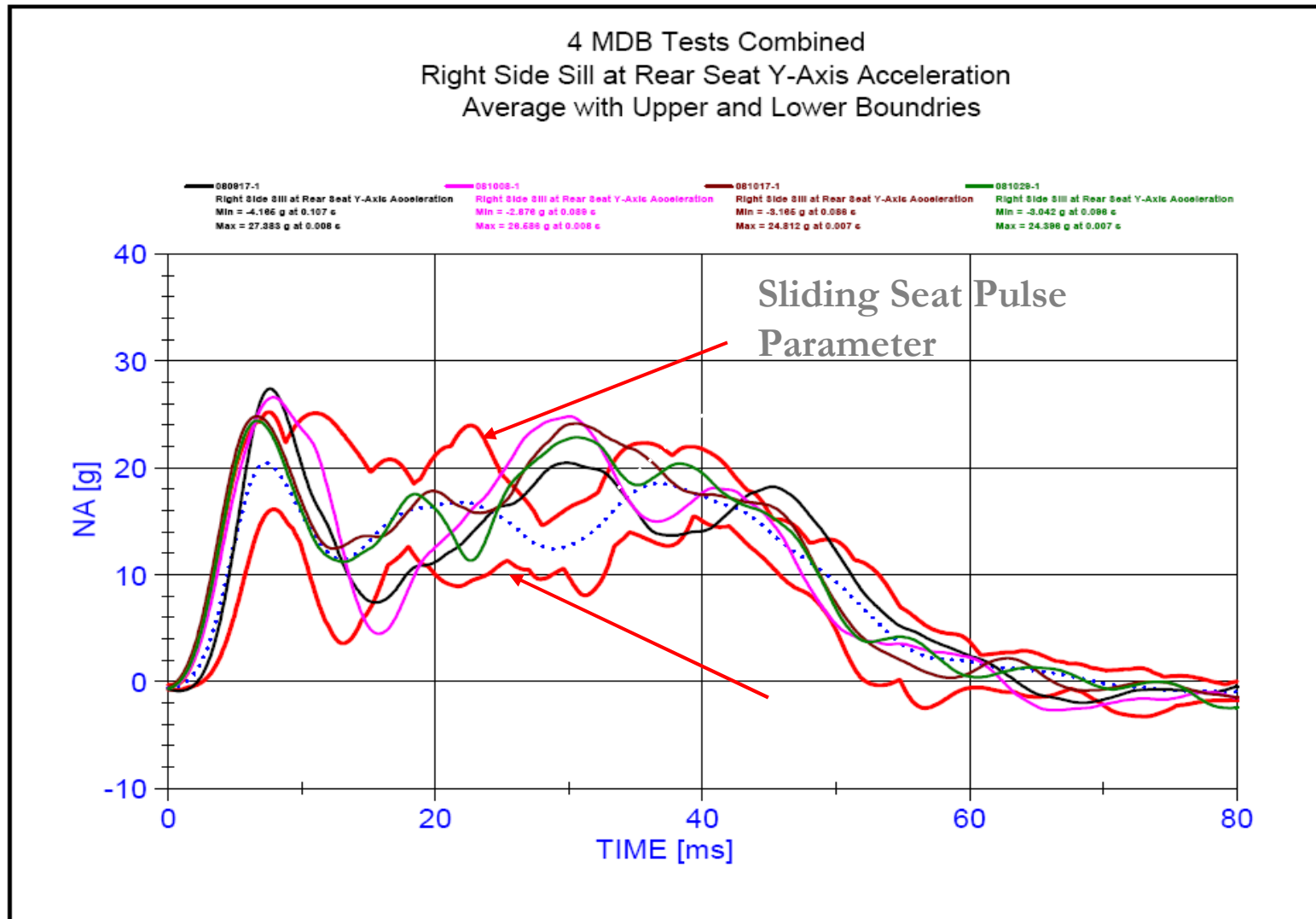

4 MDB Tests Combined Right Side Sill at Rear Seat Y-Axis Velocity Average with Upper and Lower Boundaries

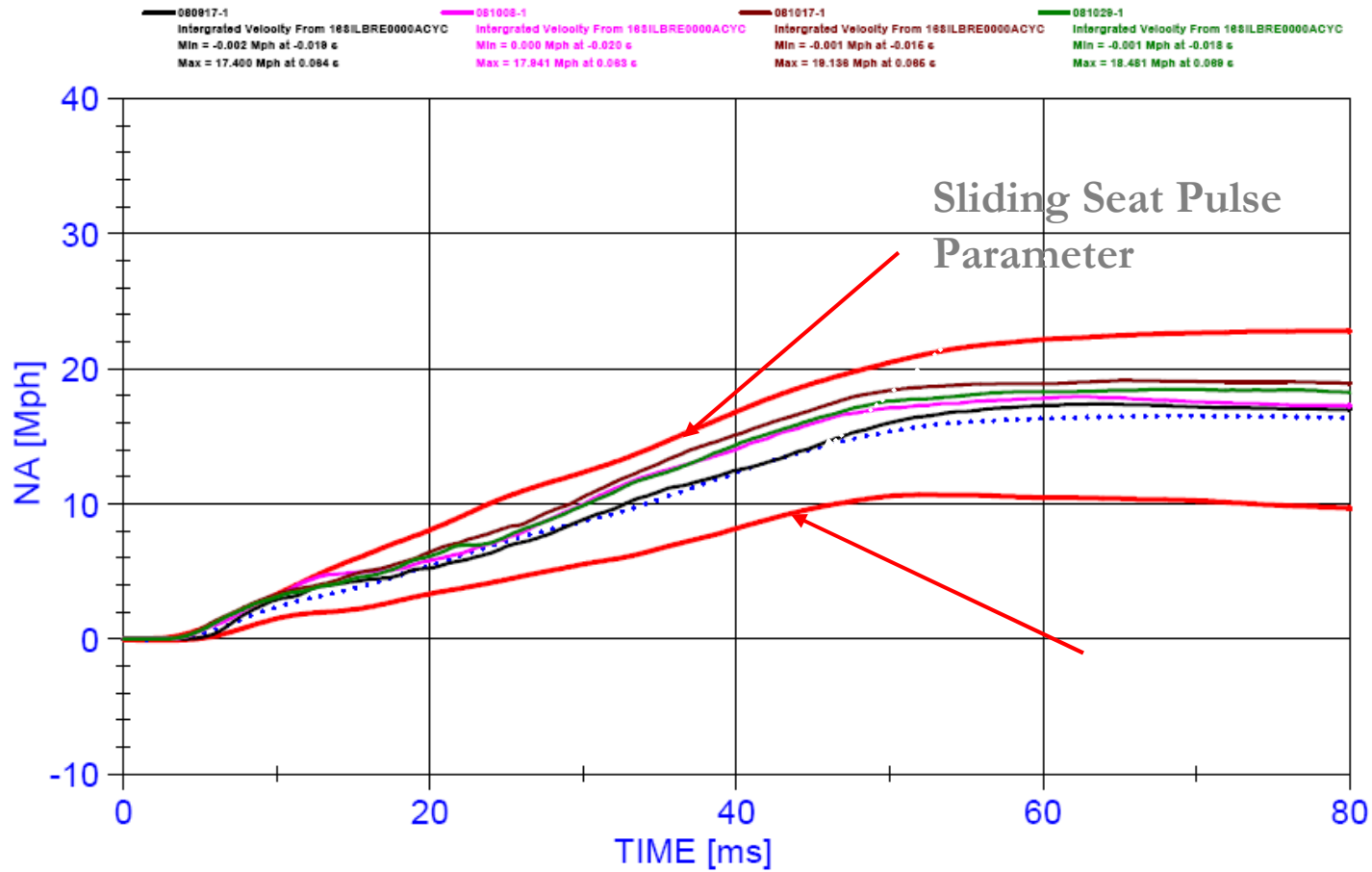

CRS Locations Relative to Door Panel / Armrest



Sentra Struck Side Door Panel

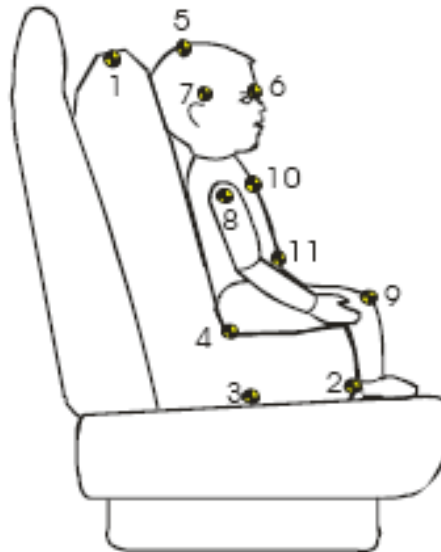

Versa Struck Side Door Panel

Summary

- Sled and crashed vehicle responses comparable
- Dummy and CRS kinematics in crash tests similar to those in sled tests
 - Armrest issue needs further investigation
- Some dummy responses similar, while others differed, between sled and crash tests
- Additional evaluation of results required to refine side impact sled test parameters



For additional inquiries, contact

Susan Meyerson

susan.meyerson@dot.gov

(202) 366 - 9291

Lisa K. Sullivan

lisa.sullivan@dot.gov

(937) 666-4511



Thank You

