

REGULATION No. 46 (Devices for indirect vision)

**Report of the informal group on camera monitor systems.**

**Introduction**

1. GRSG decided in its 95<sup>th</sup> meeting in October 2008 to set up an informal group on camera monitor systems (IGCMS) with a mandate of one year. The tasks for this informal group were dual:
  - the first task was to objectify the criteria and set-up for the test of the influence of low sunlight hitting the lens of the camera and the determination of the maximum detection distance in ECE-regulation 46 and
  - the second task was to amend the regulation so that all mirrors can be replaced by camera-monitor systems (CMS).
2. The informal group had its first meeting on 24 February 2009 where the group decided to have a subgroup (metrology group) dealing with ergonomical and ophthalmological aspects. The IGCMS and the metrology group met 5 times each.
3. The following organizations were represented:
  - two ministries of Contracting parties,
  - three technical services
  - several German vehicle manufactures
  - one representative of the Japanese manufactures and
  - several manufactures of CMS.
4. The metrology group dealt mainly with the first task of IGCMS and the inventory of necessary topics for which ISO should to develop a new ISO standard for the purpose of the second task.
5. The last meeting was held on 22 February 2010 for the metrology group and 23 February 2010 for the IGCMS. Outstanding points would be discussed bilateral between the two most involved technical services and by exchange of e-mail.

**First task**

6. The metrology discussed on the basis of document ECE/TRANS/WP.29/GRSG/2008/3 from the Netherlands the procedure for the testing of CMS of class V and VI concerning the influence of low sunlight hitting the lens of a camera (blooming test) and the determination of the maximum detection distance. For other classes of devices the secondary the provisions will be part of the secondary task.

For the blooming test the informal group agreed on many points like the test setup including the light source, the size of the light source, the maximum dimension of the blooming area, the test pattern and the illumination of the test pattern.

No agreement could yet be reached for the emission of infrared light by the light source

For the determination of the maximum detection distance the group could agree to:

- the size of the critical object that will be a cylinder with a height of 500 mm and a diameter of 300 mm and
- the principle that the system has sufficient resolution and that the displayed size is sufficiently large.

In addition, there is still a difference in view between the technical experts of two technical services on the procedure how the resolution has to be defined. One procedure is based on the principle that the visibility of the critical object is determined by its size, the displayed contrast and other factors such as blur, noise (static, dynamic). The TOD procedure, which was specially developed for that purpose, is prescribed in the Annex 1 to this report. The other procedure is based on verification whether the critical

object can be seen in the required field of vision by means of a visual inspection; the prescription of that test procedure might become available at the end of June 2010.

The group is of the opinion that the amendments should be seen as a new 03 series of amendments; therefore it has drafted transitional provisions that continue the use of mirrors that are not touched by the new provisions and that are approved according previous series of amendments.

The results of IGCMS on its first task are given in Annex 1 to this report.

### **Second task**

7. The main group of IGCMS focused on the basis of document ECE/TRANS/WP.29/GRSG/2008/25 from Germany on the second task and prepared editorial amendments of Regulation 46 in order to make the application of CMS for all classes of devices for indirect vision possible.

Starting points for the replacement of mirrors by CMS were that:

- the provisions for CMS should not be more stringent than for mirrors
- to prevent design restrictive provisions the responsibilities of the (vehicle) manufactures have been taken into account
- where necessary, provisions should be harmonized worldwide by establishing an ISO-standard and
- there is no justification to strengthen the present provisions for CMS of class V and VI.

The informal group amended the provisions such that they apply in general to devices for indirect vision without referring to mirrors, where applicable, and rearranged the definitions in a more logical sequence and deleted definitions that were not used (anymore).

Furthermore the group agreed on the following more fundamental amendments:

- the critical object for class V and VI will remain a cylindrical object of 500 mm high and a diameter of 300 mm, while ISO will define the dimensions needed for other classes of devices for indirect vision,
- an exemption for original CMS from having a type approval number on it's parts and the introduction of alternative markings of the systems,
- a reduction of the number of parts to be offered to the technical service,
- a new wording for the different classes of devices for indirect vision as the position interior or exterior are, in case of a CMS nor relevant,
- with regard to the radius of curvature of parts of devices for indirect vision these minimum value of 2.5 mm will not apply to exterior parts that are more than 2 meter above the ground, while approvals according regulation 21 and 26 can be accepted as alternatives,
- CMS will have to meet the provisions of a new ISO standard giving the requirements for camera-monitor systems for other classes than V and VI; as long as those provisions have not been approved by WP.29 the proposed amendments of the regulation can only be used for devices of class V and VI,
- the number of monitors will not exceed the number of corresponding mirrors, while the number of CMS may be less than the required mirrors, provided that the required field of vision is rendered,
- multiple images are permitted while the use of the monitor for other purposes can under certain conditions also be accepted and
- the position of the monitor shall be on an ergonomically favorable position.

The group has the opinion that the amendments should be seen as a new 04 series of amendments; therefore it has drafted transitional provisions that permit the continued use of mirrors and CMS of class V and VI that are not affected by the new provisions and that are approved according previous series of amendments.

The results of IGCMS on its second task are given in Annex 2 to this report.

Furthermore IGCMS might consider amendments to the scope of regulations 21 and 26 for editorial

amendments by replacing “mirrors” by “camera-monitor systems”.

8. Request to GRSG is to extend the mandate of IGCMS to be able to get an agreement on the few outstanding points by means of exchange of e-mails and to deliver two formal documents for regulation 46 and possibly two documents for the scope of regulation 21 and 26 for discussion in the 99<sup>th</sup> session of GRSG.

29 April 2010,

Chairman of IGCMS.

Annex 1

State of the art with regard to the testing of Camera-monitor systems

The modifications to the current text of the Regulation are marked in **bold** or ~~strikethrough~~ characters

A. PROPOSALS

1. Paragraph 2.1.2.6., amend to read:

"2.1.2.6 "Critical object" means a ~~circular~~ **cylindrical** object with a **height of 0.50 m** and a diameter of  ~~$D_0 = 0.8 \text{ m}^2$~~  **0.30 m.**"

2. Footnote 2/ to paragraph 2.1.2.6., should be deleted.

3. Paragraph 2.1.2.7., amend to read:

"2.1.2.7. "Critical perception" means the level of perception that **can just be obtained under critical conditions via the viewing system that is used. This corresponds to the situation in which the representative scale of the critical object is a multiple times larger than the smallest detail that can be perceived via the viewing system** ~~the human eye is generally capable of achieving under various conditions. For traffic conditions the limiting value for a critical perception is eight arc minutes of visual angle.~~"

4. Paragraph 2.1.2.9., amend to read:

"2.1.2.9. "Detection distance" means the distance measured ~~at ground level~~ **from the centre of the lens of the camera** ~~viewing reference point~~ to the extreme point at which a critical object can just be perceived (**as defined by the critical perception** ~~the limiting value for a critical perception just barely achieved~~).

5. "Paragraph 2.1.2.10., amend to read:

"2.1.2.10. **(reserved)** ~~"Critical field of vision"~~ means the area in which a critical object has to be detected by means of a device for indirect vision and that is defined by an angle and one or more detection distances."

---

<sup>2/</sup> ~~— A system for indirect vision is intended to detect relevant road users. The relevancy of a road user is defined by his or her position and (potential) speed. More or less in proportion with the speed of the pedestrian cyclist moped driver, the dimensions of these road users increase as well. For detection purposes a moped driver ( $D = 0.8 \text{ m}$ ) at 40 m distance would be equal to a pedestrian ( $D = 0.5 \text{ m}$ ) at a distance of 25 m. Considering the speeds, the moped driver would be selected as the criterion for the detection size; for that reason an object with a size of 0.8 m shall be used for determining the detection performance.~~

6. Paragraph 2.1.2.11., amend to read:

"2.1.2.11. (reserved) ~~Viewing reference point~~ " means ~~the point linked to the vehicle to which the prescribed field of vision is related. This point is the projection on the ground of the intersection of a vertical plane passing through the driver's ocular points with a plane parallel to the median longitudinal plane of the vehicle situated 20 cm outside the vehicle.~~"

7. Paragraph 6.2.2.2.1., amend to read:

**6.2.2.2.1. The camera shall function well in conditions in which sunlight falls on the camera. The saturated area, defined as the area in which the luminance contrast ratio ( $C=L_w/L_b$ ) of a high contrast pattern falls below 2.0, shall not cover more than 15 % of the displayed image under the conditions of paragraph 6.2.2.2.1.1 to 6.2.2.2.1.4.**

**In case the camera system shows dynamical changes in the blooming area during the test the maximum blooming area should fulfill the requirement."**

**6.2.2.2.1.1. A black and white test pattern, having a minimum contrast ratio of 20 shall be positioned in front of the camera.  
The test pattern shall be evenly illuminated at an illumination of  $3000 \pm 300$  Lx.**

**The test pattern shall be medium gray on average and cover the complete area viewed by the camera: the camera shall view no other objects than the test pattern.**

**6.2.2.2.1.2. The camera shall be hit by a (simulated sun) light of 40 kLx, spanning an angle between 0.6 and 0.9 degrees with an elevation angle of 10 degrees (directly or indirectly via a mirror) removed from the optical axis of the sensor.**

**The light source shall:**

- have a spectrum D65 with a tolerance of  $\pm 1500$ K,
  - be homogene in space and time within a tolerance of 2 kLx
- [The emission of the light source in the infrared shall be negligible.]**

**6.2.2.2.1.3. There shall be no ambient illumination of the monitor during the test.**

**6.2.2.2.1.4. An example of the set-up is given in the figure A below.**

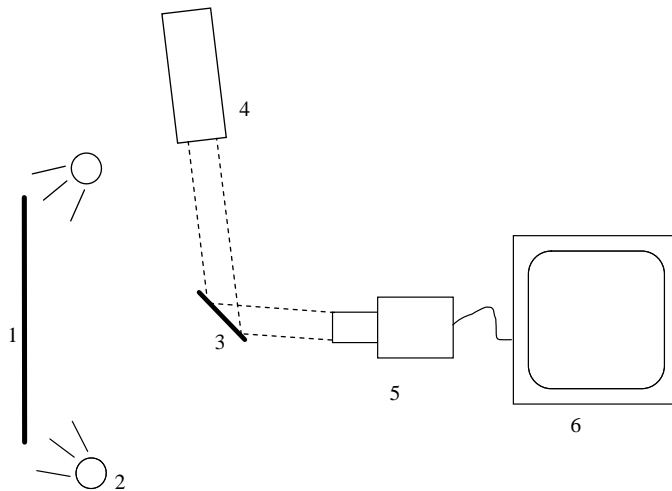

**Figure A** Diagram of the blooming measurement set-up. 1: Black & white test pattern. 2: Lamps to make the test pattern evenly illuminated. 3: Mirror. 4: High intensity light. 5: Camera. 6: Monitor.

8. Paragraph 6.2.2.2.4., amend to read:

"6.2.2.2.4. The measurements for the luminance contrast **of the monitor** shall be carried out according to ISO 15008:2009."

9. Paragraph 15.3.1., amend to read:

"15.3.1. A device for indirect vision shall give such performances that a critical object can be observed [by the driver] ~~within~~ **all over the required** ~~described~~ field of vision, taking into account the critical perception **according the procedure of Annex 10.**"

10. Paragraph 15.3.3., amend to read:

"15.3.3. **(reserved)**  
~~For the determination of the detection distance in case of camera monitor devices for indirect vision, the procedure of Annex 10 shall be applied.~~"

11. Paragraph 21 shall be replaced by the following paragraph 21

21. TRANSITIONAL PROVISIONS
- 21.1. As from the official date of entry into force of the 03 series of amendments to this Regulation, no Contracting Party applying this Regulation shall refuse an application for approval under this Regulation as amended by the 03 series of amendments.
- 21.2. As from [12 months after entry into force of the 03 series of amendments to this regulation], Contracting Parties applying this Regulation shall grant approvals to a type of

- devices for indirect vision only if the type meets the requirements of this Regulation as amended by the 03 series of amendments.
- 21.3. As from [18 months after entry into force of the 03 series of amendments to this regulation], Contracting Parties applying this Regulation shall grant approvals to a type of vehicle with regard to the installation of devices for indirect vision only if the type of vehicle meets the requirements of this Regulation as amended by the 03 series of amendments.
- 21.4. As from [24 months after entry into force of the 03 series of amendments to this regulation], Contracting Parties applying this Regulation may refuse to recognize approvals of a type of vehicle or type of device for indirect vision which have not been granted in accordance with the 03 series of amendments to this Regulation.
- 21.5. As from 26 January 2010 for vehicles of category M1 and N1 and from 26 January 2007 for vehicles of other categories, Contracting Parties applying this Regulation may refuse to recognize approvals of a device for indirect vision which have not been granted in accordance with the 02 series of amendments to this Regulation.
- 21.6. Approvals which were granted to devices for indirect vision of Classes I or III pursuant to this Regulation in its original form (00 series) or modified by the 01 or 02 series of amendments before the date of entry into force of this series of amendments shall remain valid.
- 21.7. Approvals which were granted to devices for indirect vision of Classes II, IV, V, VI or VII pursuant to this Regulation as modified by the 02 series of amendments before the date of entry into force of this series of amendments shall remain valid.
- 21.8. The provisions of this Regulation shall not prohibit the approval of a type of vehicle with regard to the mounting of devices for indirect vision pursuant to this Regulation as modified by the 03 series of amendments, if all or part of the devices for indirect vision of Classes I or III, with which it is fitted, bear the approval mark prescribed by this Regulation in its original form (00 series) or modified by the 01 or 02 series of amendments .
- 21.9. The provisions of this Regulation shall not prohibit the approval of a type of vehicle with regard to the mounting of devices for indirect vision pursuant to this Regulation as modified by the 03 series of amendments, if all or part of the rear-view mirrors of Classes II, IV, V, VI or VII, with which it is fitted, bear the approval mark prescribed by the 02 series of amendments of this Regulation.
- 21.10. Notwithstanding the provisions of paragraphs 21.2. and 21.4. and 21.5. above, for the purpose of replacement parts Contracting Parties applying this Regulation shall continue to grant approvals according to the 01 series of amendments to this Regulation, to devices for indirect vision of classes I to V and VII for use on vehicle types which have been approved before 26 January 2006 pursuant to the 01 series of amendments of Regulation No. 46 and to devices for indirect vision of class VI for use on vehicles which have been approved before 26 January 2007 pursuant to the 01 series of amendments of Regulation No. 46, and, where applicable, subsequent extensions to these approvals.
- 21.11. Notwithstanding the provisions of paragraphs 21.2. and 21.4. and 21.5. above, for the purpose of replacement parts Contracting Parties applying this Regulation shall continue to grant approvals according 02 series of amendments to this Regulation, to devices for indirect vision for use on vehicle types which have been approved before the date mentioned in paragraph 21.2 pursuant to the 02 series of amendments of Regulation No. 46, and, where applicable, subsequent extensions to these approvals.

12. Annex 10, paragraphs 1.to 1.2., amend to read:

"1.CAMERA MONITOR DEVICE FOR INDIRECT VISION

- [1.1. ~~Resolution threshold of a camera~~

The resolution threshold of a camera is defined by the formula:

$$\omega_c = 60 \frac{\beta_c}{2N_c}$$

where:

$\omega_c$  — resolution threshold of the camera (arc min)

$\beta_c$  — angle of vision of the camera ( $^\circ$ )

$N_c$  — number of video lines of the camera (#)

The manufacturer shall supply the values for  $\beta_c$  and  $N_c$

#### Determination of the smallest discernable detail.

The smallest discernable detail of the naked eye is shall be defined according to standard ophthalmologic tests like the Landolt C test or the TOD test. The smallest discernable detail at the centre of the viewing system can be determined using the Landolt C test or the TOD test. In the rest of the viewing area the smallest discernable detail may be estimated from the centrally determined smallest discernable detail and the local image deformation. For instance, in the case of a digital camera the smallest discernable detail at a given pixel location (in the monitor) scales inversely with the solid angle of the pixel.

##### 1.1.1. Landolt-C test

In the Landolt-C test test symbols are judged by the subject under test. In accordance with this test the smallest discernable detail is defined as the visual angle of the gap size of the Landolt C symbol at threshold size and is expressed in arcmin. The threshold size corresponds to the size at which the subject judges the orientation correctly in 75% of the trials. The smallest discernable detail is determined in a test involving a human observer. A test chart containing test symbols is placed in front of the camera and the observer judges the orientation of test symbols from the monitor. From the threshold gap size of the Landolt C test symbol  $d$  (in m) and the distance between the test pattern and the camera  $D$  (in m) the smallest discernable detail  $\omega_c$  (in arcmin) is calculated as follows:

$$\omega_c = \frac{d}{D} \cdot \frac{180 \cdot 60}{\pi} \quad [\text{arcmin}]$$

##### 1.1.2. TOD test

The TNO Landolt C test can be used to determine the smallest discernable detail of the camera-monitor system. However, for sensor systems it is more suitable to use the TOD (Triangle Orientation Discrimination) method which is similar to the Landolt C method, but involves equilateral triangular test patterns. The Triangle Orientation Discrimination method is described in detail by Bijl & Valetton (1999), who provide practical guidelines on how to perform a TOD measurement. In the method, triangular test patterns (see Figure 1) are viewed through the viewing system under test. Each triangle can have one out of four possible orientations (apex up, left, right or down) and the observer indicates/guesses for each triangle its orientation. When this procedure is repeated for many (randomly oriented) triangles of different sizes the fraction of correct responses can be plotted (see Figure 2), and increases with test pattern size. The threshold is defined as the point at which the fraction correct crosses the 0.75 level and can be obtained by fitting a smooth function through the data (see Bijl & Valetton, 1999). Critical perception is reached when the critical object diameter



equals two times the width of the triangle at threshold size. The smallest discernable detail ( $\omega_c$ ) is equal to 0.25 times the width of the triangle at threshold size. This means that, from the threshold triangle width  $w$  (in m) and the distance between test pattern and the camera  $D$  (in m) the smallest discernable detail  $\omega_c$  (in arcmin) is calculated as follows:

$$\omega_c = \frac{w}{4 \cdot D} \cdot \frac{180 \cdot 60}{\pi} \quad [\text{ arcmin}]$$

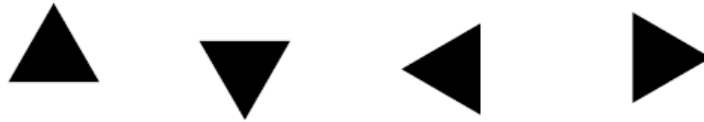

Figure 1 Triangular test patterns used in the Triangle Orientation Discrimination (TOD) method

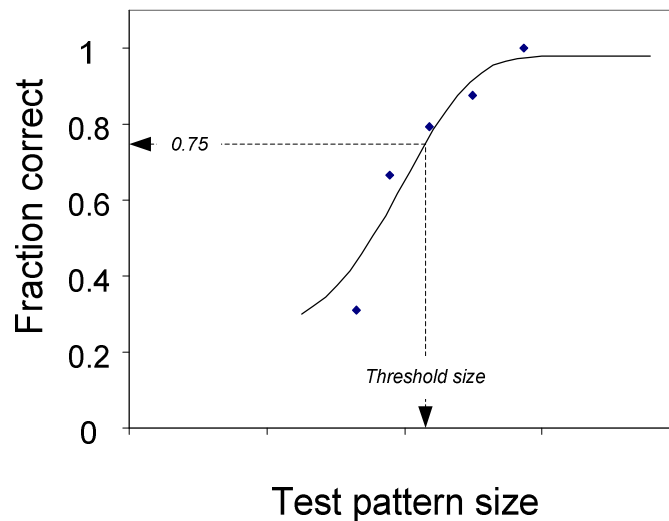

Figure 2 Typical relationship between the size of the triangle and the fraction of correct responses.

1.2. Determination of the critical viewing distance of the monitor

For a monitor having certain dimensions and properties, a distance to the monitor can be calculated within which the detection distance is dependent only on the performances of the camera. This critical viewing distance  $r_{m,c}$  is defined by:

$$r_{m,c} = \frac{H_m}{N_m \cdot 2 \cdot \tan\left(\frac{\omega_{eye}}{2 \cdot 60}\right)}$$

where:

$r_{m,c}$  — critical viewing distance (m)

$H_m$  — height of the monitor image (m)

$N_m$  — number of video lines of the monitor (-)

$\omega_{eye}$  — resolution threshold of the observer (minutes of arch)

The number 60 is for conversion from minutes of arches to degrees.

The manufacturer shall supply the values for  $H_m$  and  $N_m$ .

$\omega_{eye} = 1$

For a monitor having certain dimensions and properties, a distance to the monitor can be calculated within which the detection distance is dependent only on the performances of the camera. The critical viewing distance  $r_{mcrit}$  is defined as the distance at which the smallest discernable detail displayed on the monitor spans 1 arcmin measured from the eye (the acuity threshold of a standard observer).

$$r_{mcrit} = \frac{\delta \cdot 60 \cdot 180}{\pi} \quad [m]$$

where:

$r_{mcrit}$  - critical viewing distance of the monitor (m)

$\delta$  - size of the smallest discernable detail on the monitor (in m)"

13. Annex 10, paragraphs 1.3.1. and 1.3.2. shall be replaced by:

**1.3.1. Maximum detection distance within the critical viewing distance where, due to the installation, the distance eye-monitor is less than the critical viewing distance, the maximum attainable detection distance is defined as:**

$$r_{dclose} = \frac{D_0 \cdot 60 \cdot 180}{\omega_c \cdot \pi \cdot f} \quad [m]$$

where:

$r_{dclose}$  - detection distance [m]

$D_0$  - diameter of the critical object [m] according to paragraph 2.1.2.6;  
for the calculation of  $r_{dclose}$  for class V and VI devices a representative value of 0,30 m shall be used

$f$  - threshold increasing factor, which is equal to 8.

$\omega_c$  - smallest discernable detail [arcmin] (see paragraph 1.1.)

**1.3.2. Detection distance greater than the critical viewing distance. Where, due to the installation, the distance eye-monitor is more than the critical viewing distance, the maximum obtainable detection distance is defined as:**

$$r_{dfar} = \frac{r_{mcrit}}{r_m} \cdot r_{dclose} \quad [m]$$

where:

$r_{dfar}$  - detection distance for distances larger than the critical viewing distance [m]

$r_{dclose}$  detection distance for distances smaller than the critical viewing

**distance [m]**

**$r_m$**  - viewing distance, i.e. distance between eye and monitor [m]  
 **$r_{\text{merit}}$**  - critical viewing distance [m], see paragraph 1.2." ]

## B. JUSTIFICATION

The requirements for the approval of camera-monitor systems and the installation on vehicles as given in Regulation 46/02 seem to be unclear, like the provisions for low sunlight conditions and the visibility of critical object. The tests need objectivity in order to reduce different interpretations and to improve reproducibility.

2.1.2.6. The dimensions for the critical object for Camera-Monitor systems for the class V and VI field of vision are aligned with the pole of paragraph 15.2.4.6.1.

Furthermore footnote 2/ can be deleted as this contains only an explanation of the size of 0,8m for the previous critical object (which might be suitable for classes I.- IV but not for classes V and VI for which camera-monitor systems are allowed).

2.1.2.7. Adjustment of the definition of "critical perception" in order to incorporate a test method based on the Landolt-C or TOD principles.

2.1.2.9. The detection distance will be based on a measurement of the smallest discernable detail using Landolt-C or TOD procedures and will be expressed as a distance between the camera and the required field of vision. As the present detection distance is measured at ground level an editorial amendment of the definition of "detection distance" is needed.

2.1.2.10. The words "critical field of vision" is not used in the regulation, so this definition can be deleted.

2.1.2.11. The words "viewing reference point" is not used in the Regulation, so this definition can be deleted.

6.2.2.2.1. As standard EN 12368, related to traffic signal light, cannot be applied directly to camera's the test conditions for the blooming test, which simulates the influence of low sunlight on the performance of a camera, have been redefined in paragraph 6.2.2.2.1. to 6.2.2.2.1.4. Also the area in which the contrast is below a certain value has been set on a maximum of 15 % of the image on a monitor. This value is based on the results of comparing test.

6.2.2.2.4. This concerns a clarification that the measurement of the luminance contrast according ISO-standard 15008 has to be performed for a monitor only .

15.3.1. Clarification that the critical object has to be seen all over the required field of vision and not only on one point of that field. Furthermore a reference to Annex 10 has been inserted for details about the determination of the detection distance.

15.3.3. The reference to Annex 10 can be deleted as it is incorporated in paragraph 15.3.1.

21. As the dimension of the critical object for the class V devices for indirect vision has been reduced from 80 cm to 30 cm the new provisions should become a new series of amendments and not a supplement. This means that we need transitional provisions that:
- mandate the approval authorities to grant an approval according the 03-series of amendments as from the entry into force of the new provisions (§21.1);
  - declare that 12 months resp. 18 months after the entry into force new system type approvals must respectively new vehicle approvals must meet the new requirements, while after 24 months contracting parties may decide to refuse first registration when the new provisions are not met,
  - permits the use of devices that are not concerned with the new provisions and
  - copies several transitional provisions from the )2 series of amendments.

#### Annex 10

The procedure for calculating the maximum detection distance on the basis of video lines (which is a oversimplified model that should not be used) has been replaced by a new procedure based on ophthalmologic tests like Landolt-C or TOD (Triangle Orientation Discrimination).

## Annex 2

State of the art with regard to the replacement of mirrors by Camera-monitor systems

REGULATION No. 46 (Devices for indirect vision)

The modifications to the current text of the Regulation are marked in **bold** or ~~strikethrough~~ characters

A. PROPOSALS

1. Paragraph 2 amend to read:

“2. DEFINITIONS

For the purposes of this Regulation:

2.1. "Devices for indirect vision" means devices **intended to give a clear view to the rear, side or front of the vehicle within the fields of vision defined in paragraph 15.2.4.**~~to observe the traffic area adjacent to the vehicle which cannot be observed by direct vision.~~ These can be ~~conventional~~ mirrors, camera-monitors or other devices able to present information about the indirect field of vision to the driver.

2.1.1 "Mirror" means ~~any~~ device, excluding devices such as periscopes, intended to give a clear view to the rear, side or front of the vehicle within the fields of vision defined in paragraph 15.2.4. **by means of a reflective surface.**

2.1.1.1. "Interior mirror" means a device as defined in paragraph ~~2.1.2.1.1.~~ **2.1.1.1.**, which can be fitted in the passenger compartment of a vehicle.

2.1.1.2. "Exterior mirror" means a device as defined in paragraph ~~2.1.2.1.1.~~ **2.1.1.1.**, which can be mounted on the external surface of a vehicle.

2.1.1.3. "Surveillance mirror" means a mirror other than the ones defined in paragraph 2.1.1. which can be fitted to the inside or outside of the vehicle in order to provide fields of vision other than those specified in paragraph 15.2.4.

**2.1.1.4.** "r" means the average of the radii of curvature measured over the reflecting surface, in accordance with the method described in Annex 7.

**2.1.1.5.** "The principal radii of curvature at one point on the reflecting surface ( $r_i$ )" means the values obtained with the apparatus defined in Annex 7, measured on the arc of the reflecting surface passing through the centre of this surface parallel to the segment b, as defined in paragraph 6.1.2.1.2.1. and on the arc perpendicular to this segment.

**2.1.1.6.** "The radius of curvature at one point on the reflecting surface ( $r_p$ )" means the arithmetical average of the principal radii of curvature  $r_i$  and  $r_i'$  i.e.:

$$r_p = \frac{r_i + r_i'}{2}$$

**2.1.1.7.** "Spherical surface" means a surface, which has a constant and equal radius in all directions

**2.1.1.8.** "Aspherical surface" means a surface, which has only in one plane a constant radius.

**2.1.1.9.** "Aspherical mirror" means a mirror composed of a spherical and an aspherical part, in which the transition of the reflecting surface from the spherical to the aspherical part has to be marked. The curvature of the main axis of the mirror is defined in the x/y coordinate system defined by the radius of the spherical primary calotte with:

$$y = R - \sqrt{(R^2 - x^2) + k(x - a)^3}$$

R: nominal radius in the spherical part

k: constant for the change of curvature

a: constant for the spherical size of the spherical primary calotte

**2.1.1.10.** "Centre of the reflecting surface" means the centre of the visible area of the reflecting surface.

**2.1.1.11.** "The radius of curvature of the constituent parts of the mirror" means the radius "c" of the arc of the circle which most closely approximates to the curved form of the part in question.

2.1.2. "Camera-monitor device for indirect vision" means a device as defined in paragraph 2.1., where the field of vision is obtained by means of a camera-monitor combination as defined in paragraphs 2.1.2.1. and 2.1.2.2.

2.1.2.1. "Camera" means a device that renders an image of the outside world and then converts this image into a signal (e.g. video signal).

2.1.2.2. "Monitor" means a device that converts a signal into images that are rendered into the visual spectrum.

2.1.3. "Other devices for indirect vision" means devices as defined in paragraph 2.1., where the field of vision is not obtained by means of a mirror or a camera-monitor type device for indirect vision.

**2.1.4.** "Vision support system" means a system to enable the driver to detect and/or see objects in the area adjacent to the vehicle.

~~2.1.5. "Detection" means the ability to distinguish an object from its background/surroundings at certain distance.~~

~~2.1.6.~~ **2.1.5.** "Luminance contrast" means the brightness ratio between an object and its immediate background/surrounding that allows the object to be distinguished from its background/surroundings.

~~2.1.7.~~ **2.1.6.** "Resolution" means the smallest detail that can be discerned with a perceptual system, i.e. perceived as separate from the larger whole. The resolution of the human eye is indicated as "visual acuity".

- ~~2.1.8.~~ **2.1.7** "Critical object" means a ~~circular~~ **cylindrical** object. **For devices for class V and VI it shall be 500 mm high and with a diameter  $D_0 = 0.8$  300 mm.** ~~<sup>2/</sup>For classes I to IV and VII the dimensions shall be [.....]~~<sup>1</sup>
- 2.1.9.**2.1.8.** "Critical perception" means the level of perception that the human eye is generally capable of achieving under various conditions. For traffic conditions the limiting value for a critical perception is eight arc-minutes of visual angle.
- ~~2.1.10.~~**2.1.9.** "Field of vision" means the section of the tri-dimensional space which is monitored with the help of a device for indirect vision. Unless otherwise stated, this is based on the view on ground level offered by a device and/or devices other than mirrors. This may be limited by the relevant detection distance corresponding to the critical object.
- ~~2.1.11.~~**2.1.10.** "Detection distance" means the distance measured at ground level from the viewing reference point to the extreme point at which a critical object can just be perceived (the limiting value for a critical perception just barely achieved).
- ~~2.1.12.~~ "Critical field of vision" means the area in which a critical object has to be detected by means of a device for indirect vision and that is defined by an angle and one or more detection distances.
- ~~2.1.13.~~ "Viewing reference point" means the point linked to the vehicle to which the prescribed field of vision is related. This point is the projection on the ground of the intersection of a vertical plane passing through the driver's ocular points with a plane parallel to the median longitudinal plane of the vehicle situated 20 cm outside the vehicle.
- ~~2.1.14.~~**2.1.11.** "Visual spectrum" means light with a wavelength within the range of the perceptual limits of the human eyes: 380-780 nm.
- 2.2** "Type of device for indirect vision" means devices that do not differ on the following essential characteristics:
- (a) design of the device inclusive, if pertinent, the attachment to the bodywork;
  - (b) in case of mirrors the class, the shape, the dimensions and radius of curvature of the mirror's reflecting surface;
  - (c) in case of camera-monitor devices **the class the detection distance and the range of vision.** "
- 2.3.** "surveillance camera-monitor-recording device" means a camera and either a monitor or recording equipment other than the camera-monitor device defined in paragraph 2.1.2. which can be fitted to the inside or outside of the vehicle in order

---

~~<sup>2/</sup> A system for indirect vision is intended to detect relevant road users. The relevancy of a road user is defined by his or her position and (potential) speed. More or less in proportion with the speed of the pedestrian cyclist moped driver, the dimensions of these road users increase as well. For detection purposes a moped driver ( $D = 0.8$  m) at 40 m distance would be equal to a pedestrian ( $D = 0.5$  m) at a distance of 25 m. Considering the speeds, the moped driver would be selected as the criterion for the detection size; for that reason an object with a size of 0.8 m shall be used for determining the detection performance.~~

<sup>1</sup> **The critical object has to be defined later on, preferably by ISO.**

to provide fields of vision other than those specified in paragraph 15.2.4. or to provide a security system within or around the vehicle.

- 2.4.** "Class of ~~mirror~~ device for indirect vision" means all devices having one or more common characteristics or functions. They are classified as follows:
- Class I: "~~Interior~~ **Central** rear-view ~~mirror~~-**device** ", giving the field of vision defined in paragraph 15.2.4.1.
  - Class II and III: "Main ~~exterior~~ rear-view **device** ~~mirror~~-", giving the fields of vision defined in paragraphs 15.2.4.2. and 15.2.4.3.
  - Class IV: "Wide-angle **view device** ~~exterior mirror~~-", giving the field of vision defined in paragraph 15.2.4.4.
  - Class V: "Close-proximity **view device** ~~exterior mirror~~ ", giving the field of vision defined in paragraph 15.2.4.5.
  - Class VI: "Front **view device** ~~mirror~~ ", giving the field of vision defined in paragraph 15.2.4.6.
  - Class VII: ~~Mirrors~~ **Main rear view devices** intended for L category vehicles with bodywork **giving the field of vision defined in paragraph 15.2.4.7.**"
- 2.5.** '**original camera-monitor device for indirect vision` means a camera-monitor device of the type fitted to the vehicle at the time of type-approval or extension of type-approval.**

- Justifications:
- The definitions have been reordered such that those related to mirrors are grouped as sub points of paragraph 2.1.1; those related to camera-monitor devices become sub paragraphs of 2.1.2. and general definitions are numbered separately as 2.1.3 to 2.4.
  - The definition of "device for indirect vision" (2.1) has been aligned with the text of paragraph 2.1.1. and is relating to the required field of vision according paragraph 15.2.4.
  - The definition of mirror (2.1.1) has been amended to clarify that a mirror is only a device with a reflective surface for rendering the field of vision and excludes other devices.
  - The definitions of interior mirror and exterior mirror have been clarified so that related to the definition of mirror (2.1.1) and not to the general definition of "device for indirect vision" (2.1).
  - The names of the classes of devices have been amended as the mounting of a device for indirect vision in case of a camera-monitor system is not by definition interior or exterior the vehicle.
  - Simplification of the definition for camera-monitor device (2.1.2) as "for indirect vision is already included in the definition of paragraph 2.1.
  - IGCMS has suggested in its proposal for the testing of camera-monitor systems, to amend the definition for the critical object for class V and VI devices and to delete a certain footnote. The dimension of a diameter of 0.8 m for class V and VI will be replaced by a cylinder aligned with the provisions of paragraph 15.2.4.6.1. For other classes the dimensions of the critical object has to be defined later on, preferably by ISO.  
A consequence of the deletion of the footnote is that the definition of "detection" (2.1.2.3) is not needed anymore.
  - The informal group has two tasks in its terms of references, one dealing with the test procedure for camera monitor systems and another for the replacements of mirrors by camera monitor systems. This proposal anticipates on the adoption of the proposals for the first task like:



- a) the deletion of former definitions 2.1.5 for “detection”, 2.1.12 for “critical field of vision” and 2.1.13 for the “reference viewing point” and
- b) the amendment of the size of the critical object from a circle of 80 cm to a cylindrical figure; for the second task of the informal group the size of the critical object for devices of class I to IV and VII has to be defined in a standard that still has to be developed by ISO.

- The parameters defining a camera monitor type device (paragraph 2.2) has been limited to the class as the class defines the required field of vision.
- For camera-monitor devices the mounting position interior or exterior the vehicle is not relevant which justifies an amendment of the definitions for the mirror classes in paragraph 2.4. In addition, the new text is also made applicable to other devices than mirrors and
- The definition of original camera monitor device for indirect vision has been introduced because of amended provisions on markings in paragraph 4.2 and 5.4, where it is proposed that no marking is needed for original devices for indirect vision.

2. Paragraph 3.3 to 3.3.2., to be replaced by new paragraphs 3.3 to 3.3.1.as follows:

“3.3 For each type of device for indirect vision the application shall be accompanied by: **three samples of the parts.**

3.3.1. ~~in case of mirrors, four samples: three for use in the tests and one to be retained by the laboratory for any further examination that might subsequently prove necessary.~~ Additional specimens may be called for at the request of the laboratory.

3.3.2. ~~in case of other devices for indirect vision: one sample of all the parts.”~~

Justification: In general only three samples are needed as the retaining of one sample by the laboratory is not needed anymore.

3. Paragraph 4.2., amend to read:

“4.2 Every device **for indirect vision, with the exception of original Camera-monitor devices**, shall possess **on at least one of the main components** ~~its protective housing~~ a space large enough to accommodate the approval mark, which ~~must~~ **shall** be legible when the device has been mounted on the vehicle; this space shall be shown on the drawings referred to in Annex 1. **Other components of the device shall bear the name of the manufacturer and a means of identification.**”

**In case of limited space for the approval mark(s) other means of identification that tie it to the approval number mark shall be provided.”**

Justification: The identification of original systems can be verified by means of the vehicle type approval data so no separate marking for original devices is needed. Having regarded the limited space on the components for the approval marking it should be sufficient that only one main component has that mark; the identification of the other components can be verified by means of the system approval data.

4. Paragraph 5.4. amend to read:

- “5.4. There shall be affixed **on at least one of the main components**, conspicuously and in the space referred to in paragraph 4.2. above, to every device for indirect vision, **with the exception of original Camera-monitor devices for indirect vision**, conforming to a type approved under this Regulation, in addition to the mark prescribed in paragraph 4.1., an international approval mark consisting of:
- 5.4.1. A circle surrounding the letter "E" followed by the distinguishing number of the country which has granted approval;<sup>3/</sup>
- 5.4.2. An approval number;
- 5.4.3. ~~An additional~~ **Additional** symbol(s) I or/**and** II or/**and** III or/**and** IV or/**and** V or/**and** VI or/**and** VII, specifying the class to which the type of the ~~mirror~~ devices for indirect vision belongs ~~or the symbol S in case of any device for indirect vision other than a mirror~~. The additional symbol shall be placed in any convenient position in the vicinity of the circle containing the letter "E””

Justification: consequence of amended paragraph 4.2

5. Paragraph 5.5 amend to read:  
“5.5 The approval mark and the additional symbol(s) shall be clearly legible and be indelible.”

Justification: editorial correction as consequence of new wording of 5.4.3. that permits the use of more than one additional symbol.

6. Paragraph 6.1.1.3  
Change the reference to paragraph 6.1.3.2. into a reference to paragraph 6.3.2

Justification: consequence of the new numbering of former paragraph 6.1.3

7. Paragraph 6.1.2.1.1 amend to read:

“6.1.2.1.1. ~~Interior~~ **Central rear view interior** mirrors (Class I)

The dimensions of the reflecting surface must be such that it is possible to inscribe thereon a rectangle one side of which is 40 mm and the other 'a' mm in length, where

$$a = 150 \text{ mm} \times \frac{1}{1 + \frac{1000}{r}}$$

and r is the radius of curvature.”

Justification: alignment with the class definitions of 2.4. where the terminology “central rear view” is used

8. Paragraph 6.1.2.1.2. amend to read:

“6.1.2.1.2. ~~Main exterior-rear-view~~ **exterior** mirrors (Class II and III)”

Justification: alignment with the class definitions of 2.4. where the terminology “main rear view” is used.

9. Paragraph 6.1.2.1.3. amend to read:

“6.1.2.1.3. Wide-angle view exterior mirrors (Class IV)

The contours of the reflecting surface must be of simple geometric form and its dimensions such that it provides, if necessary in conjunction with a Class II exterior mirror, the field of vision specified in paragraph 15.2.4.4.”

Justification: alignment with the class definitions of 2.4. where the terminology “wide angle view” is used.

10. Paragraph 6.1.2.1.4. amend to read:

“6.1.2.1.4. Close-proximity view exterior mirrors (Class V)

The contours of the reflecting surface must be of simple geometric form and its dimensions such that the mirror provides the field of vision specified in paragraph 15.2.4.5.“

Justification: alignment with the class definitions of 2.4. where the terminology “close proximity view” is used.

11. Paragraph 6.1.2.1.5. amend to read:

“6.1.2.1.5. Front view mirrors (Class VI)

The contours of the reflecting surface must be of simple geometric form and its dimensions such that the mirror provides the field of vision specified in paragraph 15.2.4.6.”

Justification: alignment with the class definitions of 2.4. where the terminology “front view” is used.

12. Paragraph 6.1.2.1.6.1. amend to read:

6.1.2.1.6.1. Main rear view exterior mirrors (Class VII)

The minimum dimensions of the reflecting surface shall be such that:

- (a) Its area shall not be less than 6 900 mm<sup>2</sup>;
- (b) The diameter of circular mirrors shall not be less than 94 mm;
- (c) Where rear view mirrors are not circular, their dimensions shall enable a 78 mm-diameter circle to be prescribed on their reflecting surface.

The maximum dimensions of the reflecting surface shall be such that:

- (a) The diameter of any circular rear view mirror shall not be greater than 150 mm;

(b) The reflecting surface of any non-circular rear view mirror shall lie within a rectangle measuring 120 mm x 200 mm.

Justification: alignment with the class definitions of 2.4. where the terminology “rear view” is used.

13 Paragraph 6.1.3. shall be deleted.

Justification: text moved to 6.3 so that the provisions on the impact test applies also to other devices than mirrors.

14. Paragraph 6.1.3.2.2.3, replace the reference to paragraph 2.1.1.11. by a reference to paragraph 2.1.1.10.

Justification: consequence of the renumbering of the definitions of paragraph 2.

15. Paragraph 6.2.2.2 amend to read:

“6.2.2 CAMERA-MONITOR DEVICES ~~FOR INDIRECT VISION~~”

Justification: A camera monitor system is by definition for indirect vision.

16. Paragraph 6.2.2.1.1. amend to read:

“6.2.2.1.1. When the camera-monitor device ~~for indirect vision~~ is mounted ~~on a plane surface~~ **in the intended installation position**, all parts, irrespective of the adjustment position of the device which are in potential, static contact with a sphere either 165 mm in diameter in the case of parts fitted in the interior or 100 mm in diameter in the case of parts fitted to the exterior, must have a radius of curvature "c" of not less than 2.5 mm. **This does not apply to exterior parts of such devices which are installed 2.00 m or more above the ground.**

**Parts complying with Regulation 21 or Regulation 26 are deemed to satisfy the relevant requirements above.”**

Justification: the original wording could only be checked as part of the installation provisions. Furthermore it has been clarified that the provisions with regard to the radius of curvature do not applies to parts that are 2 metres or more above the ground and that the verification is not needed when approvals according regulation 21 or 26 are available.

17. Paragraph 6.2.2.4. amend to read:

“6.2.2.4. The measurements for the luminance contrast **of the monitor** shall be carried out according to ISO 15008: ~~2003~~ **2009.**”

Justification: clarification that the luminance contrast shall be measured for the monitor only.

18. Insert a new paragraph 6.2.2.2.5. reading:

**“6.2.2.2.5 The camera-monitor device of class I to IV and VII shall meet the provisions of newly to be developed standard ISO-xxxx:201x.**

Justification: IGCMS is of the opinion that the approval of camera-monitor systems should be based on a world-wide standard that has to be developed by ISO. In detail, the ISO standard should address the following topics:

- CMS – Applications (Use Cases, especially “Use Classes I to IV and VII as defined in UNECE regulation 46/02” and split screen use cases)
- Viewing conditions like viewing distance, viewing direction, viewing area and mirror class related to the display monitor
- Illuminance conditions (in vehicle, outside vehicle, night, day)
- Task requirements for the different use cases (mirror classes)
- Special physical requirements (Vibration, Wind, rain, snow, ice, excessive temperatures...) and coatings for protection against rain, snow and dirt, sensitivity of the system for rain,
- Performance requirements on detection and identification of the critical object as well as readability and/or legibility if required (representative and critical object(s) specifications):
- Implications for the size of the critical object related to the display and viewing conditions like geometric proportions between the size of the real critical object and the size of the displayed critical object
- CMS-Performance requirements under different lighting conditions: Display luminance and luminance contrast of the monitor under different illumination conditions, night sight (minimum illumination level), adaptation of the light intensity during the night, Colour presentation and colour uniformity
- Image artefacts (blooming, smear, lens reflection, geometric distortion) and freezing risk due to processing of image information
- image interpretation,
- Camera and display defects (Sensor pixel and display pixel defects)
- Temporal fidelity (flicker)
- Spatial instability (jitter)
- Detection of motion in real time, image moving artefacts, motion blur
- Latency (delay of time until image is displayed)
- Image compression
- Failure of the system
- Wireless technology issues (image artefacts during image processing,...).”

The new provisions according the proposed ISO standard will not apply to class V and VI devices as more stringent requirements are not needed for rendering the field of vision very close to the vehicle. There are no signs that the present provisions for these classes are insufficient.

19. insert a new paragraph 6.3 as follows:

“~~6.1.3.6.3~~      Test

6.3.1.            ~~Mirrors~~ **Devices for indirect vision** in Classes I to VI and Class VII (having fitments identical to Class III) shall be subjected to the tests described in paragraph 6.3.2.1 and 6.3.2.2. Class VII mirrors with a stem, shall be subjected to the tests described in paragraph 6.3.2.3.

6.3.1.1.        The test provided for in paragraph 6.3.2. shall not be required in the case of any exterior ~~mirror~~ **device for indirect vision** of which no part is less than 2 m from the ground, regardless of the adjustment position, when the vehicle is under a load corresponding to its maximum technically permissible mass.

This derogation also applies to the attachments of ~~mirrors~~ **devices for indirect vision** (attachment plates, arms, swivel joints, etc.) which are situated less than 2 m from the ground and which do not project beyond the overall width of the vehicle, measured in the transverse plane passing through the lowest mirror attachments or any other point forward of this plane if this configuration produces a greater overall width.

In such cases, a description specifying that the ~~mirror~~ **device for indirect vision** must be mounted so as to conform to the above-mentioned conditions for the positioning of its attachments on the vehicle must be provided.

Where advantage is taken of this derogation, the arm shall be indelibly marked with the symbol

$$\frac{\Delta}{2m}$$

and the type-approval certificate shall be endorsed to this effect.

6.3.2.            Impact test

The test according to this paragraph is not to be carried out for devices integrated in the bodywork of the vehicle and providing a frontal deflecting area of an angle not more than 45° measured in relation to the longitudinal median plane of the vehicle, or devices not protruding more than 100 mm measured beyond the circumscribing bodywork of the vehicle according to Regulation No. 26.

6.3.2.1.        Description of the test rig

6.3.2.1.1.      The test rig consists of a pendulum capable of swinging about two horizontal axes at right angles to each other, one of which is perpendicular to the plane containing the "release" trajectory of the pendulum.

The end of the pendulum comprises a hammer formed by a rigid sphere with a diameter of  $165 \pm 1$  mm having a 5 mm thick rubber covering of Shore A hardness 50.

A device is provided which permits determination of the maximum angle assumed by the arm in the plane of release.

A support firmly fixed to the structure of the pendulum serves to hold the specimens in compliance with the impact requirements specified in paragraph 6.3.2.2.7.

Figure 1 below gives the dimensions (in mm) of the test rig and the special design specifications:

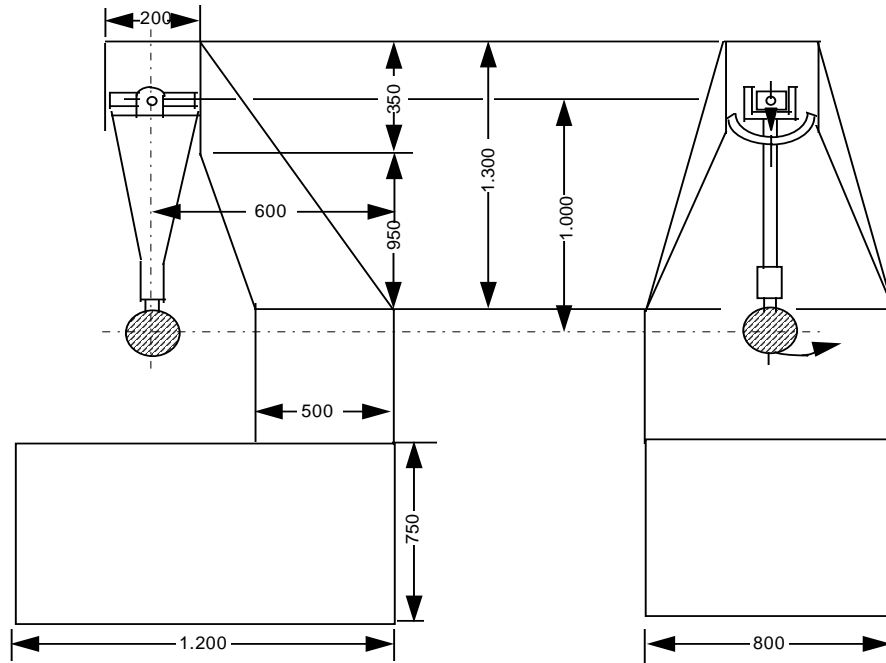

Figure 1

- 6.3.2.1.2. The centre of percussion of the pendulum coincides with the centre of the sphere, which forms the hammer. It is at a distance  $l$  from the axis of oscillation in the release plane, which is equal to  $1\text{ m} \pm 5\text{ mm}$ . The reduced mass of the pendulum is  $m_0 = 6.8 \pm 0.05$  kilograms. The relationship of  $m_0$  to the total mass  $m$  of the pendulum and to the distance  $d$  between the centre of gravity of the pendulum and its axis of rotation is expressed in the equation:

$$m_0 = m \times \frac{d}{l}$$

- 6.3.2.2. Description of the test

- 6.3.2.2.1.1 The procedure used to clamp the ~~mirror~~ **device for indirect vision** to the support shall be that recommended by the manufacturer of the device or, where appropriate, by the vehicle manufacturer.

- 6.3.2.2.2. Positioning of the ~~mirror~~ **device for indirect vision** for the test:

- 6.3.2.2.2.1. ~~Mirrors~~ **Devices for indirect vision** shall be positioned on the pendulum impact rig in such a way that the axes which are horizontal and vertical when the ~~mirror~~ **device for indirect vision** is installed on a vehicle in accordance with the applicant's mounting instructions are in a similar position;

- 6.3.2.2.2.2 When a ~~mirror~~ **device for indirect vision** is adjustable with respect to the base, the test position shall be that in which any pivoting device is least likely to operate, within the limits of adjustment provided by the applicant;

- 6.3.2.2.3. When the ~~mirror~~ **device for indirect vision** has a device for adjusting its distance from the base, the device must be set in the position in which the distance between the housing and the base is shortest;
- 6.3.2.2.4. **In case of mirrors**, when the reflecting surface is mobile in the housing, it shall be so adjusted that the upper corner, which is furthest from the vehicle, is in the position of greatest projection relative to the housing.
- 6.3.2.2.3. **In case of mirrors**, except in the case of test 2 for interior mirrors (see paragraph 6.3.2.2.7.1.), when the pendulum is in a vertical position the horizontal and longitudinal vertical planes passing through the centre of the hammer shall pass through the centre of the reflecting surface as defined in paragraph ~~2.1.1.11~~. **2.1.1.10**. The longitudinal direction of oscillation of the pendulum shall be parallel to the longitudinal median plane of the vehicle.
- 6.3.2.2.4. In case of camera-monitor-systems, when the pendulum is in a vertical position the horizontal and longitudinal vertical planes passing through the centre of the hammer shall pass through the centre of the lens or of the transparent protection part in front of the lens. The longitudinal direction of oscillation of the pendulum shall be parallel to the longitudinal median plane of the vehicle. If the test is performed with a shutter camera system, the shutter has to be open during the pendulum impact.**
- 6.3.2.2.5. When, under the conditions governing adjustment laid down in paragraphs 6.3.2.2.1. and 6.3.2.2.2. parts of the ~~mirror~~ **device for indirect vision** limit the return of the hammer, the point of impact must be displaced in a direction perpendicular to the axis of rotation or pivoting in question.
- The displacement must be no greater than is strictly necessary for the execution of the test; it must be limited in such a way that:
- a) either the sphere delimiting the hammer remains at least tangential to the cylinder as defined in paragraph 6.1.1.5.;
  - b) or, **in case of mirrors**, the point of contact with the hammer is located at least 10 mm from the periphery of the reflecting surface.
- 6.3.2.2.6. The test consists in allowing the hammer to fall from a height corresponding to a pendulum angle of 60° from the vertical so that the hammer strikes the ~~mirror~~ **device for indirect vision** at the moment when the pendulum reaches the vertical position.
- 6.3.2.2.7. The ~~mirrors~~ **devices for indirect vision** are subjected to impact under the following different conditions:
- 6.3.2.2.7.1. Interior mirrors
- a) Test 1: The points of impact shall be as defined in paragraph 6.3.2.2.3. The impact must be such that the hammer strikes the mirror on the reflecting surface side.
  - b) Test 2: Point of impact on the edge of the protective housing, such that the impact produced makes an angle of 45° with the plane of the reflecting surface and is situated in the horizontal plane passing through the centre of that surface. The impact must occur on the reflecting surface side.



#### 6.3.2.2.7.2. Exterior mirrors

- a) Test 1: The point of impact shall be as defined in paragraph 6.3.2.2.3. or 6.3.2.2.5. The impact must be such that the hammer strikes the mirror on the reflecting surface side.
- b) Test 2: The point of impact shall be as defined in paragraph 6.3.2.2.3. or 6.3.2.2.5. The impact must be such that the hammer strikes the mirror on the side opposite to the reflecting surface.

Where Class II or III rear-view mirrors are fixed to the same mounting as Class IV rear-view mirrors, the above-mentioned tests shall be executed on the lower mirror. Nevertheless, the Technical Service responsible for testing may repeat one or both of these tests on the upper mirror if this is less than 2 m from the ground.

#### 6.3.2.2.7.3. Camera-Monitor-Systems

- a) **Test 1: The point of impact shall be as defined in paragraph 6.3.2.2.4. or 6.3.2.2.5. The impact must be such that the hammer strikes the camera on the lens side.**
- b) **Test 2: The point of impact shall be as defined in paragraph 6.3.2.2.4. or 6.3.2.2.5. The impact must be such that the hammer strikes the camera on the side opposite to the lens.**

**Where more than one cameras are fixed to the same mounting, the above-mentioned tests shall be executed on the lower camera. Nevertheless, the Technical Service responsible for testing may repeat one or both of these tests on the upper camera if this is less than 2 m from the ground.**

#### 6.3.2.3. Bending test on the protective housing attached to the stem (Class VII)

##### 6.3.2.3.1. Description of test

The protective housing is placed horizontally in a device in such a way that it is possible to lock the attachment support adjusters firmly. In the direction of the largest dimension of the housing, the end closest to the point of attachment on the adjuster for the support shall be immobilized by a 15 mm-wide rigid stop covering the entire width of the housing.

At the other end, a stop identical to the one described above is placed on the housing so that the specified test load can be applied to it (Figure 2).

The end of the housing opposite to that where the force is exerted may be locked rather than held in position as shown in Figure 2.

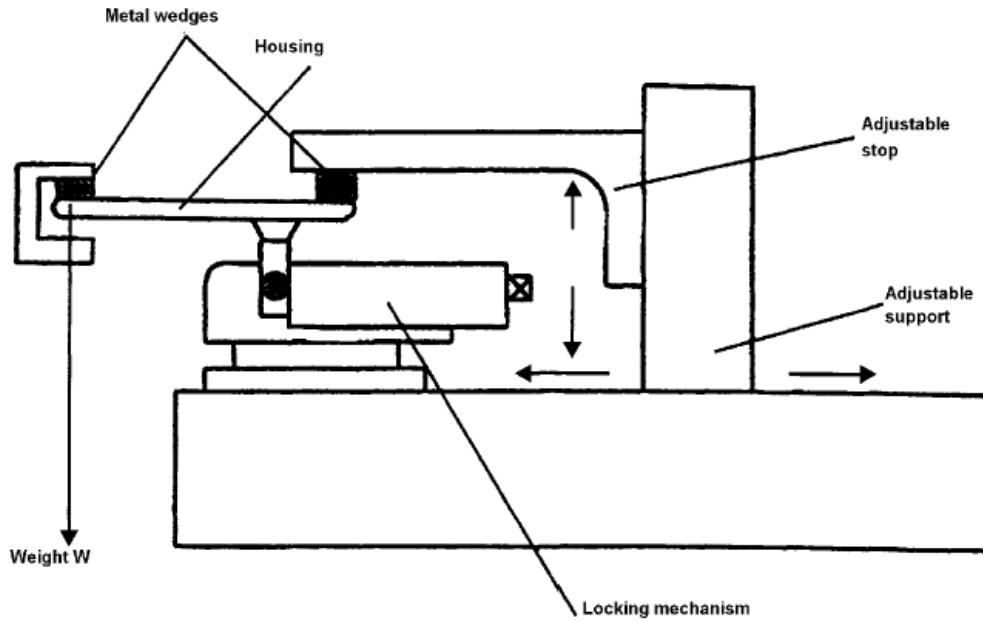

Figure 2: Example of rear view mirror bending-test rig

6.3.2.3.2. The test loading shall be 25 kilograms and shall be maintained for one minute.

6.3.3. Results of the tests

In the tests described in paragraph 6.3.2., the pendulum must continue to swing after impact in such a way that the projection of the position assumed by the arm on the plane of release makes an angle of at least 20° with the vertical. The accuracy of measurement of the angle shall be within ± 1°.

6.3.3.1.1. **In case of mirrors**, this requirement is not applicable to mirrors stuck to the windscreen, in respect of which the requirement stipulated in paragraph 6.3.3.2. shall apply after the test.

6.3.3.1.2. The required angle to the vertical is reduced from 20° to 10° for all Class II and Class IV ~~rear view mirrors~~ **devices for indirect vision** and for Class III ~~rear view mirrors~~ **devices for indirect vision** which are attached to the same mounting as Class IV ~~mirrors~~ **devices for indirect vision**.

6.3.3.2. **In case of mirrors**, should the mounting of the mirror break during the tests described in paragraph 6.3.2. for mirrors stuck to the windscreen, the part remaining must not project beyond the base by more than 10 mm and the configuration remaining after the test must satisfy the conditions laid down in paragraph 6.1.3.

6.3.3.3. **In case of mirrors**, the reflecting surface must not break during the tests described in paragraph 6.3.2. However, breakage of the reflecting surface will be allowed if one of the following conditions is fulfilled:

6.3.3.3.1. the fragments of glass still adhere to the back of the housing or to a surface firmly attached to the housing; partial separation of the glass from its backing is admissible provided that this does not exceed 2.5 mm on either side of the cracks. It is permissible for small splinters to become detached from the surface of the glass at the point of impact;

6.3.3.3.2. the reflecting surface is made of safety glass.

**6.3.3.4. In case of camera-monitor-systems, the lens shall not break during the test described in paragraph 6.3.2. “**

Justification: The provisions with regard to the impact test has been moved from paragraph 6.1.3. to a new paragraph 6.3 by which the provisions become applicable to all devices for indirect vision.  
Moreover the setup for the impact test for camera-monitor systems has been described.  
Finally it will be necessary that in analogous to mirrors the lens of the camera will not be broken after the tests.

20. Paragraph 15.1.2., amend to read:

“15.1.2. ~~Mirrors and other devices~~ **Devices** for indirect vision must be fitted in such a way that ~~the mirror or other device does not~~ **they do not** move so as significantly to change the field of vision as measured or vibrate to an extent which would cause the driver to misinterpret the nature of the image perceived.”

Justification: simplification of the text.

21. Paragraph 15.2., amend to read:

"15.2. ~~MIRRORS~~ **DEVICES FOR INDIRECT VISION** "

Justification: needed for making the provisions independent from the kind of device for indirect vision

22. Paragraph 15.2.1.1., amend to read:

“15.2.1.1. Minimum number of compulsory **devices for indirect vision**.

Justification: needed for making the provisions independent from the kind of device for indirect vision.

23. Paragraph 15.2.1.1.1., amend to read:

“15.2.1.1.1. The fields of vision prescribed in paragraph 15.2.4. shall be obtained from the minimum number ~~on~~ **of** mandatory mirrors set out in the following table **or camera monitor devices**. ~~Where the presence of a mirror is not requested on a mandatory base, this means that no other system for indirect vision can be requested on a mandatory base.~~

**In case of camera monitor systems there is no minimum number but they shall provide the same field of vision as given in that table and the provision on the minimum mounting height does not apply.**

**In case of camera-monitor devices the maximum number of monitors shall not exceed the corresponding number of mirrors. “**

Justifications: - to clarify that the minimum number of devices is not relevant for camera-monitor systems;  
- there may in future be cases where devices for indirect vision other than mirrors are mandated for without a corresponding requirement for a mirror; e.g. a rear view camera-monitor system on a truck or bus and  
- the number of monitors should be limited.

24. The table of paragraph 15.2.1.1.1., shall be amended as follows:

Vehicle category	Interior mirror	Exterior mirrors				
	Interior mirror Central rear view Class I	Main mirror (large) rear view Class II	Main mirror (small) rear view Class III	= Wide-angle mirror view Class IV	Close-proximity mirror view Class V	= Front mirror view Class VI
M <sub>1</sub>	<b>Compulsory</b> Unless the vehicle is fitted with anything other than safety glazing material in the field of vision prescribed in paragraph 15.2.4.1.	<i>Optional</i>	<b>Compulsory</b> 1 on the driver's side and 1 on the passenger's side. Class II <del>mirrors</del> <b>devices</b> may be fitted as an alternative.	<b>Optional</b> 1 on the driver's side and / or 1 on the passenger's side	<b>Optional</b> 1 on the driver's side and 1 on the passenger's side (both must be fitted at least 2 m above the ground)	<b>Optional</b> (must be fitted at least 2 m above the ground)
M <sub>2</sub>	<b>Optional</b> (no requirements for the field of view)	<b>Compulsory</b> 1 on the driver's side and 1 on the passenger's side	= Not permitted	<b>Optional</b> 1 on the driver's side and / or 1 on the passenger's side	<b>Optional</b> 1 on the driver's side and 1 on the passenger's side (both must be fitted at least 2 m above the ground)	<b>Optional</b> (must be fitted at least 2 m above the ground)
M <sub>3</sub>	<b>Optional</b> (no requirements for the field of view)	<b>Compulsory</b> 1 on the driver's side and 1 on the passenger's side	Not permitted	<b>Optional</b> 1 on the driver's side and / or 1 on the passenger's side	<b>Optional</b> 1 on the driver's side and 1 on the passenger's side  (both must be fitted at least 2 m above the ground)	<b>Optional</b> (must be fitted at least 2 m above the ground)

Vehicle category	Interior mirror	Exterior mirrors				
	Interior mirror Central rear view Class I	Main mirror (large) rear view Class II	Main mirror (small) rear view Class III	= Wide-angle mirror view Class IV	Close-proximity mirror view Class V	= Front mirror view Class VI
N <sub>1</sub>	<b>Compulsory</b> Unless the vehicle is fitted with anything other than safety glazing material in the field of vision prescribed in paragraph 15.2.4.1.	<b>Optional</b>	<b>Compulsory</b> 1 on the driver's side and 1 on the passenger's side Class II <del>mirrors</del> devices may be fitted as an alternative.	<b>Optional</b> 1 on the driver's side and / or 1 on the passenger's side	<b>Optional</b> 1 on the driver's side and 1 on the passenger's side (both must be fitted at least 2 m above the ground)	<b>Optional</b> (must be fitted at least 2 m above the ground)
N <sub>2</sub> ≤ 7,5 t	<b>Optional</b> (no requirements for the field of view)	<b>Compulsory</b> 1 on the driver's side and 1 on the passenger's side	Not permitted	<b>Compulsory</b> For both sides if a Class V <del>mirror</del> device can be fitted <b>Optional</b> For both sides together if not	<b>Compulsory</b> (see paragraphs 15.2.2.7. and 15.2.4.5.5.) One on the passenger's side <b>Optional</b> One on the driver's side (both must be fitted at least 2 m above the ground). A tolerance of + 10 cm may be applied	<b>Optional</b> 1 front mirror (must be fitted at least 2 m above the ground)
N <sub>2</sub> > 7,5 t	<b>Optional</b> (no requirements for the field of view)	<b>Compulsory</b> = 1 on the driver's side and 1 on the passenger's side	Not permitted	<b>Compulsory</b> 1 on the driver's side and 1 on the passenger's side	<b>Compulsory</b> , see paragraph 15.2.2.7. and 15.2.4.5.5) 1 on the passenger's side <b>Optional</b> 1 on Driver's side (both must be fitted at least 2 m above the ground)	<b>Compulsory</b> , see paragraph 15.2.1.1.2 1. front mirror (must be fitted at least 2 m above the ground)

Vehicle category	Interior mirror	Exterior mirrors				
	Interior mirror Central rear view Class I	Main mirror (large) rear view Class II	Main mirror (small) rear view Class III	= Wide-angle mirror view Class IV	Close-proximity mirror view Class V	= Front mirror view Class VI
N <sub>3</sub>	<b>Optional</b> (no requirements for the field of view)	<b>Compulsory</b> = 1 on the driver's side and 1 on the passenger's side	Not permitted	<b>Compulsory</b> 1 on the driver's side and 1 on the passenger's side	<b>Compulsory</b> , see paragraph 15.2.2.7. and 15.2.4.5.5) 1 on the passenger's side <b>Optional</b> 1 on driver's side (both must be fitted at least 2 m above the ground)	<b>Compulsory</b> , see paragraph 15.2.1.1.2 1. front mirror (must be fitted at least 2 m above the ground)

Justification: - alignment of the amended definitions for class (paragraph 2.4.); furthermore, the position like interior and exterior is not relevant in case of camera-monitor systems.

25. Paragraph 15.2.1.1.2., amend to read:

“15.2.1.1.2. ~~In case the described field of vision of a front mirror prescribed in paragraph 15.2.4.6. and/or a close proximity mirror described in paragraph 15.2.4.5. can be obtained by another device for indirect vision that is approved according to paragraph 6.2. and that is installed according to paragraph 15., this device can be used instead of the relevant mirror or mirrors.~~

~~In case a camera/monitor device is used, the monitor must exclusively show:~~

- ~~(a) The field of vision prescribed in paragraph 15.2.4.5. when the close proximity mirror has been substituted,~~
- ~~(b) The field of vision prescribed in paragraph 15.2.4.6. when the front mirror has been substituted while the vehicle is moving forward with a speed of up to 10 km/h, or~~
- ~~(c) Simultaneously the fields of vision prescribed in paragraphs 15.2.4.5. and 15.2.4.6. when the close proximity mirror and the front mirror have been substituted. In the case where the vehicle is moving forward at a higher speed than 10 km/h or moving backwards, the monitor may be used for other information, provided that the field of vision prescribed in paragraph 15.2.4.5. is permanently displayed."~~

**In case a camera-monitor device is used for rendering the field of vision(s) the relevant field of vision(s) shall be permanently visible to the driver when ignition is on. However, when the vehicle is moving forward at a speed higher than 10 km/h or rearwards, the monitor or the part of the monitor intended for rendering the class VI field of vision may be used for other information.**

**Multiple images may be used or displayed provided that the monitor has been approved in this mode.**

**Additional vehicle information may be displayed provided that this does not compromise the required field(s) of vision.**

Justification:

The field of vision should always be rendered as it is always available in case of mirrors. Furthermore, the purpose of all these amendments is to permit the replacements of all mirrors by camera-monitor systems and to make the provisions independent from the used device. Therefore the present wording of Regulation 46/02 is not relevant anymore. Moreover all devices installed on a vehicle must be type-approved (paragraph 15.1.1.). All this leads to a limitation of this paragraph to the use of the monitor for front view for other purposes. Finally the text has been clarified to permit split screen of combined field of visions for adjacent classes like V and VI.



26. Paragraph 15.2.1.1.3. and 15.2.1.1.4. amend to read:

“15.2.1.1.3. ~~Rear view mirrors~~ **and camera monitor devices** required for L-category vehicles with body work

Category of vehicle	<del>Interior mirror</del> <b>Central rear-view</b> (Class I)	Main rear-view exterior mirror(s) (Classes III and VII)
L category motor vehicles fitted with bodywork which partly or wholly encloses the driver	1 <u>1/</u>	1, if there is <del>an interior mirror</del> a <b>central rear-view device for indirect vision;</b> 2, if there is not <del>an interior mirror</del> a <b>central rear-view device for indirect vision</b>
<u>1/</u> No <del>interior rear view mirror</del> <b>central rear-view device for indirect vision</b> is required if the visibility conditions referred to in paragraph 15.2.5.4.1. below cannot be met. In this case two exterior rear-view mirrors <b>or camera monitor devices</b> are required, one <b>giving the view</b> on the left and one <b>giving the view</b> on the right hand side of the vehicle.		

Where a single exterior rear view mirror **or camera** is fitted this shall be located on the left hand side of the vehicle in those countries where the traffic drives on the right and on the right hand side of the vehicle in those countries where the traffic drives on the left.

**Multiple images may be used or displayed provided that the monitor has been approved in this mode.**

Justification: Alignment of the text with the new definition of classes (para. 2.4). Furthermore it has been clarified that when two devices are requested the use of split screen is permissible.

15.2.1.1.4. Optional ~~rear view mirrors~~ mirrors and camera monitor devices for L-category vehicles

The fitting of an exterior rear-view mirror **or camera monitor device giving the view** on the side of the vehicle opposite to that of the mandatory **main rear-view device for indirect vision** ~~mirror~~ referred to in paragraph 15.2.1.1.3, is permissible. ~~The rear view mirror shall meet the requirements of this Regulation.~~

Justification: Alignment of the text with the new definition of classes (para. 2.4). The former provision that the device shall meet the requirements of this regulation is superfluous as it is already covered by paragraph 15.1.1.

27 Paragraph 15.2.1.2 amend to read:

15.2.1.2. The provisions of this Regulation do not apply to the surveillance mirrors defined in paragraph 2.1.1.3 **or surveillance camera-monitor-recording device defined in paragraph 2.3.** Nevertheless, the exterior surveillance mirrors must be mounted at least 2 m above the ground when the vehicle is under a load corresponding to its maximum technical permissible mass.

Justification: To clarify that this regulation neither applies to surveillance camera-monitor systems

28. Paragraph 15.2.2.1., amend to read:

"15.2.2.1. ~~Mirrors~~ **Devices for indirect vision** must ~~shall~~ be so placed that the driver, when sitting in the driving seat in a normal driving position, has a clear view of the road to the rear, side(s) or front of the vehicle. "

Justification: The text has been amended so that it applies also for other devices than mirrors.

29. Paragraph 15.2.2.3., amend to read:

"15.2.2.3. In the case of any vehicle, which is in chassis/cab form when the field of vision is measured, the minimum and maximum body widths shall be stated by the manufacturer and, if necessary, simulated by dummy headboards. All vehicles and ~~mirror~~ **devices for indirect vision** configurations taken into consideration during the tests shall be shown on the type-approval certificate for a vehicle with regard to the installation of ~~mirrors~~ **devices for indirect vision** (see Annex 4). "

Justification: The text has been amended so that it applies also for other devices than mirrors.

30. Paragraph 15.2.2.5 amend to read:

"15.2.2.5. ~~Mirrors~~ **Devices for indirect vision** must not project beyond the external bodywork of the vehicle substantially more than is necessary to comply with the requirements concerning fields of vision laid down in paragraph 15.2.4."

Justification: The text has been amended so that it applies also for other devices than mirrors.

31. Paragraph 15.2.2.7. amend to read:

"15.2.2.7. Class V and Class VI mirrors shall be mounted on vehicles in such a way that, regardless of their position after adjustment, no part of these mirrors or their holders is less than 2 m from the ground when the vehicle is under a load corresponding to its technically permissible maximum laden mass.

These mirrors shall not, however, be mounted on vehicles the cab height of which is such as to prevent compliance with this requirement. In this case ~~an other device for indirect vision is not requested~~ **another device for indirect vision is not mandatory.**"

Justification: The text has been clarified so that other devices than mirrors is neither needed.

32. Paragraph 15.2.2.8. amend to read:

"15.2.2.8. Subject to the requirements of paragraphs 15.2.2.5., 15.2.2.6. and 15.2.2.7., ~~mirrors~~ **devices for indirect vision** may project beyond the permissible maximum widths of vehicles."

Justification: The text has been amended so that it applies also for other devices than mirrors.

33. Paragraph 15.2.3.1. and 15.2.3.2. amend to read:

15.2.3.1. ~~The interior mirror~~ **If a Class I central rear view mirror is fitted it** must be capable of being adjusted by the driver from his driving position.

15.2.3.2. ~~The exterior mirror situated on the driver's side~~ **If a main rear view Class II or Class III mirror is fitted on the driver's side, it** must be capable of being adjusted from inside the vehicle while the door is closed, although the window may be open. The mirror may, however, be locked in position from the outside.

Justification: Alignment of the text with the new definition of classes (para. 2.4) and to specify that these provisions only apply to mirrors.

34. Paragraph 15.2.4.1. amend to read:

5.2.4.1. ~~Interior rear view mirror~~ **Central rear-view field of vision (Class I)**

The field of vision must be such that the driver can see at least a 20 m wide, flat, horizontal portion of the road centred on the vertical longitudinal median plane of the vehicle and extending from 60 m behind the driver's ocular points (Figure 4) to the horizon.

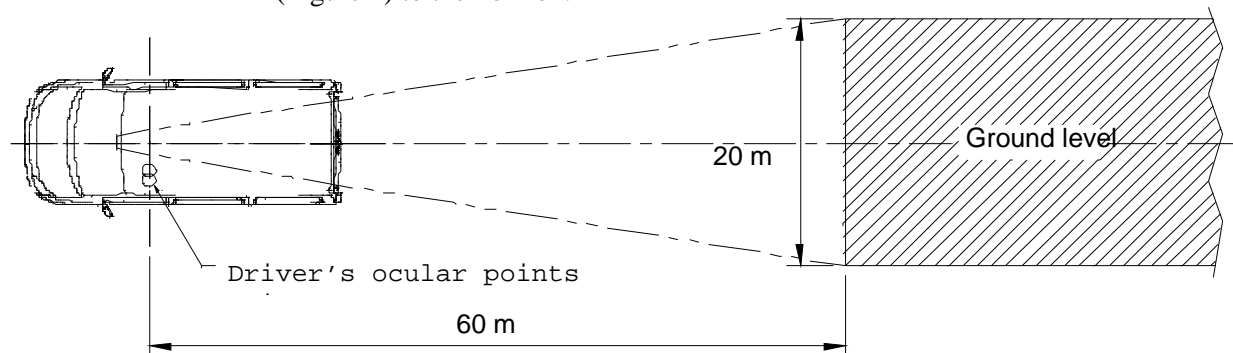

Figure 4: ~~Class I field~~ **Field of vision of Class I mirror**

Justification: Alignment of the text with the new definition of classes (para. 2.4).

35. Paragraph 15.2.4.2. , 15.2.4.2.1. and 15.2.4.2.2. , amend to read:

"15.2.4.2. ~~Main exterior rear-view mirrors~~ Class II **main rear-view field of vision** "

15.2.4.2.1. ~~Exterior Main~~ rear-view **field of vision mirror on the driver's side**

The field of vision must be such that the driver can see at least a 5 m wide, flat, horizontal portion of the road, which is bounded by a plane which is parallel to the median longitudinal vertical plane and passing through the outermost point of the vehicle on the driver's side of the vehicle and extends from 30 m behind the driver's ocular points to the horizon.

In addition, the road must be visible to the driver over a width of 1 m, which is bounded by a plane parallel to the median longitudinal vertical plane and passing through the outermost point of the vehicle starting from a point 4 m behind the vertical plane passing through the driver's ocular points (see Figure 5).

15.2.4.2.2. ~~Exterior Main~~ rear-view **field of vision mirror on the passenger's side**

The field of vision must be such that the driver can see at least a 5 m wide, flat, horizontal portion of the road, which is bounded on the passenger's side by a plane parallel to the median longitudinal vertical plane of the vehicle and passing through the outermost point of the vehicle on the passenger's side and which extends from 30 m behind the driver's ocular points to the horizon.

In addition, the road must be visible to the driver over a width of 1 m, which is bounded by a plane parallel to the median longitudinal vertical plane and passing through the outermost point of the vehicle starting from a point 4 m behind the vertical plane passing through the driver's ocular points (see Figure 5).

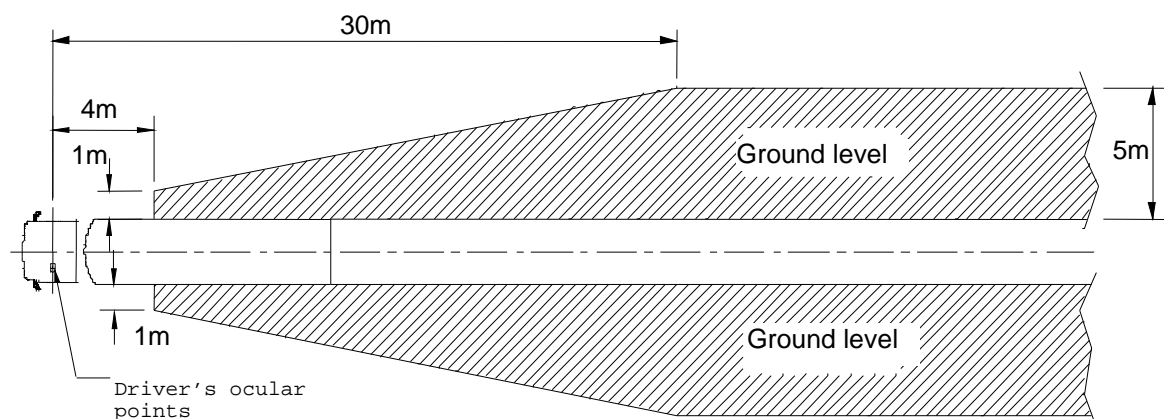

Figure 5: ~~Field of vision of Class II mirrors~~ **Class II field of vision**

“

Justification: Alignment of the text with the new definition of classes (para. 2.4)

36. Paragraph 15.2.4.3. to 15.2.4.3.2. amend to read:

“ 15.2.4.3. ~~Main exterior~~ **Class III main** rear-view **field of vision mirrors** ~~Class III~~

15.2.4.3.1. ~~Exterior~~ **Main** rear-view ~~mirror~~ **field of vision** on the driver's side

The field of vision must be such that the driver can see at least a 4 m wide, flat, horizontal portion of the road, which is bounded by a plane parallel to the median longitudinal vertical plane and passing through the outermost point of the vehicle on the driver's side of the vehicle and extends from 20 m behind the driver's ocular points to the horizon (see Figure 5).

In addition, the road must be visible to the driver over a width of 1 m, which is bounded by a plane parallel to the median longitudinal vertical plane and passing through the outermost point of the vehicle starting from a point 4 m behind the vertical plane passing through the driver's ocular points.

15.2.4.3.2. ~~Exterior~~ **Main** rear-view **field of vision mirror** on the passenger's side

The field of vision must be such that the driver can see at least a 4 m wide flat, horizontal portion of the road which is bounded by a plane parallel to the median longitudinal vertical plane passing through the outermost point of the vehicle on the passenger's side and which extends from 20 m behind the driver's ocular points to the horizon (see Figure 6).

In addition, the road must be visible to the driver over a width of 1 m, which is bounded by a plane parallel to the median longitudinal vertical plane and passing through the outermost point of the vehicle starting from a point 4 m behind the vertical plane passing through the driver's ocular points.

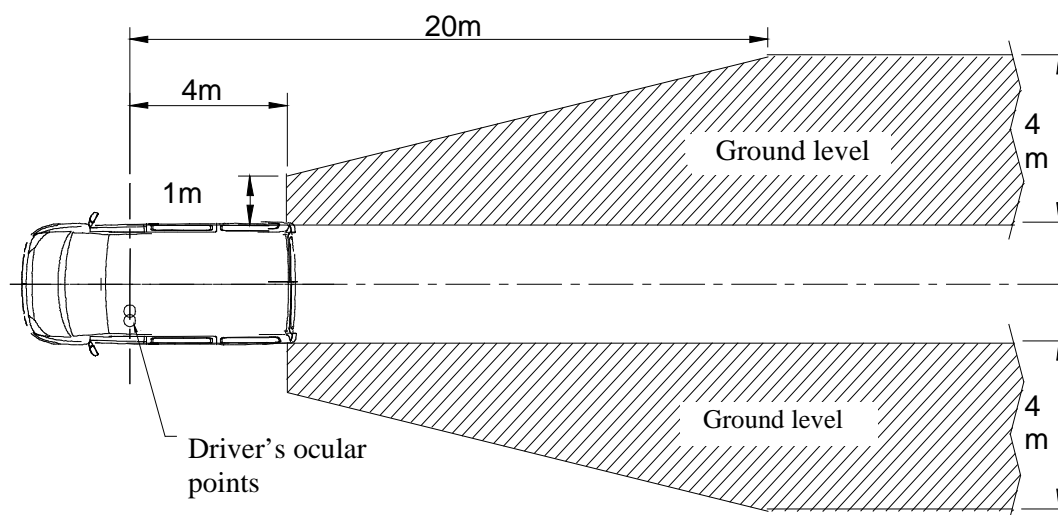

Figure 6: Field of vision of Class III **field of vision mirrors**

“.

Justification: Alignment of the text with the new definition of classes (para. 2.4).

37. Paragraph 15.2.4.4. to 15.2.4.4.2. amend to read:

15.2.4.4. ~~Wide-angle" exterior mirror (Class IV)~~ Wide-angle view **device**

15.2.4.4.1. Wide-angle **field of vision** ~~exterior mirror~~ on the driver's side

The field of vision must be such that the driver can see at least a 15 m wide, flat, horizontal portion of the road, which is bounded by a plane parallel to the median longitudinal vertical plane of the vehicle and passing through the outermost point of the vehicle on the driver's side and which extends from at least 10 m to 25 m behind the driver's ocular points.

In addition, the road must be visible to the driver over a width of 4.5 m, which is bounded by a plane parallel to the median longitudinal vertical plane and passing through the outermost point of the vehicle starting from a point 1.5 m behind the vertical plane passing through the driver's ocular points (see Figure 7).

15.2.4.4.2. "Wide-angle" **field of vision** ~~exterior mirror~~ on the passenger's side

The field of vision must be such that the driver can see at least a 15 m wide, flat, horizontal portion of the road, which is bounded by a plane parallel to the median longitudinal vertical plane of the vehicle and passing through the outermost point of the vehicle on the passenger's side and which extends from at least 10 m to 25 m behind the driver's ocular points.

In addition, the road must be visible to the driver over a width of 4.5 m, which is bounded by a plane parallel to the median longitudinal vertical plane and passing through the outermost point of the vehicle starting from a point 1.5 m behind the vertical plane passing through the driver's ocular points (see Figure 7).

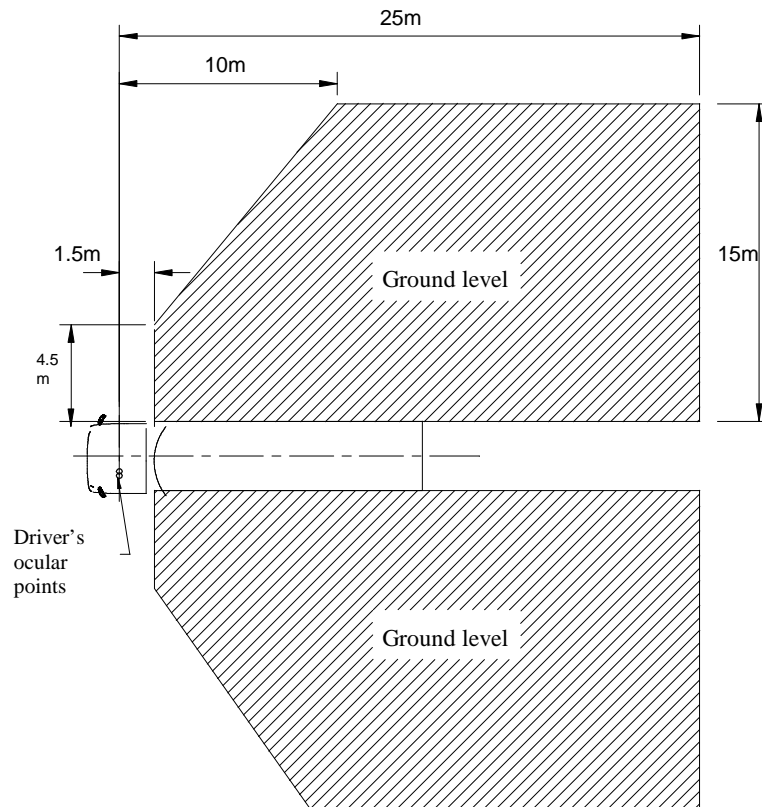

**Figure 7: Field of vision of Class IV wide-angle mirrors**  
~~Class IV wide-angle field of vision~~

**Justification:** Alignment of the text with the new definition of classes (para. 2.4); figure 7 has been corrected on the passenger's side so that the indicated dimensions are in correspondence with the front of the grey area.

38. Paragraph 15.2.4.5. amend to read:

15.2.4.5. ~~Close proximity" exterior mirror (Class V)~~ **Class V close-proximity fields of vision**

The field of vision must be such that the driver can see a flat horizontal portion of the road along the side of the vehicle, bounded by the following vertical planes (see Figures 8a and 8b):

**Justification:** Alignment of the text with the new definition of classes (para. 2.4)

39. Paragraph 15.2.4.5.5. amend to read:

- 15.2.4.5.5. In case the field of vision described in Figures 8a and 8b can be perceived through the combination of the field of vision from a Class IV **device for indirect vision** ~~wide-angle mirror~~ and that of a Class VI **device for indirect vision** ~~front mirror~~, the installation of a Class V close proximity **device for indirect vision** ~~mirror~~ is not compulsory.

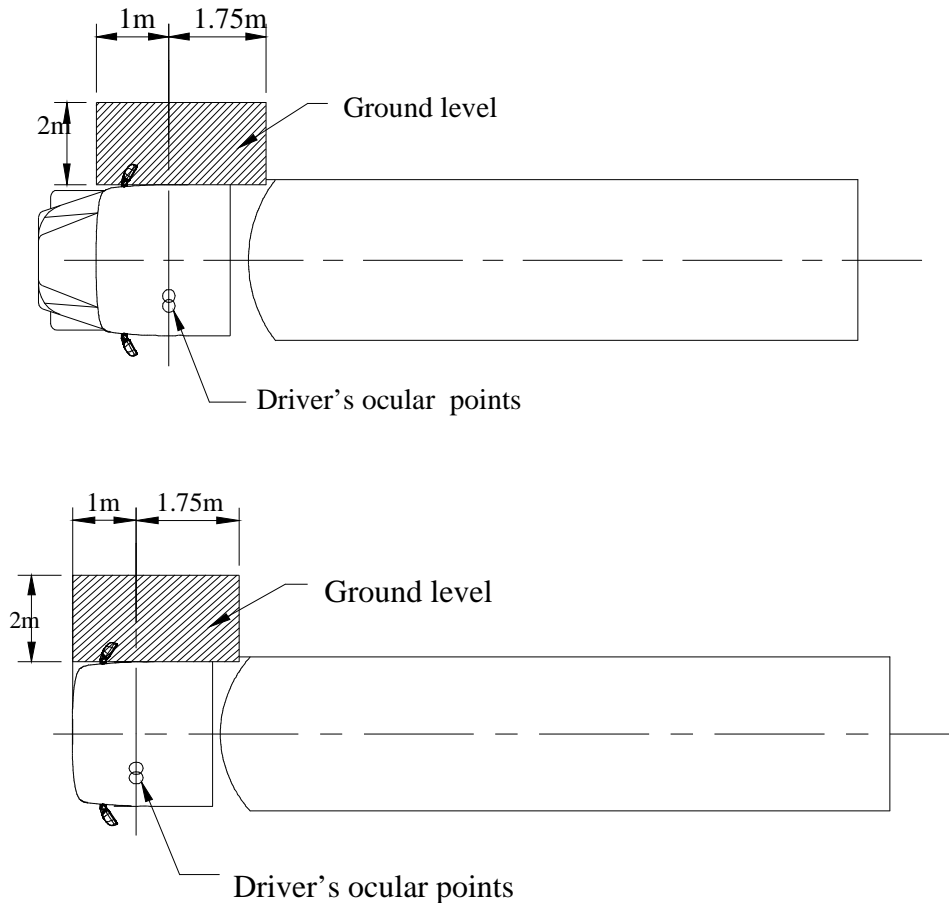

Figures 8a and 8b: Field of vision of Class V close-proximity ~~mirror~~ field of vision

Justification: Alignment of the text with the new definition of classes (para. 2.4).

40. Paragraph 15.2.4.6. to 15.2.4.6.2. , amend to read:

"15.2.4.6. ~~"Front" mirror~~ **Device for indirect vision of Class VI.** "

- 15.2.4.6.1. The field of vision shall be such that the driver can see at least a flat horizontal portion of the road, which is bounded by:
- a transverse vertical plane through the outermost point of the front of the vehicle,
  - a transverse vertical plane 2,000 mm in front of the plane defined in (a),
  - a longitudinal vertical plane parallel to the longitudinal vertical median plane going through the outermost side of the vehicle at the driver's side and,



- (d) a longitudinal vertical plane parallel to the longitudinal vertical median plane 2 000 mm outside the outermost side of the vehicle opposite to the driver's side.

The front of this field of vision opposite to the driver's side may be rounded off with a radius of 2 000 mm (see figure 9)".

For the defined field of vision, see also paragraph 15.2.4.9.2.

The provisions for **Class VI front view devices for indirect vision** ~~front mirrors~~ are compulsory for forward controlled (as defined in paragraph 12.5.) vehicles of categories  $N_2 > 7.5$  t and  $N_3$ .

If vehicles of these categories cannot fulfil the requirements by using a ~~front mirror or a camera/monitor device~~ **a device for indirect vision**, a vision support system shall be used. In the case of a vision support system this device must be able to detect an object of 500 mm height and with a diameter of 300 mm within the field defined in figure 9.

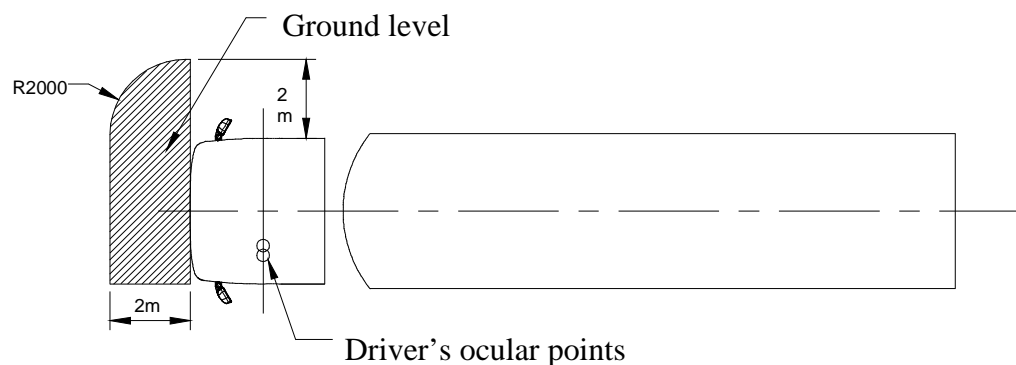

Figure 9: ~~Field of vision of Class VI front mirror~~ **Class VI front view field of vision**

- 15.2.4.6.2. However, if the driver can see, taking into account the obstructions by the A pillars, a straight line 300 mm in front of the vehicle at a height of 1,200 mm above the road surface and which is situated between a longitudinal vertical plane parallel to the longitudinal vertical median plane going through the outermost side of the vehicle at the driver's side and a longitudinal vertical plane parallel to the longitudinal vertical median plane 900 mm outside the outermost side of the vehicle opposite to the driver's side, a ~~front mirror~~ **Class VI front view device for indirect vision** ~~of Class VI~~ is not mandatory. "

Justification: Alignment of the text with the new definition of classes (para. 2.4).

41. Paragraph 15.2.4.7 to 15.2.4.7.2, amend to read:  
 "15.2.4.7. ~~L-category mirror~~ ~~(Class VII)~~. **Class VII main rear-view field of vision**

- 15.2.4.7.1. ~~Exterior~~ **Main rear-view field of vision** ~~mirror~~ on the driver's side

The field of vision must be such that the driver can see at least a 2.50 m wide, flat, horizontal portion of the road, which is bounded by a plane parallel to the median longitudinal vertical plane and passing through the outermost point of

the vehicle on the driver's side of the vehicle and extends from 10 m behind the driver's ocular points to the horizon (see Figure 10).

15.2.4.7.2. ~~Exterior~~ **Main rear-view field of vision mirror** on the passenger's side

The field of vision must be such that the driver can see at least a 4 m wide flat, horizontal portion of the road which is bounded by a plane parallel to the median longitudinal vertical plane passing through the outermost point of the vehicle on the passenger's side and which extends from 20 m behind the driver's ocular points to the horizon (see Figure 10).

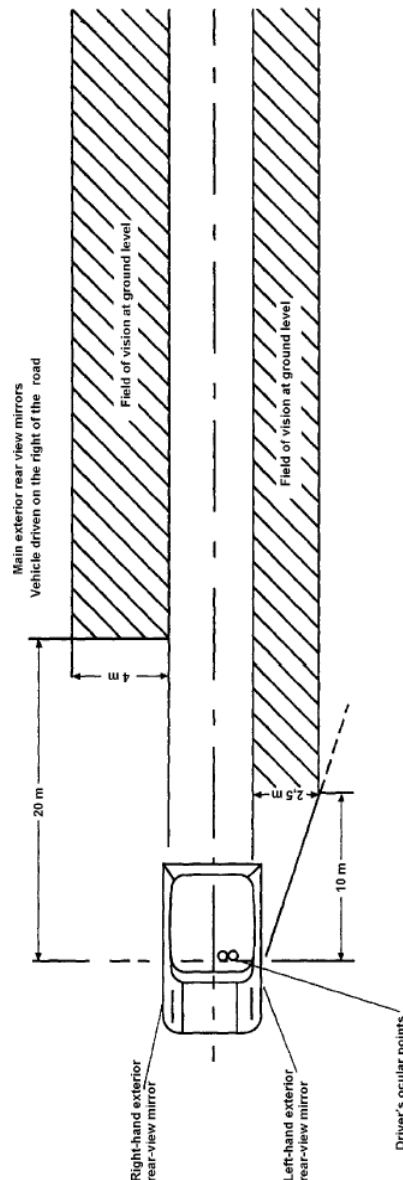

Figure 10: ~~Field of vision of Class VII~~ **field of vision mirrors**.

Justification: Alignment of the text with the new definition of classes (para. 2.4).

42. Paragraph 15.2.4.9.1. and 15.2.4.9.2, amend to read:

“15.2.4.9.1. Interior-**mounted Class I** rear-view **devices** ~~mirror (Class I)~~  
 The field of vision may be reduced by the presence of devices such as sun visors, windscreen wipers, heating elements and stop lamp of category S3, provided that all these devices together do not obscure more than 15 per cent of the prescribed field of vision. Headrests or framework or bodywork such as window columns of rear split doors, rear window frame shall be excluded from the calculation. This requirement shall be tested by projection on to a vertical plane at right angles to the longitudinal centreplane of the vehicle. The degree of obstruction shall be measured with the sun visors folded back.

15.2.4.9.2. Exterior ~~mirrors~~ **mounted devices for indirect vision** (Classes II, III, IV, V and VI).

In the fields of vision specified above, obstruction due to the bodywork and its components, such as other cab mirrors, door handles, outline marker lights, direction indicators and front and rear bumpers, as well as reflective-surface cleaning components, shall not be taken into account if they are responsible for a total obstruction of less than 10 per cent of the specified field of vision. In the case of a vehicle designed and constructed for special purposes where, due to its special features, it is not possible to meet this requirement, the obstruction of the required field of vision of a Class VI ~~mirror~~ **device for indirect vision** caused by the special features may be more than 10 per cent but not more than necessary for its special function.”

Justification: The text has been amended so that the provisions are related to where they are fitted, in the interior or to the exterior.

43. Paragraph 15.3.4. amend to read:

15.3.4 Installation requirements for the monitor

~~The viewing direction of the monitor shall roughly be the same direction as the one for the main mirror.~~ **Monitor(s) shall be located in an ergonomically favourable position.**

Justification: For following the Human Machine Interaction (HMI) principles giving a certain direction in this and preventing design restrictive provisions.

44. Paragraph 15.3.6, replace the reference to paragraph 2.1.2.13 by a reference to paragraph 2.3.

Justification: consequence of the renumbering of the definitions of paragraph 2.

45. Paragraph 21 shall be replaced by the following paragraph 21

21. TRANSITIONAL PROVISIONS

- 21.1. As from the official date of entry into force of the 04 series of amendments to this Regulation, no Contracting Party applying this Regulation shall refuse to grant approval under this Regulation as amended by the 04 series of amendments.
- 21.2. As from [12 months after entry into force of the 04 series of amendments to this regulation], Contracting Parties applying this Regulation shall grant approvals to a type of devices for indirect vision only if the type meets the requirements of this Regulation as amended by the 04 series of amendments.
- 21.3. As from [18 months after entry into force of the 04 series of amendments to this regulation], Contracting Parties applying this Regulation shall grant approvals to a type of vehicle with regard to the installation of devices for indirect vision only if the type of vehicle meets the requirements of this Regulation as amended by the 04 series of amendments.
- 21.4. As from 26 January 2010 for vehicles of category M1 and N1 and from 26 January 2007 for vehicles of other categories, Contracting Parties applying this Regulation may refuse to recognize approvals of a device for indirect vision which have not been granted in accordance with the 02 series of amendments to this Regulation.
- 21.5. Approvals which were granted to devices for indirect vision of Classes I or III pursuant to this Regulation in its original form (00 series) or modified by the 01 or 02 or 03 series of amendments before the date of entry into force of this series of amendments shall remain valid.
- 21.6. Approvals which were granted to devices for indirect vision of Classes II, IV, V, VI or VII pursuant to this Regulation as modified by the 02 or 03 series of amendments before the date of entry into force of this series of amendments shall remain valid.
- 21.7. The provisions of this Regulation shall not prohibit the approval of a type of vehicle with regard to the mounting of devices for indirect vision pursuant to this Regulation as modified by the 04 series of amendments, if all or part of the devices for indirect vision of Classes I or III, with which it is fitted, bear the approval mark prescribed by this Regulation in its original form (00 series) or modified by the 01, 02 or 03 series of amendments .
- 21.8. The provisions of this Regulation shall not prohibit the approval of a type of vehicle with regard to the mounting of devices for indirect vision pursuant to this Regulation as modified by the 04 series of amendments, if all or part of the rear-view mirrors of Classes II, IV, V, VI or VII, with which it is fitted, bear the approval mark prescribed by the 02 or 03 series of amendments of this Regulation.
- 21.9. Notwithstanding the provisions of paragraphs 21.2 and 21.5. above, for the purpose of replacement parts Contracting Parties applying this Regulation shall continue to grant approvals according to the 01 series of amendments to this Regulation, to devices for indirect vision of classes I to V and VII for use on vehicle types which have been approved before 26 January 2006 pursuant to the 01 series of amendments of Regulation No. 46 and to devices for indirect vision of class VI for use on vehicles which have been approved before 26 January 2007 pursuant to the 01 series of

amendments of Regulation No. 46, and, where applicable, subsequent extensions to these approvals.

- 21.10. Notwithstanding the provisions of paragraphs 21.2. and 21.4. above, for the purpose of replacement parts Contracting Parties applying this Regulation shall continue to grant approvals according 02 and 03 series of amendments to this Regulation, to devices for indirect vision for use on vehicle types which have been approved before the date mentioned in paragraph 21.2 pursuant to the 02 or 03 series of amendments of Regulation No. 46, and, where applicable, subsequent extensions to these approvals.
- 21.11. Notwithstanding the transitional provisions above, this 04 series of amendments to Regulation 46 shall become applicable to camera-monitor devices for indirect vision of classes I to IV and VII as soon as the ISO-standard mentioned in paragraph 6.2.2.2.5 has been approved by ISO and adopted by WP.29.

Justification: These transitional provisions aim:

1. To regulate the acceptance of type approvals which are granted according the 04 series of amendments to regulation 46 as from the date of entry into force;
2. to mandate the new provisions after 12 months for new system approvals;
3. to mandate the new provisions for new installations as from 18 months after the entry into force;
4. to continue the present options for contracting parties to refuse approvals that are not approved according the 02 series of amendments
5. to keep present approvals that are not subject to new provisions valid
6. to permit the approval of new installations which are based on present approvals that are not subject to new provisions
7. to permit under certain conditions new approvals for replacement parts on the basis for previous series of amendments and
8. to clarify that for certain classes of camera-monitor systems the 04 series of amendments can only be applied after ISO has developed the relevant standard and WP.29 has adopted that standard.

46. Annex 3, replace the reference to paragraph 6.1.3.1.1. by a reference to paragraph 6.3.1.1.

Justification: consequence of the renumbering of former paragraph 6.1.3

47. Annex 7, point 1.2.2., replace the reference to paragraph 2.1.1.6. by a reference to paragraph 2.1.1.5.

Justification: consequence of the renumbering of the definitions of paragraph 2.

-----