

**Informal Group on GTR9 Phase2
(IG GTR9-PH2)
1st Meeting**

Technical Discussion - Biofidelity

December 1-2, 2011

Japan Automobile Standards Internationalization Center (JASIC)¹

Outline

1. Pedestrian Lower Limb
2. TRL legform
3. Flex-PLI
4. Comparison of Component Responses
5. Correlation of Assembly Impact Responses
6. Determinants of Tibia Fracture Measures
7. Tibia Fracture Prediction for Different Bumper Structure
8. Summary

1. Pedestrian Lower Limb

- Leg -

Response & Injured Locations

Response

Long bones are bent during a car impact

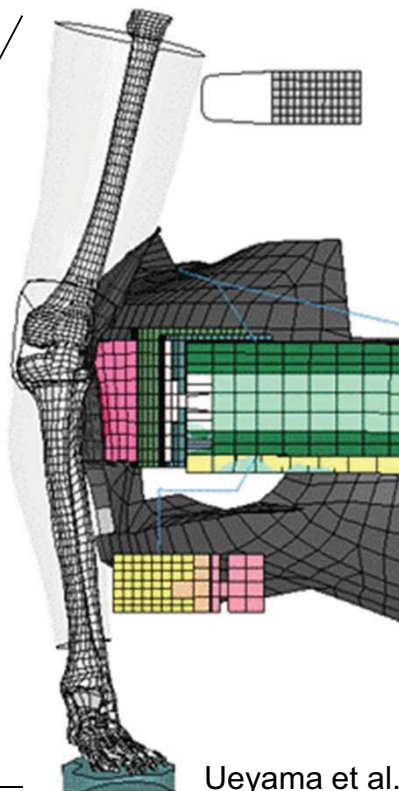
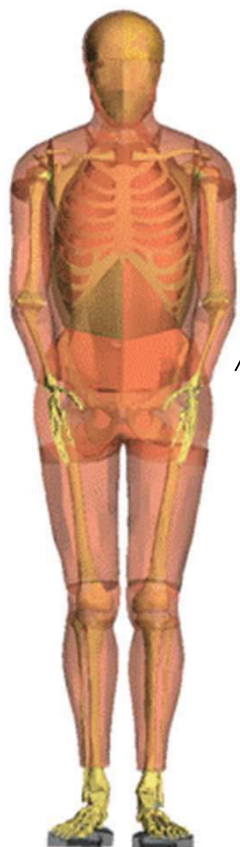

Ueyama et al. (2011)

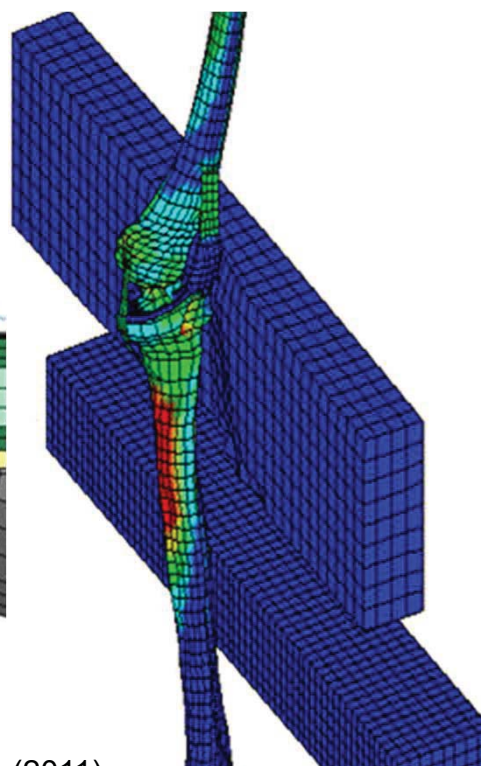

Injured Locations

Tibia fracture occurs at multiple locations

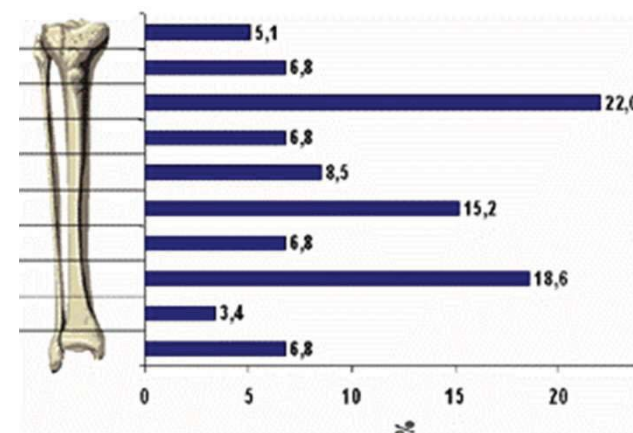

**Real-world
Accident Analysis**
Otte et al. (2007)

Reference: Ueyama T., Kikuchi Y., Mizuno K., Nakano D., Wanami S., Comparison of Response of FLEX and TRL Legform Impactor in Pedestrian Test, JSAE Transaction, Vol.42, No.5, Paper Number 20114668 (2011) (in Japanese)

Otte, D., Haasper, C., Characteristics on Fractures of Tibia and Fibula in Car Impacts to Pedestrians – Influences of Car Bumper Height and Shape, IRCOBI Conference (2007)

1. Pedestrian Lower Limb

- Knee Ligaments -

(Anterior-oblique view)

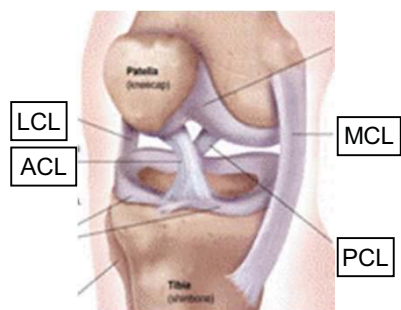

Otte et al. (2005)

MCL: Medial Collateral Ligament
 ACL: Anterior Cruciate Ligament
 PCL: Posterior Cruciate Ligament
 LCL: Lateral Collateral Ligament

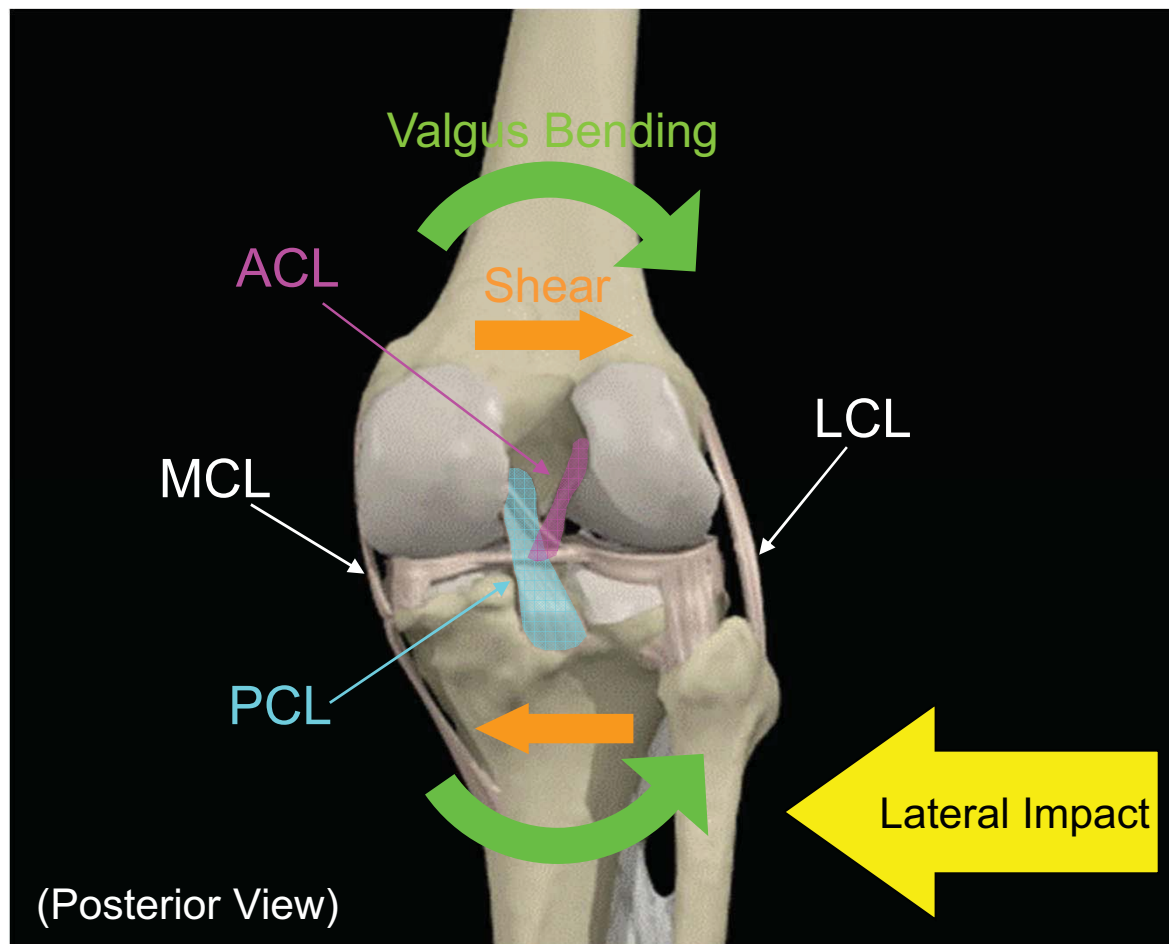

(Posterior View)

Knee ligaments can be tensed in both shear and bending

1. Pedestrian Lower Limb

- Knee Ligaments -

Takahashi et al., 2001

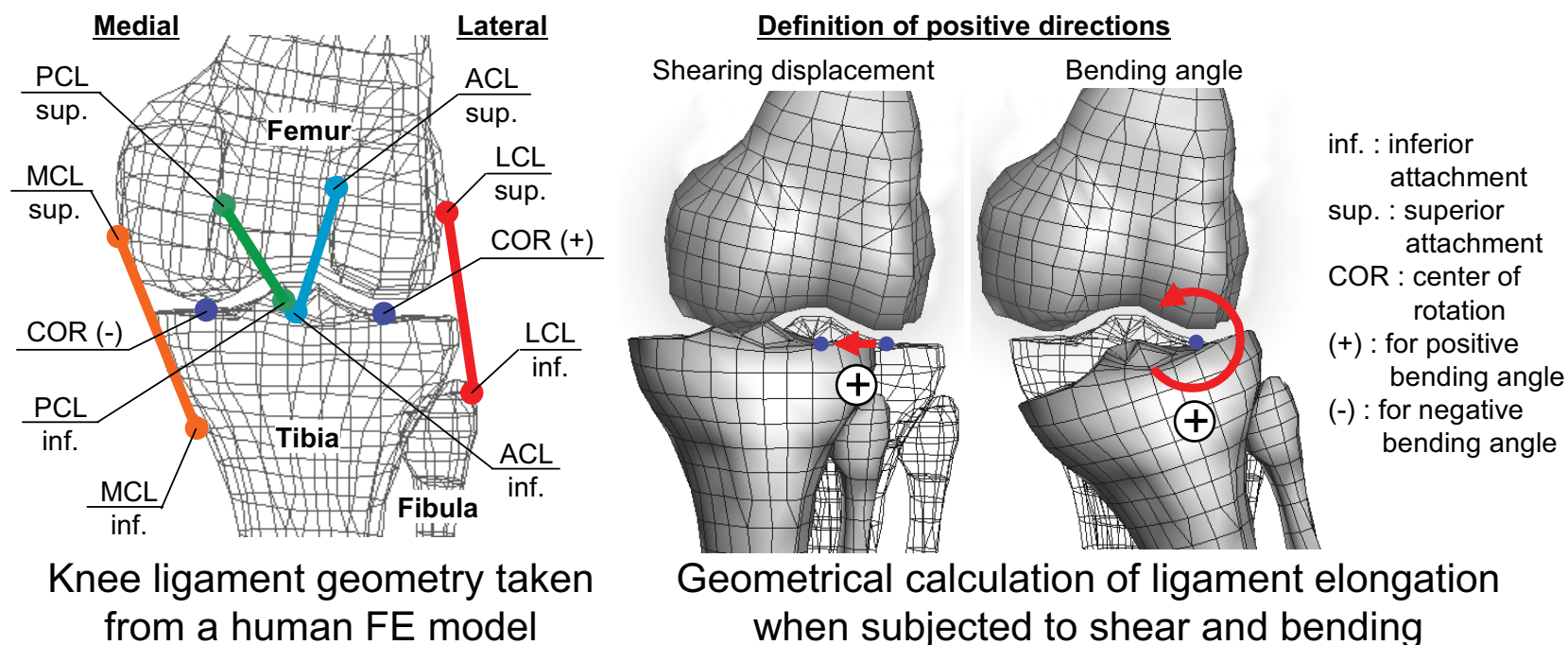

Geometrical analysis of knee ligament failure criteria when knee joint is subjected to combined lateral shear and valgus bending

1. Pedestrian Lower Limb

- Knee Ligaments -

Takahashi et al., 2001

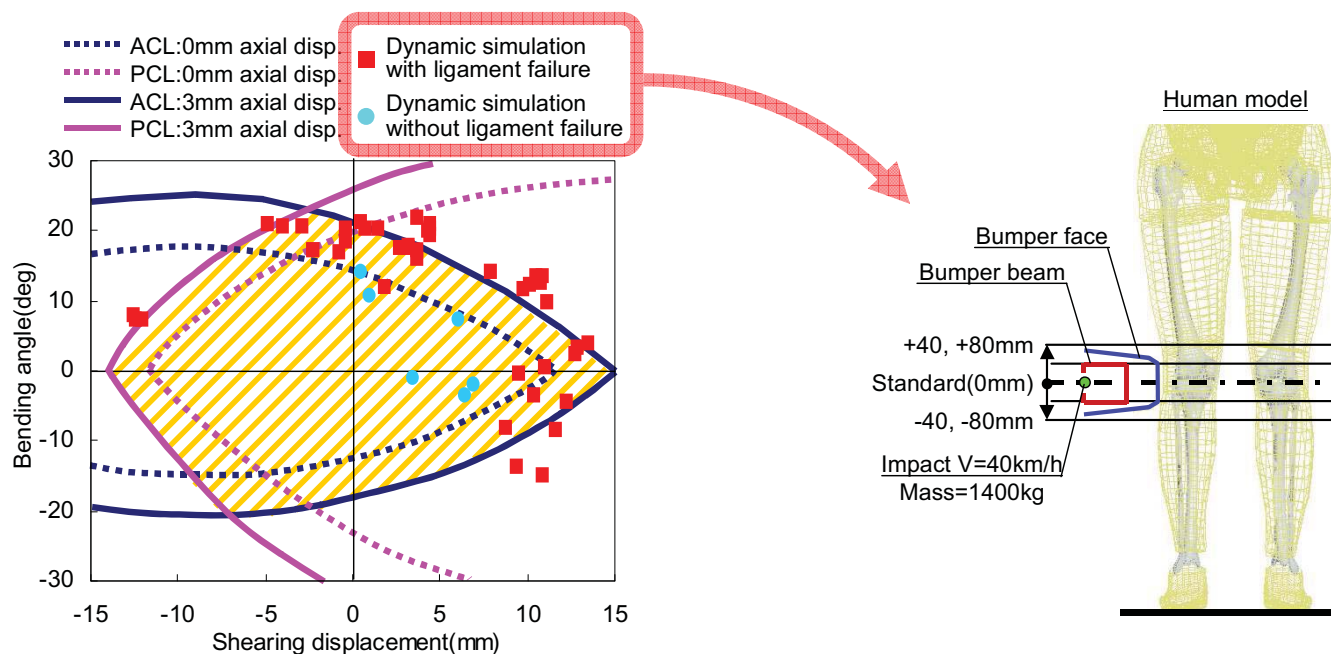

Injury limits based on strain criteria from a human FE model

- Impact simulations using a human FE model
- Shear disp. and Bend ang. @ ligament failure

- Ligaments elongate due to combined shear and bending
- Separate shear and bending criteria would not represent knee ligament failure mechanism

Reference: Takahashi Y., Kikuchi Y., Biofidelity of Test Devices and Validity of Injury Criteria for Evaluating Knee Injuries to Pedestrians, 17th ESV Conference, Paper Number 373 (2001)

2. TRL Legform

- Leg -

Response & Injury Criterion

Structure

Rigid Long bones

Main unit



Response

Long bones are not bent during a Car Impact

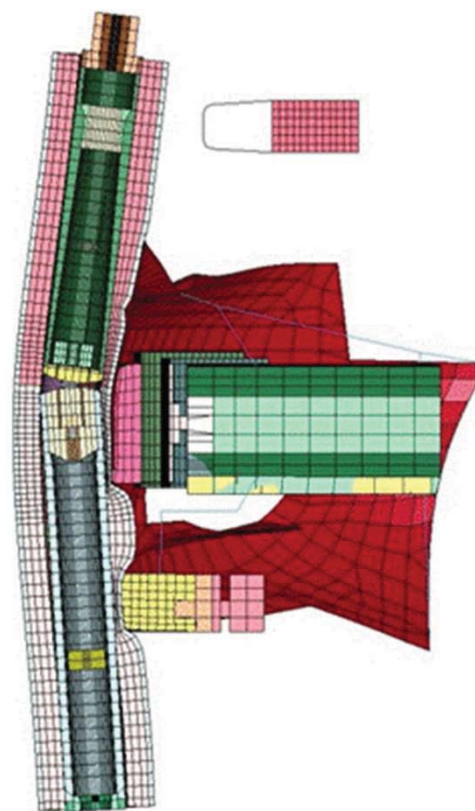

Ueyama et al. (2011)

Injury Criterion

Upper Tibia Acceleration

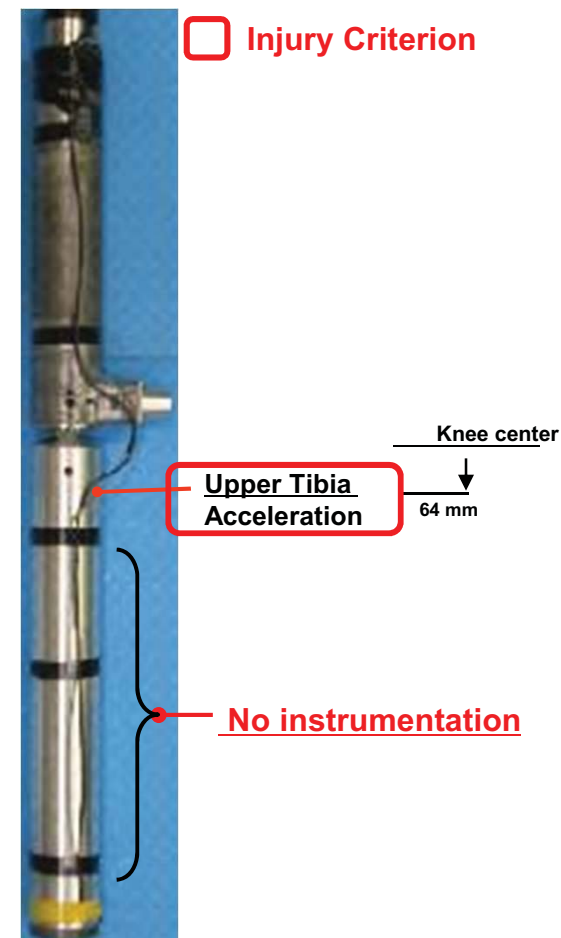

2. TRL Legform

- Knee Ligaments -

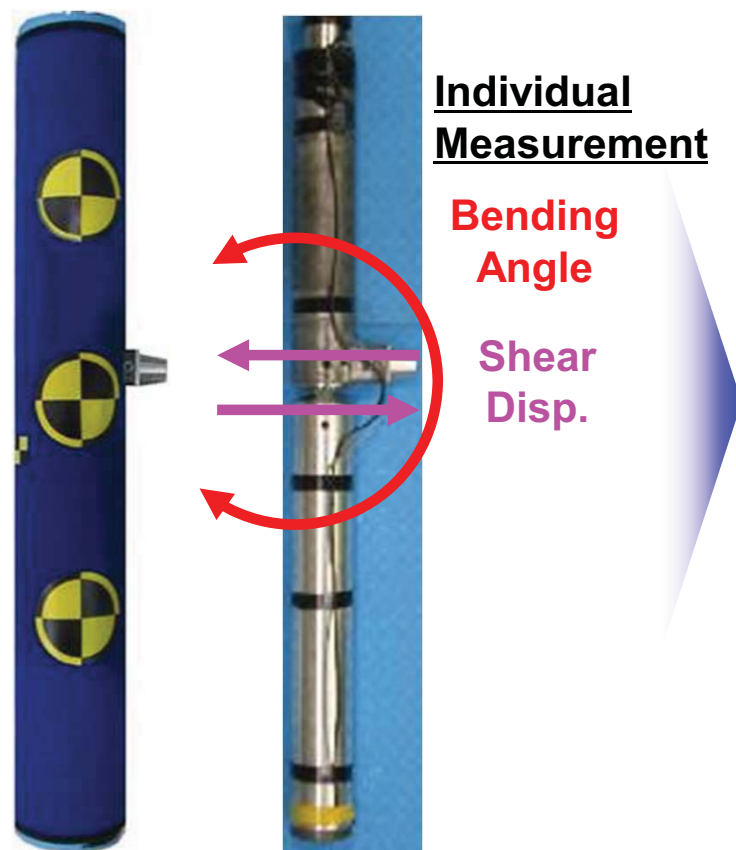

Individual measurement of shear displacement and bending angle

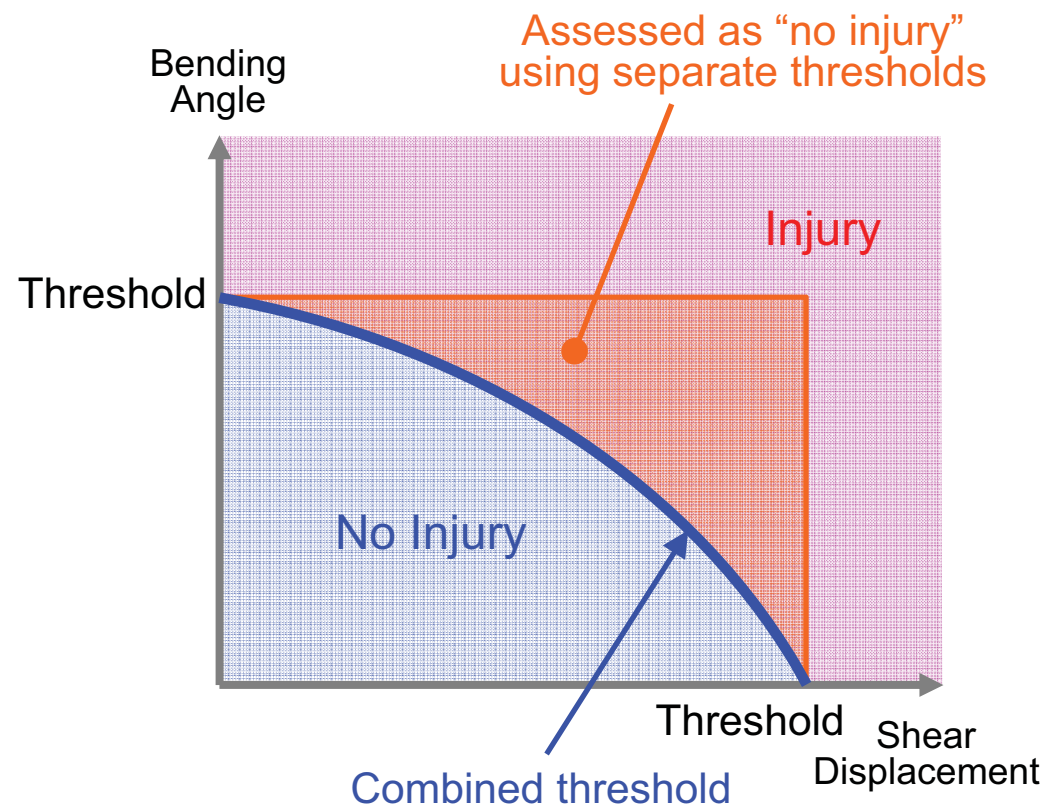

Separate thresholds may lead to inaccurate assessment of injury probability

2. TRL Legform

- Knee Ligaments -

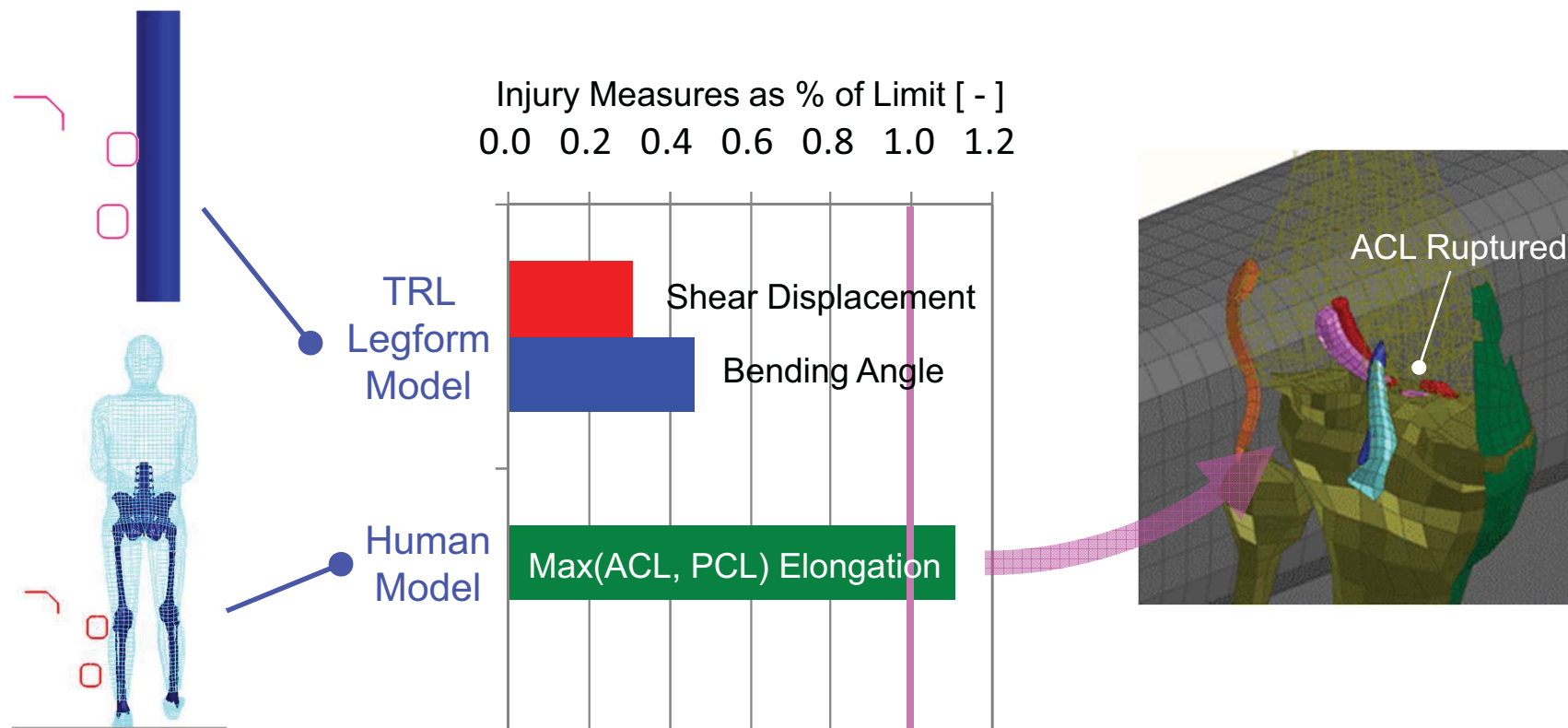

Vehicle model : Simplified vehicle model (S4) with modified bumper stiffness

Knee ligaments (especially cruciate ligaments) may fail even if separate injury measures are below thresholds

3. Flex-PLI

- Leg -

Structure
Flexible Long Bones

Response
Long bones are bent during a Car Impact

Injury Criteria
Bending Moment at Tibia

Main unit



Femur
✓ Flexible as well as human one

Tibia
✓ Flexible as well as human one

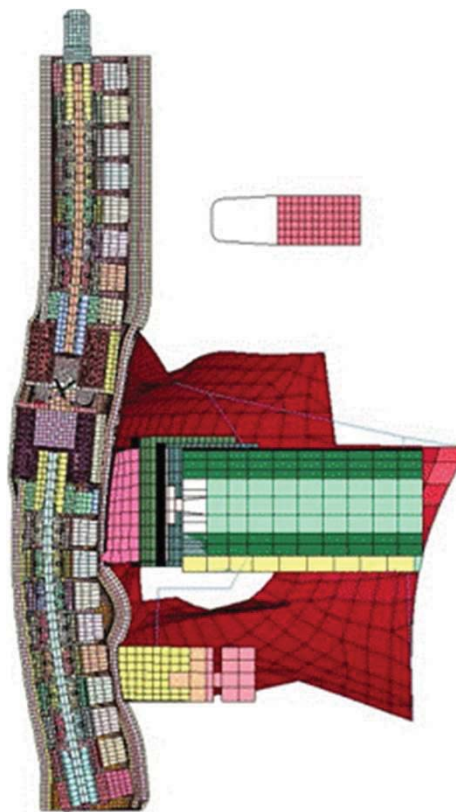

Ueyama et al. (2011)

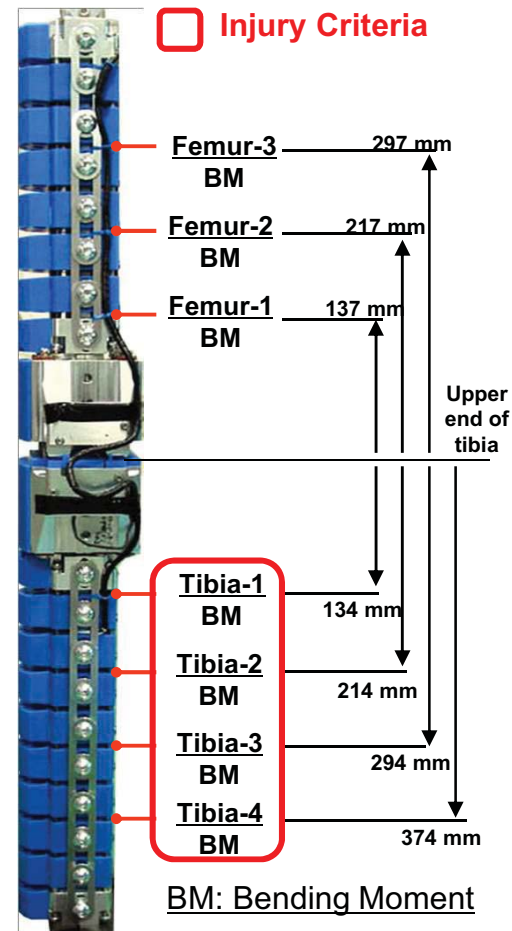

3. Flex-PLI

- Knee Ligaments -

Structure Knee

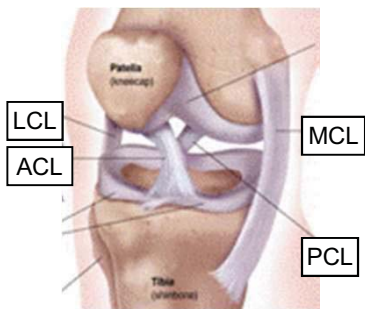

Otte et al. (2005)

Knee Ligaments
 ✓ **restraint as well as human one**

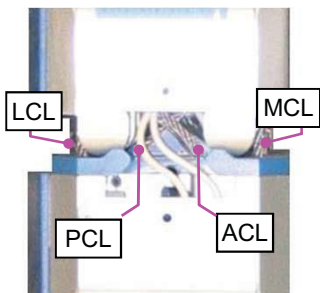

MCL: Medial Collateral Ligament
 ACL: Anterior Cruciate Ligament
 PCL: Posterior Cruciate Ligament
 LCL: Lateral Collateral Ligament



Response Knee ligaments are elongated by bending and shearing force

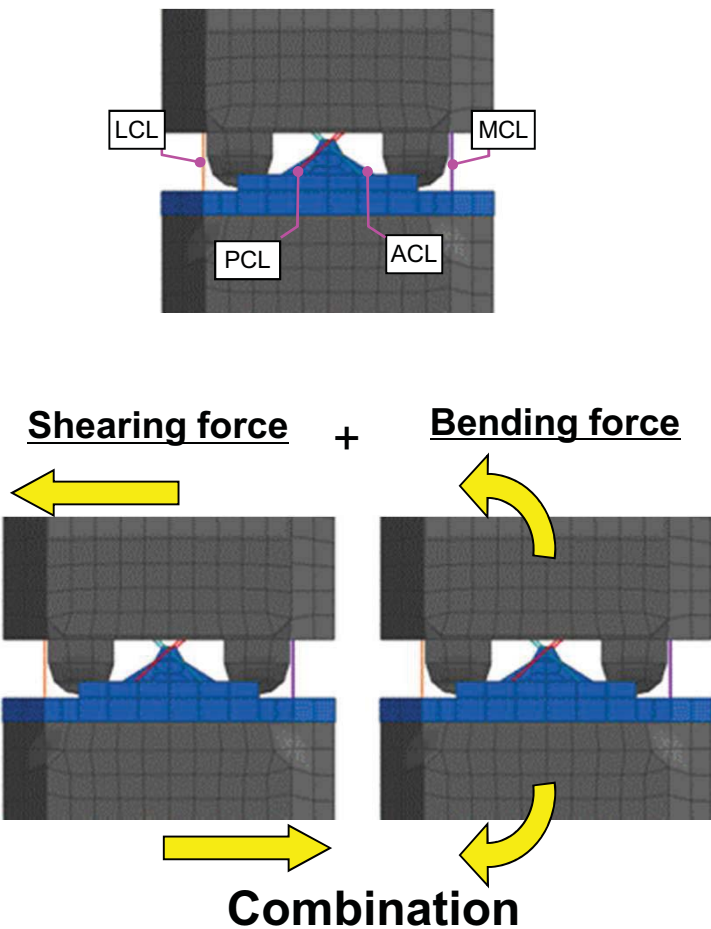

Injury Criteria Knee Ligaments Elongations

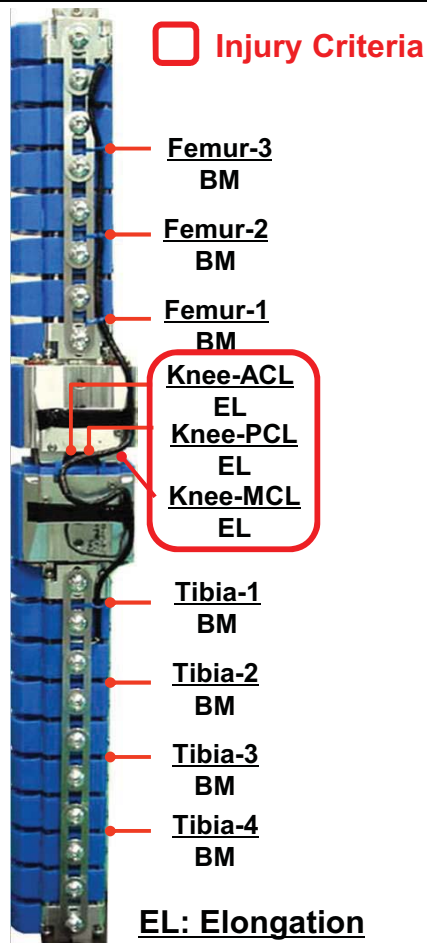

4. Comparison of Component Responses

- Tibia Bending -

TEG-021

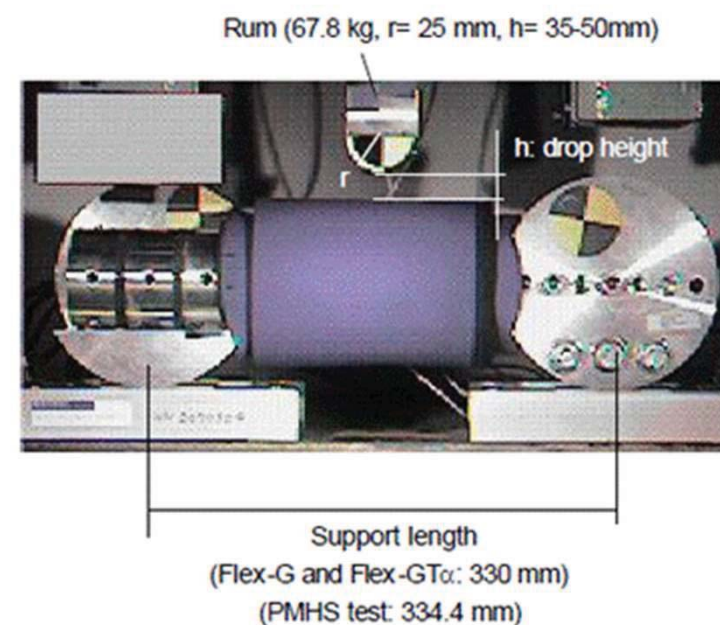
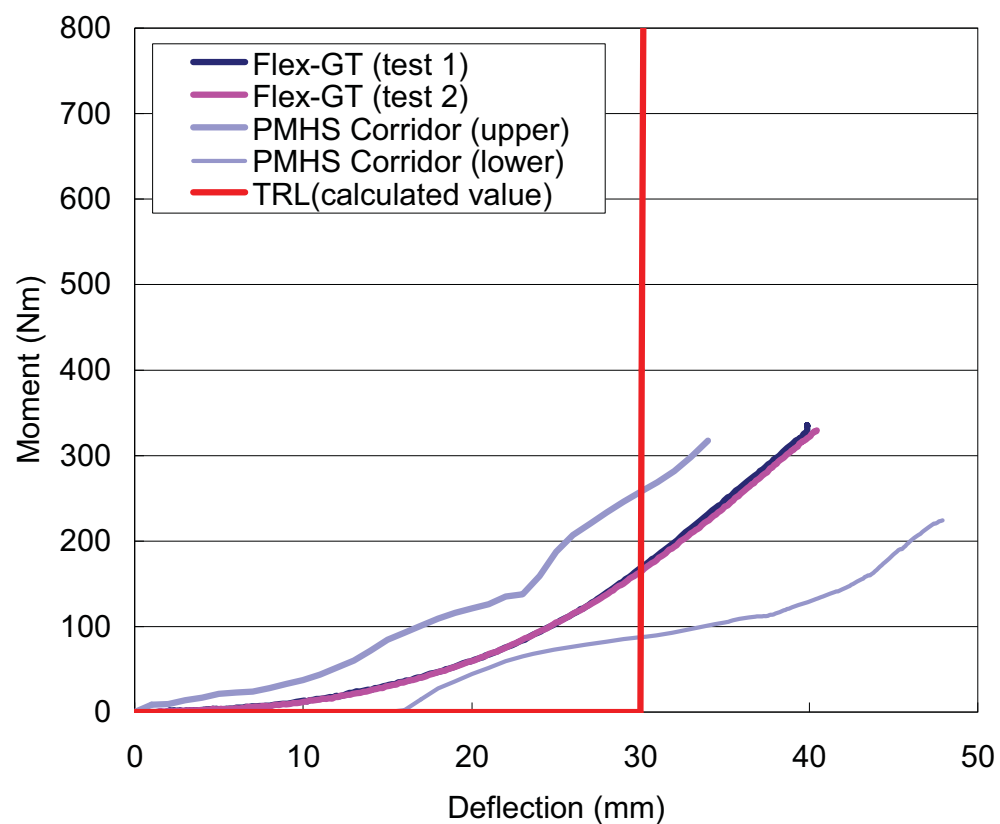

Flex-PLI tibia response characteristics are much closer to those of human compared to TRL legform

4. Comparison of Component Responses

- Knee Bending -

TEG-021

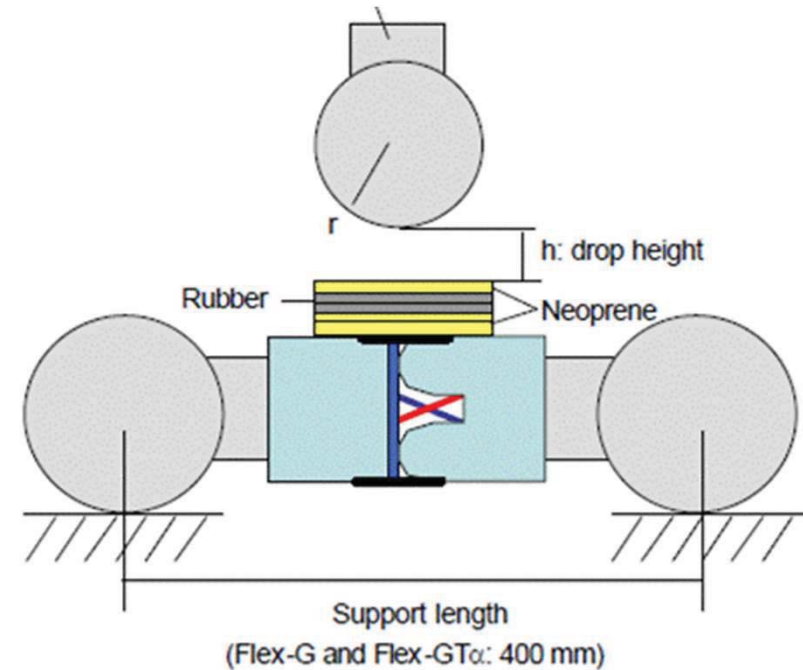
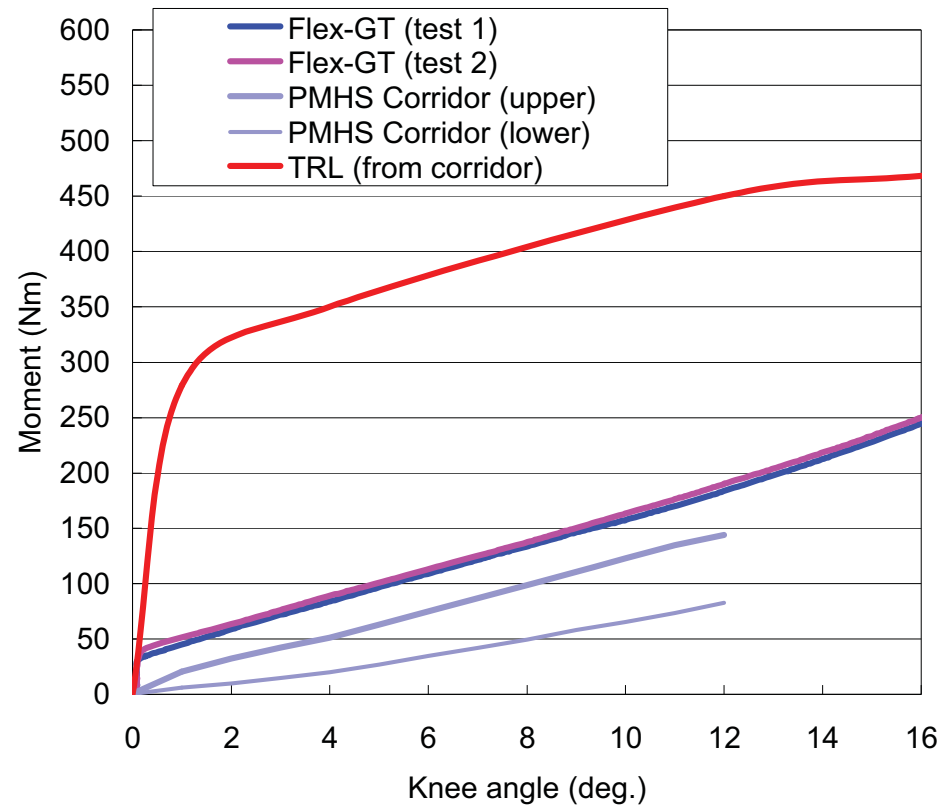

- Flex-PLI knee joint is stiffer than that of human
- Flex-PLI stiffness is much more comparable to human stiffness than TRL legform

5. Correlation of Assembly Impact Responses

- CAE Correlation Study -
Human FE Model

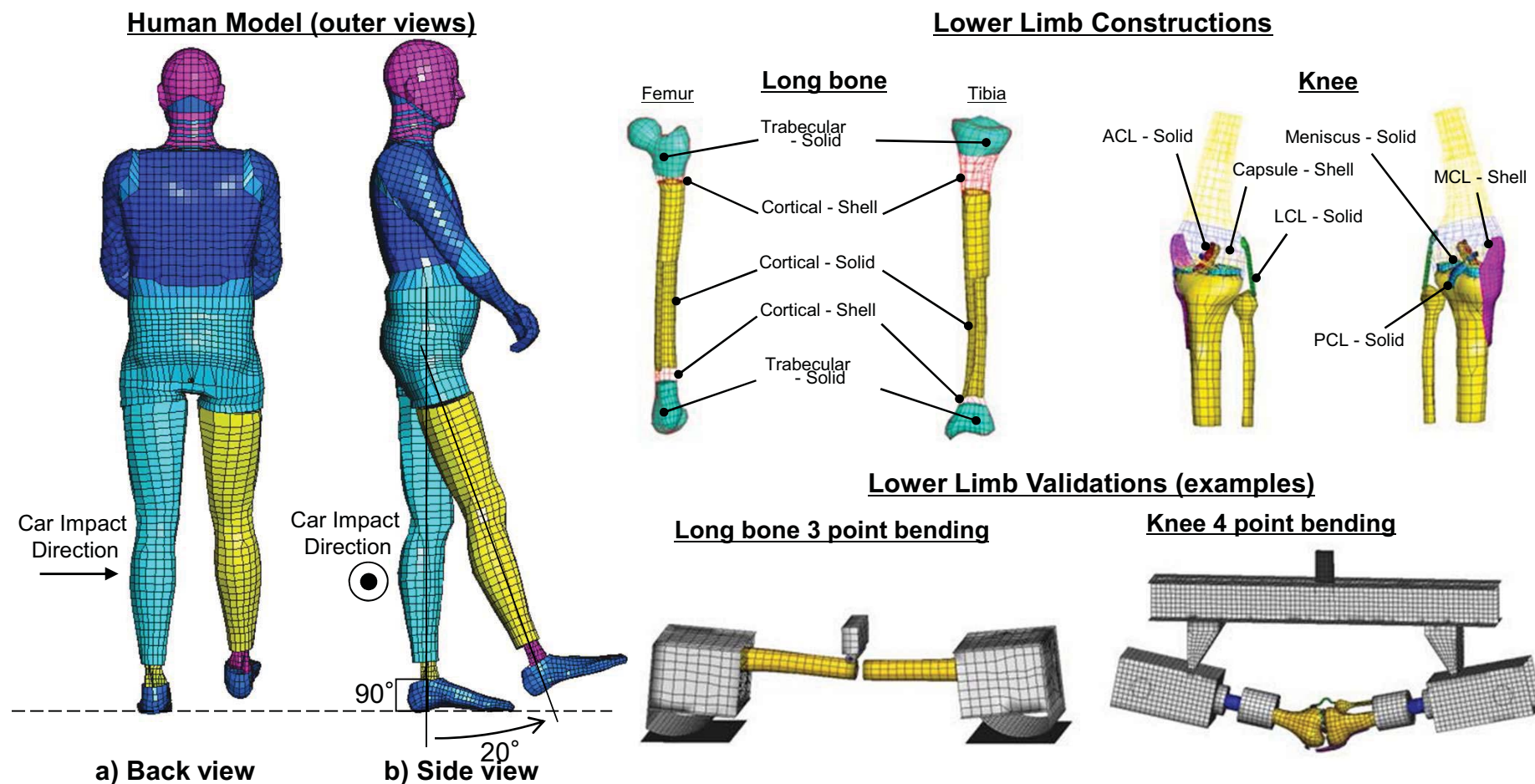

References:

- Takahashi, Y. et al. : Advanced FE Lower Limb Model for Pedestrians, 18th ESV, Paper Number 218 (2003)
- Kikuchi, Y. et al. : Development of a Finite Element Model for a Pedestrian Pelvis and Lower Limb, SAE paper 2006-01-0683 (2006)
- Kikuchi, Y. et al. : Full-Scale Validation of a Human FE Model for the Pelvis and Lower Limb of a Pedestrian, SAE Paper 2008-01-1243 (2008)

5. Correlation of Assembly Impact Responses

- CAE Correlation Study -
TRL Legform Model

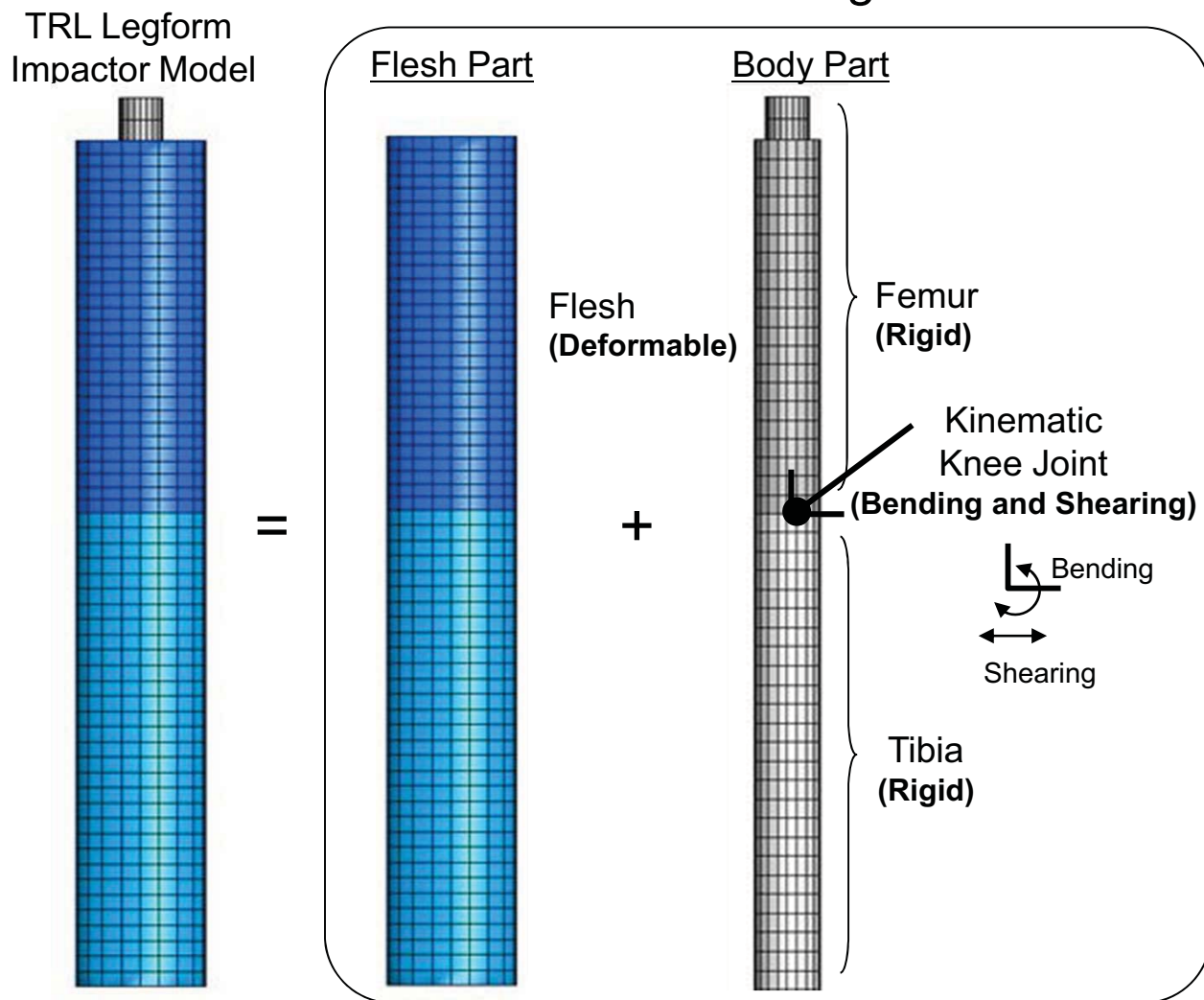

Knee Shearing Characteristics

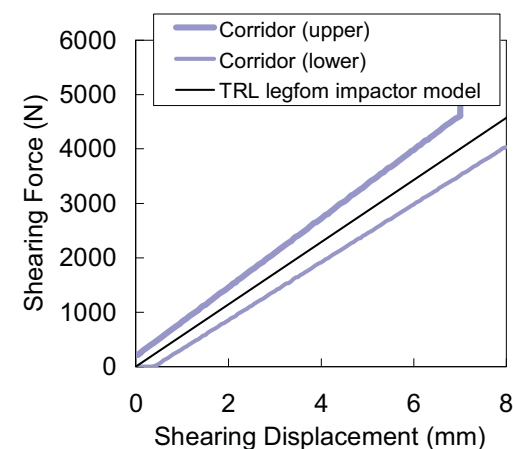

Knee Bending Characteristics

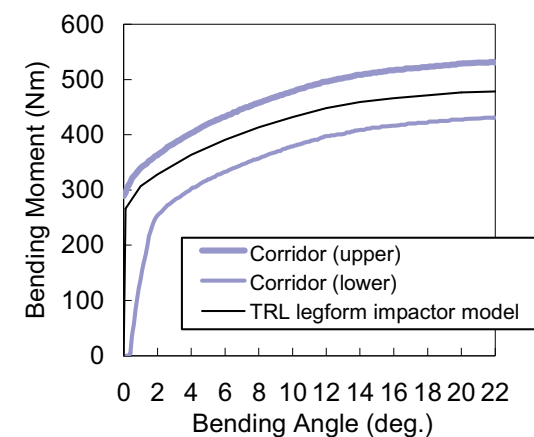

Reference : Konosu, A. et al., Evaluation of the Validity of the Tibia Fracture Assessment Using the Upper Tibia Acceleration Employed in the TRL Legform Impactor, IRCOBI Conference (2009)

5. Correlation of Assembly Impact Responses

- CAE Correlation Study -
Flex-PLI Model

TEG-096

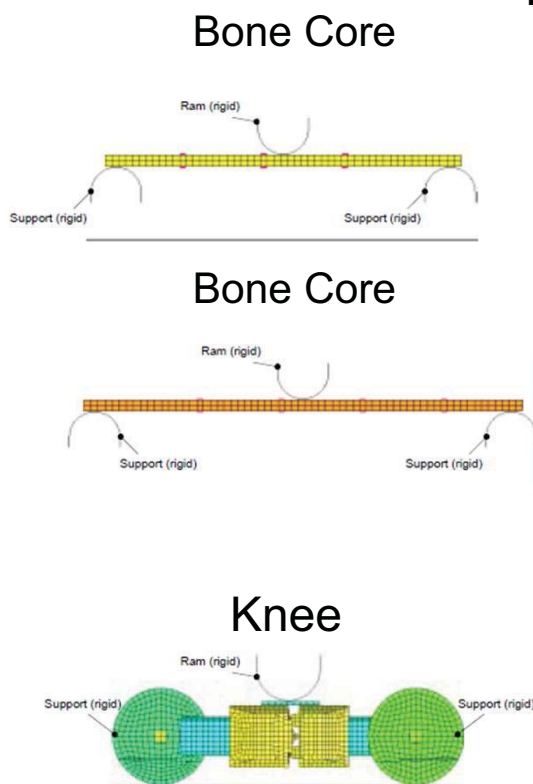
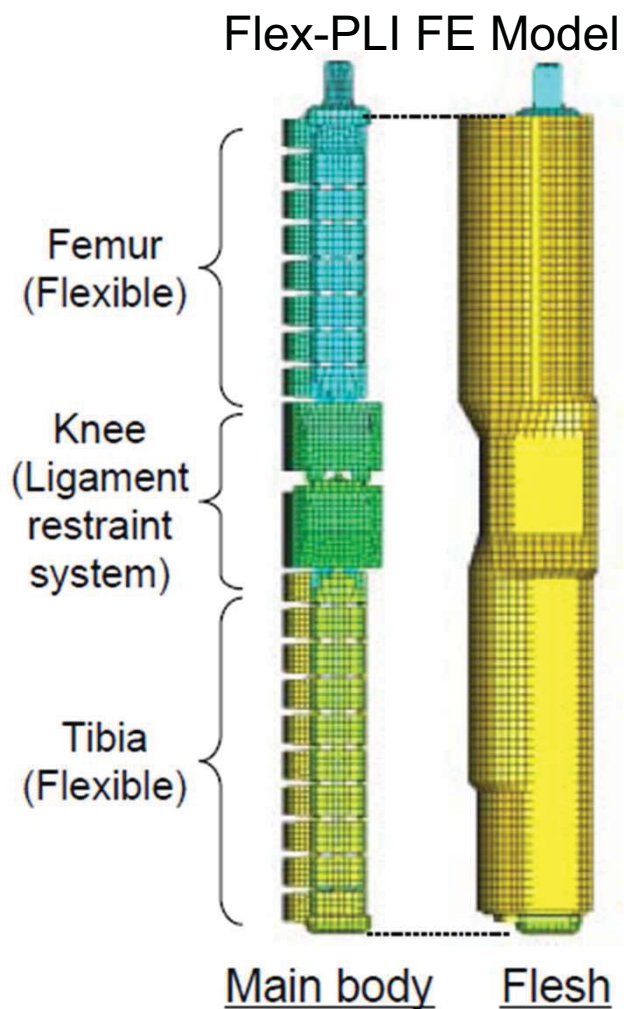

Femur

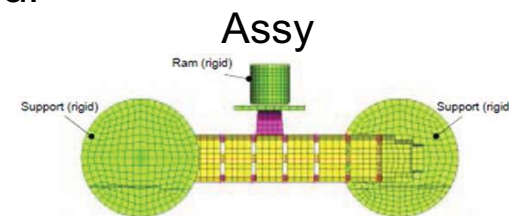

Tibia

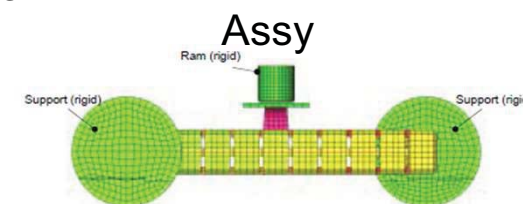

Simplified Vehicle Impact

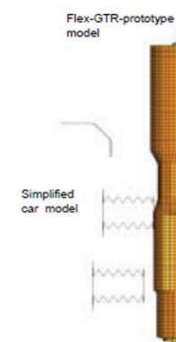

5. Correlation of Assembly Impact Responses

- CAE Correlation Study -
Simplified Vehicle Models

TEG-032

Simplified Vehicle Model

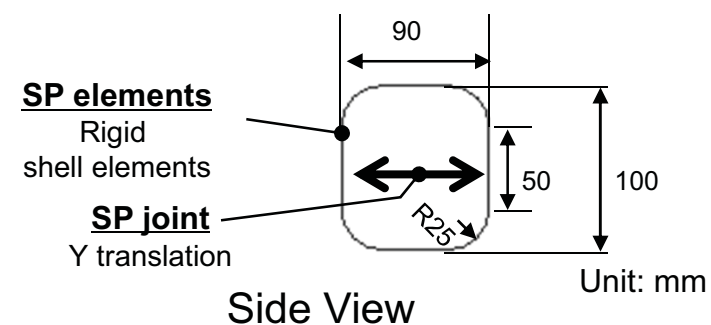
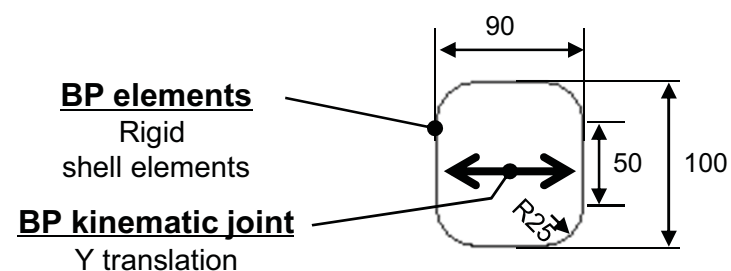
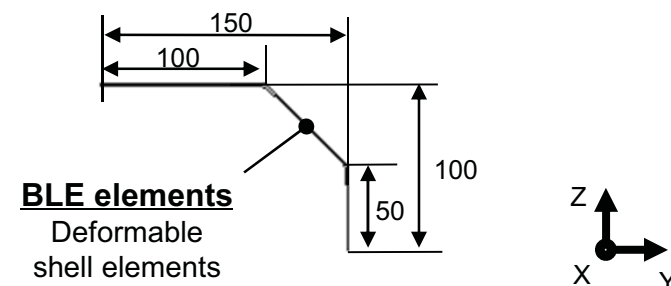
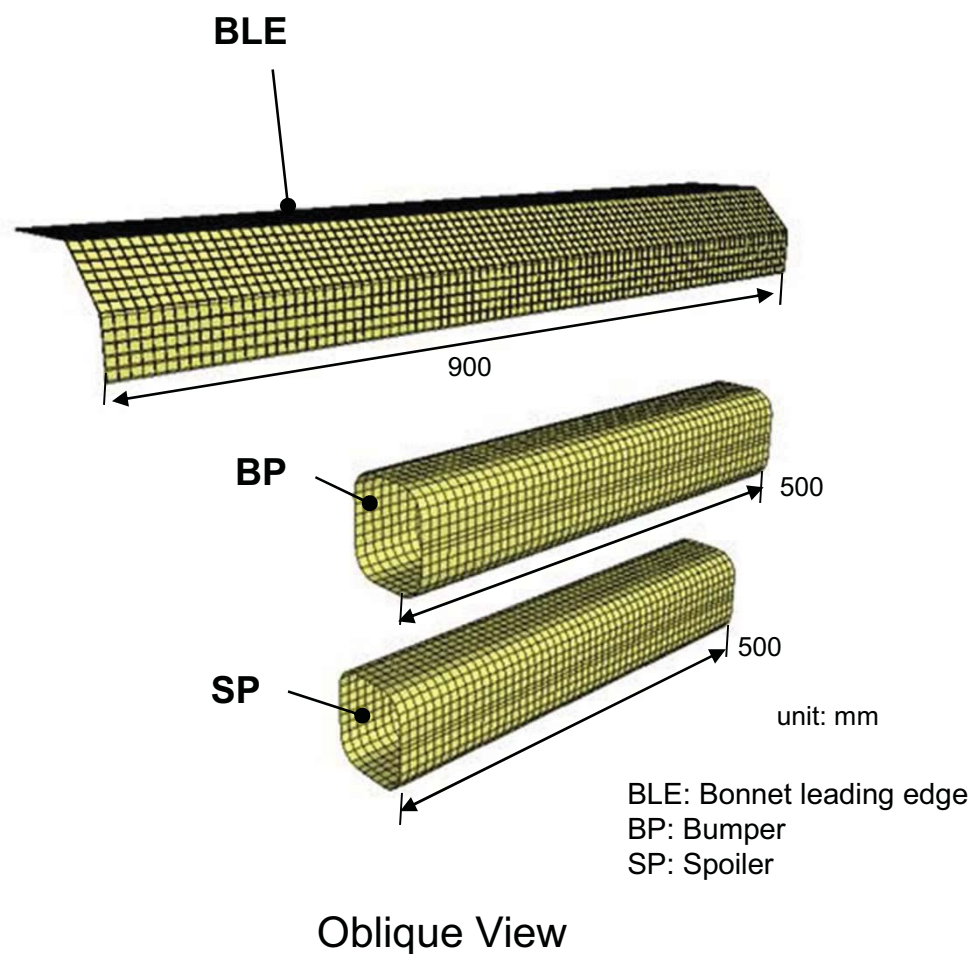

5. Correlation of Assembly Impact Responses

- CAE Correlation Study -
Simplified Vehicle Models

TEG-032

Stiffness Characteristics of
BP and SP Joints

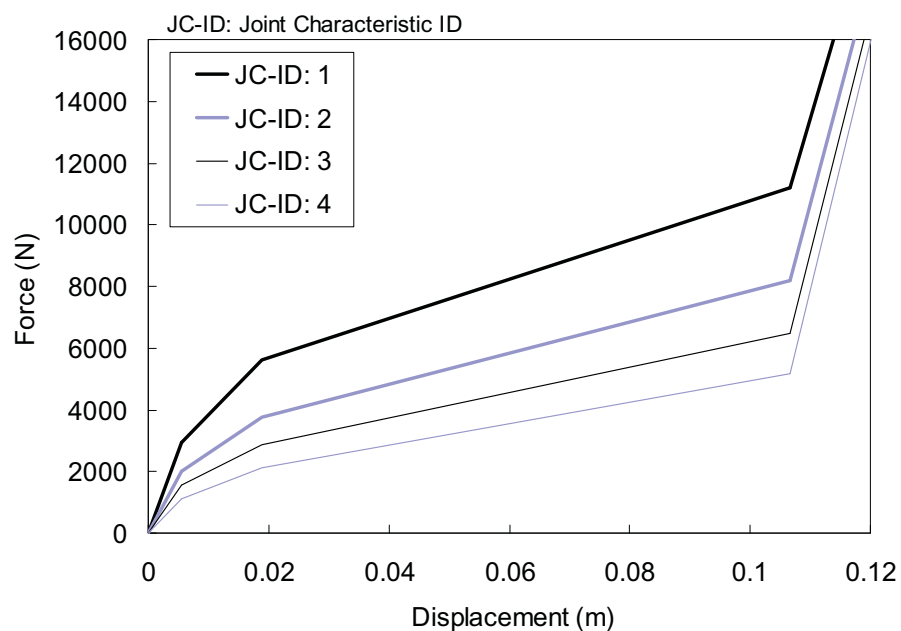

Definitions of Dimensions
(H1, H2, H3, L1, L2)

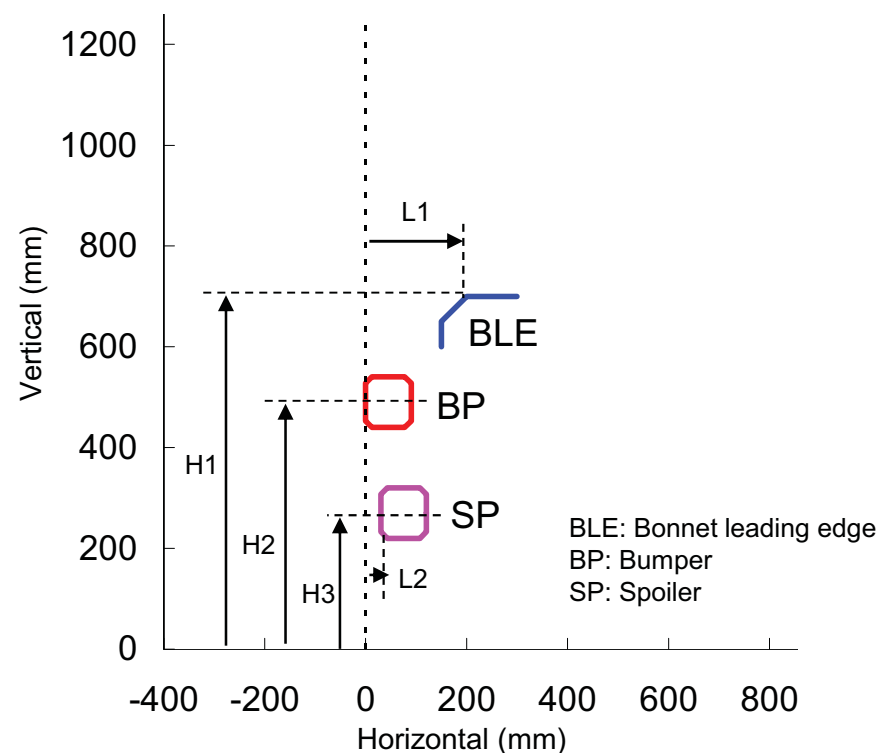

5. Correlation of Assembly Impact Responses

- CAE Correlation Study -
Simplified Vehicle Models

TEG-032

Setting Parameters

Parameter	Unit	Level 1	Level 2	Level 3
K1 (BLE stiffness*)	mm	0.4	0.6	
K2 (BP stiffness**)	JC***	0.7	0.8	1.0
K3 (SP stiffness**)	JC***	0.6	0.8	1.0
H1 (BLE height)	mm	650	700	750
H2 (BP height)	mm	450	490	530
H3 (SP height)	mm	250	270	350
L1 (BLE lead)	mm	125	200	275
L2 (SP lead)	mm	-20	0	30

Design of Experiment Method
(L18 orthogonal table)

Simulation No.	A K1 (BLE stiffness*) mm	B K2 (BP stiffness**)	C K3 (SP stiffness**)	D H1 (BLE height) mm	E H2 (BP height) mm	F H3 (SP height) mm	G L1 (BLE lead) mm	H L2 (SP lead) mm
S1	0.4	0.7	0.6	650	450	250	125	-20
S2	0.4	0.7	0.8	700	490	270	200	0
S3	0.4	0.7	1.0	750	530	350	275	30
S4	0.4	0.8	0.6	650	490	270	275	30
S5	0.4	0.8	0.8	700	530	350	125	-20
S6	0.4	0.8	1.0	750	450	250	200	0
S7	0.4	1.0	0.6	700	450	350	200	30
S8	0.4	1.0	0.8	750	490	250	275	-20
S9	0.4	1.0	1.0	650	530	270	125	0
S10	0.6	0.7	0.6	750	530	270	200	-20
S11	0.6	0.7	0.8	650	450	350	275	0
S12	0.6	0.7	1.0	700	490	250	125	30
S13	0.6	0.8	0.6	700	530	250	275	0
S14	0.6	0.8	0.8	750	450	270	125	30
S15	0.6	0.8	1.0	650	490	350	200	-20
S16	0.6	1.0	0.6	750	490	350	125	0
S17	0.6	1.0	0.8	650	530	250	200	30
S18	0.6	1.0	1.0	700	450	270	275	-20

* Stiffness is changed by steel plate thickness.

** Stiffness is changed by joint stiffness.

5. Correlation of Assembly Impact Responses

- CAE Correlation Study -

TEG-096

(modified to include
TRL legform)

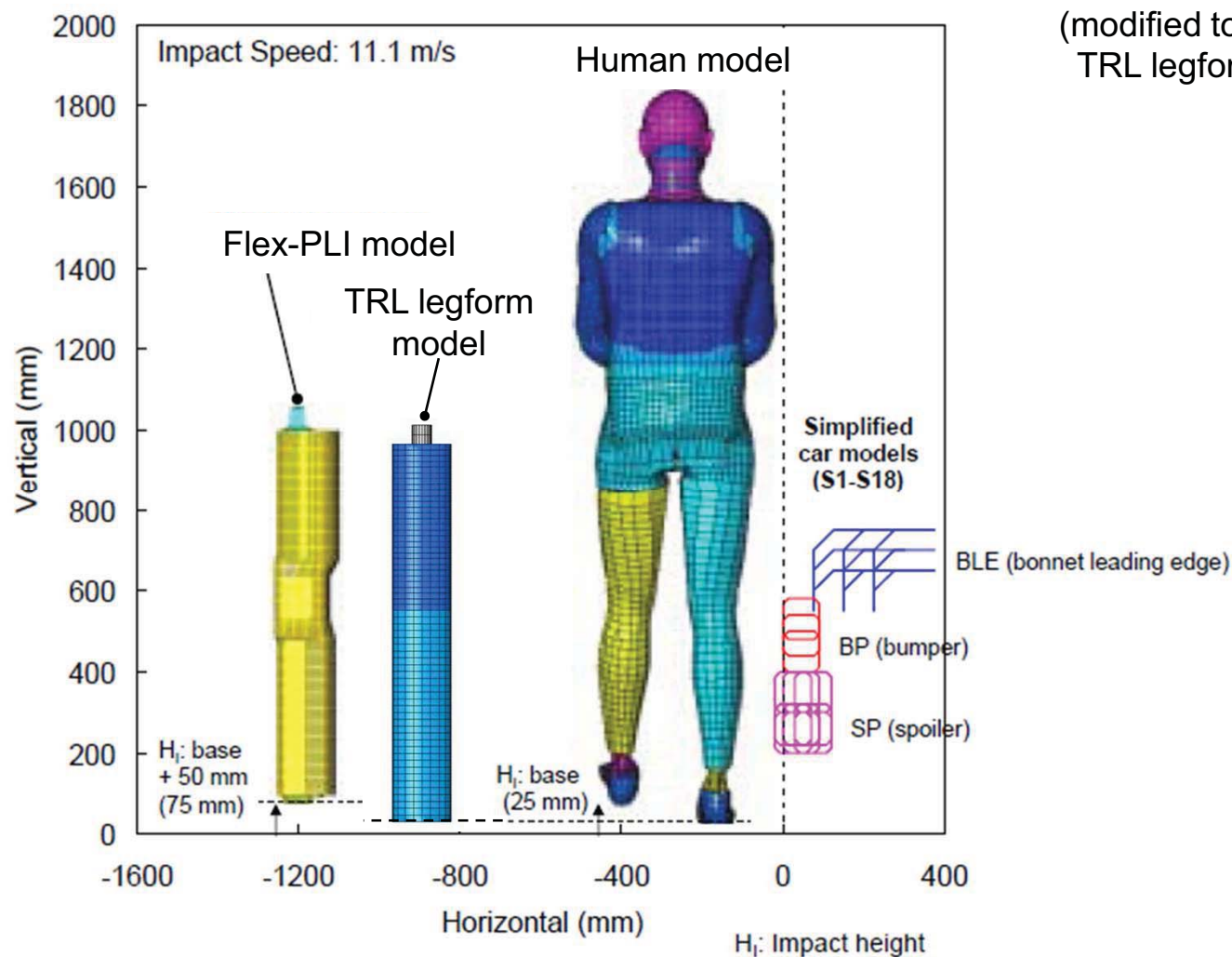

5. Correlation of Assembly Impact Responses

- CAE Correlation Study -

Correlation of Tibia Injury Measures

TEG-096

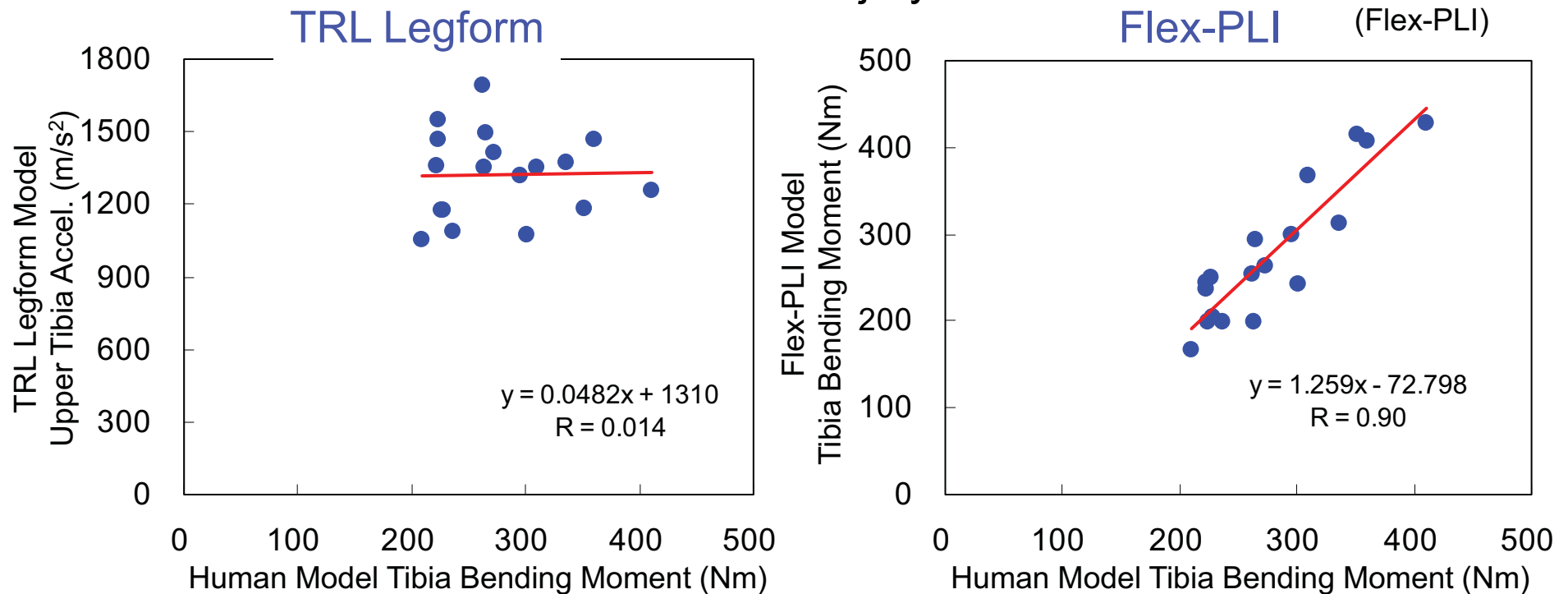

Konosu et al. (2009)

- **No correlation between TRL legform upper tibia acceleration and human tibia bending moment**
- **Good correlation between Flex-PLI and human tibia bending moment**

5. Correlation of Assembly Impact Responses

- CAE Correlation Study -
Correlation of MCL Injury Measures

TEG-096

(Flex-PLI)

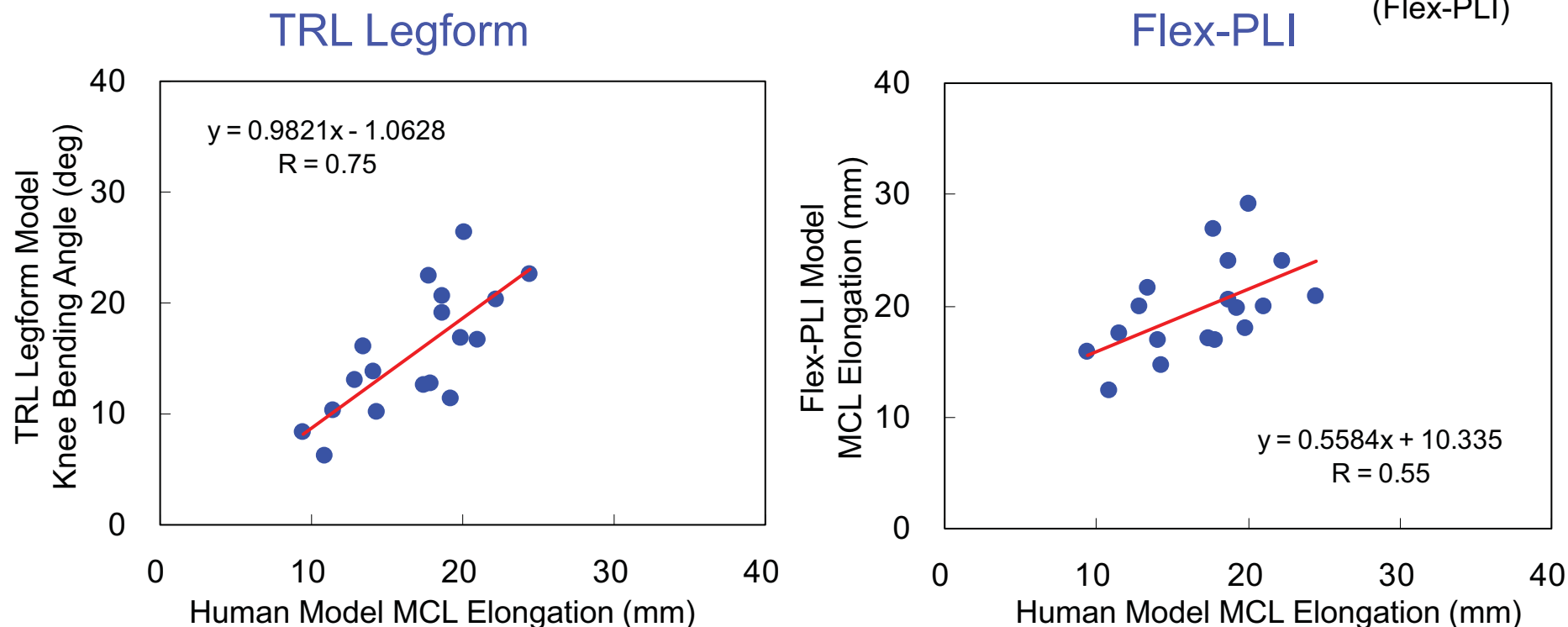

Both TRL legform knee bending angle and Flex-PLI MCL elongation show good correlation with human MCL elongation

5. Correlation of Assembly Impact Responses

- CAE Correlation Study -
Correlation of ACL Injury Measures

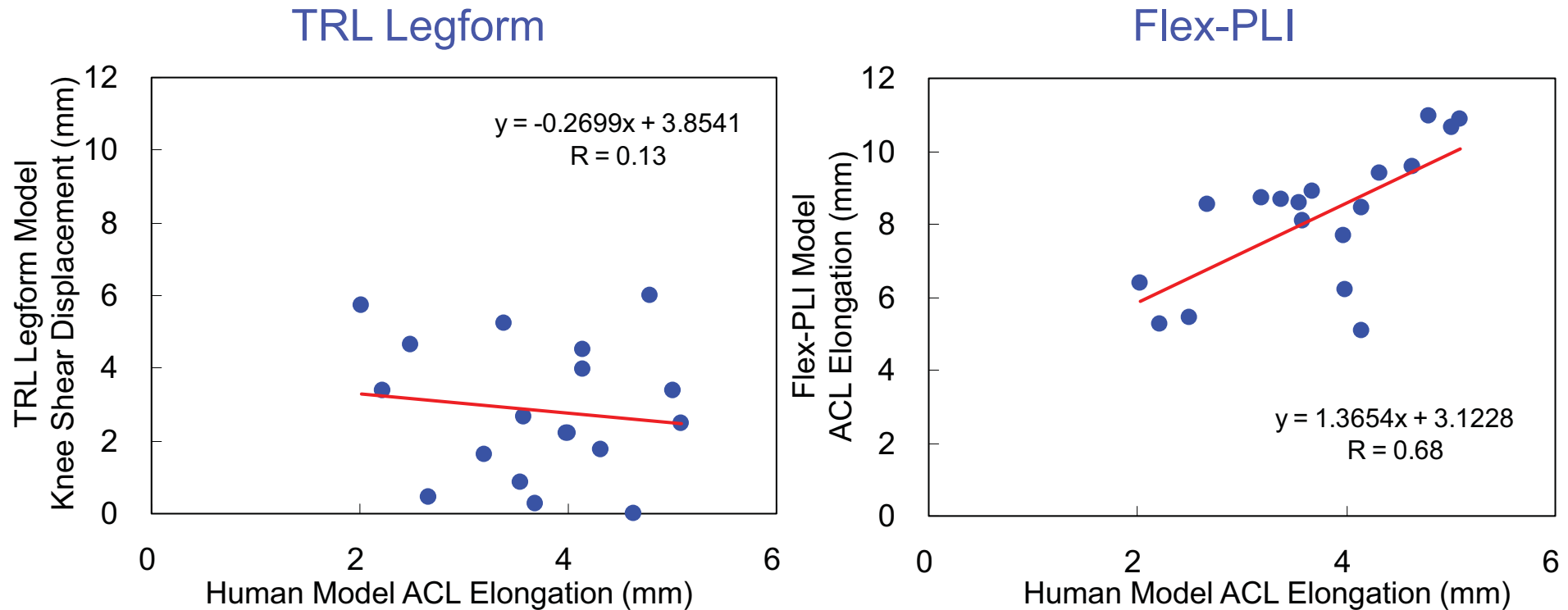

- **No correlation between TRL legform knee shear displacement and human ACL elongation**
- **Good correlation between Flex-PLI and human ACL elongation**

6. Determinants of Tibia Fracture Measures

- Ueyama et al., 2011 -

Rigid Body Model



Rigid body model

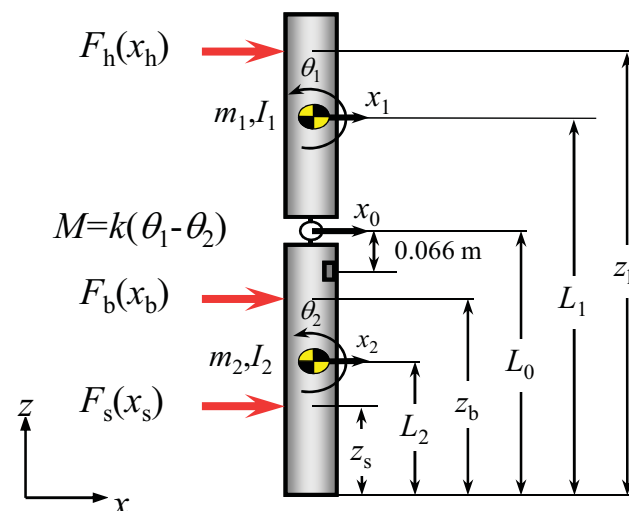

Equation of Motion

$$\begin{pmatrix} m_1 + m_2 & -m_1(L_1 - L_0) & m_2(L_0 - L_2) \\ -m_1(L_1 - L_0) & I_1 + m_1(L_1 - L_0)^2 & 0 \\ m_2(L_0 - L_2) & 0 & I_2 + m_2(L_0 - L_2)^2 \end{pmatrix} \begin{pmatrix} \ddot{x}_0 \\ \ddot{\theta}_1 \\ \ddot{\theta}_2 \end{pmatrix} + \begin{pmatrix} 0 & 0 & 0 \\ 0 & k & -k \\ 0 & -k & k \end{pmatrix} \begin{pmatrix} x_0 \\ \theta_1 \\ \theta_2 \end{pmatrix} = \begin{pmatrix} 1 & 1 & 1 \\ L_0 - z_h & 0 & 0 \\ 0 & L_0 - z_b & L_0 - z_s \end{pmatrix} \begin{pmatrix} F_h \\ F_b \\ F_s \end{pmatrix}$$

6. Determinants of Tibia Fracture Measures

- Ueyama et al., 2011 -

Tibia Acceleration

Equation of Motion of tibia

$$m_2 \ddot{x}_2 = F_b + F_s - T$$

$$a_A = \ddot{x}_0 + 0.066 \ddot{\theta}_2$$

$$= \ddot{x}_2 - (L_0 - L_2 - 0.066) \ddot{\theta}_2$$

$$a_A \approx \ddot{x}_2 \approx \frac{F_b + F_s}{m_2}$$

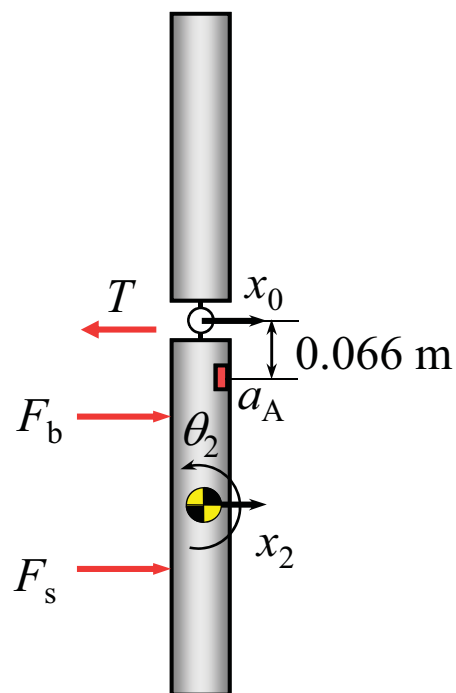

Tibia acceleration



Bumper force

+

Spoiler force

6. Determinants of Tibia Fracture Measures

- Ueyama et al., 2011 -

Tibia Bending Moment

For simplicity, instead of inertia force of tibia, approximated reaction force R_1 and R_2 is applied at the both ends of tibia.

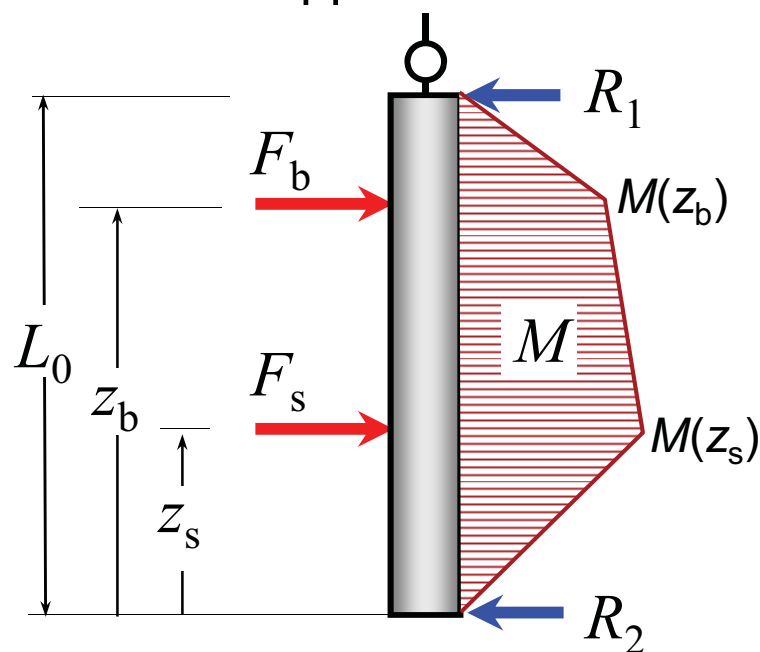

Max. tibia bending moment

$$M(z_s) = \frac{F_b(L_0 - z_b) + F_s(L_0 - z_s)}{L_0} z_s$$

$$M(z_b) = \frac{F_b z_b + F_s z_s}{L_0} (L_0 - z_b)$$

$$M_{\max} = \max \{ M(z_s), M(z_b) \}$$

Bending moment

Bumper and spoiler force

Point of force application

6. Determinants of Tibia Fracture Measures

- Ueyama et al., 2011 -

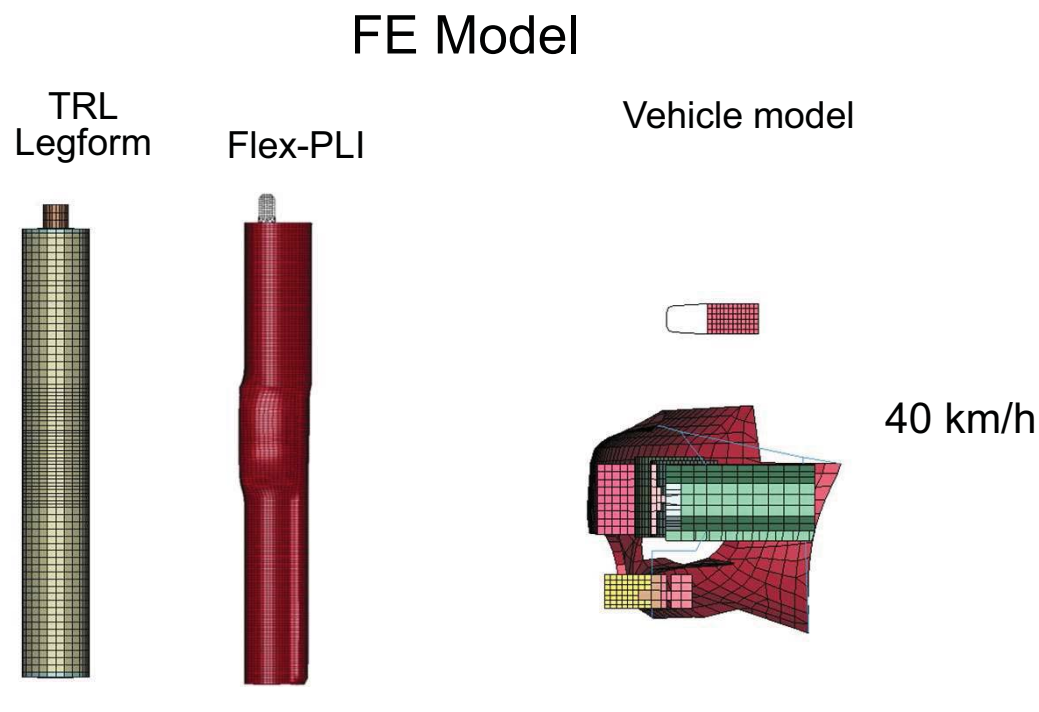

Validate Equation of Motion obtained from the rigid body model against impact simulation using FE models

6. Determinants of Tibia Fracture Measures

- Ueyama et al., 2011 -

Validation of Rigid Body Model
(Rigid Body Model vs. TRL legform FE Model)

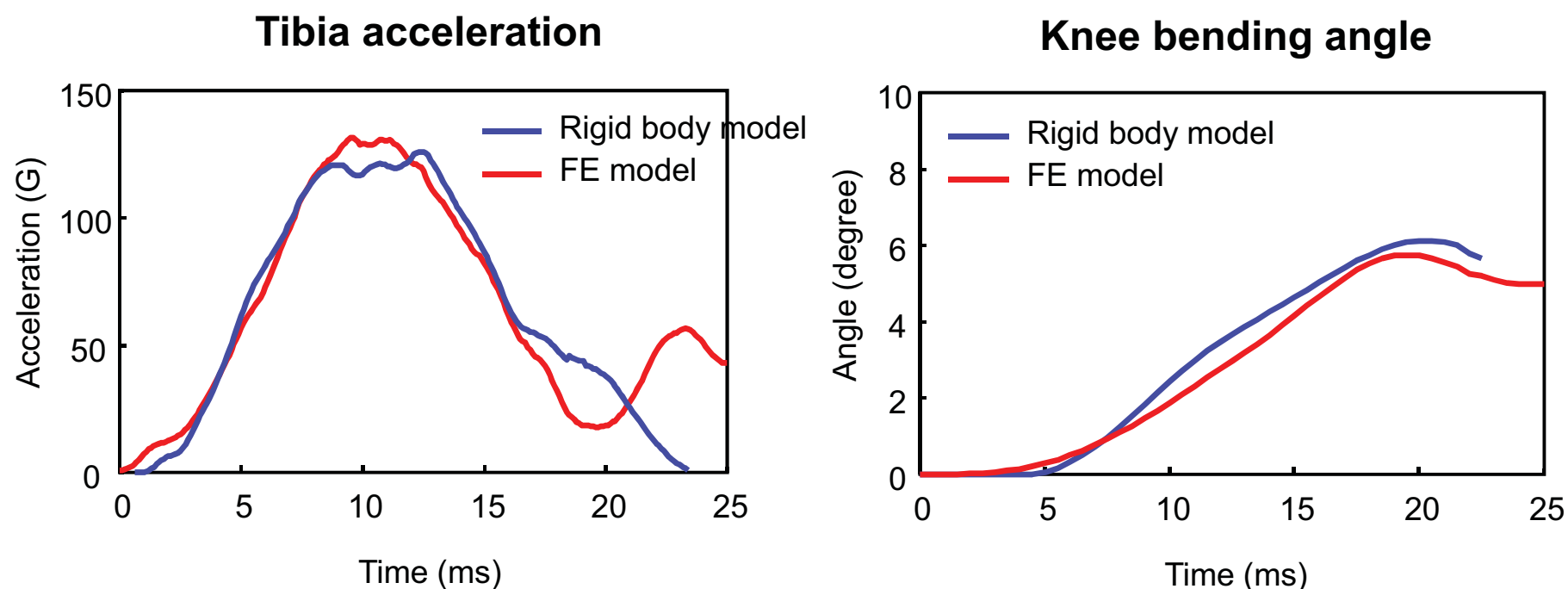

6. Determinants of Tibia Fracture Measures

- Ueyama et al., 2011 -

Car Model

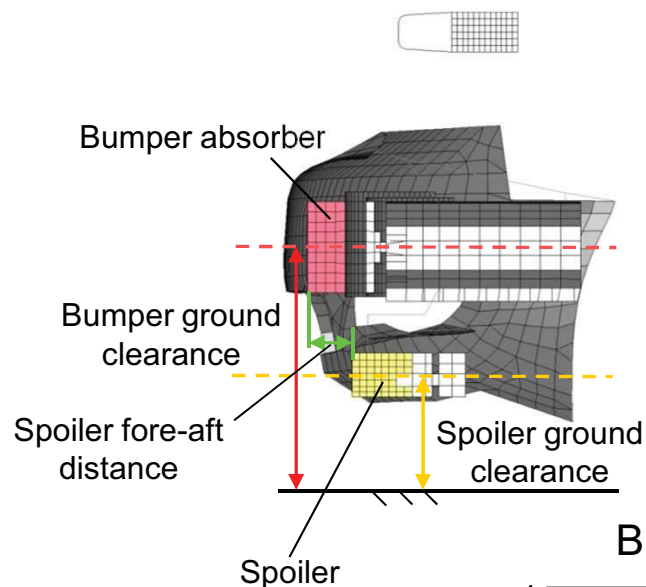

Parameter	Level 1	Level 2	Level 3
Bumper absorber stiffness	Soft	Stiff 1	Stiff 2
Spoiler stiffness	Stiff	Soft 1	Soft 2
Spoiler fore-aft distance	-31 mm	0 mm	+31 mm
Spoiler ground clearance	-34 mm	0 mm	+34 mm
Bumper ground clearance	-21 mm	0 mm	+21 mm

Bumper absorber

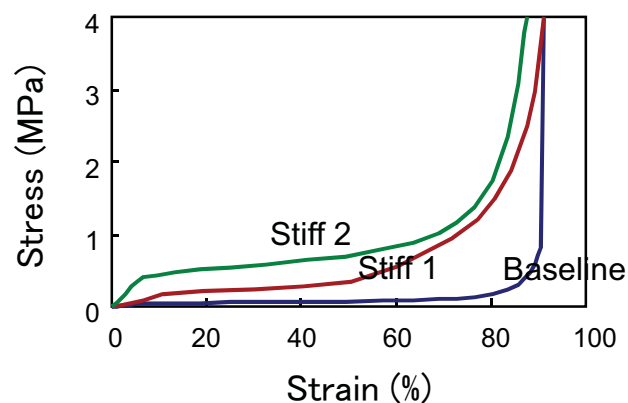

Spoiler absorber

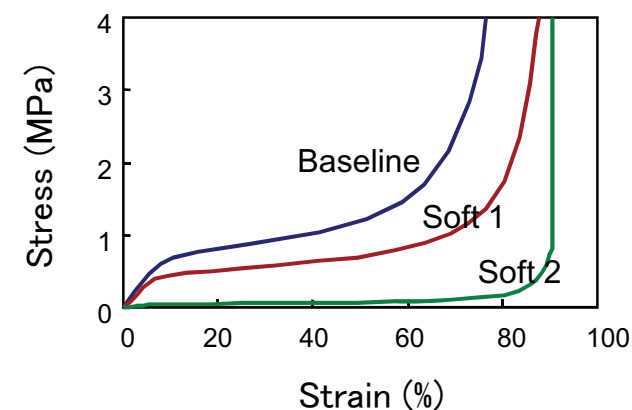

6. Determinants of Tibia Fracture Measures

- Ueyama et al., 2011 -

Tibia Acceleration (TRL Legform)

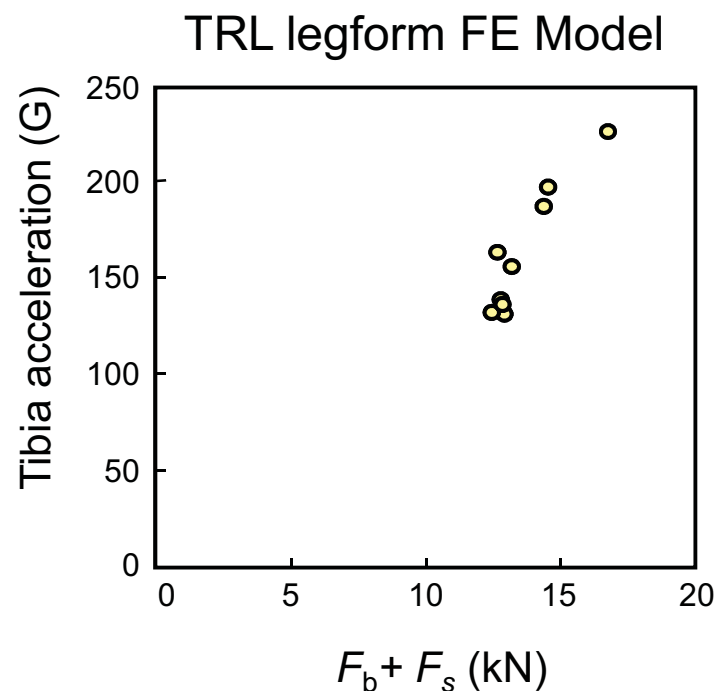
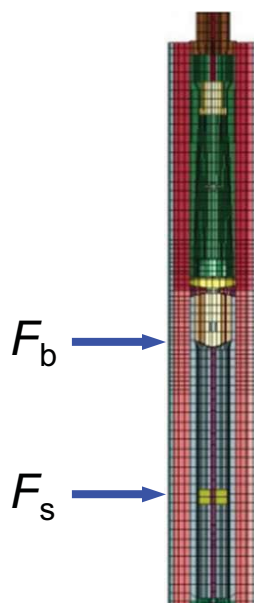

6. Determinants of Tibia Fracture Measures

- Ueyama et al., 2011 -

Tibia Bending Moment (Flex-PLI)

Presumed from Rigid body model

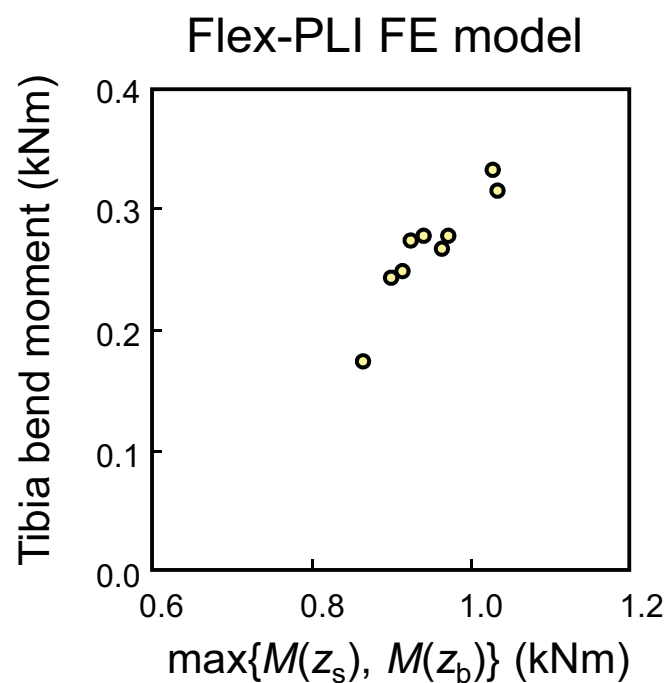
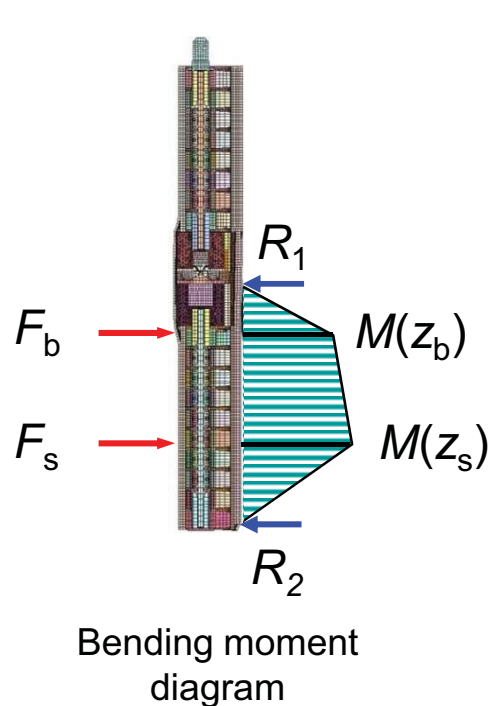

6. Determinants of Tibia Fracture Measures

- Relevant Injury Measures -

Vehicle model

18 Simplified vehicle models
used for CAE correlation study

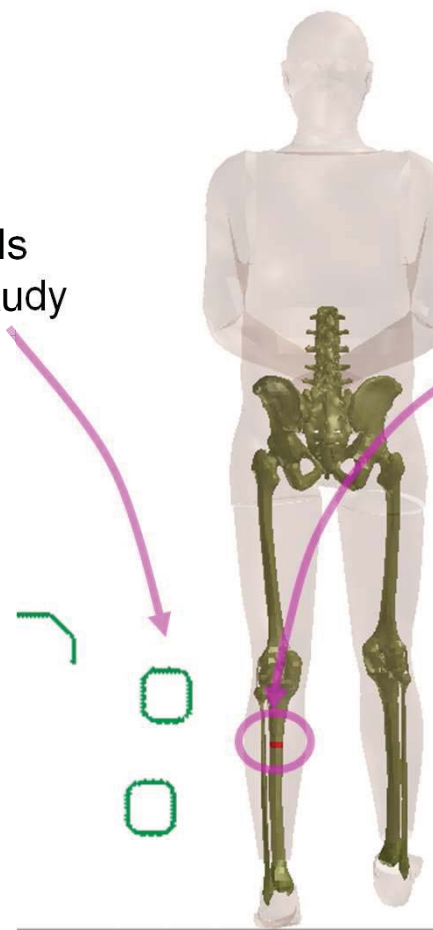

Output location

(stress, moment, acceleration)

- Cross-section corresponding to Tibia-1 of Flex-PLI
- This location provided the largest injury measures for all of the 18 vehicle models

**Investigate which of the measures used with the impactors
is more relevant to tibia stress**

6. Determinants of Tibia Fracture Measures

- Acceleration / Bending Moment vs. Stress -

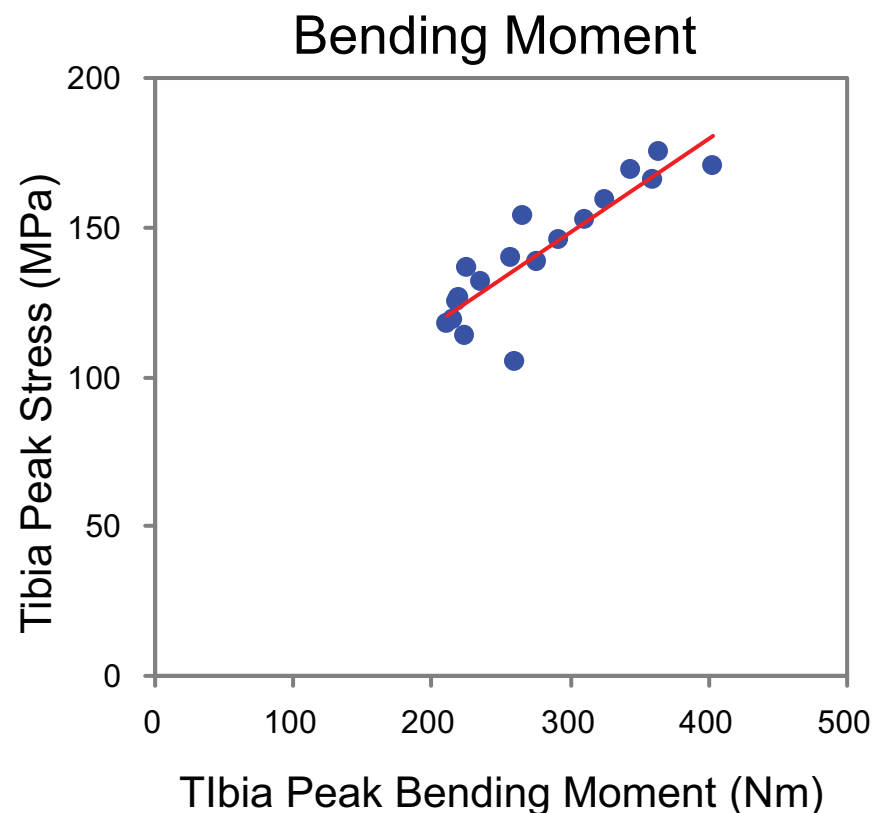
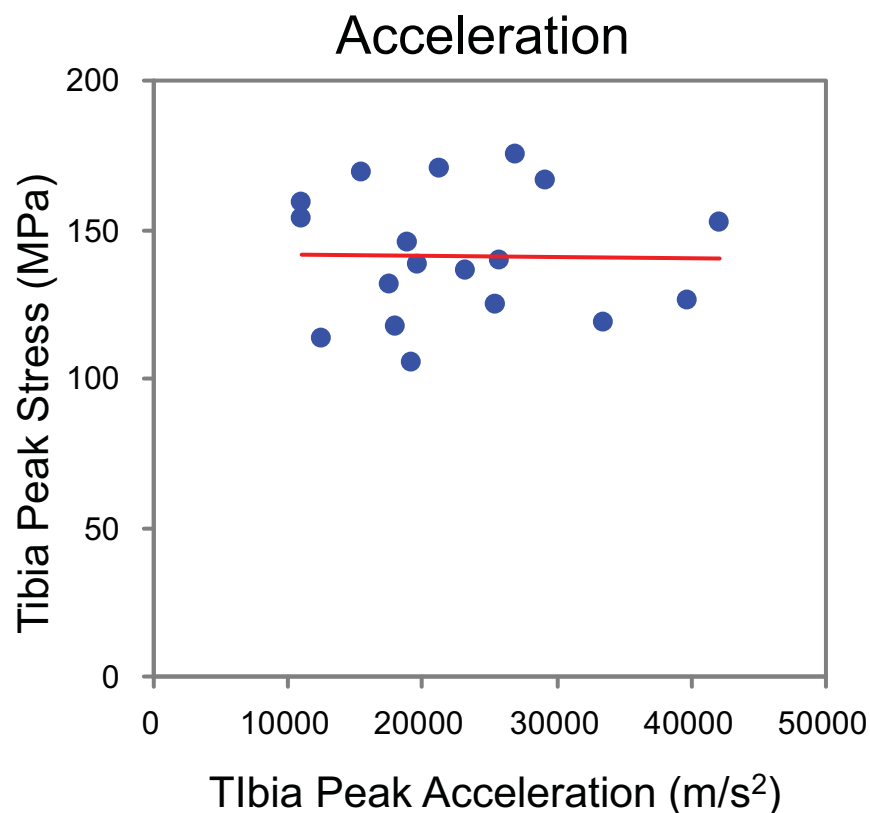

Tibia bending moment correlate with tibia peak stress much better than upper tibia acceleration

6. Determinants of Tibia Fracture Measures

- Threshold for Tibia Fracture from Biomechanical Data -

Bending Moment: **310Nm**

310Nm Bending Moment (1)

Axial Force: **6.2kN**

10.4 kN Compressive Axial Force (2)

131.4 MPa Compressive Strength (3)

78.8 MPa Tensile Strength (3)

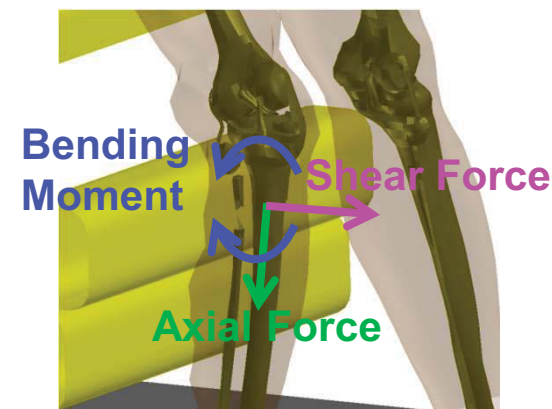

$$\rightarrow \text{Tensile Axial Force} = \text{Compressive Axial Force} \times \frac{\text{Tensile Strength}}{\text{Compressive Strength}} = 6.2 \text{ kN}$$

Shear Force: **8.4kN**

10.4 kN Compressive Axial Force (2)

131.4 MPa Compressive Strength (3)

106.0 MPa Transverse Strength (3)

$$\rightarrow \text{Shear Force} = \text{Compressive Axial Force} \times \frac{\text{Transverse Strength}}{\text{Compressive Strength}} = 8.4 \text{ kN}$$

References:

- (1) Kerrigan J., Bhalla K., Madeley N. J., Funk J., Bose D., Crandall J., Experiments for Establishing Pedestrian-Impact Lower Limb Injury Criteria, SAE 2003-01-0895, 2003 SAE World Congress (2003)
- (2) Nyquist G. W., Injury Tolerance Characteristics of the Adult Human Lower Extremities Under Static and Dynamic Loading, Proc. of the Symposium on Biomechanics and Medical Aspects of Lower Limb Injuries, SAE Paper Number 861925 (1965)
- (3) Dempster W.T., Liddicoat R.T., Compact Bone as a Non-isotropic Material, American Journal of Anatomy, Volume 91(3) (1952)

6. Determinants of Tibia Fracture Measures

- Comparison of Time Histories of Tibia Fracture Measures -

Car-A
(Passenger Car)



Car-B
(SUV;LBRLH<425mm)



Car-C
(SUV;LBRLH>425mm)



— Bending Moment — Axial Force — Shear Force

Injury Measures as % of Limit [-]

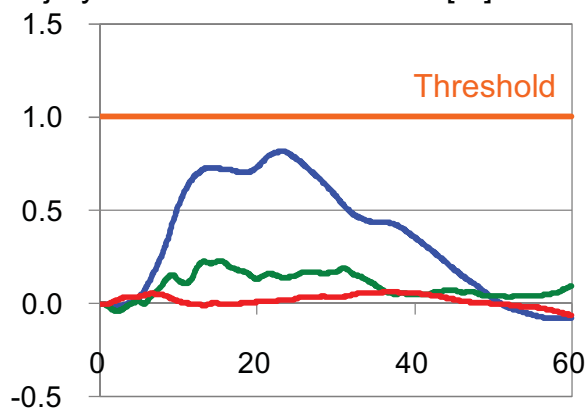

Injury Measures as % of Limit [-]

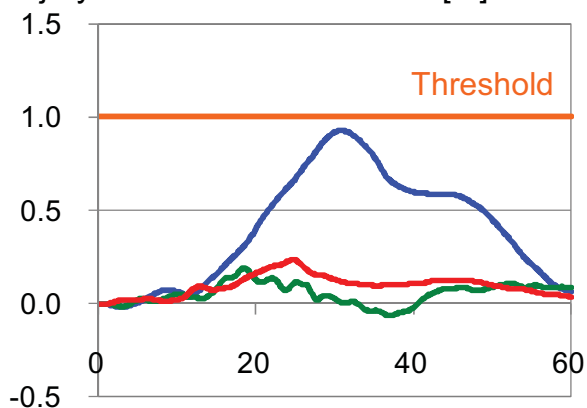

Injury Measures as % of Limit [-]

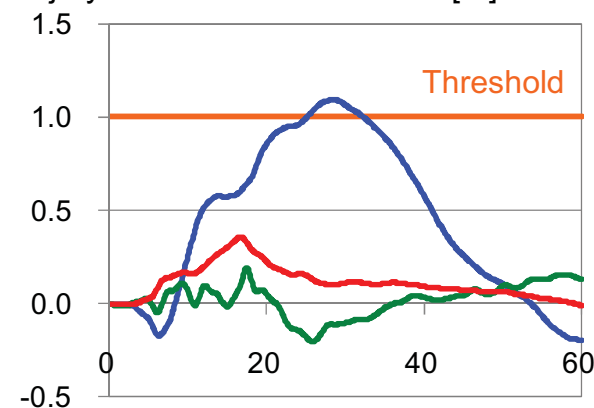

Peak normalized bending moment is predominant in all three fracture measures

6. Determinants of Tibia Fracture Measures

- Kallieris et al. (1988)-

881725

New Aspects of Pedestrian Protection Loading and Injury Pattern in Simulated Pedestrian Accidents

Dimitrios Kallieris and Georg Schmidt
University of Heidelberg

ABSTRACT

The paper presents a report about car pedestrian impact simulations. The front of a production car, which was mounted on a platform moving on rails was used as impact

comparison between the loadings in the various velocity ranges is made.

INTRODUCTION - The pedestrian is the weakest partner in road traffic. In collisions with vehicles the tolerance limit is already exceeded at

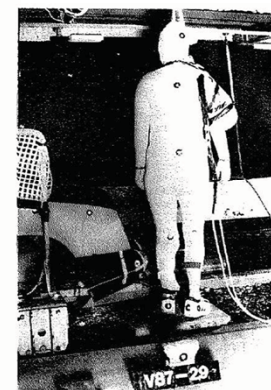

Fig. 1. Position of the PMHS relative to the car.

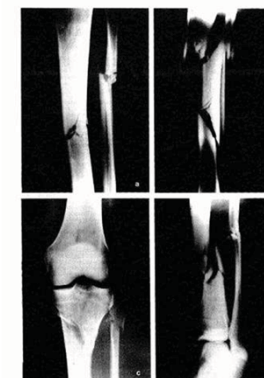

Fig. 4. Anterior-posterior x-rays of fractured tibia and fibula
a) Non-acc. 8722; b) Non-acc. 8726; c) Non-acc. 8727; d) Non-acc. 8728

- Full-scale car-pedestrian impact tests using 11 PMHSs
- Open tibia and fibula fractures in 8 cases
- When fractured, the tibia and fibula were taken out for a thorough autopsy
- Fracture of tibia and fibula can be explained by **bending strain**

Reference: Kallieris D., Schmidt G., New Aspects of Pedestrian Protection Loading and Injury Pattern in Simulated Pedestrian Accidents, 32nd Stapp Car Crash Conference Proceedings, SAE Paper Number 881725 (1988)

7. Tibia Fracture Prediction

- Comparison of Normalized Tibia Fracture Measures -

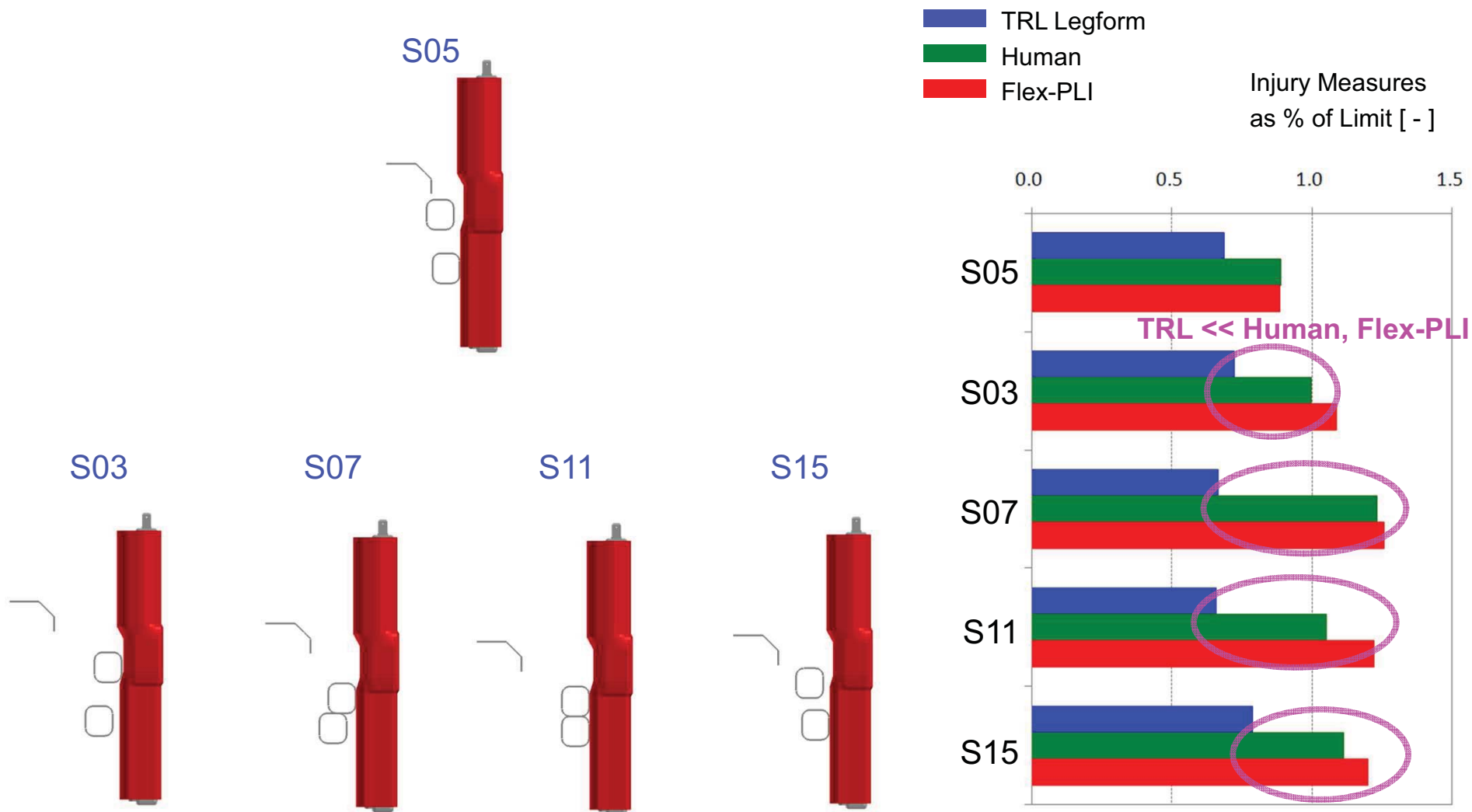

TRL legform : Upper Tibia Acceleration
 Human : Tibia Bending Moment
 Flex-PLI : Tibia Bending Moment

7. Tibia Fracture Prediction

- Comparison of Kinematics: S07 -

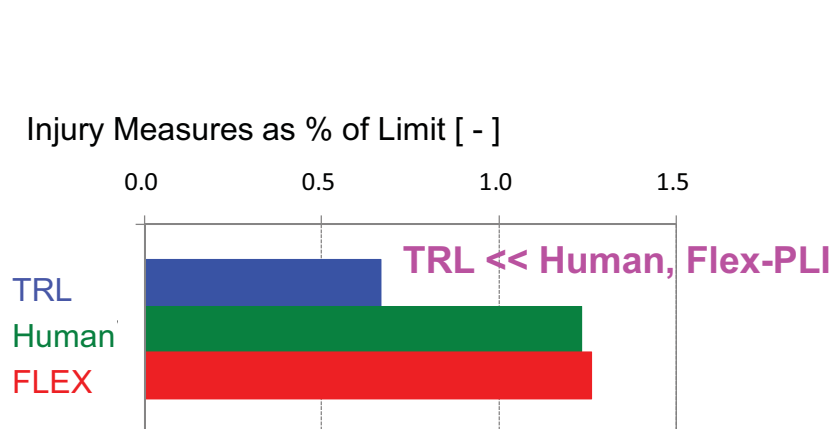

TRL Legform
11 ms
(Peak of TRL legform Model upper tibia accel.)

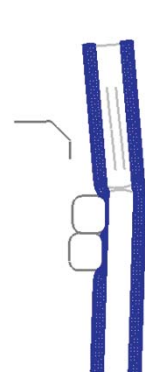

Flex-PLI



Human

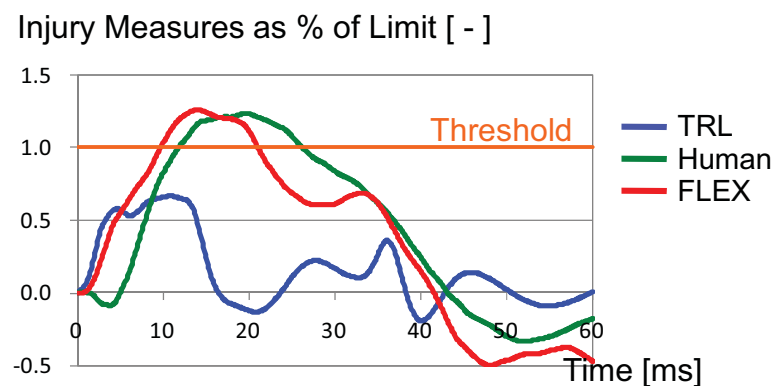
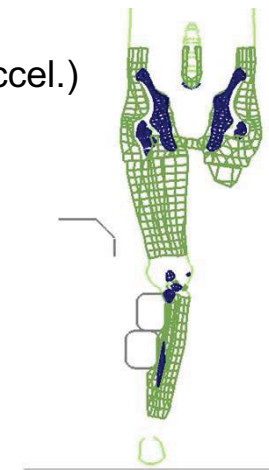

20 ms
(Peak of Human Model bending moment)

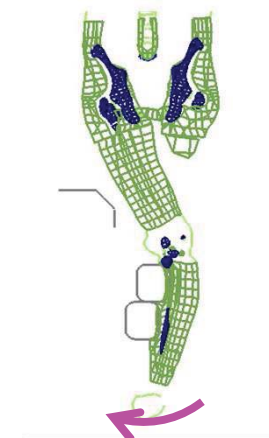
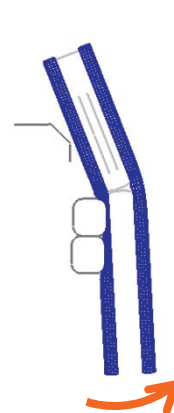

TRL legform lacks rotation of the leg underneath the bumper, which yields peak bending moment for human and Flex-PLI

7. Tibia Fracture Prediction

TRL Legform Model



Flex-PLI Model



Human Model

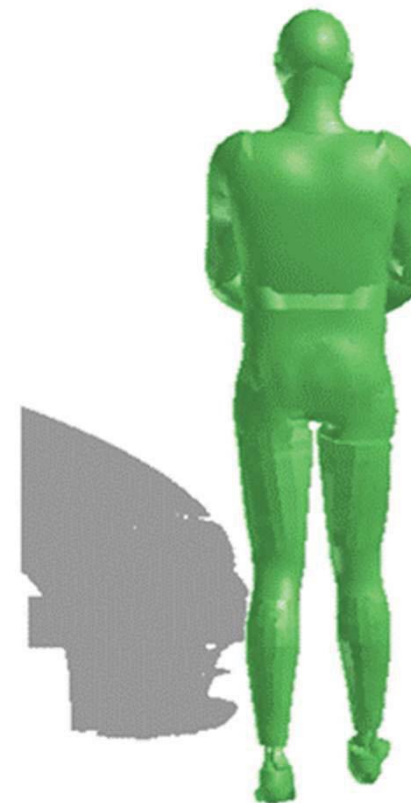

**Human Model : Same as the one used for
CAE correlation study**

7. Tibia Fracture Prediction

- Vehicle Models -

ID	Vehicle Information	Bumper Specification
Car-A Original	Passenger Car	Original
Car-A Modified		without Absorber, Stiffer Bumper Beam
Car-B Original	SUV (LBRLH < 425 mm)	Original
Car-B Modified		Stiffer Bumper Beam
Car-C Original	SUV (LBRLH > 425 mm)	Original
Car-C Modified		without Bumper Beam

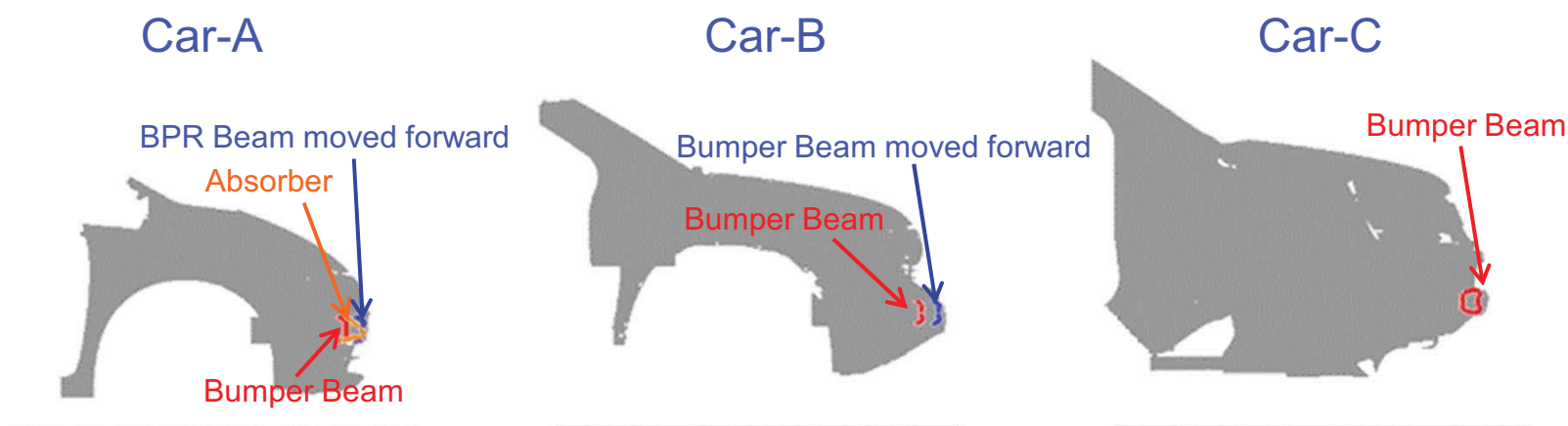

Modified bumper structure to represent bottoming

7. Tibia Fracture Prediction

- Comparison of Normalized Tibia Fracture Measures -

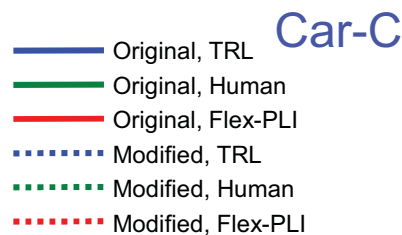
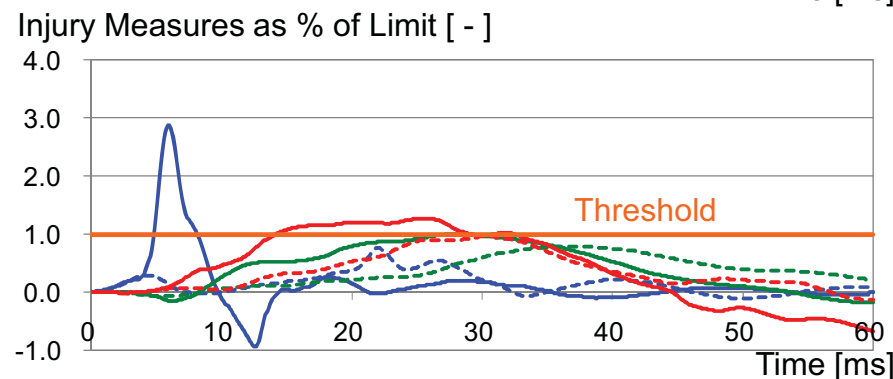
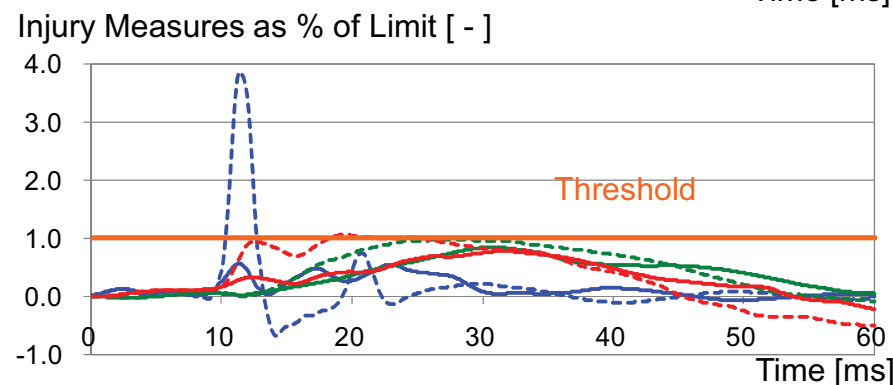
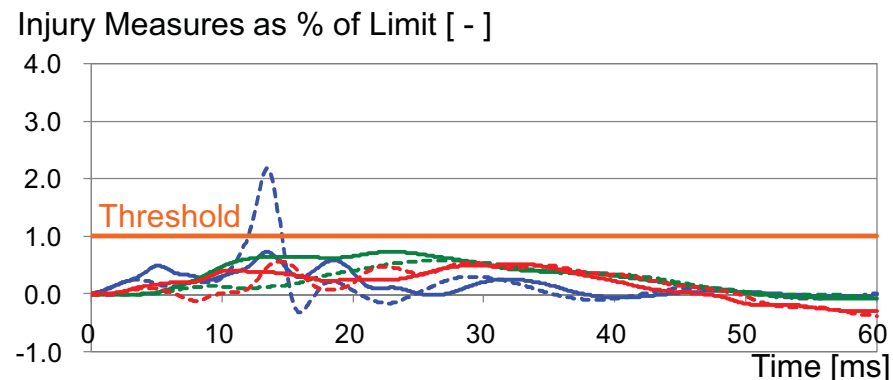
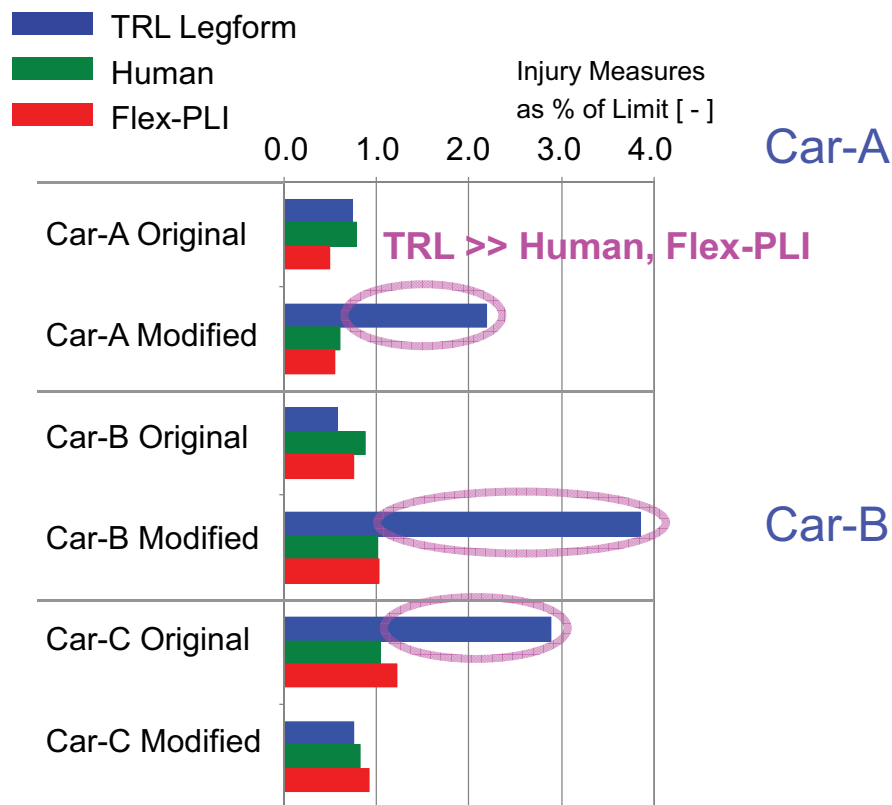

7. Tibia Fracture Prediction

- Comparison of Bumper Deformation (Car-A Modified) -

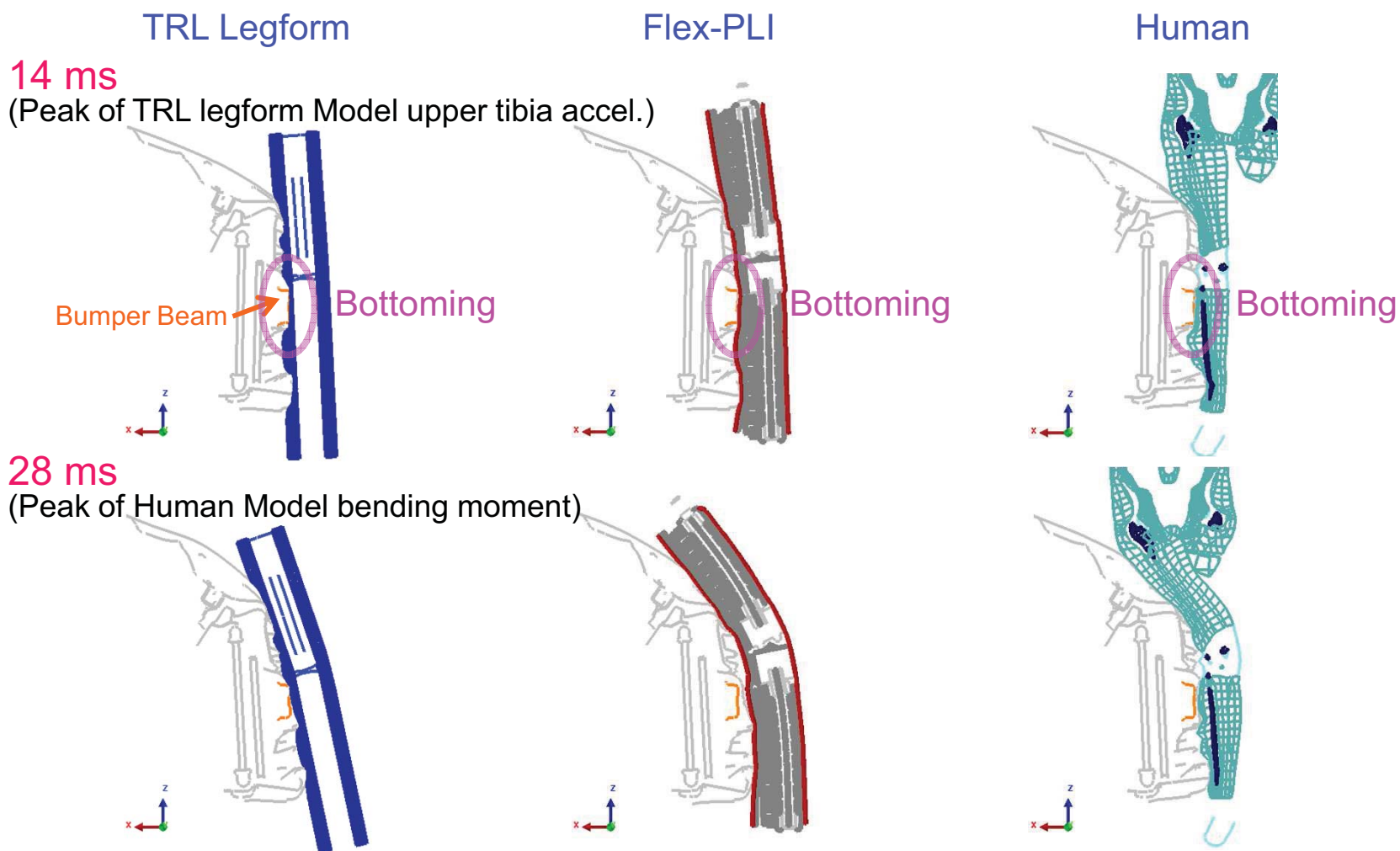

- Bumper bottomed out for all cases
- Tibia fracture measure dramatically increased only for TRL legform

8. Summary

- In vehicle impacts,
 - The tibia of both human and Flex-PLI bends due to impact from the vehicle, while the tibia of TRL legform is too stiff to represent bending
 - The knee ligaments of both human and Flex-PLI elongate due to combined bending and shear, while TRL legform uses separate bending and shear measures
- Component responses of Flex-PLI are much more biofidelic than those of TRL legform in terms of tibia and knee bending
- Correlation of assembly impact responses with human has been significantly improved with Flex-PLI for tibia fracture and knee shear measures

8. Summary (Contd.)

- Determinants of tibia fracture measures are different between TRL legform and Flex-PLI – sensitivity of loading location is much lower with TRL legform than with Flex-PLI and human
- For the human leg, the most critical injury measure is bending moment, which is used for the Flex-PLI
- For vehicles with a large bumper protrusion relative to the BLE, TRL legform tends to predict lower normalized injury values compared to human and Flex-PLI
- TRL legform upper tibia acceleration is way much more sensitive to bumper bottoming compared to Flex-PLI and human tibia bending moment

References

- Ueyama, T., Kikuchi, Y., Mizuno, K., Nakane, D., Wanami, S., *Comparison of Reponse of FLEX and TRL Legform Impactor in Pedestrian Test*, JSAE Annual Congress (Spring), Paper Number 20115181 (2011) (in Japanese)
- Otte, D., Haasper, C., *Characteristics on Fractures of Tibia and Fibula in Car Impacts to Pedestrians – Influences of Car Bumper Height and Shape*, IRCOBI Conference (2007)
- Takahashi Y., Kikuchi Y., *Biofidelity of Test Devices and Validity of Injury Criteria for Evaluating Knee Injuries to Pedestrians*, 17th ESV Conference, Paper Number 373 (2001)
- Takahashi, Y., Kikuchi, Y., Mori, F., Konosu, A. : *Advanced FE Lower Limb Model for Pedestrians*, 18th ESV, Paper Number 218 (2003)
- Kikuchi, Y., Takahashi, Y., Mori, F. : *Development of a Finite Element Model for a Pedestrian Pelvis and Lower Limb*, SAE paper 2006-01-0683 (2006)
- Kikuchi, Y., Takahashi, Y., Mori, F. : *Full-Scale Validation of a Human FE Model for the Pelvis and Lower Limb of a Pedestrian*, SAE Paper 2008-01-1243 (2008)
- Konosu, A., Issiki, T., Takahashi, Y., *Evaluation of the Validity of the Tibia Fracture Assessment Using the Upper Tibia Acceleration Employed in the TRL Legform Impactor*, IRCOBI Conference (2009)

References

- Kerrigan, J., Bhalla, K., Madeley, N., Funk, J., Bose, D., Crandall, J., *Experiments for Establishing Pedestrian-Impact Lower Limb Injury Criteria*, SAE Paper Number 2003-01-0895 (2003a)
- Dempster W.T., Liddicoat R.T., *Compact Bone as a Non-isotropic Material*, American Journal of Anatomy, Volume 91(3) (1952)
- Kallieris D., Schmidt G., *New Aspects of Pedestrian Protection Loading and Injury Pattern in Simulated Pedestrian Accidents*, 32nd Stapp Car Crash Conference Proceedings, SAE Paper Number 881725 (1988)

Thank you for your attention