

ECONOMIC COMMISSION FOR EUROPE

15 July 2014

INLAND TRANSPORT COMMITTEE

Working Party on the Transport of Dangerous Goods
Joint Meeting of Experts on the Regulations annexed to the
European Agreement concerning the International Carriage
of Dangerous Goods by Inland Waterways (ADN)
(ADN Safety Committee)

Twenty-fifth session
Geneva, 25-29 August 2014
Agenda item 4 (b)

**Proposals for amendments to the Regulations annexed to ADN:
Other proposals**

Flexible bulk containers (FBC) - test methodology and test report

**Transmitted by the International Dangerous Goods and Containers
Association (IDGCA)**

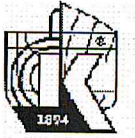

Krylov State Research Center

Copy No.



APPROVED BY

Dr. V.M. Shaposhnikov

Head of Strength &

Structure Division

_____ '____', 2014

Soft containers

Topple, righting, tear and stacking tests of container MK-14-10

Methodology

IMAN 31-406-14 MI

Agreed by
Chief Metrologist

Dr. V.D. Morozov

"____" _____ 2014

Methodology attestation
certificate No. 406/3-14

St.Petersburg
2014

TABLE OF CONTENTS

- 1. Application area and test goal 3**
- 2. Test entities 3**
- 3. Evaluated characteristics 4**
- 4. Safety and environmental protection requirements 4**
- 5 Test conditions..... 5**
- 6. Test facilities 5**
- 7. Test procedure. Criteria of test results evaluation 6**
- 8. Evaluation of test results 11**
- Appendix A 12**

1. Application area and test goal

This Methodology for testing soft containers (hereinafter referred to as MI) is a governing document for arranging and conducting tests of soft containers of MK-14-10 type (manufactured in CJSC “New Technologies in Transportation”) in Krylov State Research Center.

The goal of this testing is strength check of the above mentioned containers for compliance with requirements given in Section 6.8.5 “U.N.O. Recommendations for Dangerous Goods Transportation (Model Regulations, 17th revised edition and later editions) in terms of Topple tests, Righting tests and Tear tests, as well as Stacking tests, along with Part 6.9.1 IMDG Code (edition of 2012).

2. Test entities

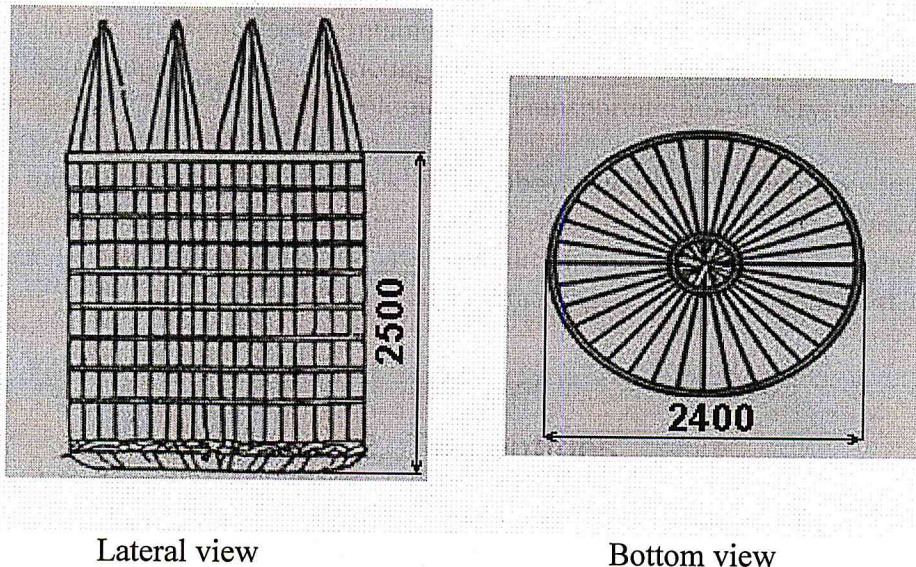

Fig.1. Characteristics of tested container

The test entity is a soft container of MK-14-10 type, the appearance of which is shown in Fig.1. It represents a load-carrying grid with lifting eyes, upper and lower fastening frameworks.

Two containers were tested. The first one was tested under stacking and tear. The second was tested under topple and lifting from the horizontal position to the vertical position (righting tests). The containers loaded not lesser than by 95% of their capacity and up to the maximally allowable gross mass (14 t) are supplied to KSRC by the Customer. Their acceptance is drawn up by a bilateral act.

Information on all detected defects in the container shell and lifting devices is recorded in a special incoming inspection act. It shall contain an unambiguous opinion on containers acceptance for the tests.

Provided the detected defects are essential, a container is not admitted for the testing with the concurrence of Customer.

3. Evaluated characteristics

All characteristics to be defined and measured during the container testing are divided into two main groups.

Characteristics providing procedures, which ensure preparation and conducting the tests in compliance with the existing conditions and requirements, are rated among the first group. This group includes external forces applied to container structural elements under its loading. The second group incorporates entity characteristics subject to definition and monitoring during this testing. First of all, visual inspection of the container during the tests could be rated in this group. The list of these characteristics depending on test types is given in Section 4 of this Methodology.

The extended uncertainty of measuring forces (loads) (at sweep efficiency 2) shall be not greater than $\pm 3\%$ relatively a measured magnitude.

The extended uncertainty of weighing the loaded container and pressure disk (at sweep efficiency 2) shall be not greater than $\pm 3\%$ relatively a measured magnitude.

The extended uncertainty of measuring the dropping height during the Topple tests (at sweep efficiency 2) shall be not greater than ± 20 mm.

The extended uncertainty of measuring the cut length during the Tear tests (at sweep efficiency 2) shall be not greater than ± 5 mm.

The extended uncertainty of measuring the container holding time under load during the Stacking tests (at sweep efficiency 2) shall be not greater than ± 15 minutes.

The extended uncertainty of measuring the container holding time under load during the Tear tests (at sweep efficiency 2) shall be not greater than ± 60 seconds.

4. Safety and environmental protection requirements

Testing of containers by this Methodology does not require any special conditions. Therefore, there is no necessity to develop special requirements to provide personnel safety during the testing. It is enough to be guided by existing safety instructions for operating personnel.

The mentioned testing is not related with use or application of any materials and means that pollute the environment. In this connection there is no necessity to formulate any ecological requirements, observation of which shall be obligatory during preparation and conduction of these tests.

5. Test conditions

According to this Methodology, during the tests it is required that the ambient temperature is in the range from +15 to + 25 °C, besides the site for the testing shall comply with the following requirements:

- it shall be integral and sufficiently massive to remain motionless;
- it shall be flat with the surface free from local defects capable to affect the test results;
- it shall be sufficiently stiff to remain unstrained;
- it shall be sufficiently strong to remain undamaged during the tests;
- it shall be sufficiently large to provide a place for whole container fall

6. Test facilities

6.1. The container was loaded with four force sensing channels that consisted of “ViCont” system and force-measuring transducers of DSTU type. The extended uncertainty of measuring the force (at sweep efficiency 2) shall be not greater than $\pm 3\%$ relatively a measured magnitude.

6.2. Weighing of the loaded container, as well as weighing the pressure disk is performed with the force sensing channels consisting of “ViCont” system and force-measuring transducers of DSTU type of an appropriate rating. The extended uncertainty of measuring the force (at sweep efficiency 2) shall be not greater than $\pm 3\%$ relatively a measured magnitude.

6.3. Measuring the dropping height during the Topple tests, as well as measuring the container cut length during the Tear tests is performed with a metallic measuring tape having the measurement range from 0 to 10,000 mm and division value 1 mm.

6.4. Measuring the container holding time under load during the Tear tests is performed with a stopwatch of Comp type. For this type the maximum error in the interval 0 – 60 min is not greater than ± 1.5 s.

6.5. Measuring the container holding time under load during the Stacking tests is performed with mechanical clock - alarm clock “Slava” having the mechanism 5671.H.1 TY 25-1619.0023-91. Error of the clock daily rate at temperature (20 ± 5) °C is not greater than ± 120 s.

6.6 The measuring instrumentation used for the tests shall have valid certificates (documents) on calibration.

6.7. Other measuring instrumentation, metrological characteristics of which are not worse than the above mentioned ones could be used as well.

7. Test procedure. Criteria of test results evaluation

Description of container loading schemes and procedures when conducting various test types, as well as test success criteria are given in this section.

7.1 Container preparation for testing

In compliance with it.2 of the MI, the Customer supplies 2 containers for testing, which are filled with a cargo simulator by not lesser than 95% of its capacity and up to it maximally allowable gross mass M_k equal to 14 t.

Container preparation for testing in the laboratory consists in its control weighing with a special force sensing channel (see it.6.2 of MI). At that the container gross mass M_k is related with the force sensing channel reading G as follows:

$$G = M_k g,$$

where g = gravity acceleration.

The cargo simulator mass shall be corrected if necessary.

7.2 Stacking tests

7.2.1. Install the container prepared according to it. 7.1 of MI vertically on the test site.

7.2.2. Assemble the pressure mechanism according to the diagram given in Fig.2.

7.2.3. Install the pressure disk inside the container with the help of a crane.

7.2.4. Apply a distributed load to the container top; the load is four times as large as the container maximally allowable gross mass M_k ($4M_k = 56$ t). The total force P_1 produced by hydraulic cylinders is defined as follows:

$$P_1 = g(4M_k - M_{FD}),$$

where M_{FD} = pressure disk mass evaluated by weighing the disk with the help of a force sensing channel.

7.2.5. Hold the container under load (see it. 7.4.5) for 24 hours. Monitor each hour the value of the force produced by the hydraulic cylinders.

7.2.6. Unload and examine the container after that.

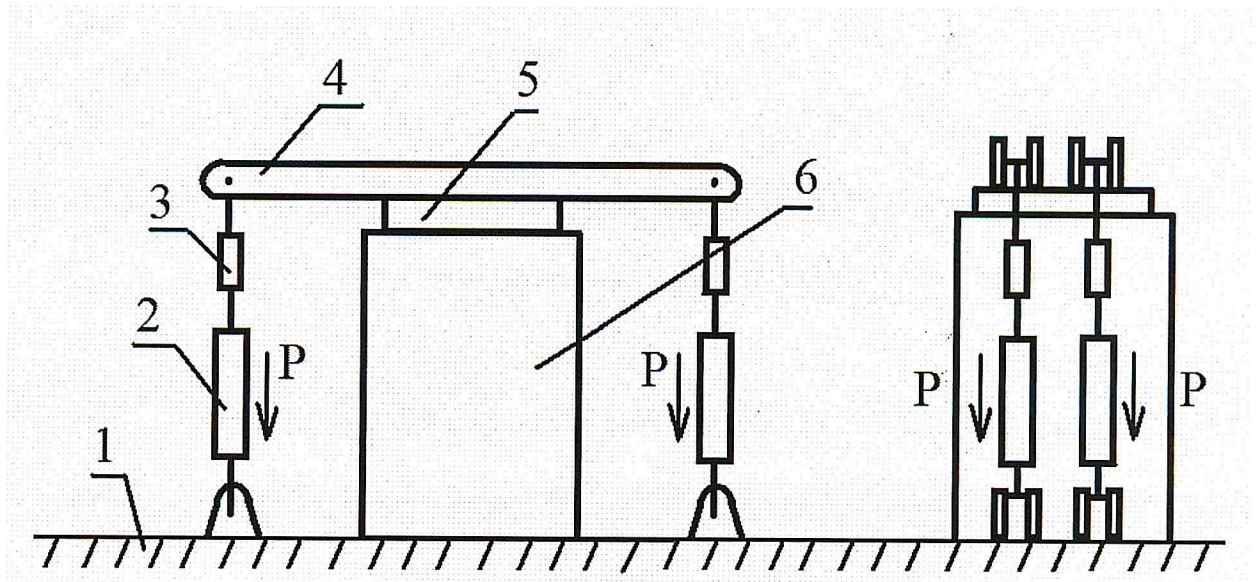

Fig. 2- Container loading scheme under stacking and tear tests

A through cut of (300 ± 5) mm length is made in the container middle part at the angle 45° to its main axis under tear tests.

- 1 – test site
- 2 – hydraulic cylinder
- 3 – dynamometer
- 4 – crossbar
- 5 – pressure disk
- 6 – container

7.2.7. Test success criterion:

- no loss of container contents during the tests or after unloading.

7.3. Tear tests

7.3.1. Tear tests are conducted for the container tested before under stacking or for a new container prepared in compliance with it.7.1 of MI.

7.3.2. In case of a new container, install it vertically on the test site and install a pressure disk in it.

7.3.3. Make a cut on the tested container side surface at an equal distance from the bottom and the upper level of the cargo simulator at the angle 45° to its main axis; the cut shall penetrate completely through all layers. The cut length shall be equal to (300 ± 5) mm.

7.3.4. Load the container from above by a uniformly distributed load equal to doubled container maximally allowable gross mass ($2M_K = 28$ t). The total force P_2 produced by hydraulic cylinders is defined as follows:

$$P_2 = g(2M_K - M_{HD}),$$

where M_{HD} = pressure disk mass evaluated by weighing the disk with the help of a force sensing channel.

7.3.5. Hold the container under load for 15 min and unload.

7.3.6. Lift the container with a crane by raising it above the floor and leave it in this position for 15 min. Then unload, put the container on the floor and examine.

7.3.7. Test success criterion:

- the initial cut length shall not be increased by more than 25 %.

7.4 Topple tests

7.4.1. After the control weighing the cargo simulator is covered with a special rubber diaphragm available in the container. The rubber diaphragm is pressed to the cargo simulator through cross connection of four lifting eyes.

7.4.2. Install the container prepared for the tests on an edge of a turning plate located on a special foundation as it is shown in Fig.3. The height of the turning plate upper surface relatively the floor shall be equal to (0.8 ± 0.02) m, and the plate itself shall have a threshold.

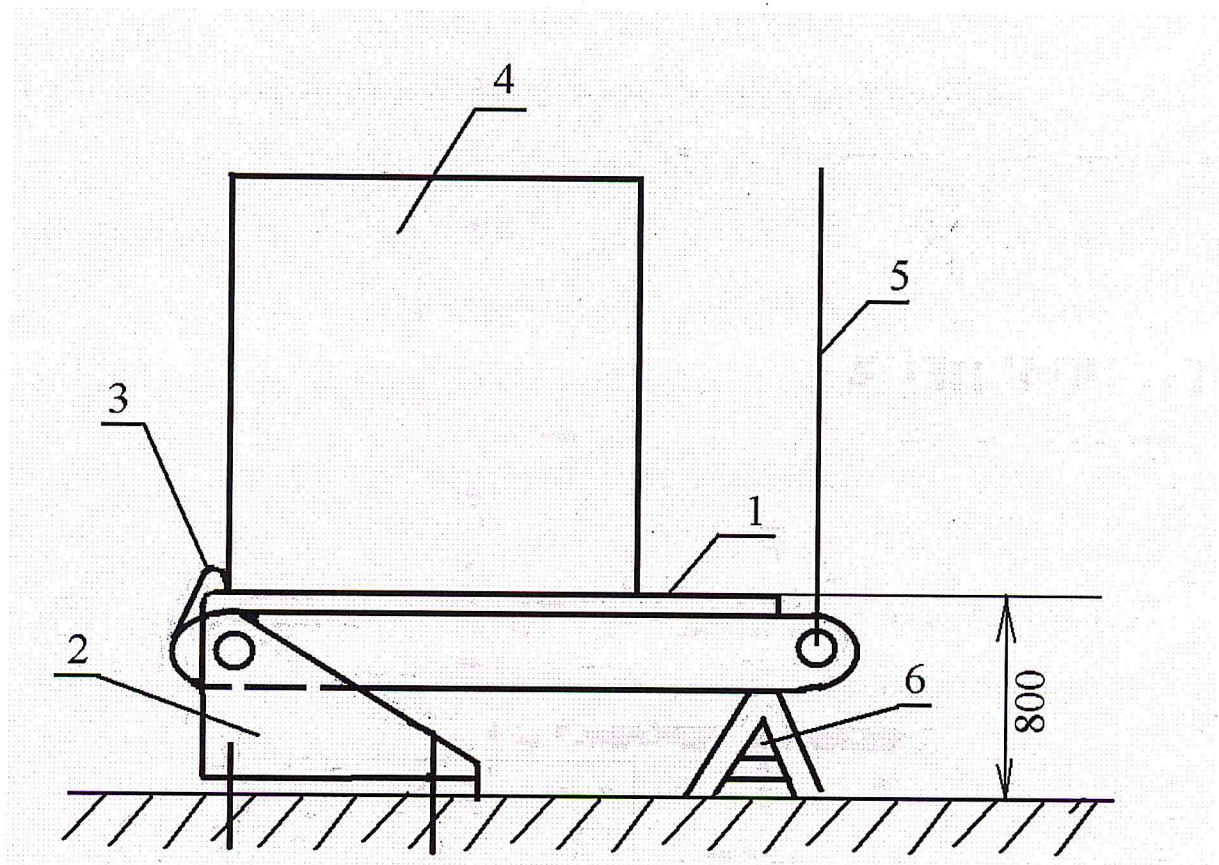

Fig.3 – Container loading scheme under topple tests

- 1 – turning plate
- 2 – foundation relatively with the turning plate turns
- 3 – threshold
- 4 – container
- 5 – crane strap
- 6 – technical support

7.4.3. Put a metallic plate to the foundation side where the container will be toppled.

7.4.4. Lift the turning plate edge (see Fig.3) with the crane by having provided container toppling on the metallic plate.

7.4.5. Shift aside the metallic plate with the container.

7.4.6. Put two container lifting eyes on the crane hook by an instruction of the Test Manager agreed with Customer representatives and a supervising body.

7.4.7. Lift the container with the help of the crane without separating the container from the metallic plate and install it vertically.

7.4.8. Test success criterion:

- no loss of the contents; insufficient ejection under an impact, for example, through locks or openings of weld broaching shall not be considered as a container disadvantage provided leakage is not continued.

7.5. Righting tests

7.5.1. Put the container prepared in compliance with it.7.1 of MI on the test site with a side surface.

7.5.2. Put two container lifting eyes on the crane hook by an instruction of the Test Manager agreed with Customer representatives and a supervising body.





7.5.3. Lift the container up to the vertical position above the floor. The container lifting speed shall not be lesser than 0.1 m/s.

7.5.4. Test success criterion:

- no damage of the container or its lifting devices, which could make the soft container unsafe for transportation and cargo operations.

8. Evaluation of test results

A test report is prepared by the Executor based on the test results in compliance with corresponding clauses from CTP IMAN 083-2013 "Quality Management System. Metrological Work Support. Test Methodology."

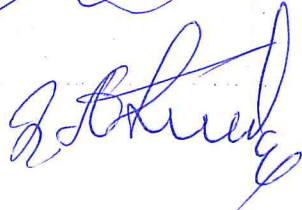
| | | |
|----------------------------|--|----------------------------|
| Senior staff scientist |  | Dr. Eugeny A. Shishenin |
| Head of section 314 |  | Sergey A. Dmitriev |
| Head of Laboratory |  | Dr. Anatoly V. Aleksandrov |
| Head of MS-3 ¹⁾ |  | Dr. Yury A. Zimnitsky |
| Customer Representative |  | Emil A. Akhiundov |

¹⁾ Metrological Service of Division No.3

Appendix A

(for reference)

Justification of errors in measured specified parameters

The following parameters are listed among the main ones, measurement accuracy of which could essentially affect the soft container testing results:

- weight of the loaded container and pressure disk;
- values of test loads;
- dropping height under topple tests;
- length of the cut on the container side surface before and after tear tests ;
- holding time under loading;
- load lifting speed.

1 Weight of the loaded container, as well as weight of the pressure disk is evaluated with the force sensing channels consisting of “ViCont” system and force-measuring transducers of DSTU type of an appropriate rating. To conduct the tests, channels are calibrated in the force measurement required range according to the Methodology IMAN 307-80-07 MI. The channel, the limits of relative force measurement error of which do not exceed $\pm 2.5\%$ at confidence probability equal to 0.95, are admitted for the testing. Therefore, the Methodology requirement on the loaded container and pressure disk weighing metering error ($\pm 3\%$) is satisfied.

2. The test load applied to the container is a sum of the pressure disk weight and forces produced by hydraulic cylinders. These forces are measured with special force sensing channels consisting of “ViCont” system and force-measuring transducers of DSTU type. Prior to the tests, the channels are calibrated (see it.1 of this Appendix); requirements to the measurement error imposed to them are similar to those given in it.1

It was said in it.1 that the relative error of weighing the pressure disk does not exceed $\pm 2.5\%$. The measuring error for forces produced by the hydraulic cylinders does not exceed $\pm 2.5\%$ as well. Therefore, the relative error of measuring the test load could not be greater than $\pm 2.5\%$.

Therefore, the Methodology requirement on the test load measuring error ($\pm 2.5\%$) is satisfied.

3 Linear dimensions (the dropping height during the Topple tests and the container cut length during the Tear tests) are measured with a metallic measuring tape having the measurement range from 0 to 10,000 mm. The measuring tape No.AR/1 was calibrated in the calibrating center of Krylov State Research Center (certificate No. № 2014409 valid up to March 25, 2015) and was recognized fit for use.

In accordance with GOST 7502-98, the measurement error for distances up to 1 m for such a measuring tape shall not exceed ± 0.3 mm. Therefore, the Methodology requirement on the dropping height and cut length measuring error (± 20 and ± 5 mm) is satisfied.

4. Measuring the container holding time under load during the Stacking tests is performed with mechanical clock - alarm clock “Slava” having the mechanism 5671.H.1 TY 25-1619.0023-91. Error of the clock daily rate at temperature $(20\pm 5)^\circ\text{C}$ is not greater than ± 120 s.

Measuring the container holding time under load during the Tear tests is performed with a stopwatch of Comp type. For this type the maximum error in the interval 0 – 60 min is not greater than ± 1.5 s.

Therefore, the Methodology requirement on the time interval measuring error (± 15 min and ± 1 min) is satisfied.

Chief metrologist

V.D. Morozov

Head of MS-3

Yu. A. Zimmitsky

Krylov State Research Center

196158, St. Petersburg
44 Moscovskoye Shosse,
Fax (812) 727-96-32
Tel. (812) 727-95-93

Copy No. 1



APPROVED BY

M. Shaposhnikov
M. Shaposhnikov
Head of Strength &
Structure Division

April 30, 2014

Test report No. AR-107-P.4

**Certification tests for structural type and safety of soft specialized
container of MK-14-10 grade**

Made in 3 copies.

Экз. No. 1 – to Customer

Экз. No. 2 – RMRS.

Экз. No. 3 – Laboratory Archives

Test results refer to the tested
entity only..

Reproduction of the report and its parts
without written permission of
Krylov State Research Center is
forbidden.

St. Petersburg
2014

Table of contents

| | |
|---|----|
| 1. General | 3 |
| 2. Test equipment and instrumentation..... | 4 |
| 3. Documents | 4 |
| 4. Test procedure..... | 4 |
| 5. Stacking tests | 5 |
| 6. Tear tests | 8 |
| 7. Receipt inspection report AR – AR107 P.4-1..... | 11 |
| 8. Report AR – AR107 P.4-2 The soft container mass evaluation | 12 |
| 9. Certificate on calibrating instrumentation | 13 |
| 10. Certificate of soft container MK 14-10..... | 15 |

1. General

1.1. A soft container of MK-14-10 grade having the following characteristics was tested.

| | |
|--|---|
| Material | Rubbered cloth reinforced with grid of belt bands |
| Maximum carrying capacity, kgf (Q_{max}) | 14,000 |
| Maximum holding capacity, m ³ | 15.0 |
| Top structure | Closed with loading arm |
| Bottom structure | Flat blind with discharging arm |
| Lifting device (quantity of lifting eyes) | 8 |
| Presence of insert | No |
| Total quantity of layers when piling | 4 |
| Overall dimensions, cm | 240×240×280 |
| Package group | III |
| Registration number | 10414360 |

1.2 Test types:

- stacking tests;
- tear tests.

1.3 Basis for the testing – Contract No. 331-31/13 dated 31.01.14 with CJSC New Technologies in Transportation

1.4. The following attended the testing:

From SJSC “New Technologies in Transportation” – Emil A. Akhiundov,

From CJSC MFRI – Evgeny B. Karpovich

From DNV GL – Boris A. Vishniakov

From CJSC Russian Register - Igor G. Sannikov



1.5 The test entity was supplied to the laboratory on April 21, 2014

1.6. The tests were conducted on April 22, 2014 – April 29.2014

2. Test equipment and instrumentation

Force metering channel DSTU -200-20 consisting of:

- Vi Cont system
- Force-measuring transducer 1798 DSTU-2I-200-No.20, bridge No.1, Certificate No. 1804/314-14 valid up to February 07, 2015.

3. Documents

3.1. Test program for the structural type and safety of soft specialized container of MK-14-10 grade.

3.2. Methodology IMAN 31-406-14 MI “Soft containers. Topple, Righting, Tear and Stacking Tests of Container MK-14-10. Test Methodology”.

3.3. Methodology IMAN 31-258-00 MI “Soft containers. Strength Characteristics. Test Methodology”.

3.4. Certification of Automatic Loading Channels for SNPK2000-300 System. Methodology IMAN 307-310-00MA.

4. Test procedure

Actions for the container preparation for the testing are explained in the methodology IMAN 31-406-14 MI “Soft containers. Topple, Righting, Tear and Stacking Tests of Container MK-14-10. Test Methodology.”

(Information required in the test report is given below for each test type on individual pages).

5. Stacking tests

5.1 Container registration number is 10414360.

5.2 Test date is April 28 to 29, 2014.

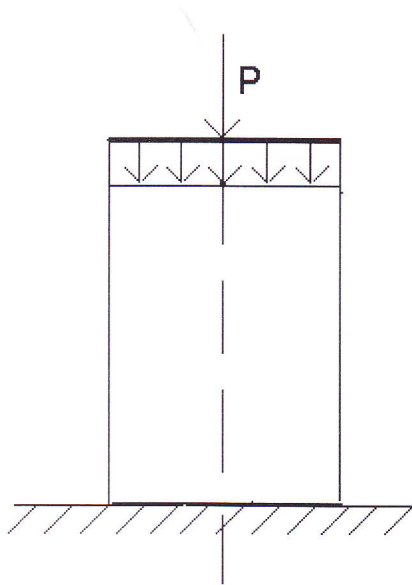

5.3 Test conditions

Container loading – not lesser than by 95% of the container capacity and up to the maximum gross mass (14 t);

Maximum load P κH - 549.4;

Air temperature T C⁰ - 10 to 16;

Test beginning 16:00 April 28, 2014
hour, minM, date

Test completion 16:00 April 29, 2014
hour, minM, date

Load hold time, hours 24.00

Fig.5.1 Test diagram

During the testing four used hydraulic cylinders were connected by the equal pressure scheme. The pressure was controlled with one dynamometer. The load time history curve is shown in Fig. 5.5.

5.4 Deviations

There were no deviations from the agreed test methodology during the tests.

5.5 Test results

The container shell was not damaged. No container contents were lost.

5.6 Conclusion

The container passed the stacking test.

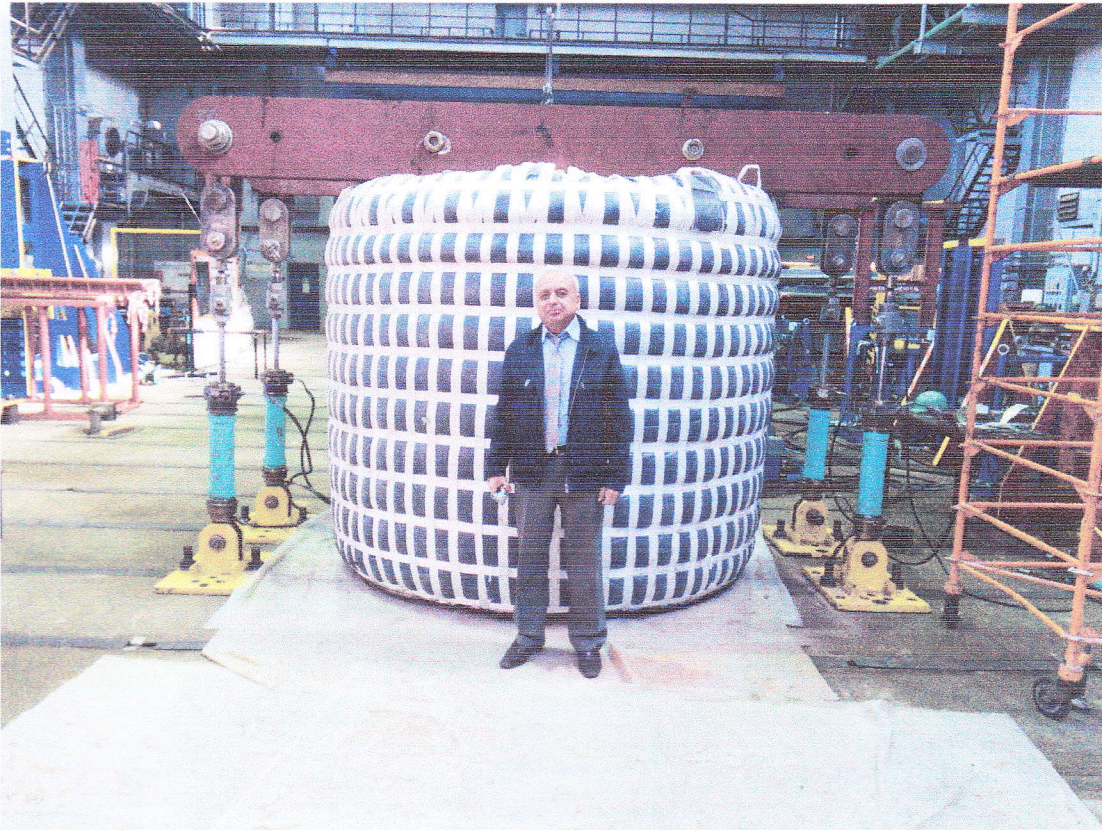

Fig. 5.2. Container on test bench under load at test beginning



Fig. 5.3. Container on test bench after stacking test (top view) beginning

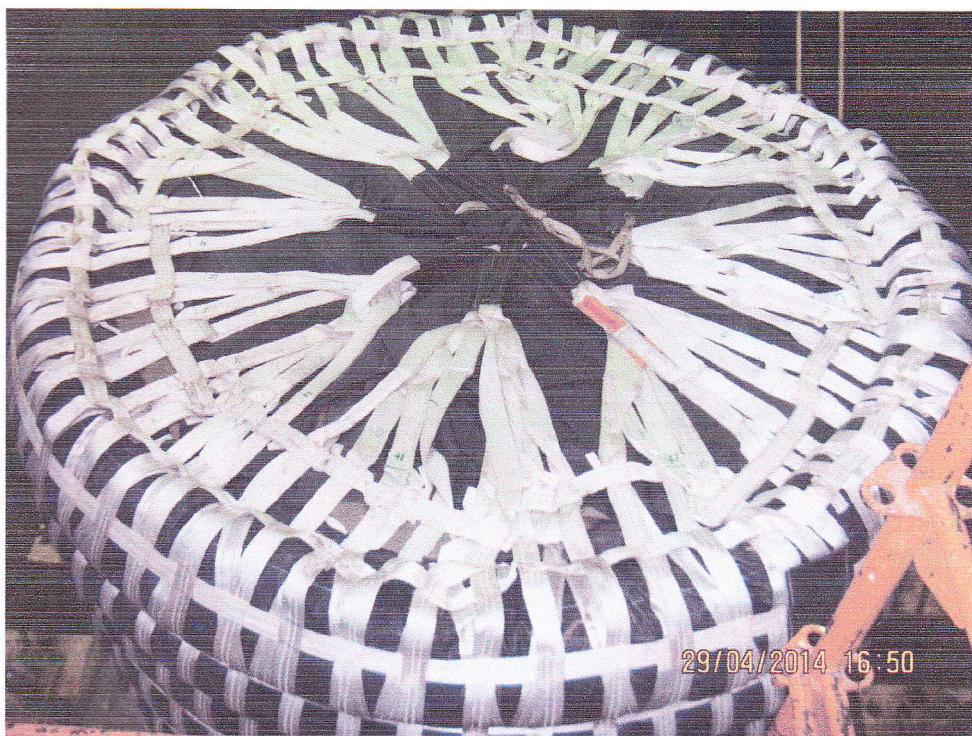

Fig. 5.4. Container with removed pressure disk

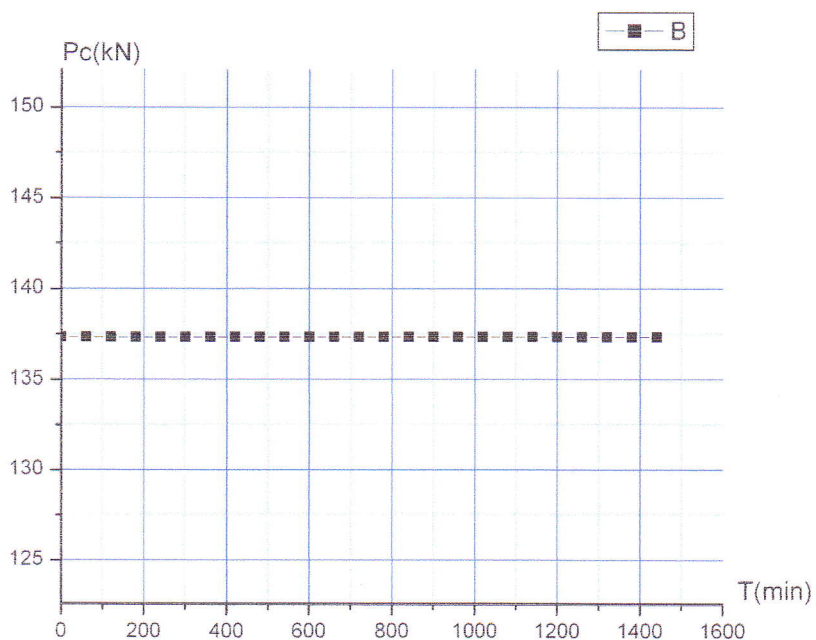

Fig. 5.5. Load time history during testing

Test Manager

E. A. Shishenin

Deputy Head of Laboratory 31

A.V. Aleksandrov

6. Tear tests

6.1 Container registration number is 10414360.

6.2 Test date is April 29, 2014.

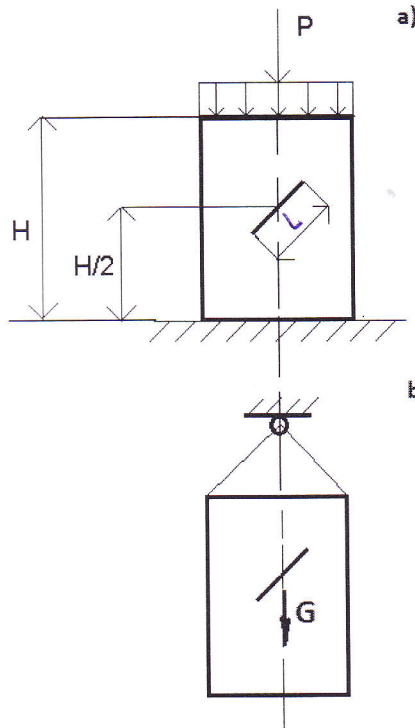

6.3 Test conditions

Container loading – not lesser than by 95% of the container capacity and up to the maximum gross mass (14 t)

| | | |
|----------------------------------|----------------------|------------------------|
| Load P, κH | - | 274.7 |
| Load G, κH | - | 140.0 |
| Air temperature T C ⁰ | - | 16 |
| Test beginning | 16:05 hour, minm, | April 29, 2014 date |

| | | |
|-----------------|----------------------|------------------------|
| Test completion | 17:20 hour, minm, | April 29, 2014 date |
|-----------------|----------------------|------------------------|

| | | |
|--------------------------------------|---|-------|
| Initial cut length L ₀ mm | - | 300 |
| Hold time under load P, min. | | 15.00 |
| (see Fig.6.1a) | | |
| Hold time under load G, min. | | 15.00 |
| (see Fig.6.1b). | | |

Fig.6.1 Test diagram

6.4 Deviations

There were no deviations from the agreed test methodology during the tests.

6.5 Test results

The cut length after the testing was L = 305 mm.

The cut length increase after the testing was $\frac{L - L_0}{L_0} \cdot 100 = 1.6 \%$

6.6 Conclusion

The container passed the tear test.



Fig. 6.1 Container under load 28 tf before tear testing

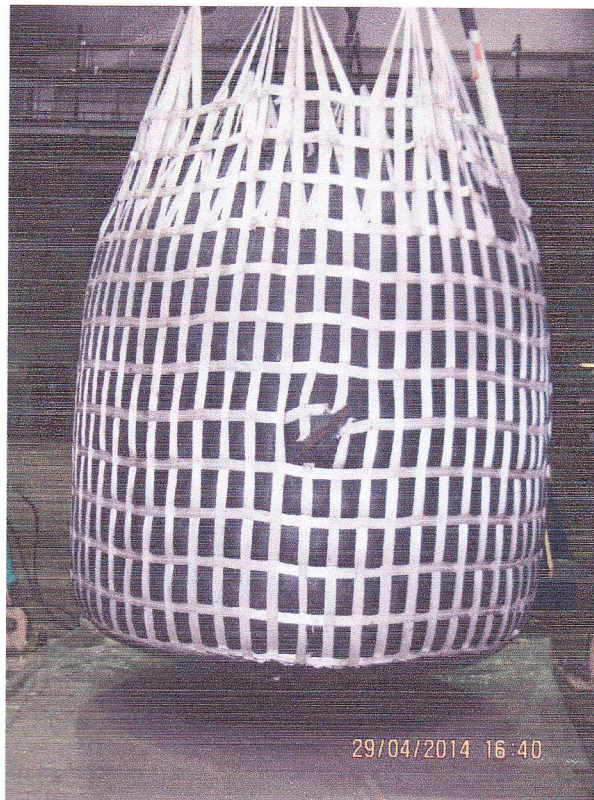

Fig. 6.2 Container under load 14 tf during tear testing



Fig. 6.2 Container after tear testing

Test Manager

E. A. Shishenin

Deputy Head of Laboratory 31

A.V. Aleksandrov

7. Receipt inspection report AR – AR107 P.4-1

St.Petersburg

April 28, 2014.

The soft container of MK-14-10 grade was manufactured in JCSC “New Technologies in Transportation” (Moscow) by Specification 2297-001-56579756-06, approved by Federal Agency “Roszheldor” and JSCo Russian Railways.

Container registration number is 10414360.

Container visual examination and measurement of main dimensions demonstrated the container structure compliance with the drawings. No damage was found in the container shell and loading grippers.

Conclusion: admit the container for the testing.

Test Manager
Senior Research Fellow



E.A. Shishenin

Lead Engineer of Section 314



S.G. Vagengeim

8. Report AR – AR107 P.4-2 The soft container mass evaluation

Report

Mass evaluation for the soft container of MK-14-10 grade during the stacking testing

St.Petersburg

April 28, 2014

We, undersigned, have compiled this report that we have weighted the soft container of MK-14-10 grade using the “Force metering channel No. DSTU-200-20”. Container registration number is 10414360.

In the result of direct measurement it was established that the container mass with the pressure disk was equal to (14000 ± 200) kg. The mass evaluation error complied with RMRS requirements to the accuracy, with which the container mass is to be evaluated.

Test Manager
Senior Research Fellow



E.A. Shishenin

Lead Engineer of Section 314



S.G. Vagengeim

9. Certificate on calibrating instrumentation

ФЕДЕРАЛЬНОЕ ГОСУДАРСТВЕННОЕ УНИТАРНОЕ ПРЕДПРИЯТИЕ
"КРЫЛОВСКИЙ ГОСУДАРСТВЕННЫЙ НАУЧНЫЙ ЦЕНТР"

Метрологическая служба

СЕРТИФИКАТ № 1804/314-14
о калибровке средства измерения

Срок действия до
« 07 » февраля 2015 г.

Канал измерения силы № ДСТУ-200-20 (314 сектор) в составе:

1. Система "ViCont",
2. Датчик силоизмерительный 1798 ДСТУ 2И-200 № 20, мост № 1 (со стороны шильдика).
(наименование средства измерения, состав)

РЕЗУЛЬТАТ КАЛИБРОВКИ

Диапазон измерения силы 20–200 кН (растяжение)

Границы относительной погрешности измерения силы при доверительной вероятности
0,95 (расширенная неопределенность с коэффициентом охвата 2) равны $\pm 1,0 \%$

Условия проведения калибровки: температура окружающего воздуха $+18^\circ\text{C}$;
атмосферное давление 98 кПа; относительная влажность воздуха 70 %.

Калибровка выполнена в соответствии с требованиями методики ИМЯН 307-82-02 МК

ЗАКЛЮЧЕНИЕ: Канал измерения силы № ДСТУ-200-20 на основании результатов
калибровки (протокол № 547 от 07.02.14 г.) допускается к
применению в качестве рабочего средства при проведении
прочностных испытаний
(допускается, не допускается к применению)

Ведущий инженер 314 сектора
(должность специалиста, проводившего калибровку)

(подпись)

А.А. Дудин
(и.о. фамилия)

ГЛАВНЫЙ МЕТРОЛОГ

(подпись)

В. Д. Морозов
(и.о. фамилия)



07 » февраля 2014 г.

10. Certificate of soft container MK 14-10

ПАСПОРТ

мягкого контейнера **МК-14-10** «17» 04 2014

Изготовитель: ЗАО «Новые технологии в перевозках»

Адрес изготовителя: 125009, Россия, Москва,

Малый Гнезниковский пер., дом 12, стр. 4,

Тел./Факс: (495) 629-69-01

| | |
|---|--------------------------|
| • Заводской номер контейнера (соответствует номеру сетки) | 10414360 |
| • Дата изготовления | 17.04.14 |
| • Чертеж | 0-20954.00 |
| • Технические условия | ТУ 2297-001-565797565-06 |
| • Грузоподъемность | 14000кг |
| • Коэффициент безопасности | 6:1 |
| • Сертификаты соответствия контейнера: | |
| - Госстандарта России | РОСС RU.АЯ02.Н42220 |
| - Lloyd's Register | Сертификат № 7/00005 |
| • Вес порожнего контейнера, не более | 70кг |

Назначение: Для транспортирования и временного хранения сыпучих продуктов при температуре окружающей среды от минус 40 до плюс 60°C. Эксплуатировать контейнеры в соответствии с «Руководством по эксплуатации 26469-01РЭ».

Гарантии изготовителя: Изготовитель гарантирует соответствие контейнера требованиям технических условий ТУ 2297-001-565797565-06 при соблюдении потребителем условий эксплуатации, транспортирования и хранения.

Гарантийный срок службы контейнера устанавливается 1 год со дня изготовления, включая время хранения, транспортирования и эксплуатации. Срок эксплуатации может быть продлен по результатам экспресс испытания на остаточную прочность по методике №МИ-009.

Руководитель предприятия Колос / Э. А. Ахундов /

Контролер ОТК Иванченко

CJSC "New Technology in Transportation"
Mr. Emil Akhundov
12, bld.4, Maliy Gnezdnikovsky per.,
125009 Moscow
Russia

Your Sign:

Your letter dd.:

Our Sign:
BAM 3.2/JW
Direct Call
+4930 8104 3908
Fax
+4930 8104 1327
E-Mail:
jan.werner@bam.de
Date:
03.04.2014

Ø
INTERNATIONAL
DANGEROUS GOODS & CONTAINERS ASSOCIATION
General Director Mikhail Ognev
business-center "Resurs", office: 431

35A, Marshal Govorov str.
198095 St. Petersburg
Russia

FBC UN-Tests – Top-Lift Tests

Our Visit and Observation of FBC-Top-Lift Test

Dear Mr. Akhundov, dear Mr. Ognev,

Enclosed you will find our observation report of the Top-Lift Test at Krylov State Research Center.

You will receive the invoice by different letter.

If you have any further questions please do not hesitate to contact us.

Best regards
By order

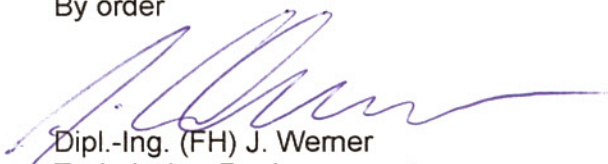

Dipl.-Ing. (FH) J. Werner
Technischer Regierungsamtman

Observation Report

1 Summary

A „Top Lift Test“ according to the Recommendations on the Transport of Dangerous Goods (UN Model Regulations) 6.8.5.3.6. on a Flexible Bulk Container (FBC) was observed at Krylov State Research Center, Moskovskoye Shosse 44 in St. Petersburg (RU) by an independent expert of the Federal Institute for Materials Research and -Testing (BAM) . Two objective loads were tested. Case 1 (84.000 kg) passed the test obviously, case 2 (118.000 kg) could not be completed due to premature failure of the containers bottom.

2 Origination

Background of the attendance by the BAM was the wish of the International Dangerous Goods Container Association (IDGCA) of a neutral observation as well as documentation of the test.

This Observation Report should confirm the correct performance of the test.

It can be added to the Test Report AR-107-P as of 18th march 2014 and given to the members of the RID/ADR/AND Joint Meeting as well as to the members of RID-Committee of Experts, WP.15 and ADN Safety Committee.

3 Observation

The observation occurred in the Krylov State Research Center.

A photo-documentation was not possible because it was prohibited to take own pictures of the test. Only the pictures taken by the IDGCA itself are available. It is not possible to give a statement of the authenticity of those pictures.

3.1 General

All values are seen as correct but could not be verified.

The values are all extracted from the „Test report No. AR-107-P Certification tests for structural type and safety of soft specialized container of MK-14-10 grade“, respectively were taken from the readouts of the measurement instruments.

3.2 Test Setup

The test setup was made as shown in 3.2.4.

3.2.1 Hydraulic system/measurement of forces

To reach the postulated load (case 1: 84.000 kg, case 2: 118.000 kg) four hydro cylinders were applied. They were mounted between a cross-piece bracket arm and a pressure disk. The force of one of them was recorded.

Also the four paths of the hydro cylinders were recorded by computers.

3.2.2 Preload (Grit)

Under the present test report AR-107-P the FBC was preloaded with 18.750 kg of Grit.

3.2.3 Specimen

The specimen (FBC) was fixed with all eight straps to the cross-piece bracket arm. As mentioned in the Test Report AR-107-P as of 18th march 2014 the FBC had the following parameters:

| | |
|---|---|
| Material | Rubbered cloth reinforced with grid of belt bands |
| Maximum carrying capacity, kg (Q_{max}) | 14,000 |
| Maximum holding capacity, m ³ | 15.0 |
| Top structure | Closed with loading arm |
| Bottom structure | Flat blind with discharging arm |
| Lifting device (quantity of lifting eyes) | 8 |
| Presence of insert | No |
| Total quantity of layers when piling | 4 |
| Overall dimensions, cm | 240×240×280 |
| Package group | III |
| Registration number | 11213691 |

3.2.4 Picture of test setup

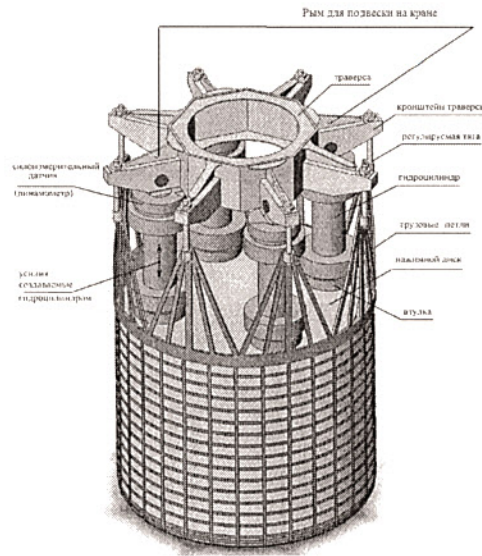

3.3 Test Performance

3.3.1 Objective Load

- a) Case 1: 84.000 kg
- b) Case 2: 118.000 kg

3.3.2 Load Regime

The forces/loads were mustered as shown in table 1:

Table 1 (Load Regime):

| No. | Cylinder load P_{cl} (tf) | Sling load P_s (tf) | Rod travel; 1 st cyl. (mm) | Rod travel; 2 nd cyl. (mm) | Rod travel; 3 rd cyl. (mm) | Rod travel; 4 th cyl. (mm) | Average travel (mm) | Notes |
|-----|--------------------------------|--------------------------|---|---|---|---|------------------------|---|
| 1 | 0 | 18.75 | 0.1 | 0.1 | 0.1 | 0.1 | 0.1 | |
| 2 | 2.72 | 29.63 | 16.1 | 18.3 | 17.9 | 16.4 | 24.58 | |
| 3 | 5.44 | 40.51 | 64.9 | 73.0 | 73.9 | 66.5 | 69.57 | |
| 4 | 8.16 | 51.39 | 131.6 | 145.2 | 145.0 | 129.5 | 137.8 | |
| 5 | 10.88 | 62.27 | 196.4 | 214.1 | 211.7 | 192.2 | 203.6 | |
| 6 | 13.6 | 73.15 | 257.8 | 278.2 | 275.1 | 252.8 | 265.97 | |
| 7 | 16.32 | 84.0 | 314.2 | 337.6 | 330.4 | 307.2 | 322.4 | Holding for 5 minutes |
| 8 | 16.32 | 84.0 | 335 | 359 | 352 | 328 | 343.5 | |
| 9 | 17.06 | 87.0 | | | | | | Failure of bottom ring framework without container loss |

The FBC was detached from the floor at any time of the test.

3.4 Result

Case 1 (84.000 kg) was passed by the specimen and was holded for five minutes.

Case 2 (118.000 kg) was not conducted because of ring framework failure under sling load 87.000 kg.

3.5 Interpretation/Comment

The FBC-straps could not be tested (for load case 2) finally because of failure of ring framework. But the test carried out can only be seen as a fictive loading condition. In real lifting the bottom structure would never have been stressed higher than the straps.

Those 118.000 kg demanded, results only out of the safety factor of 1.4 coming from the angel of 45° (demanded worst case for lifting without traverse).

The bottom structure would never be stressed (in testing) with more than 84.000 kg.

Under reservation of the correct adjustment of all values and parameters we hereby confirm the performance of the test in compliance with the Recommendations on the Transport of Dangerous Goods (UN Model Regulations) 6.8.5.3.6.

Berlin, 03.April 2014

On behalf of

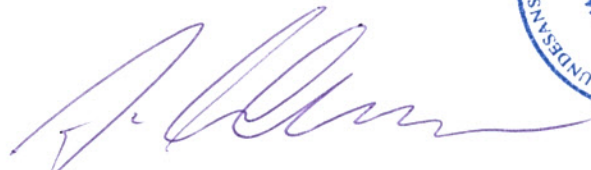

Dipl.-Ing. (FH) J. Werner

Division 3.2

Tanks for Dangerous Goods and Accident Mechanics

Federal Institute for Materials Research and Testing (BAM)

Krylov State Research Center

196158, St. Petersburg
44 Moscovskoye Shosse,
Fax (812) 727-96-32
Tel. (812) 727-95-93

Copy No. 1



APPROVED BY

M. Shaposhnikov
M. Shaposhnikov
Head of Strength &
Structure Division

April 30, 2014

Test report No. AR-107-P.4

**Certification tests for structural type and safety of soft specialized
container of MK-14-10 grade**

Made in 3 copies.

Экз. No. 1 – to Customer

Экз. No. 2 – RMRS.

Экз. No. 3 – Laboratory Archives

Test results refer to the tested
entity only..

Reproduction of the report and its parts
without written permission of
Krylov State Research Center is
forbidden.

St. Petersburg
2014

Table of contents

| | |
|---|----|
| 1. General | 3 |
| 2. Test equipment and instrumentation..... | 4 |
| 3. Documents | 4 |
| 4. Test procedure..... | 4 |
| 5. Stacking tests | 5 |
| 6. Tear tests | 8 |
| 7. Receipt inspection report AR – AR107 P.4-1..... | 11 |
| 8. Report AR – AR107 P.4-2 The soft container mass evaluation | 12 |
| 9. Certificate on calibrating instrumentation | 13 |
| 10. Certificate of soft container MK 14-10..... | 15 |

1. General

1.1. A soft container of MK-14-10 grade having the following characteristics was tested.

| | |
|--|---|
| Material | Rubbered cloth reinforced with grid of belt bands |
| Maximum carrying capacity, kgf (Q_{max}) | 14,000 |
| Maximum holding capacity, m ³ | 15.0 |
| Top structure | Closed with loading arm |
| Bottom structure | Flat blind with discharging arm |
| Lifting device (quantity of lifting eyes) | 8 |
| Presence of insert | No |
| Total quantity of layers when piling | 4 |
| Overall dimensions, cm | 240×240×280 |
| Package group | III |
| Registration number | 10414360 |

1.2 Test types:

- stacking tests;
- tear tests.

1.3 Basis for the testing – Contract No. 331-31/13 dated 31.01.14 with CJSC New Technologies in Transportation

1.4. The following attended the testing:

From SJSC “New Technologies in Transportation” – Emil A. Akhiundov,

From CJSC MFRI – Evgeny B. Karpovich

From DNV GL – Boris A. Vishniakov

From CJSC Russian Register - Igor G. Sannikov



1.5 The test entity was supplied to the laboratory on April 21, 2014

1.6. The tests were conducted on April 22, 2014 – April 29.2014

2. Test equipment and instrumentation

Force metering channel DSTU -200-20 consisting of:

- Vi Cont system
- Force-measuring transducer 1798 DSTU-2I-200-No.20, bridge No.1, Certificate No. 1804/314-14 valid up to February 07, 2015.

3. Documents

3.1. Test program for the structural type and safety of soft specialized container of MK-14-10 grade.

3.2. Methodology IMAN 31-406-14 MI “Soft containers. Topple, Righting, Tear and Stacking Tests of Container MK-14-10. Test Methodology”.

3.3. Methodology IMAN 31-258-00 MI “Soft containers. Strength Characteristics. Test Methodology”.

3.4. Certification of Automatic Loading Channels for SNPK2000-300 System. Methodology IMAN 307-310-00MA.

4. Test procedure

Actions for the container preparation for the testing are explained in the methodology IMAN 31-406-14 MI “Soft containers. Topple, Righting, Tear and Stacking Tests of Container MK-14-10. Test Methodology.”

(Information required in the test report is given below for each test type on individual pages).

5. Stacking tests

5.1 Container registration number is 10414360.

5.2 Test date is April 28 to 29, 2014.

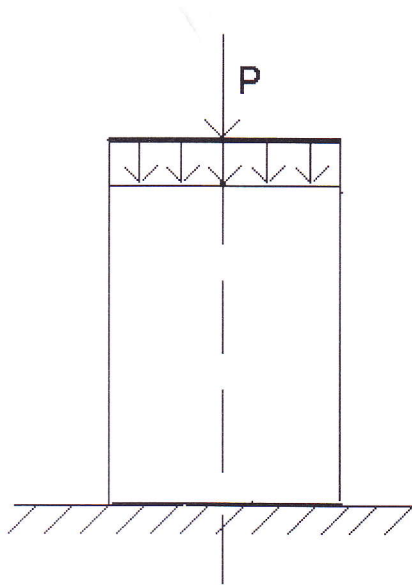

5.3 Test conditions

Container loading – not lesser than by 95% of the container capacity and up to the maximum gross mass (14 t);

Maximum load P κH - 549.4;

Air temperature T C⁰ - 10 to 16;

Test beginning 16:00 April 28, 2014
hour, minM, date

Test completion 16:00 April 29, 2014
hour, minM, date

Load hold time, hours 24.00

Fig.5.1 Test diagram

During the testing four used hydraulic cylinders were connected by the equal pressure scheme. The pressure was controlled with one dynamometer. The load time history curve is shown in Fig. 5.5.

5.4 Deviations

There were no deviations from the agreed test methodology during the tests.

5.5 Test results

The container shell was not damaged. No container contents were lost.

5.6 Conclusion

The container passed the stacking test.

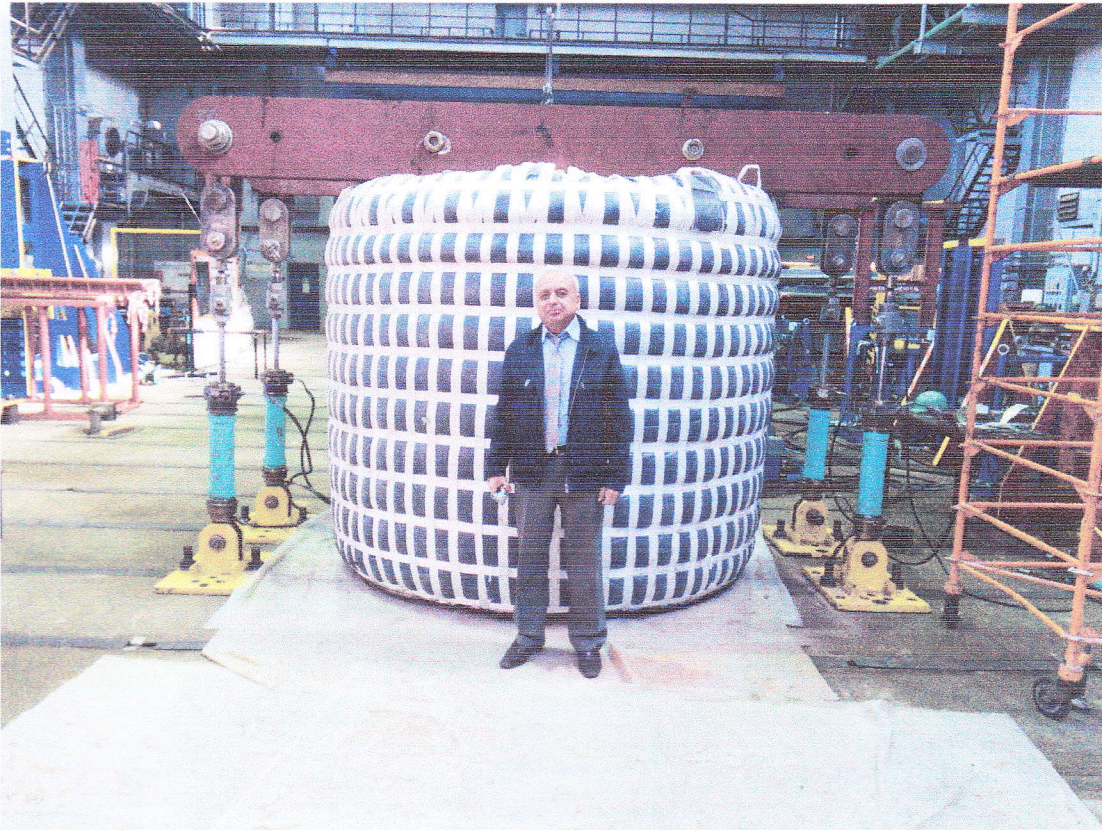

Fig. 5.2. Container on test bench under load at test beginning



Fig. 5.3. Container on test bench after stacking test (top view) beginning

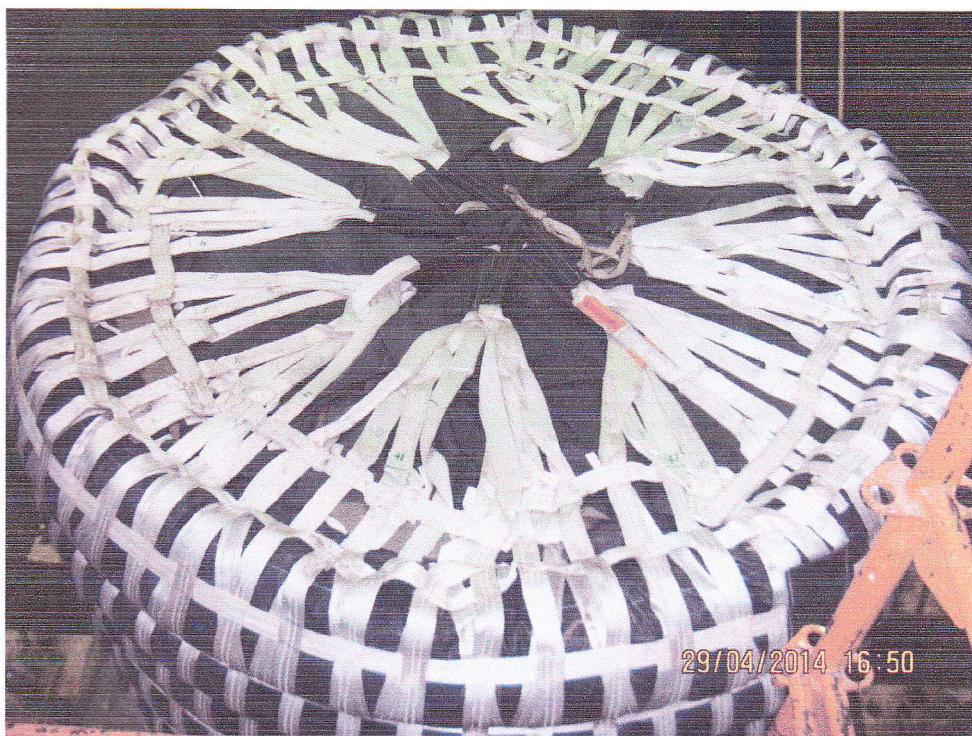

Fig. 5.4. Container with removed pressure disk

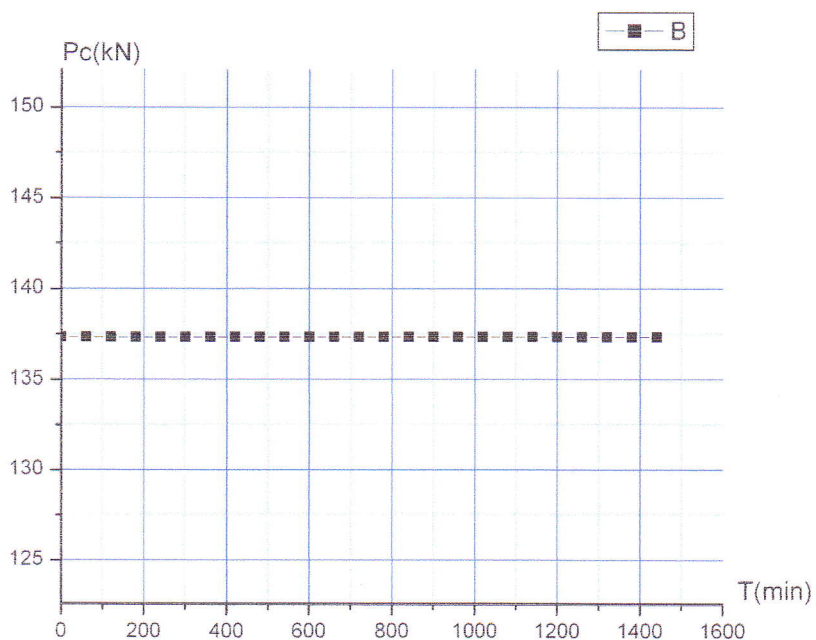

Fig. 5.5. Load time history during testing

Test Manager

E. A. Shishenin

Deputy Head of Laboratory 31

A.V. Aleksandrov

6. Tear tests

6.1 Container registration number is 10414360.

6.2 Test date is April 29, 2014.

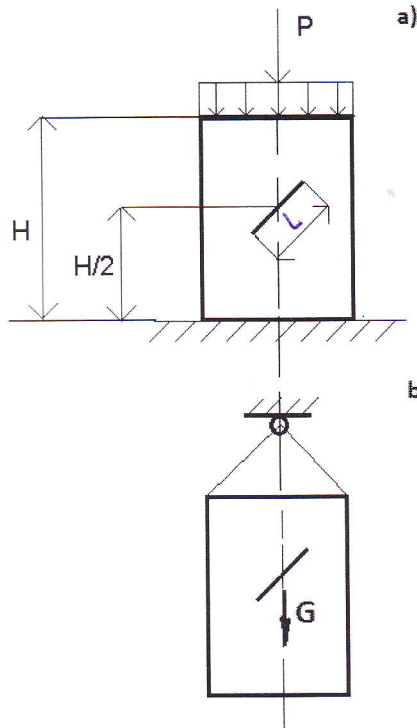

6.3 Test conditions

Container loading – not lesser than by 95% of the container capacity and up to the maximum gross mass (14 t)

| | | |
|----------------------------------|----------------------|------------------------|
| Load P, κH | - | 274.7 |
| Load G, κH | - | 140.0 |
| Air temperature T C ⁰ | - | 16 |
| Test beginning | 16:05 hour, minM, | April 29, 2014 date |
| Test completion | 17:20 hour, minM, | April 29, 2014 date |

| | | |
|--------------------------------------|---|-------|
| Initial cut length L ₀ mm | - | 300 |
| Hold time under load P, min. | | 15.00 |
| (see Fig.6.1a) | | |
| Hold time under load G, min. | | 15.00 |
| (see Fig.6.1b). | | |

Fig.6.1 Test diagram

6.4 Deviations

There were no deviations from the agreed test methodology during the tests.

6.5 Test results

The cut length after the testing was $L = 305$ mm.

The cut length increase after the testing was $\frac{L - L_0}{L_0} \cdot 100 = 1.6 \%$

6.6 Conclusion

The container passed the tear test.



Fig. 6.1 Container under load 28 tf before tear testing

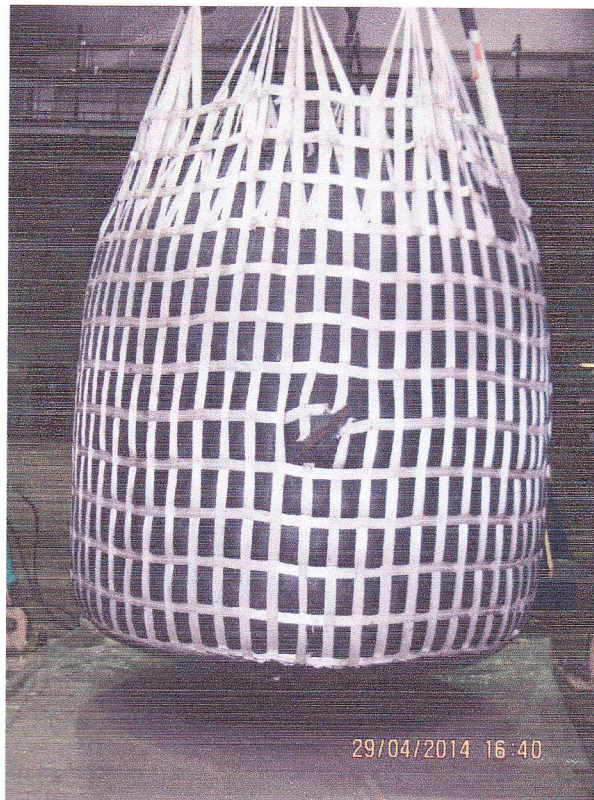

Fig. 6.2 Container under load 14 tf during tear testing



Fig. 6.2 Container after tear testing

Test Manager

E. A. Shishenin

Deputy Head of Laboratory 31

A.V. Aleksandrov

7. Receipt inspection report AR – AR107 P.4-1

St.Petersburg

April 28, 2014.

The soft container of MK-14-10 grade was manufactured in JCSC “New Technologies in Transportation” (Moscow) by Specification 2297-001-56579756-06, approved by Federal Agency “Roszheldor” and JSCo Russian Railways.

Container registration number is 10414360.

Container visual examination and measurement of main dimensions demonstrated the container structure compliance with the drawings. No damage was found in the container shell and loading grippers.

Conclusion: admit the container for the testing.

Test Manager
Senior Research Fellow



E.A. Shishenin

Lead Engineer of Section 314



S.G. Vagengeim

8. Report AR – AR107 P.4-2 The soft container mass evaluation

Report

Mass evaluation for the soft container of MK-14-10 grade during the stacking testing

St.Petersburg

April 28, 2014

We, undersigned, have compiled this report that we have weighted the soft container of MK-14-10 grade using the “Force metering channel No. DSTU-200-20”. Container registration number is 10414360.

In the result of direct measurement it was established that the container mass with the pressure disk was equal to (14000 ± 200) kg. The mass evaluation error complied with RMRS requirements to the accuracy, with which the container mass is to be evaluated.

Test Manager
Senior Research Fellow



E.A. Shishenin

Lead Engineer of Section 314



S.G. Vagengeim

9. Certificate on calibrating instrumentation

ФЕДЕРАЛЬНОЕ ГОСУДАРСТВЕННОЕ УНИТАРНОЕ ПРЕДПРИЯТИЕ
"КРЫЛОВСКИЙ ГОСУДАРСТВЕННЫЙ НАУЧНЫЙ ЦЕНТР"

Метрологическая служба

СЕРТИФИКАТ № 1804/314-14
о калибровке средства измерения

Срок действия до
« 07 » февраля 2015 г.

Канал измерения силы № ДСТУ-200-20 (314 сектор) в составе:

1. Система "ViCont",
2. Датчик силоизмерительный 1798 ДСТУ 2И-200 № 20, мост № 1 (со стороны шильдика).
(наименование средства измерения, состав)

РЕЗУЛЬТАТ КАЛИБРОВКИ

Диапазон измерения силы 20–200 кН (растяжение)

Границы относительной погрешности измерения силы при доверительной вероятности
0,95 (расширенная неопределенность с коэффициентом охвата 2) равны $\pm 1,0 \%$

Условия проведения калибровки: температура окружающего воздуха $+18^\circ\text{C}$;
атмосферное давление 98 кПа; относительная влажность воздуха 70 %.

Калибровка выполнена в соответствии с требованиями методики ИМЯН 307-82-02 МК

ЗАКЛЮЧЕНИЕ: Канал измерения силы № ДСТУ-200-20 на основании результатов
калибровки (протокол № 547 от 07.02.14 г.) допускается к
применению в качестве рабочего средства при проведении
прочностных испытаний
(допускается, не допускается к применению)

Ведущий инженер 314 сектора
(должность специалиста, проводившего калибровку)

(подпись)

А.А. Дудин
(и.о. фамилия)

ГЛАВНЫЙ МЕТРОЛОГ

(подпись)

В. Д. Морозов
(и.о. фамилия)



07 » февраля 2014 г.

10. Certificate of soft container MK 14-10

ПАСПОРТ

мягкого контейнера **МК-14-10** «17» 04 2014

Изготовитель: ЗАО «Новые технологии в перевозках»

Адрес изготовителя: 125009, Россия, Москва,

Малый Гнезниковский пер., дом 12, стр. 4,

Тел./Факс: (495) 629-69-01

| | |
|--|--------------------------|
| • Заводской номер контейнера (соответствует номеру сетки) | 10414360 |
| • Дата изготовления | 17.04.14 |
| • Чертеж | 0-20954.00 |
| • Технические условия | ТУ 2297-001-565797565-06 |
| • Грузоподъемность | 14000кг |
| • Коэффициент безопасности | 6:1 |
| • Сертификаты соответствия контейнера: | |
| - Госстандарта России | РОСС RU.АЯ02.Н42220 |
| - Lloyd's Register | Сертификат № 7/00005 |
| • Вес порожнего контейнера, не более | 70кг |

Назначение: Для транспортирования и временного хранения сыпучих продуктов при температуре окружающей среды от минус 40 до плюс 60°C. Эксплуатировать контейнеры в соответствии с «Руководством по эксплуатации 26469-01РЭ».

Гарантии изготовителя: Изготовитель гарантирует соответствие контейнера требованиям технических условий ТУ 2297-001-565797565-06 при соблюдении потребителем условий эксплуатации, транспортирования и хранения.

Гарантийный срок службы контейнера устанавливается 1 год со дня изготовления, включая время хранения, транспортирования и эксплуатации. Срок эксплуатации может быть продлен по результатам экспресс испытания на остаточную прочность по методике №МИ-009.

Руководитель предприятия Колос / Э. А. Ахундов /

Контролер ОТК Иванченко

CJSC "New Technology in Transportation"
Mr. Emil Akhundov
12, bld.4, Maliy Gnezdnikovsky per.,
125009 Moscow
Russia

Your Sign:

Your letter dd.:

Our Sign:
BAM 3.2/JW
Direct Call
+4930 8104 3908
Fax
+4930 8104 1327
E-Mail:
jan.werner@bam.de
Date:
03.04.2014

Ø
INTERNATIONAL
DANGEROUS GOODS & CONTAINERS ASSOCIATION
General Director Mikhail Ognev
business-center "Resurs", office: 431

35A, Marshal Govorov str.
198095 St. Petersburg
Russia

FBC UN-Tests – Top-Lift Tests

Our Visit and Observation of FBC-Top-Lift Test

Dear Mr. Akhundov, dear Mr. Ognev,

Enclosed you will find our observation report of the Top-Lift Test at Krylov State Research Center.

You will receive the invoice by different letter.

If you have any further questions please do not hesitate to contact us.

Best regards
By order

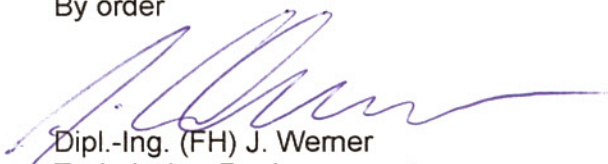

Dipl.-Ing. (FH) J. Werner
Technischer Regierungsamtman

Observation Report

1 Summary

A „Top Lift Test“ according to the Recommendations on the Transport of Dangerous Goods (UN Model Regulations) 6.8.5.3.6. on a Flexible Bulk Container (FBC) was observed at Krylov State Research Center, Moskovskoye Shosse 44 in St. Petersburg (RU) by an independent expert of the Federal Institute for Materials Research and -Testing (BAM) . Two objective loads were tested. Case 1 (84.000 kg) passed the test obviously, case 2 (118.000 kg) could not be completed due to premature failure of the containers bottom.

2 Origination

Background of the attendance by the BAM was the wish of the International Dangerous Goods Container Association (IDGCA) of a neutral observation as well as documentation of the test.

This Observation Report should confirm the correct performance of the test.

It can be added to the Test Report AR-107-P as of 18th march 2014 and given to the members of the RID/ADR/AND Joint Meeting as well as to the members of RID-Committee of Experts, WP.15 and ADN Safety Committee.

3 Observation

The observation occurred in the Krylov State Research Center.

A photo-documentation was not possible because it was prohibited to take own pictures of the test. Only the pictures taken by the IDGCA itself are available. It is not possible to give a statement of the authenticity of those pictures.

3.1 General

All values are seen as correct but could not be verified.

The values are all extracted from the „Test report No. AR-107-P Certification tests for structural type and safety of soft specialized container of MK-14-10 grade“, respectively were taken from the readouts of the measurement instruments.

3.2 Test Setup

The test setup was made as shown in 3.2.4.

3.2.1 Hydraulic system/measurement of forces

To reach the postulated load (case 1: 84.000 kg, case 2: 118.000 kg) four hydro cylinders were applied. They were mounted between a cross-piece bracket arm and a pressure disk. The force of one of them was recorded.

Also the four paths of the hydro cylinders were recorded by computers.

3.2.2 Preload (Grit)

Under the present test report AR-107-P the FBC was preloaded with 18.750 kg of Grit.

3.2.3 Specimen

The specimen (FBC) was fixed with all eight straps to the cross-piece bracket arm. As mentioned in the Test Report AR-107-P as of 18th march 2014 the FBC had the following parameters:

| | |
|---|---|
| Material | Rubbered cloth reinforced with grid of belt bands |
| Maximum carrying capacity, kg (Q_{max}) | 14,000 |
| Maximum holding capacity, m ³ | 15.0 |
| Top structure | Closed with loading arm |
| Bottom structure | Flat blind with discharging arm |
| Lifting device (quantity of lifting eyes) | 8 |
| Presence of insert | No |
| Total quantity of layers when piling | 4 |
| Overall dimensions, cm | 240×240×280 |
| Package group | III |
| Registration number | 11213691 |

3.2.4 Picture of test setup

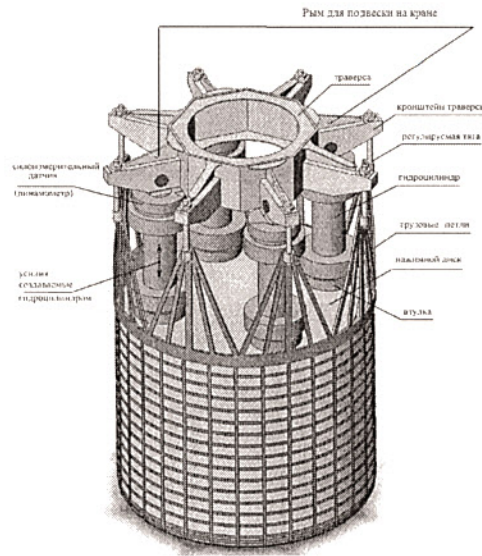

3.3 Test Performance

3.3.1 Objective Load

- a) Case 1: 84.000 kg
- b) Case 2: 118.000 kg

3.3.2 Load Regime

The forces/loads were mustered as shown in table 1:

Table 1 (Load Regime):

| No. | Cylinder load P_{cl} (tf) | Sling load P_s (tf) | Rod travel; 1 st cyl. (mm) | Rod travel; 2 nd cyl. (mm) | Rod travel; 3 rd cyl. (mm) | Rod travel; 4 th cyl. (mm) | Average travel (mm) | Notes |
|-----|--------------------------------|--------------------------|---|---|---|---|------------------------|---|
| 1 | 0 | 18.75 | 0.1 | 0.1 | 0.1 | 0.1 | 0.1 | |
| 2 | 2.72 | 29.63 | 16.1 | 18.3 | 17.9 | 16.4 | 24.58 | |
| 3 | 5.44 | 40.51 | 64.9 | 73.0 | 73.9 | 66.5 | 69.57 | |
| 4 | 8.16 | 51.39 | 131.6 | 145.2 | 145.0 | 129.5 | 137.8 | |
| 5 | 10.88 | 62.27 | 196.4 | 214.1 | 211.7 | 192.2 | 203.6 | |
| 6 | 13.6 | 73.15 | 257.8 | 278.2 | 275.1 | 252.8 | 265.97 | |
| 7 | 16.32 | 84.0 | 314.2 | 337.6 | 330.4 | 307.2 | 322.4 | Holding for 5 minutes |
| 8 | 16.32 | 84.0 | 335 | 359 | 352 | 328 | 343.5 | |
| 9 | 17.06 | 87.0 | | | | | | Failure of bottom ring framework without container loss |

The FBC was detached from the floor at any time of the test.

3.4 Result

Case 1 (84.000 kg) was passed by the specimen and was holded for five minutes.

Case 2 (118.000 kg) was not conducted because of ring framework failure under sling load 87.000 kg.

3.5 Interpretation/Comment

The FBC-straps could not be tested (for load case 2) finally because of failure of ring framework. But the test carried out can only be seen as a fictive loading condition. In real lifting the bottom structure would never have been stressed higher than the straps.

Those 118.000 kg demanded, results only out of the safety factor of 1.4 coming from the angel of 45° (demanded worst case for lifting without traverse).

The bottom structure would never be stressed (in testing) with more than 84.000 kg.

Under reservation of the correct adjustment of all values and parameters we hereby confirm the performance of the test in compliance with the Recommendations on the Transport of Dangerous Goods (UN Model Regulations) 6.8.5.3.6.

Berlin, 03.April 2014

On behalf of

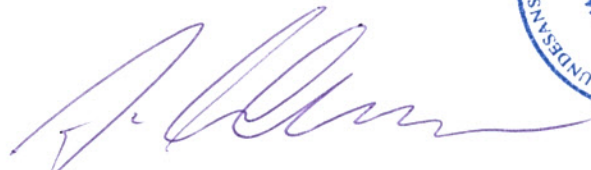

Dipl.-Ing. (FH) J. Werner

Division 3.2

Tanks for Dangerous Goods and Accident Mechanics

Federal Institute for Materials Research and Testing (BAM)