



Economic and Social Council

Distr.: General
15 April 2014

Original: English

Economic Commission for Europe

Inland Transport Committee

World Forum for Harmonization of Vehicle Regulations

163rd session

Geneva, 24-27 June 2014

Item 4.7.3 of the provisional agenda

**1958 Agreement – Consideration of draft amendments
to existing Regulations submitted by GRPE**

Proposal for the 07 series of amendments to Regulation No. 83 (Emissions of M₁ and N₁ vehicles)

Submitted by the Working Party on Pollution and Energy *

The text reproduced below was adopted by the Working Party on Pollution and Energy (GRPE) at its sixty-eighth session (ECE/TRANS/WP.29/GRPE/68, para. 22). It is based on ECE/TRANS/WP.29/GRPE/2014/2 as amended by GRPE-68-08, GRPE-68-07-Rev.1 and para. 22 of the report. It is submitted to the World Forum for Harmonization of Vehicle Regulations (WP.29) and to the Administrative Committee AC.1 for consideration.

* In accordance with the programme of work of the Inland Transport Committee for 2012–2016 (ECE/TRANS/224, para. 94 and ECE/TRANS/2012/12, programme activity 02.4), the World Forum will develop, harmonize and update Regulations in order to enhance the performance of vehicles. The present document is submitted in conformity with that mandate.



Regulation No. 83

Uniform provisions concerning the approval of vehicles with regard to the emission of pollutants according to engine fuel requirements

1. Scope

This Regulation establishes technical requirements for the type approval of motor vehicles.

In addition, this Regulation lays down rules for in-service conformity, durability of pollution control devices and on-board diagnostic (OBD) systems.

- 1.1. This Regulation shall apply to vehicles of categories M₁, M₂, N₁ and N₂ with a reference mass not exceeding 2,610 kg.¹

At the manufacturer's request, type approval granted under this Regulation may be extended from vehicles mentioned above to M₁, M₂, N₁ and N₂ vehicles with a reference mass not exceeding 2,840 kg and which meet the conditions laid down in this Regulation.

2. Definitions

For the purposes of this Regulation the following definitions shall apply:

- 2.1. "*Vehicle type*" means a group of vehicles that do not differ in the following respects:
- 2.1.1. The equivalent inertia determined in relation to the reference mass as prescribed in Annex 4a, Table A4a/3 to this Regulation; and
- 2.1.2. The engine and vehicle characteristics as defined in Annex 1 to this Regulation;
- 2.2. "*Reference mass*" means the unladen mass of the vehicle increased by a uniform figure of 100 kg for test according to Annexes 4a and 8 to this Regulation;
- 2.2.1. "*Unladen mass*" means the mass of the vehicle in running order without the uniform mass of the driver of 75 kg, passengers or load, but with the fuel tank 90 per cent full and the usual set of tools and spare wheel on board, where applicable;
- 2.2.2. "*Running order mass*" means the mass described in paragraph 2.6. of Annex 1 to this Regulation and for vehicles designed and constructed for the carriage of more than 9 persons (in addition to the driver), the mass of a crew member (75 kg), if there is a crew seat amongst the nine or more seats;

¹ As defined in the Consolidated Resolution on the Construction of Vehicles (R.E.3.), document ECE/TRANS/WP.29/78/Rev.3, para. 2. - www.unece.org/trans/main/wp29/wp29wgs/wp29gen/wp29resolutions.html.

- 2.3. "*Maximum mass*" means the technically permissible maximum mass declared by the vehicle manufacturer (this mass may be greater than the maximum mass authorised by the national administration);
- 2.4. "*Gaseous pollutants*" means the exhaust gas emissions of carbon monoxide, oxides of nitrogen expressed in nitrogen dioxide (NO₂) equivalent and hydrocarbons assuming ratio of:
- (a) C₁H_{2.525} for liquefied petroleum gas (LPG);
 - (b) C₁H₄ for natural gas (NG) and biomethane;
 - (c) C₁H_{1.89}O_{0.016} for petrol (E5);
 - (d) C₁H_{1.93}O_{0.033} for petrol (E10);
 - (e) C₁H_{1.86}O_{0.005} for diesel (B5);
 - (f) C₁H_{1.86}O_{0.007} for diesel (B7);
 - (g) C₁H_{2.74}O_{0.385} for ethanol (E85);
 - (h) C₁H_{2.61}O_{0.329} for ethanol (E75).
- 2.5. "*Particulate pollutants*" means components of the exhaust gas which are removed from the diluted exhaust gas at a maximum temperature of 325 K (52 °C) by means of the filters described in Appendix 4 to Annex 4a to this Regulation.
- 2.5.1. "*Particle numbers*" means the total number of particles of a diameter greater than 23 nm diameter present in the diluted exhaust gas after it has been conditioned to remove volatile material, as described in Appendix 5 to Annex 4a to this Regulation.
- 2.6. "*Exhaust emissions*" means
- (a) For positive-ignition (P.I.) engines, emissions of gaseous and particulate pollutants;
 - (b) For compression-ignition (C.I.) engines, emissions of gaseous pollutants, particulate pollutants and particle numbers;
- 2.7. "*Evaporative emissions*" means the hydrocarbon vapours lost from the fuel system of a motor vehicle other than those from exhaust emissions;
- 2.7.1. "*Tank breathing losses*" are hydrocarbon emissions caused by temperature changes in the fuel tank (assuming a ratio of C₁H_{2.33}).
- 2.7.2. "*Hot soak losses*" are hydrocarbon emissions arising from the fuel system of a stationary vehicle after a period of driving (assuming a ratio of C₁H_{2.20});
- 2.8. "*Engine crankcase*" means the spaces in or external to an engine which are connected to the oil sump by internal or external ducts through which gases and vapour can escape;
- 2.9. "*Cold start device*" means a device that temporarily enriches the air/fuel mixture of the engine thus assisting the engine to start;
- 2.10. "*Starting aid*" means a device which assists engine start up without enrichment of the air/fuel mixture of the engine, e.g. glow plug, injection timing change, etc.;
- 2.11. "*Engine capacity*" means:
- 2.11.1. For reciprocating piston engines, the nominal engine swept volume;
 - 2.11.2. For rotary piston engines (Wankel), twice the nominal swept volume of a combustion chamber per piston;
- 2.12. "*Pollution control devices*" means those components of a vehicle that control and/or limit exhaust and evaporative emissions.

- 2.13. "OBD" means an on-board diagnostic system for emission control, which has the capability of identifying the likely area of malfunction by means of fault codes stored in computer memory;
- 2.14. "In-service test" means the test and evaluation of conformity conducted in accordance with paragraph 9.2.1. of this Regulation;
- 2.15. "Properly maintained and used" means, for the purpose of a test vehicle, that such a vehicle satisfies the criteria for acceptance of a selected vehicle laid down in paragraph 2. of Appendix 3 to this Regulation;
- 2.16. "Defeat device" means any element of design which senses temperature, vehicle speed, engine rotational speed, transmission gear, manifold vacuum or any other parameter for the purpose of activating, modulating, delaying or deactivating the operation of any part of the emission control system, that reduces the effectiveness of the emission control system under conditions which may reasonably be expected to be encountered in normal vehicle operation and use. Such an element of design may not be considered a defeat device if:
- 2.16.1. The need for the device is justified in terms of protecting the engine against damage or accident and for safe operation of the vehicle; or
- 2.16.2. The device does not function beyond the requirements of engine starting; or
- 2.16.3. Conditions are substantially included in the Type I or Type VI test procedures.
- 2.17. "Family of vehicles" means a group of vehicle types identified by a parent vehicle for the purpose of Annex 12 to this Regulation;
- 2.18. "Biofuel" means liquid or gaseous fuel for transport, produced from biomass.
- 2.19. "Approval of a vehicle" means the approval of a vehicle type with regard to the limitation of the following conditions:²
- 2.19.1. Limitation of exhaust emissions by the vehicle, evaporative emissions, crankcase emissions, durability of pollution control devices, cold start pollutant emissions and on-board diagnostics of vehicles fuelled with unleaded petrol, or which can be fuelled with either unleaded petrol and LPG or NG/biomethane or biofuels (Approval B);
- 2.19.2. Limitation of emissions of gaseous and particulate pollutants, durability of pollution control devices and on-board diagnostics of vehicles fuelled with diesel fuel (Approval C) or which can be fuelled with either diesel fuel and biofuel or biofuel;
- 2.19.3. Limitation of emissions of gaseous pollutants by the engine, crankcase emissions, durability of pollution control devices, cold start emissions and on-board diagnostics of vehicles fuelled with LPG or NG/biomethane (Approval D);
- 2.20. "Periodically regenerating system" means an anti-pollution device (e.g. catalytic converter, particulate trap) that requires a periodical regeneration process in less than 4,000 km of normal vehicle operation. During cycles where regeneration occurs, emission standards can be exceeded. If a regeneration of an anti-pollution device occurs at least once

² Approval A cancelled. The 05 series of amendments to this Regulation prohibit the use of leaded petrol.

per Type I test and that has already regenerated at least once during vehicle preparation cycle, it will be considered as a continuously regenerating system which does not require a special test procedure. Annex 13 to this Regulation does not apply to continuously regenerating systems.

At the request of the manufacturer, the test procedure specific to periodically regenerating systems will not apply to a regenerative device if the manufacturer provides data to the Type Approval Authority that, during cycles where regeneration occurs, emissions remain below the standards given in paragraph 5.3.1.4. applied for the concerned vehicle category after agreement of the Technical Service.

- 2.21. Hybrid vehicles (HV)
- 2.21.1. General definition of hybrid vehicles (HV):
- "*Hybrid vehicle (HV)*" means a vehicle with at least two different energy converters and two different energy storage systems (on vehicle) for the purpose of vehicle propulsion.
- 2.21.2. Definition of hybrid electric vehicles (HEV):
- "*Hybrid electric vehicle (HEV)*" means a vehicle, including vehicles which draw energy from a consumable fuel only for the purpose of recharging the electrical energy/power storage device, that for the purpose of mechanical propulsion, draws energy from both of the following on-vehicle sources of stored energy/power:
- (a) A consumable fuel;
 - (b) A battery, capacitor, flywheel/generator or other electrical energy/power storage device.
- 2.22. "*Mono-fuel vehicle*" means a vehicle that is designed to run primarily on one type of fuel;
- 2.22.1. "*Mono-fuel gas vehicle*" means a vehicle that is designed primarily for permanent running on LPG or NG/biomethane or hydrogen, but may also have a petrol system for emergency purposes or starting only, where the capacity of the petrol tank does not exceed 15 litres.
- 2.23. "*Bi-fuel vehicle*" means a vehicle with two separate fuel storage systems that is designed to run on only one fuel at a time. The simultaneous use of both fuels is limited in amount and duration.
- 2.23.1. "*Bi-fuel gas vehicle*" means a bi fuel vehicle that can run on petrol (petrol mode) and also on either LPG, NG/biomethane, or hydrogen (gas mode).
- 2.24. "*Alternative fuel vehicle*" means a vehicle designed to be capable of running on at least one type of fuel that is either gaseous at atmospheric temperature and pressure, or substantially non-mineral oil derived.
- 2.25. "*Flex fuel vehicle*" means a vehicle with one fuel storage system that can run on different mixtures of two or more fuels.
- 2.25.1. "*Flex fuel ethanol vehicle*" means a flex fuel vehicle that can run on petrol or a mixture of petrol and ethanol up to an 85 per cent ethanol blend (E85).
- 2.25.2. "*Flex fuel biodiesel vehicle*" means a flex fuel vehicle that can run on mineral diesel or a mixture of mineral diesel and biodiesel.
- 2.26. "*Vehicles designed to fulfil specific social needs*" means diesel vehicles of category M₁ which are either:

- (a) Special purpose vehicles with reference mass exceeding 2,000 kg³;
 - (b) Vehicles with a reference mass exceeding 2,000 kg and designed to carry seven or more occupants including the driver with the exclusion of vehicles of category M₁G;³
 - (c) Vehicles with a reference mass exceeding 1,760 kg which are built specifically for commercial purposes to accommodate wheelchair use inside the vehicle.
- 2.27. In the context of in use performance ratio monitoring (IUPR_M), "*cold start*" means an engine coolant temperature (or equivalent temperature) at engine start of less than or equal to 35 °C and less than or equal to 7 K higher than ambient temperature (if available) at engine start.
- 2.28. "*Direct injection engine*" means an engine which can operate in a mode where the fuel is injected into the intake air after the air has been drawn through the inlet valves.
- 2.29. "*Electric power train*" means a system consisting of one or more electric energy storage devices, one or more electric power conditioning devices and one or more electric machines that convert stored electric energy to mechanical energy delivered at the wheels for propulsion of the vehicle.
- 2.30. "*Pure electric vehicle*" means a vehicle powered by an electric power train only.
- 2.31. "*Hydrogen fuel cell vehicle*" means a vehicle powered by a fuel cell that converts chemical energy from hydrogen into electric energy, for propulsion of the vehicle.
- 2.32. "*Net power*" means the power obtained on a test bench at the end of the crankshaft or its equivalent at the corresponding engine or motor speed with the auxiliaries, tested in accordance with Regulation No. 85 and determined under reference atmospheric conditions;
- 2.33. "*Maximum net power*" means the maximum value of the net power measured at full engine load.
- 2.34. "*Maximum 30 minutes power*" means the maximum net power of an electric drive train at DC voltage as set out in paragraph 5.3.2. of Regulation No. 85.
- 2.35. "*Cold start*" means an engine coolant temperature (or equivalent temperature) at engine start less than or equal to 35 °C and less than or equal to 7 K higher than ambient temperature (if available) at engine start.

3. Application for approval

- 3.1. The application for approval of a vehicle type with regard to exhaust emissions, crankcase emissions, evaporative emissions and durability of pollution control devices, as well as to its on-board diagnostic (OBD) system shall be submitted by the vehicle manufacturer or by his authorized representative to the Type Approval Authority.

³ As defined in the Consolidated Resolution on the Construction of Vehicles (R.E.3.), document ECE/TRANS/WP.29/78/Rev.3, para. 2. - www.unece.org/trans/main/wp29/wgs/wp29gen/wp29resolutions.html.

- 3.1.1. In addition, the manufacturer shall submit the following information:
- (a) In the case of vehicles equipped with positive-ignition engines, a declaration by the manufacturer of the minimum percentage of misfires out of a total number of firing events that would either result in emissions exceeding the limits given in paragraph 3.3.2. of Annex 11 to this Regulation, if that percentage of misfire had been present from the start of a Type I test as described in Annex 4a to this Regulation, or that could lead to an exhaust catalyst, or catalysts, overheating prior to causing irreversible damage;
 - (b) Detailed written information fully describing the functional operation characteristics of the OBD system, including a listing of all relevant parts of the emission control system of the vehicle that are monitored by the OBD system;
 - (c) A description of the malfunction indicator used by the OBD system to signal the presence of a fault to a driver of the vehicle;
 - (d) A declaration by the manufacturer that the OBD system complies with the provisions of paragraph 7. of Appendix 1 to Annex 11 to this Regulation relating to in-use performance under all reasonably foreseeable driving conditions;
 - (e) A plan describing the detailed technical criteria and justification for incrementing the numerator and denominator of each monitor that shall fulfil the requirements of paragraphs 7.2. and 7.3. of Appendix 1 to Annex 11 to this Regulation, as well as for disabling numerators, denominators and the general denominator under the conditions outlined in paragraph 7.7. of Appendix 1 to Annex 11 to this Regulation;
 - (f) A description of the provisions taken to prevent tampering with and modification of the emission control computer;
 - (g) If applicable, the particulars of the vehicle family as referred to in Appendix 2 to Annex 11 to this Regulation;
 - (h) Where appropriate, copies of other type approvals with the relevant data to enable extension of approvals and establishment of deterioration factors.
- 3.1.2. For the tests described in paragraph 3. of Annex 11 to this Regulation, a vehicle representative of the vehicle type or vehicle family fitted with the OBD system to be approved shall be submitted to the Technical Service responsible for the type approval test. If the Technical Service determines that the submitted vehicle does not fully represent the vehicle type or vehicle family described in Appendix 2 to Annex 11 to this Regulation, an alternative and if necessary an additional vehicle shall be submitted for test in accordance with paragraph 3. of Annex 11 to this Regulation.
- 3.2. A model of the information document relating to exhaust emissions, evaporative emissions, durability and the on-board diagnostic (OBD) system is given in Annex 1 to this Regulation. The information mentioned under item 3.2.12.2.7.6. of Annex 1 to this Regulation is to be included in Appendix 1 "OBD - Related information" to the type-approval communication given in Annex 2 to this Regulation.
- 3.2.1. Where appropriate, copies of other type approvals with the relevant data to enable extensions of approvals and establishment of deterioration factors shall be submitted.

- 3.3. For the tests described in paragraph 5. of this Regulation a vehicle representative of the vehicle type to be approved shall be submitted to the Technical Service responsible for the approval tests.
- 3.4.1. The application referred to in paragraph 3.1. of this Regulation shall be drawn up in accordance with the model of the information document set out in Annex 1 to this Regulation.
- 3.4.2. For the purposes of paragraph 3.1.1.(d), the manufacturer shall use the model of a manufacturer's certificate of compliance with the OBD in-use performance requirements set out in Appendix 2 to Annex 2 to this Regulation.
- 3.4.3. For the purposes of paragraph 3.1.1.(e), the Type Approval Authority that grants the approval shall make the information referred to in that point available to the Type Approval Authorities upon request.
- 3.4.5. For the purposes of points (d) and (e) of paragraph 3.1.1. of this Regulation, approval authorities shall not approve a vehicle if the information submitted by the manufacturer is inappropriate for fulfilling the requirements of paragraph 7. of Appendix 1 to Annex 11 to this Regulation. Paragraphs 7.2., 7.3. and 7.7. of Appendix 1 to Annex 11 to this Regulation shall apply under all reasonably foreseeable driving conditions. For the assessment of the implementation of the requirements set out in the first and second subparagraphs, the approval authorities shall take into account the state of technology.
- 3.4.6. For the purposes of paragraph 3.1.1.(f) of this Regulation, the provisions taken to prevent tampering with and modification of the emission control computer shall include the facility for updating using a manufacturer-approved programme or calibration.
- 3.4.7. For the tests specified in Table A, the manufacturer shall submit to the Technical Service responsible for the type approval tests a vehicle representative of the type to be approved.
- 3.4.8. The application for type approval of flex-fuel vehicles shall comply with the additional requirements laid down in paragraphs 4.9.1. and 4.9.2. of this Regulation.
- 3.4.9. Changes to the make of a system, component or separate technical unit that occur after a type approval shall not automatically invalidate a type approval, unless its original characteristics or technical parameters are changed in such a way that the functionality of the engine or pollution control system is affected.

4. Approval

- 4.1. If the vehicle type submitted for approval following this amendment meets the requirements of paragraph 5. of this Regulation, approval of that vehicle type shall be granted.
- 4.2. An approval number shall be assigned to each type approved.

Its first two digits shall indicate the series of amendments according to which the approval was granted. The same Contracting Party shall not assign the same number to another vehicle type.
- 4.3. Notice of approval or of extension or refusal of approval of a vehicle type pursuant to this Regulation shall be communicated to the Contracting Parties

- to the Agreement which apply this Regulation by means of a form conforming to the model in Annex 2 to this Regulation.
- 4.3.1. In the event of amendment to the present text, for example, if new limit values are prescribed, the Contracting Parties to the Agreement shall be informed which vehicle types already approved comply with the new provisions.
- 4.4. There shall be affixed, conspicuously and in a readily accessible place specified on the approval form, to every vehicle conforming to a vehicle type approved under this Regulation, an international approval mark consisting of:
- 4.4.1. A circle surrounding the letter "E" followed by the distinguishing number of the country that has granted approval.⁴
- 4.4.2. The number of this Regulation, followed by the letter "R", a dash and the approval number to the right of the circle described in paragraph 4.4.1. of this Regulation.
- 4.4.3. The approval mark shall contain an additional character after the type approval number, the purpose of which is to distinguish vehicle category and class for which the approval has been granted. This letter should be chosen according to the Table A3/1 in Annex 3 to this Regulation.
- 4.5. If the vehicle conforms to a vehicle type approved, under one or more other Regulations annexed to the Agreement, in the country which has granted approval under this Regulation, the symbol prescribed in paragraph 4.4.1. of this Regulation need not be repeated; in such a case, the Regulation and approval numbers and the additional symbols of all the Regulations under which approval has been granted in the country which has granted approval under this Regulation shall be placed in vertical columns to the right of the symbol prescribed in paragraph 4.4.1. of this Regulation.
- 4.6. The approval mark shall be clearly legible and be indelible.
- 4.7. The approval mark shall be placed close to or on the vehicle data plate.
- 4.7.1. Annex 3 to this Regulation gives examples of arrangements of the approval mark.
- 4.8. Additional requirements for vehicles fuelled by LPG or NG/biomethane
- 4.8.1. The additional requirements for vehicles fuelled by LPG or NG/biomethane are provided in Annex 12 to this Regulation.
- 4.9. Additional requirements for approval of flex fuel vehicles
- 4.9.1. For the type approval of a flex fuel ethanol or biodiesel vehicle, the vehicle manufacturer shall describe the capability of the vehicle to adapt to any mixture of petrol and ethanol fuel (up to an 85 per cent ethanol blend) or diesel and biodiesel that may occur across the market.
- 4.9.2. For flex fuel vehicles, the transition from one reference fuel to another between the tests shall take place without manual adjustment of the engine settings.

⁴ The distinguishing numbers of the Contracting Parties to the 1958 Agreement are reproduced in Annex 3 to the Consolidated Resolution on the Construction of Vehicles (R.E.3), document ECE/TRANS/WP.29/78/Rev.3 – Annex 3, www.unece.org/trans/main/wp29/wgs/wp29gen/wp29resolutions.html.

- 4.10. Requirements for approval regarding the OBD system
- 4.10.1. The manufacturer shall ensure that all vehicles are equipped with an OBD system.
- 4.10.2. The OBD system shall be designed, constructed and installed on a vehicle so as to enable it to identify types of deterioration or malfunction over the entire life of the vehicle.
- 4.10.3. The OBD system shall comply with the requirements of this Regulation during conditions of normal use.
- 4.10.4. When tested with a defective component in accordance with Appendix 1 to Annex 11 to this Regulation, the OBD system malfunction indicator shall be activated. The OBD system malfunction indicator may also activate during this test at levels of emissions below the OBD threshold limits specified in Annex 11 to this Regulation.
- 4.10.5. The manufacturer shall ensure that the OBD system complies with the requirements for in-use performance set out in paragraph 7. of Appendix 1 to Annex 11 to this Regulation under all reasonably foreseeable driving conditions.
- 4.10.6. In-use performance related data to be stored and reported by a vehicle's OBD system according to the provisions of paragraph 7.6. of Appendix 1 to Annex 11 to this Regulation shall be made readily available by the manufacturer to national authorities and independent operators without any encryption.

5. Specifications and tests

Small volume manufacturers

As an alternative to the requirements of this paragraph, vehicle manufacturers whose world-wide annual production is less than 10,000 units may obtain approval on the basis of the corresponding technical requirements specified in the table below.

<i>Legislative Act</i>	<i>Requirements</i>
The California Code of Regulations, Title 13, paragraphs 1961(a) and 1961(b)(1)(C)(1) applicable to 2001 and later model year vehicles, 1968.1, 1968.2, 1968.5, 1976 and 1975, published by Barclay's Publishing.	Type approval shall be granted under the California Code of Regulations applicable to the most recent model year of light duty vehicle.

The emissions tests for roadworthiness purposes set out in Annex 5 to this Regulation and the requirements for access to vehicle OBD information set out in paragraph 5. of Annex 11 to this Regulation shall still be required to obtain type approval with regard to emissions under this paragraph.

The Type Approval Authority shall inform the other approval authorities of Contracting Parties of the circumstances of each type approval granted under this paragraph.

- 5.1. General
 - 5.1.1. The components liable to affect the emission of pollutants shall be so designed, constructed and assembled as to enable the vehicle, in normal use,

despite the vibration to which they may be subjected, to comply with the provisions of this Regulation.

- 5.1.2. The technical measures taken by the manufacturer shall be such as to ensure that in conformity with the provisions of this Regulation, exhaust gas and evaporative emissions are effectively limited throughout the normal life of the vehicle and under normal conditions of use. This will include the security of those hoses and their joints and connections, used within the emission control systems, which shall be so constructed as to conform with the original design intent. For exhaust emissions, these provisions are deemed to be met if the provisions of paragraph 5.3.1. of this Regulation and paragraph 8.2. of this Regulation are complied with. For evaporative emissions, these conditions are deemed to be met if the provisions of paragraph 5.3.4. of this Regulation and paragraph 8.4. of this Regulation are complied with.
- 5.1.2.1. The use of a defeat device is prohibited.
- 5.1.3. Inlet orifices of petrol tanks
 - 5.1.3.1. Subject to paragraph 5.1.3.2. of this Regulation, the inlet orifice of the petrol or ethanol tank shall be so designed as to prevent the tank from being filled from a fuel pump delivery nozzle which has an external diameter of 23.6 mm or greater.
 - 5.1.3.2. Paragraph 5.1.3.1. of this Regulation shall not apply to a vehicle in respect of which both of the following conditions are satisfied, i.e.:
 - 5.1.3.2.1. The vehicle is so designed and constructed that no device designed to control the emission of gaseous pollutants shall be adversely affected by leaded petrol; and
 - 5.1.3.2.2. The vehicle is conspicuously, legibly and indelibly marked with the symbol for unleaded petrol, specified in ISO 2575:1982, in a position immediately visible to a person filling the petrol tank. Additional markings are permitted.
- 5.1.4. Provision shall be made to prevent excess evaporative emissions and fuel spillage caused by a missing fuel filler cap. This may be achieved by using one of the following:
 - 5.1.4.1. An automatically opening and closing, non-removable fuel filler cap;
 - 5.1.4.2. Design features which avoid excess evaporative emissions in the case of a missing fuel filler cap; or
 - 5.1.4.3. Any other provision which has the same effect. Examples may include, but are not limited to, a tethered filler cap, a chained filler cap or one utilising the same locking key for the filler cap as for the vehicle's ignition. In this case, the key shall be removable from the filler cap only in the locked condition.
- 5.1.5. Provisions for electronic system security
 - 5.1.5.1. Any vehicle with an emission control computer shall include features to prevent modification, except as authorised by the manufacturer. The manufacturer shall authorise modifications if these modifications are necessary for the diagnosis, servicing, inspection, retrofitting or repair of the vehicle. Any reprogrammable computer codes or operating parameter shall be resistant to tampering and afford a level of protection at least as good as the provisions in ISO DIS 15031-7, dated 15 March 2001 (SAE J2186 dated October 1996). Any removable calibration memory chips shall be potted, encased in a sealed container, or protected by electronic algorithms and shall not be changeable without the use of specialised tools and procedures. Only

- features directly associated with emissions calibration or prevention of vehicle theft may be so protected.
- 5.1.5.2. Computer-coded engine operating parameters shall not be changeable without the use of specialised tools and procedures (e. g. soldered or potted computer components or sealed (or soldered) computer enclosures).
- 5.1.5.3. In the case of mechanical fuel-injection pumps fitted to compression-ignition engines, manufacturers shall take adequate steps to protect the maximum fuel delivery setting from tampering while a vehicle is in service.
- 5.1.5.4. Manufacturers may apply to the Type Approval Authority for an exemption to one of these requirements for those vehicles which are unlikely to require protection. The criteria that the Type Approval Authority will evaluate in considering an exemption will include, but are not limited to, the current availability of performance chips, the high-performance capability of the vehicle and the projected sales volume of the vehicle.
- 5.1.5.5. Manufacturers using programmable computer code systems (e.g. Electrical Erasable Programmable Read-Only Memory, EEPROM) shall deter unauthorised reprogramming. Manufacturers shall include enhanced tamper protection strategies and write protect features requiring electronic access to an off-site computer maintained by the manufacturer. Methods giving an adequate level of tamper protection will be approved by the Type Approval Authority.
- 5.1.6. It shall be possible to inspect the vehicle for roadworthiness test in order to determine its performance in relation to the data collected in accordance with paragraph 5.3.7. of this Regulation. If this inspection requires a special procedure, this shall be detailed in the service manual (or equivalent media). This special procedure shall not require the use of special equipment other than that provided with the vehicle.
- 5.2. Test procedure
- Table A illustrates the various possibilities for type approval of a vehicle.
- 5.2.1. Positive ignition engine-powered vehicles and hybrid electric vehicles equipped with a positive-ignition engine shall be subject to the following tests:
- Type I (verifying the average exhaust emissions after a cold start);
- Type II (carbon monoxide emission at idling speed);
- Type III (emission of crankcase gases);
- Type IV (evaporation emissions);
- Type V (durability of anti-pollution devices);
- Type VI (verifying the average low ambient temperature carbon monoxide and hydrocarbon exhaust emissions after a cold start);
- OBD-test;
- Engine power test.
- 5.2.2. Positive ignition engine-powered vehicle and hybrid electric vehicles equipped with positive-ignition engine fuelled with LPG or NG/biomethane (mono or bi-fuel) shall be subjected to the following tests (according to Table A):
- Type I (verifying the average exhaust emissions after a cold start);

Type II (carbon monoxide emissions at idling speed);

Type III (emission of crankcase gases);

Type IV (evaporative emissions), where applicable;

Type V (durability of anti-pollution devices);

Type VI (verifying the average low ambient temperature carbon monoxide and hydrocarbon exhaust emissions after a cold start), where applicable,

OBD test;

Engine power test.

5.2.3. Compression ignition engine-powered vehicles and hybrid electric vehicles equipped with a compression ignition engine shall be subject to the following tests:

Type I (verifying the average exhaust emissions after a cold start);

Type V (durability of anti-pollution control devices);

OBD test;

Table A. Requirements
Application of test requirements for type approval and extensions

Vehicle category	Vehicles with positive ignition engines including hybrids								Vehicles with compression ignition engines including hybrids	
	Mono fuel				Bi-fuel ¹			Flex-fuel ¹	Flex fuel	Mono fuel
Reference fuel	Petrol (E5/E10) ⁷	LPG	NG/ Bio-methane	Hydrogen (ICE) ⁵	Petrol (E5/E10) ⁷	Petrol (E5/E10) ⁷	Petrol (E5/E10) ⁷	Petrol (E5/E10) ⁷	Diesel (B5/B7) ⁷	Diesel (B5/B7) ⁷
					LPG	NG/ Biome-thane	Hydrogen (ICE) ⁵	Ethanol (E85)	Biodiesel	
Gaseous pollutants (Type 1 test)	Yes	Yes	Yes	Yes ⁴	Yes (both fuels)	Yes (both fuels)	Yes (both fuels) ⁴	Yes (both fuels)	Yes (B5/B7 only) ^{2,7}	Yes
Particulate mass and particulate number (Type I test)	Yes ⁶	—	—	—	Yes (petrol only) ⁶	Yes (petrol only) ⁶	Yes (petrol only) ⁶	Yes (both fuels) ⁶	Yes (B5/B7 only) ^{2,7}	Yes
Idle emissions (Type II test)	Yes	Yes	Yes	—	Yes (both fuels)	Yes (both fuels)	Yes (petrol only)	Yes (both fuels)	—	—
Crankcase emissions (Type III test)	Yes	Yes	Yes	—	Yes (petrol only)	Yes (petrol only)	Yes (petrol only)	Yes (petrol only)	—	—
Evaporative emissions (Type IV test)	Yes	—	—	—	Yes (petrol only)	Yes (petrol only)	Yes (petrol only)	Yes (petrol only)	—	—
Durability (Type V test)	Yes	Yes	Yes	Yes	Yes (petrol only)	Yes (petrol only)	Yes (petrol only)	Yes (petrol only)	Yes (B5/B7 only) ^{2,7}	Yes
Low temperature emissions (Type VI test)	Yes	—	—	—	Yes (petrol only)	Yes (petrol only)	Yes (petrol only)	Yes ³ (both fuels)	—	—
In-service conformity	Yes	Yes	Yes	Yes	Yes (both fuels)	Yes (both fuels)	Yes (both fuels)	Yes (both fuels)	Yes (B5/B7 only) ^{2,7}	Yes
On-board diagnostics	Yes	Yes	Yes	Yes	Yes	Yes	Yes	Yes	Yes	Yes

¹ When a bi-fuel vehicle is combined with a flex fuel vehicle, both test requirements are applicable.

² This provision is temporary, further requirements for biodiesel shall be proposed later on.

³ The test will be performed on both fuels. The E75 test reference fuel specified in Annex 10 shall be used.

⁴ Only NOx emissions shall be determined when the vehicle is running on hydrogen.

⁵ Reference fuel is 'Hydrogen for internal combustion engines' as specified in Annex 10a.

⁶ Positive ignition particulate mass and number limits for vehicles with positive ignition engines including hybrids shall apply only to vehicles with direct injection engines..

⁷ Upon the choice of the manufacturer vehicles with positive and compression ignition engines may be tested with either E5 or E10 and either B5 or B7 fuels, respectively. However:

- not later than sixteen months after the dates set out in point 12.2.1, new type -approvals shall only be performed with E10 and B7 fuels;
- not later than as from dates set out in point 12.2.4, all new vehicles shall be approved with E10 and B7 fuels.

- 5.3. Description of tests
- 5.3.1. Type I test (Simulating the average exhaust emissions after a cold start).
- 5.3.1.1. Figure 1 illustrates the routes for Type I test. This test shall be carried out on all vehicles referred to in paragraph 1. of this Regulation.
- 5.3.1.2. The vehicle is placed on a chassis dynamometer equipped with a means of load and inertia simulation.
- 5.3.1.2.1. A test lasting a total of 19 minutes and 40 seconds, made up of two parts, One and Two, is performed without interruption. An unsampled period of not more than 20 seconds may, with the agreement of the manufacturer, be introduced between the end of Part One and the beginning of Part Two in order to facilitate adjustment of the test equipment.
- 5.3.1.2.1.1. Vehicles that are fuelled with LPG or NG/biomethane shall be tested in the Type I test for variation in the composition of LPG or NG/biomethane, as set out in Annex 12 to this Regulation. Vehicles that can be fuelled either with petrol or LPG or NG/biomethane shall be tested on both the fuels, tests on LPG or NG/biomethane being performed for variation in the composition of LPG or NG/biomethane, as set out in Annex 12 to this Regulation.
- 5.3.1.2.1.2. Notwithstanding the requirement of paragraph 5.3.1.2.1.1. of this Regulation, vehicles that can be fuelled with either petrol or a gaseous fuel, but where the petrol system is fitted for emergency purposes or starting only and which the petrol tank cannot contain more than 15 litres of petrol will be regarded for the Type I test as vehicles that can only run on a gaseous fuel.
- 5.3.1.2.2. Part One of the test is made up of four elementary urban cycles. Each elementary urban cycle comprises fifteen phases (idling, acceleration, steady speed, deceleration, etc.).
- 5.3.1.2.3. Part Two of the test is made up of one extra-urban cycle. The extra-urban cycle comprises 13 phases (idling, acceleration, steady speed, deceleration, etc.).
- 5.3.1.2.4. During the test the exhaust gases are diluted and a proportional sample collected in one or more bags. The exhaust gases of the vehicle tested are diluted, sampled and analysed, following the procedure described below, and the total volume of the diluted exhaust is measured. Not only are the carbon monoxide, hydrocarbon and nitrogen oxide emissions recorded, but also the particulate pollutant emissions from vehicles equipped with compression-ignition engines.
- 5.3.1.3. The test is carried out using the procedure of Type I test as described in Annex 4a to this Regulation. The method used to collect and analyse the gases is prescribed in Appendix 2 and Appendix 3 to Annex 4a to this Regulation, and the method to sample and analyse the particulates shall be as prescribed in Appendix 4 and Appendix 5 to Annex 4a to this Regulation.
- 5.3.1.4. Subject to the requirements of paragraph 5.3.1.5. of this Regulation the test shall be repeated three times. The results are multiplied by the appropriate deterioration factors obtained from Table 3 in paragraph 5.3.6. of this Regulation and, in the case of periodically regenerating systems as defined in paragraph 2.20., also must be multiplied by the factors K_i obtained from Annex 13 to this Regulation. The resulting masses of gaseous emissions and the mass of and number of particulates obtained shall be less than the limits shown in Table 1:

Table 1
Emissions limits

		Reference mass (RM) (kg)	Limit values													
			Mass of carbon monoxide (CO)		Mass of total hydrocarbons (THC)		Mass of non- methane hydrocarbons (NMHC)		Mass of oxides of nitrogen (NO _x)		Combined mass of hydrocarbons and oxides of nitrogen (THC + NO _x)		Mass of particulate matter (PM)		Number of particles (PN)	
			L ₁ (mg/km)		L ₂ (mg/km)		L ₃ (mg/km)		L ₄ (mg/km)		L ₂ + L ₄ (mg/km)		L ₅ (mg/km)		L ₆ (#/km)	
Category	Class		PI	CI	PI	CI	PI	CI	PI	CI	PI	CI	PI ⁽¹⁾	CI	PI ⁽¹⁾⁽²⁾	CI
M	—	All	1,000	500	100	—	68	—	60	80	—	170	4.5	4.5	6.0 × 10 ¹¹	6.0 × 10 ¹¹
N ₁	I	RM ≤ 1,305	1,000	500	100	—	68	—	60	80	—	170	4.5	4.5	6.0 × 10 ¹¹	6.0 × 10 ¹¹
	II	1,305 < RM ≤ 1,760	1,810	630	130	—	90	—	75	105	—	195	4.5	4.5	6.0 × 10 ¹¹	6.0 × 10 ¹¹
	III	1,760 < RM	2,270	740	160	—	108	—	82	125	—	215	4.5	4.5	6.0 × 10 ¹¹	6.0 × 10 ¹¹
N ₂	—	All	2,270	740	160	—	108	—	82	125	—	215	4.5	4.5	6.0 × 10 ¹¹	6.0 × 10 ¹¹

PI Positive Ignition

CI Compression Ignition

¹ Positive ignition particulate mass and number limits shall apply only to vehicles with direct injection engines.

² Until three years after the dates specified in paragraphs 12.2.1. and 12.2.2. of this Regulation for new type approvals and new vehicles respectively, a particle number emission limit of 6.0 × 10¹² #/km shall apply to PI direct injection vehicles upon the choice of the manufacturer.

- 5.3.1.4.1. Notwithstanding the requirements of paragraph 5.3.1.4. of this Regulation, for each pollutant or combination of pollutants, one of the three resulting masses obtained may exceed, by not more than 10 per cent, the limit prescribed, provided the arithmetical mean of the three results is below the prescribed limit. Where the prescribed limits are exceeded for more than one pollutant, it is immaterial whether this occurs in the same test or in different tests.
- 5.3.1.4.2. When the tests are performed with gaseous fuels, the resulting mass of gaseous emissions shall be less than the limits for petrol-engined vehicles in the Table 1.
- 5.3.1.5. The number of tests prescribed in paragraph 5.3.1.4. of this Regulation is reduced in the conditions hereinafter defined, where V_1 is the result of the first test and V_2 the result of the second test for each pollutant or for the combined emission of two pollutants subject to limitation.
- 5.3.1.5.1. Only one test is performed if the result obtained for each pollutant or for the combined emission of two pollutants subject to limitation, is less than or equal to 0.70 L (i.e. $V_1 \leq 0.70$ L).
- 5.3.1.5.2. If the requirement of paragraph 5.3.1.5.1. of this Regulation is not satisfied, only two tests are performed if, for each pollutant or for the combined emission of two pollutants subject to limitation, the following requirements are met:
- $V_1 \leq 0.85$ L and $V_1 + V_2 \leq 1.70$ L and $V_2 \leq L$.

Figure 1
Flow chart for Type I type approval

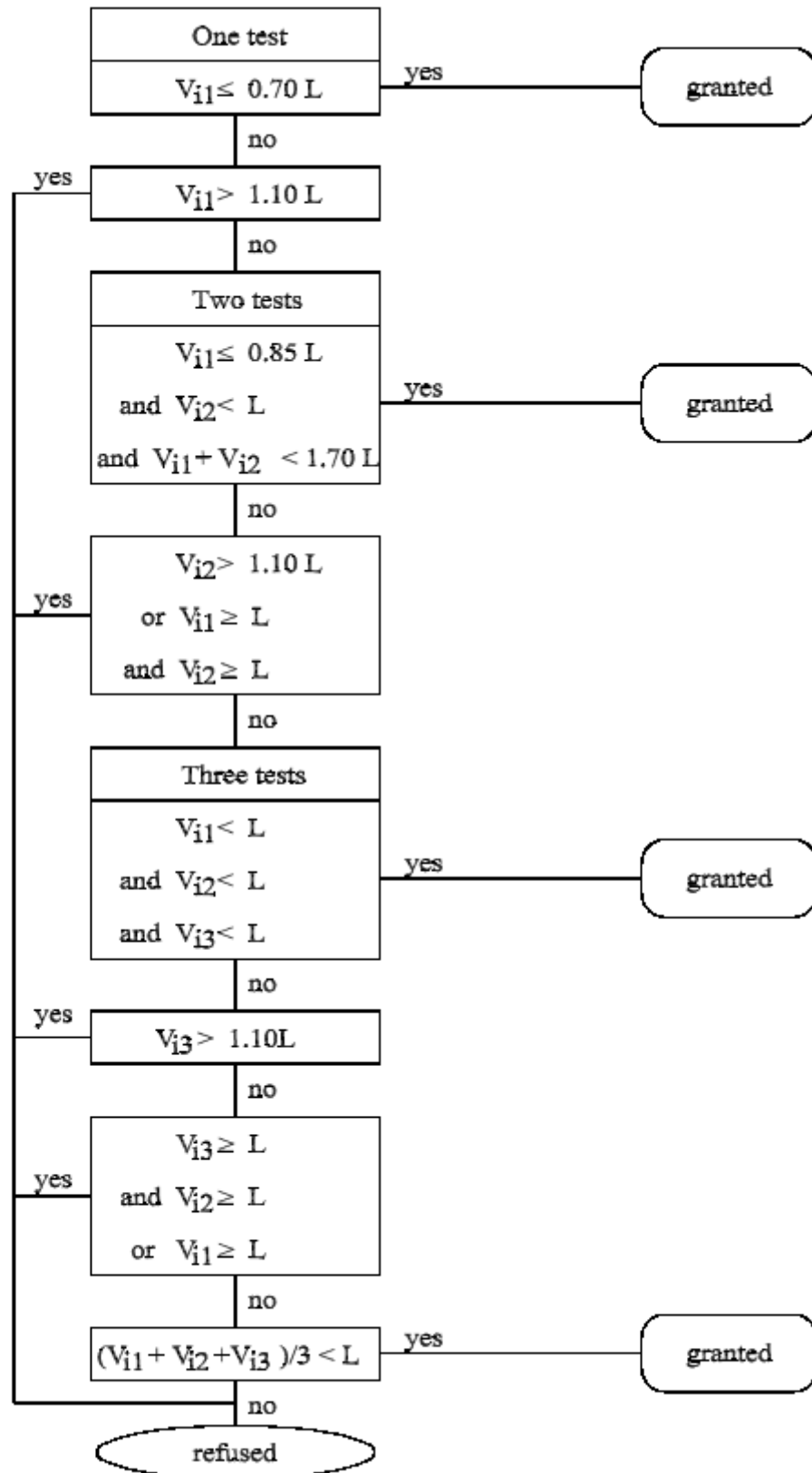

- 5.3.2. Type II test (Carbon monoxide emission test at idling speed)
- 5.3.2.1. This test is carried out on all vehicles powered by positive-ignition engines, as follows:
- 5.3.2.1.1. Vehicles that can be fuelled either with petrol or with LPG or NG/biomethane shall be tested in the Type II test on both fuels.
- 5.3.2.1.2. Notwithstanding the requirement of paragraph 5.3.2.1.1. of this Regulation, vehicles that can be fuelled with either petrol or a gaseous fuel, but where the petrol system is fitted for emergency purposes or starting only and which the petrol tank cannot contain more than 15 litres of petrol will be regarded for the Type II test as vehicles that can only run on a gaseous fuel.
- 5.3.2.2. For the Type II test set out in Annex 5 to this Regulation, at normal engine idling speed, the maximum permissible carbon monoxide content in the exhaust gases shall be that stated by the vehicle manufacturer. However, the maximum carbon monoxide content shall not exceed 0.3 per cent vol.
- At high idle speed, the carbon monoxide content by volume of the exhaust gases shall not exceed 0.2 per cent, with the engine speed being at least 2,000 min⁻¹ and Lambda being 1 ± 0.03 or in accordance with the specifications of the manufacturer.
- 5.3.3. Type III test (verifying emissions of crankcase gases)
- 5.3.3.1. This test shall be carried out on all vehicles referred to in paragraph 1. except those having compression-ignition engines.
- 5.3.3.1.1. Vehicles that can be fuelled either with petrol or with LPG or NG should be tested in the Type III test on petrol only.
- 5.3.3.1.2. Notwithstanding the requirement of paragraph 5.3.3.1.1. of this Regulation, vehicles that can be fuelled with either petrol or a gaseous fuel, but where the petrol system is fitted for emergency purposes or starting only and which the petrol tank cannot contain more than 15 litres of petrol will be regarded for the Type III test as vehicles that can only run on a gaseous fuel.
- 5.3.3.2. When tested in accordance with Annex 6 to this Regulation, the engine's crankcase ventilation system shall not permit the emission of any of the crankcase gases into the atmosphere.
- 5.3.4. Type IV test (Determination of evaporative emissions)
- 5.3.4.1. This test shall be carried out on all vehicles referred to in paragraph 1. except those vehicles having a compression-ignition engine, vehicles fuelled with LPG or NG/biomethane.
- 5.3.4.1.1. Vehicles that can be fuelled either with petrol or with LPG or with NG/biomethane should be tested in the Type IV test on petrol only.
- 5.3.4.2. When tested in accordance with Annex 7 to this Regulation, evaporative emissions shall be less than 2 g/test.
- 5.3.5. Type VI test (Verifying the average low ambient temperature carbon monoxide and hydrocarbon exhaust emissions after a cold start).
- 5.3.5.1. This test shall be carried out on all vehicles referred to in paragraph 1. of this Regulation except those having compression-ignition engines.

However, for compression ignition vehicles when applying for type approval, manufacturers shall present to the Type Approval Authority information showing that the NO_x aftertreatment device reaches a sufficiently high

temperature for efficient operation within 400 seconds after a cold start at -7°C as described in the Type VI test.

In addition, the manufacturer shall provide the Type Approval Authority with information on the operating strategy of the exhaust gas recirculation system (EGR), including information on its functioning at low temperatures.

This information shall also include a description of any effects on emissions.

The Type Approval Authority shall not grant type approval if the information provided is insufficient to demonstrate that the after treatment device actually reaches a sufficiently high temperature for efficient operation within the designated period of time.

- 5.3.5.1.1. The vehicle is placed on a chassis dynamometer equipped with a means of load an inertia simulation.
- 5.3.5.1.2. The test consists of the four elementary urban driving cycles of Part One of the Type I test. The Part One test is described in paragraph 6.1.1. of Annex 4a to this Regulation, and illustrated in Figure A4a/1 of the same annex. The low ambient temperature test lasting a total of 780 seconds shall be carried out without interruption and start at engine cranking.
- 5.3.5.1.3. The low ambient temperature test shall be carried out at an ambient test temperature of 266 K (-7°C). Before the test is carried out, the test vehicles shall be conditioned in a uniform manner to ensure that the test results may be reproducible. The conditioning and other test procedures are carried out as described in Annex 8 to this Regulation.
- 5.3.5.1.4. During the test, the exhaust gases are diluted and a proportional sample collected. The exhaust gases of the vehicle tested are diluted, sampled and analysed, following the procedure described in Annex 8 to this Regulation, and the total volume of the diluted exhaust is measured. The diluted exhaust gases are analysed for carbon monoxide and total hydrocarbons.
- 5.3.5.2. Subject to the requirements in paragraphs 5.3.5.2.2. and 5.3.5.3. of this Regulation the test shall be performed three times. The resulting mass of carbon monoxide and hydrocarbon emission shall be less than the limits shown in Table 2.

Table 2

Emission limit for the carbon monoxide and hydrocarbon tailpipe emissions after a cold start test

<i>Test temperature 266 K (-7°C)</i>			
<i>Vehicle category</i>	<i>Class</i>	<i>Mass of carbon monoxide (CO) L₁ (g/km)</i>	<i>Mass of hydrocarbons (HC) L₂ (g/km)</i>
M	-	15	1.8
N ₁	I	15	1.8
	II	24	2.7
	III	30	3.2
N ₂	-	30	3.2

- 5.3.5.2.1. Notwithstanding the requirements of paragraph 5.3.5.2. of this Regulation, for each pollutant, not more than one of the three results obtained may exceed the limit prescribed by not more than 10 per cent, provided the arithmetical mean value of the three results is below the prescribed limit. Where the prescribed limits are exceeded for more than one pollutant, it is immaterial whether this occurs in the same test or in different tests.
- 5.3.5.2.2. The number of tests prescribed in paragraph 5.3.5.2. of this Regulation may, at the request of the manufacturer, be increased to 10 if the arithmetical mean of the first three results is lower than 110 per cent of the limit. In this case, the requirement after testing is only that the arithmetical mean of all 10 results shall be less than the limit value.
- 5.3.5.3. The number of tests prescribed in paragraph 5.3.5.2. of this Regulation may be reduced according to paragraphs 5.3.5.3.1. and 5.3.5.3.2. of this Regulation.
- 5.3.5.3.1. Only one test is performed if the result obtained for each pollutant of the first test is less than or equal to 0.70 L.
- 5.3.5.3.2. If the requirement of paragraph 5.3.5.3.1. of this Regulation is not satisfied, only two tests are performed if for each pollutant the result of the first test is less than or equal to 0.85 L and the sum of the first two results is less than or equal to 1.70 L and the result of the second test is less than or equal to L.
- $$(V_1 \leq 0.85 \text{ L and } V_1 + V_2 \leq 1.70 \text{ L and } V_2 \leq L).$$
- 5.3.6. Type V test (Durability of anti-pollution devices)
- 5.3.6.1. This test shall be carried out on all vehicles referred to in paragraph 1. to which the test specified in paragraph 5.3.1. of this Regulation applies. The test represents an ageing test of 160,000 km driven in accordance with the programme described in Annex 9 to this Regulation on a test track, on the road or on a chassis dynamometer.
- 5.3.6.1.1. Vehicles that can be fuelled either with petrol or with LPG or NG should be tested in the Type V test on petrol only. In that case the deterioration factor found with unleaded petrol will also be taken for LPG or NG.
- 5.3.6.2. Notwithstanding the requirement of paragraph 5.3.6.1. of this Regulation, a manufacturer may choose to have the deterioration factors from Table 3 used as an alternative to testing to paragraph 5.3.6.1. of this Regulation.

Table 3

Deterioration factors

Engine Category	Assigned deterioration factors						
	CO	THC	NMHC	NO _x	HC + NO _x	Particulate Matter (PM)	Particles
Positive-ignition	1.5	1.3	1.3	1.6	-	1.0	1.0
Compression-ignition							

- 5.3.6.3. At the request of the manufacturer, the Technical Service may carry out the Type I test before the Type V test has been completed using the deterioration factors in the table above. On completion of the Type V test, the Technical Service may then amend the type approval results recorded in Annex 2 to this Regulation by replacing the deterioration factors in the above table with those measured in the Type V Test.

- 5.3.6.4. In the absence of assigned deterioration factors for compression ignition vehicles, manufacturers shall use the whole vehicle or bench ageing durability test procedures to establish deterioration factors.
- 5.3.6.5. Deterioration factors are determined using either procedure in paragraph 5.3.6.1. of this Regulation or using the values in Table 3 in paragraph 5.3.6.2. of this Regulation. The factors are used to establish compliance with the requirements of paragraphs 5.3.1. and 8.2. of this Regulation.
- 5.3.7. Emission data required for roadworthiness testing
- 5.3.7.1. This requirement applies to all vehicles powered by a positive-ignition engine for which type approval is sought in accordance with this Regulation.
- 5.3.7.2. When tested in accordance with Annex 5 to this Regulation (Type II test) at normal idling speed:
- (a) The carbon monoxide content by volume of the exhaust gases emitted shall be recorded; and
 - (b) The engine speed during the test shall be recorded, including any tolerances.
- 5.3.7.3. When tested at "high idle" speed (i. e. > 2,000 min.⁻¹)
- (a) The carbon monoxide content by volume of the exhaust gases emitted shall be recorded;
 - (b) The Lambda value shall be recorded; and
 - (c) The engine speed during the test shall be recorded, including any tolerances.

The Lambda value shall be calculated using the simplified Brettschneider equation as follows:

$$\frac{[\text{CO}_2] + \frac{[\text{CO}]}{2} + [\text{O}_2] + \left(\frac{H_{cv}}{4} \cdot \frac{3.5}{3.5 + \frac{[\text{CO}]}{[\text{CO}_2]}} - \frac{O_{cv}}{2} \right) \cdot ([\text{CO}_2] + [\text{CO}])}{\left(1 + \frac{H_{cv}}{4} - \frac{O_{cv}}{2} \right) \cdot ([\text{CO}_2] + [\text{CO}] + K1[\text{HC}]}$$

Where:

[] = concentration in per cent volume,

K1 = conversion factor for NDIR measurement to FID measurement (provided by manufacturer of measuring equipment),

H_{cv} = Atomic ratio of hydrogen to carbon,

- (a) for petrol (E5) 1.89;
- (b) for petrol (E10) 1.93;
- (c) for LPG 2.53;
- (d) for NG/biomethane 4.0;
- (e) for ethanol (E85) 2.74;
- (f) for ethanol (E75) 2.61;

O_{cv} = Atomic ratio of oxygen to carbon,

- (a) for petrol (E5) 0.016;
- (b) for petrol (E10) 0.033;
- (c) for LPG 0.0;
- (d) for NG/biomethane 0.0;
- (e) for ethanol (E85) 0.39;
- (f) for ethanol (E75) 0.329.

- 5.3.7.4. The engine oil temperature at the time of the test shall be measured and recorded.
- 5.3.7.5. The table in item 2.2. to Annex 2 to this Regulation shall be completed.
- 5.3.7.6. The manufacturer shall confirm the accuracy of the Lambda value recorded at the time of type approval in paragraph 5.3.7.3. of this Regulation as being representative of typical production vehicles within 24 months of the date of the granting of type approval by the Type Approval Authority. An assessment shall be made based on surveys and studies of production vehicles.
- 5.3.8. On-board diagnostics OBD - test
This test shall be carried out on all vehicles referred to in paragraph 1. of this Regulation. The test procedure described in paragraph 3. of Annex 11 to this Regulation shall be followed.

6. Modifications of the vehicle type

- 6.1. Every modification of the vehicle type shall be notified to the Technical Service that approved the vehicle type. The department may then either:
 - 6.1.1. Consider that the modifications made are unlikely to have an appreciable adverse effect and that in any case the vehicle still complies with the requirement; or
 - 6.1.2. Require a further test report from the Technical Service responsible for conducting the tests.
- 6.2. Confirmation or refusal of approval, specifying the alterations, shall be communicated by the procedure specified in paragraph 4.3. of this Regulation to the Contracting Parties to the Agreement which apply this Regulation.
- 6.3. The type Approval Authority issuing the extension of approval shall assign a series number to the extension and inform thereof the other Contracting Parties applying this Regulation by means of a communication form conforming to the model in Annex 2 to this Regulation.

7. Extensions to type approvals

- 7.1. Extensions for tailpipe emissions (Type I, Type II and Type VI tests)
 - 7.1.1. Vehicles with different reference masses
 - 7.1.1.1. The type approval shall be extended only to vehicles with a reference mass requiring the use of the next two higher equivalent inertia or any lower equivalent inertia.
 - 7.1.1.2. For category N vehicles, the approval shall be extended only to vehicles with a lower reference mass, if the emissions of the vehicle already approved are

within the limits prescribed for the vehicle for which extension of the approval is requested.

- 7.1.2. Vehicles with different overall transmission ratios
- 7.1.2.1. The type approval shall be extended to vehicles with different transmission ratios only under certain conditions.
- 7.1.2.2. To determine whether type approval can be extended, for each of the transmission ratios used in the Type I and Type VI tests, the proportion,

$$E = |(V2 - V1)|/V1$$
shall be determined where, at an engine speed of 1,000 min⁻¹, V1 is the speed of the type of vehicle approved and V2 is the speed of the vehicle type for which extension of the approval is requested.
- 7.1.2.3. If, for each transmission ratio, $E \leq 8$ per cent, the extension shall be granted without repeating the Type I and Type VI tests.
- 7.1.2.4. If, for at least one transmission ratio, $E > 8$ per cent, and if, for each gear ratio, $E \leq 13$ per cent, the Type I and Type VI tests shall be repeated. The tests may be performed in a laboratory chosen by the manufacturer subject to the approval of the Technical Service. The report of the tests shall be sent to the Technical Service responsible for the type approval tests.
- 7.1.3. Vehicles with different reference masses and transmission ratios
- The type approval shall be extended to vehicles with different reference masses and transmission ratios, provided that all the conditions prescribed in paragraphs 7.1.1. and 7.1.2. of this Regulation are fulfilled.
- 7.1.4. Vehicles with periodically regenerating systems
- The type approval of a vehicle type equipped with a periodically regenerating system shall be extended to other vehicles with periodically regenerating systems, whose parameters described below are identical, or within the stated tolerances. The extension shall only relate to measurements specific to the defined periodically regenerating system.
- 7.1.4.1. Identical parameters for extending approval are:
- (a) Engine;
 - (b) Combustion process;
 - (c) Periodically regenerating system (i.e. catalyst, particulate trap);
 - (d) Construction (i.e. type of enclosure, type of precious metal, type of substrate, cell density);
 - (e) Type and working principle;
 - (f) Dosage and additive system;
 - (g) Volume ± 10 per cent; and
 - (h) Location (temperature ± 50 °C at 120 km/h or 5 per cent difference of max. temperature/pressure).
- 7.1.4.2. Use of Ki factors for vehicles with different reference masses
- The Ki factors developed by the procedures in paragraph 3. of Annex 13 to this Regulation for type approval of a vehicle type with a periodically regenerating system, may be used by other vehicles which meet the criteria referred to in paragraph 7.1.4.1. of this Regulation and have a reference mass

within the next two higher equivalent inertia classes or any lower equivalent inertia.

- 7.1.5. Application of extensions to other vehicles
- When an extension has been granted in accordance with paragraphs 7.1.1. to 7.1.4.2. of this Regulation, such a type approval shall not be further extended to other vehicles.
- 7.2. Extensions for evaporative emissions (Type IV test)
- 7.2.1. The type approval shall be extended to vehicles equipped with a control system for evaporative emissions which meet the following conditions:
- 7.2.1.1. The basic principle of fuel/air metering (e.g. single point injection,) is the same;
- 7.2.1.2. The shape of the fuel tank and the material of the fuel tank and liquid fuel hoses are identical;
- 7.2.1.3. The worst-case vehicle with regard to the cross-section and approximate hose length shall be tested. Whether non-identical vapour/liquid separators are acceptable is decided by the Technical Service responsible for the type approval tests;
- 7.2.1.4. The fuel tank volume is within a range of ± 10 per cent;
- 7.2.1.5. The setting of the fuel tank relief valve is identical;
- 7.2.1.6. The method of storage of the fuel vapour is identical, i.e. trap form and volume, storage medium, air cleaner (if used for evaporative emission control), etc.;
- 7.2.1.7. The method of purging the stored vapour is identical (e.g. air flow, start point or purge volume over the preconditioning cycle); and
- 7.2.1.8. The method of sealing and venting the fuel metering system is identical.
- 7.2.2. The type approval shall be extended to vehicles with:
- 7.2.2.1. Different engine sizes;
- 7.2.2.2. Different engine powers;
- 7.2.2.3. Automatic and manual gearboxes;
- 7.2.2.4. Two and four wheel transmissions;
- 7.2.2.5. Different body styles; and
- 7.2.2.6. Different wheel and tyre sizes.
- 7.3. Extensions for durability of pollution control devices (Type V test)
- 7.3.1. The type approval shall be extended to different vehicle types, provided that the vehicle, engine or pollution control system parameters specified below are identical or remain within the prescribed tolerances:
- 7.3.1.1. Vehicle:
- Inertia category: the two inertia categories immediately above and any inertia category below.
- Total road load at 80 km/h: +5 per cent above and any value below.
- 7.3.1.2. Engine
- (a) Engine cylinder capacity (± 15 per cent);

- (b) Number and control of valves;
 - (c) Fuel system;
 - (d) Type of cooling system; and
 - (e) Combustion process.
- 7.3.1.3. Pollution control system parameters:
- (a) Catalytic converters and particulate filters:
 - (i) Number of catalytic converters, filters and elements;
 - (ii) Size of catalytic converters and filters (volume of monolith ± 10 per cent);
 - (iii) Type of catalytic activity (oxidizing, three-way, lean NO_x trap, SCR, lean NO_x catalyst or other);
 - (iv) Precious metal load (identical or higher);
 - (v) Precious metal type and ratio (± 15 per cent);
 - (vi) Substrate (structure and material);
 - (vii) Cell density; and
 - (viii) Temperature variation of no more than 50 K at the inlet of the catalytic converter or filter. This temperature variation shall be checked under stabilized conditions at a speed of 120 km/h and the load setting of the Type I test.
 - (b) Air injection:
 - (i) With or without;
 - (ii) Type (pulsair, air pumps, other(s)).
 - (c) EGR:
 - (i) With or without;
 - (ii) Type (cooled or non-cooled, active or passive control, high pressure or low pressure).
- 7.3.1.4. The durability test may be carried out using a vehicle, which has a different body style, gear box (automatic or manual) and size of the wheels or tyres from those of the vehicle type for which the type approval is sought.
- 7.4. Extensions for on-board diagnostics
- 7.4.1. The type approval shall be extended to different vehicles with identical engine and emission control systems as defined in Appendix 2 to Annex 11 to this Regulation. The type approval shall be extended regardless of the following vehicle characteristics:
- (a) Engine accessories;
 - (b) Tyres;
 - (c) Equivalent inertia;
 - (d) Cooling system;
 - (e) Overall gear ratio;
 - (f) Transmission type; and
 - (g) Type of bodywork.

8. Conformity of production (COP)

- 8.1. Every vehicle bearing an approval mark as prescribed under this Regulation shall conform, with regard to components affecting the emission of gaseous and particulate pollutants by the engine, emissions from the crankcase and evaporative emissions, to the vehicle type approved. The conformity of production procedures shall comply with those set out in the 1958 Agreement, Appendix 2 (E/ECE/324-E/ECE/TRANS/505/Rev.2), with the following requirements:
- 8.1.1. Where applicable the tests of Types I, II, III, IV and the test for OBD shall be performed, as described in Table A to this Regulation. The specific procedures for conformity of production are set out in the paragraphs 8.2. to 8.6. of this Regulation.
- 8.2. Checking the conformity of the vehicle for a Type I test
- 8.2.1. The Type I test shall be carried out on a vehicle of the same specification as described in the type approval certificate. When a Type I test is to be carried out for a vehicle type approval that has one or several extensions, the Type I tests shall be carried out either on the vehicle described in the initial information package or on the vehicle described in the information package relating to the relevant extension.
- 8.2.2. After selection by the Type Approval Authority, the manufacturer shall not undertake any adjustment to the vehicles selected.
- 8.2.2.1. Three vehicles shall be selected at random in the series and tested as described in paragraph 5.3.1. of this Regulation. The deterioration factors shall be used in the same way. The limit values are set out in Table 1 in paragraph 5.3.1.4. of this Regulation.
- 8.2.2.2. If the Type Approval Authority is satisfied with the production standard deviation given by the manufacturer, the tests shall be carried out according to Appendix 1 to this Regulation. If the Type Approval Authority is not satisfied with the production standard deviation given by the manufacturer, the tests shall be carried out according to Appendix 2 to this Regulation.
- 8.2.2.3. The production of a series shall be deemed to conform or not to conform on the basis of a sampling test of the vehicles once a pass decision is reached for all the pollutants or a fail decision is reached for one pollutant, according to the test criteria applied in the appropriate appendix.
- When a pass decision has been reached for one pollutant, that decision shall not be changed by any additional tests carried out to reach a decision for the other pollutants.
- If no pass decision is reached for all the pollutants and no fail decision is reached for one pollutant, a test shall be carried out on another vehicle (see Figure 2).

Figure 2
Checking the conformity of the vehicle

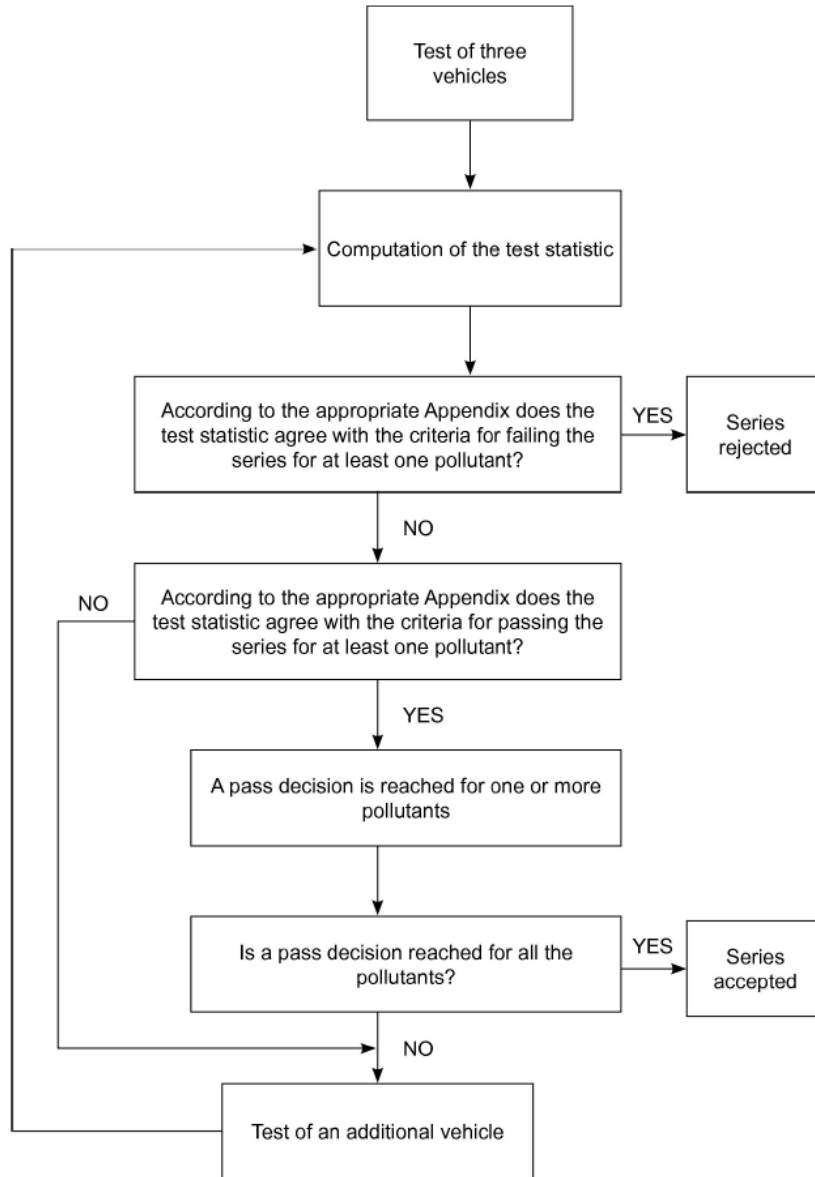

8.2.3. Notwithstanding the requirements of paragraph 5.3.1. of this Regulation, the tests shall be carried out on vehicles coming straight off the production line.

8.2.3.1. However, at the request of the manufacturer, the tests may be carried out on vehicles which have completed:

- (a) A maximum of 3,000 km for vehicles equipped with a positive ignition engine;
- (b) A maximum of 15,000 km for vehicles equipped with a compression ignition engine.

The running-in procedure shall be conducted by the manufacturer, who shall undertake not to make any adjustments to these vehicles.

- 8.2.3.2. If the manufacturer wishes to run in the vehicles, ("x" km, where $x \leq 3,000$ km for vehicles equipped with a positive ignition engine and $x \leq 15,000$ km for vehicles equipped with a compression ignition engine), the procedure shall be the following:
- (a) The pollutant emissions (Type I) shall be measured at zero and at "x" km on the first tested vehicle;
 - (b) The evolution coefficient of the emissions between zero and "x" km shall be calculated for each of the pollutant:
Emissions "x" km/Emissions zero km
This may be less than 1; and
 - (c) The other vehicles shall not be run in, but their zero km emissions shall be multiplied by the evolution coefficient.
In this case, the values to be taken shall be:
 - (i) The values at "x" km for the first vehicle;
 - (ii) The values at zero km multiplied by the evolution coefficient for the other vehicles.
- 8.2.3.3. All these tests shall be conducted with commercial fuel. However, at the manufacturer's request, the reference fuels described in Annex 10 or Annex 10a to this Regulation may be used.
- 8.3. Checking the conformity of the vehicle for a Type III test
- 8.3.1. If a Type III test is to be carried out, it shall be conducted on all vehicles selected for the Type I conformity of production test set out in paragraph 8.2. of this Regulation. The conditions laid down in Annex 6 to this Regulation shall apply.
- 8.4. Checking the conformity of the vehicle for a Type IV test
- 8.4.1. If a Type IV test is to be carried out, it shall be conducted in accordance with Annex 7 to this Regulation.
- 8.5. Checking the conformity of the vehicle for On-board Diagnostics (OBD)
- 8.5.1. If a verification of the performance of the OBD system is to be carried out, it shall be conducted in accordance with the following requirements:
- 8.5.1.1. When the Approval Authority determines that the quality of production seems unsatisfactory, a vehicle shall be randomly taken from the series and subjected to the tests described in Appendix 1 to Annex 11 to this Regulation.
- 8.5.1.2. The production shall be deemed to conform if this vehicle meets the requirements of the tests described in Appendix 1 to Annex 11 to this Regulation.
- 8.5.1.3. If the vehicle taken from the series does not satisfy the requirements of paragraph 8.5.1.1. of this Regulation, a further random sample of four vehicles shall be taken from the series and subjected to the tests described in Appendix 1 to Annex 11 to this Regulation. The tests may be carried out on vehicles which have been run in for no more than 15,000 km.
- 8.5.1.4. The production shall be deemed to conform if at least three vehicles meet the requirements of the tests described in Appendix 1 to Annex 11 to this Regulation.

- 8.6. Checking the conformity of a vehicle fuelled by LPG or NG/biomethane.
- 8.6.1. Tests for conformity of production may be performed with a commercial fuel of which the C3/C4 ratio lies between those of the reference fuels in the case of LPG, or of which the Wobbe index lies between those of the extreme reference fuels in the case of NG. In that case a fuel analysis shall be presented to the Type Approval Authority.

9. In-service conformity

9.1. Introduction

This paragraph sets out the tailpipe emissions and OBD (including IUPR_M) in-service conformity requirements for vehicles type approved to this Regulation.

9.2. Audit of in-service conformity

- 9.2.1. The audit of in-service conformity by the Type Approval Authority shall be conducted on the basis of any relevant information that the manufacturer has, under the same procedures as those for the conformity of production defined in the 1958 Agreement, Appendix 2 (E/ECE/324-E/ECE/TRANS/505/Rev.2). Information from Type Approval Authority and Contracting Party surveillance testing may complement the in-service monitoring reports supplied by the manufacturer.

- 9.2.2. Figures App4/1 and App4/2 of Appendix 4 to this Regulation illustrate the procedure for in-service conformity checking. The process for in-service conformity is described in Appendix 5 to this Regulation.

- 9.2.3. As part of the information provided for the in-service conformity control, at the request of the Type Approval Authority, the manufacturer shall report to the Type Approval Authority on warranty claims, warranty repair works and OBD faults recorded at servicing, according to a format agreed at type approval. The information shall detail the frequency and substance of faults for emissions related components and systems. The reports shall be filed at least once a year for each vehicle model for the duration of the period of up to 5 years of age or 100,000 km, whichever is the sooner.

9.2.4. Parameters defining the in-service family

The in-service family may be defined by basic design parameters which shall be common to vehicles within the family. Accordingly, vehicle types may be considered as belonging to the same in-service family if they have in common, or within the stated tolerances, the following parameters:

- 9.2.4.1. Combustion process (two stroke, four stroke, rotary);
- 9.2.4.2. Number of cylinders;
- 9.2.4.3. Configuration of the cylinder block (in-line, V, radial, horizontally opposed, other). The inclination or orientation of the cylinders is not a criterion;
- 9.2.4.4. Method of engine fuelling (e.g. indirect or direct injection);
- 9.2.4.5. Type of cooling system (air, water, oil);
- 9.2.4.6. Method of aspiration (naturally aspirated, pressure charged);
- 9.2.4.7. Fuel for which the engine is designed (petrol, diesel, NG/biomethane, LPG, etc.). Bi-fuelled vehicles may be grouped with dedicated fuel vehicles providing one of the fuels is common;

- 9.2.4.8. Type of catalytic converter (three-way catalyst, lean NO_x trap, SCR, lean NO_x catalyst or other(s));
- 9.2.4.9. Type of particulate trap (with or without);
- 9.2.4.10. Exhaust gas recirculation (with or without, cooled or non-cooled); and
- 9.2.4.11. Engine cylinder capacity of the largest engine within the family minus 30 per cent.
- 9.2.5. Information requirements
- An audit of in-service conformity will be conducted by the Approval Authority on the basis of information supplied by the manufacturer. Such information shall include in particular, the following:
- 9.2.5.1. The name and address of the manufacturer;
- 9.2.5.2. The name, address, telephone and fax numbers and e-mail address of the authorized representative within the areas covered by the manufacturer's information;
- 9.2.5.3. The model name(s) of the vehicles included in the manufacturer's information;
- 9.2.5.4. Where appropriate, the list of vehicle types covered within the manufacturer's information, i.e., for tailpipe emissions, the in-service family group in accordance with paragraph 9.2.4. of this Regulation and, for OBD and IUPR_M, the OBD family, in accordance with Appendix 2 to Annex 11 to this Regulation;
- 9.2.5.5. The vehicle identification number (VIN) codes applicable to these vehicle types within the family (VIN prefix);
- 9.2.5.6. The numbers of the type approvals applicable to these vehicle types within the family, including, where applicable, the numbers of all extensions and field fixes/recalls (re-works);
- 9.2.5.7. Details of extensions, field fixes/recalls to those type approvals for the vehicles covered within the manufacturer's information (if requested by the Type Approval Authority);
- 9.2.5.8. The period of time over which the manufacturer's information was collected;
- 9.2.5.9. The vehicle build period covered within the manufacturer's information (e.g. vehicles manufactured during the 2014 calendar year);
- 9.2.5.10. The manufacturer's in-service conformity checking procedure, including:
- (a) Vehicle location method;
 - (b) Vehicle selection and rejection criteria;
 - (c) Test types and procedures used for the programme;
 - (d) The manufacturer's acceptance/rejection criteria for the in-service family group;
 - (e) Geographical area(s) within which the manufacturer has collected information; and
 - (f) Sample size and sampling plan used.

- 9.2.5.11. The results from the manufacturer's in-service conformity procedure, including:
- (a) Identification of the vehicles included in the programme (whether tested or not). The identification shall include the following:
 - (i) Model name;
 - (ii) Vehicle identification number (VIN);
 - (iii) Vehicle registration number;
 - (iv) Date of manufacture;
 - (v) Region of use (where known); and
 - (vi) Tyres fitted (tailpipe emissions only).
 - (b) The reason(s) for rejecting a vehicle from the sample;
 - (c) Service history for each vehicle in the sample (including any re-works);
 - (d) Repair history for each vehicle in the sample (where known); and
 - (e) Test data, including the following:
 - (i) Date of test/download;
 - (ii) Location of test/download; and
 - (iii) Distance indicated on vehicle odometer;
for tailpipe emissions only;
 - (iv) Test fuel specifications (e.g. test reference fuel or market fuel);
 - (v) Test conditions (temperature, humidity, dynamometer inertia weight);
 - (vi) Dynamometer settings (e.g. power setting); and
 - (vii) Test results (from at least three different vehicles per family);and, for IUPR_M only:
 - (viii) All required data downloaded from the vehicle; and
 - (ix) For each monitor to be reported the in-use performance ratio IUPR_M.
- 9.2.5.12. Records of indication from the OBD system.
- 9.2.5.13. For IUPR_M sampling, the following:
- (a) The average of in-use-performance ratios IUPR_M of all selected vehicles for each monitor according to paragraphs 7.1.4. and 7.1.5. of Appendix 1 to Annex 11 to this Regulation;
 - (b) The percentage of selected vehicles, which have an IUPR_M greater or equal to the minimum value applicable to the monitor according to paragraphs 7.1.4. and 7.1.5. of Appendix 1 to Annex 11 to this Regulation.
- 9.3. Selection of vehicles for in-service conformity
- 9.3.1. The information gathered by the manufacturer shall be sufficiently comprehensive to ensure that in-service performance can be assessed for normal conditions of use. The manufacturer's sampling shall be drawn from

at least two Contracting Parties with substantially different vehicle operating conditions. Factors such as differences in fuels, ambient conditions, average road speeds, and urban/highway driving split shall be taken into consideration in the selection of the Contracting Parties.

For OBD IUPR_M testing only, vehicles fulfilling the criteria of paragraph 2.2.1. of Appendix 3 to this Regulation shall be included in the test sample.

- 9.3.2. In selecting the Contracting Parties for sampling vehicles, the manufacturer may select vehicles from a Contracting Party that is considered to be particularly representative. In this case, the manufacturer shall demonstrate to the Approval Authority which granted the type approval that the selection is representative (e.g. by the market having the largest annual sales of a vehicle family within the applicable Contracting Party). When a family requires more than one sample lot to be tested, as defined in paragraph 9.3.5. of this Regulation, the vehicles in the second and third sample lots shall reflect different vehicle operating conditions from those selected for the first sample.
- 9.3.3. The emissions testing may be done at a test facility which is located in a different market or region from where the vehicles have been selected.
- 9.3.4. The in-service tailpipe emissions conformity tests by the manufacturer shall be continuously carried out reflecting the production cycle of applicable vehicles types within a given in-service vehicle family. The maximum time period between commencing two in-service conformity checks shall not exceed 18 months. In the case of vehicle types covered by an extension to the type approval that did not require an emissions test, this period may be extended up to 24 months.
- 9.3.5. Sample size
- 9.3.5.1 When applying the statistical procedure defined in Appendix 4 to this Regulation (i.e. for tailpipe emissions), the number of sample lots shall depend on the annual sales volume of an in-service family in the territories of a regional organization (e.g. European Community), as defined in Table 4.

Table 4

Sample size

<i>Registrations</i> <i>- per calendar year (for tailpipe emission tests),</i> <i>- of vehicles of an OBD family with IUPR in the</i> <i>sampling period</i>	<i>Number of sample lots</i>
Up to 100,000	1
100,001 to 200,000	2
Above 200,000	3

- 9.3.5.2. For IUPR, the number of sample lots to be taken is described in Table 4 and is based on the number of vehicles of an OBD family that are approved with IUPR (subject to sampling).

For the first sampling period of an OBD family, all of the vehicle types in the family that are approved with IUPR shall be considered to be subject to sampling. For subsequent sampling periods, only vehicle types which have not been previously tested or are covered by emissions approvals that have been extended since the previous sampling period shall be considered to be subject to sampling.

For families consisting of fewer than 5,000 registrations that are subject to sampling within the sampling period, the minimum number of vehicles in a sample lot is six. For all other families, the minimum number of vehicles in a sample lot to be sampled is fifteen.

Each sample lot shall adequately represent the sales pattern, i.e. at least the high volume vehicle types (≥ 20 per cent of the family total) shall be represented.

- 9.4. On the basis of the audit referred to in paragraph 9.2. of this Regulation, the Type Approval Authority shall adopt one of the following decisions and actions:
- (a) Decide that the in-service conformity of a vehicle type, vehicle in-service family or vehicle OBD family is satisfactory and not take any further action;
 - (b) Decide that the data provided by the manufacturer is insufficient to reach a decision and request additional information or test data from the manufacturer;
 - (c) Decide that based on data from the Type Approval Authority or Contracting Party surveillance testing programmes, that information provided by the manufacturer is insufficient to reach a decision and request additional information or test data from the manufacturer; or
 - (d) Decide that the in-service conformity of a vehicle type, that is part of an in-service family, or of an OBD family, is unsatisfactory and proceed to have such vehicle type or OBD family tested in accordance with Appendix 3 to this Regulation.

If, according to the IUPR_M audit, the test criteria of paragraph 6.1.2. point (a) or (b) of Appendix 3 to this Regulation are met for the vehicles in a sample lot, the Type-Approval Authority must take the further action described in point (d) of this paragraph.

- 9.4.1. Where Type I tests are considered necessary to check the conformity of emission control devices with the requirements for their performance while in service, such tests shall be carried out using a test procedure meeting the statistical criteria defined in Appendix 4 to this Regulation.
- 9.4.2. The Approval Authority, in cooperation with the manufacturer, shall select a sample of vehicles with sufficient mileage whose use under normal conditions can be reasonably assured. The manufacturer shall be consulted on the choice of the vehicles in the sample and allowed to attend the confirmatory checks of the vehicles.
- 9.4.3. The manufacturer shall be authorized, under the supervision of the Type Approval Authority, to carry out checks, even of a destructive nature, on those vehicles with emission levels in excess of the limit values with a view to establishing possible causes of deterioration which cannot be attributed to the manufacturer (e.g. use of leaded petrol before the test date). Where the results of the checks confirm such causes, those test results shall be excluded from the conformity check.

10. Penalties for non-conformity of production

- 10.1. The approval granted in respect of a vehicle type pursuant to this amendment, may be withdrawn if the requirements laid down in paragraph 8.1. of this Regulation are not complied with or if the vehicle or vehicles taken fail to pass the tests prescribed in paragraph 8.1.1. of this Regulation.
- 10.2. If a Contracting Party which applies this Regulation withdraws an approval it has previously granted, it shall forthwith so notify the other Contracting Parties applying this Regulation, by means of a communication form conforming to the model in Annex 2 to this Regulation.

11. Production definitively discontinued

If the holder of the approval completely ceases to manufacture a type of vehicle approved in accordance with this Regulation, he shall so inform the type Type Approval Authority which granted the approval. Upon receiving the relevant communication, that authority shall inform thereof the other Contracting Parties to the 1958 Agreement applying this Regulation by means of copies of the communication form conforming to the model in Annex 2 to this Regulation.

12. Transitional provisions

- 12.1. General provisions
- 12.1.1. As from the official date of entry into force of the 07 series of amendments, no Contracting Party applying this Regulation shall refuse to grant approval under this Regulation as amended by the 07 series of amendments.
- 12.1.2. Type approval and conformity of production verification provisions, as specified in this Regulation as amended by the 06 series of amendments, remain applicable until the dates referred to in paragraphs 12.2.1. and 12.2.2. of this Regulation.
- 12.2. New type-approvals
- 12.2.1. Contracting Parties applying this Regulation shall, from the 1 September 2014 for vehicles of category M or N₁ (Class I) and 1 September 2015 for vehicles of category N₁ (Classes II or III) and category N₂, grant an ECE approval to new vehicle types only if they comply with:
- (a) The limits for the Type I test in Table 1 in paragraph 5.3.1.4. of this Regulation; and
 - (b) The Preliminary OBD threshold limits in Table A11/2 in paragraph 3.3.2.2. of Annex 11 to this Regulation.
- 12.2.2. Contracting Parties applying this Regulation shall, from the 1 September 2015 for vehicles of category M or N₁ (Class I) and 1 September 2016 for vehicles of category N₁ (Classes II or III) and category N₂, grant an ECE approval to new vehicles only if they comply with:
- (a) The limits for the Type I test in Table 1 in paragraph 5.3.1.4. of this Regulation; and
 - (b) The Preliminary OBD threshold limits in Table A11/2 in paragraph 3.3.2.2. of Annex 11 to this Regulation.

- 12.2.3. Contracting Parties applying this Regulation shall, from the 1 September 2017 for vehicles of category M or N₁ (Class I) and 1 September 2018 for vehicles of category N₁ (Classes II or III) and category N₂, grant an ECE approval to new vehicle types only if they comply with:
- (a) The limits for the Type I test in Table 1 in paragraph 5.3.1.4. of this Regulation; and
 - (b) The Final OBD threshold limits in Table A11/1 in paragraph 3.3.2.1. of Annex 11 to this Regulation.
- 12.2.4. Contracting Parties applying this Regulation shall, from the 1 September 2018 for vehicles of category M or N₁ (Class I) and 1 September 2019 for vehicles of category N₁ (Classes II or III) and category N₂, grant an ECE approval to new vehicles only if they comply with:
- (a) The limits for the Type I test in Table 1 in paragraph 5.3.1.4. of this Regulation; and
 - (b) The Final OBD threshold limits in Table A11/1 in paragraph 3.3.2.1. of Annex 11 to this Regulation.
- 12.3. Special provisions
- 12.3.1. Contracting Parties applying this Regulation may continue to grant approvals to those vehicles which comply with any previous series of amendments, or to any level of this Regulation, provided that the vehicles are intended for sale or for export to countries that apply the relating requirements in their national legislations.
13. Names and addresses of Technical Services responsible for conducting approval tests, and of Type Approval Authorities
- The Contracting Parties to the 1958 Agreement which apply this Regulation shall communicate to the United Nations Secretariat the names and addresses of the Technical Services responsible for conducting approval tests and of certifying approval or extension or refusal or withdrawal of approval, and to which forms certifying approval or extension or refusal or withdrawal of approval, issued in other countries, are to be sent.

Appendix 1

Procedure for verifying the conformity of production requirements if the production standard deviation given by the manufacturer is satisfactory

1. This appendix describes the procedure to be used to verify the production conformity for the Type I test when the manufacturer's production standard deviation is satisfactory.
2. With a minimum sample size of 3, the sampling procedure is set so that the probability of a lot passing a test with 40 per cent of the production defective is 0.95 (producer's risk = 5 per cent) while the probability of a lot being accepted with 65 per cent of the production defective is 0.1 (consumer's risk = 10 per cent).
3. For each of the pollutants given in Table 1 of paragraph 5.3.1.4. of this Regulation, the following procedure is used (see Figure 2 in paragraph 8.2. of this Regulation).

Taking:

L = the natural logarithm of the limit value for the pollutant,

x_i = the natural logarithm of the measurement for the i -th vehicle of the sample,

s = an estimate of the production standard deviation (after taking the natural logarithm of the measurements),

n = the current sample number.

4. Compute for the sample the test statistic quantifying the sum of the standard deviations from the limit and defined as:

$$\frac{1}{s} \sum_{i=1}^n (L - x_i)$$

5. Then:
 - 5.1. If the test statistic is greater than the pass decision number for the sample size given in Table App1/1, the pollutant is passed;
 - 5.2. If the test statistic is less than the fail decision number for the sample size given in Table App1/1, the pollutant is failed; otherwise, an additional vehicle is tested and the calculation reapplied to the sample with a sample size one unit greater.

Table App1/1
 Pass decision number for the sample size

<i>Cumulative number of tested vehicles (current sample size)</i>	<i>Pass decision threshold</i>	<i>Fail decision threshold</i>
3	3.327	-4.724
4	3.261	-4.79
5	3.195	-4.856
6	3.129	-4.922
7	3.063	-4.988
8	2.997	-5.054
9	2.931	-5.12
10	2.865	-5.185
11	2.799	-5.251
12	2.733	-5.317
13	2.667	-5.383
14	2.601	-5.449
15	2.535	-5.515
16	2.469	-5.581
17	2.403	-5.647
18	2.337	-5.713
19	2.271	-5.779
20	2.205	-5.845
21	2.139	-5.911
22	2.073	-5.977
23	2.007	-6.043
24	1.941	-6.109
25	1.875	-6.175
26	1.809	-6.241
27	1.743	-6.307
28	1.677	-6.373
29	1.611	-6.439
30	1.545	-6.505
31	1.479	-6.571
32	-2.112	-2.112

Appendix 2

Procedure for verifying the conformity of production requirements if the production standard deviation given by the manufacturer is either not satisfactory or not available

1. This appendix describes the procedure to be used to verify the production conformity requirements for the Type I test when the manufacturer's evidence of production standard deviation is either not satisfactory or not available.
2. With a minimum sample size of 3, the sampling procedure is set so that the probability of a lot passing a test with 40 per cent of the production defective is 0.95 (producer's risk = 5 per cent) while the probability of a lot being accepted with 65 per cent of the production defective is 0.1 (consumer's risk = 10 per cent).
3. The measurements of the pollutants given in Table 1 of paragraph 5.3.1.4. of this Regulation are considered to be log normally distributed and shall first be transformed by taking their natural logarithms. Let m_0 and m denote the minimum and maximum sample sizes respectively ($m_0 = 3$ and $m = 32$) and let n denote the current sample number.
4. If the natural logarithms of the measurements in the series are x_1, x_2, \dots, x_n and L is the natural logarithm of the limit value for the pollutant, then define:

$$d_i = x_i - L$$

$$\bar{d}_n = \frac{1}{n} \sum_{i=1}^n d_i$$

and

$$V_n^2 = \frac{1}{n} \sum_{i=1}^n (d_i - \bar{d}_n)^2$$

5. Table App2/1 shows values of the pass (A_n) and fail (B_n) decision numbers against current sample number. The test statistic is the ratio \bar{d}_n/V_n and shall be used to determine whether the series has passed or failed as follows:

For $m_0 \leq n \leq m$

(i) Pass the series if $\frac{\bar{d}_n}{V_n} \leq A_n$

(ii) Fail the series if $\frac{\bar{d}_n}{V_n} \geq B_n$

(iii) Take another measurement if $A_n < \frac{\bar{d}_n}{V_n} < B_n$

6. Remarks

The following recursive formulae are useful for computing successive values of the test statistic:

$$\bar{d}_n = \left(1 - \frac{1}{n}\right) \bar{d}_{n-1} + \frac{1}{n} d_n$$

$$V_n^2 = \left(1 - \frac{1}{n}\right) V_{n-1}^2 + \left[\frac{\bar{d}_n - d_n}{n-1}\right]^2$$

$$(n = 2, 3, \dots ; \quad \bar{d}_1 = d_1; \quad V_1 = 0 \quad)$$

Table App2/1
Minimum sample size = 3

<i>Sample size (n)</i>	<i>Pass decision threshold (A_n)</i>	<i>Fail decision threshold (B_n)</i>
3	-0.80381	16.64743
4	-0.76339	7.68627
5	-0.72982	4.67136
6	-0.69962	3.25573
7	-0.67129	2.45431
8	-0.64406	1.94369
9	-0.61750	1.59105
10	-0.59135	1.33295
11	-0.56542	1.13566
12	-0.53960	0.97970
13	-0.51379	0.85307
14	-0.48791	0.74801
15	-0.46191	0.65928
16	-0.43573	0.58321
17	-0.40933	0.51718
18	-0.38266	0.45922
19	-0.35570	0.40788
20	-0.32840	0.36203
21	-0.30072	0.32078
22	-0.27263	0.28343
23	-0.24410	0.24943
24	-0.21509	0.21831
25	-0.18557	0.18970
26	-0.15550	0.16328
27	-0.12483	0.13880
28	-0.09354	0.11603
29	-0.06159	0.09480
30	-0.02892	0.07493
31	0.00449	0.05629
32	0.03876	0.03876

Appendix 3

In-service conformity check

1. Introduction

This appendix sets out the criteria referred to in paragraphs 9.3. and 9.4. of this Regulation regarding the selection of vehicles for testing and the procedures for the in-service conformity control.
2. Selection criteria

The criteria for acceptance of a selected vehicle are defined for tailpipe emissions in paragraphs 2.1. to 2.8. of this appendix and for IUPR_M in paragraphs 2.1. to 2.5. of this appendix. Information is collected by vehicle examination and an interview with the owner/driver.

 - 2.1. The vehicle shall belong to a vehicle type that is type approved under this Regulation and covered by a certificate of conformity in accordance with the 1958 Agreement. It shall be registered and used in a country of the Contracting Parties.
 - 2.2. The vehicle shall have been in service for at least 15,000 km or 6 months, whichever is the later, and for no more than 100,000 km or 5 years, whichever is the sooner.
 - 2.2.1. For checking IUPR_M, the test sample shall include only vehicles that:
 - (a) Have collected sufficient vehicle operation data for the monitor to be tested.

For monitors required to meet the in-use monitor performance ratio and to track and report ratio data pursuant to paragraph 7.6.1. of Appendix 1 to Annex 11 to this Regulation sufficient vehicle operation data shall mean the denominator meets the criteria set forth below. The denominator, as defined in paragraphs 7.3. and 7.5. of Appendix 1 to Annex 11 to this Regulation, for the monitor to be tested must have a value equal to or greater than one of the following values:

 - (i) 75 for evaporative system monitors, secondary air system monitors, and monitors utilising a denominator incremented in accordance with paragraph 7.3.2. points (a), (b) or (c) of Appendix 1 to Annex 11 to this Regulation (e.g. cold start monitors, air conditioning system monitors, etc.); or
 - (ii) 25 for particulate filter monitors and oxidation catalyst monitors utilising a denominator incremented in accordance with paragraph 7.3.2. (d) of Appendix 1 to Annex 11 to this Regulation; or
 - (iii) 150 for catalyst, oxygen sensor, EG R, VVT, and all other component monitors;
 - (b) Have not been tampered with or equipped with add-on or modified parts that would cause the OBD system not to comply with the requirements of Annex 11 to this Regulation.
 - 2.3. There shall be a maintenance record to show that the vehicle has been properly maintained, e.g. has been serviced in accordance with the manufacturer's recommendations.

- 2.4. The vehicle shall exhibit no indications of abuse (e.g. racing, overloading, misfuelling, or other misuse), or other factors (e.g. tampering) that could affect emission performance. The fault code and mileage information stored in the computer is taken into account. A vehicle shall not be selected for testing if the information stored in the computer shows that the vehicle has operated after a fault code was stored and a relatively prompt repair was not carried out.
- 2.5. There shall have been no unauthorised major repair to the engine or major repair of the vehicle.
- 2.6. The lead content and sulphur content of a fuel sample from the vehicle tank shall meet applicable standards and there shall be no evidence of misfuelling. Checks may be done in the exhaust, etc.
- 2.7. There shall be no indication of any problem that might jeopardise the safety of laboratory personnel.
- 2.8. All anti-pollution system components on the vehicle shall be in conformity with the applicable type approval.
3. Diagnosis and maintenance
Diagnosis and any normal maintenance necessary shall be performed on vehicles accepted for testing, prior to measuring exhaust emissions, in accordance with the procedure laid down in paragraphs 3.1. to 3.8. of this appendix.
- 3.1. The following checks shall be carried out: checks on air filter, all drive belts, all fluid levels, radiator cap, all vacuum hoses and electrical wiring related to the anti-pollution system for integrity; checks on ignition, fuel metering and anti-pollution device components for maladjustments and/or tampering. All discrepancies shall be recorded.
- 3.2. The OBD system shall be checked for proper functioning. Any malfunction indications in the OBD memory shall be recorded and the requisite repairs shall be carried out. If the OBD malfunction indicator registers a malfunction during a preconditioning cycle, the fault may be identified and repaired. The test may be re-run and the results of that repaired vehicle used.
- 3.3. The ignition system shall be checked and defective components replaced, for example spark plugs, cables, etc.
- 3.4. The compression shall be checked. If the result is unsatisfactory the vehicle is rejected.
- 3.5. The engine parameters shall be checked to the manufacturer's specifications and adjusted if necessary.
- 3.6. If the vehicle is within 800 km of a scheduled maintenance service, that service shall be performed according to the manufacturer's instructions. Regardless of odometer reading, the oil and air filter may be changed at the request of the manufacturer.
- 3.7. Upon acceptance of the vehicle, the fuel shall be replaced with appropriate emission test reference fuel, unless the manufacturer accepts the use of market fuel.
- 3.8. In the case of vehicles equipped with periodically regenerating systems as defined in paragraph 2.20. of this Regulation, it shall be established that the vehicle is not approaching a regeneration period. (The manufacturer must be given the opportunity to confirm this).

- 3.8.1. If this is the case, the vehicle must be driven until the end of the regeneration. If regeneration occurs during emissions measurement, then a further test must be carried out to ensure that regeneration has been completed. A complete new test shall then be performed, and the first and second test results not taken into account.
- 3.8.2. As an alternative to paragraph 3.8.1. of this appendix, if the vehicle is approaching a regeneration the manufacturer may request that a specific conditioning cycle is used to ensure that regeneration (e.g. this may involve high speed, high load driving).
The manufacturer may request that testing may be carried out immediately after regeneration or after the conditioning cycle specified by the manufacturer and normal test preconditioning.
4. In-service testing
- 4.1. When a check on vehicles is deemed necessary, emission tests in accordance with Annex 4a to this Regulation are performed on pre-conditioned vehicles selected in accordance with the requirements of paragraphs 2. and 3. of this appendix. Pre-conditioning cycles additional to those specified in paragraph 6.3. of Annex 4a to this Regulation will only be allowed if they are representative of normal driving.
- 4.2. Vehicles equipped with an OBD system may be checked for proper in-service functionality of the malfunction indication, etc., in relation to levels of emissions (e.g. the malfunction indication limits defined in Annex 11 to this Regulation) for the type-approved specifications.
- 4.3. The OBD system may be checked, for example, for levels of emissions above the applicable limit values with no malfunction indication, systematic erroneous activation of the malfunction indication and identified faulty or deteriorated components in the OBD system.
- 4.4. If a component or system operates in a manner not covered by the particulars in the type-approval certificate and/or information package for such vehicle types and such deviation has not been authorised under the 1958 Agreement, with no malfunction indication by the OBD, the component or system shall not be replaced prior to emission testing, unless it is determined that the component or system has been tampered with or abused in such a manner that the OBD does not detect the resulting malfunction.
5. Evaluation of emission test results
- 5.1. The test results are submitted to the evaluation procedure in accordance with Appendix 4 to this Regulation.
- 5.2. Test results shall not be multiplied by deterioration factors.
- 5.3. In the case of periodically regenerating systems as defined in paragraph 2.20. of this Regulation, the results shall be multiplied by the factors K_i obtained at the time when type approval was granted.
6. Plan of remedial measures
- 6.1. The Type Approval Authority shall request the manufacturer to submit a plan of remedial measures to remedy the non-compliance when:
- 6.1.1. For tailpipe emissions more than one vehicle is found to be an outlying emitter that meets either of the following conditions:

- (a) The conditions of paragraph 3.2.2. of Appendix 4 to this Regulation and where both the Type Approval Authority and the manufacturer agree that the excess emission is due to the same cause; or
- (b) The conditions of paragraph 3.2.3. of Appendix 4 to this Regulation where the Type Approval Authority has determined that the excess emission is due to the same cause.

The Type Approval Authority must request the manufacturer to submit a plan of remedial measures to remedy the non-compliance.

6.1.2. For $IUPR_M$, of a particular monitor M the following statistical conditions are met in a test sample, the size of which is determined according to paragraph 9.3.5. of this Regulation:

- (a) For vehicles certified to a ratio of 0.1 in accordance with paragraph 7.1.5. of Appendix 1 to Annex 11 to this Regulation, the data collected from the vehicles indicate for at least one monitor M in the test sample either that the test sample average in-use-performance ratio is less than 0.1 or that 66 per cent or more of the vehicles in the test sample have an in-use monitor performance ratio of less than 0.1.
- (b) For vehicles certified to the full ratios in accordance with paragraph 7.1.4. of Appendix 1 to Annex 11 to this Regulation the data collected from the vehicles indicate for at least one monitor M in the test sample either that the test sample average in-use performance ratio in the test sample is less than the value $Test_{min}(M)$ or that 66 per cent or more of the vehicles in the test sample have an in-use performance ratio of less than $Test_{min}(M)$.

The value of $Test_{min}(M)$ shall be:

- (i) 0.230 if the monitor M is required to have an in-use ratio of 0.26;
- (ii) 0.460 if the monitor M is required to have an in-use ratio of 0.52;
- (iii) 0.297 if the monitor M is required to have an in-use ratio of 0.336;

according to paragraph 7.1.4. of Appendix 1 to Annex 11 to this Regulation.

6.2. The plan of remedial measures shall be filed with the Type Approval Authority not later than 60 working days from the date of the notification referred to in paragraph 6.1. of this appendix. The Type Approval Authority shall within 30 working days declare its approval or disapproval of the plan of remedial measures. However, where the manufacturer can demonstrate, to the satisfaction of the competent Type Approval Authority, that further time is required to investigate the non-compliance in order to submit a plan of remedial measures, an extension is granted.

6.3. The remedial measures shall apply to all vehicles likely to be affected by the same defect. The need to amend the type approval documents shall be assessed.

6.4. The manufacturer shall provide a copy of all communications related to the plan of remedial measures, and shall also maintain a record of the recall campaign, and supply regular status reports to the Type Approval Authority.

- 6.5. The plan of remedial measures shall include the requirements specified in paragraphs 6.5.1. to 6.5.11. of this appendix. The manufacturer shall assign a unique identifying name or number to the plan of remedial measures.
- 6.5.1. A description of each vehicle type included in the plan of remedial measures.
- 6.5.2. A description of the specific modifications, alterations, repairs, corrections, adjustments, or other changes to be made to bring the vehicles into conformity including a brief summary of the data and technical studies which support the manufacturer's decision as to the particular measures to be taken to correct the non-conformity.
- 6.5.3. A description of the method by which the manufacturer informs the vehicle owners.
- 6.5.4. A description of the proper maintenance or use, if any, which the manufacturer stipulates as a condition of eligibility for repair under the plan of remedial measures, and an explanation of the manufacturer's reasons for imposing any such condition. No maintenance or use conditions may be imposed unless it is demonstrably related to the non-conformity and the remedial measures.
- 6.5.5. A description of the procedure to be followed by vehicle owners to obtain correction of the non-conformity. This shall include a date after which the remedial measures may be taken, the estimated time for the workshop to perform the repairs and where they can be done. The repair shall be done expediently, within a reasonable time after delivery of the vehicle.
- 6.5.6. A copy of the information transmitted to the vehicle owner.
- 6.5.7. A brief description of the system which the manufacturer uses to assure an adequate supply of component or systems for fulfilling the remedial action. It shall be indicated when there will be an adequate supply of components or systems to initiate the campaign.
- 6.5.8. A copy of all instructions to be sent to those persons who are to perform the repair.
- 6.5.9. A description of the impact of the proposed remedial measures on the emissions, fuel consumption, derivability, and safety of each vehicle type, covered by the plan of remedial measures with data, technical studies, etc. which support these conclusions.
- 6.5.10. Any other information, reports or data the Type Approval Authority may reasonably determine is necessary to evaluate the plan of remedial measures.
- 6.5.11. Where the plan of remedial measures includes a recall, a description of the method for recording the repair shall be submitted to the Type Approval Authority. If a label is used, an example of it shall be submitted.
- 6.6. The manufacturer may be required to conduct reasonably designed and necessary tests on components and vehicles incorporating a proposed change, repair, or modification to demonstrate the effectiveness of the change, repair, or modification.
- 6.7. The manufacturer is responsible for keeping a record of every vehicle recalled and repaired and the workshop which performed the repair. The Type Approval Authority shall have access to the record on request for a period of 5 years from the implementation of the plan of remedial measures.
- 6.8. The repair and/or modification or addition of new equipment shall be recorded in a certificate supplied by the manufacturer to the vehicle owner.

Appendix 4

Statistical procedure for tailpipe emissions in-service conformity testing

1. This appendix describes the procedure to be used to verify the in-service conformity requirements for the Type I test.
2. Two different procedures are to be followed:
 - (a) One dealing with vehicles identified in the sample, due to an emission related defect, causing outliers in the results (paragraph 3. of this appendix);
 - (b) The other deals with the total sample (paragraph 4. of this appendix).
3. Procedure to be followed with outlying emitters in the sample
 - 3.1. With a minimum sample size of three and a maximum sample size as determined by the procedure of paragraph 4., a vehicle is taken at random from the sample and the emissions of the regulated pollutants are measured to determine if it is an outlying emitter.
 - 3.2. A vehicle is said to be an outlying emitter when the conditions given in paragraph 3.2.1. of this appendix are met.
 - 3.2.1. In the case of a vehicle that has been type-approved according to the limit values given in Table 1 in paragraph 5.3.1.4. of this Regulation, an outlying emitter is a vehicle where the applicable limit value for any regulated pollutant is exceeded by a factor of 1.5.
 - 3.2.2. In the specific case of a vehicle with a measured emission for any regulated pollutant within the "intermediate zone".⁵
 - 3.2.2.1. If the vehicle meets the conditions of this paragraph, the cause of the excess emission must be determined and another vehicle is then taken at random from the sample.
 - 3.2.2.2. Where more than one vehicle meets the condition of this paragraph, the Type Approval Authority and the manufacturer must determine if the excess emission from both vehicles is due to the same cause or not.
 - 3.2.2.2.1. If the Type Approval Authority and the manufacturer both agree that the excess emission is due to the same cause, the sample is regarded as having failed and the plan of remedial measures outlined in paragraph 6. of Appendix 3 to this Regulation applies.
 - 3.2.2.2.2. If the Type Approval Authority and the manufacturer cannot agree on either the cause of the excess emission from an individual vehicle or whether the causes for more than one vehicle are the same, another vehicle is taken at

⁵ For any vehicle, the "intermediate zone" is determined as follows: The vehicle shall meet the conditions given in paragraph 3.2.1. and, in addition, the measured value for the same regulated pollutant shall be below a level that is determined from the product of the limit value for the same regulated pollutant given in Table 1 in paragraph 5.3.1.4. of this Regulation multiplied by a factor of 2.5.

- random from the sample, unless the maximum sample size has already been reached.
- 3.2.2.3. When only one vehicle meeting the conditions of this paragraph has been found, or when more than one vehicle has been found and the Type Approval Authority and the manufacturer agree it is due to different causes, another vehicle is taken at random from the sample, unless the maximum sample size has already been reached.
- 3.2.2.4. If the maximum sample size is reached and not more than one vehicle meeting the requirements of this paragraph has been found where the excess emission is due to the same cause, the sample is regarded as having passed with regard to the requirements of paragraph 3. of this appendix.
- 3.2.2.5. If, at any time, the initial sample has been exhausted, another vehicle is added to the initial sample and that vehicle is taken.
- 3.2.2.6. Whenever another vehicle is taken from the sample, the statistical procedure of paragraph 4. of this appendix is applied to the increased sample.
- 3.2.3. In the specific case of a vehicle with a measured emission for any regulated pollutant within the "failure zone".⁶
- 3.2.3.1. If the vehicle meets the conditions of this paragraph, the Type Approval Authority shall determine the cause of the excess emission and another vehicle is then taken at random from the sample.
- 3.2.3.2. Where more than one vehicle meets the condition of this paragraph, and the Type Approval Authority determines that the excess emission is due to the same cause, the manufacturer shall be informed that the sample is regarded as having failed, together with the reasons for that decision, and the plan of remedial measures outlined in paragraph 6. of Appendix 3 to this Regulation applies.
- 3.2.3.3. When only one vehicle meeting the conditions of this paragraph has been found, or when more than one vehicle has been found and the Type Approval Authority has determined that it is due to different causes, another vehicle is taken at random from the sample, unless the maximum sample size has already been reached.
- 3.2.3.4. If the maximum sample size is reached and not more than one vehicle meeting the requirements of this paragraph has been found where the excess emission is due to the same cause, the sample is regarded as having passed with regard to the requirements of paragraph 3. of this appendix.
- 3.2.3.5. If, at any time, the initial sample has been exhausted, another vehicle is added to the initial sample and that vehicle is taken.
- 3.2.3.6. Whenever another vehicle is taken from the sample, the statistical procedure of paragraph 4. of this appendix is applied to the increased sample.
- 3.2.4. Whenever a vehicle is not found to be an outlying emitter, another vehicle is taken at random from the sample.
- 3.3. When an outlying emitter is found, the cause of the excess emission shall be determined.

⁶ For any vehicle, the "failure zone" is determined as follows: The measured value for any regulated pollutant exceeds a level that is determined from the product of the limit value for the same regulated pollutant given in Table 1 in paragraph 5.3.1.4. of this Regulation multiplied by a factor of 2.5.

-
- 3.4. When more than one vehicle is found to be an outlying emitter, due to the same cause, the sample is regarded as having failed.
- 3.5. When only one outlying emitter has been found, or when more than one outlying emitter is found, but due to different causes, the sample is increased by one vehicle, unless the maximum sample size has already been reached.
- 3.5.1. When in the increased sample more than one vehicle is found to be an outlying emitter, due to the same cause, the sample is regarded as having failed.
- 3.5.2. When in the maximum sample size not more than one outlying emitter is found, where the excess emission is due to the same cause, the sample is regarded as having passed with regard to the requirements of paragraph 3. of this appendix.
- 3.6. Whenever a sample is increased due to the requirements of paragraph 3.5., the statistical procedure of paragraph 4. is applied to the increased sample.
4. Procedure to be followed without separate evaluation of outlying emitters in the sample
- 4.1. With a minimum sample size of three the sampling procedure is set so that the probability of a batch passing a test with 40 per cent of the production defective is 0.95 (producer's risk = 5 per cent) while the probability of a batch being accepted with 75 per cent of the production defective is 0.15 (consumer's risk = 15 per cent).
- 4.2. For each of the pollutants given in the Table 1 of paragraph 5.3.1.4. of this Regulation, the following procedure is used (see Figure App4/2 below).
- Where:
- L = the limit value for the pollutant,
 x_i = the value of the measurement for the i -th vehicle of the sample,
n = the current sample number.
- 4.3. The test statistic quantifying the number of non-conforming vehicles, i.e. $x_i > L$, is computed for the sample.
- 4.4. Then:
- (a) If the test statistic does not exceed the pass decision number for the sample size given in Table App4/1, a pass decision is reached for the pollutant;
- (b) If the test statistic equals or exceeds the fail decision number for the sample size given in Table App4/1, a fail decision is reached for the pollutant;
- (c) Otherwise, an additional vehicle is tested and the procedure is applied to the sample with one extra unit.
- In the following table the pass and fail decision numbers are computed in accordance with the International Standard ISO 8422:1991.
5. A sample is regarded as having passed the test when it has passed both the requirements of paragraphs 3. and 4. of this appendix.

Table App4/1
Table for acceptance/rejection sampling plan by attributes

<i>Cumulative sample size (n)</i>	<i>Pass decision number</i>	<i>Fail decision number</i>
3	0	-
4	1	-
5	1	5
6	2	6
7	2	6
8	3	7
9	4	8
10	4	8
11	5	9
12	5	9
13	6	10
14	6	11
15	7	11
16	8	12
17	8	12
18	9	13
19	9	13
20	11	12

Figure App4/1
In-service conformity checking - audit procedure

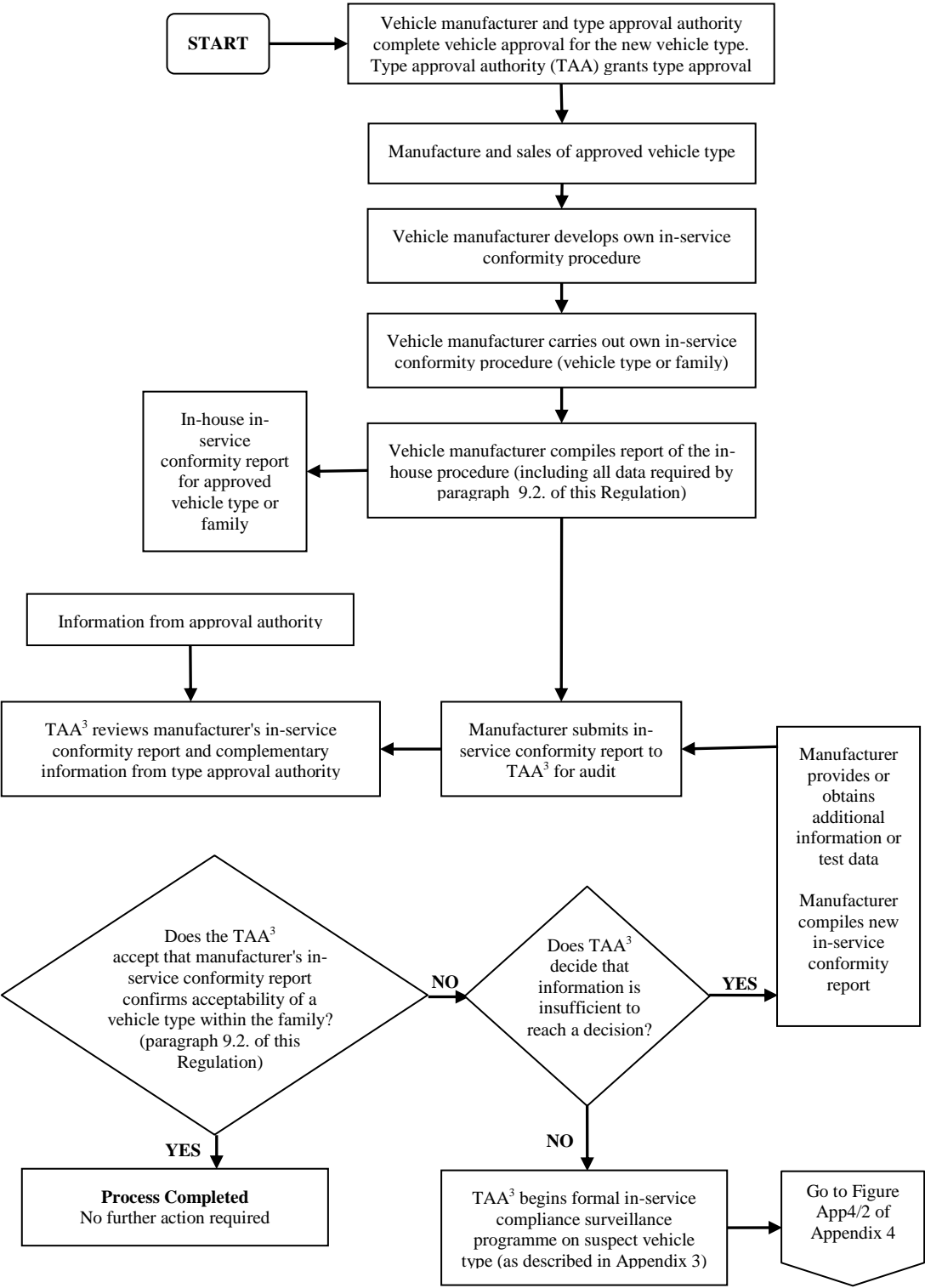

³ TAA means the "Type Approval Authority" that granted the type-approvals according to this Regulation (see the definition at ECE/TRANS/WP.29/1059, page 2, footnote 2).

Figure App4/2
In-service conformity testing - selection and test of vehicles

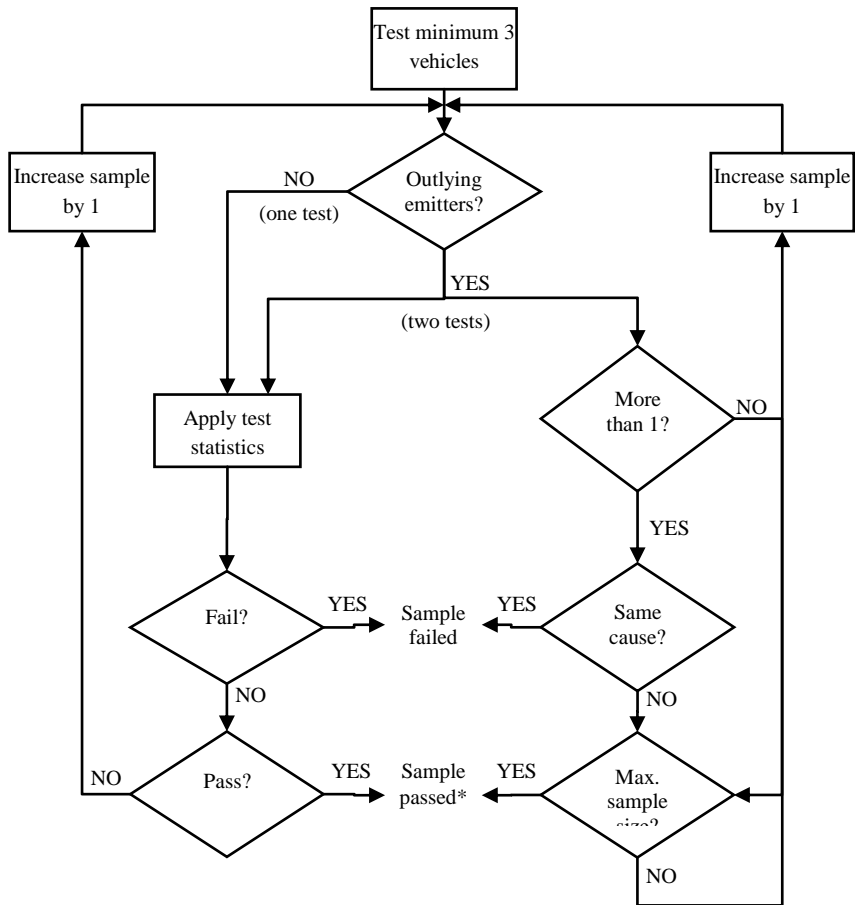

* If it fulfills both tests

Appendix 5

Responsibilities for in-service conformity

1. The process of checking in-service conformity is illustrated in Figure App5/1.
2. The manufacturer shall compile all the information needed to comply with the requirements of this annex. The Type Approval Authority may also take information from surveillance programmes into consideration.
3. The Type Approval Authority shall conduct all the procedures and tests necessary to ensure that the requirements regarding the in-service conformity are met (Phases 2 to 4).
4. In the event of discrepancies or disagreements in the assessment of information supplied, the Type Approval Authority shall request clarification from the technical service that conducted the type approval test.
5. The manufacturer shall establish and implement a plan of remedial measures. This plan shall be approved by the Type Approval Authority before it is implemented (Phase 5).

Figure App5/1
Illustration of the in-service conformity process

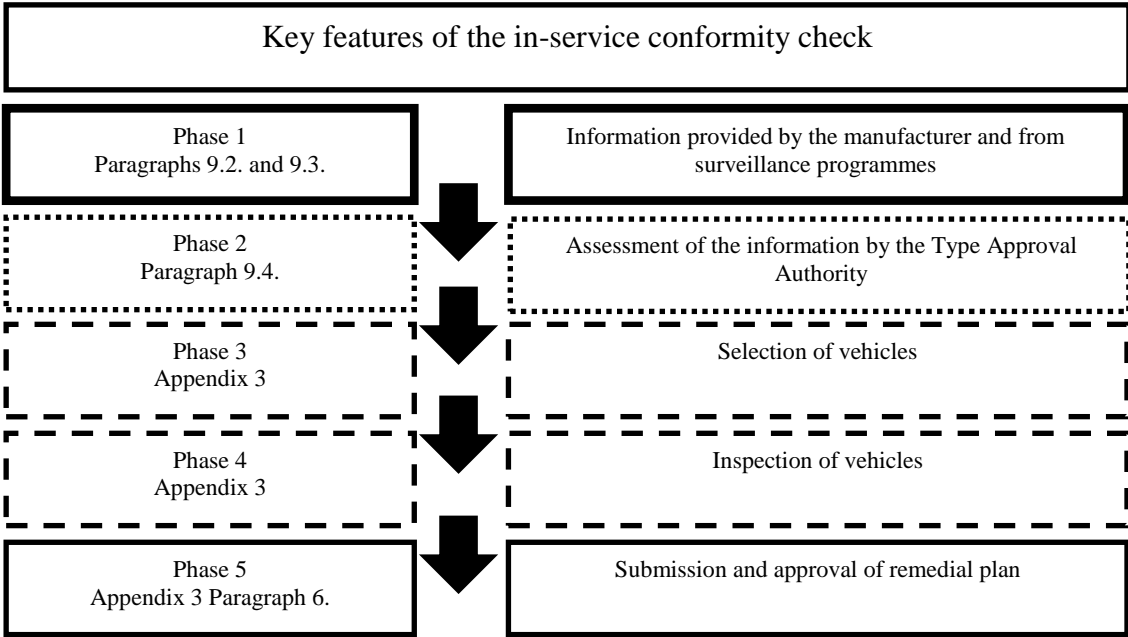

Appendix 6

Requirements for vehicles that use a reagent for the exhaust after-treatment system

1. Introduction

This appendix sets out the requirements for vehicles that rely on the use of a reagent for the after-treatment system in order to reduce emissions.
2. Reagent indication
 - 2.1. The vehicle shall include a specific indicator on the dashboard that informs the driver of low levels of reagent in the reagent storage tank and of when the reagent tank becomes empty.
3. Driver warning system
 - 3.1. The vehicle shall include a warning system consisting of visual alarms that informs the driver when the reagent level is low, that the tank soon needs to be refilled, or the reagent is not of a quality specified by the manufacturer. The warning system may also include an audible component to alert the driver.
 - 3.2. The warning system shall escalate in intensity as the reagent approaches empty. It shall culminate in a driver notification that cannot be easily defeated or ignored. It shall not be possible to turn off the system until the reagent has been replenished.
 - 3.3. The visual warning shall display a message indicating a low level of reagent. The warning shall not be the same as the warning used for the purposes of OBD or other engine maintenance. The warning shall be sufficiently clear for the driver to understand that the reagent level is low (e.g. "urea level low", "AdBlue level low", or "reagent low").
 - 3.4. The warning system does not initially need to be continuously activated, however the warning shall escalate so that it becomes continuous as the level of the reagent approaches the point where the driver inducement system in paragraph 8. of this appendix comes into effect. An explicit warning shall be displayed (e.g. "fill up urea", "fill up AdBlue", or "fill up reagent"). The continuous warning system may be temporarily interrupted by other warning signals providing important safety related messages.
 - 3.5. The warning system shall activate at a distance equivalent to a driving range of at least 2,400 km in advance of the reagent tank becoming empty.
4. Identification of incorrect reagent
 - 4.1. The vehicle shall include a means of determining that a reagent corresponding to the characteristics declared by the manufacturer and recorded in Annex 1 to this Regulation is present on the vehicle.
 - 4.2. If the reagent in the storage tank does not correspond to the minimum requirements declared by the manufacturer the driver warning system in paragraph 3. of this appendix shall be activated and shall display a message indicating an appropriate warning (e.g. "incorrect urea detected", "incorrect AdBlue detected", or "incorrect reagent detected"). If the reagent quality is

not rectified within 50 km of the activation of the warning system then the driver inducement requirements of paragraph 8. of this appendix shall apply.

5. Reagent consumption monitoring
 - 5.1. The vehicle shall include a means of determining reagent consumption and providing off-board access to consumption information.
 - 5.2. Average reagent consumption and average demanded reagent consumption by the engine system shall be available via the serial port of the standard diagnostic connector. Data shall be available over the previous complete 2,400 km period of vehicle operation.
 - 5.3. In order to monitor reagent consumption, at least the following parameters within the vehicle shall be monitored:
 - (a) The level of reagent in the on-vehicle storage tank; and
 - (b) The flow of reagent or injection of reagent as close as technically possible to the point of injection into an exhaust after-treatment system.
 - 5.4. A deviation of more than 50 per cent between the average reagent consumption and the average demanded reagent consumption by the engine system over a period of 30 minutes of vehicle operation, shall result in the activation of the driver warning system in paragraph 3., which shall display a message indicating an appropriate warning (e.g. "urea dosing malfunction", "AdBlue dosing malfunction", or "reagent dosing malfunction"). If the reagent consumption is not rectified within 50 km of the activation of the warning system then the driver inducement requirements of paragraph 8. shall apply.
 - 5.5. In the case of interruption in reagent dosing activity the driver warning system as referred to in paragraph 3. shall be activated, which shall display a message indicating an appropriate warning. This activation shall not be required where the interruption is demanded by the engine ECU because the vehicle operating conditions are such that the vehicle's emission performance does not require reagent dosing, provided that the manufacturer has clearly informed the Type Approval Authority when such operating conditions apply. If the reagent dosing is not rectified within 50 km of the activation of the warning system then the driver inducement requirements of paragraph 8. shall apply.
6. Monitoring NO_x emissions
 - 6.1. As an alternative to the monitoring requirements in paragraphs 4. and 5. above, manufacturers may use exhaust gas sensors directly to sense excess NO_x levels in the exhaust.
 - 6.2. The manufacturer shall demonstrate that use of the sensors referred to in paragraph 6.1. above and any other sensors on the vehicle, results in the activation of the driver warning system as referred to in paragraph 3. above, the display of a message indicating an appropriate warning (e.g. "emissions too high — check urea", "emissions too high — check AdBlue", "emissions too high — check reagent"), and the driver inducement system as referred to in paragraph 8.3. below, when the situations referred to in paragraphs 4.2., 5.4., or 5.5. above occur.

For the purposes of this paragraph these situations are presumed to occur if the applicable NO_x OBD threshold limit of the tables set out in paragraph 3.3.2. of Annex 11 to this Regulation is exceeded.

NOx emissions during the test to demonstrate compliance with these requirements shall be no more than 20 per cent higher than the OBD threshold limits.

7. Storage of failure information
 - 7.1. Where reference is made to this paragraph, non-erasable Parameter Identifiers (PID) shall be stored identifying the reason for and the distance travelled by the vehicle during the inducement system activation. The vehicle shall retain a record of the PID for at least 800 days or 30,000 km of vehicle operation. The PID shall be made available via the serial port of a standard diagnostic connector upon request of a generic scan tool according to the provisions of paragraph 6.5.3.1. of appendix 1 to Annex 11 to this Regulation. The information stored in the PID shall be linked to the period of cumulated vehicle operation, during which it has occurred, with an accuracy of not less than 300 days or 10,000 km.
 - 7.2. Malfunctions in the reagent dosing system attributed to technical failures (e.g. mechanical or electrical faults) shall also be subject to the OBD requirements in Annex 11 to this Regulation.
8. Driver inducement system
 - 8.1. The vehicle shall include a driver inducement system to ensure that the vehicle operates with a functioning emissions control system at all times. The inducement system shall be designed so as to ensure that the vehicle cannot operate with an empty reagent tank.
 - 8.2. The inducement system shall activate at the latest when the level of reagent in the tank reaches a level equivalent to the average driving range of the vehicle with a complete tank of fuel. The system shall also activate when the failures in paragraphs 4., 5., or 6. have occurred, depending on the NO_x monitoring approach. The detection of an empty reagent tank and the failures mentioned in paragraphs 4., 5., or 6. shall result in the failure information storage requirements of paragraph 7. coming into effect.
 - 8.3. The manufacturer shall select which type of inducement system to install. The options for a system are described in paragraphs 8.3.1., 8.3.2., 8.3.3. and 8.3.4. below.
 - 8.3.1. A "no engine restart after countdown" approach allows a countdown of restarts or distance remaining once the inducement system activates. Engine starts initiated by the vehicle control system, such as start-stop systems, are not included in this countdown. Engine restarts shall be prevented immediately after the reagent tank becomes empty or a distance equivalent to a complete tank of fuel has been exceeded since the activation of the inducement system, whichever occurs earlier.
 - 8.3.2. A "no start after refuelling" system results in a vehicle being unable to start after re-fuelling if the inducement system has activated.
 - 8.3.3. A "fuel-lockout" approach prevents the vehicle from being refuelled by locking the fuel filler system after the inducement system activates. The lockout system shall be robust to prevent it being tampered with.
 - 8.3.4. A "performance restriction" approach restricts the speed of the vehicle after the inducement system activates. The level of speed limitation shall be noticeable to the driver and significantly reduce the maximum speed of the vehicle. Such limitation shall enter into operation gradually or after an engine start. Shortly before engine restarts are prevented, the speed of the vehicle shall not exceed 50 km/h. Engine restarts shall be prevented immediately

- after the reagent tank becomes empty or a distance equivalent to a complete tank of fuel has been exceeded since the activation of inducement system, whichever occurs earlier.
- 8.4. Once the inducement system has fully activated and disabled the vehicle, the inducement system shall only be deactivated if the quantity of reagent added to the vehicle is equivalent to 2,400 km average driving range, or the failures specified in paragraphs 4., 5., or 6. have been rectified. After a repair has been carried out to correct a fault where the OBD system has been triggered under paragraph 7.2., the inducement system may be reinitialised via the OBD serial port (e.g. by a generic scan tool) to enable the vehicle to be restarted for self-diagnosis purposes. The vehicle shall operate for a maximum of 50 km to enable the success of the repair to be validated. The inducement system shall be fully reactivated if the fault persists after this validation.
- 8.5. The driver warning system referred to in paragraph 3. shall display a message indicating clearly:
- (a) The number of remaining restarts and/or the remaining distance; and
 - (b) The conditions under which the vehicle can be restarted.
- 8.6. The driver inducement system shall be deactivated when the conditions for its activation have ceased to exist. The driver inducement system shall not be automatically deactivated without the reason for its activation having been remedied.
- 8.7. Detailed written information fully describing the functional operation characteristics of the driver inducement system shall be provided to the Type Approval Authority at the time of approval.
- 8.8. As part of the application for type approval under this Regulation, the manufacturer shall demonstrate the operation of the driver warning and inducement systems.
9. Information requirements
- 9.1. The manufacturer shall provide all owners of new vehicles written information about the emission control system. This information shall state that if the vehicle emission control system is not functioning correctly, the driver shall be informed of a problem by the driver warning system and that the driver inducement system shall consequentially result in the vehicle being unable to start.
- 9.2. The instructions shall indicate requirements for the proper use and maintenance of vehicles, including the proper use of consumable reagents.
- 9.3. The instructions shall specify if consumable reagents have to be refilled by the vehicle operator between normal maintenance intervals. They shall indicate how the driver should refill the reagent tank. The information shall also indicate a likely rate of reagent consumption for that type of vehicle and how often it should be replenished.
- 9.4. The instructions shall specify that use of, and refilling of, a required reagent of the correct specifications is mandatory for the vehicle to comply with the certificate of conformity issued for that vehicle type.
- 9.5. The instructions shall state that it may be a criminal offence to use a vehicle that does not consume any reagent if it is required for the reduction of emissions.

- 9.6. The instructions shall explain how the warning system and driver inducement systems work. In addition, the consequences of ignoring the warning system and not replenishing the reagent shall be explained.
10. Operating conditions of the after-treatment system
- Manufacturers shall ensure that the emission control system retains its emission control function during all ambient conditions, especially at low ambient temperatures. This includes taking measures to prevent the complete freezing of the reagent during parking times of up to 7 days at 258 K (-15 °C) with the reagent tank 50 per cent full. If the reagent has frozen, the manufacturer shall ensure that reagent shall be available for use within 20 minutes of the vehicle starting at 258 K (-15 °C) measured inside the reagent tank, so as to ensure correct operation of the emission control system.

Annex 1

Engine and vehicle characteristics and information concerning the conduct of tests

The following information, when applicable, shall be supplied in triplicate and include a list of contents.

If there are drawings, they shall be to an appropriate scale and show sufficient detail; they shall be presented in A4 format or folded to that format. Photographs, if any, shall show sufficient detail.

If the systems, components or separate technical units have electronic controls, information concerning their performance shall be supplied.

0. General
 - 0.1. Make (name of undertaking):
 - 0.2. Type:.....
 - 0.2.1. Commercial name(s), if available:.....
 - 0.3. Means of identification of type, if marked on the vehicle:¹
 - 0.3.1. Location of that mark:
 - 0.4. Category of vehicle:²
 - 0.5. Name and address of manufacturer:
 - 0.8. Name(s) and address(es) of assembly plant(s):
 - 0.9. Name and address of manufacturer's authorized representative where appropriate:
1. General construction characteristics of the vehicle
 - 1.1. Photographs and/or drawings of a representative vehicle:
 - 1.3.3. Powered axles (number, position, interconnection):
2. Masses and dimensions³ (in kg and mm) (refer to drawing where applicable)
- 2.6. Mass of the vehicle with bodywork and, in the case of a towing vehicle of category other than M₁, with coupling device, if fitted by the manufacturer, in running order, or mass of the chassis or chassis with cab, without bodywork and/or coupling device if the manufacturer does not fit the bodywork and/or coupling device (including liquids, tools, spare wheel, if fitted, and driver and, for

¹ If the means of identification of type contains characters not relevant to describe the vehicle, component or separate technical unit types covered by this information document, such characters shall be represented in the documentation by the symbol '?' (e.g. ABC??123??).

² As defined in the Consolidated Resolution on the Construction of Vehicles (R.E.3.), document ECE/TRANS/WP.29/78/Rev.3, para. 2. - www.unece.org/trans/main/wp29/wp29wgs/wp29gen/wp29resolutions.html.

³ Where there is one version with a normal cab and another with a sleeper cab, both sets of masses and dimensions are to be stated.

	buses and coaches, a crew member if there is a crew seat in the vehicle) ⁴ (maximum and minimum for each variant):
2.8.	Technically permissible maximum laden mass as stated by the manufacturer: ^{5,6}
3.	Description of energy converters and power plant ⁷ (In the case of a vehicle that can run either on petrol, diesel, etc., or also in combination with another fuel, items shall be repeated ⁸)
3.1.	Engine Manufacturer:
3.1.1.	Manufacturer's engine code (as marked on the engine, or other means of identification):
3.2.	Internal combustion engine:
3.2.1.	Specific engine information:
3.2.1.1.	Working principle: positive-ignition/compression-ignition, four-stroke/two-stroke/rotary cycle ⁹
3.2.1.2.	Number, arrangement of cylinders:
3.2.1.2.1.	Bore: ¹⁰mm
3.2.1.2.2.	Stroke: ¹⁰mm
3.2.1.2.3.	Firing order:.....
3.2.1.3.	Engine capacity: ¹¹ cm ³
3.2.1.4.	Volumetric compression ratio: ¹²
3.2.1.5.	Drawings of combustion chamber and piston crown and, in the case of positive ignition engine, piston rings:.....
3.2.1.6.	Normal engine idling speed: ¹²
3.2.1.6.1.	High idle engine speed: ¹²
3.2.1.7.	Carbon monoxide content by volume in the exhaust gas with the engine idling (according to the manufacturer's specifications, positive ignition engines only) ¹² per cent

⁴ The mass of the driver and, if applicable, of the crew member is assessed at 75 kg (subdivided into 68 kg occupant mass and 7 kg luggage mass according to ISO Standard 2416 – 1992), the fuel tank is filled to 90 per cent and the other liquid containing systems (except those for used water) to 100 per cent of the capacity s specified by the manufacturer.

⁵ For trailers or semi-trailers, and for vehicles coupled with a trailer or a semi -trailer, which exert a significant vertical load on the coupling device or the fifth wheel, this load, divided by standard acceleration of gravity, is included in the maximum technical permissible mass.

⁶ Please fill in here the upper and lower values for each variant.

⁷ In the case of non -conventional engines and systems, particulars equivalent to those referred to here shall be supplied by the manufacturer.

⁸ Vehicles can be fuelled with both petrol and a gaseous fuel but if the petrol system is fitted for emergency purposes or starting only and the petrol tank cannot contain more than 15 litres of petrol, they will be regarded for the test as vehicles which can only run a gaseous fuel.

⁹ Strike out what does not apply.

¹⁰ This value shall be rounded-off to the nearest tenth of a millimetre.

¹¹ This value shall be calculated with $\pi = 3.1416$ and rounded-off to the nearest cm³.

¹² Specify the tolerance.

3.2.1.8.	Maximum net power: ¹³ kW at..... min ⁻¹
3.2.1.9.	Maximum permitted engine speed as prescribed by the manufacturer: min ⁻¹
3.2.1.10.	Maximum net torque: ¹³Nm at: min ⁻¹ (manufacturer's declared value)
3.2.2.	Fuel
3.2.2.1.	Light-duty vehicles: Diesel/Petrol/LPG/NG or Biomethane/Ethanol (E85)/Biodiesel/Hydrogen ¹⁴
3.2.2.2.	Research octane number (RON), unleaded:
3.2.2.3.	Fuel tank inlet: restricted orifice/label ⁹
3.2.2.4.	Vehicle fuel type: Mono fuel/Bi-fuel/Flex-fuel ⁹
3.2.2.5.	Maximum amount of biofuel acceptable in fuel (manufacturer's declared value): per cent by volume
3.2.4.	Fuel feed
3.2.4.2.	By fuel injection (compression-ignition only): yes/no ⁹
3.2.4.2.1.	System description:
3.2.4.2.2.	Working principle: direct-injection/pre-chamber/swirl Chamber ⁹
3.2.4.2.3.	Injection pump
3.2.4.2.3.1.	Make(s):
3.2.4.2.3.2.	Type(s):
3.2.4.2.3.3.	Maximum fuel delivery ^{9,12}mm ³ stroke or cycle at an engine speed of: ^{9,12}min ⁻¹ or characteristic diagram:
3.2.4.2.3.5.	Injection advance curve: ¹²
3.2.4.2.4.	Governor
3.2.4.2.4.2.	Cut-off point:
3.2.4.2.4.2.1.	Cut-off point under load: min ⁻¹
3.2.4.2.4.2.2.	Cut-off point without load: min ⁻¹
3.2.4.2.6.	Injector(s):
3.2.4.2.6.1.	Make(s):
3.2.4.2.6.2.	Type(s):
3.2.4.2.7.	Cold start system
3.2.4.2.7.1.	Make(s):
3.2.4.2.7.2.	Type(s):

¹³ Determined in accordance with the requirements of Regulation No. 85.

¹⁴ Delete where not applicable (there are cases where nothing needs to be deleted when more than one entry is applicable).

3.2.4.2.7.3.	Description:
3.2.4.2.8.	Auxiliary starting aid
3.2.4.2.8.1.	Make(s):
3.2.4.2.8.2.	Type(s):
3.2.4.2.8.3.	System description:
3.2.4.2.9.	Electronic controlled injection: yes/no ⁹
3.2.4.2.9.1.	Make(s):
3.2.4.2.9.2.	Type(s):
3.2.4.2.9.3.	Description of the system (in the case of systems other than continuous injection, give equivalent details):
3.2.4.2.9.3.1.	Make and type of the control unit:
3.2.4.2.9.3.2.	Make and type of the fuel regulator:
3.2.4.2.9.3.3.	Make and type of air-flow sensor:
3.2.4.2.9.3.4.	Make and type of fuel distributor:
3.2.4.2.9.3.5.	Make and type of throttle housing:
3.2.4.2.9.3.6.	Make and type of water temperature sensor:
3.2.4.2.9.3.7.	Make and type of air temperature sensor:
3.2.4.2.9.3.8.	Make and type of air pressure sensor:
3.2.4.3.	By fuel injection (positive-ignition only): yes/no ⁹
3.2.4.3.1.	Working principle: intake manifold (single/multi-point)/direct injection/other (specify).....
3.2.4.3.2.	Make(s):
3.2.4.3.3.	Type(s):
3.2.4.3.4.	System description (in the case of systems other than continuous injection give equivalent details):
3.2.4.3.4.1.	Make and type of the control unit:
3.2.4.3.4.2.	Make and type of the fuel regulator:
3.2.4.3.4.3.	Make and type of the air-flow sensor:
3.2.4.3.4.6.	Make and type of the micro-switch:
3.2.4.3.4.8.	Make and type of the throttle housing:
3.2.4.3.4.9.	Make and type of the water temperature sensor:
3.2.4.3.4.10.	Make and type of the air temperature sensor:
3.2.4.3.5.	Injectors: Opening pressure: ^{9,12} kPa or characteristic diagram:.....
3.2.4.3.5.1.	Make(s):
3.2.4.3.5.2.	Type(s):
3.2.4.3.6.	Injection timing:
3.2.4.3.7.	Cold start system:

3.2.4.3.7.1.	Operating principle(s):.....
3.2.4.3.7.2.	Operating limits/settings ^{9,12}
3.2.4.4.	Feed pump
3.2.4.4.1.	Pressure ^{9,12}kPa or characteristic diagram:.....
3.2.5.	Electrical system.....
3.2.5.1.	Rated voltage:..... V, positive/negative ground ⁹
3.2.5.2.	Generator
3.2.5.2.1.	Type:.....
3.2.5.2.2.	Nominal output: VA
3.2.6.	Ignition
3.2.6.1.	Make(s):
3.2.6.2.	Type(s):
3.2.6.3.	Working principle:.....
3.2.6.4.	Ignition advance curve: ¹²
3.2.6.5.	Static ignition timing: ¹²degrees before TDC
3.2.7.	Cooling system: liquid/air ⁹
3.2.7.1.	Nominal setting of the engine temperature control mechanism:
3.2.7.2.	Liquid
3.2.7.2.1.	Nature of liquid:
3.2.7.2.2.	Circulating pump(s):yes/no ⁹
3.2.7.2.3.	Characteristics:, or
3.2.7.2.3.1.	Make(s):
3.2.7.2.3.2.	Type(s):
3.2.7.2.4.	Drive ratio(s):
3.2.7.2.5.	Description of the fan and its drive mechanism:
3.2.7.3.	Air
3.2.7.3.1.	Blower: yes/no ⁹
3.2.7.3.2.	Characteristics:, or
3.2.7.3.2.1.	Make(s):
3.2.7.3.2.2.	Type(s):
3.2.7.3.3.	Drive ratio(s):
3.2.8.	Intake system:.....
3.2.8.1.	Pressure charger: yes/no ⁹
3.2.8.1.1.	Make(s):
3.2.8.1.2.	Type(s):
3.2.8.1.3.	Description of the system (maximum charge pressure:kPa, waste-gate, if applicable).....

3.2.8.2.	Inter-cooler: yes/no ⁹
3.2.8.2.1.	Type: air-air / air-water ⁹
3.2.8.3.	Intake depression at rated engine speed and at 100 per cent load (compression ignition engines only)
	Minimum allowable: kPa
	Maximum allowable: kPa
3.2.8.4.	Description and drawings of inlet pipes and their accessories (plenum chamber, heating device, additional air intakes, etc.):
3.2.8.4.1.	Intake manifold description (drawings and/or photographs):
3.2.8.4.2.	Air filter, drawings: , or
3.2.8.4.2.1.	Make(s):
3.2.8.4.2.2.	Type(s):
3.2.8.4.3.	Intake silencer, drawings , or
3.2.8.4.3.1.	Make(s):
3.2.8.4.3.2.	Type(s):
3.2.9.	Exhaust system
3.2.9.1.	Description and/or drawing of the exhaust manifold:
3.2.9.2.	Description and/or drawing of the exhaust system:
3.2.9.3.	Maximum allowable exhaust back pressure at rated engine speed and at 100 per cent load (compression ignition engines only): kPa
3.2.9.10.	Minimum cross-sectional areas of inlet and outlet ports:
3.2.11.	Valve timing or equivalent data:
3.2.11.1.	Maximum lift of valves, angles of opening and closing, or timing details of alternative distribution systems, in relation to dead centres (for variable timing system, minimum and maximum timing):
3.2.11.2.	Reference and/or setting ranges: ^{9,12}
3.2.12.	Measures taken against air pollution:
3.2.12.1.	Device for recycling crankcase gases (description and drawings):
3.2.12.2.	Additional pollution control devices (if any, and if not covered by another heading:
3.2.12.2.1.	Catalytic converter: yes/no ⁹
3.2.12.2.1.1.	Number of catalytic converters and elements (provide the information below for each separate unit:
3.2.12.2.1.2.	Dimensions and shape of the catalytic converter(s) (volume,...):
3.2.12.2.1.3.	Type of catalytic action:
3.2.12.2.1.4.	Total charge of precious metal:
3.2.12.2.1.5.	Relative concentration:
3.2.12.2.1.6.	Substrate (structure and material):
3.2.12.2.1.7.	Cell density:

-
- 3.2.12.2.1.8. Type of casing for catalytic converter(s):
- 3.2.12.2.1.9. Positioning of the catalytic converter(s) (place and reference distances in the exhaust system):
- 3.2.12.2.1.10. Heat shield: yes/no⁹
- 3.2.12.2.1.11. Regeneration systems/method of exhaust after-treatment systems, description:
- 3.2.12.2.1.11.1. The number of Type I operating cycles, or equivalent engine test bench cycles, between two cycles where regenerative phases occur under the conditions equivalent to Type I test (Distance "D" in Figure A13/1 in Annex 13 to this Regulation):
- 3.2.12.2.1.11.2. Description of method employed to determine the number of cycles between two cycles where regenerative phases occur:
- 3.2.12.2.1.11.3. Parameters to determine the level of loading required before regeneration occurs (i.e. temperature, pressure etc.):
- 3.2.12.2.1.11.4. Description of method used to load system in the test procedure described in paragraph 3.1. of Annex 13 to this Regulation:
- 3.2.12.2.1.11.5. Normal operating temperature range (K):
- 3.2.12.2.1.11.6. Consumable reagents (where appropriate):
- 3.2.12.2.1.11.7. Type and concentration of reagent needed for catalytic action (where appropriate):
- 3.2.12.2.1.11.8. Normal operational temperature range of reagent (where appropriate):
- 3.2.12.2.1.11.9. International standard (where appropriate):
- 3.2.12.2.1.11.10. Frequency of reagent refill: continuous/maintenance⁹ (where appropriate):
- 3.2.12.2.1.12. Make of catalytic converter:
- 3.2.12.2.1.13. Identifying part number:
- 3.2.12.2.2. Oxygen sensor: yes/no⁹
- 3.2.12.2.2.1. Type:
- 3.2.12.2.2.2. Location of oxygen sensor:
- 3.2.12.2.2.3. Control range of oxygen sensor:¹²
- 3.2.12.2.2.4. Make of oxygen sensor:
- 3.2.12.2.2.5. Identifying part number:
- 3.2.12.2.3. Air injection: yes/no⁹
- 3.2.12.2.3.1. Type (pulse air, air pump, etc.):
- 3.2.12.2.4. Exhaust gas recirculation (EGR): yes/no⁹
- 3.2.12.2.4.1. Characteristics (flow rate, etc.):
- 3.2.12.2.4.2. Water cooled system: yes/no⁹
- 3.2.12.2.5. Evaporative emission control system: yes/no⁹
- 3.2.12.2.5.1. Detailed description of the devices and their state of tune:

3.2.12.2.5.2.	Drawing of the evaporative control system:
3.2.12.2.5.3.	Drawing of the carbon canister:.....
3.2.12.2.5.4.	Mass of dry charcoal:g
3.2.12.2.5.5.	Schematic drawing of the fuel tank with indication of capacity and material:.....
3.2.12.2.5.6.	Drawing of the heat shield between tank and exhaust system:.....
3.2.12.2.6.	Particulate trap: yes/no ⁹
3.2.12.2.6.1.	Dimensions and shape of the particulate trap (capacity):
3.2.12.2.6.2.	Type and design of particulate trap and design:
3.2.12.2.6.3.	Location of the particulate trap (reference distances in the exhaust line):
3.2.12.2.6.4.	Regeneration system/method. Description and/or drawing:
3.2.12.2.6.4.1.	The number of Type I operating cycles, or equivalent engine test bench cycle, between two cycles where regeneration phases occur under the conditions equivalent to Type I test (Distance 'D' in Figure A13/1 in Annex 13 to this Regulation):
3.2.12.2.6.4.2.	Description of method employed to determine the number of cycles between two cycles where regenerative phases occur:
3.2.12.2.6.4.3.	Parameters to determine the level of loading required before regeneration occurs (i.e. temperature, pressure, etc.):
3.2.12.2.6.4.4.	Description of method used to load system in the test procedure described in paragraph 3.1. of Annex 13 to this Regulation:
3.2.12.2.6.5.	Make of particulate trap:
3.2.12.2.6.6.	Identifying part number:
3.2.12.2.7.	On-board-diagnostic (OBD) system: (yes/no) ⁹
3.2.12.2.7.1.	Written description and/or drawing of the malfunction indicator (MI):.
3.2.12.2.7.2.	List and purpose of all components monitored by the OBD system:
3.2.12.2.7.3.	Written description (general working principles) for:
3.2.12.2.7.3.1.	Positive-ignition engines
3.2.12.2.7.3.1.1.	Catalyst monitoring:
3.2.12.2.7.3.1.2.	Misfire detection:
3.2.12.2.7.3.1.3.	Oxygen sensor monitoring:
3.2.12.2.7.3.1.4.	Other components monitored by the OBD system:
3.2.12.2.7.3.2.	Compression-ignition engines
3.2.12.2.7.3.2.1.	Catalyst monitoring:
3.2.12.2.7.3.2.2.	Particulate trap monitoring:
3.2.12.2.7.3.2.3.	Electronic fuelling system monitoring:

- 3.2.12.2.7.3.2.4. Other components monitored by the OBD system:
- 3.2.12.2.7.4. Criteria for MI activation (fixed number of driving cycles or statistical method):
- 3.2.12.2.7.5. List of all OBD output codes and formats used (with explanation of each):
- 3.2.12.2.7.6. The following additional information must be provided by the vehicle manufacturer for the purposes of enabling the manufacture of OBD-compatible replacement or service parts and diagnostic tools and test equipment, unless such information is covered by intellectual property rights or constitutes specific know-how of the manufacturer or the OEM supplier(s).
- 3.2.12.2.7.6.1. A description of the type and number of the pre-conditioning cycles used for the original type approval of the vehicle.
- 3.2.12.2.7.6.2. A description of the type of the OBD demonstration cycle used for the original type-approval of the vehicle for the component monitored by the OBD system.
- 3.2.12.2.7.6.3. A comprehensive document describing all sensed components with the strategy for fault detection and MI activation (fixed number of driving cycles or statistical method), including a list of relevant secondary sensed parameters for each component monitored by the OBD system. A list of all OBD output codes and format used (with an explanation of each) associated with individual emission related power-train components and individual non-emission related components, where monitoring of the component is used to determine MI activation. In particular, a comprehensive explanation for the data given in service \$05 Test ID \$21 to FF and the data given in service \$06 must be provided. In the case of vehicle types that use a communication link in accordance with ISO 15765-4 "Road vehicles – Diagnostics on Controller Area Network (CAN) – Part 4: Requirements for emissions-related systems", a comprehensive explanation for the data given in service \$06 Test ID \$00 to FF, for each OBD monitor ID supported, must be provided.
- 3.2.12.2.7.6.4. The information required by this paragraph may, for example, be defined by completing a table as follows, which shall be attached to this annex:

<i>Component</i>	<i>Fault code</i>	<i>Monitoring strategy</i>	<i>Fault detection criteria</i>	<i>MI activation criteria</i>	<i>Secondary parameters</i>	<i>Preconditioning</i>	<i>Demonstration test</i>
Catalyst	P0420	Oxygen sensor 1 and 2 signals	Difference between sensor 1 and sensor 2 signals	3 rd cycle	Engine speed, engine load, A/F mode, catalyst temperature	Two Type I cycles	Type I

- 3.2.12.2.8. Other systems (description and operation):
- 3.2.13. Location of the absorption coefficient symbol (compression ignition engines only):
- 3.2.14. Details of any devices designed to influence fuel economy (if not covered by other items):

3.2.15.	LPG fuelling system: yes/no ⁹
3.2.15.1.	Approval number (approval number of Regulation No. 67):
3.2.15.2.	Electronic engine management control unit for LPG fuelling
3.2.15.2.1.	Make(s):
3.2.15.2.2.	Type(s):
3.2.15.2.3.	Emission-related adjustment possibilities:
3.2.15.3.	Further documentation:
3.2.15.3.1.	Description of the safeguarding of the catalyst at switch-over from petrol to LPG or back:
3.2.15.3.2.	System layout (electrical connections, vacuum connections, compensation hoses, etc.)
3.2.15.3.3.	Drawing of the symbol:
3.2.16.	NG fuelling system: yes/no ⁹
3.2.16.1.	Approval number (approval number of Regulation No. 110):
3.2.16.2.	Electronic engine management control unit for NG fuelling
3.2.16.2.1.	Make(s):
3.2.16.2.2.	Type(s):
3.2.16.2.3.	Emission-related adjustment possibilities:
3.2.16.3.	Further documentation:
3.2.16.3.1.	Description of the safeguarding of the catalyst at switch-over from petrol to NG or back:
3.2.16.3.2.	System layout (electrical connections, vacuum connections, compensation hoses, etc.):
3.2.16.3.3.	Drawing of the symbol:
3.2.18.	Hydrogen fuelling system: yes/no ⁹
3.2.18.1.	Type-approval number according to [Global Technical Regulation (gtr) on hydrogen and fuel cell vehicles, currently under development]:
3.2.18.2.	Electronic engine management control unit for hydrogen fuelling
3.2.18.2.1.	Make(s):
3.2.18.2.2.	Type(s):
3.2.18.2.3.	Emission-related adjustment possibilities:
3.2.18.3.	Further documentation
3.2.18.3.1.	Description of the safeguarding of the catalyst at switch-over from petrol to hydrogen or back:
3.2.18.3.2.	System lay-out (electrical connections, vacuum connections compensation hoses, etc.):
3.2.18.3.3.	Drawing of the symbol:
3.3.	Electric motor

-
- 3.3.1. Type (winding, excitation):
 - 3.3.1.1. Maximum hourly output: kW (manufacturer's declared value)
 - 3.3.1.1.1. Maximum net power¹⁵ kW (manufacturer's declared value)
 - 3.3.1.1.2. Maximum 30 minutes power¹⁵ ... kW (manufacturer's declared value)
 - 3.3.1.2. Operating voltage: V
 - 3.3.2. Battery
 - 3.3.2.1. Number of cells:
 - 3.3.2.2. Mass:kg
 - 3.3.2.3. Capacity: Ah (Amp-hours)
 - 3.3.2.4. Position:
 - 3.4. Engines or motor combinations
 - 3.4.1. Hybrid Electric Vehicle: yes/no⁹
 - 3.4.2. Category of Hybrid Electric vehicle Off Vehicle Charging/Not Off Vehicle Charging⁹
 - 3.4.3. Operating mode switch: with/without⁹
 - 3.4.3.1. Selectable modes
 - 3.4.3.1.1. Pure electric: yes/no⁹
 - 3.4.3.1.2. Pure fuel consuming: yes/no⁹
 - 3.4.3.1.3. Hybrid modes: yes/no (if yes, short description)
 - 3.4.4. Description of the energy storage device: (battery, capacitor, flywheel/generator...)
 - 3.4.4.1. Make(s):
 - 3.4.4.2. Type(s):
 - 3.4.4.3. Identification number:
 - 3.4.4.4. Kind of electrochemical couple:
 - 3.4.4.5. Energy: (for battery: voltage and capacity Ah in 2 h, for capacitor: J, ..)
 - 3.4.4.6. Charger: on board/external/without⁹
 - 3.4.5. Electric machines (describe each type of electric machine separately)
 - 3.4.5.1. Make:.....
 - 3.4.5.2. Type:
 - 3.4.5.3. Primary use: traction motor/generator
 - 3.4.5.3.1. When used as traction motor: monomotor/multimotors (number):
 - 3.4.5.4. Maximum power: kW
 - 3.4.5.5. Working principle:.....

¹⁵ Determined in accordance with the requirements of Regulation No. 85.

3.4.5.5.1.	Direct current/alternating current/number of phases:
3.4.5.5.2.	Separate excitation/series/compound ⁹
3.4.5.5.3.	Synchronous/asynchronous ⁹
3.4.6.	Control unit.....
3.4.6.1.	Make:.....
3.4.6.2.	Type:.....
3.4.6.3.	Identification number:
3.4.7.	Power controller
3.4.7.1.	Make:.....
3.4.7.2.	Type:.....
3.4.7.3.	Identification number:
3.4.8.	Vehicle electric range..... km (according to Annex 9 of Regulation No.101):
3.4.9.	Manufacturer's recommendation for preconditioning:
3.6.	Temperatures permitted by the manufacturer
3.6.1.	Cooling system
3.6.1.1.	Liquid cooling
3.6.1.1.1.	Maximum temperature at outlet: K
3.6.1.2.	Air cooling
3.6.1.2.1.	Reference point:
3.6.1.2.2.	Maximum temperature at reference point: K
3.6.2.	Maximum outlet temperature of the inlet intercooler: K
3.6.3.	Maximum exhaust temperature at the point in the exhaust pipe(s) adjacent to the outer flange(s) of the exhaust manifold: K
3.6.4.	Fuel temperature
3.6.4.1.	Minimum: K
3.6.4.2.	Maximum: K
3.6.5.	Lubricant temperature
3.6.5.1.	Minimum: K
3.6.5.2.	Maximum: K
3.8.	Lubrication system
3.8.1.	Description of the system
3.8.1.1.	Position of the lubricant reservoir:
3.8.1.2.	Feed system (by pump/injection into intake/mixing with fuel, etc.) ⁹
3.8.2.	Lubricating pump
3.8.2.1.	Make(s):
3.8.2.2.	Type(s):

- 3.8.3. Mixture with fuel
- 3.8.3.1. Percentage:
- 3.8.4. Oil cooler: yes/no⁹
- 3.8.4.1. Drawing(s):..... , or
- 3.8.4.1.1. Make(s):
- 3.8.4.1.2. Type(s):
- 4. Transmission¹⁶
- 4.3. Moment of inertia of engine flywheel:
- 4.3.1. Additional moment of inertia with no gear engaged:
- 4.4. Clutch (type):.....
- 4.4.1. Maximum torque conversion:.....
- 4.5. Gearbox:
- 4.5.1. Type (manual/automatic/CVT (continuously variable transmission)⁹....
- 4.6. Gear ratios

<i>Index</i>	<i>Internal gearbox ratios (ratios of engine to gearbox output shaft revolutions)</i>	<i>Final drive ratios (ratio of gearbox output shaft to driven wheel revolutions)</i>	<i>Total gear ratios</i>
Maximum for continuously variable transmission (CVT)			
1			
2			
3			
4, 5, others			
Minimum for CVT			
Reverse			

- 6. Suspension.....
- 6.6. Tyres and wheels
- 6.6.1. Tyre / wheel combination(s)
 - (a)
 - For all tyre options indicate size designation, load-capacity index,
speed Category symbol;
 - (b)

¹⁶ The specified particulars are to be given for any proposed variants.

- For tyres of category Z intended to be fitted on vehicles whose maximum speed exceeds 300 km/h equivalent information shall be provided; for wheels indicate rim size(s) and off-set(s).
- 6.6.1.1. Axles
 - 6.6.1.1.1. Axle 1:
 - 6.6.1.1.2. Axle 2:
 - 6.6.1.1.3. Axle 3:
 - 6.6.1.1.4. Axle 4: etc.
 - 6.6.2. Upper and lower limit of rolling radii/circumference:¹⁷
 - 6.6.2.1. Axles
 - 6.6.2.1.1. Axle 1:
 - 6.6.2.1.2. Axle 2:
 - 6.6.2.1.3. Axle 3:
 - 6.6.2.1.4. Axle 4: etc.
 - 6.6.3. Tyre pressure(s) recommended by the manufacturer: kPa
 - 9. Bodywork
 - 9.1. Type of bodywork:¹⁸
 - 9.10.3. Seats
 - 9.10.3.1. Number:

¹⁷ Specify one or another.

¹⁸ As defined in the Consolidated Resolution on the Construction of Vehicles (R.E.3.), document ECE/TRANS/WP.29/78/Rev.3, para. 2. - www.unece.org/trans/main/wp29/wp29wgs/wp29gen/wp29resolutions.html.

Annex 1 - Appendix 1

Information on test conditions

- 1. Spark plug
 - 1.1. Make:
 - 1.2. Type:
 - 1.3. Spark-gap setting:
- 2. Ignition coil
 - 2.1. Make:
 - 2.2. Type:
- 3. Lubricant used
 - 3.1. Make:.....
 - 3.2. Type: (state percentage of oil in mixture if lubricant and fuel mixed)
- 4. Dynamometer load setting information (repeat information for each dynamometer test)
 - 4.1. Vehicle bodywork type (variant/version)
 - 4.2. Gearbox type (manual/automatic/CVT)
 - 4.3. Fixed load curve dynamometer setting information (if used).....
 - 4.3.1. Alternative dynamometer load setting method used (yes/no¹)
 - 4.3.2. Inertia mass (kg):.....
 - 4.3.3. Effective power absorbed at 80km/h including running losses of the vehicle on the dynamometer (kW)
 - 4.3.4. Effective power absorbed at 50km/h including running losses of the vehicle on the dynamometer (kW).....
 - 4.4. Adjustable load curve dynamometer setting information (if used)
 - 4.4.1. Coast down information from the test track
 - 4.4.2. Tyres make and type:
 - 4.4.3. Tyre dimensions (front/rear):
 - 4.4.4. Tyre pressure (front/rear) (kPa):.....
 - 4.4.5. Vehicle test mass including driver (kg):

¹ Strike out what does not apply.

4.4.6. Road coast down data (if used)

<i>V (km/h)</i>	<i>V₂ (km/h)</i>	<i>V₁ (km/h)</i>	<i>Mean corrected coast down time (s)</i>
120			
100			
80			
60			
40			
20			

4.4.7. Average corrected road power (if used)

<i>V (km/h)</i>	<i>CPcorrected (kW)</i>
120	
100	
80	
60	
40	
20	

Annex 2

Communication

(maximum format: A4 (210 x 297 mm))

issued by:
Name of administration:
.....
.....

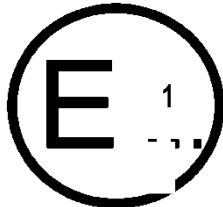

concerning:² Approval granted
Approval extended
Approval refused
Approval withdrawn
Production definitively discontinued

of a vehicle type with regard to the emission of gaseous pollutants by the engine pursuant to Regulation No. 83

Approval No. Extension No.
Reason for extension:.....

Section I

- 0.1. Make (trade name of manufacturer):
- 0.2. Type:
- 0.2.1. Commercial name(s) (if available):
- 0.3. Means of identification of type if marked on the vehicle³
- 0.3.1. Location of that marking:
- 0.4. Category of vehicle⁴
- 0.5. Name and address of manufacturer:
- 0.8. Name(s) and address(es) of assembly plant(s):
- 0.9. If applicable, name and address of manufacturer's representative:

¹ Distinguishing number of the country which has granted/extended/refused/withdrawn approval (see approval provisions in the Regulation).

² Strike out what does not apply.

³ If the means of identification of type contains characters not relevant to describe the vehicle, component or separate technical unit types covered by this information document, such characters shall be represented in the documentation by the symbol '?' (e.g. ABC??123??).

⁴ As defined in the Consolidated Resolution on the Construction of Vehicles (R.E.3.), document ECE/TRANS/WP.29/78/Rev.3, para. 2. - www.unece.org/trans/main/wp29/wp29wgs/wp29gen/wp29resolutions.html.

Section II

1. Additional information (where applicable): (see addendum)
2. Technical Service responsible for carrying out the tests:
3. Date of test report:
4. Number of test report:
5. Remarks (if any): (see addendum)
6. Place:
7. Date:
8. Signature:

- Attachments: 1. Information package.
2. Test report.

Addendum to type approval communication No ... concerning the type approval of a vehicle with regard to exhaust emissions pursuant to Regulation No. 83, 07 series of amendments

1. Additional information
 - 1.1. Mass of the vehicle in running order:
 - 1.2. Reference mass of the vehicle:
 - 1.3. Maximum mass of the vehicle:
 - 1.4. Number of seats (including the driver):
 - 1.6. Type of bodywork:
 - 1.6.1. For M₁, M₂: saloon/ hatchback/station wagon/coupé/convertible/multipurpose vehicle⁵
 - 1.6.2. For N₁, N₂: lorry, van⁵
 - 1.7. Drive wheels: front, rear, 4 x 4⁵
 - 1.8. Pure electric vehicle: yes/no⁵
 - 1.9. Hybrid electric vehicle: yes/no⁵
 - 1.9.1. Category of Hybrid Electric vehicle: Off Vehicle Charging (OVC)/Not Off Vehicle charging (NOVC)⁵
 - 1.9.2. Operating mode switch: with/without⁵
 - 1.10. Engine identification:.....
 - 1.10.1. Engine displacement:.....
 - 1.10.2. Fuel supply system: direct injection/indirect injection⁵
 - 1.10.3. Fuel recommended by the manufacturer:
 - 1.10.4. Maximum power: kW at min⁻¹
 - 1.10.5. Pressure charging device: yes/no⁵
 - 1.10.6. Ignition system: compression ignition / positive ignition⁵
 - 1.11. Power train (for pure electric vehicle or hybrid electric vehicle)⁵
 - 1.11.1. Maximum net power: kW, at: to min⁻¹
 - 1.11.2. Maximum thirty minutes power: kW
 - 1.11.3. Maximum net torque: Nm, at min⁻¹
 - 1.12. Traction battery (for pure electric vehicle or hybrid electric vehicle)
 - 1.12.1. Nominal voltage: V
 - 1.12.2. Capacity (2 h rate): Ah
 - 1.13. Transmission
 - 1.13.1. Manual or automatic or continuously variable transmission:^{5,6}

⁵ Delete or strike out what does not apply (there are cases where nothing needs to be deleted when more than one entry is applicable).

⁶ In the case of vehicles equipped with automatic-shift gearboxes, give all pertinent technical data.

- 1.13.2. Number of gear ratios:
- 1.13.3. Total gear ratios (including the rolling circumferences of the tyres under load): road speeds per 1,000 min⁻¹ (km/h)
 First gear: Sixth gear:
 Second gear: Seventh gear:
 Third gear: Eighth gear:
 Fourth gear: Overdrive:.....
 Fifth gear:
- 1.13.4. Final drive ratio:
- 1.14. Tyres:
- 1.14.1. Type:
- 1.14.2. Dimensions:
- 1.14.3. Rolling circumference under load:.....
- 1.14.4. Rolling circumference of tyres used for the Type I test
2. Test results
- 2.1. Tailpipe emissions test results:
- Emissions classification: 07 series of amendments

Type approval number if not parent vehicle⁷

Type I Result	Test	CO (mg/km)	THC (mg/km)	NMHC (mg/km)	NO _x (mg/km)	THC+NO _x (mg/km)	Particulates (mg/km)	Particles (#/km)
Measured ^{i,ii}	1							
	2							
	3							
Measured mean value (M) ^{i,ii}								
Ki ^{i,iii}						iv		
Mean value calculated with Ki (M.Ki) ⁱⁱ						v		
DF ^{i,iii}								
Final mean value calculated with Ki and DF (M.Ki.DF) ^{vi}								
Limit value								

- ⁱ Where applicable
ⁱⁱ Round to 2 decimal places
ⁱⁱⁱ Round to 4 decimal places
^{iv} Not applicable
^v Mean value calculated by adding mean values (M.Ki) calculated for THC and NO_x
^{vi} Round to 1 decimal place more than limit value

⁷ If the means of identification of type contains characters not relevant to describe the vehicle, component or separate technical unit types covered by this information document, such characters shall be represented in the documentation by the symbol '?' (e.g. ABC??123??).

Position of the engine cooling fan during the test:
 Height of the lower edge above ground: cm
 Lateral position of fan centre: cm
 Right/left of vehicle centre-line⁵Information about regeneration strategy
 D - Number of operating cycles between two (2) cycles where regenerative phases occur:
 d - Number of operating cycles required for regeneration:
 Type II: per cent
 Type III:
 Type IV: g/test
 Type V:
 Durability test type: whole vehicle test/bench ageing test/none⁵
 - Deterioration factor DF: calculated/assigned⁵
 - Specify the values (DF):

Type VI:

Type VI	CO (mg/km)	THC (mg/km)
Measured value		

2.1.1. For bi fuel vehicles, the type I table shall be repeated for both fuels. For flex fuel vehicles, when the type 1 test is to be performed on both fuels according to Table A. of this Regulation and for vehicles running on LPG or NG/Biomethane, either mono fuel or bi fuel, the table shall be repeated for the different reference gases used in the test, and an additional table shall display the worst results obtained. When applicable, in accordance with paragraphs 3.1.4 and 3.1.5 of Annex 12 of this Regulation, it shall be shown if the results are measured or calculated.

OBD test

- 2.1.2. Written description and/or drawing of the malfunction indicator (MI):
- 2.1.3. List and function of all components monitored by the OBD system:
- 2.1.4. Written description (general working principles) for:
- 2.1.4.1. Misfire detection:⁸.....
- 2.1.4.2. Catalyst monitoring:⁸.....
- 2.1.4.3. Oxygen sensor monitoring:⁸.....
- 2.1.4.4. Other components monitored by the OBD system:⁸.....
- 2.1.4.5. Catalyst monitoring:⁹.....
- 2.1.4.6. Particulate trap monitoring:⁹.....

⁸ For compression-ignition engine vehicles.

⁹ For vehicles equipped with positive-ignition engines.

- 2.1.4.7. Electronic fuelling system actuator monitoring:⁹
- 2.1.4.8. Other components monitored by the OBD system:
- 2.1.5. Criteria for MI activation (fixed number of driving cycles or statistical method):.....
- 2.1.6. List of all OBD output codes and formats used (with explanation of each):
.....
- 2.2. Emissions data required for roadworthiness testing

<i>Test</i>	<i>CO value (per cent vol.)</i>	<i>Lambdaⁱ</i>	<i>Engine speed (min⁻¹)</i>	<i>Engine oil temperature (°C)</i>
Low idle test		N/A		
High idle test				

ⁱ Lambda formula: see paragraph 5.3.7.3. of this Regulation.

- 2.3. Catalytic converters: yes/no²
- 2.3.1. Original equipment catalytic converter tested to all relevant requirements of this Regulation yes/no⁵
- 2.4. Smoke opacity test results^{5,10}
- 2.4.1. At steady speeds: See technical service test report number
- 2.4.2. Free acceleration tests
- 2.4.2.1. Measured value of the absorption coefficient:m⁻¹
- 2.4.2.2. Corrected value of the absorption coefficient:m⁻¹
- 2.4.2.3. Location of the absorption coefficient symbol on the vehicle:
- 3. Remarks:

¹⁰ Smoke opacity measurements to be carried out according to provisions laid out in Regulation No. 24.

Annex 2 – Appendix 1

OBD – Related information

As noted in item 3.2.12.2.7.6. of the information document in Annex 1 to this Regulation, the information in this appendix is provided by the vehicle manufacturer for the purposes of enabling the manufacture of OBD-compatible replacement or service parts and diagnostic tools and test equipment.

Upon request, the following information shall be made available to any interested component, diagnostic tools or test equipment manufacturer, on a non-discriminatory basis.

1. A description of the type and number of the pre-conditioning cycles used for the original type approval of the vehicle.
2. A description of the type of the OBD demonstration cycle used for the original type approval of the vehicle for the component monitored by the OBD system.
3. A comprehensive document describing all sensed components with the strategy for fault detection and MI activation (fixed number of driving cycles or statistical method), including a list of relevant secondary sensed parameters for each component monitored by the OBD system and a list of all OBD output codes and format used (with an explanation of each) associated with individual emission related power-train components and individual non-emission related components, where monitoring of the component is used to determine MI activation. In particular, a comprehensive explanation for the data given in service \$05 Test ID \$21 to FF and the data given in service \$06 shall be provided. In the case of vehicle types that use a communication link in accordance with ISO 15765-4 'Road vehicles – Diagnostics on Controller Area Network (CAN) – Part 4: Requirements for emissions-related systems', a comprehensive explanation for the data given in service \$06 Test ID \$00 to FF, for each OBD monitor ID supported, shall be provided.

This information may be provided in the form of a table, as follows:

<i>Component</i>	<i>Fault code</i>	<i>Monitoring strategy</i>	<i>Fault detection criteria</i>	<i>MI activation criteria</i>	<i>Secondary parameters</i>	<i>Pre-conditioning</i>	<i>Demonstration test</i>
Catalyst	P0420	Oxygen sensor 1 and 2 signals	Difference between sensor 1 and sensor 2 signals	3 rd cycle	Engine speed, engine load, A/F mode, catalyst temperature	Two Type I cycles	Type I

Annex 2 - Appendix 2

Manufacturer's certificate of compliance with the OBD in-use performance requirements

(Manufacturer):

(Address of the manufacturer):

Certifies that:

1. The vehicle types listed in attachment to this Certificate are in compliance with the provisions of paragraph 7. of Appendix 1 to Annex 11 to this Regulation relating to the in-use performance of the OBD system under all reasonably foreseeable driving conditions;
2. The plan(s) describing the detailed technical criteria for incrementing the numerator and denominator of each monitor attached to this Certificate are correct and complete for all types of vehicles to which this Certificate applies.

Done at [.....Place]

On [.....Date]

[Signature of the Manufacturer's Representative]

Annexes:

- (a) List of vehicle types to which this Certificate applies;
- (b) Plan(s) describing the detailed technical criteria for incrementing the numerator and denominator of each monitor, as well as plan(s) for disabling numerators, denominators and general denominator.

Annex 3

Arrangements of the approval mark

In the approval mark issued and affixed to a vehicle in conformity with paragraph 4. of this Regulation, the type approval number shall be accompanied by an alphabetical character assigned according to Table A3/1 of this annex, reflecting the vehicle category and class that the approval is limited to.

This annex outlines the appearance of this mark, and gives an example how it shall be composed.

The following schematic graph presents the general lay-out, proportions and contents of the marking. The meaning of numbers and alphabetical character are identified, and sources to determine the corresponding alternatives for each approval case are also referred.

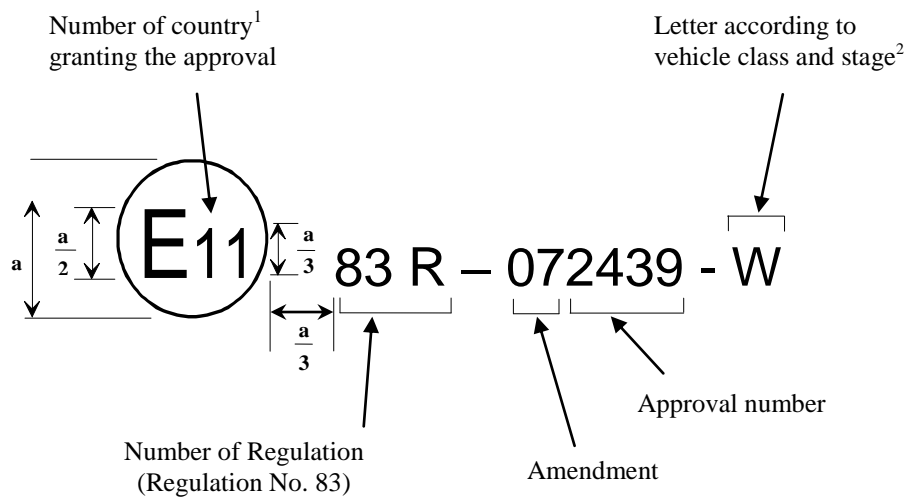

a = 8 mm (minimum)

The following graph is a practical example of how the marking should be composed.

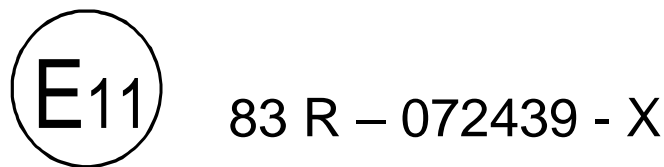

The preceding approval mark affixed to a vehicle in conformity with paragraph 4. of this Regulation shows that the vehicle type concerned has been approved in the United Kingdom (E 11), pursuant to Regulation No. 83 under approval number 2439. This mark indicates that the approval was given in accordance with the requirements of this

¹ Number of country according to footnote in paragraph 4.4.1. of this Regulation.

² According to Table A3/1 of this annex.

Regulation with the 07 series of amendments incorporated. Furthermore, the accompanying letter (X) denotes that the vehicle belongs to vehicle category N₁ class II that meets the emission and OBD standards listed in Table A3/1.

Table A3/1

Letters with reference to fuel, engine and vehicle category

<i>Character</i>	<i>Vehicle category and class</i>	<i>Engine type</i>	<i>Emission standard</i>	<i>OBD standard</i>
T	M, N ₁ class I.	CI	A	Interim OBD threshold limits (see Table A11/3)
U	N ₁ class II	CI	A	Interim OBD threshold limits (see Table A11/3)
V	N ₁ class III, N ₂	CI	A	Interim OBD threshold limits (see Table A11/3)
W	M, N ₁ class I.	PI CI	A	Preliminary OBD threshold limits (see Table A11/2)
X	N ₁ class II	PI CI	A	Preliminary OBD threshold limits (see Table A11/2)
Y	N ₁ class III, N ₂	PI CI	A	Preliminary OBD threshold limits (see Table A11/2)
ZA	M, N ₁ class I.	PI CI	B	Preliminary OBD threshold limits (see Table A11/2)
ZB	N ₁ class II	PI CI	B	Preliminary OBD threshold limits (see Table A11/2)
ZC	N ₁ class III, N ₂	PI CI	B	Preliminary OBD threshold limits (see Table A11/2)
ZD	M, N ₁ class I.	PI CI	B	Final OBD threshold limits (see Table A11/1)
ZE	N ₁ class II	PI CI	B	Final OBD threshold limits (see Table A11/1)

ZF	N ₁ class III, N ₂	PI CI	B	Final OBD threshold limits (see Table A11/1)
----	--	----------	---	---

Emissions standard key

- A Emission requirements according to the limits in Table 1 in paragraph 5.3.1.4. of this Regulation, but allowing the preliminary values for particle numbers for PI vehicles as detailed in Footnote 2 to that table;
- B Emission requirements according to the limits in Table 1 in paragraph 5.3.1.4. of this Regulation, including the final particle number standards for PI vehicles and use of E10 and B7 reference fuel (where applicable).

Annex 4a

Type I Test

(Verifying exhaust emissions after a cold start)

1. Applicability
This annex effectively replaces former Annex 4 to this Regulation.
2. Introduction
This annex describes the procedure for the Type I test defined in paragraph 5.3.1. of this Regulation. When the reference fuel to be used is LPG or NG/biomethane, the provisions of Annex 12 to this Regulation shall apply additionally.
3. Test conditions
 - 3.1. Ambient conditions
 - 3.1.1. During the test, the test cell temperature shall be between 293 K and 303 K (20 °C and 30 °C). The absolute humidity (H) of either the air in the test cell or the intake air of the engine shall be such that:
$$5.5 \leq H \leq 12.2 \quad (\text{g H}_2\text{O/kg dry air})$$

The absolute humidity (H) shall be measured.

The following temperatures shall be measured:

Test cell ambient air

Dilution and sampling system temperatures as required for emissions measurement systems defined in Appendices 2 to 5 to this annex.

The atmospheric pressure shall be measured.
 - 3.2. Test vehicle
 - 3.2.1. The vehicle shall be presented in good mechanical condition. It shall have been run-in and driven at least 3,000 km before the test.
 - 3.2.2. The exhaust device shall not exhibit any leak likely to reduce the quantity of gas collected, which quantity shall be that emerging from the engine.
 - 3.2.3. The tightness of the intake system may be checked to ensure that carburation is not affected by an accidental intake of air.
 - 3.2.4. The settings of the engine and of the vehicle's controls shall be those prescribed by the manufacturer. This requirement also applies, in particular, to the settings for idling (rotation speed and carbon monoxide content of the exhaust gases), for the cold start device and for the exhaust gas cleaning system.
 - 3.2.5. The vehicle to be tested, or an equivalent vehicle, shall be fitted, if necessary, with a device to permit the measurement of the characteristic parameters necessary for chassis dynamometer setting, in conformity with paragraph 5. of this annex.
 - 3.2.6. The Technical Service responsible for the tests may verify that the vehicle's performance conforms to that stated by the manufacturer, that it can be used

for normal driving and, more particularly, that it is capable of starting when cold and when hot.

- 3.2.7. The daytime running lamps of the vehicle as defined in paragraph 2 of Regulation No. 48 shall be switched on during the test cycle. The vehicle tested shall be equipped with the daytime running lamp system that has the highest electrical energy consumption among the daytime running lamp systems, which are fitted by the manufacturer to vehicles in the group represented by the type-approved vehicle. The manufacturer shall supply appropriate technical documentation to the type-approval authorities in this respect.
- 3.3. Test fuel
 - 3.3.1. The appropriate reference fuel as defined in Annex 10 or Annex 10a to this Regulation shall be used for testing.
 - 3.3.2. Vehicles that are fuelled either with petrol or with LPG or NG/biomethane, shall be tested according to Annex 12 to this Regulation with the appropriate reference fuel(s) as defined in Annex 10 or Annex 10a to this Regulation.
- 3.4. Vehicle installation
 - 3.4.1. The vehicle shall be approximately horizontal during the test so as to avoid any abnormal distribution of the fuel.
 - 3.4.2. A current of air of variable speed shall be blown over the vehicle. The blower speed shall be, within the operating range of 10 km/h to at least the maximum speed of the test cycle being used. The linear velocity of the air at the blower outlet shall be within ± 5 km/h of the corresponding roller speed within the range of 10 km/h to 50 km/h. At the range over 50 km/h, the linear velocity of the air shall be within ± 10 km/h of the corresponding roller speed. At roller speeds of less than 10 km/h, air velocity may be zero.

The above mentioned air velocity shall be determined as an averaged value of a number of measuring points which:

- (a) For blowers with rectangular outlets are located at the centre of each rectangle dividing the whole of the blower outlet into 9 areas (dividing both horizontal and vertical sides of the blower outlet into 3 equal parts). The centre area shall not be measured (as shown in the diagram below).

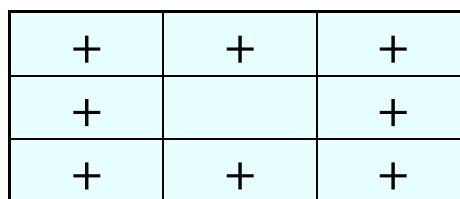

- (b) For circular blower outlets, the outlet shall be divided into 8 equal arcs by vertical, horizontal and 45° lines. The measurement points lie on the radial centre line of each arc (22.5°) at a radius of two thirds of the total (as shown in the diagram below).

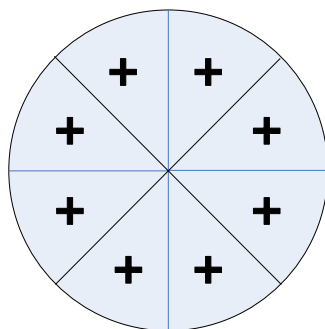

These measurements shall be made with no vehicle or other obstruction in front of the fan.

The device used to measure the linear velocity of the air shall be located at between 0 and 20 cm from the air outlet.

The final selection of the blower shall have the following characteristics:

- (a) Area: at least 0.2 m²;
- (b) Height of the lower edge above ground: approximately 0.2 m;
- (c) Distance from the front of the vehicle: approximately 0.3 m.

The height and lateral position of the cooling fan may be modified at the request of the manufacturer and if considered appropriate by the Type Approval authority.

In the cases described above, the cooling fan position and configuration shall be recorded in the approval test report and shall be used for conformity of production (COP) and in-service conformity (ISC) testing.

4. Test equipment

4.1. Chassis dynamometer

The chassis dynamometer requirements are given in Appendix 1 to this annex.

4.2. Exhaust dilution system

The exhaust dilution system requirements are given in Appendix 2 to this annex.

4.3. Gaseous emissions sampling and analysis

The gaseous emissions sampling and analysis equipment requirements are given in Appendix 3 to this annex.

4.4. Particulate Mass (PM) emissions equipment

The particulate mass sampling and measurement requirements are given in Appendix 4 to this annex.

4.5. Particle Number (PN) emissions equipment

The particle number sampling and measurement requirements are given in Appendix 5 to this annex.

4.6. General test cell equipment

The following temperatures shall be measured with an accuracy of ± 1.5 K:

- (a) Test cell ambient air;

- (b) Intake air to the engine;
- (c) Dilution and sampling system temperatures as required for emissions measurement systems defined in Appendices 2 to 5 to this annex.

The atmospheric pressure shall be measurable to within ± 0.1 kPa.

The absolute humidity (H) shall be measurable to within ± 5 per cent.

5. Determination of vehicle road load

5.1. Test procedure

The procedure for measuring the vehicle road load is described in Appendix 7 to this annex.

This procedure is not required if the chassis dynamometer load is to be set according to the reference mass of the vehicle.

6. Emissions test procedure

6.1. Test cycle

The operating cycle, made up of a Part One (urban cycle) and Part Two (extra-urban cycle), is illustrated in Figure A4a/1. During the complete test the elementary urban cycle is run four times followed, by Part Two.

6.1.1. Elementary urban cycle

Part One of the test cycle comprises 4 times the elementary urban cycle which is defined in Table A4a/1, illustrated in Figure A4a/2, and summarized below.

Breakdown by phases:

	<i>Time (s)</i>	<i>per cent</i>	
Idling	60	30.8	35.4
Deceleration, clutch disengaged	9	4.6	
Gear-changing	8	4.1	
Accelerations	36	18.5	
Steady-speed periods	57	29.2	
Decelerations	25	12.8	
Total	195	100	

Breakdown by use of gears:

	<i>Time (s)</i>	<i>per cent</i>	
Idling	60	30.8	35.4
Deceleration, clutch disengaged	9	4.6	
Gear-changing	8	4.1	
First gear	24	12.3	
Second gear	53	27.2	
Third gear	41	21	
Total	195	100	

General information:

Average speed during test:	19 km/h
Effective running time:	195 s
Theoretical distance covered per cycle:	1,013 km
Equivalent distance for the four cycles:	4,052 km

6.1.2. Extra-urban cycle

Part Two of the test cycle is the extra-urban cycle which is defined in Table A4a/2, illustrated in Figure A4a/3, and summarized below.

Breakdown by phases:

	<i>Time (s)</i>	<i>per cent</i>
Idling	20	5.0
Deceleration, clutch disengaged	20	5.0
Gear-shift	6	1.5
Accelerations	103	25.8
Steady-speed periods	209	52.2
Decelerations	42	10.5
Total	400	100

Breakdown by use of gears:

	<i>Time (s)</i>	<i>per cent</i>
Idling	20	5.0
Deceleration, clutch disengaged	20	5.0
Gear-shift	6	1.5
First gear	5	1.3
Second gear	9	2.2
Third gear	8	2
Fourth gear	99	24.8
Fifth gear	233	58.2
Total	400	100

General information:

Average speed during test:	62.6 km/h
Effective running time:	400 s
Theoretical distance covered per cycle:	6.955 km
Maximum speed:	120 km/h
Maximum acceleration:	0.833 m/s ²
Maximum deceleration:	-1.389 m/s ²

6.1.3. Use of the gearbox

6.1.3.1. If the maximum speed which can be attained in first gear is below 15 km/h, the second, third and fourth gears shall be used for the urban cycle (Part One) and the second, third, fourth and fifth gears for the extra-urban cycle (Part Two). The second, third and fourth gears may also be used for the urban cycle (Part One) and the second, third, fourth and fifth gears for the extra-urban cycle (Part Two) when the manufacturer's instructions recommend starting in second gear on level ground, or when first gear is therein defined as a gear reserved for cross-country driving, crawling or towing.

Vehicles which do not attain the acceleration and maximum speed values required in the operating cycle shall be operated with the accelerator control

fully depressed until they once again reach the required operating curve. Deviations from the operating cycle shall be recorded in the test report.

Vehicles equipped with semi-automatic-shift gearboxes shall be tested by using the gears normally employed for driving, and the gear shift is used in accordance with the manufacturer's instructions.

- 6.1.3.2. Vehicles equipped with automatic-shift gearboxes shall be tested with the highest gear ("Drive") engaged. The accelerator shall be used in such a way as to obtain the steadiest acceleration possible, enabling the various gears to be engaged in the normal order. Furthermore, the gear-change points shown in Tables A4a/1 and A4a/2 of this annex shall not apply; acceleration shall continue throughout the period represented by the straight line connecting the end of each period of idling with the beginning of the next following period of steady speed. The tolerances given in paragraphs 6.1.3.4. and 6.1.3.5. shall apply.
- 6.1.3.3. Vehicles equipped with an overdrive that the driver can actuate shall be tested with the overdrive out of action for the urban cycle (Part One) and with the overdrive in action for the extra-urban cycle (Part Two).
- 6.1.3.4. A tolerance of ± 2 km/h shall be allowed between the indicated speed and the theoretical speed during acceleration, during steady speed, and during deceleration when the vehicle's brakes are used. If the vehicle decelerates more rapidly without the use of the brakes, only the provisions of paragraph 6.4.4.3. shall apply. Speed tolerances greater than those prescribed shall be accepted during phase changes provided that the tolerances are never exceeded for more than 0.5 s on any one occasion.
- 6.1.3.5. The time tolerances shall be ± 1.0 s. The above tolerances shall apply equally at the beginning and at the end of each gear-changing period for the urban cycle (Part One) and for the operations Nos. 3, 5 and 7 of the extra-urban cycle (Part Two). It should be noted that the time of two seconds allowed includes the time for changing gear and, if necessary, a certain amount of latitude to catch up with the cycle.
- 6.2. Test preparation
- 6.2.1. Load and inertia setting
- 6.2.1.1. Load determined with vehicle road test
- The dynamometer shall be adjusted so that the total inertia of the rotating masses will simulate the inertia and other road load forces acting on the vehicle when driving on the road. The means by which this load is determined is described in paragraph 5. of this annex.
- Dynamometer with fixed load curve: the load simulator shall be adjusted to absorb the power exerted on the driving wheels at a steady speed of 80 km/h and the absorbed power at 50 km/h shall be noted.
- Dynamometer with adjustable load curve: the load simulator shall be adjusted in order to absorb the power exerted on the driving wheels at steady speeds of 120, 100, 80, 60 and 40 and 20 km/h.
- 6.2.1.2. Load determined by vehicle reference mass
- With the manufacturer's agreement the following method may be used.
- The brake is adjusted so as to absorb the load exerted at the driving wheels at a constant speed of 80 km/h, in accordance with Table A4a/3.

If the corresponding equivalent inertia is not available on the dynamometer, the larger value closest to the vehicle reference mass will be used.

In the case of vehicles other than passenger cars, with a reference mass of more than 1,700 kg or vehicles with permanent all-wheel drive, the power values given in Table A4a/3 are multiplied by a factor 1.3.

6.2.1.3. The method used and the values obtained (equivalent inertia - characteristic adjustment parameter) shall be recorded in the test report.

6.2.2. Preliminary testing cycles

Preliminary testing cycles should be carried out if necessary to determine how best to actuate the accelerator and brake controls so as to achieve a cycle approximating to the theoretical cycle within the prescribed limits under which the cycle is carried out.

6.2.3. Tyre pressures

The tyre pressures shall be the same as that specified by the manufacturer and used for the preliminary road test for brake adjustment. The tyre pressure may be increased by up to 50 per cent from the manufacturer's recommended setting in the case of a two-roller dynamometer. The actual pressure used shall be recorded in the test report.

6.2.4. Background particulate mass measurement

The particulate background level of the dilution air may be determined by passing filtered dilution air through the particulate filter. This shall be drawn from the same point as the particulate sample. One measurement may be performed prior to or after the test. Particulate mass measurements may be corrected by subtracting the background contribution from the dilution system. The permissible background contribution shall be $\leq 1\text{mg/km}$ (or equivalent mass on the filter). If the background exceeds this level, the default figure of 1mg/km (or equivalent mass on the filter) shall be employed. Where subtraction of the background contribution gives a negative result, the particulate mass result shall be considered to be zero.

6.2.5. Background particle number measurements

The subtraction of background particle numbers may be determined by sampling dilution air drawn from a point downstream of the particle and hydrocarbon filters into the particle number measurement system. Background correction of particle number measurements shall not be allowed for type approval, but may be used at the manufacturer's request for conformity of production and in service conformity where there are indications that tunnel contribution is significant.

6.2.6. Particulate mass filter selection

A single particulate filter without back-up shall be employed for both urban and extra-urban phases of the cycle combined.

Twin particulate filters, one for the urban, one for the extra-urban phase, may be used without back-up filters, only where the pressure-drop increase across the sample filter between the beginning and the end of the emissions test is otherwise expected to exceed 25 kPa.

6.2.7. Particulate mass filter preparation

6.2.7.1. Particulate mass sampling filters shall be conditioned (as regards temperature and humidity) in an open dish that has been protected against dust ingress for at least 2 and for not more than 80 hours before the test in an air-conditioned

chamber. After this conditioning, the uncontaminated filters will be weighed and stored until they are used. If the filters are not used within one hour of their removal from the weighing chamber they shall be re-weighed.

6.2.7.2. The one hour limit may be replaced by an eight-hour limit if one or both of the following conditions are met:

6.2.7.2.1. A stabilized filter is placed and kept in a sealed filter holder assembly with the ends plugged; or

6.2.7.2.2. A stabilized filter is placed in a sealed filter holder assembly which is then immediately placed in a sample line through which there is no flow.

6.2.7.3. The particulate sampling system shall be started and prepared for sampling.

6.2.8. Particle number measurement preparation

6.2.8.1. The particle specific dilution system and measurement equipment shall be started and readied for sampling.

6.2.8.2. Prior to the test(s) the correct function of the particle counter and volatile particle remover elements of the particle sampling system shall be confirmed according to paragraphs 2.3.1. and 2.3.3. of Appendix 5 to this annex.

The particle counter response shall be tested at near zero prior to each test and, on a daily basis, at high particle concentrations using ambient air.

When the inlet is equipped with a HEPA filter, it shall be demonstrated that the entire particle sampling system is free from any leaks.

6.2.9. Checking the gas analysers

The emissions analysers for the gases shall be set at zero and spanned. The sample bags shall be evacuated.

6.3. Conditioning procedure

6.3.1. For the purpose of measuring particulates, at most 36 hours and at least 6 hours before testing, the Part Two cycle described in paragraph 6.1. of this annex shall be used for vehicle pre-conditioning. Three consecutive cycles shall be driven. The dynamometer setting shall be indicated as in paragraph 6.2.1. of this annex.

At the request of the manufacturer, vehicles fitted with indirect injection positive-ignition engines may be preconditioned with one Part One and two Part Two driving cycles.

In a test facility in which there may be possible contamination of a low particulate emitting vehicle test with residue from a previous test on a high particulate emitting vehicle, it is recommended, for the purpose of sampling equipment pre-conditioning, that a 120 km/h steady state drive cycle of 20 minutes duration followed by three consecutive Part Two cycles be driven by a low particulate emitting vehicle.

After this preconditioning, and before testing, vehicles shall be kept in a room in which the temperature remains relatively constant between 293 and 303 K (20 °C and 30 °C). This conditioning shall be carried out for at least six hours and continue until the engine oil temperature and coolant, if any, are within ± 2 K of the temperature of the room.

If the manufacturer so requests, the test shall be carried out not later than 30 hours after the vehicle has been run at its normal temperature.

- 6.3.3. For positive-ignition engined vehicles fuelled with LPG or NG/biomethane or so equipped that they can be fuelled with either petrol or LPG or NG/biomethane, between the tests on the first gaseous reference fuel and the second gaseous reference fuel, the vehicle shall be preconditioned before the test on the second reference fuel. This preconditioning is done on the second reference fuel by driving a preconditioning cycle consisting of one Part One (urban part) and two times Part Two (extra-urban part) of the test cycle described in paragraph 6.1. of this annex. On the manufacturer's request and with the agreement of the technical service this preconditioning may be extended. The dynamometer setting shall be the one indicated in paragraph 6.2. of this annex.
- 6.4. Test procedure
- 6.4.1. Starting-up the engine
- 6.4.1.1. The engine shall be started up by means of the devices provided for this purpose according to the manufacturer's instructions, as incorporated in the drivers' handbook of production vehicles.
- 6.4.1.2. The first cycle starts on the initiation of the engine start-up procedure.
- 6.4.1.3. In cases where LPG or NG/biomethane is used as a fuel it is permissible that the engine is started on petrol and switched to LPG or NG/biomethane after a predetermined period of time which cannot be changed by the driver. This period of time shall not exceed 60 seconds.
- 6.4.2. Idling
- 6.4.2.1. Manual-shift or semi-automatic gearbox, see Tables A4a/1 and A4a/2.
- 6.4.2.2. Automatic-shift gearbox
- After initial engagement the selector shall not be operated at any time during the test except in the case specified in paragraph 6.4.3.3. of this annex or if the selector can actuate the overdrive, if any.
- 6.4.3. Accelerations
- 6.4.3.1. Accelerations shall be so performed that the rate of acceleration is as constant as possible throughout the operation.
- 6.4.3.2. If an acceleration cannot be carried out in the prescribed time, the extra time required shall be deducted from the time allowed for changing gear, if possible, but otherwise from the subsequent steady-speed period.
- 6.4.3.3. Automatic-shift gearboxes
- If acceleration cannot be carried out in the prescribed time, the gear selector shall operate in accordance with requirements for manual-shift gearboxes.
- 6.4.4. Decelerations
- 6.4.4.1. All decelerations of the elementary urban cycle (Part One) shall be effected by removing the foot completely from the accelerator with the clutch remaining engaged. The clutch shall be disengaged, without use of the gear lever, at the higher of the following speeds: 10 km/h or the speed corresponding to the engine idle speed.
- All decelerations of the extra-urban cycle (Part Two) shall be effected by removing the foot completely from the accelerator, the clutch remaining engaged. The clutch shall be disengaged, without use of the gear lever, at a speed of 50 km/h for the last deceleration.

-
- 6.4.4.2. If the period of deceleration is longer than that prescribed for the corresponding phase, the vehicle's brakes shall be used to enable compliance with the timing of the cycle.
- 6.4.4.3. If the period of deceleration is shorter than that prescribed for the corresponding phase, the timing of the theoretical cycle shall be restored by constant speed or an idling period merging into the following operation.
- 6.4.4.4. At the end of the deceleration period (halt of the vehicle on the rollers) of the elementary urban cycle (Part One), the gears shall be placed in neutral and the clutch engaged.
- 6.4.5. Steady speeds
- 6.4.5.1. "Pumping" or the closing of the throttle shall be avoided when passing from acceleration to the following steady speed.
- 6.4.5.2. Periods of constant speed shall be achieved by keeping the accelerator position fixed.
- 6.4.6. Sampling
- Sampling shall begin (BS) before or at the initiation of the engine start up procedure and end on conclusion of the final idling period in the extra-urban cycle (Part Two, end of sampling (ES)) or, in the case of the Type VI test, on conclusion of the final idling period of the last elementary urban cycle (Part One).
- 6.4.7. During the test the speed is recorded against time or collected by the data-acquisition system so that the correctness of the cycles performed can be assessed.
- 6.4.8. Particles shall be measured continuously in the particle sampling system. The average concentrations shall be determined by integrating the analyser signals over the test cycle.
- 6.5. Post-test procedures
- 6.5.1. Gas analyser check
- Zero and span gas reading of the analysers used for continuous measurement shall be checked. The test shall be considered acceptable if the difference between the pre-test and post-test results is less than 2 per cent of the span gas value.
- 6.5.2. Particulate filter weighing
- Reference filters shall be weighed within 8 hours of the test filter weighing. The contaminated particulate test filter shall be taken to the weighing chamber within one hour following the analyses of the exhaust gases. The test filter shall be conditioned for at least 2 hours and not more than 80 hours and then weighed.
- 6.5.3. Bag analysis
- 6.5.3.1. The exhaust gases contained in the bag shall be analysed as soon as possible and in any event not later than 20 minutes after the end of the test cycle.
- 6.5.3.2. Prior to each sample analysis, the analyser range to be used for each pollutant shall be set to zero with the appropriate zero gas.
- 6.5.3.3. The analysers shall then be set to the calibration curves by means of span gases of nominal concentrations of 70 to 100 per cent of the range.

- 6.5.3.4. The analysers' zero settings shall then be rechecked: if any reading differs by more than 2 per cent of the range from that set in paragraph 6.5.3.2. of this annex, the procedure shall be repeated for that analyser.
- 6.5.3.5. The samples shall then be analysed.
- 6.5.3.6. After the analysis, zero and span points shall be rechecked using the same gases. If these rechecks are within ± 2 per cent of those in paragraph 6.5.3.3. of this annex, the analysis shall be considered acceptable.
- 6.5.3.7. At all points in this paragraph, the flow-rates and pressures of the various gases shall be the same as those used during calibration of the analysers.
- 6.5.3.8. The figure adopted for the content of the gases in each of the pollutants measured shall be that read off after stabilisation of the measuring device. Hydrocarbon mass emissions of compression-ignition engines shall be calculated from the integrated HFID reading, corrected for varying flow if necessary, as shown in paragraph 6.6.6. of this annex.

6.6. Calculation of emissions

6.6.1. Determination of volume

- 6.6.1.1. Calculation of the volume when a variable dilution device with constant flow control by orifice or venturi is used.

Record continuously the parameters showing the volumetric flow, and calculate the total volume for the duration of the test.

- 6.6.1.2. Calculation of volume when a positive displacement pump is used

The volume of diluted exhaust gas measured in systems comprising a positive displacement pump is calculated with the following formula:

$$V = V_o \cdot N$$

Where:

V = volume of the diluted gas expressed in litres per test (prior to correction),

V_o = volume of gas delivered by the positive displacement pump in testing conditions in litres per revolution,

N = number of revolutions per test.

- 6.6.1.3. Correction of Volume to Standard Conditions

The diluted exhaust-gas volume is corrected by means of the following formula:

$$V_{\text{mix}} = V \cdot K_1 \cdot \left(\frac{P_B - P_1}{T_p} \right) \quad (1)$$

Where:

$$K_1 = \frac{273.2 \text{ (K)}}{101.33 \text{ (kPa)}} = 2.6961 \quad (2)$$

P_B = barometric pressure in the test room in kPa,

P_1 = vacuum at the inlet to the positive displacement pump in kPa relative to the ambient barometric pressure,

T_p = average temperature of the diluted exhaust gas entering the positive displacement pump during the test (K).

6.6.2. Total mass of gaseous and particulate pollutants emitted

The mass M of each pollutant emitted by the vehicle during the test shall be determined by obtaining the product of the volumetric concentration and the volume of the gas in question, with due regard for the following densities under above-mentioned reference conditions:

In the case of carbon monoxide (CO): $d = 1.25 \text{ g/l}$

In the case of hydrocarbons:

For petrol (E5) ($C_1H_{1.89}O_{0.016}$) $d = 0.631 \text{ g/l}$

For petrol (E10) ($C_1H_{1.93}O_{0.033}$) $d = 0.645 \text{ g/l}$

For diesel (B5) ($C_1H_{1.86}O_{0.005}$) $d = 0.622 \text{ g/l}$

For diesel (B7) ($C_1H_{1.86}O_{0.007}$) $d = 0.623 \text{ g/l}$

For LPG ($CH_{2.525}$) $d = 0.649 \text{ g/l}$

For LPG ($CH_{2.525}$) $d = 0.649 \text{ g/l}$

For NG/biomethane (C_1H_4) $d = 0.714 \text{ g/l}$

For ethanol (E85) ($C_1H_{2.74}O_{0.385}$) $d = 0.932 \text{ g/l}$

For ethanol (E75) ($C_1H_{2.61}O_{0.329}$) $d = 0.886 \text{ g/l}$

In the case of nitrogen oxides (NO_x): $d = 2.05 \text{ g/l}$

6.6.3. Mass emissions of gaseous pollutants shall be calculated by means of the following formula:

$$M_i = \frac{V_{\text{mix}} \cdot Q_i \cdot k_h \cdot C_i \cdot 10^{-6}}{d} \quad (3)$$

Where:

M_i = mass emission of the pollutant i in grams per kilometre,

V_{mix} = volume of the diluted exhaust gas expressed in litres per test and corrected to standard conditions (273.2 K and 101.33 kPa),

Q_i = density of the pollutant i in grams per litre at normal temperature and pressure (273.2 K and 101.33 kPa),

k_h = humidity correction factor used for the calculation of the mass emissions of oxides of nitrogen. There is no humidity correction for HC and CO,

C_i = concentration of the pollutant i in the diluted exhaust gas expressed in ppm and corrected by the amount of the pollutant i contained in the dilution air,

d = distance corresponding to the operating cycle in kilometres.

6.6.4. Correction for dilution air concentration

The concentration of pollutant in the diluted exhaust gas shall be corrected by the amount of the pollutant in the dilution air as follows:

$$C_i = C_e - C_d \cdot \left(1 - \frac{1}{DF}\right) \quad (4)$$

Where:

C_i = concentration of the pollutant i in the diluted exhaust gas, expressed in ppm and corrected by the amount of i contained in the dilution air,

C_e = measured concentration of pollutant i in the diluted exhaust gas, expressed in ppm,

C_d = concentration of pollutant i in the air used for dilution, expressed in ppm,

DF = dilution factor.

The dilution factor is calculated as follows:

For each reference fuel, except hydrogen

$$DF = \frac{X}{C_{CO_2} + (C_{HC} + C_{CO}) \cdot 10^{-4}}$$

For a fuel of composition $C_xH_yO_z$, the general formula is:

$$X = 100 \frac{x}{x + \frac{y}{2} + 3.76 \cdot \left(x + \frac{y}{4} - \frac{z}{2}\right)}$$

The dilution factors for the reference fuels covered by this Regulation are provided below:

$$DF = \frac{13.4}{C_{CO_2} + (C_{HC} + C_{CO}) \cdot 10^{-4}} \quad \text{for petrol (E5)} \quad (5a)$$

$$DF = \frac{13.4}{C_{CO_2} + (C_{HC} + C_{CO}) \cdot 10^{-4}} \quad \text{for petrol (E10)} \quad (5b)$$

$$DF = \frac{13.5}{C_{CO_2} + (C_{HC} + C_{CO}) \cdot 10^{-4}} \quad \text{for diesel (B5)} \quad (5c)$$

$$DF = \frac{13.5}{C_{CO_2} + (C_{HC} + C_{CO}) \cdot 10^{-4}} \quad \text{for diesel (B7)} \quad (5d)$$

$$DF = \frac{11.9}{C_{CO_2} + (C_{HC} + C_{CO}) \cdot 10^{-4}} \quad \text{for LPG} \quad (5e)$$

$$DF = \frac{9.5}{C_{CO_2} + (C_{HC} + C_{CO}) \cdot 10^{-4}} \quad \text{for NG/biomethane} \quad (5f)$$

$$DF = \frac{12.5}{C_{CO_2} + (C_{HC} + C_{CO}) \cdot 10^{-4}} \quad \text{for ethanol (E85)} \quad (5g)$$

$$DF = \frac{12.7}{C_{CO_2} + (C_{HC} + C_{CO}) \cdot 10^{-4}} \quad \text{for ethanol (E75)} \quad (5h)$$

$$DF = \frac{35.03}{C_{H_2O} - C_{H_2O-DA} + C_{H_2} \cdot 10^{-4}} \quad \text{for hydrogen} \quad (5i)$$

In these equations:

C_{CO_2} = concentration of CO_2 in the diluted exhaust gas contained in the sampling bag, expressed in per cent volume,

C_{HC} = concentration of HC in the diluted exhaust gas contained in the sampling bag, expressed in ppm carbon equivalent,

C_{CO} = concentration of CO in the diluted exhaust gas contained in the sampling bag, expressed in ppm,

C_{H_2O} = concentration of H_2O in the diluted exhaust gas contained in the sampling bag, expressed in per cent volume,

C_{H_2O-DA} = concentration of H_2O in the air used for dilution, expressed in per cent volume,

C_{H_2} = concentration of hydrogen in the diluted exhaust gas contained in the sampling bag, expressed in ppm,

Non-methane hydrocarbon concentration is calculated as follows:

$$C_{NMHC} = C_{THC} - (Rf_{CH_4} \cdot C_{CH_4})$$

Where:

C_{NMHC} = corrected concentration of NMHC in the diluted exhaust gas, expressed in ppm carbon equivalent,

C_{THC} = concentration of THC in the diluted exhaust gas, expressed in ppm carbon equivalent and corrected by the amount of THC contained in the dilution air,

C_{CH_4} = concentration of CH_4 in the diluted exhaust gas, expressed in ppm carbon equivalent and corrected by the amount of CH_4 contained in the dilution air,

Rf_{CH_4} = is the FID response factor to methane as defined in paragraph 2.3.3. of Appendix 3 to this annex.

6.6.5. Calculation of the NO humidity correction factor

In order to correct the influence of humidity on the results of oxides of nitrogen, the following calculations are applied:

$$k_h = \frac{1}{1 - 0.0329 \cdot (H - 10.71)} \quad (6)$$

in which:

$$H = \frac{6.211 \cdot R_a \cdot P_d}{P_B - P_d \cdot R_a \cdot 10^{-2}}$$

Where:

H = absolute humidity expressed in grams of water per kilogram of dry air,

R_a = relative humidity of the ambient air expressed as a percentage,

P_d = saturation vapour pressure at ambient temperature expressed in kPa,

P_B = atmospheric pressure in the room, expressed in kPa.

6.6.6. Determination of HC for compression-ignition engines

To calculate HC-mass emission for compression-ignition engines, the average HC concentration is calculated as follows:

$$C_e = \frac{\int_{t_1}^{t_2} C_{HC} \cdot dt}{t_2 - t_1} \quad (7)$$

Where:

$\int_{t_1}^{t_2} C_{HC} \cdot dt$ = integral of the recording of the heated FID over the test (t₂-t₁)

C_e = concentration of HC measured in the diluted exhaust in ppm of C_i is substituted for C_{HC} in all relevant equations.

6.6.7. Determination of particulates

Particulate emission M_p (g/km) is calculated by means of the following equation:

$$M_p = \frac{(V_{mix} + V_{ep}) \cdot P_e}{V_{ep} \cdot d}$$

Where exhaust gases are vented outside tunnel;

$$M_p = \frac{V_{mix} \cdot P_e}{V_{ep} \cdot d}$$

Where exhaust gases are returned to the tunnel;

Where:

V_{mix} = volume of diluted exhaust gases (see paragraph 6.6.1. of this annex), under standard conditions,

V_{ep} = volume of exhaust gas flowing through particulate filter under standard conditions,

- P_e = particulate mass collected by filter(s),
 d = distance corresponding to the operating cycle in km,
 M_p = particulate emission in g/km.

Where correction for the particulate background level from the dilution system has been used, this shall be determined in accordance with paragraph 6.2.4. of this annex. In this case, the particulate mass (g/km) shall be calculated as follows:

$$M_p = \left[\frac{P_e}{V_{ep}} - \left(\frac{P_a}{V_{ap}} \cdot \left(1 - \frac{1}{DF} \right) \right) \right] \cdot \frac{(V_{mix} + V_{ep})}{d}$$

Where exhaust gases are vented outside tunnel;

$$M_p = \left[\frac{P_e}{V_{ep}} - \left(\frac{P_a}{V_{ap}} \cdot \left(1 - \frac{1}{DF} \right) \right) \right] \cdot \frac{V_{mix}}{d}$$

Where exhaust gases are returned to the tunnel.

Where:

- V_{ap} = volume of tunnel air flowing through the background particulate filter under standard conditions,
 P_a = particulate mass collected by background filter,
 DF = dilution factor as determined in paragraph 6.6.4. of this annex.

Where application of a background correction results in a negative particulate mass (in g/km) the result shall be considered to be zero g/km particulate mass.

6.6.8. Determination of particle numbers

Number emission of particles shall be calculated by means of the following equation:

$$N = \frac{V \cdot k \cdot \bar{C}_s \cdot \bar{f}_r \cdot 10^3}{d}$$

Where:

- N = particle number emission expressed in particles per kilometre,
 V = volume of the diluted exhaust gas expressed in litres per test and corrected to standard conditions (273.2 K and 101.33 kPa),
 K = calibration factor to correct the particle number counter measurements to the level of the reference instrument where this is not applied internally within the particle number counter. Where the calibration factor is applied internally within the particle number counter a value of 1 shall be used for k in the above equation,
 \bar{C}_s = corrected concentration of particles from the diluted exhaust gas expressed as the average particles per cubic centimetre

figure from the emissions test including the full duration of the drive cycle. If the volumetric mean concentration results (\bar{C}) from the particle number counter are not output at standard conditions (273.2 K and 101.33 kPa), then the concentrations should be corrected to those conditions (\bar{C}_s),

\bar{f}_r = mean particle concentration reduction factor of the volatile particle remover at the dilution setting used for the test,

d = distance corresponding to the operating cycle expressed in kilometres,

\bar{C} = shall be calculated from the following equation:

$$\bar{C} = \frac{\sum_{i=1}^{i=n} C_i}{n}$$

Where:

C_i = a discrete measurement of particle concentration in the diluted gas exhaust from the particle counter expressed in particles per cubic centimetre and corrected for coincidence,

n = total number of discrete particle concentration measurements made during the operating cycle,

n shall be calculated from the following equation:

$$n = T \cdot f$$

Where:

T = time duration of the operating cycle expressed in seconds,

f = data logging frequency of the particle counter expressed in Hz.

6.6.9. Allowance for mass emissions from vehicles equipped with periodically regenerating devices

When the vehicle is equipped with a periodically regenerating system as defined in Annex 13 to this Regulation:

6.6.9.1. The provisions of Annex 13 to this Regulation shall apply for the purposes of particulate mass measurements only and not particle number measurements.

6.6.9.2. For particulate mass sampling during a test in which the vehicle undergoes a scheduled regeneration, the filter face temperature shall not exceed 192 °C.

6.6.9.3. For particulate mass sampling during a test when the regenerating device is in a stabilized loading condition (i.e. the vehicle is not undergoing a regeneration), it is recommended that the vehicle has completed > 1/3 of the mileage between scheduled regenerations or that the periodically regenerating device has undergone equivalent loading off the vehicle.

For the purposes of Conformity of Production testing, the manufacturer may ensure that this is included within the evolution coefficient. In this case,

paragraph 8.2.3.2. of this Regulation is replaced by paragraph 6.6.9.3.1. of this annex.

6.6.9.3.1. If the manufacturer wishes to run in the vehicles, ("x" km, where $x \leq 3,000$ km for vehicles equipped with a positive ignition engine and $x \leq 15,000$ km for vehicles equipped with a compression ignition engine and where the vehicle is at $> 1/3$ distance between successive regenerations), the procedure will be as follows:

- (a) The pollutant emissions (type I) will be measured at zero and at "x" km on the first tested vehicle;
- (b) The evolution coefficient of the emissions between zero and "x" km will be calculated for each of the pollutants:

$$\text{Evolution coefficient } t = \frac{\text{Emissions at "x" km}}{\text{Emissions at zero km}}$$

This may be less than 1,

- (a) The other vehicles will not be run in, but their zero km emissions will be multiplied by the evolution coefficient.

In this case, the values to be taken will be:

- (a) The values at "x" km for the first vehicle;
- (b) The values at zero km multiplied by the evolution coefficient for the other vehicles.

Table A4a/1
Elementary urban operating cycle on the chassis dynamometer (Part One)

	Operation	Phase	Acceleration (m/s ²)	Speed (km/h)	Duration of each		Cumulative time (s)	Gear to be used in the case of a manual gearbox
					Operation (s)	Phase (s)		
1	Idling	1	0	0	11	11	11	6 s PM + 5 s K ₁ ¹
2	Acceleration	2	1.04	0-15	4	4	15	1
3	Steady speed	3	0	15	9	8	23	1
4	Deceleration	4	-0.69	15-10	2	5	25	1
	Deceleration, clutch disengaged		-0.92	10-0	3		28	K ₁ ¹
6	Idling	5	0	0	21	21	49	16 s PM + 5 s K ₁ ¹
7	Acceleration	6	0.83	0-15	5	12	54	1
8	Gear change			15	2		56	
9	Acceleration		0.94	15-32	5		61	2
10	Steady speed	7	0	32	24	24	85	2
11	Deceleration	8	-0.75	32-10	8	11	93	2
12	Deceleration, clutch disengaged		-0.92	10-0	3		96	K ₂ ¹
13	Idling	9	0	0	21		117	16 s PM + 5 s K ₁ ¹
14	Acceleration	10	0.83	0-15	5	26	122	1
15	Gear change			15	2		124	
16	Acceleration		0.62	15-35	9		133	2
17	Gear change			35	2		135	
18	Acceleration		0.52	35-50	8		143	3
19	Steady speed	11	0	50	12	12	155	3
20	Deceleration	12	-0.52	50-35	8	8	163	3
21	Steady speed	13	0	35	13	13	176	3
22	Gear change	14		35	2	12	178	
23	Deceleration		-0.99	35-10	7		185	2
24	Deceleration clutch disengaged		-0.92	10-0	3		188	K ₂ ¹
25	Idling	15	0	0	7	7	195	7 s PM ¹

¹ PM = gearbox in neutral, clutch engaged. K₁, K₂ = first or second gear engaged, clutch disengaged.

Table A4a/2

Extra-urban cycle (Part Two) for the Type I test

No. of operation	Operation	Phase	Acceleration (m/s ²)	Speed (km/h)	Duration of each		Cumulative time(s)	Gear to be used in the case of a manual gearbox	
					Operation(s)	Phase(s)			
1	Idling	1	0	0	20	20	20	K ₁ ¹	
2	Acceleration	2	0.83	0-15	5	41	25	1	
3	Gear change				15		2	27	-
4	Acceleration		0.62	15-35	9		36	2	
5	Gear change				35		2	38	-
6	Acceleration		0.52	35-50	8		46	3	
7	Gear change				50		2	48	-
8	Acceleration		0.43	50-70	13		61	4	
9	Steady speed		3	0	70		50	50	111
10	Deceleration	4	-0.69	70-50	8	8	119	4 s.5 + 4 s.4	
11	Steady speed	5	0	50	69	69	188	4	
12	Acceleration	6	0.43	50-70	13	13	201	4	
13	Steady speed	7	0	70	50	50	251	5	
14	Acceleration	8	0.24	70-100	35	35	286	5	
15	Steady speed ²	9	0	100	30	30	316	5 ²	
16	Acceleration ²	10	0.28	100-120	20	20	336	5 ²	
17	Steady speed ²	11	0	120	10	20	346	5 ²	
18	Deceleration ²	12	-0.69	120-80	16	34	362	5 ²	
19	Deceleration ²		-1.04	80-50	8		370	5 ²	
20	Deceleration, clutch disengaged		1.39	50-0	10		380	K ₅ ¹	
21	Idle	13	0	0	20	20	400	PM ¹	

¹ PM = gearbox in neutral, clutch engaged. K₁, K₅ = first or second gear engaged, clutch disengaged

² Additional gears can be used according to manufacturer recommendations if the vehicle is equipped with a transmission with more than five gears.

Table A4a/3

Simulated inertia and dyno loading requirements

Reference mass of vehicle RW (kg)	Equivalent inertia	Power and load absorbed by the dynamometer at 80 km/h		Road Load Coefficients	
		kg	kW	N	a (N)
RW ≤ 480	455	3.8	171	3.8	0.0261
480 < RW ≤ 540	510	4.1	185	4.2	0.0282
540 < RW ≤ 595	570	4.3	194	4.4	0.0296
595 < RW ≤ 650	625	4.5	203	4.6	0.0309
650 < RW ≤ 710	680	4.7	212	4.8	0.0323
710 < RW ≤ 765	740	4.9	221	5.0	0.0337
765 < RW ≤ 850	800	5.1	230	5.2	0.0351
850 < RW ≤ 965	910	5.6	252	5.7	0.0385
965 < RW ≤ 1080	1020	6.0	270	6.1	0.0412
1080 < RW ≤ 1190	1130	6.3	284	6.4	0.0433
1190 < RW ≤ 1305	1250	6.7	302	6.8	0.0460
1305 < RW ≤ 1420	1360	7.0	315	7.1	0.0481
1420 < RW ≤ 1530	1470	7.3	329	7.4	0.0502
1530 < RW ≤ 1640	1590	7.5	338	7.6	0.0515
1640 < RW ≤ 1760	1700	7.8	351	7.9	0.0536
1760 < RW ≤ 1870	1810	8.1	365	8.2	0.0557
1870 < RW ≤ 1980	1930	8.4	378	8.5	0.0577
1980 < RW ≤ 2100	2040	8.6	387	8.7	0.0591
2100 < RW ≤ 2210	2150	8.8	396	8.9	0.0605
2210 < RW ≤ 2380	2270	9.0	405	9.1	0.0619
2380 < RW ≤ 2610	2270	9.4	423	9.5	0.0646
2610 < RW	2270	9.8	441	9.9	0.0674

Figure A4a/1
Operating cycle for the Type I test

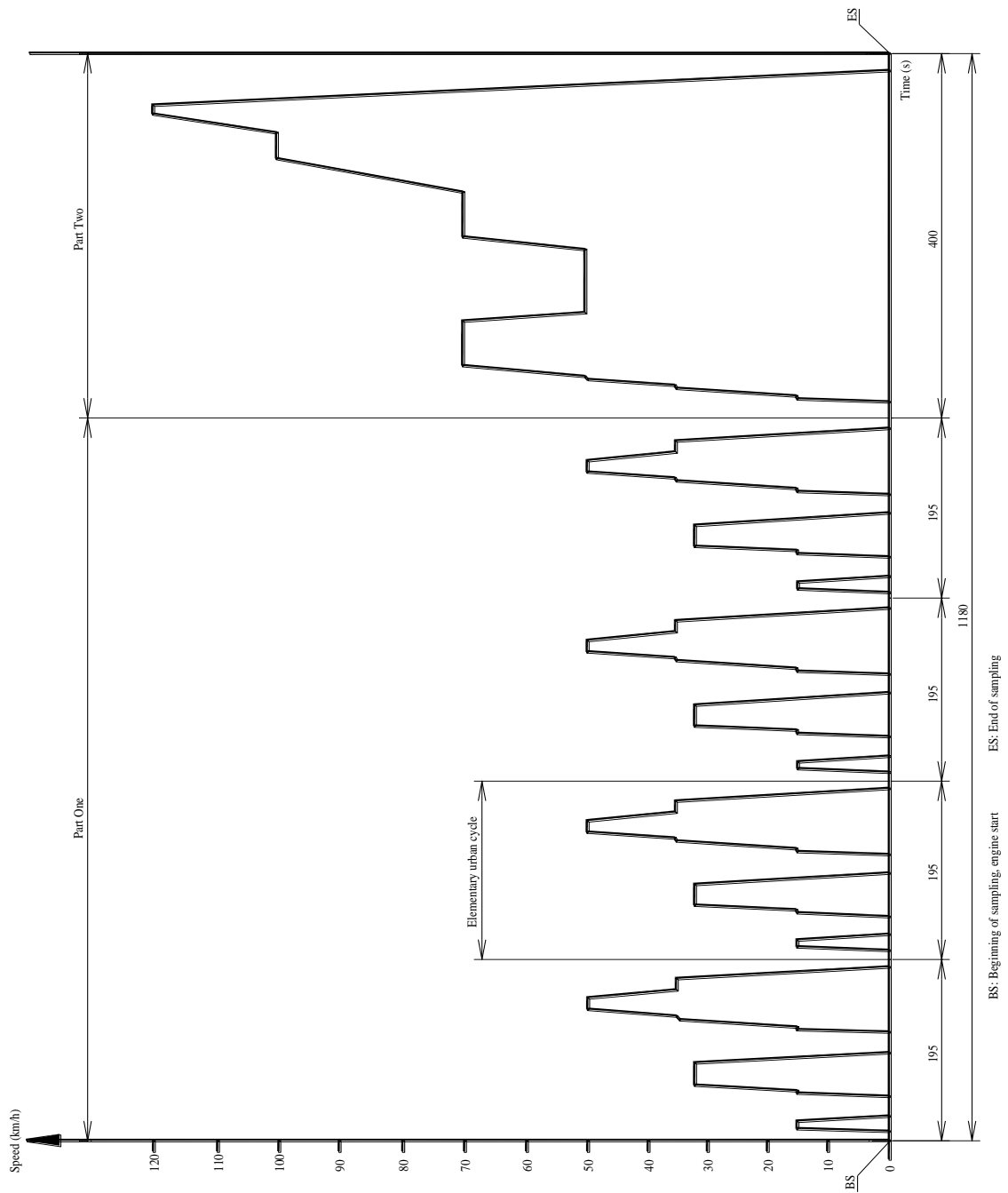

Figure A4a/2
Elementary urban cycle for the Type I test

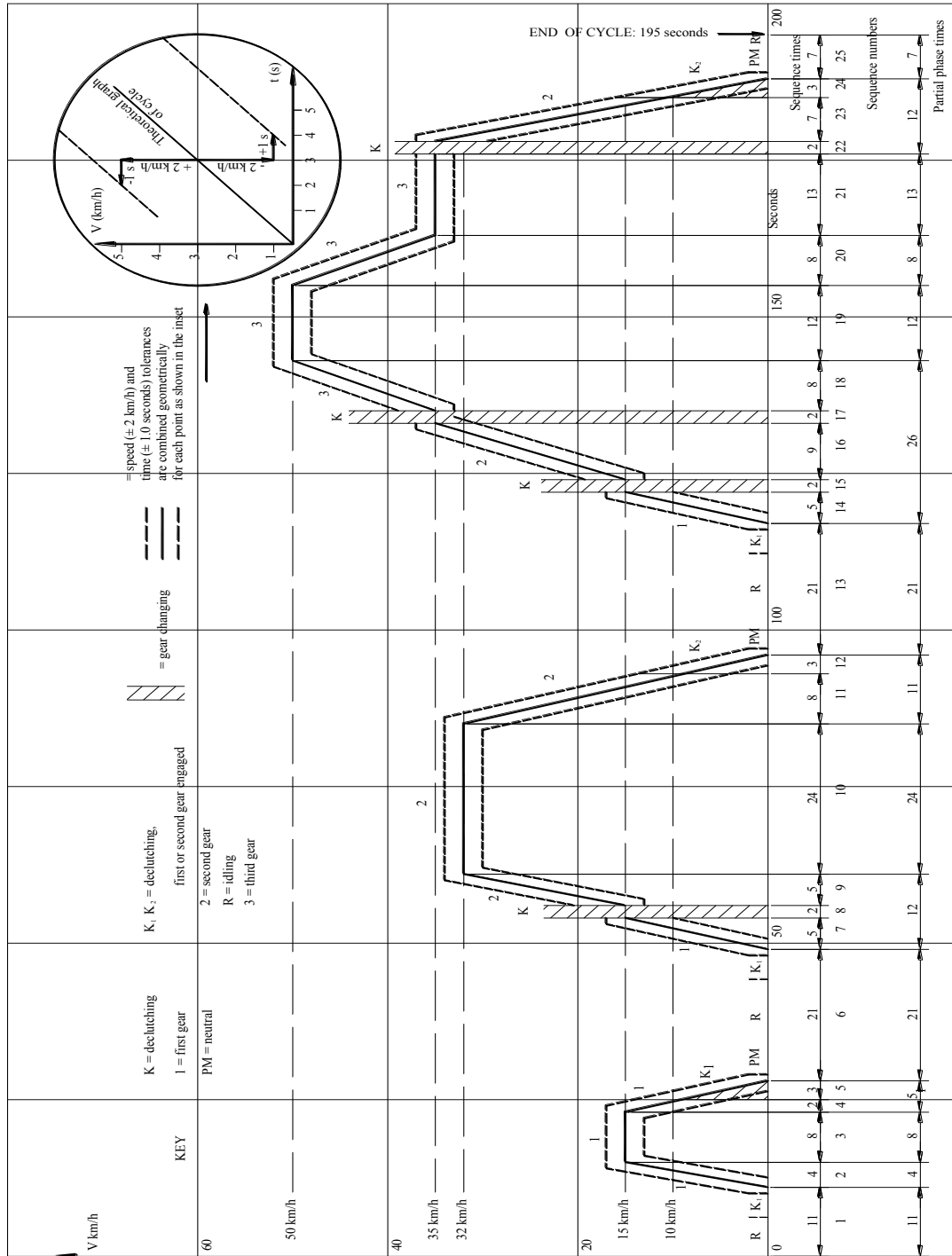
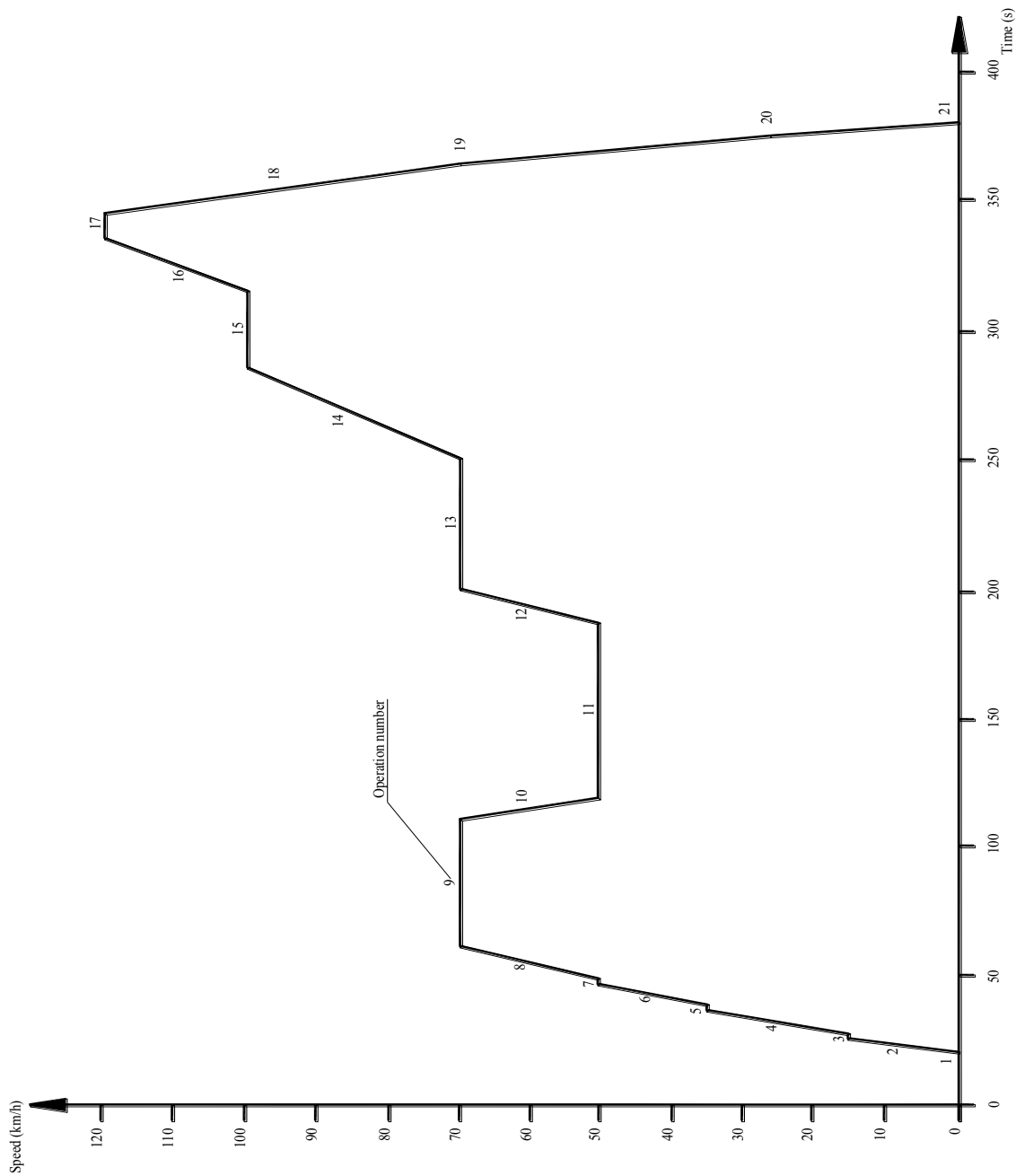

Figure A4a/3
Extra-urban cycle (Part Two) for the Type I test



Annex 4a -Appendix 1

Chassis dynamometer system

1. Specification
 - 1.1. General requirements
 - 1.1.1. The dynamometer shall be capable of simulating road load within one of the following classifications:
 - (a) Dynamometer with fixed load curve, i.e. a dynamometer whose physical characteristics provide a fixed load curve shape;
 - (b) Dynamometer with adjustable load curve, i.e. a dynamometer with at least two road load parameters that can be adjusted to shape the load curve.
 - 1.1.2. Dynamometers with electric inertia simulation shall be demonstrated to be equivalent to mechanical inertia systems. The means by which equivalence is established are described in Appendix 6 to this annex.
 - 1.1.3. In the event that the total resistance to progress on the road cannot be reproduced on the chassis dynamometer between speeds of 10 km/h and 120 km/h, it is recommended that a chassis dynamometer having the characteristics defined below should be used.
 - 1.1.3.1. The load absorbed by the brake and the chassis dynamometer internal frictional effects between the speeds of 0 and 120 km/h is as follows:
$$F = (a + b \cdot V^2) \pm 0.1 \cdot F_{80} \quad (\text{without being negative})$$
Where:
 - F = total load absorbed by the chassis dynamometer (N),
 - a = value equivalent to rolling resistance (N),
 - b = value equivalent to coefficient of air resistance (N/(km/h)²),
 - V = speed (km/h),
 - F₈₀ = load at 80 km/h (N).
 - 1.2. Specific Requirements
 - 1.2.1. The setting of the dynamometer shall not be affected by the lapse of time. It shall not produce any vibrations perceptible to the vehicle and likely to impair the vehicle's normal operations.
 - 1.2.2. The chassis dynamometer may have one or two rollers. The front roller shall drive, directly or indirectly, the inertial masses and the power absorption device.
 - 1.2.3. It shall be possible to measure and read the indicated load to an accuracy of ± 5 per cent.
 - 1.2.4. In the case of a dynamometer with a fixed load curve, the accuracy of the load setting at 80 km/h shall be ± 5 per cent. In the case of a dynamometer

with adjustable load curve, the accuracy of matching dynamometer load to road load shall be ± 5 per cent at 120, 100, 80, 60, and 40 km/h and ± 10 per cent at 20 km/h. Below this, dynamometer absorption shall be positive.

1.2.5. The total inertia of the rotating parts (including the simulated inertia where applicable) shall be known and shall be within ± 20 kg of the inertia class for the test.

1.2.6. The speed of the vehicle shall be measured by the speed of rotation of the roller (the front roller in the case of a two-roller dynamometer). It shall be measured with an accuracy of ± 1 km/h at speeds above 10 km/h.

The distance actually driven by the vehicle shall be measured by the movement of rotation of the roller (the front roller in the case of a two-roller dynamometer).

2. Dynamometer calibration procedure

2.1. Introduction

This paragraph describes the method to be used to determine the load absorbed by a dynamometer brake. The load absorbed comprises the load absorbed by frictional effects and the load absorbed by the power-absorption device.

The dynamometer is brought into operation beyond the range of test speeds. The device used for starting up the dynamometer is then disconnected: the rotational speed of the driven roller decreases.

The kinetic energy of the rollers is dissipated by the power-absorption unit and by the frictional effects. This method disregards variations in the roller's internal frictional effects caused by rollers with or without the vehicle. The frictional effects of the rear roller shall be disregarded when the roller is free.

2.2. Calibration of the load indicator at 80 km/h

The following procedure shall be used for calibration of the load indicator to 80 km/h as a function of the load absorbed (see also Figure A4a.App1/4):

2.2.1. Measure the rotational speed of the roller if this has not already been done. A fifth wheel, a revolution counter or some other method may be used.

2.2.2. Place the vehicle on the dynamometer or devise some other method of starting-up the dynamometer.

2.2.3. Use the flywheel or any other system of inertia simulation for the particular inertia class to be used.

Figure A4a.App1/4
Diagram illustrating the power absorbed by the chassis dynamometer

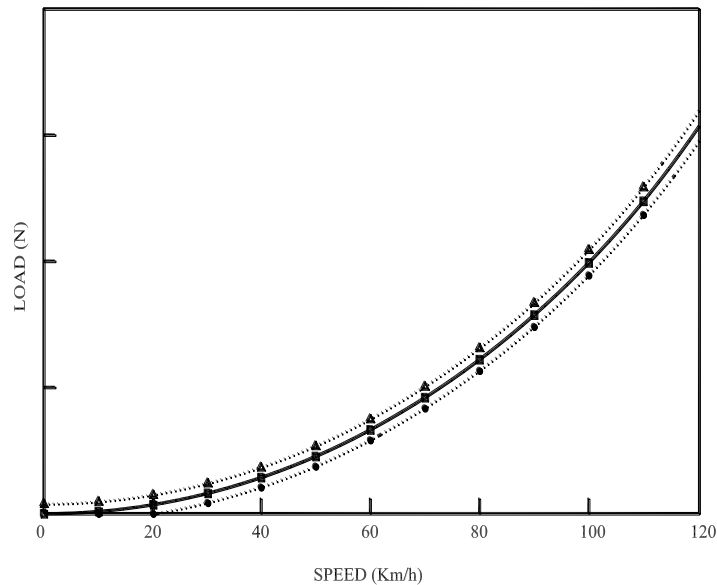

Legend:
 $\square = F = a + b \cdot V^2$ $\bullet = (a + b \cdot V^2) - 0.1 \cdot F_{80}$ $\Delta = (a + b \cdot V^2) + 0.1 \cdot F_{80}$

- 2.2.4. Bring the dynamometer to a speed of 80 km/h.
- 2.2.5. Note the load indicated F_i (N).
- 2.2.6. Bring the dynamometer to a speed of 90 km/h.
- 2.2.7. Disconnect the device used to start-up the dynamometer.
- 2.2.8. Note the time taken by the dynamometer to pass from a speed of 85 km/h to a speed of 75 km/h.
- 2.2.9. Set the power-absorption device at a different level.
- 2.2.10. The requirements of paragraphs 2.2.4. to 2.2.9. of this appendix shall be repeated sufficiently often to cover the range of loads used.
- 2.2.11. Calculate the load absorbed using the formula:

$$F = \frac{M_i \cdot \Delta V}{t}$$

Where:

- F = load absorbed (N),
- M_i = equivalent inertia in kg (excluding the inertial effects of the free rear roller),
- ΔV = speed deviation in m/s (10 km/h = 2.775 m/s),
- t = time taken by the roller to pass from 85 km/h to 75 km/h.

- 2.2.12. Figure A4a.App1/5 shows the load indicated at 80 km/h in terms of load absorbed at 80 km/h.

Figure A4a.App1/5

Load indicated at 80 km/h in terms of load absorbed at 80 km/h

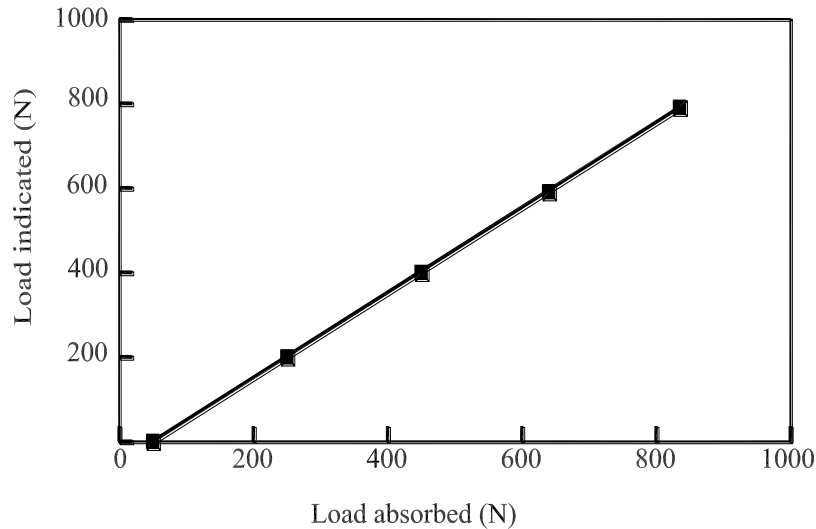

- 2.2.13. The requirements of paragraphs 2.2.3. to 2.2.12. of this appendix shall be repeated for all inertia classes to be used.

- 2.3. Calibration of the load indicator at other speeds

The procedures described in paragraph 2.2. of this appendix shall be repeated as often as necessary for the chosen speeds.

- 2.4. Calibration of force or torque

The same procedure shall be used for force or torque calibration.

3. Verification of the load curve

- 3.1. Procedure

The load-absorption curve of the dynamometer from a reference setting at a speed of 80 km/h shall be verified as follows:

- 3.1.1. Place the vehicle on the dynamometer or devise some other method of starting-up the dynamometer.
- 3.1.2. Adjust the dynamometer to the absorbed load (F) at 80 km/h.
- 3.1.3. Note the load absorbed at 120, 100, 80, 60, 40 and 20 km/h.
- 3.1.4. Draw the curve F(V) and verify that it corresponds to the requirements of paragraph 1.1.3.1. of this appendix.
- 3.1.5. Repeat the procedure set out in paragraphs 3.1.1. to 3.1.4. of this appendix for other values of power F at 80 km/h and for other values of inertias.

Annex 4a - Appendix 2

Exhaust dilution system

1. System specification

1.1. System overview

A full-flow exhaust dilution system shall be used. This requires that the vehicle exhaust be continuously diluted with ambient air under controlled conditions. The total volume of the mixture of exhaust and dilution air shall be measured and a continuously proportional sample of the volume shall be collected for analysis. The quantities of pollutants are determined from the sample concentrations, corrected for the pollutant content of the ambient air and the totalised flow over the test period.

The exhaust dilution system shall consist of a transfer tube, a mixing chamber and dilution tunnel, a dilution air conditioning, a suction device and a flow measurement device. Sampling probes shall be fitted in the dilution tunnel as specified in Appendices 3, 4 and 5 to this annex.

The mixing chamber described above will be a vessel, such as those illustrated in Figures A4a.App2/6 and A4a.App2/7, in which vehicle exhaust gases and the dilution air are combined so as to produce a homogeneous mixture at the chamber outlet.

1.2. General requirements

1.2.1. The vehicle exhaust gases shall be diluted with a sufficient amount of ambient air to prevent any water condensation in the sampling and measuring system at all conditions which may occur during a test.

1.2.2. The mixture of air and exhaust gases shall be homogeneous at the point where the sampling probe is located (see paragraph 1.3.3. of this appendix). The sampling probe shall extract a representative sample of the diluted exhaust gas.

1.2.3. The system shall enable the total volume of the diluted exhaust gases to be measured.

1.2.4. The sampling system shall be gas-tight. The design of the variable-dilution sampling system and the materials that go to make it up shall be such that they do not affect the pollutant concentration in the diluted exhaust gases. Should any component in the system (heat exchanger, cyclone separator, blower, etc.) change the concentration of any of the pollutants in the diluted exhaust gases and the fault cannot be corrected, then sampling for that pollutant shall be carried out upstream from that component.

1.2.5. All parts of the dilution system that are in contact with raw and diluted exhaust gas, shall be designed to minimise deposition or alteration of the particulates or particles. All parts shall be made of electrically conductive materials that do not react with exhaust gas components, and shall be electrically grounded to prevent electrostatic effects.

1.2.6. If the vehicle being tested is equipped with an exhaust pipe comprising several branches, the connecting tubes shall be connected as near as possible to the vehicle without adversely affecting its operation.

1.2.7. The variable-dilution system shall be so designed as to enable the exhaust gases to be sampled without appreciably changing the back-pressure at the exhaust pipe outlet.

1.2.8. The connecting tube between the vehicle and dilution system shall be designed so as to minimize heat loss.

1.3. Specific requirements

1.3.1. Connection to vehicle exhaust

The connecting tube between the vehicle exhaust outlets and the dilution system shall be as short as possible; and satisfy the following requirements:

- (a) Be less than 3.6 m long, or less than 6.1 m long if heat insulated. Its internal diameter may not exceed 105 mm;
- (b) Shall not cause the static pressure at the exhaust outlets on the vehicle being tested to differ by more than ± 0.75 kPa at 50 km/h, or more than ± 1.25 kPa for the whole duration of the test from the static pressures recorded when nothing is connected to the vehicle exhaust outlets. The pressure shall be measured in the exhaust outlet or in an extension having the same diameter, as near as possible to the end of the pipe. Sampling systems capable of maintaining the static pressure to within ± 0.25 kPa may be used if a written request from a manufacturer to the Technical Service substantiates the need for the closer tolerance;
- (c) Shall not change the nature of the exhaust gas;
- (d) Any elastomer connectors employed shall be as thermally stable as possible and have minimum exposure to the exhaust gases.

1.3.2. Dilution air conditioning

The dilution air used for the primary dilution of the exhaust in the CVS tunnel shall be passed through a medium capable of reducing particles in the most penetrating particle size of the filter material by ≥ 99.95 per cent, or through a filter of at least class H13 of EN 1822:1998. This represents the specification of High Efficiency Particulate Air (HEPA) filters. The dilution air may optionally be charcoal scrubbed before being passed to the HEPA filter. It is recommended that an additional coarse particle filter is situated before the HEPA filter and after the charcoal scrubber, if used.

At the vehicle manufacturer's request, the dilution air may be sampled according to good engineering practice to determine the tunnel contribution to background particulate mass levels, which can then be subtracted from the values measured in the diluted exhaust.

1.3.3. Dilution tunnel

Provision shall be made for the vehicle exhaust gases and the dilution air to be mixed. A mixing orifice may be used.

In order to minimise the effects on the conditions at the exhaust outlet and to limit the drop in pressure inside the dilution-air conditioning device, if any, the pressure at the mixing point shall not differ by more than ± 0.25 kPa from atmospheric pressure.

The homogeneity of the mixture in any cross-section at the location of the sampling probe shall not vary by more than ± 2 per cent from the average of the values obtained for at least five points located at equal intervals on the diameter of the gas stream.

For particulate and particle emissions sampling, a dilution tunnel shall be used which:

- (a) Shall consist of a straight tube of electrically-conductive material, which shall be earthed;
- (b) Shall be small enough in diameter to cause turbulent flow (Reynolds number ≥ 4000) and of sufficient length to cause complete mixing of the exhaust and dilution air;
- (c) Shall be at least 200 mm in diameter;
- (d) May be insulated.

1.3.4. Suction device

This device may have a range of fixed speeds to ensure sufficient flow to prevent any water condensation. This result is generally obtained if the flow is either:

- (a) Twice as high as the maximum flow of exhaust gas produced by accelerations of the driving cycle; or
- (b) Sufficient to ensure that the CO₂ concentration in the dilute-exhaust sample bag is less than 3 per cent by volume for petrol and diesel, less than 2.2 per cent by volume for LPG and less than 1.5 per cent by volume for NG/biomethane.

1.3.5. Volume Measurement in the Primary Dilution System

The method of measuring total dilute exhaust volume incorporated in the constant volume sampler shall be such that measurement is accurate to ± 2 per cent under all operating conditions. If the device cannot compensate for variations in the temperature of the mixture of exhaust gases and dilution air at the measuring point, a heat exchanger shall be used to maintain the temperature to within ± 6 K of the specified operating temperature.

If necessary, some form of protection for the volume measuring device may be used e.g. a cyclone separator, bulk stream filter, etc.

A temperature sensor shall be installed immediately before the volume measuring device. This temperature sensor shall have an accuracy and a precision of ± 1 K and a response time of 0.1 s at 62 per cent of a given temperature variation (value measured in silicone oil).

The measurement of the pressure difference from atmospheric pressure shall be taken upstream from and, if necessary, downstream from the volume measuring device.

The pressure measurements shall have a precision and an accuracy of ± 0.4 kPa during the test.

1.4. Recommended System Descriptions

Figure A4a.App2/6 and Figure A4a.App2/7 are schematic drawings of two types of recommended exhaust dilution systems that meet the requirements of this annex.

Since various configurations can produce accurate results, exact conformity with these figures is not essential. Additional components such as instruments, valves, solenoids and switches may be used to provide additional information and co-ordinate the functions of the component system.

1.4.1. Full Flow Dilution System with Positive Displacement Pump

Figure A4a.App2/6
Positive Displacement Pump Dilution System

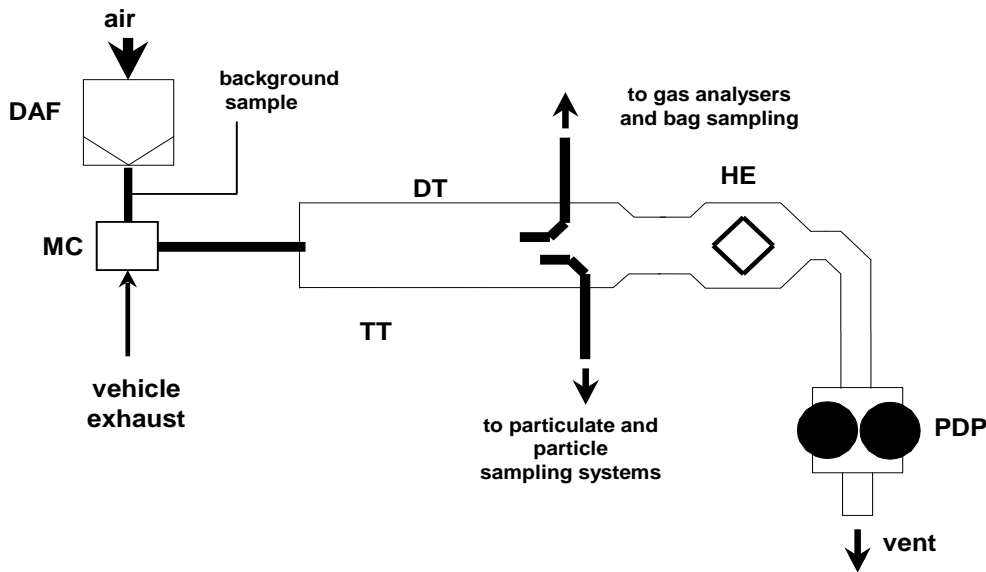

The positive displacement pump (PDP) full flow dilution system satisfies the requirements of this annex by metering the flow of gas through the pump at constant temperature and pressure. The total volume is measured by counting the revolutions made by the calibrated positive displacement pump. The proportional sample is achieved by sampling with pump, flow-meter and flow control valve at a constant flow rate. The collecting equipment consists of:

- 1.4.1.1. A filter (DAF) for the dilution air, which can be preheated if necessary. This filter shall consist of the following filters in sequence: an optional activated charcoal filter (inlet side), and a high efficiency particulate air (HEPA) filter (outlet side). It is recommended that an additional coarse particle filter is situated before the HEPA filter and after the charcoal filter, if used. The purpose of the charcoal filter is to reduce and stabilize the hydrocarbon concentrations of ambient emissions in the dilution air;
- 1.4.1.2. A transfer tube (TT) by which vehicle exhaust is admitted into a dilution tunnel (DT) in which the exhaust gas and dilution air are mixed homogeneously;
- 1.4.1.3. The positive displacement pump (PDP), producing a constant-volume flow of the air/exhaust-gas mixture. The PDP revolutions, together with associated temperature and pressure measurement are used to determine the flowrate;
- 1.4.1.4. A heat exchanger (HE) of a capacity sufficient to ensure that throughout the test the temperature of the air/exhaust-gas mixture measured at a point immediately upstream of the positive displacement pump is within 6 K of the average operating temperature during the test. This device shall not affect the pollutant concentrations of diluted gases taken off after for analysis.
- 1.4.1.5. A mixing chamber (MC) in which exhaust gas and air are mixed homogeneously, and which may be located close to the vehicle so that the length of the transfer tube (TT) is minimized.
- 1.4.2. Full Flow Dilution System with Critical Flow Venturi

Figure A4a.App2/7
Critical-Flow Venturi Dilution System

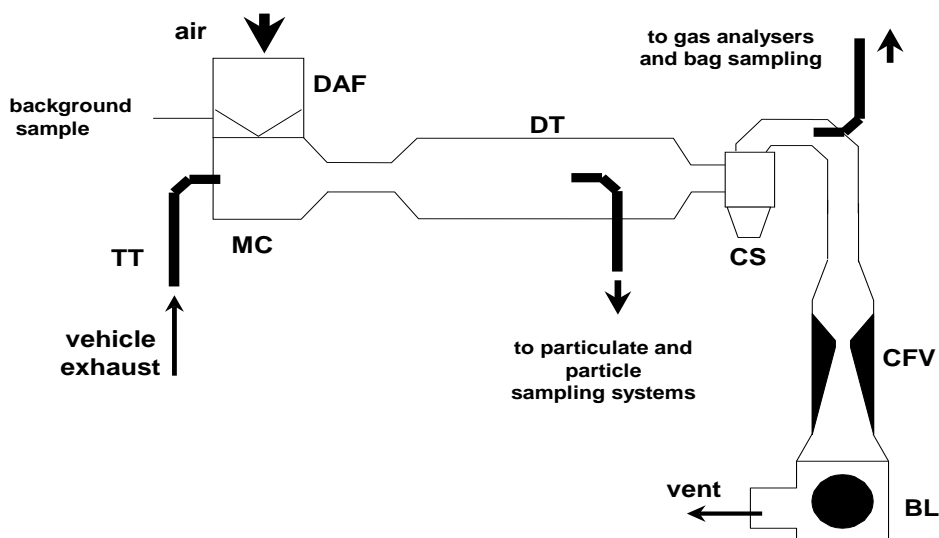

The use of a critical-flow venturi (CFV) for the full-flow dilution system is based on the principles of flow mechanics for critical flow. The variable mixture flow rate of dilution and exhaust gas is maintained at sonic velocity which is directly proportional to the square root of the gas temperature. Flow is continually monitored, computed and integrated throughout the test.

The use of an additional critical-flow sampling venturi ensures the proportionality of the gas samples taken from the dilution tunnel. As both pressure and temperature are equal at the two venturi inlets the volume of the gas flow diverted for sampling is proportional to the total volume of diluted exhaust-gas mixture produced, and thus the requirements of this annex are met. The collecting equipment consists of:

- 1.4.2.1. A filter (DAF) for the dilution air, which can be preheated if necessary. This filter shall consist of the following filters in sequence: an optional activated charcoal filter (inlet side), and a high efficiency particulate air (HEPA) filter (outlet side). It is recommended that an additional coarse particle filter is situated before the HEPA filter and after the charcoal filter, if used. The purpose of the charcoal filter is to reduce and stabilize the hydrocarbon concentrations of ambient emissions in the dilution air;
- 1.4.2.2. A mixing chamber (MC) in which exhaust gas and air are mixed homogeneously, and which may be located close to the vehicle so that the length of the transfer tube (TT) is minimized;
- 1.4.2.3. A dilution tunnel (DT) from which particulates and particles are sampled;
- 1.4.2.4. Some form of protection for the measurement system may be used e.g. a cyclone separator, bulk stream filter, etc.;
- 1.4.2.5. A measuring critical-flow venturi tube (CFV), to measure the flow volume of the diluted exhaust gas;
- 1.4.2.6. A blower (BL), of sufficient capacity to handle the total volume of diluted exhaust gas.

2. CVS calibration procedure
 - 2.1. General requirements

The CVS system shall be calibrated by using an accurate flow-meter and a restricting device. The flow through the system shall be measured at various pressure readings and the control parameters of the system measured and related to the flows. The flow-metering device shall be dynamic and suitable for the high flow-rate encountered in constant volume sampler testing. The device shall be of certified accuracy traceable to an approved national or international standard.
 - 2.1.1. Various types of flow-meter may be used, e.g. calibrated venturi, laminar flow-meter, calibrated turbine-meter, provided that they are dynamic measurement systems and can meet the requirements of paragraph 1.3.5. of this appendix.
 - 2.1.2. The following paragraphs give details of methods of calibrating PDP and CFV units, using a laminar flow-meter, which gives the required accuracy, together with a statistical check on the calibration validity.
 - 2.2. Calibration of the positive displacement pump (PDP)
 - 2.2.1. The following calibration procedure outlines the equipment, the test configuration and the various parameters that are measured to establish the flow-rate of the CVS pump. All the parameters related to the pump are simultaneously measured with the parameters related to the flow-meter which is connected in series with the pump. The calculated flow-rate (given in m^3/min at pump inlet, absolute pressure and temperature) can then be plotted versus a correlation function that is the value of a specific combination of pump parameters. The linear equation that relates the pump flow and the correlation function is then determined. In the event that a CVS has a multiple speed drive, a calibration for each range used shall be performed.
 - 2.2.2. This calibration procedure is based on the measurement of the absolute values of the pump and flow-meter parameters that relate the flow rate at each point. Three conditions shall be maintained to ensure the accuracy and integrity of the calibration curve:
 - 2.2.2.1. The pump pressures shall be measured at tappings on the pump rather than at the external piping on the pump inlet and outlet. Pressure taps that are mounted at the top centre and bottom centre of the pump drive headplate are exposed to the actual pump cavity pressures, and therefore reflect the absolute pressure differentials;
 - 2.2.2.2. Temperature stability shall be maintained during the calibration. The laminar flow-meter is sensitive to inlet temperature oscillations which cause the data points to be scattered. Gradual changes of ± 1 K in temperature are acceptable as long as they occur over a period of several minutes; and
 - 2.2.2.3. All connections between the flow-meter and the CVS pump shall be free of any leakage.
 - 2.2.3. During an exhaust emission test, the measurement of these same pump parameters enables the user to calculate the flow rate from the calibration equation.
 - 2.2.4. Figure A4a.App2/8 of this appendix shows one possible test set-up. Variations are permissible, provided that the Technical Service approves them as being of comparable accuracy. If the set-up shown in Figure A4a.App2/8 is used, the following data shall be found within the limits of precision given:

Barometric pressure (corrected)(P _b)	±0.03 kPa
Ambient temperature (T)	±0.2 K
Air temperature at LFE (ETI)	±0.15 K
Pressure depression upstream of LFE (EPI)	±0.01 kPa
Pressure drop across the LFE matrix (EDP)	±0.0015 kPa
Air temperature at CVS pump inlet (PTI)	±0.2 K
Air temperature at CVS pump outlet (PTO)	±0.2 K
Pressure depression at CVS pump inlet (PPI)	±0.22 kPa
Pressure head at CVS pump outlet (PPO)	±0.22 kPa
Pump revolutions during test period (n)	±1 min ⁻¹
Elapsed time for period (minimum 250 s) (t)	±0.1 s

Figure A4a.App2/8
PDP Calibration Configuration

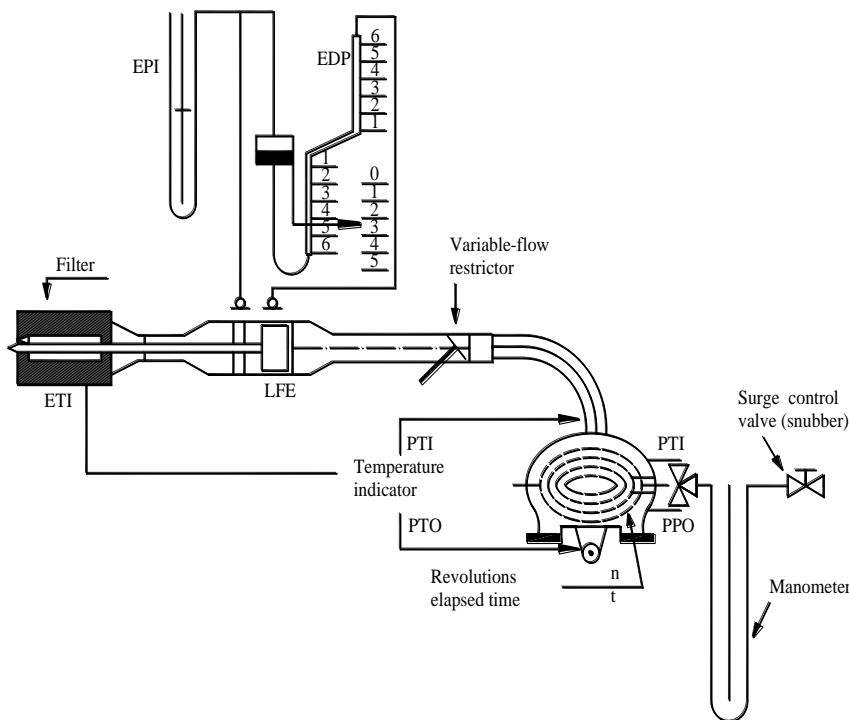

- 2.2.5. After the system has been connected as shown in Figure A4a.App2/8, set the variable restrictor in the wide-open position and run the CVS pump for 20 minutes before starting the calibration.
- 2.2.6. Reset the restrictor valve to a more restricted condition in an increment of pump inlet depression (about 1 kPa) that will yield a minimum of six data points for the total calibration. Allow the system to stabilize for three minutes and repeat the data acquisition.
- 2.2.7. The air flow rate (Q_s) at each test point is calculated in standard m³/min from the flow-meter data using the manufacturer's prescribed method.
- 2.2.8. The air flow-rate is then converted to pump flow (V₀) in m³/rev at absolute pump inlet temperature and pressure.

$$V_0 = \frac{Q_s}{n} \cdot \frac{T_p}{273.2} \cdot \frac{101.33}{P_p}$$

Where:

- V_0 = pump flow rate at T_p and P_p (m^3/rev),
- Q_s = air flow at 101.33 kPa and 273.2 K (m^3/min),
- T_p = pump inlet temperature (K),
- P_p = absolute pump inlet pressure (kPa),
- N = pump speed (min^{-1}).

- 2.2.9. To compensate for the interaction of pump speed pressure variations at the pump and the pump slip rate, the correlation function (x_0) between the pump speed (n), the pressure differential from pump inlet to pump outlet and the absolute pump outlet pressure is then calculated as follows:

$$x_0 = \frac{1}{n} \sqrt{\frac{\Delta P_p}{P_e}}$$

Where:

- x_0 = correlation function,
- ΔP_p = pressure differential from pump inlet to pump outlet (kPa),
- P_e = absolute outlet pressure ($PPO + P_b$) (kPa).

A linear least-square fit is performed to generate the calibration equations which have the formula:

$$V_0 = D_0 - M(x_0)$$

$$n = A - B(\Delta P_p)$$

D_0 , M , A and B are the slope-intercept constants describing the lines.

- 2.2.10. A CVS system that has multiple speeds shall be calibrated on each speed used. The calibration curves generated for the ranges shall be approximately parallel and the intercept values (D_0) shall increase as the pump flow range decreases.

- 2.2.11. If the calibration has been performed carefully, the calculated values from the equation will be within 0.5 per cent of the measured value of V_0 . Values of M will vary from one pump to another. Calibration is performed at pump start-up and after major maintenance.

- 2.3. Calibration of the critical-flow venturi (CFV)

- 2.3.1. Calibration of the CFV is based upon the flow equation for a critical venturi:

$$Q_s = \frac{K_v P}{\sqrt{T}}$$

Where:

- Q_s = flow,
- K_v = calibration coefficient,
- P = absolute pressure (kPa),
- T = absolute temperature (K).

Gas flow is a function of inlet pressure and temperature.

The calibration procedure described below establishes the value of the calibration coefficient at measured values of pressure, temperature and air flow.

2.3.2. The manufacturer's recommended procedure shall be followed for calibrating electronic portions of the CFV.

2.3.3. Measurements for flow calibration of the critical flow venturi are required and the following data shall be found within the limits of precision given:

Barometric pressure (corrected) (P_b)	± 0.03 kPa,
LFE air temperature, flow-meter (ETI)	± 0.15 K,
Pressure depression upstream of LFE (EPI)	± 0.01 kPa,
Pressure drop across (EDP) LFE matrix	± 0.0015 kPa,
Air flow (Q_s)	± 0.5 per cent,
CFV inlet depression (PPI)	± 0.02 kPa,
Temperature at venturi inlet (T_v)	± 0.2 K.

2.3.4. The equipment shall be set up as shown in Figure A4a.App2/9 and checked for leaks. Any leaks between the flow-measuring device and the critical-flow venturi will seriously affect the accuracy of the calibration.

Figure A4a.App2/9
CFV Calibration Configuration

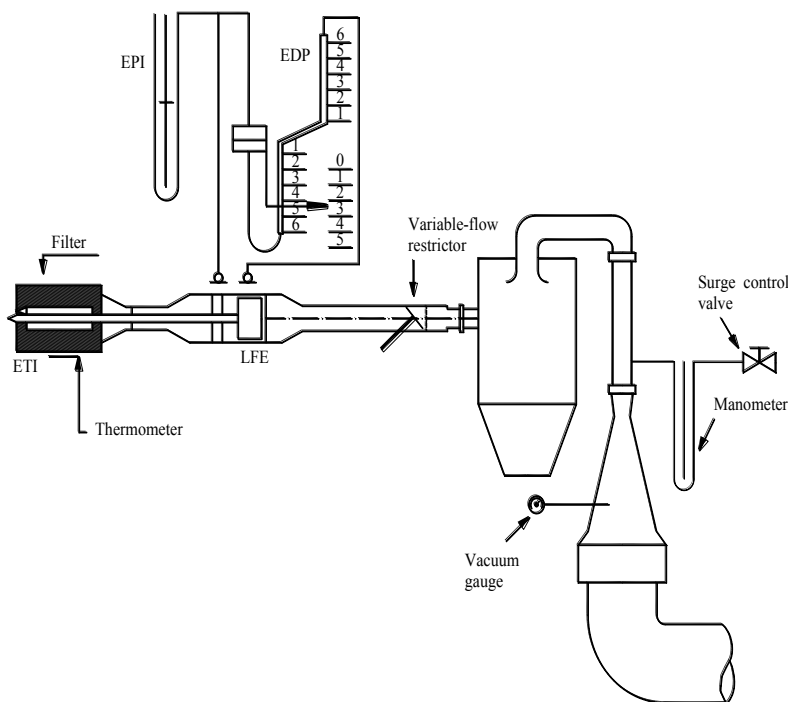

2.3.5. The variable-flow restrictor shall be set to the open position, the blower shall be started and the system stabilized. Data from all instruments shall be recorded.

2.3.6. The flow restrictor shall be varied and at least eight readings across the critical flow range of the venturi shall be made.

- 2.3.7. The data recorded during the calibration shall be used in the following calculations. The air flow-rate (Q_s) at each test point is calculated from the flow-meter data using the manufacturer's prescribed method.

Calculate values of the calibration coefficient for each test point:

$$K_v = \frac{Q_s \sqrt{T_v}}{P_v}$$

Where:

- Q_s = flow-rate in m³/min at 273.2 K and 101.33 kPa,
 T_v = temperature at the venturi inlet (K),
 P_v = absolute pressure at the venturi inlet (kPa).

Plot K_v as a function of venturi inlet pressure. For sonic flow, K_v will have a relatively constant value. As pressure decreases (vacuum increases) the venturi becomes unchoked and K_v decreases. The resultant K_v changes are not permissible.

For a minimum of eight points in the critical region, calculate an average K_v and the standard deviation.

If the standard deviation exceeds 0.3 per cent of the average K_v , take corrective action.

3. System verification procedure

3.1. General requirements

The total accuracy of the CVS sampling system and analytical system shall be determined by introducing a known mass of a pollutant gas into the system whilst it is being operated as if during a normal test and then analysing and calculating the pollutant mass according to the formulae in paragraph 6.6. of Annex 4a to this Regulation except that the density of propane shall be taken as 1.967 grams per litre at standard conditions. The following two techniques are known to give sufficient accuracy.

The maximum permissible deviation between the quantity of gas introduced and the quantity of gas measured is 5 per cent.

3.2. CFO method

3.2.1. Metering a constant flow of pure gas (CO or C₃H₈) using a critical flow orifice device.

3.2.2. A known quantity of pure gas (CO or C₃H₈) is fed into the CVS system through the calibrated critical orifice. If the inlet pressure is high enough, the flow-rate (q), which is adjusted by means of the critical flow orifice, is independent of orifice outlet pressure (critical flow). If deviations exceeding 5 per cent occur, the cause of the malfunction shall be determined and corrected. The CVS system is operated as in an exhaust emission test for about 5 to 10 minutes. The gas collected in the sampling bag is analysed by the usual equipment and the results compared to the concentration of the gas samples which was known beforehand.

3.3. Gravimetric method

3.3.1. Metering a limited quantity of pure gas (CO or C₃H₈) by means of a gravimetric technique.

3.3.2. The following gravimetric procedure may be used to verify the CVS system.

The weight of a small cylinder filled with either carbon monoxide or propane is determined with a precision of ± 0.01 g. For about 5 to 10 minutes, the CVS system is operated as in a normal exhaust emission test, while CO or propane is injected into the system. The quantity of pure gas involved is determined by means of differential weighing. The gas accumulated in the bag is then analysed by means of the equipment normally used for exhaust-gas analysis. The results are then compared to the concentration figures computed previously.

Annex 4a -Appendix 3

Gaseous emissions measurement equipment

1. Specification
 - 1.1. System overview

A continuously proportional sample of the diluted exhaust gases and the dilution air shall be collected for analysis.

Mass gaseous emissions shall be determined from the proportional sample concentrations and the total volume measured during the test. The sample concentrations shall be corrected to take account of the pollutant content of the ambient air.
 - 1.2. Sampling system requirements
 - 1.2.1. The sample of dilute exhaust gases shall be taken upstream from the suction device but downstream from the conditioning devices (if any).
 - 1.2.2. The flow rate shall not deviate from the average by more than ± 2 per cent.
 - 1.2.3. The sampling rate shall not fall below 5 litres per minute and shall not exceed 0.2 per cent of the flow rate of the dilute exhaust gases. An equivalent limit shall apply to constant-mass sampling systems.
 - 1.2.4. A sample of the dilution air shall be taken at a constant flow rate near the ambient air-inlet (after the filter if one is fitted).
 - 1.2.5. The dilution air sample shall not be contaminated by exhaust gases from the mixing area.
 - 1.2.6. The sampling rate for the dilution air shall be comparable to that used in the case of the dilute exhaust gases.
 - 1.2.7. The materials used for the sampling operations shall be such as not to change the pollutant concentration.
 - 1.2.8. Filters may be used in order to extract the solid particles from the sample.
 - 1.2.9. The various valves used to direct the exhaust gases shall be of a quick-adjustment, quick-acting type.
 - 1.2.10. Quick-fastening gas-tight connections may be used between the three-way valves and the sampling bags, the connections sealing themselves automatically on the bag side. Other systems may be used for conveying the samples to the analyser (three-way stop valves, for example).
 - 1.2.11. Storage of the sample

The gas samples shall be collected in sampling bags of sufficient capacity not to impede the sample flow; the bag material shall be such as to affect neither the measurements themselves nor the chemical composition of the gas samples by more than ± 2 per cent after 20 minutes (for instance: laminated polyethylene/polyamide films, or fluorinated polyhydrocarbons).

- 1.2.12. Hydrocarbon sampling system – diesel engines
- 1.2.12.1. The hydrocarbon sampling system shall consist of a heated sampling probe, line, filter and pump. The sampling probe shall be installed at the same distance from the exhaust gas inlet as the particulate sampling probe, in such a way that neither interferes with samples taken by the other. It shall have a minimum internal diameter of 4 mm.
- 1.2.12.2. All heated parts shall be maintained at a temperature of 463 K (190 °C) ± 10 K by the heating system.
- 1.2.12.3. The average concentration of the measured hydrocarbons shall be determined by integration.
- 1.2.12.4. The heated sampling line shall be fitted with a heated filter (F_H) 99 per cent efficient with particles $\geq 0.3 \mu\text{m}$, to extract any solid particles from the continuous flow of gas required for analysis.
- 1.2.12.5. The sampling system response time (from the probe to the analyser inlet) shall be no more than four seconds.
- 1.2.12.6. The HFID shall be used with a constant flow (heat exchanger) system to ensure a representative sample, unless compensation for varying CFV or CFO flow is made.
- 1.3. Gas Analysis Requirements
- 1.3.1. Carbon monoxide (CO) and carbon dioxide (CO₂) analyses:
Analysers shall be of the non-dispersive infra-red (NDIR) absorption type.
- 1.3.2. Total Hydrocarbons (THC) analysis - spark-ignition engines:
The analyser shall be of the flame ionisation (FID) type calibrated with propane gas expressed equivalent to carbon atoms (C₁).
- 1.3.3. Total Hydrocarbons (THC) analysis - compression-ignition engines:
The analyser shall be of the flame ionisation type with detector, valves, pipework, etc., heated to 463 K (190 °C) ± 10 K (HFID). It shall be calibrated with propane gas expressed equivalent to carbon atoms (C₁).
- 1.3.4. Methane (CH₄) analysis:
The analyser shall be either a gas chromatograph combined with a flame ionisation (FID) type or a flame ionisation (FID) with a non-methane cutter type, calibrated with methane gas expressed as equivalent to carbon atoms (C₁).
- 1.3.5. Water (H₂O) analysis:
The analyser shall be of the non-dispersive infrared analyzer (NDIR) absorption type. The NDIR shall be calibrated either with water vapour or with propylene (C₃H₆). If the NDIR is calibrated with water vapour, it shall be ensured that no water condensation can occur in tubes and connections during the calibration process. If the NDIR is calibrated with propylene, the manufacturer of the analyzer shall provide the information for converting the concentration of propylene to its corresponding concentration of water vapour. The values for conversion shall be periodically checked by the manufacturer of the analyzer, and at least once per year.

- 1.3.6. Hydrogen (H₂) analysis:
The analyser shall be of the sector field mass spectrometry type, calibrated with hydrogen.
- 1.3.7. Nitrogen oxide (NO_x) analysis:
The analyser shall be either of the chemi-luminescent (CLA) or of the non-dispersive ultra-violet resonance absorption (NDUVR) type, both with NO_x-NO converters.
- 1.3.8. The analysers shall have a measuring range compatible with the accuracy required to measure the concentrations of the exhaust gas sample pollutants.
- 1.3.9. Measurement error shall not exceed ±2 per cent (intrinsic error of analyser) disregarding the true value for the calibration gases.
- 1.3.10. For concentrations of less than 100 ppm, the measurement error shall not exceed ±2 ppm.
- 1.3.11. The ambient air sample shall be measured on the same analyser with an appropriate range.
- 1.3.12. No gas drying device shall be used before the analysers unless shown to have no effect on the pollutant content of the gas stream.
- 1.4. Recommended System Descriptions

Figure A4a.App3/10 is a schematic drawing of the system for gaseous emissions sampling.

Figure A4a.App3/10
Gaseous Emissions Sampling Schematic

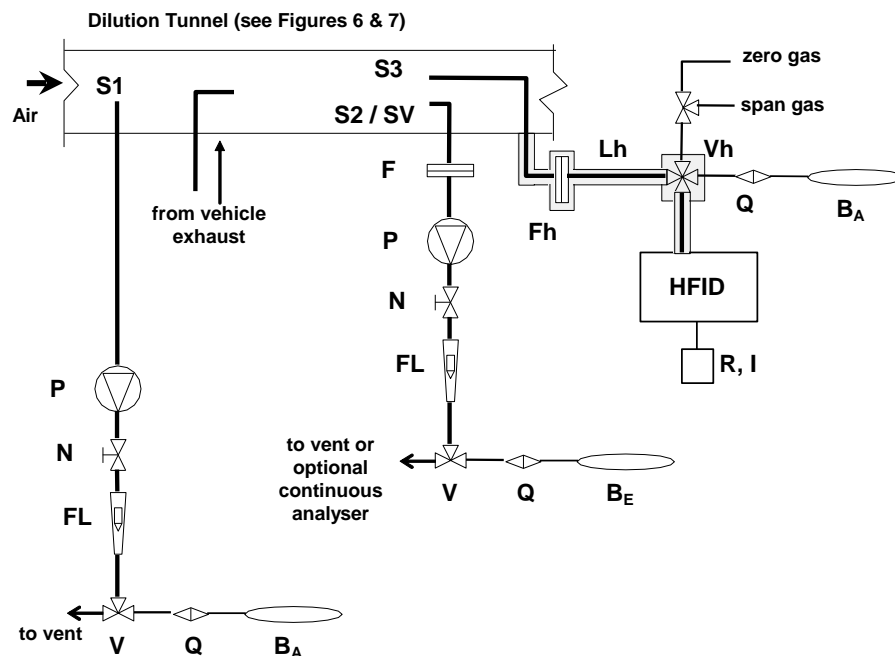

The components of the system are as follows:

- 1.4.1. Two sampling probes (S_1 and S_2) for continuous sampling of the dilution air and of the diluted exhaust-gas/air mixture;
 - 1.4.2. A filter (F), to extract solid particles from the flows of gas collected for analysis;
 - 1.4.3. Pumps (P), to collect a constant flow of the dilution air as well as of the diluted exhaust-gas/air mixture during the test;
 - 1.4.4. Flow controller (N), to ensure a constant uniform flow of the gas samples taken during the course of the test from sampling probes S_1 and S_2 (for PDP-CVS) and flow of the gas samples shall be such that, at the end of each test, the quantity of the samples is sufficient for analysis (approximately 10 litres per minute);
 - 1.4.5. Flow meters (FL), for adjusting and monitoring the constant flow of gas samples during the test;
 - 1.4.6. Quick-acting valves (V), to divert a constant flow of gas samples into the sampling bags or to the outside vent;
 - 1.4.7. Gas-tight, quick-lock coupling elements (Q) between the quick-acting valves and the sampling bags; the coupling shall close automatically on the sampling-bag side; as an alternative, other ways of transporting the samples to the analyser may be used (three-way stopcocks, for instance);
 - 1.4.8. Bags (B), for collecting samples of the diluted exhaust gas and of the dilution air during the test;
 - 1.4.9. A sampling critical-flow venturi (SV), to take proportional samples of the diluted exhaust gas at sampling probe S_2 A(CFV-CVS only);
 - 1.4.10. A scrubber (PS), in the sampling line (CFV-CVS only);
 - 1.4.11. Components for hydrocarbon sampling using HFID:
 - F_h is a heated filter,
 - S₃ is a sampling point close to the mixing chamber,
 - V_h is a heated multi-way valve,
 - Q is a quick connector to allow the ambient air sample BA to be analysed on the HFID,
 - FID is a heated flame ionisation analyser,
 - R and I are a means of integrating and recording the instantaneous hydrocarbon concentrations,
 - L_h is a heated sample line.
2. Calibration procedures
 - 2.1. Analyser calibration procedure
 - 2.1.1. Each analyser shall be calibrated as often as necessary and in any case in the month before type approval testing and at least once every six months for verifying conformity of production.
 - 2.1.2. Each normally used operating range shall be calibrated by the following procedure:
 - 2.1.2.1. The analyser calibration curve is established by at least five calibration points spaced as uniformly as possible. The nominal

- concentration of the calibration gas of the highest concentration shall be not less than 80 per cent of the full scale.
- 2.1.2.2. The calibration gas concentration required may be obtained by means of a gas divider, diluting with purified N₂ or with purified synthetic air. The accuracy of the mixing device shall be such that the concentrations of the diluted calibration gases may be determined to within ± 2 per cent.
- 2.1.2.3. The calibration curve is calculated by the least squares method. If the resulting polynomial degree is greater than 3, the number of calibration points shall be at least equal to this polynomial degree plus 2.
- 2.1.2.4. The calibration curve shall not differ by more than ± 2 per cent from the nominal value of each calibration gas.
- 2.1.3. Trace of the calibration curve
- From the trace of the calibration curve and the calibration points, it is possible to verify that the calibration has been carried out correctly. The different characteristic parameters of the analyser shall be indicated, particularly:
- The scale;
 - The sensitivity;
 - The zero point;
 - The date of carrying out the calibration.
- 2.1.4. If it can be shown to the satisfaction of the technical service that alternative technology (e.g. computer, electronically controlled range switch, etc.) can give equivalent accuracy, then these alternatives may be used.
- 2.2. Analyser Verification Procedure
- 2.2.1. Each normally used operating range shall be checked prior to each analysis in accordance with the following:
- 2.2.2. The calibration shall be checked by use of a zero gas and by use of a span gas that has a nominal value within 80-95 per cent of the supposed value to be analysed.
- 2.2.3. If, for the two points considered, the value found does not differ by more than ± 5 per cent of the full scale from the theoretical value, the adjustment parameters may be modified. Should this not be the case, a new calibration curve shall be established in accordance with paragraph 2.1. of this appendix.
- 2.2.4. After testing, zero gas and the same span gas are used for re-checking. The analysis is considered acceptable if the difference between the two measuring results is less than 2 per cent.
- 2.3. FID Hydrocarbon Response Check Procedure
- 2.3.1. Detector response optimisation
- The FID shall be adjusted, as specified by the instrument manufacturer. Propane in air should be used, to optimise the response, on the most common operating range.

- 2.3.2. Calibration of the HC analyser
- The analyser should be calibrated using propane in air and purified synthetic air (see paragraph 3 of this appendix).
- Establish a calibration curve as described in paragraph 2.1. of this appendix.
- 2.3.3. Response factors of different hydrocarbons and recommended limits
- The response factor (Rf), for a particular hydrocarbon species is the ratio of the FID C_1 reading to the gas cylinder concentration, expressed as ppm C_1 .
- The concentration of the test gas shall be at a level to give a response of approximately 80 per cent of full-scale deflection, for the operating range. The concentration shall be known, to an accuracy of ± 2 per cent in reference to a gravimetric standard expressed in volume. In addition, the gas cylinder shall be pre-conditioned for 24 hours at a temperature between 293 K and 303 K (20 and 30 °C).
- Response factors should be determined when introducing an analyser into service and thereafter at major service intervals. The test gases to be used and the recommended response factors are:
- Methane and purified air: $1.00 < Rf < 1.15$
or $1.00 < Rf < 1.05$ for NG/biomethane fuelled vehicles
- Propylene and purified air: $0.90 < Rf < 1.00$
- Toluene and purified air: $0.90 < Rf < 1.00$
- These are relative to a response factor (Rf) of 1.00 for propane and purified air.
- 2.3.4. Oxygen interference check and recommended limits
- The response factor shall be determined as described in paragraph 2.3.3.. The test gas to be used and recommended response factor range is:
- Propane and nitrogen: $0.95 < Rf < 1.05$
- 2.4. NO_x Converter Efficiency Test Procedure
- The efficiency of the converter used for the conversion of NO_2 into NO is tested as follows:
- Using the test set up as shown in Figure A4a.App3/11 and the procedure described below, the efficiency of converters can be tested by means of an ozonator.
- 2.4.1. Calibrate the analyzer in the most common operating range following the manufacturer's specifications using zero and span gas (the NO content of which shall amount to about 80 per cent of the operating range and the NO_2 concentration of the gas mixture shall be less than 5 per cent of the NO concentration). The NO_x analyser shall be in the NO mode so that the span gas does not pass through the converter. Record the indicated concentration.
- 2.4.2. Via a T-fitting, oxygen or synthetic air is added continuously to the span gas flow until the concentration indicated is about 10 per cent less than the indicated calibration concentration given in paragraph 2.4.1. of this appendix. Record the indicated concentration (c). The ozonator is kept deactivated throughout this process.

- 2.4.3. The ozonator is now activated to generate enough ozone to bring the NO concentration down to 20 per cent (minimum 10 per cent) of the calibration concentration given in paragraph 2.4.1. of this appendix. Record the indicated concentration (d).
- 2.4.4. The NO_x analyser is then switched to the NO_x mode, which means that the gas mixture (consisting of NO, NO₂, O₂ and N₂) now passes through the converter. Record the indicated concentration (a).
- 2.4.5. The ozonator is now deactivated. The mixture of gases described in paragraph 2.4.2. of this appendix passes through the converter into the detector. Record the indicated concentration (b).

Figure A4a.App3/11

NO_x Converter Efficiency Test Configuration

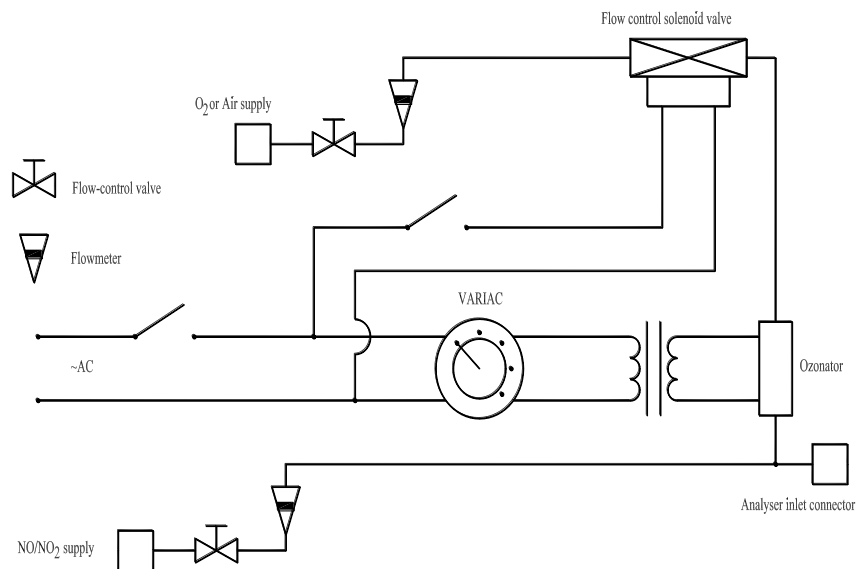

- 2.4.6. With the ozonator deactivated, the flow of oxygen or synthetic air is also shut off. The NO₂ reading of the analyser shall then be no more than 5 per cent above the figure given in paragraph 2.4.1. of this appendix.
- 2.4.7. The efficiency of the NO_x converter is calculated as follows:
- $$\text{Efficiency (per cent)} = \left(1 + \frac{a - b}{c - d}\right) \cdot 100$$
- 2.4.8. The efficiency of the converter shall not be less than 95 per cent.
- 2.4.9. The efficiency of the converter shall be tested at least once a week.

3. Reference gases

3.1. Pure gases

The following pure gases shall be available, if necessary, for calibration and operation:

Purified nitrogen: (purity: ≤ 1 ppm C, ≤ 1 ppm CO, ≤ 400 ppm CO₂, ≤ 0.1 ppm NO);

Purified synthetic air: (purity: ≤ 1 ppm C, ≤ 1 ppm CO, ≤ 400 ppm CO₂, ≤ 0.1 ppm NO); oxygen content between 18 and 21 per cent volume;

Purified oxygen: (purity > 99.5 per cent vol. O₂);

Purified hydrogen (and mixture containing helium):
(purity ≤ 1 ppm C, ≤400 ppm CO₂);

Carbon monoxide: (minimum purity 99.5 per cent);

Propane: (minimum purity 99.5 per cent);

Propylene: (minimum purity 99.5 per cent).

3.2. Calibration and span gases

Mixtures of gases having the following chemical compositions shall be available:

- (a) C₃H₈ and purified synthetic air (see paragraph 3.1);
- (b) CO and purified nitrogen;
- (c) CO₂ and purified nitrogen.

NO and purified nitrogen (the amount of NO₂ contained in this calibration gas shall not exceed 5 per cent of the NO content).

The true concentration of a calibration gas shall be within ±2 per cent of the stated figure.

Annex 4a -Appendix 4

Particulate mass emissions measurement equipment

1. Specification
 - 1.1. System overview
 - 1.1.1. The particulate sampling unit shall consist of a sampling probe located in the dilution tunnel, a particle transfer tube, a filter holder, a partial-flow pump, and flow rate regulators and measuring units.
 - 1.1.2. It is recommended that a particle size pre-classifier (e.g. cyclone or impactor) be employed upstream of the filter holder. However, a sampling probe, acting as an appropriate size-classification device such as that shown in Figure A4a.App4/13, is acceptable.
 - 1.2. General requirements
 - 1.2.1. The sampling probe for the test gas flow for particulates shall be so arranged within the dilution tract that a representative sample gas flow can be taken from the homogeneous air/exhaust mixture.
 - 1.2.2. The particulate sample flow rate shall be proportional to the total flow of diluted exhaust gas in the dilution tunnel to within a tolerance of ± 5 per cent of the particulate sample flow rate.
 - 1.2.3. The sampled dilute exhaust gas shall be maintained at a temperature below 325 K (52 °C) within 20 cm upstream or downstream of the particulate filter face, except in the case of a regeneration test where the temperature must be below 192 °C.
 - 1.2.4. The particulate sample shall be collected on a single filter mounted within a holder in the sampled dilute exhaust gas flow.
 - 1.2.5. All parts of the dilution system and the sampling system from the exhaust pipe up to the filter holder, which are in contact with raw and diluted exhaust gas, shall be designed to minimise deposition or alteration of the particulates. All parts shall be made of electrically conductive materials that do not react with exhaust gas components, and shall be electrically grounded to prevent electrostatic effects.
 - 1.2.6. If it is not possible to compensate for variations in the flow rate, provision shall be made for a heat exchanger and a temperature control device as specified in paragraph 1.3.5. of Appendix 2 to this annex so as to ensure that the flow rate in the system is constant and the sampling rate accordingly proportional.
 - 1.3. Specific requirements
 - 1.3.1. PM sampling probe
 - 1.3.1.1. The sample probe shall deliver the particle-size classification performance described in paragraph 1.3.1.4. It is recommended that this performance be achieved by the use of a sharp-edged, open-ended probe facing directly into the direction of flow plus a pre-classifier (cyclone impactor, etc.). An appropriate sampling probe, such as that indicated in Figure A4a.App4/13, may alternatively be used provided it achieves the pre-classification performance described in paragraph 1.3.1.4.

- 1.3.1.2. The sample probe shall be installed near the tunnel centreline, between 10 and 20 tunnel diameters downstream of the exhaust gas inlet to the tunnel and have an internal diameter of at least 12 mm.
- If more than one simultaneous sample is drawn from a single sample probe, the flow drawn from that probe shall be split into identical sub-flows to avoid sampling artefacts.
- If multiple probes are used, each probe shall be sharp-edged, open-ended and facing directly into the direction of flow. Probes shall be equally spaced around the central longitudinal axis of the dilution tunnel, with the spacing between probes at least 5 cm.
- 1.3.1.3. The distance from the sampling tip to the filter mount shall be at least five probe diameters, but shall not exceed 1,020 mm.
- 1.3.1.4. The pre-classifier (e.g. cyclone, impactor, etc.) shall be located upstream of the filter holder assembly. The pre-classifier 50 per cent cut point particle diameter shall be between 2.5 μm and 10 μm at the volumetric flow rate selected for sampling particulate mass emissions. The pre-classifier shall allow at least 99 per cent of the mass concentration of 1 μm particles entering the pre-classifier to pass through the exit of the pre-classifier at the volumetric flow rate selected for sampling particulate mass emissions. However, a sampling probe, acting as an appropriate size-classification device, such as that shown in Figure A4a.App3/13, is acceptable as an alternative to a separate pre-classifier.
- 1.3.2. Sample Pump and Flow Meter
- 1.3.2.1. The sample gas flow measurement unit shall consist of pumps, gas flow regulators and flow measuring units.
- 1.3.2.2. The temperature of the gas flow in the flow meter may not fluctuate by more than ± 3 K, except during regeneration tests on vehicles equipped with periodically regenerating after treatment devices. In addition, the sample mass flow rate must remain proportional to the total flow of diluted exhaust gas to within a tolerance of ± 5 per cent of the particulate sample mass flow rate. Should the volume of flow change unacceptably as a result of excessive filter loading, the test shall be stopped. When it is repeated, the rate of flow shall be decreased.
- 1.3.3. Filter and Filter Holder
- 1.3.3.1. A valve shall be located downstream of the filter in the direction of flow. The valve shall be quick enough acting to open and close within 1 s of the start and end of test.
- 1.3.3.2. It is recommended that the mass collected on the 47 mm diameter filter (P_e) is ≥ 20 μg and that the filter loading should be maximized consistent with the requirements of paragraphs 1.2.3., 1.3.2. and 1.3.3. of this appendix.
- 1.3.3.3. For a given test the gas filter face velocity shall be set to a single value within the range 20 cm/s to 80 cm/s unless the dilution system is being operated with sampling flow proportional to CVS flow rate.
- 1.3.3.4. Fluorocarbon coated glass fibre filters or fluorocarbon membrane filters are required. All filter types shall have a 0.3 μm DOP (dioctylphthalate) or PAO (poly-alpha-olefin) CS 68649-12-7 or CS 68037-01-4 collection efficiency of at least 99 per cent at a gas filter

face velocity of 5.33 cm/s measured according to one of the following standards:

- (a) U.S.A. Department of Defense Test Method Standard, MIL-STD-282 method 102.8: DOP-Smoke Penetration of Aerosol-Filter Element
- (b) U.S.A. Department of Defense Test Method Standard, MIL-STD-282 method 502.1.1: DOP-Smoke Penetration of Gas-Mask Canisters
- (c) Institute of Environmental Sciences and Technology, IEST-RP-CC021: Testing HEPA and ULPA Filter Media.

1.3.3.5. The filter holder assembly shall be of a design that provides an even flow distribution across the filter stain area. The filter stain area shall be at least 1,075 mm².

1.3.4. Filter Weighing Chamber and Balance

1.3.4.1. The microgram balance used to determine the weight of a filter shall have a precision (standard deviation) of 2 µg and resolution of 1 µg or better.

It is recommended that the microbalance be checked at the start of each weighing session by weighing one reference weight of 50 mg. This weight shall be weighed three times and the average result recorded. If the average result of the weighings is ±5 µg of the result from the previous weighing session then the weighing session and balance are considered valid.

The weighing chamber (or room) shall meet the following conditions during all filter conditioning and weighing operations:

Temperature maintained at 295 ± 3 K (22 ± 3 °C);

Relative humidity maintained at 45 ± 8 per cent;

Dewpoint maintained at 9.5 °C ± 3 °C.

It is recommended that temperature and humidity conditions are recorded along with sample and reference filter weights.

1.3.4.2. Buoyancy Correction

All filter weights shall be corrected for filter buoyancy in air.

The buoyancy correction depends on the density of the sample filter medium, the density of air, and the density of the calibration weight used to calibrate the balance. The density of the air is dependent on the pressure, temperature and humidity.

It is recommended that the temperature and dew point of the weighing environment are controlled to 22 °C ± 1 °C and dew point of 9.5 °C ± 1 °C respectively. However, the minimum requirements stated in paragraph 1.3.4.1. of this appendix will also result in an acceptable correction for buoyancy effects. The correction for buoyancy shall be applied as follows:

$$m_{corr} = m_{uncorr} \cdot \left(\frac{1 - \left(\frac{\rho_{air}}{\rho_{weight}} \right)}{1 - \left(\frac{\rho_{air}}{\rho_{media}} \right)} \right)$$

Where:

- m_{corr} = PM mass corrected for buoyancy
- m_{uncorr} = PM mass uncorrected for buoyancy
- ρ_{air} = density of air in balance environment
- ρ_{weight} = density of calibration weight used to span balance
- ρ_{media} = density of PM sample medium (filter) according to the table below:

Filter Medium	ρ_{media}
Teflon coated glass fibre (e.g. TX40)	2,300 kg/m ³

ρ_{air} can be calculated as follows:

$$\rho_{\text{air}} = \frac{P_{\text{abs}} \cdot M_{\text{mix}}}{R \cdot T_{\text{amb}}}$$

Where:

- P_{abs} = absolute pressure in balance environment,
- M_{mix} = molar mass of air in balance environment (28.836 gmol⁻¹),
- R = molar gas constant (8.314 Jmol⁻¹K⁻¹),
- T_{amb} = absolute ambient temperature of balance environment.

The chamber (or room) environment shall be free of any ambient contaminants (such as dust) that would settle on the particulate filters during their stabilisation.

Limited deviations from weighing room temperature and humidity specifications will be allowed provided their total duration does not exceed 30 minutes in any one filter conditioning period. The weighing room should meet the required specifications prior to personal entrance into the weighing room. During the weighing operation no deviations from the specified conditions are permitted.

1.3.4.3. The effects of static electricity shall be nullified. This may be achieved by grounding the balance through placement upon an antistatic mat and neutralisation of the particulate filters prior to weighing using a Polonium neutraliser or a device of similar effect. Alternatively nullification of static effects may be achieved through equalisation of the static charge.

1.3.4.4. A test filter shall be removed from the chamber no earlier than an hour before the test begins.

1.4. Recommended System Description

Figure A4a.App4/12 is a schematic drawing of the recommended particulate sampling system. Since various configurations can produce equivalent results, exact conformance with this figure is not required. Additional components such as instruments, valves, solenoids, pumps and switches may be used to provide additional information and coordinate the functions of component systems. Further components that are not needed to maintain accuracy with other system configurations

may be excluded if their exclusion is based upon good engineering judgement.

Figure A4a.App4/12
Particulate Sampling System

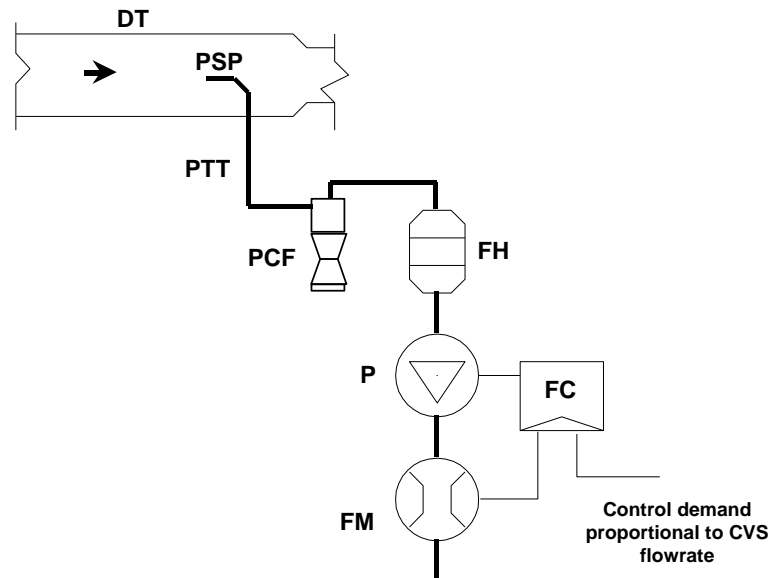

A sample of the diluted exhaust gas is taken from the full flow dilution tunnel DT through the particulate sampling probe PSP and the particulate transfer tube PTT by means of the pump P. The sample is passed through the particle size pre-classifier PCF and the filter holder(s) FH that contain the particulate sampling filter(s). The flow rate for sampling is set by the flow controller FC.

2. Calibration and verification procedures

2.1. Flow Meter Calibration

The Technical Service shall ensure the existence of a calibration certificate for the flow meter demonstrating compliance with a traceable standard within a 12 month period prior to the test, or since any repair or change which could influence calibration.

2.2. Microbalance Calibration

The Technical Service shall ensure the existence of a calibration certificate for the microbalance demonstrating compliance with a traceable standard within a 12 months period prior to the test.

2.3. Reference Filter Weighing

To determine the specific reference filter weights, at least two unused reference filters shall be weighed within 8 hours of, but preferably at the same time as, the sample filter weighings. Reference filters shall be of the same size and material as the sample filter.

If the specific weight of any reference filter changes by more than $\pm 5 \mu\text{g}$ between sample filter weighings, then the sample filter and reference filters shall be reconditioned in the weighing room and then reweighed.

The comparison of reference filter weighings shall be made between the specific weights and the rolling average of that reference filter's specific weights.

The rolling average shall be calculated from the specific weights collected in the period since the reference filters were placed in the weighing room. The averaging period shall be at least 1 day but not exceed 30 days.

Multiple reconditioning and reweighings of the sample and reference filters are permitted until a period of 80 h has elapsed following the measurement of gases from the emissions test.

If, prior to or at the 80 h point, more than half the number of reference filters meet the $\pm 5 \mu\text{g}$ criterion, then the sample filter weighing can be considered valid.

If, at the 80 h point, two reference filters are employed and one filter fails the $\pm 5 \mu\text{g}$ criterion, the sample filter weighing can be considered valid under the condition that the sum of the absolute differences between specific and rolling averages from the two reference filters must be less than or equal to $10 \mu\text{g}$.

In case less than half of the reference filters meet the $\pm 5 \mu\text{g}$ criterion the sample filter shall be discarded, and the emissions test repeated. All reference filters must be discarded and replaced within 48 hours.

In all other cases, reference filters must be replaced at least every 30 days and in such a manner that no sample filter is weighed without comparison to a reference filter that has been present in the weighing room for at least 1 day.

If the weighing room stability criteria outlined in paragraph 1.3.4. of this appendix are not met, but the reference filter weighings meet the above criteria, the vehicle manufacturer has the option of accepting the sample filter weights or voiding the tests, fixing the weighing room control system and re-running the test.

Figure A4a.App4/13
Particulate sampling probe configuration

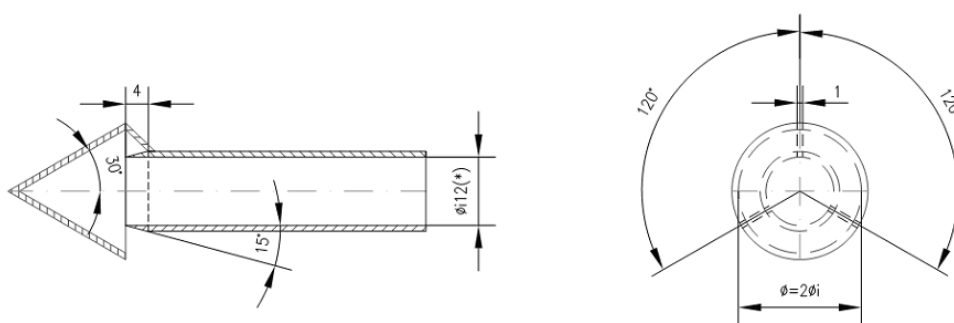

(*) Minimum internal diameter
Wall thickness ~ 1 mm - Material: stainless steel

Annex 4a -Appendix 5

Particle number emissions measurement equipment

1. Specification
 - 1.1. System overview
 - 1.1.1. The particle sampling system shall consist of a dilution tunnel, a sampling probe and a volatile particle remover (VPR) upstream of a particle number counter (PNC) and suitable transfer tubing.
 - 1.1.2. It is recommended that a particle size pre-classifier (e.g. cyclone, impactor etc.) be located prior to the inlet of the VPR. However, a sample probe acting as an appropriate size-classification device, such as that shown in Figure A4a.App4/13, is an acceptable alternative to the use of a particle size pre-classifier.
 - 1.2. General requirements
 - 1.2.1. The particle sampling point shall be located within a dilution tunnel.

The sampling probe tip (PSP) and particle transfer tube (PTT) together comprise the particle transfer system (PTS). The PTS conducts the sample from the dilution tunnel to the entrance of the VPR. The PTS shall meet the following conditions:

It shall be installed near the tunnel centre line, 10 to 20 tunnel diameters downstream of the gas inlet, facing upstream into the tunnel gas flow with its axis at the tip parallel to that of the dilution tunnel.

It shall have an internal diameter of ≥ 8 mm.

Sample gas drawn through the PTS shall meet the following conditions:

It shall have a flow Reynolds number (Re) of $< 1,700$;

It shall have a residence time in the PTS of ≤ 3 seconds.

Any other sampling configuration for the PTS for which equivalent particle penetration at 30 nm can be demonstrated will be considered acceptable.

The outlet tube (OT) conducting the diluted sample from the VPR to the inlet of the PNC shall have the following properties:

It shall have an internal diameter of ≥ 4 mm;

Sample Gas flow through the OT shall have a residence time of ≤ 0.8 seconds.

Any other sampling configuration for the OT for which equivalent particle penetration at 30 nm can be demonstrated will be considered acceptable.
 - 1.2.2. The VPR shall include devices for sample dilution and for volatile particle removal. The sampling probe for the test gas flow shall be so arranged within the dilution tract that a representative sample gas flow is taken from a homogeneous air/exhaust mixture.
 - 1.2.3. All parts of the dilution system and the sampling system from the exhaust pipe up to the PNC, which are in contact with raw and diluted exhaust gas, shall be designed to minimise deposition of the particles. All parts shall be made of electrically conductive materials that do not react with exhaust gas

- components, and shall be electrically grounded to prevent electrostatic effects.
- 1.2.4. The particle sampling system shall incorporate good aerosol sampling practice that includes the avoidance of sharp bends and abrupt changes in cross-section, the use of smooth internal surfaces and the minimisation of the length of the sampling line. Gradual changes in the cross-section are permissible.
- 1.3. Specific Requirements
- 1.3.1. The particle sample shall not pass through a pump before passing through the PNC.
- 1.3.2. A sample pre-classifier is recommended.
- 1.3.3. The sample preconditioning unit shall:
- 1.3.3.1. Be capable of diluting the sample in one or more stages to achieve a particle number concentration below the upper threshold of the single particle count mode of the PNC and a gas temperature below 35 °C at the inlet to the PNC;
- 1.3.3.2. Include an initial heated dilution stage which outputs a sample at a temperature of ≥ 150 °C and ≤ 400 °C and dilutes by a factor of at least 10;
- 1.3.3.3. Control heated stages to constant nominal operating temperatures, within the range specified in paragraph 1.3.3.2. of this appendix, to a tolerance of ± 10 °C. Provide an indication of whether or not heated stages are at their correct operating temperatures.
- 1.3.3.4. Achieve a particle concentration reduction factor ($f_r(d_i)$), as defined in paragraph 2.2.2. of this appendix, for particles of 30 nm and 50 nm electrical mobility diameters, that is no more than 30 per cent and 20 per cent respectively higher, and no more than 5 per cent lower than that for particles of 100 nm electrical mobility diameter for the VPR as a whole;
- 1.3.3.5. Also achieve > 99.0 per cent vaporisation of 30 nm tetracontane ($\text{CH}_3(\text{CH}_2)_{38}\text{CH}_3$) particles, with an inlet concentration of $\geq 10,000$ cm^{-3} , by means of heating and reduction of partial pressures of the tetracontane.
- 1.3.4. The PNC shall:
- 1.3.4.1. Operate under full flow operating conditions;
- 1.3.4.2. Have a counting accuracy of ± 10 per cent across the range 1 cm^{-3} to the upper threshold of the single particle count mode of the PNC against a traceable standard. At concentrations below 100 cm^{-3} measurements averaged over extended sampling periods may be required to demonstrate the accuracy of the PNC with a high degree of statistical confidence;
- 1.3.4.3. Have a readability of at least 0.1 particles cm^{-3} at concentrations below 100 cm^{-3} ;
- 1.3.4.4. Have a linear response to particle concentrations over the full measurement range in single particle count mode;
- 1.3.4.5. Have a data reporting frequency equal to or greater than 0.5 Hz;
- 1.3.4.6. Have a T90 response time over the measured concentration range of less than 5 s;
- 1.3.4.7. Incorporate a coincidence correction function up to a maximum 10 per cent correction, and may make use of an internal calibration factor as determined in paragraph 2.1.3., but shall not make use of any other algorithm to correct for or define the counting efficiency;

- 1.3.4.8. Have counting efficiencies at particle sizes of 23 nm (± 1 nm) and 41 nm (± 1 nm) electrical mobility diameter of 50 per cent (± 12 per cent) and > 90 per cent respectively. These counting efficiencies may be achieved by internal (for example; control of instrument design) or external (for example; size pre-classification) means;
- 1.3.4.9. If the PNC makes use of a working liquid, it shall be replaced at the frequency specified by the instrument manufacturer.
- 1.3.5. Where they are not held at a known constant level at the point at which PNC flow rate is controlled, the pressure and/or temperature at inlet to the PNC must be measured and reported for the purposes of correcting particle concentration measurements to standard conditions.
- 1.3.6. The sum of the residence time of the PTS, VPR and OT plus the T90 response time of the PNC shall be no greater than 20 s.
- 1.4. Recommended System Description

The following paragraph contains the recommended practice for measurement of particle number. However, any system meeting the performance specifications in paragraphs 1.2. and 1.3. of this appendix is acceptable.

Figure A4a.App5/14 is a schematic drawing of the recommended particle sampling system.

Figure A4a.App5/14

Schematic of Recommended Particle Sampling System

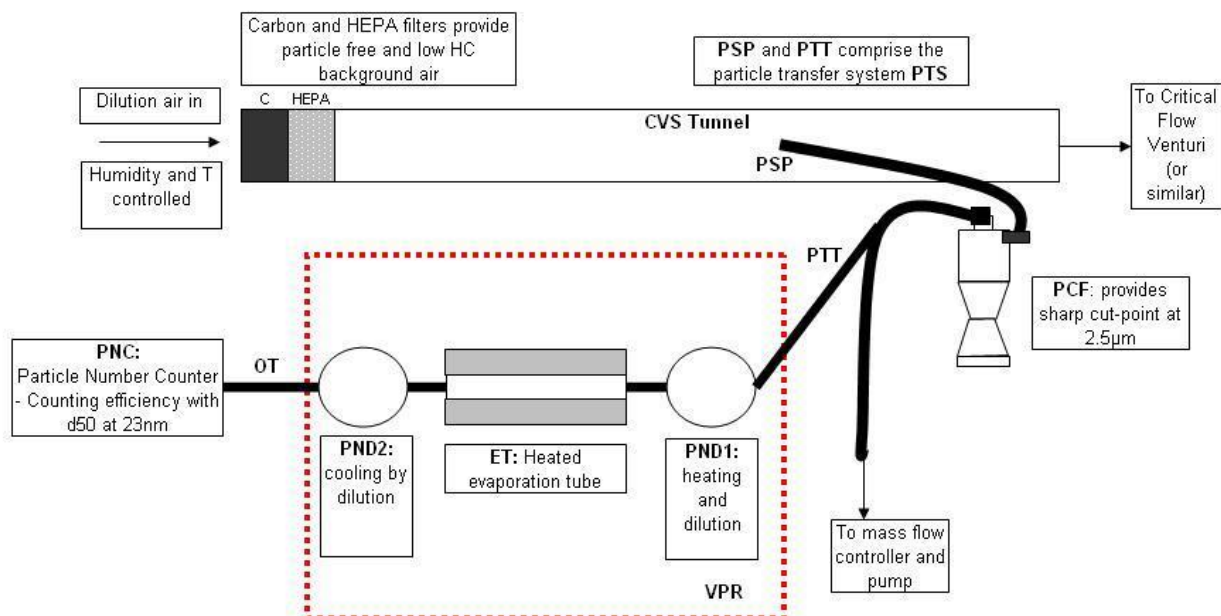

1.4.1. Sampling system description

The particle sampling system shall consist of a sampling probe tip in the dilution tunnel (PSP), a particle transfer tube (PTT), a particle pre-classifier (PCF) and a volatile particle remover (VPR) upstream of the particle number concentration measurement (PNC) unit. The VPR shall include devices for sample dilution (particle number diluters: PND₁ and PND₂) and particle evaporation (Evaporation tube, ET). The sampling probe for the test gas flow shall be so arranged within the dilution tract that a representative sample gas flow is taken from a homogeneous air/exhaust mixture. The sum of the residence time of the system plus the T90 response time of the PNC shall be no greater than 20 s.

1.4.2. Particle transfer system

The sampling probe tip (PSP) and particle transfer tube (PTT) together comprise the particle transfer system (PTS). The PTS conducts the sample from the dilution tunnel to the entrance to the first particle number diluter. The PTS shall meet the following conditions:

It shall be installed near the tunnel centre line, 10 to 20 tunnel diameters downstream of the gas inlet, facing upstream into the tunnel gas flow with its axis at the tip parallel to that of the dilution tunnel.

It shall have an internal diameter of ≥ 8 mm.

Sample gas drawn through the PTS shall meet the following conditions:

It shall have a flow Reynolds number (Re) of < 1.700 ;

It shall have a residence time in the PTS of ≤ 3 seconds.

Any other sampling configuration for the PTS for which equivalent particle penetration for particles of 30 nm electrical mobility diameter can be demonstrated will be considered acceptable.

The outlet tube (OT) conducting the diluted sample from the VPR to the inlet of the PNC shall have the following properties:

It shall have an internal diameter of ≥ 4 mm;

Sample gas flow through the POT shall have a residence time of ≤ 0.8 seconds.

Any other sampling configuration for the OT for which equivalent particle penetration for particles of 30 nm electrical mobility diameter can be demonstrated will be considered acceptable.

1.4.3. Particle pre-classifier

The recommended particle pre-classifier shall be located upstream of the VPR. The pre-classifier 50 per cent cut point particle diameter shall be between 2.5 μm and 10 μm at the volumetric flow rate selected for sampling particle number emissions. The pre-classifier shall allow at least 99 per cent of the mass concentration of 1 μm particles entering the pre-classifier to pass through the exit of the pre-classifier at the volumetric flow rate selected for sampling particle number emissions.

1.4.4. Volatile particle remover (VPR)

The VPR shall comprise one particle number diluter (PND₁), an evaporation tube and a second diluter (PND₂) in series. This dilution function is to reduce the number concentration of the sample entering the particle concentration measurement unit to less than the upper threshold of the single particle count mode of the PNC and to suppress nucleation within the sample. The VPR

shall provide an indication of whether or not PND₁ and the evaporation tube are at their correct operating temperatures.

The VPR shall achieve > 99.0 per cent vaporisation of 30 nm tetracontane (CH₃(CH₂)₃₈CH₃) particles, with an inlet concentration of $\geq 10,000 \text{ cm}^{-3}$, by means of heating and reduction of partial pressures of the tetracontane. It shall also achieve a particle concentration reduction factor (f_r) for particles of 30 nm and 50 nm electrical mobility diameters, that is no more than 30 per cent and 20 per cent respectively higher, and no more than 5 per cent lower than that for particles of 100 nm electrical mobility diameter for the VPR as a whole.

1.4.4.1. First Particle Number Dilution Device (PND₁)

The first particle number dilution device shall be specifically designed to dilute particle number concentration and operate at a (wall) temperature of 150 °C - 400 °C. The wall temperature setpoint should be held at a constant nominal operating temperature, within this range, to a tolerance of $\pm 10 \text{ °C}$ and not exceed the wall temperature of the ET (paragraph 1.4.4.2. of this appendix). The diluter should be supplied with HEPA filtered dilution air and be capable of a dilution factor of 10 to 200 times.

1.4.4.2. Evaporation Tube

The entire length of the ET shall be controlled to a wall temperature greater than or equal to that of the first particle number dilution device and the wall temperature held at a fixed nominal operating temperature between 300 °C and 400 °C, to a tolerance of $\pm 10 \text{ °C}$.

1.4.4.3. Second Particle Number Dilution Device (PND₂)

PND₂ shall be specifically designed to dilute particle number concentration. The diluter shall be supplied with HEPA filtered dilution air and be capable of maintaining a single dilution factor within a range of 10 to 30 times. The dilution factor of PND₂ shall be selected in the range between 10 and 15 such that particle number concentration downstream of the second diluter is less than the upper threshold of the single particle count mode of the PNC and the gas temperature prior to entry to the PNC is $< 35 \text{ °C}$.

1.4.5. Particle Number Counter (PNC)

The PNC shall meet the requirements of paragraph 1.3.4.

2. Calibration/validation of the particle sampling system¹

2.1. Calibration of the Particle Number Counter

2.1.1. The Technical Service shall ensure the existence of a calibration certificate for the PNC demonstrating compliance with a traceable standard within a 12 month period prior to the emissions test.

2.1.2. The PNC shall also be recalibrated and a new calibration certificate issued following any major maintenance.

¹ Example calibration/validation methods are available at <http://www.unece.org/trans/main/wp29/wp29wgs/wp29grpe/pmpFCP.html>.

- 2.1.3. Calibration shall be traceable to a standard calibration method:
- (a) By comparison of the response of the PNC under calibration with that of a calibrated aerosol electrometer when simultaneously sampling electrostatically classified calibration particles; or
 - (b) By comparison of the response of the PNC under calibration with that of a second PNC which has been directly calibrated by the above method.

In the electrometer case, calibration shall be undertaken using at least six standard concentrations spaced as uniformly as possible across the PNC's measurement range. These points will include a nominal zero concentration point produced by attaching HEPA filters of at least class H13 of EN 1822:2008, or equivalent performance, to the inlet of each instrument. With no calibration factor applied to the PNC under calibration, measured concentrations shall be within ± 10 per cent of the standard concentration for each concentration used, with the exception of the zero point, otherwise the PNC under calibration shall be rejected. The gradient from a linear regression of the two data sets shall be calculated and recorded. A calibration factor equal to the reciprocal of the gradient shall be applied to the PNC under calibration. Linearity of response is calculated as the square of the Pearson product moment correlation coefficient (R^2) of the two data sets and shall be equal to or greater than 0.97. In calculating both the gradient and R^2 the linear regression shall be forced through the origin (zero concentration on both instruments).

In the reference PNC case, calibration shall be undertaken using at least six standard concentrations across the PNC's measurement range. At least three points shall be at concentrations below $1,000 \text{ cm}^{-3}$, the remaining concentrations shall be linearly spaced between $1,000 \text{ cm}^{-3}$ and the maximum of the PNC's range in single particle count mode. These points will include a nominal zero concentration point produced by attaching HEPA filters of at least class H13 of EN 1822:2008, or equivalent performance, to the inlet of each instrument. With no calibration factor applied to the PNC under calibration, measured concentrations shall be within ± 10 per cent of the standard concentration for each concentration, with the exception of the zero point, otherwise the PNC under calibration shall be rejected. The gradient from a linear regression of the two data sets shall be calculated and recorded. A calibration factor equal to the reciprocal of the gradient shall be applied to the PNC under calibration. Linearity of response is calculated as the square of the Pearson product moment correlation coefficient (R^2) of the two data sets and shall be equal to or greater than 0.97. In calculating both the gradient and R^2 the linear regression shall be forced through the origin (zero concentration on both instruments).

- 2.1.4. Calibration shall also include a check, against the requirements in paragraph 1.3.4.8., on the PNC's detection efficiency with particles of 23 nm electrical mobility diameter. A check of the counting efficiency with 41 nm particles is not required.
- 2.2. Calibration/Validation of the Volatile Particle Remover
- 2.2.1. Calibration of the VPR's particle concentration reduction factors across its full range of dilution settings, at the instrument's fixed nominal operating temperatures, shall be required when the unit is new and following any major maintenance. The periodic validation requirement for the VPR's particle concentration reduction factor is limited to a check at a single setting, typical of that used for measurement on diesel particulate filter equipped vehicles. The Technical Service shall ensure the existence of a calibration or validation

certificate for the volatile particle remover within a 6 month period prior to the emissions test. If the volatile particle remover incorporates temperature monitoring alarms a 12 month validation interval shall be permissible.

The VPR shall be characterised for particle concentration reduction factor with solid particles of 30 nm, 50 nm and 100 nm electrical mobility diameter. Particle concentration reduction factors ($f_r(d)$) for particles of 30 nm and 50 nm electrical mobility diameters shall be no more than 30 per cent and 20 per cent higher respectively, and no more than 5 per cent lower than that for particles of 100 nm electrical mobility diameter. For the purposes of validation, the mean particle concentration reduction factor shall be within ± 10 per cent of the mean particle concentration reduction factor ($\overline{f_r}$) determined during the primary calibration of the VPR.

- 2.2.2. The test aerosol for these measurements shall be solid particles of 30, 50 and 100 nm electrical mobility diameter and a minimum concentration of 5,000 particles cm^{-3} at the VPR inlet. Particle concentrations shall be measured upstream and downstream of the components.

The particle concentration reduction factor at each particle size ($f_r(d_i)$) shall be calculated as follows;

$$f_r(d_i) = \frac{N_{in}(d_i)}{N_{out}(d_i)}$$

Where:

$N_{in}(d_i)$ = upstream particle number concentration for particles of diameter d_i ;

$N_{out}(d_i)$ = downstream particle number concentration for particles of diameter d_i ; and

d_i = particle electrical mobility diameter (30, 50 or 100 nm).

$N_{in}(d_i)$ and $N_{out}(d_i)$ shall be corrected to the same conditions.

The mean particle concentration reduction ($\overline{f_r}$) at a given dilution setting shall be calculated as follows;

$$\overline{f_r} = \frac{f_r(30\text{nm}) + f_r(50\text{nm}) + f_r(100\text{nm})}{3}$$

It is recommended that the VPR is calibrated and validated as a complete unit.

- 2.2.3. The Technical Service shall ensure the existence of a validation certificate for the VPR demonstrating effective volatile particle removal efficiency within a 6 month period prior to the emissions test. If the volatile particle remover incorporates temperature monitoring alarms a 12 month validation interval shall be permissible. The VPR shall demonstrate greater than 99.0 per cent removal of tetracontane ($\text{CH}_3(\text{CH}_2)_{38}\text{CH}_3$) particles of at least 30 nm electrical mobility diameter with an inlet concentration of $\geq 10,000 \text{ cm}^{-3}$ when operated at its minimum dilution setting and manufacturers recommended operating temperature.

2.3. Particle Number System Check Procedures

- 2.3.1. Prior to each test, the particle counter shall report a measured concentration of less than 0.5 particles cm^{-3} when a HEPA filter of at least class H13 of EN 1822:2008, or equivalent performance, is attached to the inlet of the entire particle sampling system (VPR and PNC).

- 2.3.2. On a monthly basis, the flow into the particle counter shall report a measured value within 5 per cent of the particle counter nominal flow rate when checked with a calibrated flow meter.
- 2.3.3. Each day, following the application of a HEPA filter of at least class H13 of EN 1822:2008, or equivalent performance, to the inlet of the particle counter, the particle counter shall report a concentration of $\leq 0.2 \text{ cm}^{-3}$. Upon removal of this filter, the particle counter shall show an increase in measured concentration to at least 100 particles cm^{-3} when challenged with ambient air and a return to $\leq 0.2 \text{ cm}^{-3}$ on replacement of the HEPA filter.
- 2.3.4. Prior to the start of each test, it shall be confirmed that the measurement system indicates that the evaporation tube, where featured in the system, has reached its correct operating temperature.
- 2.3.5. Prior to the start of each test, it shall be confirmed that the measurement system indicates that the diluter PND₁ has reached its correct operating temperature.

Annex 4a - Appendix 6

Verification of simulated inertia

1. Object

The method described in this appendix makes it possible to check that the simulated total inertia of the dynamometer is carried out satisfactorily in the running phase of the operating cycle. The manufacturer of the dynamometer shall specify a method for verifying the specifications according to paragraph 3. of this appendix.

2. Principle

2.1. Drawing-up working equations

Since the dynamometer is subjected to variations in the rotating speed of the roller(s), the force at the surface of the roller(s) can be expressed by the formula:

$$F = I \cdot \gamma = I_M \cdot \gamma + F_1$$

Where:

- F = force at the surface of the roller(s),
- I = total inertia of the dynamometer (equivalent inertia of the vehicle: see Table A4a/3 in this annex),
- I_M = inertia of the mechanical masses of the dynamometer,
- γ = tangential acceleration at roller surface,
- F_1 = inertia force.

Note: An explanation of this formula with reference to dynamometers with mechanically simulated inertia is appended.

Thus, total inertia is expressed as follows:

$$I = I_m + F_1 / \gamma$$

Where:

- I_m can be calculated or measured by traditional methods,
- F_1 can be measured on the dynamometer,
- γ can be calculated from the peripheral speed of the rollers.

The total inertia (I) will be determined during an acceleration or deceleration test with values higher than or equal to those obtained on an operating cycle.

2.2. Specification for the calculation of total inertia

The test and calculation methods shall make it possible to determine the total inertia I with a relative error ($\Delta I/I$) of less than ± 2 per cent.

3. Specification
- 3.1. The mass of the simulated total inertia I shall remain the same as the theoretical value of the equivalent inertia (see Table A4a/3) within the following limits:
 - 3.1.1. ± 5 per cent of the theoretical value for each instantaneous value;
 - 3.1.2. ± 2 per cent of the theoretical value for the average value calculated for each sequence of the cycle.

The limit given in paragraph 3.1.1. of this appendix is brought to ± 50 per cent for one second when starting and, for vehicles with manual transmission, for two seconds during gear changes.
4. Verification procedure
- 4.1. Verification is carried out during each test throughout the cycle defined in paragraph 6.1. of Annex 4a to this Regulation.
- 4.2. However, if the requirements of paragraph 3. are met, with instantaneous accelerations which are at least three times greater or smaller than the values obtained in the sequences of the theoretical cycle, the verification described above will not be necessary.

Annex 4a - Appendix 7

Measurement of vehicle road load

Resistance to progress of a vehicle measurement method on the road simulation on a chassis dynamometer

1. Object of the methods
The object of the methods defined below is to measure the resistance to progress of a vehicle at stabilized speeds on the road and to simulate this resistance on a dynamometer, in accordance with the conditions set out in paragraph 6.2.1. of Annex 4a to this Regulation.
2. Definition of the road
The road shall be level and sufficiently long to enable the measurements specified in this appendix to be made. The slope shall be constant to within ± 0.1 per cent and shall not exceed 1.5 per cent.
3. Atmospheric conditions
 - 3.1. Wind
Testing shall be limited to wind speeds averaging less than 3 m/s with peak speeds of less than 5 m/s. In addition, the vector component of the wind speed across the test road shall be less than 2 m/s. Wind velocity shall be measured 0.7 m above the road surface.
 - 3.2. Humidity
The road shall be dry.
 - 3.3. Pressure and Temperature
Air density at the time of the test shall not deviate by more than ± 7.5 per cent from the reference conditions, $P = 100$ kPa and $T = 293.2$ K.
4. Vehicle preparation¹
 - 4.1. Selection of the test vehicle
If not all variants of a vehicle type are measured, the following criteria for the selection of the test vehicle shall be used.
 - 4.1.1. Body
If there are different types of body, the test shall be performed on the least aerodynamic body. The manufacturer shall provide the necessary data for the selection.

¹ For HEV, and until uniform technical provisions have been established, the manufacturer will agree with the technical service concerning the status of the vehicle when performing the test as defined in this appendix.

- 4.1.2. Tyres
The widest tyre shall be chosen. If there are more than three tyre sizes, the widest minus one shall be chosen.
- 4.1.3. Testing mass
The testing mass shall be the reference mass of the vehicle with the highest inertia range.
- 4.1.4. Engine
The test vehicle shall have the largest heat exchanger(s).
- 4.1.5. Transmission
A test shall be carried out with each type of the following transmission:
Front-wheel drive,
Rear-wheel drive,
Full-time 4 x 4,
Part-time 4 x 4,
Automatic gearbox,
Manual gearbox.
- 4.2. Running-in
The vehicle shall be in normal running order and adjustment after having been run-in for at least 3,000 km. The tyres shall be run-in at the same time as the vehicle or have a tread depth within 90 and 50 per cent of the initial tread depth.
- 4.3. Verifications
The following checks shall be made in accordance with the manufacturer's specifications for the use considered:
Wheels, wheel trims, tyres (make, type, pressure), front axle geometry, brake adjustment (elimination of parasitic drag), lubrication of front and rear axles, adjustment of the suspension and vehicle level, etc.
- 4.4. Preparation for the test
- 4.4.1. The vehicle shall be loaded to its reference mass. The level of the vehicle shall be that obtained when the centre of gravity of the load is situated midway between the "R" points of the front outer seats and on a straight line passing through those points.
- 4.4.2. In the case of road tests, the windows of the vehicle shall be closed. Any covers of air climatisation systems, headlamps, etc. shall be in the non-operating position.
- 4.4.3. The vehicle shall be clean.
- 4.4.4. Immediately prior to the test, the vehicle shall be brought to normal running temperature in an appropriate manner.

5. Methods
- 5.1. Energy variation during coast-down method
- 5.1.1. On the road
- 5.1.1.1. Test equipment and error
- Time shall be measured to an error lower than ± 0.1 s.
- Speed shall be measured to an error lower than ± 2 per cent.
- 5.1.1.2. Test procedure
- 5.1.1.2.1. Accelerate the vehicle to a speed 10 km/h greater than the chosen test speed V.
- 5.1.1.2.2. Place the gearbox in "neutral" position.
- 5.1.1.2.3. Measure the time taken (t_1) for the vehicle to decelerate from speed $V_2 = V + \Delta V$ km/h to $V_1 = V - \Delta V$ km/h
- 5.1.1.2.4. Perform the same test in the opposite direction: t_2 .
- 5.1.1.2.5. Take the average T of the two times t_1 and t_2 .
- 5.1.1.2.6. Repeat these tests several times such that the statistical accuracy (p) of the average

$$T = \frac{1}{n} \sum_{i=1}^n T_i \text{ is not more than 2 per cent } (p \leq \square 2 \text{ per cent})$$

The statistical accuracy (p) is defined by:

$$p = \left(\frac{t \cdot s}{\sqrt{n}} \right) \cdot \frac{100}{T}$$

Where:

t = coefficient given by the following table,

n = number of tests,

s = standard deviation, $s = \sqrt{\frac{\sum_{i=1}^n (T_i - T)^2}{n - 1}}$

n	4	5	6	7	8	9	10	11	12	13	14	15
t	3.2	2.8	2.6	2.5	2.4	2.3	2.3	2.2	2.2	2.2	2.2	2.2
$\frac{t}{\sqrt{n}}$	1.6	1.25	1.06	0.94	0.85	0.77	0.73	0.66	0.64	0.61	0.59	0.57

- 5.1.1.2.7. Calculate the power by the formula:

$$P = \frac{M \cdot V \cdot \Delta V}{500 \cdot T}$$

Where:

- P is expressed in kW,
V = speed of the test in m/s,
 ΔV = speed deviation from speed V, in m/s as specified in paragraph 5.1.1.2.3. of this appendix,
M = reference mass in kg,
T = time in seconds (s).

- 5.1.1.2.8. The power (P) determined on the track shall be corrected to the reference ambient conditions as follows:

$$P_{\text{Corrected}} = K \cdot P_{\text{Measured}}$$

$$K = \frac{R_R}{R_T} \cdot [1 + K_R (t - t_0)] + \frac{R_{\text{AERO}}}{R_T} \cdot \frac{(\rho_0)}{\rho}$$

Where:

- R_R = rolling resistance at speed V,
 R_{AERO} = aerodynamic drag at speed V,
 R_T = total driving resistance = $R_R + R_{\text{AERO}}$,
 K_R = temperature correction factor of rolling resistance, taken to be equal to $8.64 \times 10^{-3}/^{\circ}\text{C}$, or the manufacturer's correction factor that is approved by the authority,
t = road test ambient temperature in $^{\circ}\text{C}$,
 t_0 = reference ambient temperature = 20°C ,
 ρ = air density at the test conditions,
 ρ_0 = air density at the reference conditions (20°C , 100 kPa).

The ratios R_R/R_T and R_{AERO}/R_T shall be specified by the vehicle manufacturer based on the data normally available to the company.

If these values are not available, subject to the agreement of the manufacturer and the technical service concerned, the figures for the rolling/ total resistance given by the following formula may be used:

$$\frac{R_R}{R_T} = a \cdot M + b$$

Where:

- M = vehicle mass in kg and for each speed the coefficients a and b are shown in the following table:

<i>V (km/h)</i>	<i>a</i>	<i>b</i>
20	$7.24 \cdot 10^{-5}$	0.82
40	$1.59 \cdot 10^{-4}$	0.54
60	$1.96 \cdot 10^{-4}$	0.33
80	$1.85 \cdot 10^{-4}$	0.23
100	$1.63 \cdot 10^{-4}$	0.18
120	$1.57 \cdot 10^{-4}$	0.14

- 5.1.2. On the dynamometer
- 5.1.2.1. Measurement equipment and accuracy
The equipment shall be identical to that used on the road.
- 5.1.2.2. Test procedure
- 5.1.2.2.1. Install the vehicle on the test dynamometer.
- 5.1.2.2.2. Adjust the tyre pressure (cold) of the driving wheels as required by the dynamometer.
- 5.1.2.2.3. Adjust the equivalent inertia of the dynamometer.
- 5.1.2.2.4. Bring the vehicle and dynamometer to operating temperature in a suitable manner.
- 5.1.2.2.5. Carry out the operations specified in paragraph 5.1.1.2. of this appendix (with the exception of paragraphs 5.1.1.2.4. and 5.1.1.2.5. of this appendix), replacing M by I in the formula set out in paragraph 5.1.1.2.7. of this appendix.
- 5.1.2.2.6. Adjust the brake to reproduce the corrected power (paragraph 5.1.1.2.8. of this appendix) and to take into account the difference between the vehicle mass (M) on the track and the equivalent inertia test mass (I) to be used. This may be done by calculating the mean corrected road coast down time from V_2 to V_1 and reproducing the same time on the dynamometer by the following relationship:
- $$T_{\text{corrected}} = \frac{T_{\text{measured}}}{K} \cdot \frac{I}{M}$$
- K = value specified in paragraph 5.1.1.2.8. above.
- 5.1.2.2.7. The power P_a to be absorbed by the dynamometer shall be determined in order to enable the same power (paragraph 5.1.1.2.8. of this appendix) to be reproduced for the same vehicle on different days.
- 5.2. Torque measurements method at constant speed
- 5.2.1. On the road
- 5.2.1.1. Measurement equipment and error
Torque measurement shall be carried out with an appropriate measuring device accurate to within ± 2 per cent.
Speed measurement shall be accurate to within ± 2 per cent.
- 5.2.1.2. Test procedure
- 5.2.1.2.1. Bring the vehicle to the chosen stabilized speed V.

5.2.1.2.2. Record the torque C_t and speed over a period of at least 20 seconds. The accuracy of the data recording system shall be at least ± 1 Nm for the torque and ± 0.2 km/h for the speed.

5.2.1.2.3. Differences in torque C_t and speed relative to time shall not exceed 5 per cent for each second of the measurement period.

5.2.1.2.4. The torque C_{t1} is the average torque derived from the following formula:

$$C_{t1} = \frac{1}{\Delta t} \int_t^{t+\Delta t} C(t) dt$$

5.2.1.2.5. The test shall be carried out three times in each direction. Determine the average torque from these six measurements for the reference speed. If the average speed deviates by more than 1 km/h from the reference speed, a linear regression shall be used for calculating the average torque.

5.2.1.2.6. Determine the average of these two torques C_{t1} and C_{t2} , i.e. C_t .

5.2.1.2.7. The average torque C_T determined on the track shall be corrected to the reference ambient conditions as follows:

$$C_{Tcorrected} = K \cdot C_{Tmeasured}$$

Where K has the value specified in paragraph 5.1.1.2.8. of this appendix.

5.2.2. On the dynamometer

5.2.2.1. Measurement equipment and error

The equipment shall be identical to that used on the road.

5.2.2.2. Test procedure

5.2.2.2.1. Perform the operations specified in paragraphs 5.1.2.2.1. to 5.1.2.2.4. of this appendix.

5.2.2.2.2. Perform the operations specified in paragraphs 5.2.1.2.1. to 5.2.1.2.4. of this appendix.

5.2.2.2.3. Adjust the power absorption unit to reproduce the corrected total track torque indicated in paragraph 5.2.1.2.7.

5.2.2.2.4. Proceed with the same operations as in paragraph 5.1.2.2.7. of this appendix, for the same purpose.

Annex 5

Type II test

(Carbon monoxide emission test at idling speed)

1. Introduction

This annex describes the procedure for the Type II test defined in paragraph 5.3.2. of this Regulation.
2. Conditions of measurement
 - 2.1. The fuel shall be the reference fuel, specifications for which are given in Annexes 10 and 10a to this Regulation.
 - 2.2. During the test, the environmental temperature shall be between 293 and 303 K (20 and 30 °C). The engine shall be warmed up until all temperatures of cooling and lubrication means and the pressure of lubrication means have reached equilibrium.
 - 2.2.1. Vehicles that are fuelled either with petrol or with LPG or NG/biomethane shall be tested with the reference fuel(s) used for the Type I Test.
 - 2.3. In the case of vehicles with manually-operated or semi-automatic-shift gearboxes, the test shall be carried out with the gear lever in the "neutral" position and with the clutch engaged.
 - 2.4. In the case of vehicles with automatic-shift gearboxes, the test shall be carried out with the gear selector in either the "neutral" or the "parking" position.
- 2.5. Components for adjusting the idling speed
 - 2.5.1. Definition

For the purposes of this Regulation, "*components for adjusting the idling speed*" means controls for changing the idling conditions of the engine which may be easily operated by a mechanic using only the tools described in paragraph 2.5.1.1. of this annex. In particular, devices for calibrating fuel and air flows are not considered as adjustment components if their setting requires the removal of the set-stops, an operation which cannot normally be performed except by a professional mechanic.

 - 2.5.1.1. Tools which may be used to control components for adjusting the idling speed: screwdrivers (ordinary or cross-headed), spanners (ring, open-end or adjustable), pliers, Allen keys.
 - 2.5.2. Determination of measurement points
 - 2.5.2.1. A measurement at the setting in accordance with the conditions fixed by the manufacturer is performed first;
 - 2.5.2.2. For each adjustment component with a continuous variation, a sufficient number of characteristic positions shall be determined.
 - 2.5.2.3. The measurement of the carbon-monoxide content of exhaust gases shall be carried out for all the possible positions of the adjustment components, but for components with a continuous variation only the positions defined in paragraph 2.5.2.2. of this annex shall be adopted.

- 2.5.2.4. The Type II test shall be considered satisfactory if one or both of the two following conditions is met:
- 2.5.2.4.1. None of the values measured in accordance with paragraph 2.5.2.3. of this annex exceed the limit values;
- 2.5.2.4.2. The maximum content obtained by continuously varying one of the adjustment components while the other components are kept stable does not exceed the limit value, this condition being met for the various combinations of adjustment components other than the one which was varied continuously.
- 2.5.2.5. The possible positions of the adjustment components shall be limited:
- 2.5.2.5.1. on the one hand, by the larger of the following two values: the lowest idling speed which the engine can reach; the speed recommended by the manufacturer, minus 100 revolutions per minute;
- 2.5.2.5.2. on the other hand, by the smallest of the following three values:
The highest speed the engine can attain by activation of the idling speed components;
The speed recommended by the manufacturer, plus 250 revolutions per minute;
The cut-in speed of automatic clutches.
- 2.5.2.6. In addition, settings incompatible with correct running of the engine shall not be adopted as measurement settings. In particular, when the engine is equipped with several carburettors all the carburettors shall have the same setting.
3. Sampling of gases
- 3.1. The sampling probe shall be inserted into the exhaust pipe to a depth of at least 300 mm into the pipe connecting the exhaust with the sampling bag and as close as possible to the exhaust.
- 3.2. The concentration in CO (C_{CO}) and CO₂ (C_{CO_2}) shall be determined from the measuring instrument readings or recordings, by use of appropriate calibration curves.
- 3.3. The corrected concentration for carbon monoxide regarding four-stroke engines is:
- $$C_{CO \text{ corr}} = C_{CO} \frac{15}{C_{CO} + C_{CO_2}} \quad (\text{per cent vol.})$$
- 3.4. The concentration in C_{CO} (see paragraph 3.2. of this annex) measured according to the formulae contained in paragraph 3.3. of this annex need not be corrected if the total of the concentrations measured ($C_{CO} + C_{CO_2}$) is for four-stroke engines at least:
- (a) For petrol 15 per cent
- (b) For LPG 13.5 per cent
- (c) For NG/biomethane 11.5 per cent

Annex 6

Type III test

(Verifying emissions of crankcase gases)

1. Introduction

This annex describes the procedure for the Type III Test defined in paragraph 5.3.3. of this Regulation.
2. General provisions
 - 2.1. The Type III test shall be carried out on a vehicle with positive- ignition engine, which has been, subjected to the Type I and the Type II test, as applicable.
 - 2.2. The engines tested shall include leak-proof engines other than those so designed that even a slight leak may cause unacceptable operating faults (such as flat-twin engines).
3. Test conditions
 - 3.1. Idling shall be regulated in conformity with the manufacturer's recommendations.
 - 3.2. The measurement shall be performed in the following three sets of conditions of engine operation:

<i>Condition Number</i>	<i>Vehicle speed (km/h)</i>
1	Idling
2	50 ±2 (in 3rd gear or "drive")
3	50 ±2 (in 3rd gear or "drive")

<i>Condition Number</i>	<i>Power absorbed by the brake</i>
1	Nil
2	That corresponding to the setting for Type I Test at 50 km/h
3	That for conditions No. 2, multiplied by a factor of 1.7

4. Test method
 - 4.1. For the operation conditions as listed in paragraph 3.2. of this annex, reliable function of the crankcase ventilation system shall be checked.
5. Method of verification of the crankcase ventilation system
 - 5.1. The engine's apertures shall be left as found.
 - 5.2. The pressure in the crankcase shall be measured at an appropriate location. It shall be measured at the dip-stick hole with an inclined-tube manometer.
 - 5.3. The vehicle shall be deemed satisfactory if, in every condition of measurement defined in paragraph 3.2. of this annex, the pressure measured

- in the crankcase does not exceed the atmospheric pressure prevailing at the time of measurement.
- 5.4. For the test by the method described above, the pressure in the intake manifold shall be measured to within ± 1 kPa.
- 5.5. The vehicle speed as indicated at the dynamometer shall be measured to within ± 2 km/h.
- 5.6. The pressure measured in the crankcase shall be measured to within ± 0.01 kPa.
- 5.7. If in one of the conditions of measurement defined in paragraph 3.2. of this annex, the pressure measured in the crankcase exceeds the atmospheric pressure, an additional test as defined in paragraph 6. of this annex shall be performed if so requested by the manufacturer.
6. Additional test method
- 6.1. The engine's apertures shall be left as found.
- 6.2. A flexible bag impervious to crankcase gases and having a capacity of approximately five litres shall be connected to the dipstick hole. The bag shall be empty before each measurement.
- 6.3. The bag shall be closed before each measurement. It shall be opened to the crankcase for five minutes for each condition of measurement prescribed in paragraph 3.2. of this annex.
- 6.4. The vehicle shall be deemed satisfactory if, in every condition of measurement defined in paragraph 3.2. of this annex, no visible inflation of the bag occurs.
- 6.5. Remark
- 6.5.1. If the structural layout of the engine is such that the test cannot be performed by the methods described in paragraphs 6.1. to 6.4. of this annex, the measurements shall be effected by that method modified as follows:
- 6.5.2. Before the test, all apertures other than that required for the recovery of the gases shall be closed;
- 6.5.3. The bag shall be placed on a suitable take-off which does not introduce any additional loss of pressure and is installed on the recycling circuit of the device directly at the engine-connection aperture (see diagram below).

Type III test

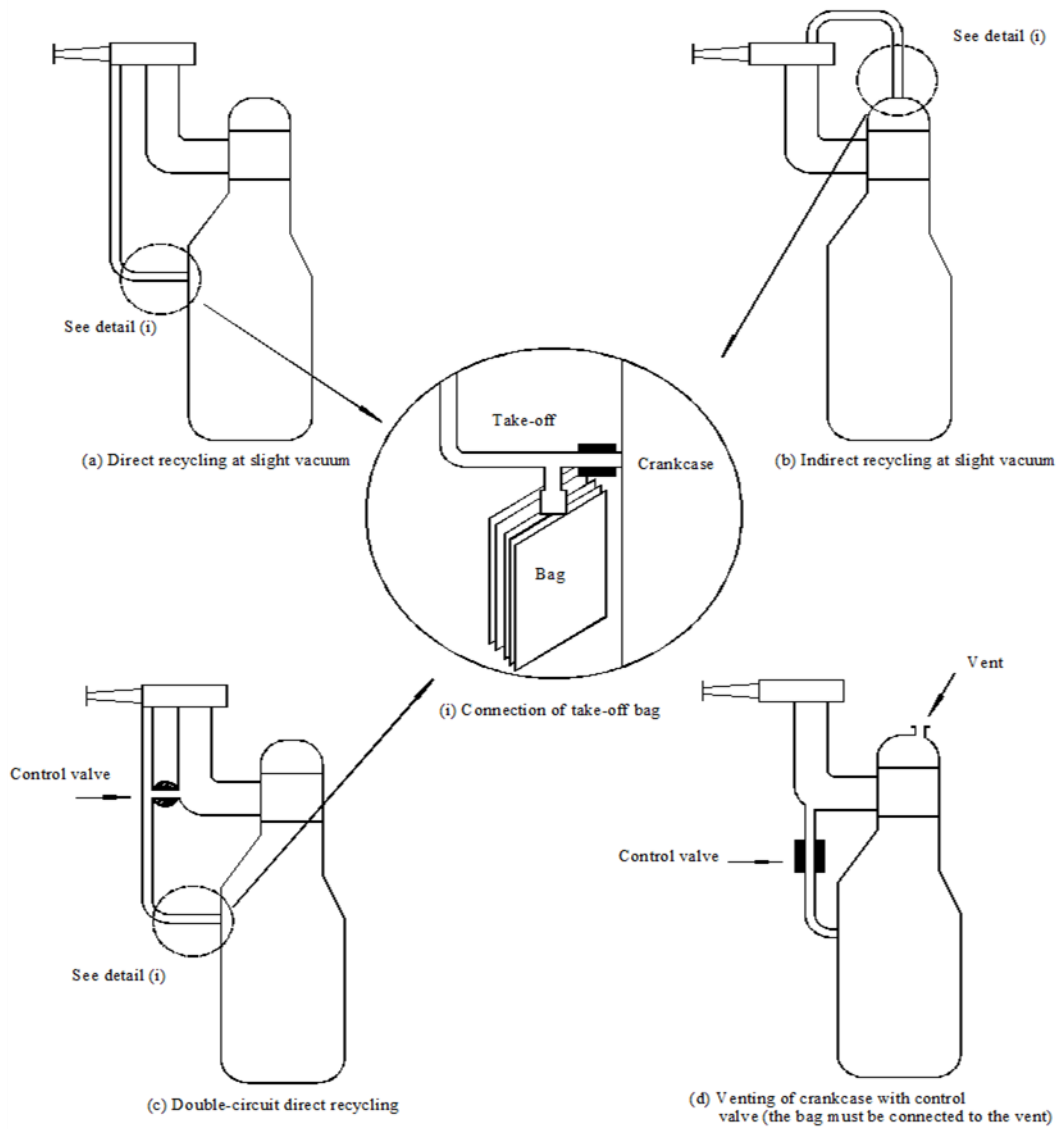

Annex 7

Type IV test

(Determination of evaporative emissions from vehicles with positive-ignition engines)

1. Introduction

This annex describes the procedure of the Type IV Test according to paragraph 5.3.4. of this Regulation.

This procedure describes a method for the determination of the loss of hydrocarbons by evaporation from the fuel systems of vehicles with positive-ignition engines.
2. Description of test

The evaporative emissions test (see Figure A7/1) is designed to determine hydrocarbon evaporative emissions as a consequence of diurnal temperatures fluctuation, hot soaks during parking, and urban driving. The test consists of these phases:

 - 2.1. Test preparation including an urban (Part One) and extra-urban (Part Two) driving cycle,
 - 2.2. Hot soak loss determination,
 - 2.3. Diurnal loss determination.

Mass emissions of hydrocarbons from the hot soak and the diurnal loss phases are added up to provide an overall result for the test.
3. Vehicle and fuel
 - 3.1. Vehicle
 - 3.1.1. The vehicle shall be in good mechanical condition and have been run in and driven at least 3,000 km before the test. The evaporative emission control system shall be connected and have been functioning correctly over this period and the carbon canister(s) shall have been subject to normal use, neither undergoing abnormal purging nor abnormal loading.
 - 3.2. Fuel
 - 3.2.1. The appropriate reference fuel shall be used, as defined in Annex 10 or Annex 10a to this Regulation.
4. Test equipment for evaporative test
 - 4.1. Chassis dynamometer

The chassis dynamometer shall meet the requirements of Appendix 1 to Annex 4a to this Regulation.
 - 4.2. Evaporative emission measurement enclosure

The evaporative emission measurement enclosure shall be a gas-tight rectangular measuring chamber able to contain the vehicle under test. The vehicle shall be accessible from all sides and the enclosure when sealed shall be gas-tight in accordance with Appendix 1 to this annex. The inner surface of the enclosure shall be impermeable and non-reactive to hydrocarbons. The temperature conditioning system shall be capable of controlling the internal

enclosure air temperature to follow the prescribed temperature versus time profile throughout the test, and an average tolerance of 1 K over the duration of the test.

The control system shall be tuned to provide a smooth temperature pattern that has a minimum of overshoot, hunting, and instability about the desired long-term ambient temperature profile. Interior surface temperatures shall not be less than 278 K (5 °C) nor more than 328 K (55 °C) at any time during the diurnal emission test.

Wall design shall be such as to promote good dissipation of heat. Interior surface temperatures shall not be below 293 K (20 °C), nor above 325 K (52 °C) for the duration of the hot soak rest.

To accommodate the volume changes due to enclosure temperature changes, either a variable-volume or fixed-volume enclosure may be used.

4.2.1. Variable-volume enclosure

The variable-volume enclosure expands and contracts in response to the temperature change of the air mass in the enclosure. Two potential means of accommodating the internal volume changes are movable panel(s), or a bellows design, in which an impermeable bag or bags inside the enclosure expand(s) and contract(s) in response to internal pressure changes by exchanging air from outside the enclosure. Any design for volume accommodation shall maintain the integrity of the enclosure as specified in Appendix 1 to this annex over the specified temperature range.

Any method of volume accommodation shall limit the differential between the enclosure internal pressure and the barometric pressure to a maximum value of ± 5 kPa.

The enclosure shall be capable of latching to a fixed volume. A variable volume enclosure shall be capable of accommodating a +7 per cent change from its "nominal volume" (see paragraph 2.1.1. of Appendix 1 to this annex), taking into account temperature and barometric pressure variation during testing.

4.2.2. Fixed-volume enclosure

The fixed-volume enclosure shall be constructed with rigid panels that maintain a fixed enclosure volume, and meet the requirements below.

4.2.2.1. The enclosure shall be equipped with an outlet flow stream that withdraws air at a low, constant rate from the enclosure throughout the test. An inlet flow stream may provide make-up air to balance the outgoing flow with incoming ambient air. Inlet air shall be filtered with activated carbon to provide a relatively constant hydrocarbon level. Any method of volume accommodation shall maintain the differential between the enclosure internal pressure and the barometric pressure between 0 and -5 kPa.

4.2.2.2. The equipment shall be capable of measuring the mass of hydrocarbon in the inlet and outlet flow streams with a resolution of 0.01 gram. A bag sampling system may be used to collect a proportional sample of the air withdrawn from and admitted to the enclosure. Alternatively, the inlet and outlet flow streams may be continuously analysed using an on-line FID analyser and integrated with the flow measurements to provide a continuous record of the mass hydrocarbon removal.

Figure A7/1
Determination of evaporative emissions
3000 km run-in period (no excessive purge/load)
Ageing of canister(s) verified
Steam-clean of vehicle (if necessary)

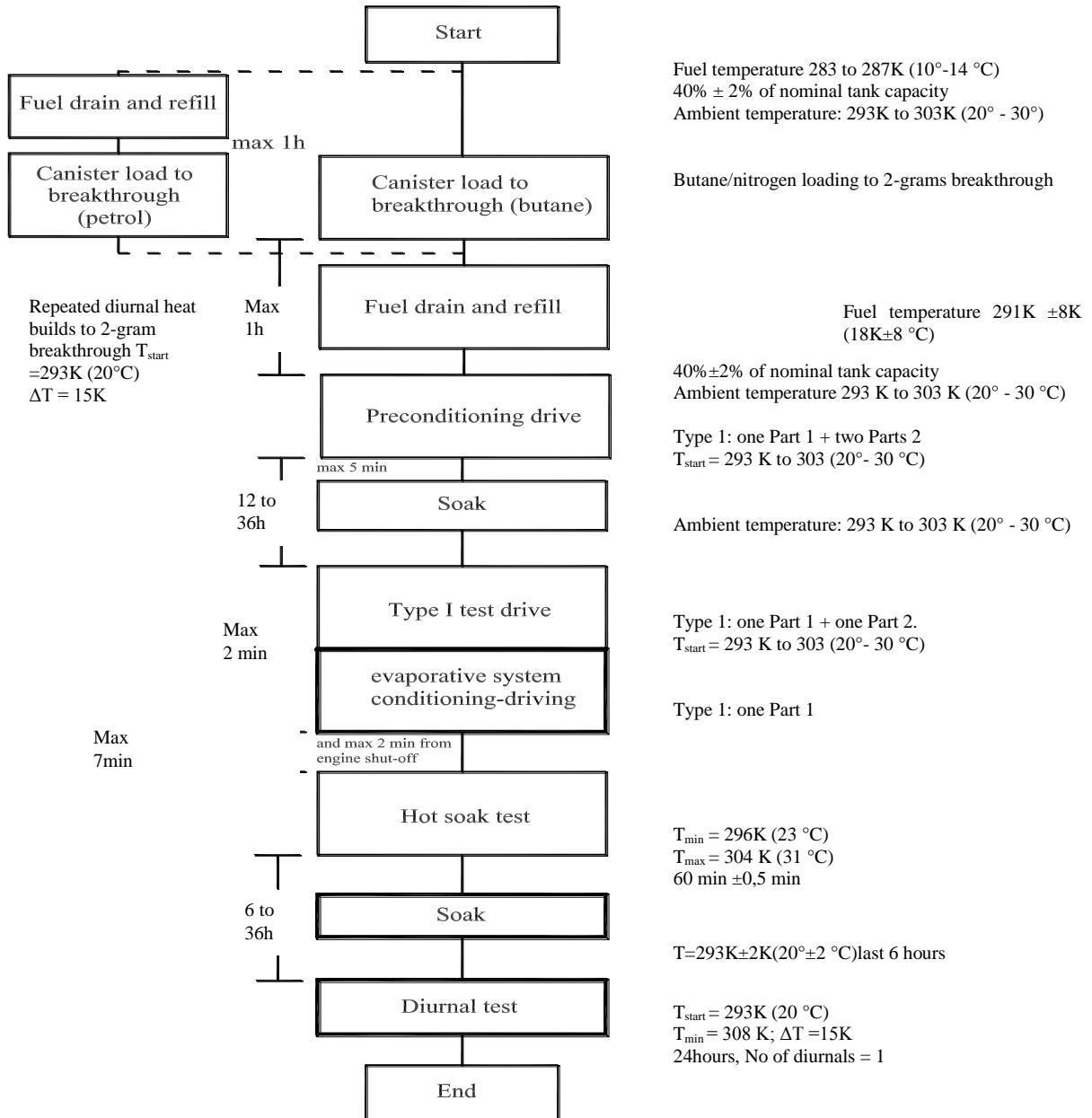

Notes:

1. Evaporative emission control families - details clarified.
2. Exhaust emissions may be measured during Type I test drive but these are not used for legislative purposes. Exhaust emission legislative test remains separate.

-
- 4.3. Analytical systems
 - 4.3.1. Hydrocarbon analyser
 - 4.3.1.1. The atmosphere within the chamber is monitored using a hydrocarbon detector of the flame ionisation detector (FID) type. Sample gas shall be drawn from the mid-point of one side wall or roof of the chamber and any bypass flow shall be returned to the enclosure, preferably to a point immediately downstream of the mixing fan.
 - 4.3.1.2. The hydrocarbon analyser shall have a response time to 90 per cent of final reading of less than 1.5 seconds. Its stability shall be better than 2 per cent of full scale at zero and at 80 ± 20 per cent of full scale over a 15-minute period for all operational ranges.
 - 4.3.1.3. The repeatability of the analyser expressed as one standard deviation shall be better than ± 1 per cent of full scale deflection at zero and at 80 ± 20 per cent of full scale on all ranges used.
 - 4.3.1.4. The operational ranges of the analyser shall be chosen to give best resolution over the measurement, calibration and leak checking procedures.
 - 4.3.2. Hydrocarbon analyser data recording system
 - 4.3.2.1. The hydrocarbon analyser shall be fitted with a device to record electrical signal output either by strip chart recorder or other data processing system at a frequency of at least once per minute. The recording system shall have operating characteristics at least equivalent to the signal being recorded and shall provide a permanent record of results. The record shall show a positive indication of the beginning and end of the hot soak or diurnal emission test (including beginning and end of sampling periods along with the time elapsed between start and completion of each test).
 - 4.4. Fuel tank heating (only applicable for gasoline canister load option)
 - 4.4.1. The fuel in the vehicle tank(s) shall be heated by a controllable source of heat; for example a heating pad of 2,000 W capacity is suitable. The heating system shall apply heat evenly to the tank walls beneath the level of the fuel so as not to cause local overheating of the fuel. Heat shall not be applied to the vapour in the tank above the fuel.
 - 4.4.2. The tank heating device shall make it possible to heat the fuel in the tank evenly by 14 K from 289 K (16 °C) within 60 minutes, with the temperature sensor position as in paragraph 5.1.1. of this annex . The heating system shall be capable of controlling the fuel temperature to ± 1.5 K of the required temperature during the tank heating process.
 - 4.5. Temperature recording
 - 4.5.1. The temperature in the chamber is recorded at two points by temperature sensors which are connected so as to show a mean value. The measuring points are extended approximately 0.1 m into the enclosure from the vertical centre line of each side wall at a height of 0.9 ± 0.2 m.
 - 4.5.2. The temperatures of the fuel tank(s) are recorded by means of the sensor positioned in the fuel tank as in paragraph 5.1.1. of this annex in the case of use of the gasoline canister load option (paragraph 5.1.5. of this annex).
 - 4.5.3. Temperatures shall, throughout the evaporative emission measurements, be recorded or entered into a data processing system at a frequency of at least once per minute.

- 4.5.4. The accuracy of the temperature recording system shall be within ± 1.0 K and the temperature shall be capable of being resolved to ± 0.4 K.
- 4.5.5. The recording or data processing system shall be capable of resolving time to ± 15 seconds.
- 4.6. Pressure recording
- 4.6.1. The difference Δp between barometric pressure within the test area and the enclosure internal pressure shall, throughout the evaporative emission measurements, be recorded or entered into a data processing system at a frequency of at least once per minute.
- 4.6.2. The accuracy of the pressure recording system shall be within ± 2 kPa and the pressure shall be capable of being resolved to ± 0.2 kPa.
- 4.6.3. The recording or data processing system shall be capable of resolving time to ± 15 seconds.
- 4.7. Fans
- 4.7.1. By the use of one or more fans or blowers with the SHED door(s) open it shall be possible to reduce the hydrocarbons concentration in the chamber to the ambient hydrocarbon level.
- 4.7.2. The chamber shall have one or more fans or blowers of like capacity 0.1 to 0.5 m³/min. with which to thoroughly mix the atmosphere in the enclosure. It shall be possible to attain an even temperature and hydrocarbon concentration in the chamber during measurements. The vehicle in the enclosure shall not be subjected to a direct stream of air from the fans or blowers.
- 4.8. Gases
- 4.8.1. The following pure gases shall be available for calibration and operation:
Purified synthetic air: (purity < 1 ppm C₁ equivalent,
 ≤ 1 ppm CO, ≤ 400 ppm CO₂, ≤ 0.1 ppm NO);
oxygen content between 18 and 21 per cent by volume.
Hydrocarbon analyser fuel gas: (40 \pm 2 per cent hydrogen, and balance helium with less than 1 ppm C₁ equivalent hydrocarbon, less than 400 ppm CO₂),
Propane (C₃H₈): 99.5 per cent minimum purity.
Butane (C₄H₁₀): 98 per cent minimum purity.
Nitrogen (N₂): 98 per cent minimum purity.
- 4.8.2. Calibration and span gases shall be available containing mixtures of propane (C₃H₈) and purified synthetic air. The true concentrations of a calibration gas shall be within 2 per cent of the stated figures. The accuracy of the diluted gases obtained when using a gas divider shall be to within ± 2 per cent of the true value. The concentrations specified in Appendix 1 to this annex may also be obtained by the use of a gas divider using synthetic air as the dilutant gas.
- 4.9. Additional equipment
- 4.9.1. The absolute humidity in the test area shall be measurable to within ± 5 per cent.

-
5. Test procedure
- 5.1. Test preparation
- 5.1.1. The vehicle is mechanically prepared before the test as follows:
- (a) The exhaust system of the vehicle shall not exhibit any leaks;
 - (b) The vehicle may be steam-cleaned before the test;
 - (c) In the case of use of the gasoline canister load option (paragraph 5.1.5. of this annex) the fuel tank of the vehicle shall be equipped with a temperature sensor to enable the temperature to be measured at the mid-point of the fuel in the fuel tank when filled to 40 per cent of its capacity;
 - (d) Additional fittings, adapters or devices may be fitted to the fuel system in order to allow a complete draining of the fuel tank. For this purpose it is not necessary to modify the shell of the tank;
 - (e) The manufacturer may propose a test method in order to take into account the loss of hydrocarbons by evaporation coming only from the fuel system of the vehicle.
- 5.1.2. The vehicle is taken into the test area where the ambient temperature is between 293 and 303 K (20 and 30 °C).
- 5.1.3. The ageing of the canister(s) has to be verified. This may be done by demonstrating that it has accumulated a minimum of 3,000 km. If this demonstration is not given, the following procedure is used. In the case of a multiple canister system each canister shall undergo the procedure separately.
- 5.1.3.1. The canister is removed from the vehicle. Special care shall be taken during this step to avoid damage to components and the integrity of the fuel system.
- 5.1.3.2. The weight of the canister shall be checked.
- 5.1.3.3. The canister is connected to a fuel tank, possibly an external one, filled with reference fuel, to 40 per cent volume of the fuel tank(s).
- 5.1.3.4. The fuel temperature in the fuel tank shall be between 183 K and 287 K (10 and 14 °C).
- 5.1.3.5. The (external) fuel tank is heated from 288 K to 318 K (15 to 45 °C) (1 °C increase every 9 minutes).
- 5.1.3.6. If the canister reaches breakthrough before the temperature reaches 318 K (45 °C), the heat source shall be turned off. Then the canister is weighed. If the canister did not reach breakthrough during the heating to 318 K (45 °C), the procedure from paragraph 5.1.3.3. of this annex shall be repeated until breakthrough occurs.
- 5.1.3.7. Breakthrough may be checked as described in paragraphs 5.1.5. and 5.1.6. of this annex, or with the use of another sampling and analytical arrangement capable of detecting the emission of hydrocarbons from the canister at breakthrough.
- 5.1.3.8. The canister shall be purged with 25 ±5 litres per minute with the emission laboratory air until 300 bed volume exchanges are reached.
- 5.1.3.9. The weight of the canister shall be checked.
- 5.1.3.10. The steps of the procedure in paragraphs 5.1.3.4. to 5.1.3.9. of this annex shall be repeated nine times. The test may be terminated prior to that, after

- not less than three ageing cycles, if the weight of the canister after the last cycles has stabilised.
- 5.1.3.11. The evaporative emission canister is reconnected and the vehicle restored to its normal operating condition.
- 5.1.4. One of the methods specified in paragraphs 5.1.5. and 5.1.6. of this annex shall be used to precondition the evaporative canister. For vehicles with multiple canisters, each canister shall be preconditioned separately.
- 5.1.4.1. Canister emissions are measured to determine breakthrough.
Breakthrough is here defined as the point at which the cumulative quantity of hydrocarbons emitted is equal to 2 grams.
- 5.1.4.2. Breakthrough may be verified using the evaporative emission enclosure as described in paragraphs 5.1.5. and 5.1.6. of this annex. Alternatively, breakthrough may be determined using an auxiliary evaporative canister connected downstream of the vehicle's canister. The auxiliary canister shall be well purged with dry air prior to loading.
- 5.1.4.3. The measuring chamber shall be purged for several minutes immediately before the test until a stable background is obtained. The chamber air mixing fan(s) shall be switched on at this time.
The hydrocarbon analyser shall be zeroed and spanned immediately before the test.
- 5.1.5. Canister loading with repeated heat builds to breakthrough
- 5.1.5.1. The fuel tank(s) of the vehicle(s) is (are) emptied using the fuel tank drain(s). This shall be done so as not to abnormally purge or abnormally load the evaporative control devices fitted to the vehicle. Removal of the fuel cap is normally sufficient to achieve this.
- 5.1.5.2. The fuel tank(s) is (are) refilled with test fuel at a temperature of between 283 K to 287 K (10 to 14 °C) to 40 ± 2 per cent of the tank's normal volumetric capacity. The fuel cap(s) of the vehicle shall be fitted at this point.
- 5.1.5.3. Within one hour of being refuelled the vehicle shall be placed, with the engine shut off, in the evaporative emission enclosure. The fuel tank temperature sensor is connected to the temperature recording system. A heat source shall be properly positioned with respect to the fuel tank(s) and connected to the temperature controller. The heat source is specified in paragraph 4.4. of this annex. In the case of vehicles fitted with more than one fuel tank, all the tanks shall be heated in the same way as described below. The temperatures of the tanks shall be identical to within ± 1.5 K.
- 5.1.5.4. The fuel may be artificially heated to the starting diurnal temperature of 293 K (20 °C) ± 1 K.
- 5.1.5.5. When the fuel temperature reaches at least 292 K (19 °C), the following steps shall be taken immediately: the purge blower shall be turned off; enclosure doors closed and sealed; and measurement initiated of the hydrocarbon level in the enclosure.
- 5.1.5.6. When the fuel temperature of the fuel tank reaches 293 K (20 °C) a linear heat build of 15 K (15 °C) begins. The fuel shall be heated in such a way that the temperature of the fuel during the heating conforms to the function below to within ± 1.5 K. The elapsed time of the heat build and temperature rise is recorded.

$$T_r = T_o + 0.2333 \cdot t$$

Where:

T_r = required temperature (K),

T_o = initial temperature (K),

t = time from start of the tank heat build in minutes.

- 5.1.5.7. As soon as break-through occurs or when the fuel temperature reaches 308 K (35 °C), whichever occurs first, the heat source is turned off, the enclosure doors unsealed and opened, and the vehicle fuel tank cap(s) removed. If break-through has not occurred by the time the fuel temperature 308 K (35 °C), the heat source is removed from the vehicle, the vehicle removed from the evaporative emission enclosure and the entire procedure outlined in paragraph 5.1.7. repeated until break-through occurs.
- 5.1.6. Butane loading to breakthrough
- 5.1.6.1. If the enclosure is used for the determination of the break-through (see paragraph 5.1.4.2. of this annex) the vehicle shall be placed, with the engine shut off, in the evaporative emission enclosure.
- 5.1.6.2. The evaporative emission canister shall be prepared for the canister loading operation. The canister shall not be removed from the vehicle, unless access to it in its normal location is so restricted that loading can only reasonably be accomplished by removing the canister from the vehicle. Special care shall be taken during this step to avoid damage to the components and the integrity of the fuel system.
- 5.1.6.3. The canister is loaded with a mixture composed of 50 per cent butane and 50 per cent nitrogen by volume at a rate of 40 grams butane per hour.
- 5.1.6.4. As soon as the canister reaches breakthrough, the vapour source shall be shut off.
- 5.1.6.5. The evaporative emission canister shall then be reconnected and the vehicle restored to its normal operating condition.
- 5.1.7. Fuel drain and refill
- 5.1.7.1. The fuel tank(s) of the vehicle(s) is (are) emptied using the fuel tank drain(s). This shall be done so as not to abnormally purge or abnormally load the evaporative control devices fitted to the vehicle. Removal of the fuel cap is normally sufficient to achieve this.
- 5.1.7.2. The fuel tank(s) is (are) refilled with test fuel at a temperature of between 291 ± 8 K (18 ± 8 °C) to 40 \pm 2 per cent of the tank's normal volumetric capacity. The fuel cap(s) of the vehicle shall be fitted at this point.
- 5.2. Preconditioning drive
- 5.2.1. Within one hour from the completing of canister loading in accordance with paragraphs 5.1.5. or 5.1.6. of this annex the vehicle is placed on the chassis dynamometer and driven through one Part One and two Part Two driving cycles of Type I Test as specified in Annex 4a to this Regulation. Exhaust emissions are not sampled during this operation.
- 5.3. Soak
- 5.3.1. Within five minutes of completing the preconditioning operation specified in paragraph 5.2.1. of this annex the engine bonnet shall be completely closed

and the vehicle driven off the chassis dynamometer and parked in the soak area. The vehicle is parked for a minimum of 12 hours and a maximum of 36 hours. The engine oil and coolant temperatures shall have reached the temperature of the area or within ± 3 K of it at the end of the period.

- 5.4. Dynamometer test
 - 5.4.1. After conclusion of the soak period the vehicle is driven through a complete Type I Test drive as described in Annex 4a to this Regulation (cold start urban and extra urban test). Then the engine is shut off. Exhaust emissions may be sampled during this operation but the results shall not be used for the purpose of exhaust emission type approval.
 - 5.4.2. Within two minutes of completing the Type I Test drive specified in paragraph 5.4.1. of this annex the vehicle is driven a further conditioning drive consisting of one urban test cycle (hot start) of a Type I Test. Then the engine is shut off again. Exhaust emissions need not be sampled during this operation.
- 5.5. Hot soak evaporative emissions test
 - 5.5.1. Before the completion of the test run the measuring chamber shall be purged for several minutes until a stable hydrocarbon background is obtained. The enclosure mixing fan(s) shall also be turned on at this time.
 - 5.5.2. The hydrocarbon analyser shall be zeroed and spanned immediately prior to the test.
 - 5.5.3. At the end of the driving cycle the engine bonnet shall be completely closed and all connections between the vehicle and the test stand disconnected. The vehicle is then driven to the measuring chamber with a minimum use of the accelerator pedal. The engine shall be turned off before any part of the vehicle enters the measuring chamber. The time at which the engine is switched off is recorded on the evaporative emission measurement data recording system and temperature recording begins. The vehicle's windows and luggage compartments shall be opened at this stage, if not already opened.
 - 5.5.4. The vehicle shall be pushed or otherwise moved into the measuring chamber with the engine switched off.
 - 5.5.5. The enclosure doors are closed and sealed gas-tight within two minutes of the engine being switched off and within seven minutes of the end of the conditioning drive.
 - 5.5.6. The start of a 60 ± 0.5 minute hot soak period begins when the chamber is sealed. The hydrocarbon concentration, temperature and barometric pressure are measured to give the initial readings C_{HCl} , P_i and T_i for the hot soak test. These figures are used in the evaporative emission calculation, paragraph 6.. The ambient temperature T of the enclosure shall not be less than 296 K and no more than 304 K during the 60-minute hot soak period.
 - 5.5.7. The hydrocarbon analyser shall be zeroed and spanned immediately before the end of the 60 ± 0.5 minute test period.
 - 5.5.8. At the end of the 60 ± 0.5 minute test period, the hydrocarbon concentration in the chamber shall be measured. The temperature and the barometric pressure are also measured. These are the final readings C_{HCl} , P_f and T_f for the hot soak test used for the calculation in paragraph 6..

- 5.6. Soak
- 5.6.1. The test vehicle shall be pushed or otherwise moved to the soak area without use of the engine and soaked for not less than 6 hours and not more than 36 hours between the end of the hot soak test and the start of the diurnal emission test. For at least 6 hours of this period the vehicle shall be soaked at 293 ± 2 K (20 ± 2 °C).
- 5.7. Diurnal test
- 5.7.1. The test vehicle shall be exposed to one cycle of ambient temperature according to the profile specified in Appendix 2 to this annex with a maximum deviation of ± 2 K at any time. The average temperature deviation from the profile, calculated using the absolute value of each measured deviation, shall not exceed ± 1 K. Ambient temperature shall be measured at least every minute. Temperature cycling begins when time $T_{\text{start}} = 0$, as specified in paragraph 5.7.6. of this annex.
- 5.7.2. The measuring chamber shall be purged for several minutes immediately before the test until a stable background is obtainable. The chamber mixing fan(s) shall also be switched on at this time.
- 5.7.3. The test vehicle, with the engine shut off and the test vehicle windows and luggage compartment(s) opened shall be moved into the measuring chamber. The mixing fan(s) shall be adjusted in such a way as to maintain a minimum air circulation speed of 8 km/h under the fuel tank of the test vehicle.
- 5.7.4. The hydrocarbon analyser shall be zeroed and spanned immediately before the test.
- 5.7.5. The enclosure doors shall be closed and gas-tight sealed.
- 5.7.6. Within 10 minutes of closing and sealing the doors, the hydrocarbon concentration, temperature and barometric pressure are measured to give the initial readings $C_{\text{HC},i}$, P_i and T_i for the diurnal test. This is the point where time $T_{\text{start}} = 0$.
- 5.7.7. The hydrocarbon analyser shall be zeroed and spanned immediately before the end of the test.
- 5.7.8. The end of the emission sampling period occurs 24 hours ± 6 minutes after the beginning of the initial sampling, as specified in paragraph 5.7.6. of this annex. The time elapsed is recorded. The hydrocarbon concentration, temperature and barometric pressure are measured to give the final readings $C_{\text{HC},f}$, P_f and T_f for the diurnal test used for the calculation in paragraph 6. of this annex This completes the evaporative emission test procedure.
6. Calculation
- 6.1. The evaporative emission tests described in paragraph 5. of this annex allow the hydrocarbon emissions from the diurnal and hot soak phases to be calculated. Evaporative losses from each of these phases is calculated using the initial and final hydrocarbon concentrations, temperatures and pressures in the enclosure, together with the net enclosure volume. The formula below is used:

$$M_{\text{HC}} = k \cdot V \cdot 10^{-4} \left(\frac{C_{\text{HC},f} \cdot P_f}{T_f} - \frac{C_{\text{HC},i} \cdot P_i}{T_i} \right) + M_{\text{HC,out}} - M_{\text{HC},i}$$

Where:

- M_{HC} = hydrocarbon mass in grams,
 $M_{HC,out}$ = mass of hydrocarbon exiting the enclosure, in the case of fixed-volume enclosures for diurnal emission testing (grams),
 $M_{HC,i}$ = mass of hydrocarbon entering the enclosure, in the case of fixed-volume enclosures for diurnal emission testing (grams),
 C_{HC} = measured hydrocarbon concentration in the enclosure (ppm volume in C₁ equivalent),
 V = net enclosure volume in cubic metres corrected for the volume of the vehicle, with the windows and the luggage compartment open. If the volume of the vehicle is not determined a volume of 1.42 m³ is subtracted,
 T = ambient chamber temperature, in K,
 P = barometric pressure in kPa,
 H/C = hydrogen to carbon ratio,
 k = $1.2 \cdot (12 + H/C)$;

Where:

- i = is the initial reading,
 f = is the final reading,
 H/C = is taken to be 2.33 for diurnal test losses,
 H/C = is taken to be 2.20 for hot soak losses.

6.2. Overall results of test

The overall hydrocarbon mass emission for the vehicle is taken to be:

$$M_{total} = M_{DI} + M_{HS}$$

Where:

- M_{total} = overall mass emissions of the vehicle (grams),
 M_{DI} = hydrocarbon mass emission for diurnal test (grams),
 M_{HS} = hydrocarbon mass emission for the hot soak (grams).

7. Conformity of production

7.1. For routine end-of-production-line testing, the holder of the approval may demonstrate compliance by sampling vehicles which shall meet the following requirements.

7.2. Test for leakage

7.2.1. Vents to the atmosphere from the emission control system shall be isolated.

7.2.2. A pressure of 370 ± 10 mm of H₂O shall be applied to the fuel system.

7.2.3. The pressure shall be allowed to stabilise prior to isolating the fuel system from the pressure source.

-
- 7.2.4. Following isolation of the fuel system, the pressure shall not drop by more than 50 mm of H₂O in five minutes.
- 7.3. Test for venting
- 7.3.1. Vents to the atmosphere from the emission control shall be isolated.
- 7.3.2. A pressure of 370 ± 10 mm of H₂O shall be applied to the fuel system.
- 7.3.3. The pressure shall be allowed to stabilise prior to isolating the fuel system from the pressure source.
- 7.3.4. The venting outlets from the emission control systems to the atmosphere shall be reinstated to the production condition.
- 7.3.5. The pressure of the fuel system shall drop to below 100 mm of H₂O in not less than 30 seconds but within two minutes.
- 7.3.6. At the request of the manufacturer the functional capacity for venting can be demonstrated by equivalent alternative procedure. The specific procedure should be demonstrated by the manufacturer to the technical service during the type approval procedure.
- 7.4. Purge test
- 7.4.1. Equipment capable of detecting an airflow rate of 1.0 litres in one minute shall be attached to the purge inlet and a pressure vessel of sufficient size to have negligible effect on the purge system shall be connected via a switching valve to the purge inlet, or alternatively.
- 7.4.2. The manufacturer may use a flow meter of his own choosing, if acceptable to the Type Approval Authority.
- 7.4.3. The vehicle shall be operated in such a manner that any design feature of the purge system that could restrict purge operation is detected and the circumstances noted.
- 7.4.4. Whilst the engine is operating within the bounds noted in paragraph 7.4.3. of this annex, the air flow shall be determined by either:
- 7.4.4.1. The device indicated in paragraph 7.4.1. of this annex being switched in. A pressure drop from atmospheric to a level indicating that a volume of 1.0 litres of air has flowed into the evaporative emission control system within one minute shall be observed; or
- 7.4.4.2. If an alternative flow measuring device is used, a reading of no less than 1.0 litre per minute shall be detectable.
- 7.4.4.3. At the request of the manufacturer an alternative purge test procedure can be used, if the procedure has been presented to and has been accepted by the technical service during the type approval procedure.
- 7.5. The Type Approval Authority which has granted type approval may at any time verify the conformity control methods applicable to each production unit.
- 7.5.1. The inspector shall take a sufficiently large sample from the series.
- 7.5.2. The inspector may test these vehicles by application of paragraph 7.1. of this annex.
- 7.6. If the requirements of paragraph 7.5. of this annex are not met, the Type Approval Authority shall ensure that all necessary steps are taken to re-establish conformity of production as rapidly as possible.

Annex 7 - Appendix 1

Calibration of equipment for evaporative emission testing

1. Calibration frequency and methods
 - 1.1. All equipment shall be calibrated before its initial use and then calibrated as often as necessary and in any case in the month before type approval testing. The calibration methods to be used are described in this appendix.
 - 1.2. Normally the series of temperatures which are mentioned first shall be used. The series of temperatures within square brackets may alternatively be used.
2. Calibration of the enclosure
 - 2.1. Initial determination of internal volume of the enclosure
 - 2.1.1. Before its initial use, the internal volume of the chamber shall be determined as follows:

The internal dimensions of the chamber are carefully measured, allowing for any irregularities such as bracing struts. The internal volume of the chamber is determined from these measurements.

For variable-volume enclosures, the enclosure shall be latched to a fixed volume when the enclosure is held at an ambient temperature of 303 K (30 °C) [(302 K (29 °C))]. This nominal volume shall be repeatable within ± 0.5 per cent of the reported value.
 - 2.1.2. The net internal volume is determined by subtracting 1.42 m³ from the internal volume of the chamber. Alternatively the volume of the test vehicle with the luggage compartment and windows open may be used instead of the 1.42 m³.
 - 2.1.3. The chamber shall be checked as in paragraph 2.3. of this appendix. If the propane mass does not correspond to the injected mass to within ± 2 per cent, then corrective action is required.
 - 2.2. Determination of chamber background emissions

This operation determines that the chamber does not contain any materials that emit significant amounts of hydrocarbons. The check shall be carried out at the enclosure's introduction to service, after any operations in the enclosure which may affect background emissions and at a frequency of at least once per year.

 - 2.2.1. Variable-volume enclosures may be operated in either latched or unlatched volume configuration, as described in paragraph 2.1.1. of this appendix, ambient temperatures shall be maintained at 308 K \pm 2 K. (35 \pm 2 °C) [309 K \pm 2 K (36 \pm 2 °C)], throughout the 4-hour period mentioned below.
 - 2.2.2. Fixed volume enclosures shall be operated with the inlet and outlet flow streams closed. Ambient temperatures shall be maintained at 308 K \pm 2 K (35 \pm 2 °C) [309 K \pm 2 K (36 \pm 2 °C) throughout the 4-hour period mentioned below.
 - 2.2.3. The enclosure may be sealed and the mixing fan operated for a period of up to 12 hours before the 4-hour background sampling period begins.
 - 2.2.4. The analyser (if required) shall be calibrated, then zeroed and spanned.

- 2.2.5. The enclosure shall be purged until a stable hydrocarbon reading is obtained, and the mixing fan turned on if not already on.
- 2.2.6. The chamber is then sealed and the background hydrocarbon concentration, temperature and barometric pressure are measured. These are the initial readings C_{HCl} , P_i , T_i used in the enclosure background calculation.
- 2.2.7. The enclosure is allowed to stand undisturbed with the mixing fan on for a period of four hours.
- 2.2.8. At the end of this time the same analyser is used to measure the hydrocarbon concentration in the chamber. The temperature and the barometric pressure are also measured. These are the final readings C_{HCl} , P_f , T_f .
- 2.2.9. The change in mass of hydrocarbons in the enclosure shall be calculated over the time of the test in accordance with paragraph 2.4. of this appendix and shall not exceed 0.05 g.
- 2.3. Calibration and hydrocarbon retention test of the chamber
- The calibration and hydrocarbon retention test in the chamber provides a check on the calculated volume in paragraph 2.1. of this appendix and also measures any leak rate. The enclosure leak rate shall be determined at the enclosure's introduction to service, after any operations in the enclosure which may affect the integrity of the enclosure, and at least monthly thereafter. If six consecutive monthly retention checks are successfully completed without corrective action, the enclosure leak rate may be determined quarterly thereafter as long as no corrective action is required.
- 2.3.1. The enclosure shall be purged until a stable hydrocarbon concentration is reached. The mixing fan is turned on, if not already switched on. The hydrocarbon analyser is zeroed, calibrated if required, and spanned.
- 2.3.2. On variable-volume enclosures, the enclosure shall be latched to the nominal volume position. On fixed-volume enclosures the outlet and inlet flow streams shall be closed.
- 2.3.3. The ambient temperature control system is then turned on (if not already on) and adjusted for an initial temperature of 308 K (35 °C) [309 K (36 °C)].
- 2.3.4. When the enclosure stabilises at $308 \text{ K} \pm 2 \text{ K}$ ($35 \pm 2 \text{ °C}$) [$309 \text{ K} \pm 2 \text{ K}$ ($36 \pm 2 \text{ °C}$)], the enclosure is sealed and the background concentration, temperature and barometric pressure measured. These are the initial readings C_{HCl} , P_i , T_i used in the enclosure calibration.
- 2.3.5. A quantity of approximately 4 grams of propane is injected into the enclosure. The mass of propane shall be measured to an accuracy and precision of ± 2 per cent of the measured value.
- 2.3.6. The contents of the chamber shall be allowed to mix for five minutes and then the hydrocarbon concentration, temperature and barometric pressure are measured. These are the readings C_{HCl} , P_f , T_f for the calibration of the enclosure as well as the initial readings C_{HCl} , P_i , T_i for the retention check.
- 2.3.7. Based on the readings taken according to paragraphs 2.3.4. and 2.3.6. and the formula in paragraph 2.4. of this appendix, the mass of propane in the enclosure is calculated. This shall be within ± 2 per cent of the mass of propane measured in paragraph 2.3.5. of this appendix.
- 2.3.8. For variable-volume enclosures the enclosure shall be unlatched from the nominal volume configuration. For fixed-volume enclosures, the outlet and inlet flow streams shall be opened.

- 2.3.9. The process is then begun of cycling the ambient temperature from 308 K (35 °C) to 293 K (20 °C) and back to 308 K (35 °C) [308.6 K (35.6 °C) to 295.2 K (22.2 °C) and back to 308.6 K (35.6 °C)] over a 24-hour period according to the profile [alternative profile] specified in Appendix 2 to this annex within 15 minutes of sealing the enclosure. (Tolerances as specified in paragraph 5.7.1. of this annex).
- 2.3.10. At the completion of the 24-hour cycling period, the final hydrocarbon concentration, temperature and barometric pressure are measured and recorded. These are the final readings $C_{HC,f}$, P_f , T_f for the hydrocarbon retention check.
- 2.3.11. Using the formula in paragraph 2.4. of this appendix, the hydrocarbon mass is then calculated from the readings taken in paragraphs 2.3.6. and 2.3.10. of this appendix. The mass may not differ by more than 3 per cent from the hydrocarbon mass given in paragraph 2.3.7. of this appendix.

2.4. Calculations

The calculation of net hydrocarbon mass change within the enclosure is used to determine the chamber's hydrocarbon background and leak rate. Initial and final readings of hydrocarbon concentration, temperature and barometric pressure are used in the following formula to calculate the mass change.

$$M_{HC} = k.V.10^{-4} \left(\frac{C_{HC,f} \cdot P_f}{T_f} - \frac{C_{HC,i} \cdot P_i}{T_i} \right) + M_{HC,out} - M_{HC,i}$$

Where:

- M_{HC} = hydrocarbon mass in grams,
 $M_{HC,out}$ = mass of hydrocarbons exiting the enclosure, in the case of fixed-volume enclosures for diurnal emission testing (grams),
 $M_{HC,i}$ = mass of hydrocarbons entering the enclosure when a fixed-volume enclosure is used for testing diurnal emissions (grams),
 C_{HC} = hydrocarbon concentration in the enclosure (ppm carbon (*Note:* ppm carbon = ppm propane x 3)),
 V = enclosure volume in cubic metres,
 T = ambient temperature in the enclosure, (K),
 P = barometric pressure, (kPa),
 K = 17.6;

Where:

- i is the initial reading,
 f is the final reading.

3. Checking of FID hydrocarbon analyzer

3.1. Detector response optimisation

The FID shall be adjusted as specified by the instrument manufacturer. Propane in air should be used to optimise the response on the most common operating range.

- 3.2. Calibration of the HC analyser
- The analyser should be calibrated using propane in air and purified synthetic air. See paragraph 3.2. of Appendix 3 to Annex 4a to this Regulation.
- Establish a calibration curve as described in paragraphs 4.1. to 4.5. of this appendix.
- 3.3. Oxygen interference check and recommended limits
- The response factor (Rf) for a particular hydrocarbon species is the ratio of the FID C1 reading to the gas cylinder concentration, expressed as ppm C1. The concentration of the test gas shall be at a level to give a response of approximately 80 per cent of full-scale deflection, for the operating range. The concentration shall be known, to an accuracy of ± 2 per cent in reference to a gravimetric standard expressed in volume. In addition the gas cylinder shall be preconditioned for 24 hours at a temperature between 293 K and 303 K (20 and 30 °C).
- Response factors should be determined when introducing an analyser into service and thereafter at major service intervals. The reference gas to be used is propane with balance purified air which is taken to give a response factor of 1.00.
- The test gas to be used for oxygen interference and the recommended response factor range are given below:
- Propane and nitrogen: $0.95 \leq Rf \leq 1.05$.
4. Calibration of the hydrocarbon analyzer
- Each of the normally used operating ranges are calibrated by the following procedure:
- 4.1. Establish the calibration curve by at least five calibration points spaced as evenly as possible over the operating range. The nominal concentration of the calibration gas with the highest concentrations to be at least 80 per cent of the full scale.
- 4.2. Calculate the calibration curve by the method of least squares. If the resulting polynomial degree is greater than 3, then the number of calibration points shall be at least the number of the polynomial degree plus 2.
- 4.3. The calibration curve shall not differ by more than 2 per cent from the nominal value of each calibration gas.
- 4.4. Using the coefficients of the polynomial derived from paragraph 3.2. of this appendix, a table of indicated reading against true concentration shall be drawn up in steps of no greater than 1 per cent of full scale. This is to be carried out for each analyser range calibrated. The table shall also contain other relevant data such as:
- (a) Date of calibration, span and zero potentiometer readings (where applicable);
 - (b) Nominal scale;
 - (c) Reference data of each calibration gas used;
 - (d) The actual and indicated value of each calibration gas used together with the percentage differences;
 - (e) FID fuel and type;

(f) FID air pressure.

- 4.5. If it can be shown to the satisfaction of the technical service that alternative technology (e.g. computer, electronically controlled range switch) can give equivalent accuracy, then those alternatives may be used.

Annex 7 - Appendix 2

<i>Diurnal ambient temperature profile for the calibration of the enclosure and the diurnal emission test</i>			<i>Alternative diurnal ambient temperature profile for the calibration of the enclosure in accordance with Annex 7, Appendix 1, paragraphs 1.2. and 2.3.9.</i>	
<i>Time (hours)</i>		<i>Temperature (°C_i)</i>	<i>Time (hours)</i>	<i>Temperature (°C_i)</i>
<i>Calibration</i>	<i>Test</i>			
13	0/24	20.0	0	35.6
14	1	20.2	1	35.3
15	2	20.5	2	34.5
16	3	21.2	3	33.2
17	4	23.1	4	31.4
18	5	25.1	5	29.7
19	6	27.2	6	28.2
20	7	29.8	7	27.2
21	8	31.8	8	26.1
22	9	33.3	9	25.1
23	10	34.4	10	24.3
24/0	11	35.0	11	23.7
1	12	34.7	12	23.3
2	13	33.8	13	22.9
3	14	32.0	14	22.6
4	15	30.0	15	22.2
5	16	28.4	16	22.5
6	17	26.9	17	24.2
7	18	25.2	18	26.8
8	19	24.0	19	29.6
9	20	23.0	20	31.9
10	21	22.0	21	33.9
11	22	20.8	22	35.1
12	23	20.2	23	3.4
			24	35.6

Annex 8

Type VI test

(Verifying the average exhaust emissions of carbon monoxide and hydrocarbons after a cold start at low ambient temperature)

1. Introduction

This annex applies only to vehicles with positive-ignition engines. It describes the equipment required and the procedure for the Type VI Test defined in paragraph 5.3.5. of this Regulation in order to verify the emissions of carbon monoxide and hydrocarbons at low ambient temperatures. Topics addressed in this Regulation include:

 - (a) Equipment requirements;
 - (b) Test conditions;
 - (c) Test procedures and data requirements.
2. Test equipment
 - 2.1. Summary
 - 2.1.1. This chapter deals with the equipment needed for low ambient temperature exhaust emission tests of positive-ignition engines. Equipment required and specifications are equivalent to the requirements for the Type I test as specified Annex 4a to this Regulation, with appendices, if specific requirements for the Type VI test are not prescribed. Paragraphs 2.2. to 2.6. of this annex describe deviations applicable to Type VI low ambient temperature testing.
 - 2.2. Chassis dynamometer
 - 2.2.1. The requirements of Appendix 1 to Annex 4a to this Regulation apply. The dynamometer shall be adjusted to simulate the operation of a vehicle on the road at 266 K (-7 °C). Such adjustment may be based on a determination of the road load force profile at 266 K (-7 °C). Alternatively the driving resistance determined according to Appendix 7 to Annex 4a to this Regulation may be adjusted for a 10 per cent decrease of the coast-down time. The technical service may approve the use of other methods of determining the driving resistance.
 - 2.2.2. For calibration of the dynamometer the provisions of Appendix 1 to Annex 4a to this Regulation apply.
 - 2.3. Sampling system
 - 2.3.1. The provisions of Appendix 2 and Appendix 3 to Annex 4a to this Regulation apply.
 - 2.4. Analytical equipment
 - 2.4.1. The provisions of Appendix 3 to Annex 4a to this Regulation apply, but only for carbon monoxide, carbon dioxide, and total hydrocarbon testing.
 - 2.4.2. For calibrations of the analytical equipment the provisions of Annex 4a to this Regulation apply.

-
- 2.5. Gases
 - 2.5.1. The provisions of paragraph 3. of Appendix 3 to Annex 4a to this Regulation apply, where they are relevant.
 - 2.6. Additional equipment
 - 2.6.1. For equipment used for the measurement of volume, temperature, pressure and humidity the provisions in paragraph 4.6. of Annex 4a to this Regulation apply.
 - 3. Test sequence and fuel
 - 3.1. General requirements
 - 3.1.1. The test sequence in Figure A8/1 shows the steps encountered as the test vehicle undergoes the procedures for the Type VI Test. Ambient temperature levels encountered by the test vehicle shall average: 266 K (-7 °C) \pm 3 K and shall not be less than 260 K (-13 °C), or more than 272 K (-1 °C).

The temperature may not fall below 263 K (-10 °C), or exceed 269 K (-4 °C) for more than three consecutive minutes.
 - 3.1.2. The test cell temperature monitored during testing shall be measured at the output of the cooling fan (paragraph 5.2.1. of this annex). The ambient temperature reported shall be an arithmetic average of the test cell temperatures measured at constant intervals no more than one minute apart.
 - 3.2. Test procedure

The Part One urban driving cycle according to Figure A4a/1 in Annex 4a to this Regulation, consists of four elementary urban cycles which together make a complete Part One cycle.
 - 3.2.1. Start of engine, start of the sampling and the operation of the first cycle shall be in accordance with Table 1 and Figure A4a/1 in Annex 4a to this Regulation.
 - 3.3. Preparation for the test
 - 3.3.1. For the test vehicle the provisions of paragraph 3.2. of Annex 4a to this Regulation apply. For setting the equivalent inertia mass on the dynamometer the provisions of paragraph 6.2.1. of Annex 4a to this Regulation apply.

Figure A8/1
Procedure for low ambient temperature test

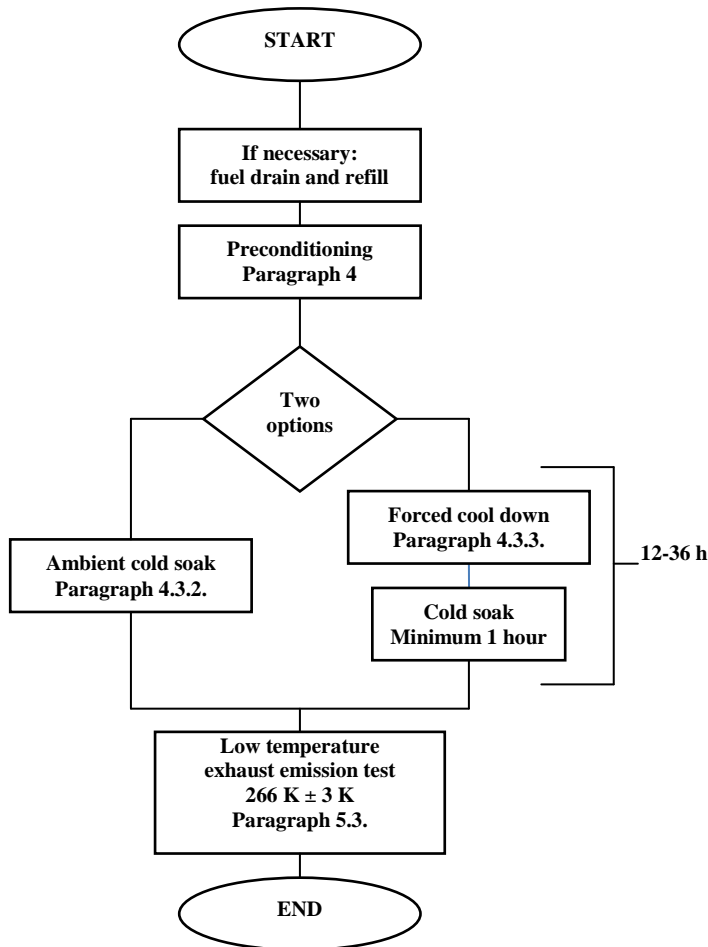

- 3.4. Test fuel
- 3.4.1. The test fuel must comply with the specifications given in paragraph 2. of Annex 10 to this Regulation.
- 4. Vehicle preconditioning
- 4.1. Summary
- 4.1.1. To ensure reproducible emission tests, the test vehicles shall be conditioned in a uniform manner. The conditioning consists of a preparatory drive on a chassis dynamometer followed by a soak period before the emission test according to paragraph 4.3. of this annex.
- 4.2. Preconditioning
- 4.2.1. The fuel tank(s) shall be filled with the specified test fuel. If the existing fuel in the fuel tank(s) does not meet the specifications contained in paragraph 3.4.1. of this annex, the existing fuel shall be drained prior to the fuel fill. The test fuel shall be at a temperature less than or equal to 289 K (+16 °C). For the above operations the evaporative emission control system shall neither be abnormally purged nor abnormally loaded.
- 4.2.2. The vehicle is moved to the test cell and placed on the chassis dynamometer.

- 4.2.3. The preconditioning consists of one complete driving cycle, Parts One and Two, according to Tables A4a/1 and A4a/2 and Figure A4a/1 of Annex 4a to this Regulation. At the request of the manufacturer, vehicles with a positive-ignition engine may be preconditioned with one Part One and two Part Two driving cycles.
- 4.2.4. During the preconditioning the test cell temperature shall remain relatively constant and not be higher than 303 K (30 °C)
- 4.2.5. The drive-wheel tyre pressure shall be set in accordance with the provisions of paragraph 6.2.3. of Annex 4a to this Regulation.
- 4.2.6. Within ten minutes of completion of the preconditioning, the engine shall be switched off.
- 4.2.7. If requested by the manufacturer and approved by the technical service, additional preconditioning may in exceptional cases be allowed. The technical service may also choose to conduct additional preconditioning. The additional preconditioning consists of one or more driving schedules of the Part One cycle as described in Table A4a/1 and Figure A4a/1 of Annex 4a to this Regulation. The extent of such additional preconditioning shall be recorded in the test report.
- 4.3. Soak methods
- 4.3.1. One of the following two methods, to be selected by the manufacturer, shall be utilised to stabilise the vehicle before the emission test.
- 4.3.2. Standard method
- The vehicle is stored for not less than 12 hours nor for more than 36 hours prior to the low ambient temperature exhaust emission test. The ambient temperature (dry bulb) during this period shall be maintained at an average temperature of:
- 266 K (-7 °C) \pm 3 K during each hour of this period and shall not be less than 260 K (-13 °C) nor more than 272 K (-1 °C). In addition, the temperature may not fall below 263 K (-10 °C) nor more than 269 K (-4 °C) for more than three consecutive minutes.
- 4.3.3. Forced method
- The vehicle shall be stored for not more than 36 hours prior to the low ambient temperature exhaust emission test.
- 4.3.3.1. The vehicle shall not be stored at ambient temperatures which exceed 303 K (30 °C) during this period.
- 4.3.3.2. Vehicle cooling may be accomplished by force-cooling the vehicle to the test temperature. If cooling is augmented by fans, the fans shall be placed in a vertical position so that the maximum cooling of the drive train and engine is achieved and not primarily the sump. Fans shall not be placed under the vehicle.
- 4.3.3.3. The ambient temperature need only be stringently controlled after the vehicle has been cooled to 266 K (-7 °C) \pm 2 K, as determined by a representative bulk oil temperature.
- A representative bulk oil temperature is the temperature of the oil measured near the middle of the oil sump, not at the surface or at the bottom of the oil sump. If two or more diverse locations in the oil are monitored, they shall all meet the temperature requirements.

- 4.3.3.4. The vehicle shall be stored for at least one hour after it has been cooled to 266 K (-7 °C) \pm 2 K, prior to the low ambient temperature exhaust emission test. The ambient temperature (dry bulb) during this period shall average 266 K (-7 °C) \pm 3 K, and shall not be less than 260 K (-13 °C) or more than 272 K (-1 °C),
- In addition, the temperature may not fall below 263 K (-10 °C) or exceed 269 K (-4 °C), for more than three consecutive minutes.
- 4.3.4. If the vehicle is stabilised at 266 K (-7 °C), in a separate area and is moved through a warm area to the test cell, the vehicle shall be destabilised in the test cell for at least six times the period the vehicle is exposed to warmer temperatures. The ambient temperature (dry bulb) during this period shall average 266 K (-7 °C) \pm 3 K and shall not be less than 260 K (-13 °C) nor more than 272 K (-1 °C).
- In addition, the temperature may not fall below 263 K (-10 °C) or exceed 269 K (-4 °C), for more than three consecutive minutes.
5. Dynamometer procedure
- 5.1. Summary
- 5.1.1. The emission sampling is performed over a test procedure consisting of the Part One cycle (Annex 4a to this Regulation, Table A4a/1 and Figure A4a/1). Engine start-up, immediate sampling, operation over the Part One cycle and engine shut-down make a complete low ambient temperature test, with a total test time of 780 seconds. The exhaust emissions are diluted with ambient air and a continuously proportional sample is collected for analysis. The exhaust gases collected in the bag are analysed for hydrocarbons, carbon monoxide, and carbon dioxide. A parallel sample of the dilution air is similarly analysed for carbon monoxide, total hydrocarbons and carbon dioxide.
- 5.2. Dynamometer operation
- 5.2.1. Cooling fan
- 5.2.1.1. A cooling fan is positioned so that cooling air is appropriately directed to the radiator (water cooling) or to the air intake (air-cooling) and to the vehicle.
- 5.2.1.2. For front-engined vehicles, the fan shall be positioned in front of the vehicle, within 300 mm of it. In the case of rear-engined vehicles or if the above arrangement is impractical, the cooling fan shall be positioned so that sufficient air is supplied to cool the vehicle.
- 5.2.1.3. The fan speed shall be such that, within the operating range of 10 km/h to at least 50 km/h, the linear velocity of the air at the blower outlet is within \pm 5 km/h of the corresponding roller speed. The final selection of the blower shall have the following characteristics:
- (a) Area: at least 0.2 m²;
 - (b) Height of the lower edge above ground: approximately 20 cm.
- As an alternative the blower linear air speed shall be at least 6 m/s (21.6 km/h). At the request of the manufacturer, for special vehicles (e.g. vans, off-road) the height of the cooling fan may be modified.
- 5.2.1.4. The vehicle speed as measured from the dynamometer roll(s) shall be used (paragraph 1.2.6. of Appendix 1 to Annex 4a to this Regulation).
- 5.2.2. *Reserved*

-
- 5.2.3. Preliminary testing cycles may be carried out if necessary, to determine how best to actuate the accelerator and brake controls so as to achieve a cycle approximating to the theoretical cycle within the prescribed limits, or to permit sampling system adjustment. Such driving shall be carried out before "START" according to Figure A8/1.
- 5.2.4. Humidity in the air shall be kept low enough to prevent condensation on the dynamometer roll(s).
- 5.2.5. The dynamometer shall be thoroughly warmed as recommended by the dynamometer manufacturer, and using procedures or control methods that assure stability of the residual frictional power.
- 5.2.6. The time between dynamometer warming and the start of the emission test shall be no longer than 10 minutes if the dynamometer bearings are not independently heated. If the dynamometer bearings are independently heated, the emission test shall begin no longer than 20 minutes after dynamometer warming.
- 5.2.7. If the dynamometer power is to be adjusted manually, it shall be set within one hour prior to the exhaust emission test phase. The test vehicle may not be used to make the adjustment. The dynamometer, using automatic control of pre-selectable power settings, may be set at any time prior to the beginning of the emission test.
- 5.2.8. Before the emission test driving schedule may begin, the test cell temperature shall be 266 K (-7 °C) ± 2 K, as measured in the air stream of the cooling fan with a maximum distance of 1.5 m from the vehicle.
- 5.2.9. During operation of the vehicle the heating and defrosting devices shall be shut off.
- 5.2.10. The total driving distance or roller revolutions measured are recorded.
- 5.2.11. A four-wheel drive vehicle shall be tested in a two-wheel drive mode of operation. The determination of the total road force for dynamometer setting is performed while operating the vehicle in its primary designed driving mode.
- 5.3. Performing the test
- 5.3.1. The provisions of paragraph 6.4., excluding 6.4.1.2., of Annex 4a to this Regulation apply in respect of starting the engine, carrying out the test and taking the emission samples. The sampling begins before or at the initiation of the engine start-up procedure and ends on conclusion of the final idling period of the last elementary cycle of the Part One (urban driving cycle), after 780 seconds.
- The first driving cycle starts with a period of 11 seconds idling as soon as the engine has started.
- 5.3.2. For the analysis of the sampled emissions the provisions of paragraph 6.5., excluding paragraph 6.5.2., of Annex 4a to this Regulation apply. In performing the exhaust sample analysis the technical service shall exercise care to prevent condensation of water vapour in the exhaust gas sampling bags.
- 5.3.3. For the calculations of the mass emissions the provisions of paragraph 6.6. of Annex 4a to this Regulation apply.
6. Other requirements
- 6.1. Irrational emission control strategy

- 6.1.1. Any irrational emission control strategy which results in a reduction in effectiveness of the emission control system under normal operating conditions at low temperature driving, so far as not covered by the standardised emission tests, may be considered a defeat device.

Annex 9

Type V test

(Description of the endurance test for verifying the durability of pollution control devices)

1. Introduction
 - 1.1. This annex described the test for verifying the durability of anti-pollution devices equipping vehicles with positive-ignition or compression-ignition engines. The durability requirements shall be demonstrated using one of the three options set out in paragraphs 1.2., 1.3. and 1.4. below.
 - 1.2. The whole vehicle durability test represents an ageing test of 160,000 km. This test is to be performed driven on a test track, on the road, or on a chassis dynamometer.
 - 1.3. The manufacturer may choose to use a bench ageing durability test. The technical requirements for this test are set out in paragraph 2.2. of this annex.
 - 1.4. As an alternative to durability testing, a manufacturer may choose to apply the assigned deterioration factors from Table 3 in paragraph 5.3.6.2. of this Regulation.
 - 1.5. At the request of the manufacturer, the technical service may carry out the Type I Test before the whole vehicle or bench ageing durability test has been completed using the assigned deterioration factors in Table 3 in paragraph 5.3.6.2. of this Regulation. On completion of the whole vehicle or bench ageing durability test, the technical service may then amend the type approval results recorded in Annex 2 to this Regulation by replacing the assigned deterioration factors in the above table with those measured in the whole vehicle or bench ageing durability test.
 - 1.6. Deterioration factors are determined using either the procedures set out in paragraphs 1.2. and 1.3. of this annex or using the assigned values in the table referred in paragraph 1.4. of this annex. The deterioration factors are used to establish compliance with the requirements of the appropriate emissions limits set out in Table 1 in paragraph 5.3.1.4. of this Regulation during the useful life of the vehicle.
2. Technical requirements
 - 2.1. As an alternative to the operating cycle described in paragraph 6.1. for the whole vehicle durability test, the vehicle manufacturer may use Standard Road Cycle (SRC) described in Appendix 3 to this annex. This test cycle shall be conducted until the vehicle has covered a minimum of 160,000 km.
 - 2.2. Bench ageing durability test
 - 2.2.1. In addition to the requirements for the bench ageing test set out in paragraph 1.3. of this annex, the technical requirements set out in this paragraph 2. shall apply.

The fuel to be used during the test shall be the one specified in paragraph 4.
 - 2.3. The bench ageing durability test to be used shall be the one appropriate to the type of engine, as detailed in paragraphs 2.3.1. and 2.3.2. of this annex.

2.3.1. Vehicles with Positive Ignition Engines

2.3.1.1. The following bench ageing procedure shall be applicable for positive-ignition vehicles including hybrid vehicles which use a catalyst as the principle after-treatment emission control device.

The bench ageing procedure requires the installation of the catalyst-plus-oxygen sensor system on a catalyst ageing bench.

Ageing on the bench shall be conducted by following the standard bench cycle (SBC) for the period of time calculated from the bench ageing time (BAT) equation. The BAT equation requires, as input, catalyst time-at-temperature data measured on the Standard Road Cycle (SRC), described in Appendix 3 of this annex.

2.3.1.2. Standard bench cycle (SBC). Standard catalyst bench ageing shall be conducted following the SBC. The SBC shall be run for the period of time calculated from the BAT equation. The SBC is described in Appendix 1 to this annex.

2.3.1.3. Catalyst time-at-temperature data. Catalyst temperature shall be measured during at least two full cycles of the SRC cycle as described in Appendix 3 to this annex.

Catalyst temperature shall be measured at the highest temperature location in the hottest catalyst on the test vehicle. Alternatively, the temperature may be measured at another location providing that it is adjusted to represent the temperature measured at the hottest location using good engineering judgement.

Catalyst temperature shall be measured at a minimum rate of one hertz (one measurement per second).

The measured catalyst temperature results shall be tabulated into a histogram with temperature groups of no larger than 25 °C.

2.3.1.4. Bench-ageing time. Bench ageing time shall be calculated using the bench ageing time (BAT) equation as follows:

te for a temperature bin = $th e^{((R/Tr)-(R/Tv))}$

Total te = Sum of te over all the temperature groups

Bench-Ageing Time = A (Total te)

Where:

A = 1.1 This value adjusts the catalyst ageing time to account for deterioration from sources other than thermal ageing of the catalyst.

R = Catalyst thermal reactivity = 17,500

th = The time (in hours) measured within the prescribed temperature bin of the vehicle's catalyst temperature histogram adjusted to a full useful life basis e.g., if the histogram represented 400 km, and useful life is 160,000 km; all histogram time entries would be multiplied by 400 (160,000/400).

Total te = The equivalent time (in hours) to age the catalyst at the temperature of Tr on the catalyst ageing bench using the catalyst ageing cycle to produce the same amount of deterioration experienced by the catalyst due to thermal deactivation over the 160,000 km.

- te for a bin = The equivalent time (in hours) to age the catalyst at the temperature of T_r on the catalyst ageing bench using the catalyst ageing cycle to produce the same amount of deterioration experienced by the catalyst due to thermal deactivation at the temperature bin of T_v over 160,000 km.
- T_r = The effective reference temperature (in K) of the catalyst on the catalyst bench run on the bench ageing cycle. The effective temperature is the constant temperature that would result in the same amount of ageing as the various temperatures experienced during the bench ageing cycle.
- T_v = The mid-point temperature (in K) of the temperature bin of the vehicle on-road catalyst temperature histogram.

2.3.1.5. Effective reference temperature on the SBC. The effective reference temperature of the standard bench cycle (SBC) shall be determined for the actual catalyst system design and actual ageing bench which will be used using the following procedures:

- (a) Measure time-at-temperature data in the catalyst system on the catalyst ageing bench following the SBC. Catalyst temperature shall be measured at the highest temperature location of the hottest catalyst in the system. Alternatively, the temperature may be measured at another location providing that it is adjusted to represent the temperature measured at the hottest location.

Catalyst temperature shall be measured at a minimum rate of one hertz (one measurement per second) during at least 20 minutes of bench ageing. The measured catalyst temperature results shall be tabulated into a histogram with temperature groups of no larger than 10 °C.

- (b) The BAT equation shall be used to calculate the effective reference temperature by iterative changes to the reference temperature (T_r) until the calculated ageing time equals or exceeds the actual time represented in the catalyst temperature histogram. The resulting temperature is the effective reference temperature on the SBC for that catalyst system and ageing bench.

2.3.1.6. Catalyst Ageing Bench. The catalyst ageing bench shall follow the SBC and deliver the appropriate exhaust flow, exhaust constituents, and exhaust temperature at the face of the catalyst.

All bench ageing equipment and procedures shall record appropriate information (such as measured A/F ratios and time-at-temperature in the catalyst) to assure that sufficient ageing has actually occurred.

2.3.1.7. Required Testing. For calculating deterioration factors at least two Type I tests before bench ageing of the emission control hardware and at least two Type I tests after the bench-aged emission hardware is reinstalled have to be performed on the test vehicle.

Additional testing may be conducted by the manufacturer. Calculation of the deterioration factors has to be done according to the calculation method as specified in paragraph 7. of this annex.

- 2.3.2. Vehicles with Compression Ignition Engines
- 2.3.2.1. The following bench ageing procedure is applicable for compression-ignition vehicles including hybrid vehicles.
- The bench ageing procedure requires the installation of the after-treatment system on an after-treatment system ageing bench.
- Ageing on the bench is conducted by following the standard diesel bench cycle (SDBC) for the number of regenerations/desulphurisations calculated from the bench ageing duration (BAD) equation.
- 2.3.2.2. Standard Diesel Bench Cycle (SDBC). Standard bench ageing is conducted following the SDBC. The SDBC shall be run for the period of time calculated from the bench ageing duration (BAD) equation. The SDBC is described in Appendix 2 to this annex.
- 2.3.2.3. Regeneration data. Regeneration intervals shall be measured during at least 10 full cycles of the SRC cycle as described in Appendix 3 to this annex. As an alternative the intervals from the K_i determination may be used.
- If applicable, desulphurisation intervals shall also be considered based on manufacturer's data.
- 2.3.2.4. Diesel bench-ageing duration. Bench ageing duration is calculated using the BAD equation as follows:
- Bench-Ageing Duration = number of regeneration and/or desulphurisation cycles (whichever is the longer) equivalent to 160,000 km of driving.
- 2.3.2.5. Ageing bench. The ageing bench shall follow the SDBC and deliver appropriate exhaust flow, exhaust constituents, and exhaust temperature to the after-treatment system inlet.
- The manufacturer shall record the number of regenerations/desulphurisations (if applicable) to assure that sufficient ageing has actually occurred.
- 2.3.2.6. Required testing. For calculating deterioration factors at least two Type I tests before bench ageing of the emission control hardware and at least two Type I tests after the bench-aged emission hardware is reinstalled have to be performed. Additional testing may be conducted by the manufacturer. Calculation of the deterioration factors shall be done according to the calculation method set out in paragraph 7. of this annex and with the additional requirements contained in this Regulation.
3. Test vehicle
- 3.1. The vehicle shall be in good mechanical order; the engine and the anti-pollution devices shall be new. The vehicle may be the same as that presented for the Type I test; this Type I test has to be done after the vehicle has run at least 3,000 km of the ageing cycle of paragraph 6.1. of this annex.
4. Fuel
- The durability test is conducted with a suitable commercially available fuel.
5. Vehicle maintenance and adjustments
- Maintenance, adjustments as well as the use of the test vehicle's controls shall be those recommended by the manufacturer.
6. Vehicle operation on track, road or on chassis dynamometer

- 6.1. Operating cycle
- During operation on track, road or on roller test bench, the distance shall be covered according to the driving schedule (Figure A9/1) described below:
- 6.1.1. The durability test schedule is composed of 11 cycles covering 6 kilometres each,
- 6.1.2. During the first nine cycles, the vehicle is stopped four times in the middle of the cycle, with the engine idling each time for 15 seconds,
- 6.1.3. Normal acceleration and deceleration,
- 6.1.4. Five decelerations in the middle of each cycle, dropping from cycle speed to 32 km/h, and the vehicle is gradually accelerated again until cycle speed is attained,
- 6.1.5. The 10th cycle is carried out at a steady speed of 89 km/h,
- 6.1.6. The 11th cycle begins with maximum acceleration from stop point up to 113 km/h. At half-way, braking is employed normally until the vehicle comes to a stop. This is followed by an idle period of 15 seconds and a second maximum acceleration.

The schedule is then restarted from the beginning.

The maximum speed of each cycle is given in Table A9/1.

Table A9/1

Maximum speed of each cycle

<i>Cycle</i>	<i>Cycle speed in km/h</i>
1	64
2	48
3	64
4	64
5	56
6	48
7	56
8	72
9	56
10	89
11	113

Figure A9/1
Driving schedule

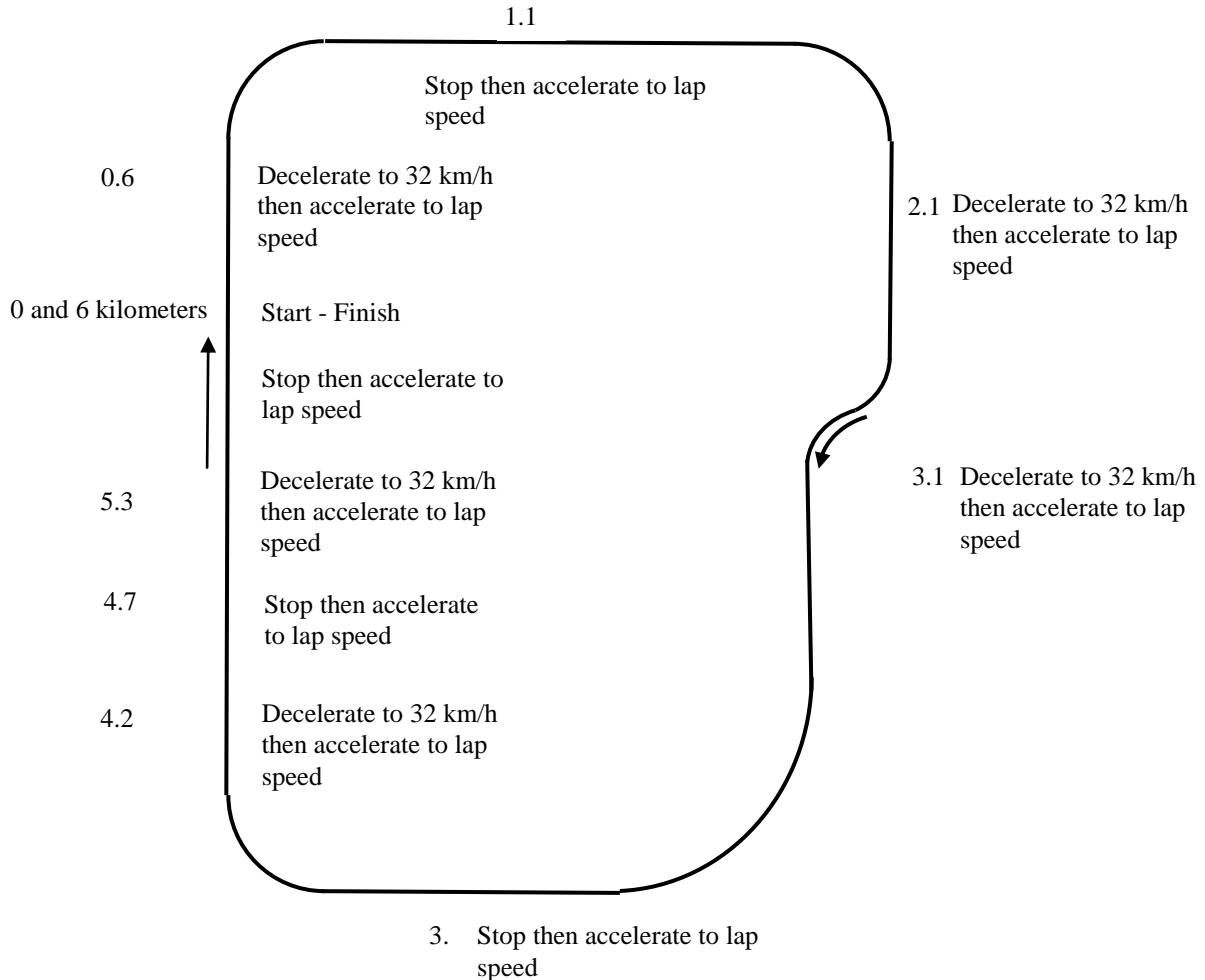

- 6.2. The durability test, or if the manufacturer has chosen, the modified durability test shall be conducted until the vehicle has covered a minimum of 160,000 km.
- 6.3. Test equipment
 - 6.3.1. Chassis dynamometer
 - 6.3.1.1. When the durability test is performed on a chassis dynamometer, the dynamometer shall enable the cycle described in paragraph 6.1. of this annex to be carried out. In particular, it shall be equipped with systems simulating inertia and resistance to progress.
 - 6.3.1.2. The brake shall be adjusted in order to absorb the power exerted on the driving wheels at a steady speed of 80 km/h. Methods to be applied to determine this power and to adjust the brake are the same as those described in Appendix 7 to Annex 4a to this Regulation.

- 6.3.1.3. The vehicle cooling system should enable the vehicle to operate at temperatures similar to those obtained on road (oil, water, exhaust system, etc.).
- 6.3.1.4. Certain other test bench adjustments and features are deemed to be identical, where necessary, to those described in Annex 4a to this Regulation (inertia, for example, which may be mechanical or electronic).
- 6.3.1.5. The vehicle may be moved, where necessary, to a different bench in order to conduct emission measurement tests.

6.3.2. Operation on track or road

When the durability test is completed on track or road, the vehicle's reference mass will be at least equal to that retained for tests conducted on a chassis dynamometer.

7. Measuring emissions of pollutants

At the start of the test (0 km), and every 10,000 km (± 400 km) or more frequently, at regular intervals until having covered 160,000 km, exhaust emissions are measured in accordance with the Type I Test as defined in paragraph 5.3.1. of this Regulation. The limit values to be complied with are those laid down in paragraph 5.3.1.4. of this Regulation.

In the case of vehicles equipped with periodically regenerating systems as defined in paragraph 2.20. of this Regulation, it shall be checked that the vehicle is not approaching a regeneration period. If this is the case, the vehicle must be driven until the end of the regeneration. If a regeneration occurs during the emissions measurement, a new test (including preconditioning) shall be performed, and the first result not taken into account.

All exhaust emissions results shall be plotted as a function of the running distance on the system rounded to the nearest kilometre and the best fit straight line fitted by the method of least squares shall be drawn through all these data points. This calculation shall not take into account the test results at 0 km.

The data will be acceptable for use in the calculation of the deterioration factor only if the interpolated 6,400 km and 160,000 km points on this line are within the above mentioned limits.

The data are still acceptable when a best fit straight line crosses an applicable limit with a negative slope (the 6,400 km interpolated point is higher than the 160,000 km interpolated point) but the 160,000 km actual data point is below the limit.

A multiplicative exhaust emission deterioration factor shall be calculated for each pollutant as follows:

$$D.E.F. = \frac{Mi_2}{Mi_1}$$

Where:

Mi_1 = mass emission of the pollutant i in g/km interpolated to 6,400 km,

Mi_2 = mass emission of the pollutant i in g/km interpolated to 160,000 km.

These interpolated values shall be carried out to a minimum of four places to the right of the decimal point before dividing one by the other to determine the deterioration factor. The result shall be rounded to three places to the right of the decimal point.

If a deterioration factor is less than one, it is deemed to be equal to one.

At the request of a manufacturer, an additive exhaust emission deterioration factor shall be calculated for each pollutant as follows:

$$D . E . F . = M_{i_2} - M_{i_1}$$

Annex 9 - Appendix 1

Standard Bench Cycle (SBC)

1. Introduction

The standard ageing durability procedure consists of ageing a catalyst/oxygen sensor system on an ageing bench which follows the standard bench cycle (SBC) described in this Appendix. The SBC requires the use of an ageing bench with an engine as the source of feed gas for the catalyst. The SBC is a 60-second cycle which is repeated as necessary on the ageing bench to conduct ageing for the required period of time. The SBC is defined based on the catalyst temperature, engine air/fuel (A/F) ratio, and the amount of secondary air injection which is added in front of the first catalyst.
2. Catalyst Temperature Control
 - 2.1. Catalyst temperature shall be measured in the catalyst bed at the location where the highest temperature occurs in the hottest catalyst. Alternatively, the feed gas temperature may be measured and converted to catalyst bed temperature using a linear transform calculated from correlation data collected on the catalyst design and ageing bench to be used in the ageing process.
 - 2.2. Control the catalyst temperature at stoichiometric operation (01 to 40 seconds on the cycle) to a minimum of 800 °C ($\pm 10^\circ$ C) by selecting the appropriate engine speed, load, and spark timing for the engine. Control the maximum catalyst temperature that occurs during the cycle to 890 °C ($\pm 10^\circ$ C) by selecting the appropriate A/F ratio of the engine during the "rich" phase described in Table A9.App1/2.
 - 2.3. If a low control temperature other than 800 °C is utilized, the high control temperature shall be 90 °C higher than the low control temperature.

Table A9.App1/2

Standard Bench Cycle (SBC)

<i>Time (seconds)</i>	<i>Engine Air/Fuel Ratio</i>	<i>Secondary Air Injection</i>
1-40	Stoichiometric with load, spark timing and engine speed controlled to achieve a minimum catalyst temperature of 800 °C	None
41-45	"Rich" (A/F ratio selected to achieve a maximum catalyst temperature over the entire cycle of 890 °C or 90 °C higher than lower control temperature)	None
46-55	"Rich" (A/F ratio selected to achieve a maximum catalyst temperature over the entire cycle of 890 °C or 90 °C higher than lower control temperature)	3 % ($\pm 1\%$)
56-60	Stoichiometric with load, spark timing and engine speed controlled to achieve a minimum catalyst temperature of 800 °C	3 % ($\pm 1\%$)

Figure A9.App1/2
Standard Bench Cycle

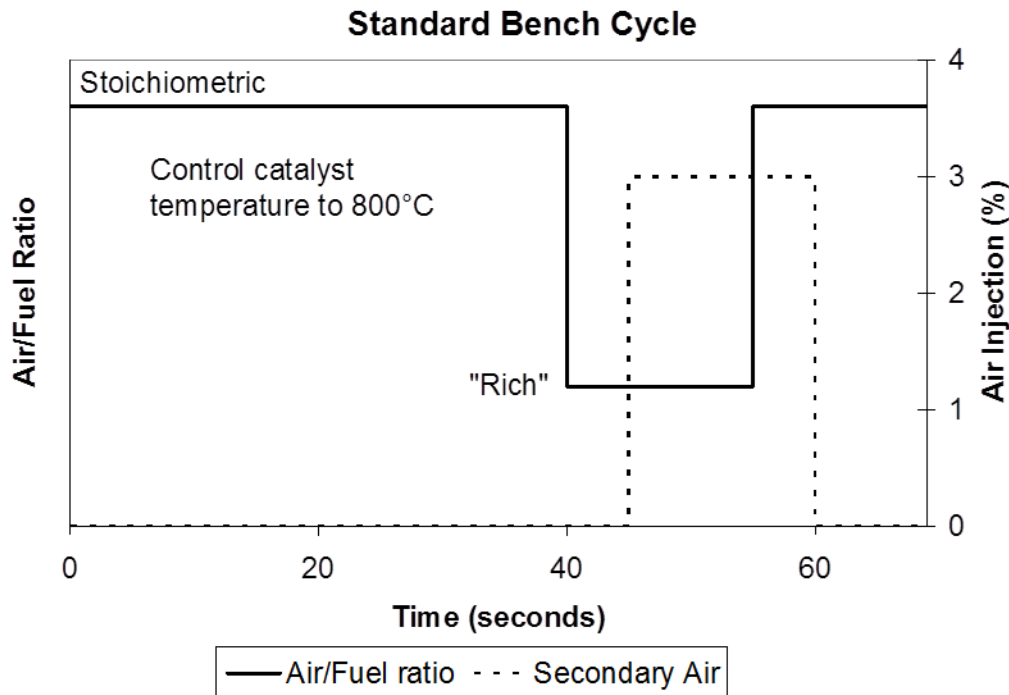

3. Ageing Bench Equipment and Procedures
- 3.1. Ageing Bench Configuration. The ageing bench shall provide the appropriate exhaust flow rate, temperature, air-fuel ratio, exhaust constituents and secondary air injection at the inlet face of the catalyst.

The standard ageing bench consists of an engine, engine controller, and engine dynamometer. Other configurations may be acceptable (e.g. whole vehicle on a dynamometer, or a burner that provides the correct exhaust conditions), as long as the catalyst inlet conditions and control features specified in this appendix are met.

A single ageing bench may have the exhaust flow split into several streams providing that each exhaust stream meets the requirements of this appendix. If the bench has more than one exhaust stream, multiple catalyst systems may be aged simultaneously.

- 3.2. Exhaust System Installation. The entire catalyst(s)-plus-oxygen sensor(s) system, together with all exhaust piping which connects these components, will be installed on the bench. For engines with multiple exhaust streams (such as some V6 and V8 engines), each bank of the exhaust system will be installed separately on the bench in parallel.

For exhaust systems that contain multiple in-line catalysts, the entire catalyst system including all catalysts, all oxygen sensors and the associated exhaust piping will be installed as a unit for ageing. Alternatively, each individual catalyst may be separately aged for the appropriate period of time.

- 3.3. Temperature Measurement. Catalyst temperature shall be measured using a thermocouple placed in the catalyst bed at the location where the highest temperature occurs in the hottest catalyst. Alternatively, the feed gas

temperature just before the catalyst inlet face may be measured and converted to catalyst bed temperature using a linear transform calculated from correlation data collected on the catalyst design and ageing bench to be used in the ageing process. The catalyst temperature shall be stored digitally at the speed of 1 hertz (one measurement per second).

- 3.4. Air/Fuel measurement. Provisions shall be made for the measurement of the air/fuel (A/F) ratio (such as a wide-range oxygen sensor) as close as possible to the catalyst inlet and outlet flanges. The information from these sensors shall be stored digitally at the speed of 1 hertz (one measurement per second).

- 3.5. Exhaust flow balance. Provisions shall be made to assure that the proper amount of exhaust (measured in grams/second at stoichiometry, with a tolerance of ± 5 grams/second) flows through each catalyst system that is being aged on the bench.

The proper flow rate is determined based upon the exhaust flow that would occur in the original vehicle's engine at the steady state engine speed and load selected for the bench ageing in paragraph 3.6..

- 3.6. Setup. The engine speed, load, and spark timing are selected to achieve a catalyst bed temperature of 800 °C (± 10 °C) at steady-state stoichiometric operation.

The air injection system is set to provide the necessary air flow to produce 3.0 per cent oxygen (± 0.1 %) in the steady-state stoichiometric exhaust stream just in front of the first catalyst. A typical reading at the upstream A/F measurement point (required in paragraph 3.4. of this appendix) is lambda 1.16 (which is approximately 3 per cent oxygen).

With the air injection on, set the "Rich" A/F ratio to produce a catalyst bed temperature of 890 °C (± 10 °C). A typical A/F value for this step is lambda 0.94 (approximately 2 per cent CO).

- 3.7. Ageing Cycle. The standard bench ageing procedures use the standard bench cycle (SBC). The SBC is repeated until the amount of ageing calculated from the bench ageing time equation (BAT) is achieved.

- 3.8. Quality Assurance. The temperatures and A/F ratio in paragraphs 3.3. and 3.4. of this appendix shall be reviewed periodically (at least every 50 hours) during ageing. Necessary adjustments shall be made to assure that the SBC is being appropriately followed throughout the ageing process.

After the ageing has been completed, the catalyst time-at-temperature collected during the ageing process shall be tabulated into a histogram with temperature groups of no larger than 10 °C. The BAT equation and the calculated effective reference temperature for the ageing cycle according to paragraph 2.3.1.4. of this annex will be used to determine if the appropriate amount of thermal ageing of the catalyst has in fact occurred. Bench ageing will be extended if the thermal effect of the calculated ageing time is not at least 95 per cent of the target thermal ageing.

- 3.9. Start up and Shutdown. Care should be taken to assure that the maximum catalyst temperature for rapid deterioration (e.g. 1,050 °C) does not occur during start up or shutdown. Special low temperature start up and shutdown procedures may be used to alleviate this concern.

4. Experimentally determining the R-factor for bench ageing durability procedures

- 4.1. The R-Factor is the catalyst thermal reactivity coefficient used in the bench ageing time (BAT) equation. Manufacturers may determine the value of R experimentally using the following procedures.
 - 4.1.1. Using the applicable bench cycle and ageing bench hardware, age several catalysts (minimum of 3 of the same catalyst design) at different control temperatures between the normal operating temperature and the damage limit temperature. Measure emissions (or catalyst inefficiency (1-catalyst efficiency)) for each exhaust constituent. Assure that the final testing yields data between one- and two-times the emission standard.
 - 4.1.2. Estimate the value of R and calculate the effective reference temperature (T_r) for the bench ageing cycle for each control temperature according to paragraph 2.3.1.4. of this annex.
 - 4.1.3. Plot emissions (or catalyst inefficiency) versus ageing time for each catalyst. Calculate the least-squared best-fit line through the data. For the data set to be useful for this purpose the data should have an approximately common intercept between 0 and 6400 km. See Figure A9.App1/3 for an example.
 - 4.1.4. Calculate the slope of the best-fit line for each ageing temperature.

Figure A9.App1/3

Example of catalyst ageing

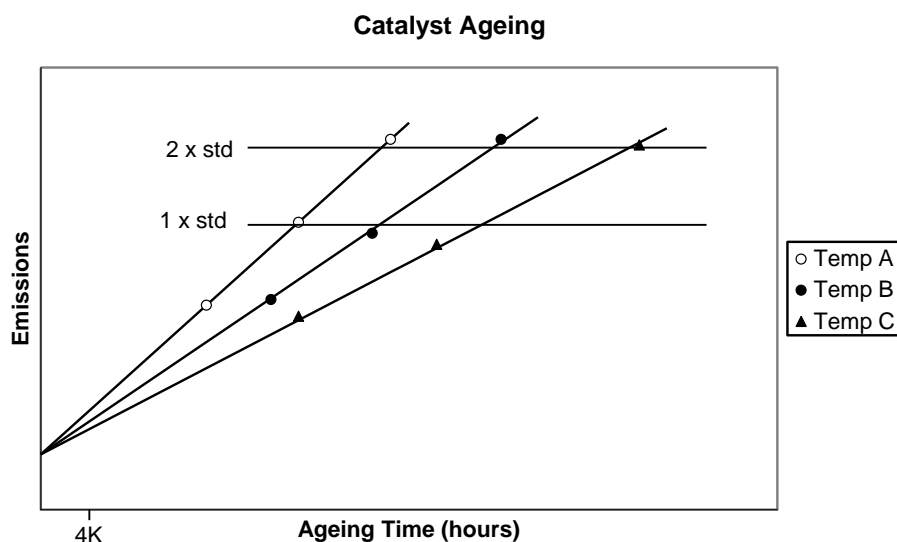

- 4.1.5. Plot the natural log (\ln) of the slope of each best-fit line (determined in paragraph 4.1.4. of this appendix) along the vertical axis, versus the inverse of ageing temperature ($1/(\text{ageing temperature, deg K})$) along the horizontal axis. Calculate the least squared best-fit lines through the data. The slope of the line is the R-factor. See Figure A9.App1/4 for an example.
- 4.1.6. Compare the R-factor to the initial value that was used in paragraph 4.1.2. of this appendix. If the calculated R-factor differs from the initial value by more than 5 per cent, choose a new R-factor that is between the initial and calculated values, and then repeat the steps in paragraphs 4.1.2. to 4.1.6. of this appendix to derive a new R-factor. Repeat this process until the calculated R-factor is within 5 per cent of the initially assumed R-factor.
- 4.1.7. Compare the R-factor determined separately for each exhaust constituent. Use the lowest R-factor (worst case) for the BAT equation.

Figure A9.App1/4
Determining the R-Factor

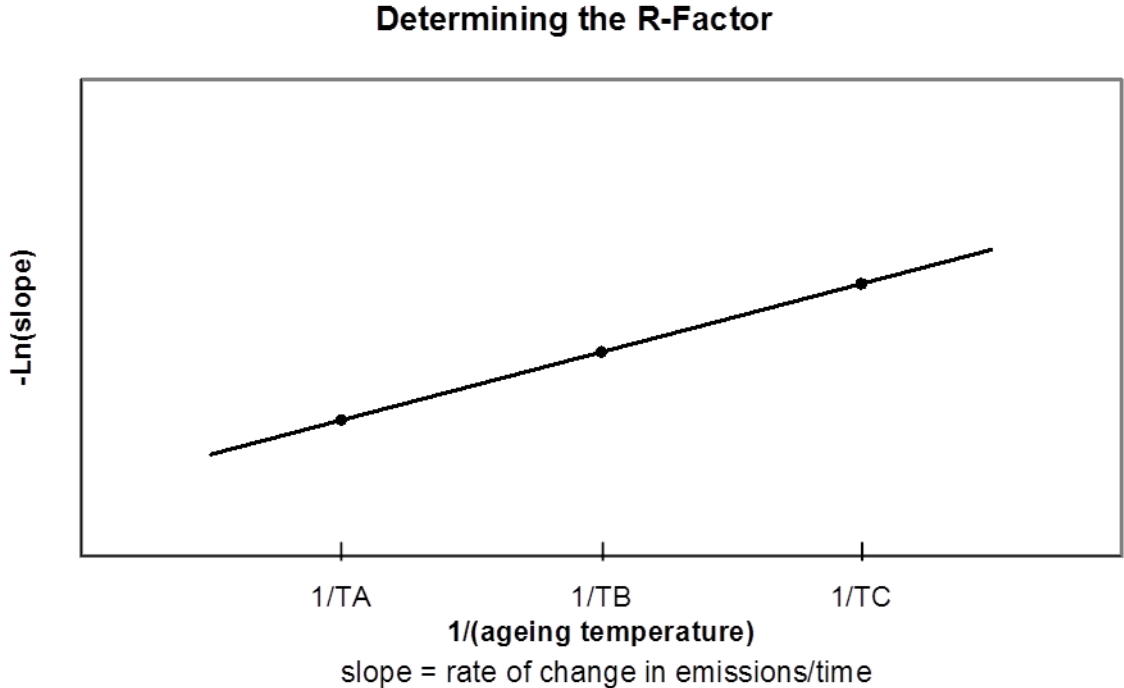

Annex 9 - Appendix 2

Standard Diesel Bench Cycle (SDBC)

1. Introduction

For particulate filters, the number of regenerations is critical to the ageing process. For systems that require desulphurisation cycles (e.g. NO_x storage catalysts), this process is also significant.

The standard diesel bench ageing durability procedure consists of ageing an after-treatment system on an ageing bench which follows the standard bench cycle (SDBC) described in this appendix. The SDBC requires use of an ageing bench with an engine as the source of feed gas for the system.

During the SDBC, the regeneration/desulphurisation strategies of the system shall remain in normal operating condition.

2. The Standard Diesel Bench Cycle reproduces the engine speed and load conditions that are encountered in the SRC cycle as appropriate to the period for which durability is to be determined. In order to accelerate the process of ageing, the engine settings on the test bench may be modified to reduce the system loading times. For example the fuel injection timing or EGR strategy may be modified.

3. Ageing bench equipment and procedures

- 3.1. The standard ageing bench consists of an engine, engine controller, and engine dynamometer. Other configurations may be acceptable (e.g. whole vehicle on a dynamometer, or a burner that provides the correct exhaust conditions), as long as the after-treatment system inlet conditions and control features specified in this appendix are met.

A single ageing bench may have the exhaust flow split into several streams provided that each exhaust stream meets the requirements of this appendix. If the bench has more than one exhaust stream, multiple after-treatment systems may be aged simultaneously.

- 3.2. Exhaust system installation. The entire after-treatment system, together with all exhaust piping which connects these components, will be installed on the bench. For engines with multiple exhaust streams (such as some V6 and V8 engines), each bank of the exhaust system will be installed separately on the bench.

The entire after-treatment system will be installed as a unit for ageing. Alternatively, each individual component may be separately aged for the appropriate period of time.

Annex 9 - Appendix 3

Standard Road Cycle (SRC)

1. Introduction

The standard road cycle (SRC) is a kilometre accumulation cycle. The vehicle may be run on a test track or on a kilometre accumulation dynamometer.

The cycle consists of 7 laps of a 6 km course. The length of the lap may be changed to accommodate the length of the mileage accumulation test track.

Standard Road cycle

Lap	Description	Typical acceleration rate m/s ²
1	(start engine) idle 10 seconds	0
1	Moderate acceleration to 48 km/h	1.79
1	Cruise at 48 km/h for ¼ lap	0
1	Moderate deceleration to 32 km/h	-2.23
1	Moderate acceleration to 48 km/h	1.79
1	Cruise at 48 km/h for ¼ lap	0
1	Moderate deceleration to stop	-2.23
1	Idle 5 seconds	0
1	Moderate acceleration to 56 km/h	1.79
1	Cruise at 56 km/h for ¼ lap	0
1	Moderate deceleration to 40 km/h	-2.23
1	Moderate acceleration to 56 km/h	1.79
1	Cruise at 56 km/h for ¼ lap	0
1	Moderate deceleration to stop	-2.23
2	idle 10 seconds	0
2	Moderate acceleration to 64 km/h	1.34
2	Cruise at 64 km/h for ¼ lap	0
2	Moderate deceleration to 48 km/h	-2.23
2	Moderate acceleration to 64 km/h	1.34
2	Cruise at 64 km/h for ¼ lap	0
2	Moderate deceleration to stop	-2.23
2	Idle 5 seconds	0
2	Moderate acceleration to 72 km/h	1.34
2	Cruise at 72 km/h for ¼ lap	0
2	Moderate deceleration to 56 km/h	-2.23
2	Moderate acceleration to 72 km/h	1.34
2	Cruise at 72 km/h for ¼ lap	0
2	Moderate deceleration to stop	-2.23
3	idle 10 seconds	0
3	Hard acceleration to 88 km/h	1.79
3	Cruise at 88 km/h for ¼ lap	0
3	Moderate deceleration to 72 km/h	-2.23
3	Moderate acceleration to 88 km/h	0.89
3	Cruise at 88 km/h for ¼ lap	0
3	Moderate deceleration to 72 km/h	-2.23
3	Moderate acceleration to 97 km/h	0.89
3	Cruise at 97 km/h for ¼ lap	0

<i>Lap</i>	<i>Description</i>	<i>Typical acceleration rate m/s²</i>
3	Moderate deceleration to 80 km/h	-2.23
3	Moderate acceleration to 97 km/h	0.89
3	Cruise at 97 km/h for ¼ lap	0
3	Moderate deceleration to stop	-1.79
4	idle 10 seconds	0
4	Hard acceleration to 129 km/h	1.34
4	Coastdown to 113 km/h	-0.45
4	Cruise at 113 km/h for ½ lap	0
4	Moderate deceleration to 80 km/h	-1.34
4	Moderate acceleration to 105 km/h	0.89
4	Cruise at 105 km/h for ½ lap	0
4	Moderate deceleration to 80 km/h	-1.34
5	Moderate acceleration to 121 km/h	0.45
5	Cruise at 121 km/h for ½ lap	0
5	Moderate deceleration to 80 km/h	-1.34
5	Light acceleration to 113 km/h	0.45
5	Cruise at 113 km/h for ½ lap	0
5	Moderate deceleration to 80 km/h	-1.34
6	Moderate acceleration to 113 km/h	0.89
6	Coastdown to 97 km/h	-0.45
6	Cruise at 97 km/h for ½ lap	0
6	Moderate deceleration to 80 km/h	-1.79
6	Moderate acceleration to 104 km/h	0.45
6	Cruise at 104 km/h for ½ lap	0
6	Moderate deceleration to stop	-1.79
7	idle 45 seconds	0
7	Hard acceleration to 88 km/h	1.79
7	Cruise at 88 km/h for ¼ lap	0
7	Moderate deceleration to 64 km/h	-2.23
7	Moderate acceleration to 88 km/h	0.89
7	Cruise at 88 km/h for ¼ lap	0
7	Moderate deceleration to 64 km/h	-2.23
7	Moderate acceleration to 80 km/h	0.89
7	Cruise at 80 km/h for ¼ lap	0
7	Moderate deceleration to 64 km/h	-2.23
7	Moderate acceleration to 80 km/h	0.89
7	Cruise at 80 km/h for ¼ lap	0
7	Moderate deceleration to stop	-2.23

The standard road cycle is represented graphically in the following figure:

Standard Road Cycle

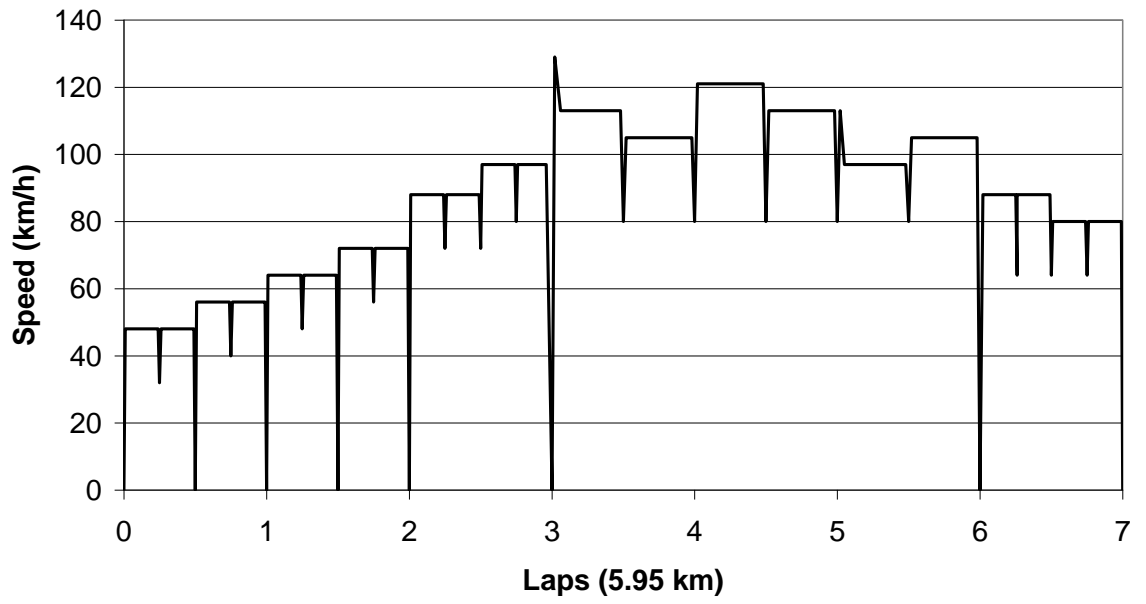

Annex 10

Specifications of reference fuels

1. Specifications of reference fuels for testing vehicles to the emission limits
 - 1.1. Technical data on the reference fuel to be used for testing vehicles equipped with positive-ignition engines

Type: Petrol (E5)

Parameter	Unit	Limits ¹		Test method
		Minimum	Maximum	
Research octane number, RON		95.0	-	EN 25164 prEN ISO 5164
Motor octane number, MON		85.0	-	EN 25163 prEN ISO 5163
Density at 15 °C	kg/m ³	743	756	EN ISO 3675 EN ISO 12185
Vapour pressure	kPa	56.0	60.0	EN ISO 13016-1 (DVPE)
Water content	% v/v		0.015	ASTM E 1064
Distillation:				
– Evaporated at 70 °C	% v/v	24.0	44.0	EN-ISO 3405
– Evaporated at 100 °C	% v/v	48.0	60.0	EN-ISO 3405
– Evaporated at 150 °C	% v/v	82.0	90.0	EN-ISO 3405
– Final boiling point	°C	190	210	EN-ISO 3405
Residue	% v/v	—	2.0	EN-ISO 3405
Hydrocarbon analysis:				
– Olefins	% v/v	3.0	13.0	ASTM D 1319
– Aromatics	% v/v	29.0	35.0	ASTM D 1319
– Benzene	% v/v	-	1.0	EN 12177
– Saturates	% v/v		Report	ASTM 1319
Carbon/hydrogen ratio			Report	
Carbon/oxygen ratio			Report	
Induction period ²	minutes	480	-	EN-ISO 7536
Oxygen content ³	% m/m		Report	EN 1601
Existent gum	mg/ml	-	0.04	EN-ISO 6246
Sulphur content ⁴	mg/kg	-	10	EN ISO 20846 EN ISO 20884
Copper corrosion		-	Class 1	EN-ISO 2160
Lead content	mg/l	-	5	EN 237
Phosphorus content ⁵	mg/l	-	1.3	ASTM D 3231
Ethanol ³	% v/v	4.7	5.3	EN 1601 EN 13132

¹ The values quoted in the specifications are "true values". In establishment of their limit values the terms of ISO 4259 Petroleum products - Determination and application of precision data in relation to methods of test have been applied and in fixing a minimum value, a minimum difference of 2R above zero has been taken into account; in fixing a maximum and minimum value, the minimum difference is 4R (R = reproducibility).

Notwithstanding this measure, which is necessary for technical reasons, the manufacturer of fuels shall nevertheless aim at a zero value where the stipulated maximum value is 2R and at the mean value in the case of quotations of maximum and minimum limits. Should it be necessary to clarify whether a fuel meets the requirements of the specifications, the terms of ISO 4259 shall be applied.

² The fuel may contain oxidation inhibitors and metal deactivators normally used to stabilize refinery gasoline streams, but detergent/dispersive additives and solvent oils shall not be added.

³ Ethanol meeting the specification of EN 15376 is the only oxygenate that shall be intentionally added to the reference fuel.

⁴ The actual sulphur content of the fuel used for the Type I Test shall be reported

⁵ There shall be no intentional addition of compounds containing phosphorus, iron, manganese, or lead to this reference fuel.

Type: Petrol (E10)

Parameter	Unit	Limits ¹		Test method
		Minimum	Maximum	
Research octane number, RON ²		95.0	98.0	EN ISO 5164
Motor octane number, MON ²		85.0	89.0	EN ISO 5163
Density at 15°C	kg/m ³	743.0	756.0	EN ISO 12185
Vapour pressure (DVPE)	kPa	56.0	60.0	EN 13016-1
Water content	% m/m	max 0.05 Appearance at -7°C: Clear & Bright		EN 12937
Distillation:				
– evaporated at 70°C	% v/v	34.0	46.0	EN ISO 3405
– evaporated at 100°C	% v/v	54.0	62.0	EN ISO 3405
– evaporated at 150°C	% v/v	86.0	94.0	EN ISO 3405
– final boiling point	°C	170	195	EN ISO 3405
Residue	% v/v	—	2.0	EN ISO 3405
Hydrocarbon analysis:				
– olefins	% v/v	6.0	13.0	EN 22854
– aromatics	% v/v	25.0	32.0	EN 22854
– benzene	% v/v	-	1.00	EN 22854 EN 238
– saturates	% v/v	report		EN 22854
Carbon/hydrogen ratio		report		
Carbon/oxygen ratio		report		
Induction Period ³	minutes	480	—	EN ISO 7536
Oxygen content ⁴	% m/m	3.3	3.7	EN 22854
Solvent washed gum (Existent gum content)	mg/100ml	—	4	EN ISO 6246
Sulphur content ⁵	mg/kg	—	10	EN ISO 20846 EN ISO 20884
Copper corrosion 3hrs, 50°C		—	class 1	EN ISO 2160
Lead content	mg/l	—	5	EN 237
Phosphorus content ⁶	mg/l	—	1.3	ASTM D 3231
Ethanol ⁴	% v/v	9.0	10.0	EN 22854

¹ The values quoted in the specifications are 'true values'. In establishment of their limit values the terms of ISO 4259 Petroleum products - Determination and application of precision data in relation to methods of test have been applied and in fixing a minimum value, a minimum difference of 2R above zero has been taken into account; in fixing a maximum and minimum value, the minimum difference is 4R (R = reproducibility).

² Notwithstanding this measure, which is necessary for technical reasons, the manufacturer of fuels shall nevertheless aim at a zero value where the stipulated maximum value is 2R and at the mean value in the case of quotations of maximum and minimum limits. Should it be necessary to clarify whether a fuel meets the requirements of the specifications, the terms of ISO 4259 shall be applied.

³ A correction factor of 0.2 for MON and RON shall be subtracted for the calculation of the final result in accordance with EN 228:2008.

⁴ The fuel may contain oxidation inhibitors and metal deactivators normally used to stabilise refinery gasoline streams, but detergent/dispersive additives and solvent oils shall not be added.

⁵ Ethanol is the only oxygenate that shall be intentionally added to the reference fuel. The Ethanol used shall conform to EN 15376.

⁶ The actual sulphur content of the fuel used for the Type 1 test shall be reported.

⁷ There shall be no intentional addition of compounds containing phosphorus, iron, manganese, or lead to this reference fuel.

Type: Ethanol (E85)

Parameter	Unit	Limits ¹		Test method ²
		Minimum	Maximum	
Research octane number, RON		95.0	-	EN ISO 5164
Motor octane number, MON		85.0	-	EN ISO 5163
Density at 15 °C	kg/m ³	Report		ISO 3675
Vapour pressure	kPa	40.0	60.0	EN ISO 13016-1 (DVPE)
Sulphur content ^{3, 4}	mg/kg	-	10	EN ISO 20846 EN ISO 20884
Oxidation stability	minutes	360		EN ISO 7536
Existent gum content (solvent washed)	mg/(100 ml)	-	5	EN-ISO 6246
Appearance This shall be determined at ambient temperature or 15 °C whichever is higher.		Clear and bright, visibly free of suspended or precipitated contaminants		Visual inspection
Ethanol and higher alcohols ⁷	% V/V	83	85	EN 1601 EN 13132 EN 14517
Higher alcohols (C3-C8)	% V/V	-	2.0	
Methanol	% V/V		0.5	
Petrol ⁵	% V/V	Balance		EN 228
Phosphorus	mg/l	0.3 ⁶		ASTM D 3231
Water content	% V/V		0.3	ASTM E 1064
Inorganic chloride content	mg/l		1	ISO 6227
pHe		6.5	9.0	ASTM D 6423
Copper strip corrosion (3h at 50 °C)	Rating	Class 1		EN ISO 2160
Acidity, (as acetic acid CH ₃ COOH)	% m/m (mg/l)	-	0.005 (40)	ASTM D 1613
Carbon/hydrogen ratio		report		
Carbon/oxygen ration		report		

¹ The values quoted in the specifications are "true values". In establishment of their limit values the terms of ISO 4259 Petroleum products - Determination and application of precision data in relation to methods of test have been applied and in fixing a minimum value, a minimum difference of 2R above zero has been taken into account; in fixing a maximum and minimum value, the minimum difference is 4R (R = reproducibility).

Notwithstanding this measure, which is necessary for technical reasons, the manufacturer of fuels shall nevertheless aim at a zero value where the stipulated maximum value is 2R and at the mean value in the case of quotations of maximum and minimum limits. Should it be necessary to clarify whether a fuel meets the requirements of the specifications, the terms of ISO 4259 shall be applied.

² In cases of dispute, the procedures for resolving the dispute and interpretation of the results based on test method precision, described in EN ISO 4259 shall be used.

³ In cases of national dispute concerning sulphur content, either EN ISO 20846 or EN ISO 20884 shall be called up similar to the reference in the national annex of EN 228.

⁴ The actual sulphur content of the fuel used for the Type I Test shall be reported.

⁵ The unleaded petrol content can be determined as 100 minus the sum of the percentage content of water and alcohols.

⁶ There shall be no intentional addition of compounds containing phosphorus, iron, manganese, or lead to this reference fuel.

⁷ Ethanol to meet specification of EN 15376 is the only oxygenate that shall be intentionally added to this reference fuel.

1.2. Technical data on the reference fuel to be used for testing vehicles equipped with compression-ignition engine

Type: Diesel fuel (B5)

Parameter	Unit	Limits ¹		Test method
		Minimum	Maximum	
Cetane number ²		52.0	54.0	EN-ISO 5165
Density at 15 °C	kg/m ³	833	837	EN-ISO 3675
Distillation:				
- 50 % point	°C	245	-	EN-ISO 3405
- 95 % point	°C	345	350	EN-ISO 3405
- Final boiling point	°C	-	370	EN-ISO 3405
Flash point	°C	55	-	EN 22719
CFPP	°C	-	- 5	EN 116
Viscosity at 40 °C	mm ² /s	2.3	3.3	EN-ISO 3104
Polycyclic aromatic hydrocarbons	% m/m	2.0	6.0	EN 12916
Sulphur content ³	mg/kg	-	10	EN ISO 20846 /EN ISO 20884
Copper corrosion		-	Class 1	EN-ISO 2160
Conradson carbon residue (10 % DR)	% m/m	-	0.2	EN-ISO 10370
Ash content	% m/m	-	0.01	EN-ISO 6245
Water content	% m/m	-	0.02	EN-ISO 12937
Neutralisation (strong acid) number	mg KOH/g	-	0.02	ASTM D 974
Oxidation stability ⁴	mg/ml	-	0.025	EN-ISO 12205
Lubricity (HFRR wear scan diameter at 60 °C)	µm	-	400	EN ISO 12156
Oxidation stability at 110 °C ^{4, 6}	h	20.0		EN 14112
FAME ⁵	% v/v	4.5	5.5	EN 14078

¹ The values quoted in the specifications are "true values". In establishment of their limit values the terms of ISO 4259 Petroleum products – Determination and application of precision data in relation to methods of test have been applied and in fixing a minimum value, a minimum difference of 2R above zero has been taken into account; in fixing a maximum and minimum value, the minimum difference is 4R (R = reproducibility).

Notwithstanding this measure, which is necessary for technical reasons, the manufacturer of fuels shall nevertheless aim at a zero value where the stipulated maximum value is 2R and at the mean value in the case of quotations of maximum and minimum limits. Should it be necessary to clarify whether a fuel meets the requirements of the specifications, the terms of ISO 4259 shall be applied.

² The range for cetane number is not in accordance with the requirements of a minimum range of 4R. However, in the case of a dispute between fuel supplier and fuel user, the terms of ISO 4259 may be used to resolve such disputes provided replicate measurements, of sufficient number to archive the necessary precision, are made in preference to single determinations.

³ The actual sulphur content of the fuel used for the Type I Test shall be reported.

⁴ Even though oxidation stability is controlled, it is likely that shelf life will be limited. Advice shall be sought from the supplier as to storage conditions and life.

⁵ FAME content to meet the specification of EN 14214.

⁶ Oxidation stability can be demonstrated by EN-ISO 12205 or by EN 14112. This requirement shall be reviewed based on CEN/TC19 evaluations of oxidative stability performance and test limits.

Type: Diesel fuel (B7)

Parameter	Unit	Limits ¹		Test method
		Minimum	Maximum	
Cetane Index		46.0		EN ISO 4264
Cetane number ²		52.0	56.0	EN ISO 5165
Density at 15 °C	kg/m ³	833.0	837.0	EN ISO 12185
Distillation:				
- 50% point	°C	245.0	—	EN ISO 3405
- 95% point	°C	345.0	360.0	EN ISO 3405
- final boiling point	°C	—	370.0	EN ISO 3405
Flash point	°C	55	—	EN ISO 2719
Cloud point	°C	-	-10	EN 23015
Viscosity at 40 °C	mm ² /s	2.30	3.30	EN ISO 3104
Polycyclic aromatic hydrocarbons	% m/m	2.0	4.0	EN 12916
Sulphur content	mg/kg	—	10.0	EN ISO 20846 EN ISO 20884
Copper corrosion 3hrs, 50°C		—	Class 1	EN ISO 2160
Conradson carbon residue (10 % DR)	% m/m	—	0.20	EN ISO 10370
Ash content	% m/m	—	0.010	EN ISO 6245
Total contamination	mg/kg	-	24	EN 12662
Water content	mg/kg	—	200	EN ISO 12937
Acid number	mg KOH/g	—	0.10	EN ISO 6618
Lubricity (HFRR wear scan diameter at 60 °C)	µm	—	400	EN ISO 12156
Oxidation stability @ 110°C ³	h	20.0		EN 15751
FAME ⁴	% v/v	6.0	7.0	EN 14078

¹ The values quoted in the specifications are 'true values'. In establishment of their limit values the terms of ISO 4259 Petroleum products – Determination and application of precision data in relation to methods of test have been applied and in fixing a minimum value, a minimum difference of 2R above zero has been taken into account; in fixing a maximum and minimum value, the minimum difference is 4R (R = reproducibility). Notwithstanding this measure, which is necessary for technical reasons, the manufacturer of fuels shall nevertheless aim at a zero value where the stipulated maximum value is 2R and at the mean value in the case of quotations of maximum and minimum limits. Should it be necessary to clarify whether a fuel meets the requirements of the specifications, the terms of ISO 4259 shall be applied.

² The range for cetane number is not in accordance with the requirements of a minimum range of 4R. However, in the case of a dispute between fuel supplier and fuel user, the terms of ISO 4259 may be used to resolve such disputes provided replicate measurements, of sufficient number to archive the necessary precision, are made in preference to single determinations.

³ Even though oxidation stability is controlled, it is likely that shelf life will be limited. Advice shall be sought from the supplier as to storage conditions and life.

⁴ FAME content to meet the specification of EN 14214.

2. Specifications of reference fuel to be used for testing vehicles equipped with positive-ignition engines at low ambient temperature – Type VI Test

Type: Petrol (E5)

Parameter	Unit	Limits ¹		Test method
		Minimum	Maximum	
Research octane number, RON		95.0	-	EN 25164 Pr. EN ISO 5164
Motor octane number, MON		85.0	-	EN 25163 Pr. EN ISO 5163
Density at 15 °C	kg/m ³	743	756	EN ISO 3675 EN ISO 12185
Vapour pressure	kPa	56.0	95.0	EN ISO 13016-1 (DVPE)
Water content	% v/v		0.015	ASTM E 1064
Distillation:				
- Evaporated at 70 °C	% v/v	24.0	44.0	EN-ISO 3405
- Evaporated at 100 °C	% v/v	50.0	60.0	EN-ISO 3405
- Evaporated at 150 °C	% v/v	82.0	90.0	EN-ISO 3405
- Final boiling point	°C	190	210	EN-ISO 3405
Residue	% v/v	-	2.0	EN-ISO 3405
Hydrocarbon analysis:				
- Olefins	% v/v	3.0	13.0	ASTM D 1319
- Aromatics	% v/v	29.0	35.0	ASTM D 1319
- Benzene	% v/v	-	1.0	EN 12177
- Saturates	% v/v		Report	ASTM 1319
Carbon/hydrogen ratio			Report	
Carbon/oxygen ratio			Report	
Induction period ²	minutes	480	-	EN-ISO 7536
Oxygen content ³	% m/m		Report	EN 1601
Existent gum	mg/ml	-	0.04	EN-ISO 6246
Sulphur content ⁴	mg/kg	-	10	EN ISO 20846 EN ISO 20884
Copper corrosion		-	Class 1	EN-ISO 2160
Lead content	mg/l	-	5	EN 237
Phosphorus content ⁵	mg/l	-	1.3	ASTM D 3231
Ethanol ³	% v/v	4.7	5.3	EN 1601 EN 13132

¹ The values quoted in the specifications are "true values". In establishment of their limit values the terms of ISO 4259 Petroleum products - Determination and application of precision data in relation to methods of test have been applied and in fixing a minimum value, a minimum difference of 2R above zero has been taken into account; in fixing a maximum and minimum value, the minimum difference is 4R (R = reproducibility).

Notwithstanding this measure, which is necessary for technical reasons, the manufacturer of fuels shall nevertheless aim at a zero value where the stipulated maximum value is 2R and at the mean value in the case of quotations of maximum and minimum limits. Should it be necessary to clarify whether a fuel meets the requirements of the specifications, the terms of ISO 4259 shall be applied.

² The fuel may contain oxidation inhibitors and metal deactivators normally used to stabilize refinery gasoline streams, but detergent/dispersive additives and solvent oils shall not be added.

³ Ethanol meeting the specification of EN 15376 is the only oxygenate that shall be intentionally added to the reference fuel.

⁴ The actual sulphur content of the fuel used for the Type VI Test shall be reported.

⁵ There shall be no intentional addition of compounds containing phosphorus, iron, manganese, or lead to this reference fuel.

Type: Petrol (E10)

Parameter	Unit	Limits ¹		Test method
		Minimum	Maximum	
Research octane number, RON ²		95.0	98.0	EN ISO 5164
Motor octane number, MON ²		85.0	89.0	EN ISO 5163
Density at 15°C	kg/m ³	743.0	756.0	EN ISO 12185
Vapour pressure (DVPE)	kPa	56.0	95.0	EN 13016-1
Water content		max 0.05 Appearance at -7°C: Clear & Bright		EN 12937
Distillation:				
– evaporated at 70°C	% v/v	34.0	46.0	EN ISO 3405
– evaporated at 100°C	% v/v	54.0	62.0	EN ISO 3405
– evaporated at 150°C	% v/v	86.0	94.0	EN ISO 3405
– final boiling point	°C	170	195	EN ISO 3405
Residue	% v/v	—	2.0	EN ISO 3405
Hydrocarbon analysis:				
– olefins	% v/v	6.0	13.0	EN 22854
– aromatics	% v/v	25.0	32.0	EN 22854
– benzene	% v/v	-	1.00	EN 22854 EN 238
– saturates	% v/v	report		EN 22854
Carbon/hydrogen ratio		report		
Carbon/oxygen ratio		report		
Induction Period ³	minutes	480	—	EN ISO 7536
Oxygen content ⁴	% m/m	3.3	3.7	EN 22854
Solvent washed gum (Existent gum content)	mg/100ml	—	4	EN ISO 6246
Sulphur content ⁵	mg/kg	—	10	EN ISO 20846 EN ISO 20884
Copper corrosion 3hrs, 50°C		—	class 1	EN ISO 2160
Lead content	mg/l	—	5	EN 237
Phosphorus content ⁶	mg/l	—	1.3	ASTM D 3231
Ethanol ⁴	% v/v	9.0	10.0	EN 22854

¹ The values quoted in the specifications are ‘true values’. In establishment of their limit values the terms of ISO 4259 Petroleum products - Determination and application of precision data in relation to methods of test have been applied and in fixing a minimum value, a minimum difference of 2R above zero has been taken into account; in fixing a maximum and minimum value, the minimum difference is 4R (R = reproducibility). Notwithstanding this measure, which is necessary for technical reasons, the manufacturer of fuels shall nevertheless aim at a zero value where the stipulated maximum value is 2R and at the mean value in the case of quotations of maximum and minimum limits. Should it be necessary to clarify whether a fuel meets the requirements of the specifications, the terms of ISO 4259 shall be applied.

² A correction factor of 0,2 for MON and RON shall be subtracted for the calculation of the final result in accordance with EN 228:2008.

³ The fuel may contain oxidation inhibitors and metal deactivators normally used to stabilise refinery gasoline streams, but detergent/dispersive additives and solvent oils shall not be added.

⁴ Ethanol is the only oxygenate that shall be intentionally added to the reference fuel. The Ethanol used shall conform to EN 15376.

⁵ The actual sulphur content of the fuel used for the Type 1 test shall be reported.

⁶ There shall be no intentional addition of compounds containing phosphorus, iron, manganese, or lead to this reference fuel.

Type: Ethanol (E75)

Parameter	Unit	Limits ¹		Test method ²
		Minimum	Maximum	
Research octane number, RON		95	-	EN ISO 5164
Motor octane number, MON		85	-	EN ISO 5163
Density at 15 °C	kg/m ³	report		EN ISO 12185
Vapour pressure	kPa	50	60	EN ISO 1 30 16-1 (DVPE)
Sulphur content ^{3, 4}	mg/kg	-	10	EN ISO 20846 EN ISO 20884
Oxidation stability	minutes	360	-	EN ISO 7536
Existent gum content (solvent washed)	mg/100ml	-	4	EN ISO 6246
Appearance shall be determined at ambient temperature or 15 °C whichever is higher.		Clear and bright, visibly free of suspended or precipitated contaminants		Visual inspection
Ethanol and higher alcohols ⁷	% (V/V)	70	80	EN 1601 EN 13132 EN 1451 7
Higher alcohols (C 3 - C8)	% (V/V)	-	2	
Methanol		-	0.5	
Petrol ⁵	% (V/V)	Balance		EN 228
Phosphorus	mg/l	0.3 ⁶		EN 15487 ASTM D 3231
Water content	% (V/V)	-	0.3	ASTM E 1064 EN 15 489
Inorganic chloride content	mg/l	-	1	ISO 6227 - EN 15492
pHe		6.5	9	ASTM D 6423 EN 15490
Copper strip corrosion (3h at 50 °C)	Rating	Class I		EN ISO 2160
Acidity (as acetic acid CH ₃ COOH)	% (m/m)		0.005	ASTM 0161 3
	mg/l		40	EN 15491
Carbon/hydrogen ratio		report		
Carbon/oxygen ratio		report		

¹ The values referred to in the specifications are "true values". When establishing the value limits, the terms of ISO 4259 Petroleum products - Determination and application of precision data in relation to methods of test were applied. When fixing a minimum value, a minimum difference of 2R above zero was taken into account. When fixing a maximum and minimum value, the minimum difference used was 4R (R = reproducibility). Notwithstanding this procedure, which is necessary for technical reasons, fuel manufacturers shall aim for a zero value where the stipulated maximum value is 2R and for the mean value for quotations of maximum and minimum limits. Where it is necessary to clarify whether fuel meets the requirements of the specifications, the ISO 4259 terms shall be applied.

² In cases of dispute, the procedures for resolving the dispute and interpretation of the results based on test method precision, described in EN ISO 4259 shall be used.

³ In cases of national dispute concerning sulphur content, either EN ISO 20846 or EN ISO 20884 shall be called up similar to the reference in the national annex of EN 228.

⁴ The actual sulphur content of the fuel used for the Type VI test shall be reported.

⁵ The unleaded petrol content may be determined as 100 minus the sum of the percentage content of water and alcohols.

⁶ There shall be no intentional addition of compounds containing phosphorus, iron, manganese, or lead to this reference fuel.

⁷ Ethanol to meet specification of EN 15376 is the only oxygenate that shall be intentionally added to this reference fuel.

Annex 10a

Specifications of gaseous reference fuels

1. Specifications of gaseous reference fuels
 - 1.1. Technical data of the LPG reference fuels used for testing vehicles to the emission limits given in Table 1 in paragraph 5.3.1.4. of this Regulation – Type I Test

Type: LPG

Parameter	Unit	Fuel A	Fuel B	Test method
<i>Composition:</i>				ISO 7941
C ₃ -content	per cent vol	30 ± 2	85 ± 2	
C ₄ -content	per cent vol	Balance ¹	Balance ¹	
< C ₃ , >C ₄	per cent vol	max. 2	max. 2	
Olefins	per cent vol	max. 12	max. 15	
Evaporation residue	mg/kg	max. 50	max. 50	ISO 13757 or EN 15470
Water at 0°C		free	free	EN 15469
Total sulphur content	mg/kg	max. 50	max. 50	EN 24260 or ASTM 6667
Hydrogen sulphide		none	none	ISO 8819
Copper strip corrosion	rating	Class 1	Class 1	ISO 6251 ²
Odour		characteristic	characteristic	
Motor octane number		min. 89	min. 89	EN 589 Annex B

¹ Balance has to be read as follows: balance = 100 – C₃ ≤ C₃ ≤ C₄.

² This method may not accurately determine the presence of corrosive materials if the sample contains corrosion inhibitors or other chemicals which diminish the corrosivity of the sample to the copper strip. Therefore, the addition of such compounds for the sole purpose of biasing the test method is prohibited.

- 1.2. Technical data of the NG or biomethane reference fuels

Type: NG/biomethane

Characteristics	Units	Basis	Limits		Test Method
			min.	max.	
Reference fuel G ₂₀					
<i>Composition:</i>					
Methane	per cent mole	100	99	100	ISO 6974
Balance ¹	per cent mole	-	-	1	ISO 6974
N ₂	per cent mole				ISO 6974
Sulphur content	mg/m ^{3 2}	-	-	10	ISO 6326-5
Wobbe Index (net)	MJ/m ^{3 3}	48.2	47.2	49.2	
Reference fuel G ₂₅					
<i>Composition:</i>					
Methane	per cent mole	86	84	88	ISO 6974
Balance ¹	per cent mole	-	-	1	ISO 6974
N ₂	per cent mole	14	12	16	ISO 6974
Sulphur content	mg/m ^{3 2}	-	-	10	ISO 6326-5
Wobbe Index (net)	MJ/m ^{3 3}	39.4	38.2	40.6	

¹ Inerts (different from N₂) + C₂ + C₂₊.

² Value to be determined at 293.2 K (20 °C) and 101.3 kPa.

³ Value to be determined at 273.2 K (0 °C) and 101.3 kPa.

1.3. Technical data of hydrogen for internal combustion engines

Type: hydrogen for internal combustion engines

Characteristics	Units	Limits		Test method
		minimum	maximum	
Hydrogen purity	% mole	98	100	ISO 14687-1
Total hydrocarbon	µmol/mol	0	100	ISO 14687-1
Water ¹	µmol/mol	0	2	ISO 14687-1
Oxygen	µmol/mol	0	2	ISO 14687-1
Argon	µmol/mol	0	2	ISO 14687-1
Nitrogen	µmol/mol	0	2	ISO 14687-1
CO	µmol/mol	0	1	ISO 14687-1
Sulphur	µmol/mol	0	2	ISO 14687-1
Permanent particulates ³				ISO 14687-1

¹ Not to be condensed

² Combined water, oxygen, nitrogen and argon: 1.900 µmol/mol.

³ The hydrogen shall not contain dust, sand, dirt, gums, oils, or other substances in an amount sufficient to damage the fuelling station equipment of the vehicle (engine) being fuelled.

1.4. Technical data of hydrogen for fuel cell vehicles

Type: Hydrogen for fuel cell vehicles

Characteristics	Units	Limits		Test method
		minimum	maximum	
Hydrogen fuel ¹	% mole	99.99	100	ISO 14687-2
Total gases ²	µmol/mol	0	100	
Total hydrocarbon	µmol/mol	0	2	ISO 14687-2
Water	µmol/mol	0	5	ISO 14687-2
Oxygen	µmol/mol	0	5	ISO 14687-2
Helium (He), Nitrogen (N ₂), Argon (Ar)	µmol/mol	0	100	ISO 14687-2
CO ₂	µmol/mol	0	2	ISO 14687-2
CO	µmol/mol	0	0.2	ISO 14687-2
Total sulphur compounds	µmol/mol	0	0.004	ISO 14687-2
Formaldehyde (HCHO)	µmol/mol	0	0.01	ISO 14687-2
Formic acid (HCOOH)	µmol/mol	0	0.2	ISO 14687-2
Ammonia (NH ₃)	µmol/mol	0	0.1	ISO 14687-2
Total halogenated compounds	µmol/mol	0	0.05	ISO 14687-2
Particulates size	µm	0	10	ISO 14687-2
Particulates concentration	µg/l	0	1	ISO 14687-2

¹ The hydrogen fuel index is determined by subtracting the total content of non-hydrogen gaseous constituents listed in the table (Total gases), expressed in mole per cent, from 100 mole per cent. It is less than the sum of the maximum allowable limits of all non-hydrogen constituents shown in the Table.

² The value of total gases is summation of the values of the non-hydrogen constituents listed in the table, except the particulates.

1.5. Technical data of hydrogen and the NG/biomethane fuels

Type: H2NG

The hydrogen and the NG/biomethane fuels composing a H2NG mixture, must comply separately with their corresponding characteristics, expressed in this annex.

Annex 11

On-board diagnostics (OBD) for motor vehicles

1. Introduction

This annex applies to the functional aspects of on-board diagnostic (OBD) system for the emission control of motor vehicles.
2. Definitions

For the purposes of this annex:

 - 2.1. "*OBD*" means an on-board diagnostic system for emission control which shall have the capability of identifying the likely area of malfunction by means of fault codes stored in computer memory.
 - 2.2. "*Vehicle type*" means a category of power-driven vehicles which do not differ in such essential engine and OBD system characteristics.
 - 2.3. "*Vehicle family*" means a manufacturer's grouping of vehicles which, through their design, are expected to have similar exhaust emission and OBD system characteristics. Each vehicle of this family shall have complied with the requirements of this Regulation as defined in Appendix 2 to this annex.
 - 2.4. "*Emission control system*" means the electronic engine management controller and any emission-related component in the exhaust or evaporative system which supplies an input to or receives an output from this controller.
 - 2.5. "*Malfunction indicator (MI)*" means a visible or audible indicator that clearly informs the driver of the vehicle in the event of a malfunction of any emission-related component connected to the OBD system, or the OBD system itself.
 - 2.6. "*Malfunction*" means the failure of an emission-related component or system that would result in emissions exceeding the limits in paragraph 3.3.2. of this annex or if the OBD system is unable to fulfil the basic monitoring requirements of this annex.
 - 2.7. "*Secondary air*" refers to air introduced into the exhaust system by means of a pump or aspirator valve or other means that is intended to aid in the oxidation of HC and CO contained in the exhaust gas stream.
 - 2.8. "*Engine misfire*" means lack of combustion in the cylinder of a positive-ignition engine due to absence of spark, poor fuel metering, poor compression or any other cause. In terms of OBD monitoring it is that percentage of misfires out of a total number of firing events (as declared by the manufacturer) that would result in emissions exceeding the limits given in paragraph 3.3.2. of this annex or that percentage that could lead to an exhaust catalyst, or catalysts, overheating causing irreversible damage.
 - 2.9. "*Type I Test*" means the driving cycle (Parts One and Two) used for emission approvals, as detailed in Tables A4a/1 and A4a/2 of Annex 4a to this Regulation.
 - 2.10. A "*driving cycle*" consists of engine start-up, driving mode where a malfunction would be detected if present, and engine shut-off.

- 2.11. A "*warm-up cycle*" means sufficient vehicle operation such that the coolant temperature has risen by a least 22 K from engine starting and reaches a minimum temperature of 343 K (70 °C).
- 2.12. A "*Fuel trim*" refers to feedback adjustments to the base fuel schedule. Short-term fuel trim refers to dynamic or instantaneous adjustments. Long-term fuel trim refers to much more gradual adjustments to the fuel calibration schedule than short-term trim adjustments. These long-term adjustments compensate for vehicle differences and gradual changes that occur over time.
- 2.13. A "*Calculated load value*" refers to an indication of the current airflow divided by peak airflow, where peak airflow is corrected for altitude, if available. This definition provides a dimensionless number that is not engine specific and provides the service technician with an indication of the proportion of engine capacity that is being used (with wide open throttle as 100 per cent);

$$CLV = \frac{\text{Current airflow}}{\text{Peak airflow (at sea level)}} \cdot \frac{\text{Atmospheric pressure (at sea level)}}{\text{Barometric pressure}}$$

- 2.14. "*Permanent emission default mode*" refers to a case where the engine management controller permanently switches to a setting that does not require an input from a failed component or system where such a failed component or system would result in an increase in emissions from the vehicle to a level above the limits given in paragraph 3.3.2. of this annex.
- 2.15. "*Power take-off unit*" means an engine-driven output provision for the purposes of powering auxiliary, vehicle mounted, equipment.
- 2.16. "*Access*" means the availability of all emission-related OBD data including all fault codes required for the inspection, diagnosis, servicing or repair of emissions-related parts of the vehicle, via the serial interface for the standard diagnostic connection (pursuant to paragraph 6.5.3.5. of Appendix 1 to this annex).
- 2.17. "*Unrestricted*" means:
- 2.17.1. Access not dependent on an access code obtainable only from the manufacturer, or a similar device; or
- 2.17.2. Access allowing evaluation of the data produced without the need for any unique decoding information, unless that information itself is standardised.
- 2.18. "*Standardised*" means that all data stream information, including all fault codes used, shall be produced only in accordance with industry standards which, by virtue of the fact that their format and their permitted options are clearly defined, provide for a maximum level of harmonisation in the motor vehicle industry, and whose use is expressly permitted in this Regulation.
- 2.19. "*Repair information*" means all information required for diagnosis, servicing, inspection, periodic monitoring or repair of the vehicle and which the manufacturers provide for their authorised dealers/repair shops. Where necessary, such information shall include service handbooks, technical manuals, diagnosis information (e.g. minimum and maximum theoretical values for measurements), wiring diagrams, the software calibration identification number applicable to a vehicle type, instructions for individual and special cases, information provided concerning tools and equipment, data

record information and two-directional monitoring and test data. The manufacturer shall not be obliged to make available that information which is covered by intellectual property rights or constitutes specific know-how of manufacturers and/or OEM suppliers; in this case the necessary technical information shall not be improperly withheld.

2.20. "Deficiency" means, in respect of vehicle OBD systems, that up to two separate components or systems that are monitored contain temporary or permanent operating characteristics that impair the otherwise efficient OBD monitoring of those components or systems or do not meet all of the other detailed requirements for OBD. Vehicles may be type-approved, registered and sold with such deficiencies according to the requirements of paragraph 4. of this annex.

3. Requirements and tests

3.1. All vehicles shall be equipped with an OBD system so designed, constructed and installed in a vehicle as to enable it to identify types of deterioration or malfunction over the entire life of the vehicle. In achieving this objective the Type Approval Authority shall accept that vehicles which have travelled distances in excess of the Type V durability distance (according to Annex 9 to this Regulation) referred to in paragraph 3.3.1. of this annex, may show some deterioration in OBD system performance such that the emission limits given in paragraph 3.3.2. of this annex may be exceeded before the OBD system signals a failure to the driver of the vehicle.

3.1.1. Access to the OBD system required for the inspection, diagnosis, servicing or repair of the vehicle shall be unrestricted and standardised. All emission-related fault codes shall be consistent with paragraph 6.5.3.4. of Appendix 1 to this annex.

3.1.2. No later than three months after the manufacturer has provided any authorised dealer or repair shop with repair information, the manufacturer shall make that information (including all subsequent amendments and supplements) available upon reasonable and non-discriminatory payment and shall notify the Type Approval Authority accordingly.

In the event of failure to comply with these provisions the Type Approval Authority shall act to ensure that repair information is available, in accordance with the procedures laid down for type approval and in-service surveys.

3.2. The OBD system shall be so designed, constructed and installed in a vehicle as to enable it to comply with the requirements of this annex during conditions of normal use.

3.2.1. Temporary disablement of the OBD system

3.2.1.1. A manufacturer may disable the OBD system if its ability to monitor is affected by low fuel levels. Disablement shall not occur when the fuel tank level is above 20 per cent of the nominal capacity of the fuel tank.

3.2.1.2. A manufacturer may disable the OBD system at ambient engine starting temperatures below 266 K (-7 °C) or at elevations over 2,500 metres above sea level provided the manufacturer submits data and/or an engineering evaluation which adequately demonstrate that monitoring would be unreliable when such conditions exist. A manufacturer may also request disablement of the OBD system at other ambient engine starting temperatures if he demonstrates to the authority with data and/or an engineering evaluation that misdiagnosis would occur under such conditions. It is not necessary to

illuminate the malfunction indicator (MI) if the OBD thresholds are exceeded during a regeneration provided no defect is present.

- 3.2.1.3. For vehicles designed to accommodate the installation of power take-off units, disablement of affected monitoring systems is permitted provided disablement occurs only when the power take-off unit is active.

In addition to the provisions of this paragraph the manufacturer may temporarily disable the OBD system in the following conditions:

- (a) For flex fuel or mono/bi fuel gas vehicles during 1 minute after re-fuelling to allow for the recognition of fuel quality and composition by the ECU;
- (b) For bi fuel vehicles during 5 seconds after fuel switching to allow for readjusting engine parameters;
- (c) The manufacturer may deviate from these time limits if it can demonstrate that stabilisation of the fuelling system after re-fuelling or fuel switching takes longer for justified technical reasons. In any case, the OBD system shall be re-enabled as soon as either the fuel quality and composition is recognised, or the engine parameters are readjusted.

- 3.2.2. Engine misfire in vehicles equipped with positive-ignition engines

- 3.2.2.1. Manufacturers may adopt higher misfire percentage malfunction criteria than those declared to the authority, under specific engine speed and load conditions where it can be demonstrated to the authority that the detection of lower levels of misfire would be unreliable.

- 3.2.2.2. When a manufacturer can demonstrate to the authority that the detection of higher levels of misfire percentages is still not feasible, or that misfire cannot be distinguished from other effects (e.g. rough roads, transmission shifts, after engine starting; etc.) the misfire monitoring system may be disabled when such conditions exist.

- 3.3. Description of tests

- 3.3.1. The tests are carried out on the vehicle used for the Type V durability test, given in Annex 9 to this Regulation, and using the test procedure in Appendix 1 to this annex. Tests are carried out at the conclusion of the Type V durability testing.

When no Type V durability testing is carried out, or at the request of the manufacturer, a suitably aged and representative vehicle may be used for these OBD demonstration tests.

- 3.3.2. The OBD system shall indicate the failure of an emission-related component or system when that failure results in emissions exceeding the threshold limits given in Table A11/1, Table A11/2, or Table A11/3 in accordance with the provisions of paragraph 12. of this Regulation:

- 3.3.2.1. The OBD thresholds limits for vehicles that are type approved according to the emission limits set out in Table 1 in paragraph 5.3.1.4. of this Regulation from the dates given in paragraphs 12.2.3. and 12.2.4. of this Regulation for new type approvals and new vehicles respectively are given in Table A11/1:

Table A11/1: Final OBD threshold limits

Category	Class	Reference mass (RM) (kg)	Mass of carbon monoxide		Mass of non- methane hydrocarbons		Mass of oxides of nitrogen		Mass of particulate matter ¹		Number of particles ¹	
			(CO) (mg/km)	(CI) (mg/km)	(NMHC) (mg/km)	(CI) (mg/km)	(NO _x) (mg/km)	(CI) (mg/km)	(PI) (mg/km)	(CI) (#/km)	(PI) (#/km)	
M	—	All	PI	CI	PI	CI	PI	CI	CI	PI	CI	PI
N ₁	I	RM ≤ 1305	1,900	1,750	170	290	90	140	12	12		
	II	1305 < RM ≤ 1760	3,400	2,200	225	320	110	180	12	12		
	III	1760 < RM	4,300	2,500	270	350	120	220	12	12		
N ₂	—	All	4,300	2,500	270	350	120	220	12	12		

Key PI Positive Ignition
CI Compression Ignition.

¹ Positive ignition particulate mass and number limits apply only to vehicles with direct injection engines

3.3.2.2. Until the dates specified in paragraphs 12.2.3. and 12.2.4. of this Regulation for new type approvals and new vehicles respectively, the OBD threshold limits in Table A11/2 shall be applied to vehicles that are type approved according to the emission limits set out in Table 1 in paragraph 5.3.1.4. of this Regulation, upon the choice of the manufacturer:

Table A11/2: Preliminary OBD threshold limits

Category	Class	Reference mass (RM) (kg)	Mass of carbon monoxide		Mass of non-methane hydrocarbons		Mass of oxides of nitrogen		Mass of particulate matter ¹	
			(CO) (mg/km)	(CI) (mg/km)	(NMHC) (mg/km)	(CI) (mg/km)	(NO _x) (mg/km)	(CI) (mg/km)	(CI) (mg/km)	(PI) (mg/km)
M	—	All	PI	CI	PI	CI	PI	CI	CI	PI
N ₁	I	RM ≤ 1305	1,900	1,750	170	290	150	180	25	25
	II	1305 < RM ≤ 1760	3,400	2,200	225	320	190	220	25	25
	III	1760 < RM	4,300	2,500	270	350	210	280	30	30
N ₂	—	All	4,300	2,500	270	350	210	280	30	30

Key PI Positive Ignition
CI Compression Ignition.

¹ Positive ignition particulate mass and number limits apply only to vehicles with direct injection engines

3.3.2.3. The OBD thresholds limits for compression ignition vehicles that comply with the emission limit values set out Table 1 in paragraph 5.3.1.4. of this Regulation and type-approved before the dates given in paragraph 12.2.1. of this Regulation are contained in the Table A11/3. These threshold limits shall cease to apply from the dates set out in paragraph 12.2.2. of this Regulation for new vehicles to be registered, sold or entered into service.

Table A11/3: Interim OBD threshold limits

Category	Class	Reference mass (RM) (kg)	Mass of carbon monoxide		Mass of non-methane hydrocarbons		Mass of oxides of nitrogen		Mass of particulate matter	
			(CO) (mg/km)	(CI) (mg/km)	(NMHC) (mg/km)	(CI) (mg/km)	(NO _x) (mg/km)	(CI) (mg/km)	(CI) (mg/km)	(CI) (mg/km)
M	—	All	CI	CI	CI	CI	CI	CI	CI	CI
N ₁	I	RM ≤ 1305	1,900	320	240	50				
	II	1305 < RM ≤ 1760	2,400	360	240	50				
	III	1760 < RM	2,800	400	315	50				
N ₂	—	All	2,800	400	375	50				

Key PI Positive Ignition
CI Compression Ignition.

- 3.3.3. Monitoring requirements for vehicles equipped with positive-ignition engines;
- In satisfying the requirements of paragraph 3.3.2. of this annex the OBD system shall, at a minimum, monitor for:
- 3.3.3.1. The reduction in the efficiency of the catalytic converter with respect to emissions of THC and NO_x. Manufacturers may monitor the front catalyst alone or in combination with the next catalyst(s) downstream. Each monitored catalyst or catalyst combination shall be considered malfunctioning when the emissions exceed the NMHC or NO_x threshold limits provided for by paragraph 3.3.2. of this annex.
- 3.3.3.2. The presence of engine misfire in the engine operating region bounded by the following lines:
- (a) A maximum speed of 4,500 min⁻¹ or 1,000 min⁻¹ greater than the highest speed occurring during a Type I Test cycle, whichever is the lower;
 - (b) The positive torque line (i.e. engine load with the transmission in neutral);
 - (c) A line joining the following engine operating points: the positive torque line at 3,000 min⁻¹ and a point on the maximum speed line defined in (a) above with the engine's manifold vacuum at 13.33 kPa lower than that at the positive torque line.
- 3.3.3.3. Oxygen sensor deterioration
- This paragraph shall mean that the deterioration of all oxygen sensors fitted and used for monitoring malfunctions of the catalytic converter according to the requirements of this annex shall be monitored.
- 3.3.3.4. If active on the selected fuel, other emission control system components or systems, or emission related power train components or systems which are connected to a computer, the failure of which may result in tailpipe emissions exceeding the limits given in paragraph 3.3.2. of this annex;
- 3.3.3.5. Unless otherwise monitored, any other emission-related power-train component connected to a computer, including any relevant sensors to enable monitoring functions to be carried out, shall be monitored for circuit continuity;
- 3.3.3.6. The electronic evaporative emission purge control shall, at a minimum, be monitored for circuit continuity.
- 3.3.3.7. For direct injection positive ignition engines any malfunction, which may lead to emissions exceeding the particulate threshold limits provided for by paragraph 3.3.2. of this annex and which has to be monitored according to the requirements of this annex for compression ignition engines, shall be monitored.
- 3.3.4. Monitoring requirements for vehicles equipped with compression-ignition engines
- In satisfying the requirements of paragraph 3.3.2. of this annex the OBD system shall monitor:
- 3.3.4.1. Where fitted, reduction in the efficiency of the catalytic converter;
- 3.3.4.2. Where fitted, the functionality and integrity of the particulate trap;

- 3.3.4.3. The fuel-injection system electronic fuel quantity and timing actuator(s) is/are monitored for circuit continuity and total functional failure;
- 3.3.4.4. Other emission control system components or systems, or emission-related power-train components or systems, which are connected to a computer, the failure of which may result in exhaust emissions exceeding the limits given in paragraph 3.3.2. of this annex. Examples of such systems or components are those for monitoring and control of air mass-flow, air volumetric flow (and temperature), boost pressure and inlet manifold pressure (and relevant sensors to enable these functions to be carried out).
- 3.3.4.5. Unless otherwise monitored, any other emission-related power-train component connected to a computer shall be monitored for circuit continuity.
- 3.3.4.6. Malfunctions and the reduction in efficiency of the EGR system shall be monitored.
- 3.3.4.7. Malfunctions and the reduction in efficiency of a NO_x after-treatment system using a reagent and the reagent dosing sub-system shall be monitored.
- 3.3.4.8. Malfunctions and the reduction in efficiency of NO_x after-treatment not using a reagent shall be monitored.
- 3.3.4.9. The following devices should however be monitored for total failure or removal (if removal would cause the applicable emission limits to be exceeded):
 - (a) A particulate trap fitted to compression ignition engines as a separate unit or integrated into a combined emission control device;
 - (b) A NO_x aftertreatment system fitted to compression ignition engines as a separate unit or integrated into a combined emission control device;
 - (c) A diesel oxidation catalyst (DOC) fitted to compression ignition engines as a separate unit or integrated into a combined emission control device.
- 3.3.4.10. The devices referred to in paragraph 3.3.4.9. shall also be monitored for any failure that would result in exceeding the applicable OBD threshold limits.
- 3.3.5. Manufacturers may demonstrate to the Type Approval Authority that certain components or systems need not be monitored if, in the event of their total failure or removal, emissions do not exceed the emission limits given in paragraph 3.3.2. of this annex.
- 3.4. A sequence of diagnostic checks shall be initiated at each engine start and completed at least once provided that the correct test conditions are met. The test conditions shall be selected in such a way that they all occur under normal driving as represented by the Type I test.
- 3.5. Activation of malfunction indicator (MI)
- 3.5.1. The OBD system shall incorporate a malfunction indicator readily perceivable to the vehicle operator. The MI shall not be used for any other purpose except to indicate emergency start-up or limp-home routines to the driver. The MI shall be visible in all reasonable lighting conditions. When activated, it shall display a symbol in conformity with ISO 2575. A vehicle shall not be equipped with more than one general purpose MI for emission-related problems. Separate specific purpose tell tales (e. g. brake system, fasten seat belt, oil pressure, etc.) are permitted. The use of red colour for an MI is prohibited.

- 3.5.2. For strategies requiring more than two preconditioning cycles for MI activation, the manufacturer must provide data and/or an engineering evaluation which adequately demonstrates that the monitoring system is equally effective and timely in detecting component deterioration. Strategies requiring on average more than ten driving cycles for MI activation are not accepted. The MI must also activate whenever the engine control enters a permanent emission default mode of operation if the emission limits given in paragraph 3.3.2. of this annex are exceeded or if the OBD system is unable to fulfil the basic monitoring requirements specified in paragraph 3.3.3. or 3.3.4. of this annex. The MI must operate in a distinct warning mode, e.g. a flashing light, under any period during which engine misfire occurs at a level likely to cause catalyst damage, as specified by the manufacturer. The MI must also activate when the vehicle's ignition is in the "key-on" position before engine starting or cranking and de-activate after engine starting if no malfunction has previously been detected.
- 3.6. The OBD system must record fault code(s) indicating the status of the emission control system. Separate status codes must be used to identify correctly functioning emission control systems and those emission control systems which need further vehicle operation to be fully evaluated. If the MI is activated due to deterioration or malfunction or permanent emission default modes of operation, a fault code must be stored that identifies the type of malfunction. A fault code must also be stored in the cases referred to in paragraphs 3.3.3.5. and 3.3.4.5. of this annex.
- 3.6.1. The distance travelled by the vehicle while the MI is activated shall be available at any instant through the serial port on the standard link connector.
- 3.6.2. In the case of vehicles equipped with positive-ignition engines, misfiring cylinders need not be uniquely identified if a distinct single or multiple cylinder misfire fault code is stored.
- 3.7. Extinguishing the MI
- 3.7.1. If misfire at levels likely to cause catalyst damage (as specified by the manufacturer) is not present any more, or if the engine is operated after changes to speed and load conditions where the level of misfire will not cause catalyst damage, the MI may be switched back to the previous state of activation during the first driving cycle on which the misfire level was detected and may be switched to the normal activated mode on subsequent driving cycles. If the MI is switched back to the previous state of activation, the corresponding fault codes and stored freeze-frame conditions may be erased.
- 3.7.2. For all other malfunctions, the MI may be de-activated after three subsequent sequential driving cycles during which the monitoring system responsible for activating the MI ceases to detect the malfunction and if no other malfunction has been identified that would independently activate the MI.
- 3.8. Erasing a fault code
- 3.8.1. The OBD system may erase a fault code and the distance travelled and freeze-frame information if the same fault is not re-registered in at least 40 engine warm-up cycles.
- 3.9. Bi-fuelled gas vehicles
- In general, for bi-fuelled gas vehicles for each of the fuel types (petrol and (NG/biomethane)/LPG)) all the OBD requirements as for a mono-fuelled vehicle are applicable. To this end one of the following two options in

paragraphs 3.9.1. or 3.9.2. of this annex or any combination thereof, shall be used.

- 3.9.1. One OBD system for both fuel types.
- 3.9.1.1. The following procedures shall be executed for each diagnostic in a single OBD system for operation on petrol and on (NG/biomethane)/LPG, either independent of the fuel currently in use or fuel type specific:
 - (a) Activation of malfunction indicator (MI) (see paragraph 3.5. of this annex);
 - (b) Fault code storage (see paragraph 3.6. of this annex);
 - (c) Extinguishing the MI (see paragraph 3.7. of this annex);
 - (d) Erasing a fault code (see paragraph 3.8. of this annex).

For components or systems to be monitored, either separate diagnostics for each fuel type can be used or a common diagnostic.
- 3.9.1.2. The OBD system can reside in either one or more computers.
- 3.9.2. Two separate OBD systems, one for each fuel type.
- 3.9.2.1. The following procedures shall be executed independently of each other when the vehicle is operated on petrol or on (NG/biomethane)/LPG:
 - (a) Activation of malfunction indicator (MI) (see paragraph 3.5. of this annex);
 - (b) Fault code storage (see paragraph 3.6. of this annex);
 - (c) Extinguishing the MI (see paragraph 3.7. of this annex);
 - (d) Erasing a fault code (see paragraph 3.8. of this annex).
- 3.9.2.2. The separate OBD systems can reside in either one or more computers.
- 3.9.3. Specific requirements regarding the transmission of diagnostic signals from bi-fuelled gas vehicles.
- 3.9.3.1. On a request from a diagnostic scan tool, the diagnostic signals shall be transmitted on one or more source addresses. The use of source addresses is described in ISO DIS 15031-5 "Road vehicles - communication between vehicles and external test equipment for emissions-related diagnostics – Part 5: Emissions-related diagnostic services", dated 1 November 2001.
- 3.9.3.2. Identification of fuel specific information can be realized:
 - (a) By use of source addresses; and/or
 - (b) By use of a fuel select switch; and/or
 - (c) By use of fuel specific fault codes.
- 3.9.4. Regarding the status code (as described in paragraph 3.6. of this annex), one of the following two options has to be used, if one or more of the diagnostics reporting readiness is fuel type specific:
 - (a) The status code is fuel specific, i.e. use of two status codes, one for each fuel type;
 - (b) The status code shall indicate fully evaluated control systems for both fuel types (petrol and (NG/biomethane)/LPG)) when the control systems are fully evaluated for one of the fuel types.

If none of the diagnostics reporting readiness is fuel type specific, then only one status code has to be supported.

4. Requirements relating to the type-approval of on-board diagnostic systems
 - 4.1. A manufacturer may request to the authority that an OBD system be accepted for type-approval even though the system contains one or more deficiencies such that the specific requirements of this annex are not fully met.
 - 4.2. In considering the request, the authority shall determine whether compliance with the requirements of this annex is infeasible or unreasonable.

The Type Approval Authority shall take into consideration data from the manufacturer that details such factors as, but not limited to, technical feasibility, lead time and production cycles including phase-in or phase-out of engines or vehicle designs and programmed upgrades of computers, the extent to which the resultant OBD system will be effective in complying with the requirements of this Regulation and that the manufacturer has demonstrated an acceptable level of effort towards compliance with the requirements of this Regulation.

 - 4.2.1. The Type Approval Authority shall not accept any deficiency request that includes the complete lack of a required diagnostic monitor or the lack of mandated recording and reporting of data related to a monitor.
 - 4.2.2. The Type Approval Authority will not accept any deficiency request that does not respect the OBD threshold limits in paragraph 3.3.2. of this annex.
 - 4.3. In determining the identified order of deficiencies, deficiencies relating to paragraphs 3.3.3.1., 3.3.3.2. and 3.3.3.3. of this annex for positive-ignition engines and paragraphs 3.3.4.1., 3.3.4.2. and 3.3.4.3. of this annex for compression-ignition engines shall be identified first.
 - 4.4. Prior to or at the time of type-approval, no deficiency shall be granted in respect of the requirements of paragraph 6.5., except paragraph 6.5.3.4., of Appendix 1 to this annex.
 - 4.5. Deficiency period
 - 4.5.1. A deficiency may be carried-over for a period of two years after the date of type-approval of the vehicle type unless it can be adequately demonstrated that substantial vehicle hardware modifications and additional lead-time beyond two years would be necessary to correct the deficiency. In such a case, the deficiency may be carried-over for a period not exceeding three years.
 - 4.5.2. A manufacturer may request that the Approval Authority grant a deficiency retrospectively when such a deficiency is discovered after the original type-approval. In this case, the deficiency may be carried-over for a period of two years after the date of notification to the Type Approval Authority unless it can be adequately demonstrated that substantial vehicle hardware modifications and additional lead-time beyond two years would be necessary to correct the deficiency. In such a case, the deficiency may be carried-over for a period not exceeding three years.
 - 4.6. The authority shall notify its decision in granting a deficiency request to all other Contracting Parties to the 1958 Agreement applying this Regulation.
5. Access to OBD information
 - 5.1. Applications for type-approval or amendment of a type-approval shall be accompanied by the relevant information concerning the vehicle OBD

system. This relevant information shall enable manufacturers of replacement or retrofit components to make the parts they manufacture compatible with the vehicle OBD system with a view to fault-free operation assuring the vehicle user against malfunctions. Similarly, such relevant information shall enable the manufacturers of diagnostic tools and test equipment to make tools and equipment that provide for effective and accurate diagnosis of vehicle emission control systems.

- 5.2. Upon request, the Type Approval Authorities shall make Appendix 1 to Annex 2 to this Regulation containing the relevant information on the OBD system available to any interested components, diagnostic tools or test equipment manufacturer on a non-discriminatory basis.
- 5.2.1. If an Type Approval Authority receives a request from any interested components, diagnostic tools or test equipment manufacturer for information on the OBD system of a vehicle that has been type-approved to a previous version of this Regulation,
- (a) The Type Approval Authority shall, within 30 days, request the manufacturer of the vehicle in question to make available the information required in item 3.2.12.2.7.6. of Annex 1 to this Regulation. The requirement of the second section of item 3.2.12.2.7.6. of Annex 1 (i.e. the following text "unless such information is covered by intellectual property rights or constitutes specific know-how of the manufacturer or the OEM supplier(s)") is not applicable;
 - (b) The manufacturer shall submit this information to the Type Approval Authority within two months of the request;
 - (c) The Type Approval Authority shall transmit this information to the Type Approval Authorities of the Contracting Parties and the Type Approval Authority which granted the original type-approval shall attach this information to Annex 1 to this Regulation of the vehicle type-approval information.

This requirement shall not invalidate any approval previously granted pursuant to Regulation No. 83 nor prevent extensions to such approvals under the terms of the Regulation under which they were originally granted.

- 5.2.2. Information can only be requested for replacement or service components that are subject to UNECE type-approval, or for components that form part of a system that is subject to UNECE type-approval.
- 5.2.3. The request for information must identify the exact specification of the vehicle model for which the information is required. It must confirm that the information is required for the development of replacement or retrofit parts or components or diagnostic tools or test equipment.

Annex 11 - Appendix 1

Functional aspects of on-board diagnostic (OBD) systems

1. Introduction

This appendix describes the procedure of the test according to paragraph 3. of this annex. The procedure describes a method for checking the function of the on-board diagnostic (OBD) system installed on the vehicle by failure simulation of relevant systems in the engine management or emission control system. It also sets procedures for determining the durability of OBD systems.

The manufacturer shall make available the defective components and/or electrical devices which would be used to simulate failures. When measured over the Type I Test cycle, such defective components or devices shall not cause the vehicle emissions to exceed the limits of paragraph 3.3.2. of this annex by more than 20 per cent.

When the vehicle is tested with the defective component or device fitted, the OBD system is approved if the MI is activated. The OBD system is also approved if the MI is activated below the OBD threshold limits.

2. Description of test

2.1. The testing of OBD systems consists of the following phases:

2.1.1. Simulation of malfunction of a component of the engine management or emission control system,

2.1.2. Preconditioning of the vehicle with a simulated malfunction over preconditioning specified in paragraphs 6.2.1. or 6.2.2. of this appendix.

2.1.3. Driving the vehicle with a simulated malfunction over the Type I Test cycle and measuring the emissions of the vehicle,

2.1.4. Determining whether the OBD system reacts to the simulated malfunction and indicates malfunction in an appropriate manner to the vehicle driver.

2.2. Alternatively, at the request of the manufacturer, malfunction of one or more components may be electronically simulated according to the requirements of paragraph 6. of this appendix.

2.3. Manufacturers may request that monitoring take place outside the Type I Test cycle if it can be demonstrated to the authority that monitoring during conditions encountered during the Type I Test cycle would impose restrictive monitoring conditions when the vehicle is used in service.

3. Test vehicle and fuel

3.1. Vehicle

The test vehicle shall meet the requirements of paragraph 3.2. of Annex 4a to this Regulation.

3.2. Fuel

The appropriate reference fuel as described in Annex 10 or Annex 10a to this Regulation must be used for testing. The fuel type for each failure mode to be tested (described in paragraph 6.3. of this appendix) may be selected by the Type Approval Authority from the reference fuels described in Annex 10a to

this Regulation in the case of the testing of a mono-fuelled gas vehicle and from the reference fuels described in Annex 10 and Annex 10a to this Regulation in the case of the testing of a bi-fuelled gas vehicle. The selected fuel type must not be changed during any of the test phases (described in paragraphs 2.1. to 2.3. of this appendix). In the case of the use of LPG or NG/biomethane as a fuel it is permissible that the engine is started on petrol and switched to LPG or NG/biomethane after a pre-determined period of time which is controlled automatically and not under the control of the driver.

4. Test temperature and pressure
 - 4.1. The test temperature and pressure shall meet the requirements of the Type I Test as described in paragraph 3.1. of Annex 4a to this Regulation.
5. Test equipment
 - 5.1. Chassis dynamometer

The chassis dynamometer shall meet the requirements of Appendix 1 to Annex 4a to this Regulation.
6. OBD test procedure
 - 6.1. The operating cycle on the chassis dynamometer shall meet the requirements of Annex 4a to this Regulation.
 - 6.2. Vehicle preconditioning
 - 6.2.1. According to the engine type and after introduction of one of the failure modes given in paragraph 6.3. of this appendix, the vehicle shall be preconditioned by driving at least two consecutive Type I tests (Parts One and Two). For compression-ignition engines an additional preconditioning of two Part Two cycles is permitted.
 - 6.2.2. At the request of the manufacturer, alternative preconditioning methods may be used.
 - 6.3. Failure modes to be tested
 - 6.3.1. Positive-ignition engines:
 - 6.3.1.1. Replacement of the catalyst with a deteriorated or defective catalyst or electronic simulation of such a failure.
 - 6.3.1.2. Engine misfire conditions according to the conditions for misfire monitoring given in paragraph 3.3.3.2. of Annex 11 to this Regulation.
 - 6.3.1.3. Replacement of the oxygen sensor with a deteriorated or defective oxygen sensor or electronic simulation of such a failure.
 - 6.3.1.4. Electrical disconnection of any other emission-related component connected to a power-train management computer (if active on the selected fuel type).
 - 6.3.1.5. Electrical disconnection of the electronic evaporative purge control device (if equipped and if active on the selected fuel type). For this specific failure mode, the Type I Test need not be performed.
 - 6.3.2. Compression-ignition engines:
 - 6.3.2.1. Where fitted, replacement of the catalyst with a deteriorated or defective catalyst or electronic simulation of such a failure.
 - 6.3.2.2. Where fitted, total removal of the particulate trap or, where sensors are an integral part of the trap, a defective trap assembly.

- 6.3.2.3. Electrical disconnection of any fuelling system electronic fuel quantity and timing actuator.
- 6.3.2.4. Electrical disconnection of any other emission-related component connected to a power-train management computer.
- 6.3.2.5. In meeting the requirements of paragraphs 6.3.2.3. and 6.3.2.4. of this appendix, and with the agreement of the Type Approval Authority, the manufacturer shall take appropriate steps to demonstrate that the OBD system will indicate a fault when disconnection occurs.
- 6.3.2.6. The manufacturer shall demonstrate that malfunctions of the EGR flow and cooler are detected by the OBD system during its approval test.
- 6.4. OBD system test
- 6.4.1. Vehicles fitted with positive-ignition engines:
- 6.4.1.1. After vehicle preconditioning according to paragraph 6.2. of this appendix, the test vehicle is driven over a Type I test (Parts One and Two).
- The MI shall activate before the end of this test under any of the conditions given in paragraphs 6.4.1.2. to 6.4.1.5. of this appendix. The Technical Service may substitute those conditions with others in accordance with paragraph 6.4.1.6. of this appendix. However, the total number of failures simulated shall not exceed four (4) for the purpose of type approval.
- In the case of testing a bi-fuel gas vehicle, both fuel types shall be used within the maximum of four (4) simulated failures at the discretion of the Type Approval Authority.
- 6.4.1.2. Replacement of a catalyst with a deteriorated or defective catalyst or electronic simulation of a deteriorated or defective catalyst that results in emissions exceeding the NMHC limit given in paragraph 3.3.2. of this annex.
- 6.4.1.3. An induced misfire condition according to the conditions for misfire monitoring given in paragraph 3.3.3.2. of this annex that results in emissions exceeding any of the limits given in paragraph 3.3.2. of this annex.
- 6.4.1.4. Replacement of an oxygen sensor with a deteriorated or defective oxygen sensor or electronic simulation of a deteriorated or defective oxygen sensor that results in emissions exceeding any of the limits given in paragraph 3.3.2. of this annex.
- 6.4.1.5. Electrical disconnection of the electronic evaporative purge control device (if equipped and if active on the selected fuel type).
- 6.4.1.6. Electrical disconnection of any other emission-related power-train component connected to a computer that results in emissions exceeding any of the limits given in paragraph 3.3.2. of this annex (if active on the selected fuel type).
- 6.4.2. Vehicles fitted with compression-ignition engines:
- 6.4.2.1. After vehicle preconditioning according to paragraph 6.2. of this appendix, the test vehicle is driven over a Type I test (Parts One and Two).
- The MI shall activate before the end of this test under any of the conditions given in paragraphs 6.4.2.2. to 6.4.2.5. of this appendix. The technical service may substitute those conditions by others in accordance with paragraph 6.4.2.5. of this appendix. However, the total number of failures simulated shall not exceed four (4) for the purposes of type approval.

- 6.4.2.2. Where fitted, replacement of a catalyst with a deteriorated or defective catalyst or electronic simulation of a deteriorated or defective catalyst that results in emissions exceeding limits given in paragraph 3.3.2. of this annex.
- 6.4.2.3. Where fitted, total removal of the particulate trap or replacement of the particulate trap with a defective particulate trap meeting the conditions of paragraph 6.3.2.2. of this appendix that results in emissions exceeding the limits given in paragraph 3.3.2. of this annex.
- 6.4.2.4. With reference to paragraph 6.3.2.5. of this appendix, disconnection of any fuelling system electronic fuel quantity and timing actuator that results in emissions exceeding any of the limits given in paragraph 3.3.2. of this annex.
- 6.4.2.5. With reference to paragraph 6.3.2.5. of this appendix, disconnection of any other emission-related power-train component connected to a computer that results in emissions exceeding any of the limits given in paragraph 3.3.2. of this annex.
- 6.5. Diagnostic signals
 - 6.5.1. *Reserved*
 - 6.5.1.1. Upon determination of the first malfunction of any component or system, "freeze-frame" engine conditions present at the time shall be stored in computer memory. Should a subsequent fuel system or misfire malfunction occur, any previously stored freeze-frame conditions shall be replaced by the fuel system or misfire conditions (whichever occurs first). Stored engine conditions shall include, but are not limited to calculated load value, engine speed, fuel trim value(s) (if available), fuel pressure (if available), vehicle speed (if available), coolant temperature, intake manifold pressure (if available), closed- or open-loop operation (if available) and the fault code which caused the data to be stored. The manufacturer shall choose the most appropriate set of conditions facilitating effective repairs for freeze-frame storage. Only one frame of data is required. Manufacturers may choose to store additional frames provided that at least the required frame can be read by a generic scan tool meeting the specifications of paragraphs 6.5.3.2. and 6.5.3.3. of this appendix. If the fault code causing the conditions to be stored is erased in accordance with paragraph 3.8. of this annex, the stored engine conditions may also be erased.
 - 6.5.1.2. If available, the following signals in addition to the required freeze-frame information shall be made available on demand through the serial port on the standardised data link connector, if the information is available to the on-board computer or can be determined using information available to the on-board computer: diagnostic trouble codes, engine coolant temperature, fuel control system status (closed-loop, open-loop, other), fuel trim, ignition timing advance, intake air temperature, manifold air pressure, air flow rate, engine speed, throttle position sensor output value, secondary air status (upstream, downstream or atmosphere), calculated load value, vehicle speed and fuel pressure.

The signals shall be provided in standard units based on the specifications given in paragraph 6.5.3. of this appendix. Actual signals shall be clearly identified separately from default value or limp-home signals.
 - 6.5.1.3. For all emission control systems for which specific on-board evaluation tests are conducted (catalyst, oxygen sensor, etc.), except misfire detection, fuel system monitoring and comprehensive component monitoring, the results of the most recent test performed by the vehicle and the limits to which the system is compared shall be made available through the serial data port on

the standardised data link connector according to the specifications given in paragraph 6.5.3. of this appendix. For the monitored components and systems excepted above, a pass/fail indication for the most recent test results shall be available through the data link connector.

All data required to be stored in relation to OBD in-use performance according to the provisions of paragraph 7.6. of this appendix shall be available through the serial data port on the standardized data link connector according to the specifications given in paragraph 6.5.3. of this appendix.

- 6.5.1.4. The OBD requirements to which the vehicle is certified (i.e. Annex 11 or the alternative requirements specified in paragraph 5. of this Regulation) and the major emission control systems monitored by the OBD system consistent with paragraph 6.5.3.3. of this appendix shall be available through the serial data port on the standardised data link connector according to the specifications given in paragraph 6.5.3. of this appendix.
- 6.5.1.5. For all types of vehicles entering into service, the software calibration identification number shall be made available through the serial port on the standardised data link connector. The software calibration identification number shall be provided in a standardised format.
- 6.5.2. The emission control diagnostic system is not required to evaluate components during malfunction if such evaluation would result in a risk to safety or component failure.
- 6.5.3. The emission control diagnostic system must provide for standardised and unrestricted access and conform with the following ISO standards and/or SAE specification.
- 6.5.3.1. One of the following standards with the restrictions as described must be used as the on-board to off-board communications link:
- ISO 9141 - 2: 1994 (amended 1996) "Road Vehicles – Diagnostic Systems – Part 2: CARB requirements for interchange of digital information;
- SAE J1850: March 1998 Class B Data Communication Network Interface". Emission-related messages must use the cyclic redundancy check and the three-byte header and not use inter-byte separation or checksums;
- ISO 14230 – Part 4 "Road Vehicles – Keyword protocol 2000 for diagnostic systems – Part 4: Requirements for emission-relate systems";
- ISO DIS 15765-4 "Road vehicles – Diagnostics on Controller Area Network (CAN) – Part 4: Requirements for emissions-related systems", dated 1 November 2001.
- 6.5.3.2. Test equipment and diagnostic tools needed to communicate with OBD systems must meet or exceed the functional specification given in ISO DIS 15031-4 "Road vehicles – Communication between vehicle and external test equipment for emissions-related diagnostics – Part 4: External test equipment", dated 1 November 2001.
- 6.5.3.3. Basic diagnostic data, (as specified in paragraphs 6.5.1.1. to 6.5.1.5. of this appendix) and bi-directional control information must be provided using the format and units described in ISO DIS 15031-5 "Road vehicles – Communication between vehicle and external test equipment for emissions-related diagnostics – Part 5: Emissions-related diagnostic services", dated 1 November 2001, and must be available using a diagnostic tool meeting the requirements of ISO DIS 15031-4.

- The vehicle manufacturer shall provide to a national standardisation body the details of any emission-related diagnostic data, e.g. PIDs, OBD monitor Ids, Test Ids not specified in ISO DIS 15031-5 but related to this Regulation.
- 6.5.3.4. When a fault is registered, the manufacturer must identify the fault using an appropriate fault code consistent with those given in Section 6.3. of ISO DIS 15031-6 “Road vehicles – Communication between vehicle and external test equipment for emissions-related diagnostics – Part 6: Diagnostic trouble code definitions”, relating to “emission related system diagnostic trouble codes”. If such identification is not possible, the manufacturer may use diagnostic trouble codes according to Sections 5.3. and 5.6. of ISO DIS 15031-6. The fault codes must be fully accessible by standardised diagnostic equipment complying with the provisions of paragraph 6.5.3.2. of this appendix.
- The vehicle manufacturer shall provide to a national standardisation body the details of any emission-related diagnostic data, e.g. PID’s, OBD monitor Id’s, Test Id’s not specified in ISO DIS 15031-5 but related to this Regulation.
- 6.5.3.5. The connection interface between the vehicle and the diagnostic tester must be standardised and must meet all the requirements of ISO DIS 15031-3 “Road vehicles – Communication between vehicle and external test equipment for emissions-related diagnostics – Part 3: Diagnostic connector and related electrical circuits: specification and use”, dated 1 November 2001. The installation position must be subject to agreement of the Type Approval Authority such that it is readily accessible by service personnel but protected from tampering by non-qualified personnel.
- 6.5.3.6. The manufacturer shall also make accessible, where appropriate on payment, the technical information required for the repair or maintenance of motor vehicles unless that information is covered by an intellectual property right or constitutes essential, secret know-how which is identified in an appropriate form; in such case, the necessary technical information shall not be withheld improperly.
- Entitled to such information is any person engaged in commercially servicing or repairing, road-side rescuing, inspecting or testing of vehicles or in the manufacturing or selling replacement or retro-fit components, diagnostic tools and test equipment.
7. In-use performance
- 7.1. General Requirements
- 7.1.1. Each monitor of the OBD system shall be executed at least once per driving cycle in which the monitoring conditions as specified in paragraph 7.2. of this appendix are met. Manufacturers may not use the calculated ratio (or any element thereof) or any other indication of monitor frequency as a monitoring condition for any monitor.
- 7.1.2. The in-use performance ratio (IUPR) of a specific monitor M of the OBD systems and in-use performance of pollution control devices shall be:
- $$IUPR_M = \text{Numerator}_M / \text{Denominator}_M$$
- 7.1.3. Comparison of Numerator and Denominator gives an indication of how often a specific monitor is operating relative to vehicle operation. To ensure all manufacturers are tracking IUPR_M in the same manner, detailed requirements are given for defining and incrementing these counters.

- 7.1.4. If, according to the requirements of this annex, the vehicle is equipped with a specific monitor M, $IUPR_M$ shall be greater or equal to the following minimum values:
- (a) 0.260 for secondary air system monitors and other cold start related monitors;
 - (b) 0.520 for evaporative emission purge control monitors;
 - (c) 0.336 for all other monitors.
- 7.1.5. Vehicles shall comply with the requirements of paragraph 7.1.4. of this appendix for a mileage of at least 160,000 km. By way of derogation, vehicle types approved, registered, sold or entered into service before the relevant dates given in paragraphs 12.2.1. and 12.2.2. of this Regulation, shall have an $IUPR_M$ greater or equal to 0.1 for all monitors M. For new type approvals and new vehicles the monitor required by paragraph 3.3.4.7. of this annex shall have an $IUPR$ greater or equal to 0.1 until the dates specified in paragraphs 12.2.3. and 12.2.4. of this Regulation respectively.
- 7.1.6. The requirements of this paragraph are deemed to be met for a particular monitor M, if for all vehicles of a particular OBD family manufactured in a particular calendar year the following statistical conditions hold:
- (a) The average $IUPR_M$ is equal or above the minimum value applicable to the monitor;
 - (b) More than 50 per cent of all vehicles have an $IUPR_M$ equal or above the minimum value applicable to the monitor.
- 7.1.7. The manufacturer shall demonstrate to the Type Approval Authority that these statistical conditions are satisfied all monitors required to be reported by the OBD system according to paragraph 7.6. of this appendix not later than 18 months thereafter. For this purpose, for OBD families consisting of more than 1,000 registrations in the European Union or non-EU Contracting Party, that are subject to sampling within the sampling period, the process described in paragraph 9. of this Regulation shall be used without prejudice to the provisions of paragraph 7.1.9. of this appendix.

In addition to the requirements set out in paragraph 9. of this Regulation and regardless of the result of the audit described in paragraph 9.2. of this Regulation, the authority granting the approval shall apply the in-service conformity check for $IUPR$ described in Appendix 3 to this Regulation in an appropriate number of randomly determined cases. "In an appropriate number of randomly determined cases" means that this measure has a dissuasive effect on non-compliance with the requirements of paragraph 7. of this appendix or the provision of manipulated, false or non-representative data for the audit. If no special circumstances apply and can be demonstrated by the type-approval authorities, random application of the in-service conformity check to 5 per cent of the type approved OBD families shall be considered as sufficient for compliance with this requirement. For this purpose, type-approval authorities may find arrangements with the manufacturer for the reduction of double testing of a given OBD family as long as these arrangements do not harm the dissuasive effect of the Type Approval Authority's own in-service conformity check on non-compliance with the requirements of this paragraph 7. of this appendix. Data collected by EU-member States during surveillance testing programmes may be used for in-service conformity checks. Upon request, type-approval authorities shall provide data on the audits and random in-service conformity checks performed, including the methodology used for identifying those cases,

which are made subject to the random in-service conformity check, to the European Commission and other Type Approval Authorities.

- 7.1.8. For the entire test sample of vehicles the manufacturer must report to the relevant authorities all of the in-use performance data to be reported by the OBD system according to paragraph 7.6. of this appendix in conjunction with an identification of the vehicle being tested and the methodology used for the selection of the tested vehicles from the fleet. Upon request, the type-approval authority granting the approval shall make these data and the results of the statistical evaluation available to the European Commission and other approval authorities.
- 7.1.9. Public authorities and their delegates may pursue further tests on vehicles or collect appropriate data recorded by vehicles to verify compliance with the requirements of this annex.
- 7.2. Numerator_M
- 7.2.1. The numerator of a specific monitor is a counter measuring the number of times a vehicle has been operated such that all monitoring conditions necessary for the specific monitor to detect a malfunction in order to warn the driver, as they have been implemented by the manufacturer, have been encountered. The numerator shall not be incremented more than once per driving cycle, unless there is reasoned technical justification.
- 7.3. Denominator_M
- 7.3.1. The purpose of the denominator is to provide a counter indicating the number of vehicle driving events, taking into account special conditions for a specific monitor. The denominator shall be incremented at least once per driving cycle, if during this driving cycle such conditions are met and the general denominator is incremented as specified in paragraph 7.5. of this appendix unless the denominator is disabled according to paragraph 7.7. of this appendix.
- 7.3.2. In addition to the requirements of paragraph 7.3.1. of this appendix:
- (a) Secondary air system monitor denominator(s) shall be incremented if the commanded "on" operation of the secondary air system occurs for a time greater than or equal to 10 seconds. For purposes of determining this commanded "on" time, the OBD system may not include time during intrusive operation of the secondary air system solely for the purposes of monitoring.
 - (b) Denominators of monitors of systems only active during cold start shall be incremented if the component or strategy is commanded "on" for a time greater than or equal to 10 seconds.
 - (c) The denominator(s) for monitors of Variable Valve Timing (VVT) and/or control systems shall be incremented if the component is commanded to function (e.g., commanded "on", "open", "closed", "locked", etc.) on two or more occasions during the driving cycle or for a time greater than or equal to 10 seconds, whichever occurs first.
 - (d) For the following monitors, the denominator(s) shall be incremented by one if, in addition to meeting the requirements of this paragraph on at least one driving cycle, at least 800 cumulative kilometres of vehicle operation have been experienced since the last time the denominator was incremented:

- (i) Diesel oxidation catalyst;
 - (ii) Diesel particulate filter.
 - (e) Without prejudice to requirements for the increment of denominators of other monitors the denominators of monitors of the following components shall be incremented if and only if the driving cycle started with a cold start:
 - (i) Liquid (oil, engine coolant, fuel, SCR reagent) temperature sensors;
 - (ii) Clean air (ambient air, intake air, charge air, inlet manifold) temperature sensors;
 - (iii) Exhaust (EGR recirculation/cooling, exhaust gas turbo-charging, catalyst) temperature sensors;
 - (f) The denominators of monitors of the boost pressure control system shall be incremented if all of the following conditions are met:
 - (i) The general denominator conditions are fulfilled;
 - (ii) The boost pressure control system is active for a time greater than or equal to 15 seconds.
- 7.3.3. For hybrid vehicles, vehicles that employ alternative engine start hardware or strategies (e.g. integrated starter and generators), or alternative fuel vehicles (e.g. dedicated, bi-fuel, or dual-fuel applications), the manufacturer may request the approval of the Type Approval Authority to use alternative criteria to those set forth in this paragraph for incrementing the denominator. In general, the Type Approval Authority shall not approve alternative criteria for vehicles that only employ engine shut off at or near idle/vehicle stop conditions. Approval by the Type Approval Authority of the alternative criteria shall be based on the equivalence of the alternative criteria to determine the amount of vehicle operation relative to the measure of conventional vehicle operation in accordance with the criteria in this paragraph.
- 7.4. Ignition Cycle Counter
- 7.4.1. The ignition cycle counter indicates the number of ignition cycles a vehicle has experienced. The ignition cycle counter may not be incremented more than once per driving cycle.
- 7.5. General Denominator
- 7.5.1. The general denominator is a counter measuring the number of times a vehicle has been operated. It shall be incremented within 10 seconds, if and only if, the following criteria are satisfied on a single driving cycle:
- (a) Cumulative time since engine start is greater than or equal to 600 seconds while at an elevation of less than 2,440 m above sea level and at an ambient temperature of greater than or equal to -7° C;
 - (b) Cumulative vehicle operation at or above 40 km/h occurs for greater than or equal to 300 seconds while at an elevation of less than 2,440 m above sea level and at an ambient temperature of greater than or equal to -7 °C;
 - (c) Continuous vehicle operation at idle (i.e. accelerator pedal released by driver and vehicle speed less than or equal to 1.6 km/h) for greater

than or equal to 30 seconds while at an elevation of less than 2,440 m above sea level and at an ambient temperature of greater than or equal to -7 °C.

- 7.6. Reporting and increasing counters
- 7.6.1. The OBD system shall report in accordance with the ISO 15031-5 specifications the ignition cycle counter and general denominator as well as separate numerators and denominators for the following monitors, if their presence on the vehicle is required by this annex:
- (a) Catalysts (each bank to be reported separately);
 - (b) Oxygen/exhaust gas sensors, including secondary oxygen sensors (each sensor to be reported separately);
 - (c) Evaporative system;
 - (d) EGR system;
 - (e) VVT system;
 - (f) Secondary air system;
 - (g) Particulate filter;
 - (h) NO_x after-treatment system (e.g. NO_x adsorber, NO_x reagent/catalyst system);
 - (i) Boost pressure control system.
- 7.6.2. For specific components or systems that have multiple monitors, which are required to be reported by this paragraph (e.g. oxygen sensor bank 1 may have multiple monitors for sensor response or other sensor characteristics), the OBD system shall separately track numerators and denominators for each of the specific monitors except those monitoring for short circuit or open circuit failures and report only the corresponding numerator and denominator for the specific monitor that has the lowest numerical ratio. If two or more specific monitors have identical ratios, the corresponding numerator and denominator for the specific monitor that has the highest denominator shall be reported for the specific component.
- 7.6.3. All counters, when incremented, shall be incremented by an integer of one.
- 7.6.4. The minimum value of each counter is 0, the maximum value shall not be less than 65,535, notwithstanding any other requirements on standardised storage and reporting of the OBD system.
- 7.6.5. If either the numerator or denominator for a specific monitor reaches its maximum value, both counters for that specific monitor shall be divided by two before being incremented again according to the provisions set in paragraphs 7.2. and 7.3. of this appendix. If the ignition cycle counter or the general denominator reaches its maximum value, the respective counter shall change to zero at its next increment according to the provisions set in paragraphs 7.4. and 7.5. of this appendix, respectively.
- 7.6.6. Each counter shall be reset to zero only when a non-volatile memory reset occurs (e.g. reprogramming event, etc.) or, if the numbers are stored in keep-alive memory (KAM), when KAM is lost due to an interruption in electrical power to the control module (e.g. battery disconnect, etc.).
- 7.6.7. The manufacturer shall take measures to ensure that the values of numerator and denominator cannot be reset or modified, except in cases provided for explicitly in this paragraph.

- 7.7. Disablement of Numerators and Denominators and of the General Denominator
- 7.7.1. Within 10 seconds of a malfunction being detected, which disables a monitor required to meet the monitoring conditions of this annex (i.e. a pending or confirmed code is stored), the OBD system shall disable further incrementing of the corresponding numerator and denominator for each monitor that is disabled. When the malfunction is no longer detected (i.e., the pending code is erased through self-clearing or through a scan tool command), incrementing of all corresponding numerators and denominators shall resume within 10 seconds.
- 7.7.2. Within 10 seconds of the start of a power take-off operation (PTO) that disables a monitor required to meet the monitoring conditions of this annex, the OBD system shall disable further incrementing of the corresponding numerator and denominator for each monitor that is disabled. When the PTO operation ends, incrementing of all corresponding numerators and denominators shall resume within 10 seconds.
- 7.7.3. The OBD system shall disable further incrementing of the numerator and denominator of a specific monitor within 10 seconds, if a malfunction of any component used to determine the criteria within the definition of the specific monitor's denominator (i.e. vehicle speed, ambient temperature, elevation, idle operation, engine cold start, or time of operation) has been detected and the corresponding pending fault code has been stored. Incrementing of the numerator and denominator shall resume within 10 seconds when the malfunction is no longer present (e.g. pending code erased through self-clearing or by a scan tool command).
- 7.7.4. The OBD system shall disable further incrementing of the general denominator within 10 seconds, if a malfunction has been detected of any component used to determine whether the criteria in paragraph 7.5. of this appendix are satisfied (i.e. vehicle speed, ambient temperature, elevation, idle operation, or time of operation) and the corresponding pending fault code has been stored. The general denominator may not be disabled from incrementing for any other condition. Incrementing of the general denominator shall resume within 10 seconds when the malfunction is no longer present (e.g. pending code erased through self-clearing or by a scan tool command).

Annex 11 - Appendix 2

Essential characteristics of the vehicle family

1. Parameters defining the OBD family

The OBD family means a manufacturer's grouping of vehicles which, through their design, are expected to have similar exhaust emission and OBD system characteristics. Each engine of this family shall comply with the requirements of this Regulation.

The OBD family may be defined by basic design parameters which shall be common to vehicles within the family. In some cases there may be interaction of parameters. These effects shall also be taken into consideration to ensure that only vehicles with similar exhaust emission characteristics are included within an OBD family.

2. To this end, those vehicle types whose parameters described below are identical are considered to belong to the same engine/emission control/OBD system combination.

Engine:

- (a) Combustion process (i.e. positive-ignition, compression-ignition, two-stroke, four-stroke/rotary);
- (b) Method of engine fuelling (i.e. single or multi-point fuel injection); and
- (c) Fuel type (i.e. petrol, diesel, flex fuel petrol/ethanol, flex fuel diesel/biodiesel, NG/biomethane, LPG, bi fuel petrol/NG/biomethane, bi-fuel petrol/LPG).

Emission control system:

- (a) Type of catalytic converter (i.e. oxidation, three-way, heated catalyst, SCR, other);
- (b) Type of particulate trap;
- (c) Secondary air injection (i.e. with or without); and
- (d) Exhaust gas recirculation (i.e. with or without);

OBD parts and functioning.

The methods of OBD functional monitoring malfunction detection and malfunction indication to the vehicle driver.

Annex 12

Granting of an ECE type approval for a vehicle fuelled by LPG or NG/biomethane

1. Introduction

This annex describes the special requirements that apply in the case of an approval of a vehicle that runs on LPG or NG/biomethane, or that can run either on petrol or LPG or NG/biomethane in so far as the testing on LPG or NG/biomethane gas is concerned.

In the case of LPG and NG/biomethane natural gas there is on the market a large variation in fuel composition, requiring the fuelling system to adapt its fuelling rates to these compositions. To demonstrate this capability, the vehicle has to be tested in the Type I test on two extreme reference fuels and demonstrate the self-adaptability of the fuelling system. Whenever the self-adaptability of a fuelling system has been demonstrated on a vehicle, such a vehicle may be considered as a parent of a family. Vehicles that comply with the requirements of members of that family, if fitted with the same fuelling system, need to be tested on only one fuel.

2. Definitions

For the purpose of this annex the following definitions shall apply:

- 2.1. A "*family*" means a group of vehicle types fuelled by LPG or NG/biomethane, identified by a parent vehicle.
- 2.2. A "*parent vehicle*" means a vehicle that is selected to act as the vehicle on which the self-adaptability of a fuelling system is going to be demonstrated, and to which the members of a family refer. It is possible to have more than one parent vehicle in a family.
- 2.3. Member of the family
- 2.3.1. A "*member of the family*" is a vehicle that shares the following essential characteristics with its parent(s):
 - (a) It is produced by the same manufacturer;
 - (b) It is subject to the same emission limits;
 - (c) If the gas fuelling system has a central metering for the whole engine:
It has a certified power output between 0.7 and 1.15 times that of the parent vehicle.
 - (d) If the gas fuelling system has an individual metering per cylinder:
It has a certified power output per cylinder between 0.7 and 1.15 times that of the parent vehicle.
 - (e) If fitted with a catalyst, it has the same type of catalyst i.e. three way, oxidation, de-NO_x.
 - (f) It has a gas fuelling system (including the pressure regulator) from the same system manufacturer and of the same type: induction, vapour injection (single point, multipoint), liquid injection (single point, multipoint).

- (g) This gas fuelling system is controlled by an ECU of the same type and technical specification, containing the same software principles and control strategy. The vehicle may have a second ECU compared to the parent vehicle, provided that the ECU is only used to control the injectors, additional shut-off valves and the data acquisition from additional sensors.
- 2.3.2. With regard to requirements (c) and (d): in the case where a demonstration shows two gas-fuelled vehicles could be members of the same family with the exception of their certified power output, respectively P_1 and P_2 ($P_1 < P_2$), and both are tested as if were parent vehicles the family relation will be considered valid for any vehicle with a certified power output between $0.7 P_1$ and $1.15 P_2$.
3. Granting of a type approval
- Type approval is granted subject to the following requirements:
- 3.1. Exhaust emissions approval of a parent vehicle
- 3.1.1. The parent vehicle should demonstrate its capability to adapt to any fuel composition that may occur across the market. In the case of LPG there are variations in C3/C4 composition. In the case of NG/biomethane there are generally two types of fuel, high calorific fuel (H-gas) and low calorific fuel (L-gas), but with a significant spread within both ranges; they differ significantly in Wobbe index. These variations are reflected in the reference fuels.
- 3.1.2. In the case of vehicles fuelled by LPG, NG/biomethane, the parent vehicle(s) shall be tested in the Type I test on the two extreme reference fuels of Annex 10a to this Regulation. In the case of NG/biomethane, if the transition from one fuel to another is in practice aided through the use of a switch, this switch shall not be used during type approval. In such a case on the manufacturer's request and with the agreement of the Technical Service the pre-conditioning cycle referred in paragraph 6.3. of Annex 4a to this Regulation may be extended.
- 3.1.3. The vehicle is considered to conform if, under the tests and reference fuels mentioned in paragraph 3.1.2. of this annex, the vehicle complies with the emission limits.
- 3.1.4. In the case of vehicles fuelled by LPG or NG/biomethane, the ratio of emission results "r" shall be determined for each pollutant as follows:

<i>Type(s) of fuel</i>	<i>Reference fuels</i>	<i>Calculation of "r"</i>
LPG and petrol (Approval B)	Fuel A	$r = \frac{B}{A}$
or LPG only (Approval D)	Fuel B	
NG/biomethane and petrol (Approval B)	Fuel G ₂₀	$r = \frac{G_{25}}{G_{20}}$
or NG/biomethane only (Approval D)	Fuel G ₂₅	

- 3.2. Exhaust emissions approval of a member of the family:
- For the type approval of a mono fuel gas vehicle and bi fuel gas vehicles operating in gas mode, fuelled by LPG or NG/Biomethane, as a member of the family, a Type I test shall be performed with one gas reference fuel. This reference fuel may be either of the gas reference fuels. The vehicle is considered to comply if the following requirements are met:
- 3.2.1. The vehicle complies with the definition of a family member as defined in paragraph 2.3. of this annex;
- 3.2.2. If the test fuel is reference fuel A for LPG or G20 for NG/biomethane, the emission result shall be multiplied by the relevant factor "r" calculated in paragraph 3.1.4. of this annex if $r > 1$; if $r < 1$, no correction is needed;
- 3.2.3. If the test fuel is reference fuel B for LPG or G25 for NG/biomethane, the emission result shall be divided by the relevant factor "r" calculated in paragraph 3.1.4. of this annex if $r < 1$; if $r > 1$, no correction is needed;
- 3.2.4. On the manufacturer's request, the Type I test may be performed on both reference fuels, so that no correction is needed;
- 3.2.5. The vehicle shall comply with the emission limits valid for the relevant category for both measured and calculated emissions;
- 3.2.6. If repeated tests are made on the same engine the results on reference fuel G20, or A, and those on reference fuel G25, or B, shall first be averaged; the "r" factor shall then be calculated from these averaged results;
- 3.2.7. Without prejudice to paragraph 6.4.1.3. of Annex 4a to this Regulation, during the Type I test it is permissible to use petrol only or simultaneously with gas when operating in gas mode provided that the energy consumption of gas is higher than 80% per cent of the total amount of energy consumed during the test. This percentage shall be calculated in accordance with the method set out in Appendix 1 (LPG) or Appendix 2 (NG/biomethane) of this annex.
4. General conditions
- 4.1. Tests for conformity of production may be performed with a commercial fuel of which the C3/C4 ratio lies between those of the reference fuels in the case of LPG, or of which the Wobbe index lies between those of the extreme reference fuels in the case of NG/biomethane. In that case a fuel analysis needs to be present.

Annex 12 - Appendix 1

Bi-fuel gas vehicle - Calculation of LPG energy ratio

1. Measurement of the LPG mass consumed during the Type I test cycle
Measurement of the LPG mass consumed during the Type I test cycle shall be done by a fuel weighing system capable of measuring the weight of the LPG storage container during the test in accordance with the following:
an accuracy of ± 2 per cent of the difference between the readings at the beginning and at the end of the test or better.
Precautions shall be taken to avoid measurement errors.
Such precautions shall at least include the careful installation of the device according to the instrument manufacturers' recommendations and to good engineering practice.
Other measurement methods are permitted if an equivalent accuracy can be demonstrated.
2. Calculation of the LPG energy ratio
The fuel consumption value shall be calculated from the emissions of hydrocarbons, carbon monoxide, and carbon dioxide determined from the measurement results assuming that only LPG is burned during the test.
The LPG ratio of the energy consumed in the cycle is then determined as follows:
$$G_{LPG} = M_{LPG} * 10000 / (FC_{norm} * dist * d)$$
Where:
 G_{LPG} : the LPG energy ratio (%);
 M_{LPG} : the LPG mass consumed during the cycle (kg);
 FC_{norm} : the fuel consumption (l/100 km) calculated in accordance with Paragraph 1.4.3., letter (b), of Annex 6 to Regulation No. 101. If applicable, the correction factor cf in the equation used to determine FC_{norm} shall be calculated using the H/C ratio of the gaseous fuel;
dist: distance travelled during the cycle (km);
d: density $d = 0.538$ kg/litre.

Annex 12 - Appendix 2

Bi-fuel vehicle - Calculation of NG/biomethane energy ratio

1. Measurement of the CNG mass consumed during the Type I test cycle
Measurement of the CNG mass consumed during the cycle shall be done by a fuel weighing system capable to measure the CNG storage container during the test in accordance with the following:
An accuracy of ± 2 per cent of the difference between the readings at the beginning and at the end of the test or better.
Precautions shall be taken to avoid measurement errors.
Such precautions shall at least include the careful installation of the device according to the instrument manufacturers' recommendations and to good engineering practice.
Other measurement methods are permitted if an equivalent accuracy can be demonstrated.
2. Calculation of the CNG energy ratio
The fuel consumption value shall be calculated from the emissions of hydrocarbons, carbon monoxide, and carbon dioxide determined from the measurement results assuming that only CNG is burned during the test.
The CNG ratio of the energy consumed in the cycle is then determined as follows:
$$G_{\text{CNG}} = M_{\text{CNG}} * \text{cf} * 10000 / (\text{FC}_{\text{norm}} * \text{dist} * d)$$

Where:

G_{CNG} : the CNG energy ratio (%);

M_{CNG} : the CNG mass consumed during the cycle (kg);

FC_{norm} : the fuel consumption ($\text{m}^3/100 \text{ km}$) calculated in accordance with paragraph 1.4.3., letter (c), of Annex 6 to Regulation No. 101;

dist: distance travelled during the cycle (km);

d: density $d = 0.654 \text{ kg/m}^3$;

cf: correction factor, assuming the following values:

cf = 1 in case of G_{20} reference fuel;

cf = 0.78 in case of G_{25} reference fuel.

Annex 13

Emissions test procedure for a vehicle equipped with a periodically regenerating system

1. Introduction

This annex defines the specific provisions regarding type-approval of a vehicle equipped with a periodically regenerating system as defined in paragraph 2.20. of this Regulation.
2. Scope and extension of the type approval
- 2.1. Vehicle family groups equipped with periodically regenerating system

The procedure applies to vehicles equipped with a periodically regenerating system as defined in paragraph 2.20. of this Regulation. For the purpose of this annex vehicle family groups may be established. Accordingly, those vehicle types with regenerative systems, whose parameters described below are identical, or within the stated tolerances, shall be considered to belong to the same family with respect to measurements specific to the defined periodically regenerating systems.
- 2.1.1. Identical parameters are:

Engine:

 - (a) Combustion process.

Periodically regenerating system (i.e. catalyst, particulate trap):

 - (a) Construction (i.e. type of enclosure, type of precious metal, type of substrate, cell density);
 - (b) Type and working principle;
 - (c) Dosage and additive system;
 - (d) Volume ± 10 per cent;
 - (e) Location (temperature ± 50 °C at 120 km/h or 5 per cent difference of maximum temperature/pressure).
- 2.2. Vehicle types of different reference masses

The K_i factors developed by the procedures in this annex for type approval of a vehicle type with a periodically regenerating system as defined in paragraph 2.20. of this Regulation, may be extended to other vehicles in the family group with a reference mass within the next two higher equivalent inertia classes or any lower equivalent inertia.
3. Test Procedure

The vehicle may be equipped with a switch capable of preventing or permitting the regeneration process provided that this operation has no effect on original engine calibration. This switch shall be permitted only for the purpose of preventing regeneration during loading of the regeneration system and during the pre-conditioning cycles. However, it shall not be used during the measurement of emissions during the regeneration phase; rather the emission test shall be carried out with the unchanged Original Equipment Manufacturer's (OEM) control unit.

- 3.1. Exhaust emission measurement between two cycles where regenerative phases occur
- 3.1.1. Average emissions between regeneration phases and during loading of the regenerative device shall be determined from the arithmetic mean of several approximately equidistant (if more than 2) Type I operating cycles or equivalent engine test bench cycles. As an alternative, the manufacturer may provide data to show that the emissions remain constant (± 15 per cent) between regeneration phases. In this case, the emissions measured during the regular Type I test may be used. In any other case emissions measurement for at least two Type I operating cycles or equivalent engine test bench cycles must be completed: one immediately after regeneration (before new loading) and one as close as possible prior to a regeneration phase. All emissions measurements and calculations shall be carried out according to paragraphs 6.4. to 6.6. of Annex 4a to this Regulation. Determination of average emissions for a single regenerative system shall be calculated according to paragraph 3.3. of this annex and for multiple regeneration systems according to paragraph 3.4. of this annex.
- 3.1.2. The loading process and K_i determination shall be made during the Type I operating cycle, on a chassis dynamometer or on an engine test bench using an equivalent test cycle. These cycles may be run continuously (i.e. without the need to switch the engine off between cycles). After any number of completed cycles, the vehicle may be removed from the chassis dynamometer, and the test continued at a later time.
- 3.1.3. The number of cycles (D) between two cycles where regeneration phases occur, the number of cycles over which emissions measurements are made (n), and each emissions measurement (M'_{sij}) shall be reported in items 3.2.12.2.1.11.1. to 3.2.12.2.1.11.4. or items 3.2.12.2.6.4.1. to 3.2.12.2.6.4.4. of Annex 1 to this Regulation as applicable.
- 3.2. Measurement of emissions during regeneration
- 3.2.1. Preparation of the vehicle, if required, for the emissions test during a regeneration phase, may be completed using the preparation cycles in paragraph 6.3. of Annex 4a to this Regulation or equivalent engine test bench cycles, depending on the loading procedure chosen in paragraph 3.1.2. of this annex.
- 3.2.2. The test and vehicle conditions for the Type I test described in Annex 4a to this Regulation apply before the first valid emission test is carried out.
- 3.2.3. Regeneration must not occur during the preparation of the vehicle. This may be ensured by one of the following methods:
 - 3.2.3.1. A "dummy" regenerating system or partial system may be fitted for the pre-conditioning cycles.
 - 3.2.3.2. Any other method agreed between the manufacturer and the Type Approval Authority.
- 3.2.4. A cold-start exhaust emission test including a regeneration process shall be performed according to the Type I operating cycle, or equivalent engine test bench cycle. If the emissions tests between two cycles where regeneration phases occur are carried out on an engine test bench, the emissions test including a regeneration phase shall also be carried out on an engine test bench.
- 3.2.5. If the regeneration process requires more than one operating cycle, subsequent test cycle(s) shall be driven immediately, without switching the

engine off, until complete regeneration has been achieved (each cycle shall be completed). The time necessary to set up a new test should be as short as possible (e.g. particular matter filter change). The engine must be switched off during this period.

3.2.6. The emission values during regeneration (M_{ri}) shall be calculated according to paragraph 6.6. of Annex 4a to this Regulation. The number of operating cycles (d) measured for complete regeneration shall be recorded.

3.3. Calculation of the combined exhaust emissions of a single regenerative system

$$(1) \quad M_{si} = \frac{\sum_{j=1}^n M'_{sij}}{n} \quad n \geq 2$$

$$(2) \quad M_{ri} = \frac{\sum_{j=1}^d M'_{rij}}{d}$$

$$(3) \quad M_{pi} = \left\{ \frac{M_{si} * D + M_{ri} * d}{D + d} \right\}$$

Where for each pollutant (i) considered:

M'_{sij} = mass emissions of pollutant (i) in g/km over one Type I operating cycle (or equivalent engine test bench cycle) without regeneration,

M'_{rij} = mass emissions of pollutant (i) in g/km over one Type I operating cycle (or equivalent engine test bench cycle) during regeneration (if $d > 1$, the first Type I test is run cold, and subsequent cycles are hot),

M_{si} = mass emissions of pollutant (i) in g/km without regeneration,

M_{ri} = mass emissions of pollutant (i) in g/km during regeneration,

M_{pi} = mass emissions of pollutant (i) in g/km,

n = number of test points at which emissions measurements (Type I operating cycles or equivalent engine test bench cycles) are made between two cycles where regenerative phases occur, ≥ 2 ,

d = number of operating cycles required for regeneration,

D = number of operating cycles between two cycles where regenerative phases occur.

For exemplary illustration of measurement parameters see Figure A13/1.

Figure A13/1

Parameters measured during emissions test during and between cycles where regeneration occurs (schematic example, the emissions during "D" may increase or decrease)

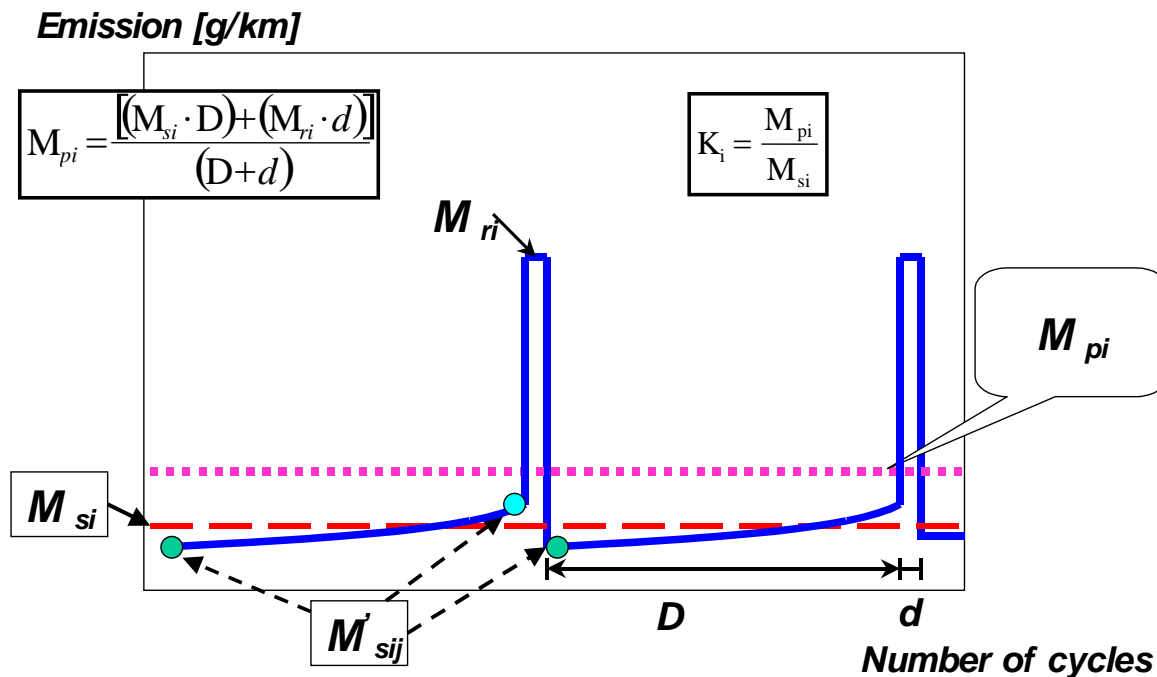

3.3.1. Calculation of the regeneration factor K for each pollutant (i) considered

$$K_i = M_{pi} / M_{si}$$

M_{si} , M_{pi} and K_i results shall be recorded in the test report delivered by the Technical Service.

K_i may be determined following the completion of a single sequence.

3.4. Calculation of combined exhaust emissions of multiple periodic regenerating systems

$$(1) \quad M_{sik} = \frac{\sum_{j=1}^{n_k} M'_{sik,j}}{n_k} \quad n_k \geq 2$$

$$(2) \quad M_{rik} = \frac{\sum_{j=1}^{d_k} M'_{rik,j}}{d_j}$$

$$(3) \quad M_{si} = \frac{\sum_{k=1}^x M_{sik} \cdot D_k}{\sum_{k=1}^x D_k}$$

$$(4) \quad M_{ri} = \frac{\sum_{k=1}^x M_{rik} \cdot d_k}{\sum_{k=1}^x d_k}$$

$$(5) \quad M_{pi} = \frac{M_{si} \cdot \sum_{k=1}^x D_k + M_{ri} \cdot \sum_{k=1}^x d_k}{\sum_{k=1}^x (D_k + d_k)}$$

$$(6) \quad M_{pi} = \frac{\sum_{k=1}^x (M_{sik} \cdot D_k + M_{rik} \cdot d_k)}{\sum_{k=1}^x (D_k + d_k)}$$

$$(7) \quad K_i = \frac{M_{pi}}{M_{si}}$$

Where:

- M_{si} = mean mass emission of all events k of pollutant (i) in g/km without regeneration,
- M_{ri} = mean mass emission of all events k of pollutant (i) in g/km during regeneration,
- M_{pi} = mean mass emission of all events k of pollutant (i) in g/km,
- M_{sik} = mean mass emission of event k of pollutant (i) in g/km without regeneration,
- M_{rik} = mean mass emission of event k of pollutant (i) in g/km during regeneration,
- $M'_{sik,j}$ = mass emissions of event k of pollutant (i) in g/km over one Type I operating cycle (or equivalent engine test bench cycle) without regeneration measured at point j; $1 \leq j \leq n_k$,
- $M'_{rik,j}$ = mass emissions of event k of pollutant (i) in g/km over one Type I operating cycle (or equivalent engine test bench cycle) during regeneration (when $j > 1$, the first Type I test is run cold, and subsequent cycles are hot) measured at operating cycle j; $1 \leq j \leq n_k$,
- n_k = number of test points of event k at which emissions measurements (Type I operating cycles or equivalent engine test bench cycles) are made between two cycles where regenerative phases occur, ≥ 2 ,
- d_k = number of operating cycles of event k required for regeneration,
- D_k = number of operating cycles of event k between two cycles where regenerative phases occur.

For an illustration of measurement parameters see Figure A13/2

Figure A13/2

Parameters measured during emissions test during and between cycles where regeneration occurs (schematic example)

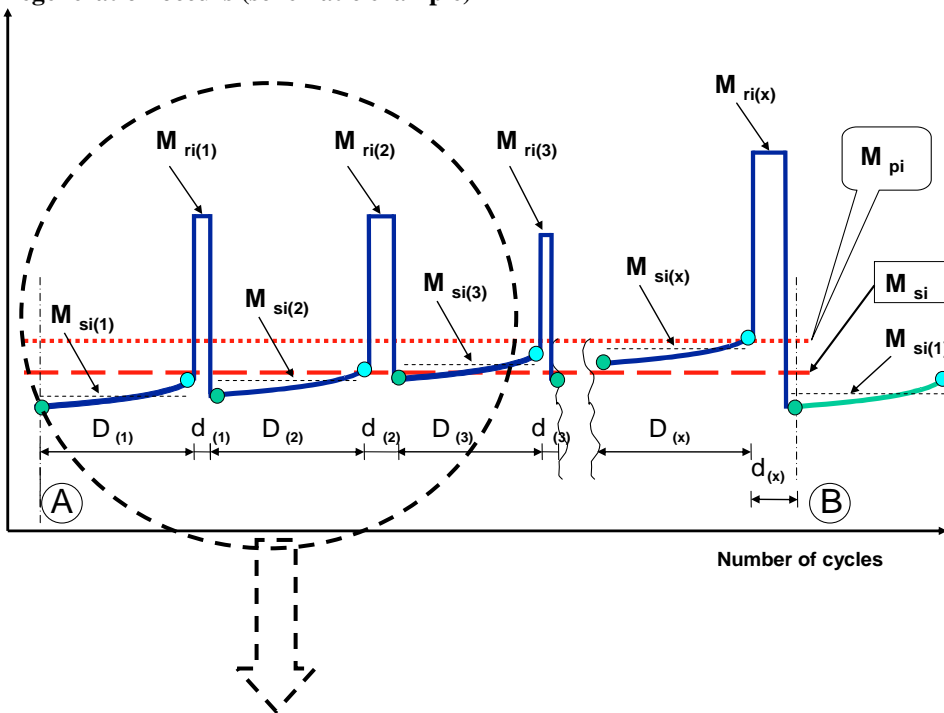

For more details of the schematic process see Figure A13/3

Figure A13/3

Parameters measured during emissions test during and between cycles where regeneration occurs (schematic example)

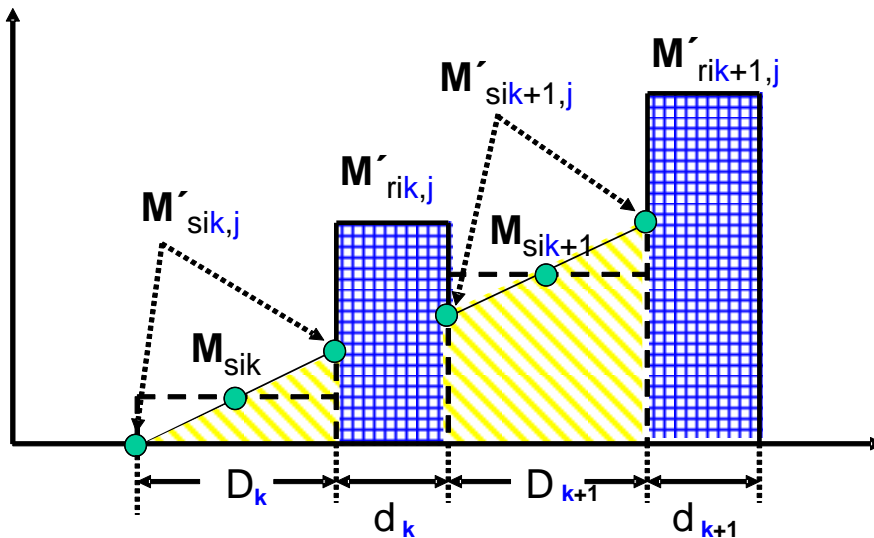

For application of a simple and realistic case, the following description gives a detailed explanation of the schematic example shown in Figure A13/3 above:

1. "DPF": regenerative, equidistant events, similar emissions (± 15 per cent) from event to event

$$D_k = D_{k+1} = D_1$$

$$d_k = d_{k+1} = d_1$$

$$M_{rik} - M_{sik} = M_{rik+1} - M_{sik+1}$$

$$n_k = n$$

2. "DeNO_x": the desulphurisation (SO₂ removal) event is initiated before an influence of sulphur on emissions is detectable (± 15 per cent of measured emissions) and in this example for exothermic reason together with the last DPF regeneration event performed.

$$M'_{sik,j=1} = \text{constant} \rightarrow M_{sik} = M_{sik+1} = M_{si2}$$

$$M_{rik} = M_{rik+1} = M_{ri2}$$

For SO₂ removal event: $M_{ri2}, M_{si2}, d_2, D_2, n_2 = 1$

3. Complete system (DPF + DeNO_x):

$$M_{si} = \frac{n \cdot M_{sil} \cdot D_1 + M_{si2} \cdot D_2}{n \cdot (D_1 + d_1) + D_2 + d_2}$$

$$M_{ri} = \frac{n \cdot M_{ri1} \cdot d_1 + M_{ri2} \cdot d_2}{n \cdot (D_1 + d_1) + D_2 + d_2}$$

$$M_{pi} = \frac{M_{si} + M_{ri}}{n \cdot (D_1 + d_1) + D_2 + d_2} = \frac{n \cdot (M_{sil} \cdot D_1 + M_{ri1} \cdot d_1) + M_{si2} \cdot D_2 + M_{ri2} \cdot d_2}{n \cdot (D_1 + d_1) + D_2 + d_2}$$

The calculation of the factor (K_i) for multiple periodic regenerating systems is only possible after a certain number of regeneration phases for each system. After performing the complete procedure (A to B, see Figure A13/2), the original starting conditions A should be reached again.

- 3.4.1. Extension of approval for a multiple periodic regeneration system
- 3.4.1.1. If the technical parameter(s) and or the regeneration strategy of a multiple regeneration system for all events within this combined system are changed, the complete procedure including all regenerative devices should be performed by measurements to update the multiple k_i - factor.
- 3.4.1.2. If a single device of the multiple regeneration system changed only in strategy parameters (i.e. such as "D" and/or "d" for DPF) and the manufacturer could present technical feasible data and information to the Technical Service that:

- (a) There is no detectable interaction to the other device(s) of the system; and
- (b) The important parameters (i.e. construction, working principle, volume, location etc.) are identical;

The necessary update procedure for k_i could be simplified.

As agreed between the manufacturer and the Technical Service in such a case only a single event of sampling/storage and regeneration should be performed and the test results (" M_{si} ", " M_{ri} ") in combination with the changed parameters ("D" and/or "d") could be introduced in the relevant formula(s) to update the multiple k_i - factor in a mathematical way under substitution of the existing basis k_i - factor formula(s)."

Annex 14

Emissions test procedure for hybrid electric vehicles (HEV)

1. Introduction
 - 1.1. This annex defines the specific provisions regarding type-approval of a hybrid electric vehicle (HEV) as defined in paragraph 2.21.2. of this Regulation.
 - 1.2. As a general principle, for the tests of Type I, II, III, IV, V, VI and OBD, hybrid electric vehicles shall be tested according to Annex 4a, 5, 6, 7, 9, 8 and 11 to this Regulation respectively, unless modified by this annex.
 - 1.3. For the Type I test only, OVC vehicles (as categorized in paragraph 2. of this annex) shall be tested according to condition A and to condition B. The test results under both conditions A and B and the weighted values shall be reported in the communication form.
 - 1.4. The emissions test results shall comply with the limits under all specified test conditions of this Regulation.

2. Categories of hybrid electric vehicles

<i>Vehicle charging</i>	<i>Off-Vehicle Charging¹ (OVC)</i>		<i>Not Off-Vehicle Charging² (NOVC)</i>	
Operating mode switch	Without	With	Without	With

¹ Also known as "externally chargeable"

² Also known as "not externally chargeable"

3. Type I test methods
 - 3.1. Externally chargeable (OVC HEV) without an operating mode switch
 - 3.1.1. Two tests shall be performed under the following conditions:

Condition A: Test shall be carried out with a fully charged electrical energy/power storage device.

Condition B: Test shall be carried out with an electrical energy/power storage device in minimum state of charge (maximum discharge of capacity).

The profile of the state of charge (SOC) of the electrical energy/power storage device during different stages of the Type I test is given in Appendix 1 to this annex.
 - 3.1.2. Condition A
 - 3.1.2.1. The procedure shall start with the discharge of the electrical energy/power storage device of the vehicle while driving (on the test track, on a chassis dynamometer, etc.):
 - (a) At a steady speed of 50 km/h until the fuel consuming engine of the HEV starts up;
 - (b) Or, if a vehicle cannot reach a steady speed of 50 km/h without starting up the fuel consuming engine, the speed shall be reduced until the vehicle can run a lower steady speed where the fuel consuming

engine does not start up for a defined time/distance (to be specified between technical service and manufacturer);

(c) Or with manufacturer's recommendation.

The fuel consuming engine shall be stopped within 10 seconds of it being automatically started.

3.1.2.2. Conditioning of vehicle

3.1.2.2.1. For compression-ignition engines the Part Two cycle described in Table A4a/2 (and Figure A4a/3) of Annex 4a to this Regulation shall be used. Three consecutive cycles shall be driven according to paragraph 3.1.2.5.3. of this annex.

3.1.2.2.2. Vehicles fitted with positive-ignition engines shall be preconditioned with one Part One and two Part Two driving cycles according to paragraph 3.1.2.5.3. of this annex.

3.1.2.3. After this preconditioning, and before testing, the vehicle shall be kept in a room in which the temperature remains relatively constant between 293 and 303 K (20 °C and 30 °C). This conditioning shall be carried out for at least six hours and continue until the engine oil temperature and coolant, if any, are within ± 2 K of the temperature of the room, and the electrical energy/power storage device is fully charged as a result of the charging prescribed in paragraph 3.1.2.4. of this annex.

3.1.2.4. During soak, the electrical energy/power storage device shall be charged:

(a) With the on board charger if fitted; or

(b) With an external charger recommended by the manufacturer, using the normal overnight charging procedure.

This procedure excludes all types of special charges that could be automatically or manually initiated like, for instance, the equalization charges or the servicing charges.

The manufacturer shall declare that during the test, a special charge procedure has not occurred.

3.1.2.5. Test procedure

3.1.2.5.1. The vehicle shall be started up by the means provided for normal use to the driver. The first cycle starts on the initiation of the vehicle start-up procedure.

3.1.2.5.2. The test procedures defined in either paragraph 3.1.2.5.2.1. or 3.1.2.5.2.2. of this annex may be used in line with the procedure chosen in paragraph 3.2.3.2. of Annex 8 to Regulation No. 101.

3.1.2.5.2.1. Sampling shall begin (BS) before or at the initiation of the vehicle start up procedure and end on conclusion of the final idling period in the extra-urban cycle (Part Two, end of sampling (ES)).

3.1.2.5.2.2. Sampling shall begin (BS) before or at the initiation of the vehicle start up procedure and continue over a number of repeat test cycles. It shall end on conclusion of the final idling period in the first extra-urban (Part Two) cycle during which the battery reached the minimum state of charge according to the criterion defined below (end of sampling (ES)).

The electricity balance Q [Ah] is measured over each combined cycle, using the procedure specified in Appendix 2 of Annex 8 to Regulation No. 101, and used to determine when the battery minimum state of charge has been reached.

The battery minimum state of charge is considered to have been reached in combined cycle N if the electricity balance measured during combined cycle N+1 is not more than a 3 per cent discharge, expressed as a percentage of the nominal capacity of the battery (in Ah) in its maximum state of charge, as declared by the manufacturer. At the manufacturer's request additional test cycles may be run and their results included in the calculations in paragraphs 3.1.2.5.5. and 3.1.4.2. of this annex provided that the electricity balance for each additional test cycle shows less discharge of the battery than over the previous cycle.

In between each of the cycles a hot soak period of up to 10 minutes is allowed. The power train shall be switched off during this period.

- 3.1.2.5.3. The vehicle shall be driven according to provisions in Annex 4a to this Regulation, or in case of special gear shifting strategy, according to the manufacturer's instructions, as incorporated in the drivers' handbook of production vehicles and indicated by a technical gear shift instrument (for drivers' information). For these vehicles the gear shifting points prescribed in Annex 4a to this Regulation are not applied. For the pattern of the operating curve the description according to paragraph 6.1.3. of Annex 4a to this Regulation shall apply.
- 3.1.2.5.4. The exhaust gases shall be analyzed according to provisions in Annex 4a to this Regulation.
- 3.1.2.5.5. The test results shall be compared to the limits prescribed in paragraph 5.3.1.4. of this Regulation and the average emission of each pollutant in grams per kilometre for Condition A shall be calculated (M_{1i}).

In the case of testing according to paragraph 3.1.2.5.2.1. of this annex, (M_{1i}) is simply the result of the single combined cycle run.

In the case of testing according to paragraph 3.1.2.5.2.2. of this annex, the test result of each combined cycle run (M_{1ia}), multiplied by the appropriate deterioration and K_i factors, shall be less than the limits prescribed in paragraph 5.3.1.4. of this Regulation. For the purposes of the calculation in paragraph 3.1.4. of this annex, M_{1i} shall be defined as:

$$M_{1i} = \frac{1}{N} \sum_{a=1}^N M_{1ia}$$

Where:

i: pollutant
a: cycle

- 3.1.3. Condition B
- 3.1.3.1. Conditioning of vehicle
 - 3.1.3.1.1. For compression-ignition engines the Part Two cycle described in Table A4a/2 (and Figure A4a/3) of Annex 4a to this Regulation shall be used. Three consecutive cycles shall be driven according to paragraph 3.1.3.4.3. of this annex.
 - 3.1.3.1.2. Vehicles fitted with positive-ignition engines shall be preconditioned with one Part One and two Part Two driving cycles according to paragraph 3.1.3.4.3. of this annex.
- 3.1.3.2. The electrical energy/power storage device of the vehicle shall be discharged while driving (on the test track, on a chassis dynamometer, etc.):

- (a) At a steady speed of 50 km/h until the fuel consuming engine of the HEV starts up;
- (b) Or if a vehicle cannot reach a steady speed of 50 km/h without starting up the fuel consuming engine, the speed shall be reduced until the vehicle can run a lower steady speed where the fuel consuming engine just does not start up for a defined time/distance (to be specified between technical service and manufacturer);
- (c) Or with manufacturer's recommendation.

The fuel consuming engine shall be stopped within 10 seconds of it being automatically started.

3.1.3.3. After this preconditioning, and before testing, the vehicle shall be kept in a room in which the temperature remains relatively constant between 293 and 303 K (20 °C and 30 °C). This conditioning shall be carried out for at least six hours and continue until the engine oil temperature and coolant, if any, are within ± 2 K of the temperature of the room.

3.1.3.4. Test procedure

3.1.3.4.1. The vehicle shall be started up by the means provided for normal use to the driver. The first cycle starts on the initiation of the vehicle start-up procedure.

3.1.3.4.2. Sampling shall begin (BS) before or at the initiation of the vehicle start up procedure and end on conclusion of the final idling period in the extra-urban cycle (Part Two, end of sampling (ES)).

3.1.3.4.3. The vehicle shall be driven according to Annex 4a to this Regulation, or in case of special gear shifting strategy according to the manufacturer's instructions, as incorporated in the drivers' handbook of production vehicles and indicated by a technical gear shift instrument (for drivers information). For these vehicles the gear shifting points prescribed in Annex 4a to this Regulation are not applied. For the pattern of the operating curve the description according to paragraph 6.1.3. of Annex 4a to this Regulation shall apply.

3.1.3.4.4. The exhaust gases shall be analyzed according to Annex 4a to this Regulation.

3.1.3.5. The test results shall be compared to the limits prescribed in paragraph 5.3.1.4. of this Regulation and the average emission of each pollutant for Condition B shall be calculated (M_{2i}). The test results M_{2i} , multiplied by the appropriate deterioration and K_i factors, shall be less than the limits prescribed in paragraph 5.3.1.4. of this Regulation.

3.1.4. Test results

3.1.4.1. In the case of testing according to paragraph 3.1.2.5.2.1. of this annex

For communication, the weighted values shall be calculated as below:

$$M_i = (De \cdot M_{1i} + Dav \cdot M_{2i}) / (De + Dav)$$

Where:

M_i = mass emission of the pollutant i in grams per kilometre,

M_{1i} = average mass emission of the pollutant i in grams per kilometre with a fully charged electrical energy/power storage device calculated in paragraph 3.1.2.5.5. of this annex

- M_{2i} = average mass emission of the pollutant i in grams per kilometre with an electrical energy/power storage device in minimum state of charge (maximum discharge of capacity) calculated in paragraph 3.1.3.5. of this annex
- D_e = vehicle electric range, according to the procedure described in Regulation No. 101, Annex 9, where the manufacturer must provide the means for performing the measurement with the vehicle running in pure electric mode,
- D_{av} = 25 km (average distance between two battery recharges).

3.1.4.2. In the case of testing according to paragraph 3.1.2.5.2.2. of this annex
For communication, the weighted values shall be calculated as below:

$$M_i = (D_{ovc} \cdot M_{1i} + D_{av} \cdot M_{2i}) / (D_{ovc} + D_{av})$$

Where:

- M_i = mass emission of the pollutant i in grams per kilometre,
- M_{1i} = average mass emission of the pollutant i in grams per kilometre with a fully charged electrical energy/power storage device calculated in paragraph 3.1.2.5.5. of this annex
- M_{2i} = average mass emission of the pollutant i in grams per kilometre with an electrical energy/power storage device in minimum state of charge (maximum discharge of capacity) calculated in paragraph 3.1.3.5. of this annex
- D_{ovc} = OVC range according to the procedure described in Regulation No. 101, Annex 9.
- D_{av} = 25 km (average distance between two battery recharges).

3.2. Externally chargeable (OVC HEV) with an operating mode switch

3.2.1. Two tests shall be performed under the following conditions:

- 3.2.1.1. Condition A: Test shall be carried out with a fully charged electrical energy/power storage device.
- 3.2.1.2. Condition B: Test shall be carried out with an electrical energy/power storage device in minimum state of charge (maximum discharge of capacity).

3.2.1.3. The operating mode switch shall be positioned according to Table A14/1.

Table A14/1

Hybrid-modes Battery state of charge	- Pure electric - Hybrid Switch in position	- Pure fuel consuming - Hybrid Switch in position	- Pure electric - Pure fuel consuming - Hybrid Switch in position	- Hybrid mode n ¹ ... - Hybrid mode m ¹ Switch in position
Condition A Fully charged	Hybrid	Hybrid	Hybrid	Most electric hybrid mode ²
Condition B Min. state of charge	Hybrid	Fuel consuming	Fuel consuming	Most fuel consuming mode ³

Notes:

¹ For instance: sport, economic, urban, extra-urban position ...

² *Most electric hybrid mode:*

The hybrid mode which can be proven to have the highest electricity consumption of all selectable hybrid modes when tested in accordance with condition A of paragraph 4. of Annex 8 to Regulation No. 101, to be established based on information provided by the manufacturer and in agreement with the technical service.

³ *Most fuel consuming mode:*

The hybrid mode which can be proven to have the highest fuel consumption of all selectable hybrid modes when tested in accordance with condition B of paragraph 4. of Annex 8 to Regulation No. 101, to be established based on information provided by the manufacturer and in agreement with the technical service.

3.2.2. Condition A

3.2.2.1. If the pure electric range of the vehicle is higher than one complete cycle, on the request of the manufacturer, the Type I test may be carried out in pure electric mode. In this case, engine preconditioning prescribed in paragraph 3.2.2.3.1. or 3.2.2.3.2. of this annex can be omitted.

3.2.2.2. The procedure shall start with the discharge of the electrical energy/power storage device of the vehicle while driving with the switch in pure electric position (on the test track, on a chassis dynamometer, etc.) at a steady speed of 70 per cent \pm 5 per cent of the maximum thirty minutes speed of the vehicle (determined according to Regulation No. 101).

Stopping the discharge occurs:

- (a) When the vehicle is not able to run at 65 per cent of the maximum thirty minutes speed; or
- (b) When an indication to stop the vehicle is given to the driver by the standard on-board instrumentation; or
- (c) After covering the distance of 100 km.

If the vehicle is not equipped with a pure electric mode, the electrical energy/power storage device discharge shall be achieved by driving the vehicle (on the test track, on a chassis dynamometer, etc.):

- (a) At a steady speed of 50 km/h until the fuel consuming engine of the HEV starts up; or
- (b) If a vehicle cannot reach a steady speed of 50 km/h without starting up the fuel consuming engine, the speed shall be reduced until the vehicle can run a lower steady speed where the fuel consuming engine does

not start up for a defined time/distance (to be specified between technical service and manufacturer); or

(c) With manufacturers' recommendation.

The fuel consuming engine shall be stopped within 10 seconds of it being automatically started.

3.2.2.3. Conditioning of vehicle

3.2.2.3.1. For compression-ignition engines the Part Two cycle described in Table A4a/2 (and Figure A4a/3) of Annex 4a to this Regulation shall be used. Three consecutive cycles shall be driven according to paragraph 3.2.2.6.3. of this annex.

3.2.2.3.2. Vehicles fitted with positive-ignition engines shall be preconditioned with one Part One and two Part Two driving cycles according to paragraph 3.2.2.6.3. of this annex.

3.2.2.4. After this preconditioning, and before testing, the vehicle shall be kept in a room in which the temperature remains relatively constant between 293 and 303 K (20 °C and 30 °C). This conditioning shall be carried out for at least six hours and continue until the engine oil temperature and coolant, if any, are within ± 2 K of the temperature of the room, and the electrical energy/power storage device is fully charged as a result of the charging prescribed in paragraph 3.2.2.5. of this annex.

3.2.2.5. During soak, the electrical energy/power storage device shall be charged:

(a) With the on board charger if fitted; or

(b) With an external charger recommended by the manufacturer, using the normal overnight charging procedure.

This procedure excludes all types of special charges that could be automatically or manually initiated like, for instance, the equalisation charges or the servicing charges.

The manufacturer shall declare that during the test, a special charge procedure has not occurred.

3.2.2.6. Test procedure

3.2.2.6.1. The vehicle shall be started up by the means provided for normal use to the driver. The first cycle starts on the initiation of the vehicle start-up procedure.

3.2.2.6.2. The test procedures defined in either paragraph 3.2.2.6.2.1. or 3.2.2.6.2.2. of this annex may be used in line with the procedure chosen in paragraph 4.2.4.2. of Annex 8 to Regulation No. 101,

3.2.2.6.2.1. Sampling shall begin (BS) before or at the initiation of the vehicle start up procedure and end on conclusion of the final idling period in the extra-urban cycle (Part Two, end of sampling (ES)).

3.2.2.6.2.2. Sampling shall begin (BS) before or at the initiation of the vehicle start up procedure and continue over a number of repeat test cycles. It shall end on conclusion of the final idling period in the first extra-urban (Part Two) cycle during which the battery has reached the minimum state of charge according to the criterion defined below (end of sampling (ES)).

The electricity balance Q [Ah] is measured over each combined cycle, using the procedure specified in Appendix 2 to Annex 8 to Regulation No. 101, and used to determine when the battery minimum state of charge has been reached.

The battery minimum state of charge is considered to have been reached in combined cycle N if the electricity balance measured during combined cycle N+1 is not more than a 3 per cent discharge, expressed as a percentage of the nominal capacity of the battery (in Ah) in its maximum state of charge, as declared by the manufacturer. At the manufacturer's request additional test cycles may be run and their results included in the calculations in paragraphs 3.2.2.7. and 3.2.4. of this annex provided that the electricity balance for each additional test cycle shows less discharge of the battery than over the previous cycle.

In between each of the cycles a hot soak period of up to 10 minutes is allowed. The power train shall be switched off during this period.

- 3.2.2.6.3. The vehicle shall be driven according to Annex 4a to this Regulation, or in case of special gear shifting strategy, according to the manufacturer's instructions, as incorporated in the drivers' handbook of production vehicles and indicated by a technical gear shift instrument (for drivers' information). For these vehicles the gear shifting points prescribed in Annex 4a to this Regulation are not applied. For the pattern of the operating curve the description according to paragraph 6.1.3. of Annex 4a to this Regulation shall apply.
- 3.2.2.6.4. The exhaust gases shall be analysed according to Annex 4a to this Regulation.
- 3.2.2.7. The test results shall be compared to the limits prescribed in paragraph 5.3.1.4. of this Regulation and the average emission of each pollutant in grams per kilometre for Condition A shall be calculated (M_{ii}).

In the case of testing according to paragraph 3.2.2.6.2.1. of this annex, (M_{ii}) is simply the result of the single combined cycle run.

In the case of testing according to paragraph 3.2.2.6.2.2. of this annex, the test result of each combined cycle run M_{ia} , multiplied by the appropriate deterioration and K_i factors, shall be less than the limits prescribed in paragraph 5.3.1.4. of this Regulation. For the purposes of the calculation in paragraph 3.2.4. of this annex, M_{ii} shall be defined as:

$$M_{ii} = \frac{1}{N} \sum_{a=1}^N M_{ia}$$

Where:

i: pollutant
a: cycle

- 3.2.3. Condition B
- 3.2.3.1. Conditioning of vehicle
- 3.2.3.1.1. For compression-ignition engines the Part Two cycle described in Table A4a/2 and Figure A4a/2 of Annex 4a to this Regulation shall be used. Three consecutive cycles shall be driven according to paragraph 3.2.3.4.3. of this annex.
- 3.2.3.1.2. Vehicles fitted with positive-ignition engines shall be preconditioned with one Part One and two Part Two driving cycles according to paragraph 3.2.3.4.3. of this annex.
- 3.2.3.2. The electrical energy/power storage device of the vehicle shall be discharged according to paragraph 3.2.2.2. of this annex.

- 3.2.3.3. After this preconditioning, and before testing, the vehicle shall be kept in a room in which the temperature remains relatively constant between 293 and 303 K (20 °C and 30 °C). This conditioning shall be carried out for at least six hours and continue until the engine oil temperature and coolant, if any, are within ± 2 K of the temperature of the room.
- 3.2.3.4. Test procedure
- 3.2.3.4.1. The vehicle shall be started up by the means provided for normal use to the driver. The first cycle starts on the initiation of the vehicle start-up procedure.
- 3.2.3.4.2. Sampling shall begin (BS) before or at the initiation of the vehicle start up procedure and end on conclusion of the final idling period in the extra-urban cycle (Part Two, end of sampling (ES)).
- 3.2.3.4.3. The vehicle shall be driven according to Annex 4a to this Regulation, or in case of special gear shifting strategy, according to the manufacturer's instructions, as incorporated in the drivers' handbook of production vehicles and indicated by a technical gear shift instrument (for drivers' information). For these vehicles the gear shifting points prescribed in Annex 4a to this Regulation are not applied. For the pattern of the operating curve the description according to paragraph 6.1.3. of Annex 4a to this Regulation shall apply.
- 3.2.3.4.4. The exhaust gases shall be analysed according to provisions in Annex 4a to this Regulation.
- 3.2.3.5. The test results shall be compared to the limits prescribed in paragraph 5.3.1.4. of this Regulation and the average emission of each pollutant for Condition B shall be calculated (M_{2i}). The test results M_{2i} , multiplied by the appropriate deterioration and K_i factors, shall be less than the limits prescribed in paragraph 5.3.1.4. of this Regulation.
- 3.2.4. Test results
- 3.2.4.1. In the case of testing according to paragraph 3.2.2.6.2.1. of this annex.
For communication, the weighted values shall be calculated as below:
- $$M_i = (De \cdot M_{1i} + Dav \cdot M_{2i}) / (De + Dav)$$
- Where:
- M_i = mass emission of the pollutant i in grams per kilometre,
- M_{1i} = average mass emission of the pollutant i in grams per kilometre with a fully charged electrical energy/power storage device calculated in paragraph 3.2.2.7. of this annex.
- M_{2i} = average mass emission of the pollutant i in grams per kilometre with an electrical energy/power storage device in minimum state of charge (maximum discharge of capacity) calculated in paragraph 3.2.3.5. of this annex.
- De = vehicle electric range with the switch in pure electric position, according to the procedure described in Regulation No. 101, Annex 9. If there is not a pure electric position, the manufacturer must provide the means for performing the measurement with the vehicle running in pure electric mode.
- Dav = 25 km (average distance between two battery recharge).

- 3.2.4.2. In the case of testing according to paragraph 3.2.2.6.2.2. of this annex.
For communication, the weighted values shall be calculated as below
- $$M_i = (D_{ovc} \cdot M_{1i} + D_{av} \cdot M_{2i}) / (D_{ovc} + D_{av})$$
- Where:
- M_i = mass emission of the pollutant i in grams per kilometre,
 M_{1i} = average mass emission of the pollutant i in grams per kilometre with a fully charged electrical energy/power storage device calculated in paragraph 3.2.2.7. of this annex
 M_{2i} = average mass emission of the pollutant i in grams per kilometre with an electrical energy/power storage device in minimum state of charge (maximum discharge of capacity) calculated in paragraph 3.2.3.5. of this annex
 D_{ovc} = OVC range according to the procedure described in Regulation No. 101, Annex 9.
 D_{av} = 25 km (average distance between two battery recharges).
- 3.3. Not externally chargeable (not-OVC HEV) without an operating mode switch
- 3.3.1. These vehicles shall be tested according to Annex 4a.
- 3.3.2. For preconditioning, at least two consecutive complete driving cycles (one Part One and one Part Two) are carried out without soak.
- 3.3.3. The vehicle shall be driven according to Annex 4a, or in case of special gear shifting strategy according to the manufacturer's instructions, as incorporated in the drivers' handbook of production vehicles and indicated by a technical gear shift instrument (for drivers information). For these vehicles the gear shifting points prescribed in Annex 4a are not applied. For the pattern of the operating curve the description according to paragraph 6.1.3. of Annex 4a shall apply.
- 3.4. Not externally chargeable (not-OVC HEV) with an operating mode switch
- 3.4.1. These vehicles are preconditioned and tested in hybrid mode according to Annex 4a. If several hybrid modes are available, the test shall be carried out in the mode that is automatically set after turn on of the ignition key (normal mode). On the basis of information provided by the manufacturer, the Technical Service will make sure that the limit values are met in all hybrid modes.
- 3.4.2. For preconditioning, at least two consecutive complete driving cycles (one Part One and one Part Two) shall be carried out without soak.
- 3.4.3. The vehicle shall be driven according to Annex 4a to this Regulation, or in case of special gear shifting strategy according to the manufacturer's instructions, as incorporated in the drivers' handbook of production vehicles and indicated by a technical gear shift instrument (for drivers information). For these vehicles the gear shifting points prescribed in or Annex 4a to this Regulation are not applied. For the pattern of the operating curve the description according to paragraph 6.1.3. of Annex 4a to this Regulation shall apply.

4. Type II test methods
 - 4.1. The vehicles shall be tested according to Annex 5 with the fuel consuming engine running. The manufacturer shall provide a "service mode" that makes execution of this test possible.

If necessary, the special procedure provided for in paragraph 5.1.6. to this Regulation shall be used.
5. Type III Test methods
 - 5.1. The vehicles shall be tested according to Annex 6 with the fuel consuming engine running. The manufacturer shall provide a "service mode" that makes execution of this test possible.
 - 5.2. The tests shall be carried out only for conditions 1 and 2 of paragraph 3.2. of Annex 6. If for any reasons it is not possible to test on condition 2, alternatively another steady speed condition (with fuel consuming engine running under load) should be carried out.
6. Type IV Test methods
 - 6.1. The vehicles shall be tested according to Annex 7 to this Regulation.
 - 6.2. Before starting the test procedure (paragraph 5.1. of Annex 7 to this Regulation), the vehicles shall be preconditioned as follows:
 - 6.2.1. For OVC vehicles:
 - 6.2.1.1. OVC vehicles without an operating mode switch: the procedure shall start with the discharge of the electrical energy/power storage device of the vehicle while driving (on the test track, on a chassis dynamometer, etc.):
 - (a) At a steady speed of 50 km/h until the fuel consuming engine of the HEV starts up; or
 - (b) If a vehicle cannot reach a steady speed of 50 km/h without starting up the fuel consuming engine, the speed shall be reduced until the vehicle can run a lower steady speed where the fuel consuming engine just does not start up for a defined time/distance (to be specified between Technical Service and manufacturer); or
 - (c) With manufacturer's recommendation.

The fuel consuming engine shall be stopped within 10 seconds of it being automatically started.
 - 6.2.1.2. OVC vehicles with an operating mode switch: the procedure shall start with the discharge of the electrical energy/power storage device of the vehicle while driving with the switch in pure electric position (on the test track, on a chassis dynamometer, etc.) at a steady speed of 70 per cent \pm 5 per cent from the maximum thirty minutes speed of the vehicle.

Stopping the discharge occurs:

 - (a) When the vehicle is not able to run at 65 per cent of the maximum thirty minutes speed; or
 - (b) When an indication to stop the vehicle is given to the driver by the standard on-board instrumentation; or
 - (c) After covering the distance of 100 km.

If the vehicle is not equipped with a pure electric mode, the electrical energy/power storage device discharge shall be conducted with the vehicle driving (on the test track, on a chassis dynamometer, etc.):

- (a) At a steady speed of 50 km/h until the fuel consuming engine of the HEV starts up; or
- (b) If a vehicle cannot reach a steady speed of 50 km/h without starting up the fuel consuming engine, the speed shall be reduced until the vehicle can run a lower steady speed where the fuel consuming engine does not start up for a defined time/distance (to be specified between technical service and manufacturer); or
- (c) With manufacturer's recommendation.

The engine shall be stopped within 10 seconds of it being automatically started.

6.2.2. For NOVC vehicles:

6.2.2.1. NOVC vehicles without an operating mode switch: the procedure shall start with a preconditioning of at least two consecutive complete driving cycles (one Part One and one Part Two) without soak.

6.2.2.2. NOVC vehicles with an operating mode switch: the procedure shall start with a preconditioning of at least two consecutive complete driving cycles (one Part One and one Part Two) without soak, performed with the vehicle running in hybrid mode. If several hybrid modes are available, the test shall be carried out in the mode which is automatically set after turn on of the ignition key (normal mode).

6.3. The preconditioning drive and the dynamometer test shall be carried out according to paragraphs 5.2. and 5.4. of Annex 7 to this Regulation:

6.3.1. For OVC vehicles: under the same conditions as specified by condition B of the Type I test (paragraphs 3.1.3. and 3.2.3. of this annex).

6.3.2. For NOVC vehicles: under the same conditions as in the Type I test.

7. Type V Test methods

7.1. The vehicles shall be tested according to Annex 9 to this Regulation.

7.2. For OVC vehicles:

It is allowed to charge the electrical energy/power storage device twice a day during mileage accumulation.

For OVC vehicles with an operating mode switch, mileage accumulation should be driven in the mode which is automatically set after turn on of the ignition key (normal mode).

During the mileage accumulation a change into another hybrid mode is allowed if necessary in order to continue the mileage accumulation after agreement of the Technical Service.

The measurements of emissions of pollutants shall be carried out under the same conditions as specified by condition B of the Type I test (paragraphs 3.1.3. and 3.2.3. of this annex).

7.3. For NOVC vehicles:

For NOVC vehicles with an operating mode switch, mileage accumulation shall be driven in the mode which is automatically set after turn on of the ignition key (normal mode).

- The measurements of emissions of pollutants shall be carried out in the same conditions as in the Type I test.
8. Type VI test methods
 - 8.1. The vehicles shall be tested according to Annex 8 to this Regulation.
 - 8.2. For OVC vehicles, the measurements of emissions of pollutants shall be carried out under the same conditions as specified for condition B of the Type I test (paragraphs 3.1.3. and 3.2.3. of this annex).
 - 8.3. For NOVC vehicles, the measurements of emissions of pollutants shall be carried out under the same conditions as in the Type I test.
 9. On board diagnostics (OBD) Test methods
 - 9.1. The vehicles shall be tested according to Annex 11 to this Regulation.
 - 9.2. For OVC vehicles, the measurements of emissions of pollutants shall be carried out under the same conditions as specified for condition B of the Type I test (paragraphs 3.1.3. and 3.2.3. of this annex).
 - 9.3. For NOVC vehicles, the measurements of emissions of pollutants shall be carried out under the same conditions as in the Type I test.

Annex 14 - Appendix 1

Electrical energy/power storage device State Of Charge (SOC) profile for OVC HEV Type I test

Condition A of the Type I test

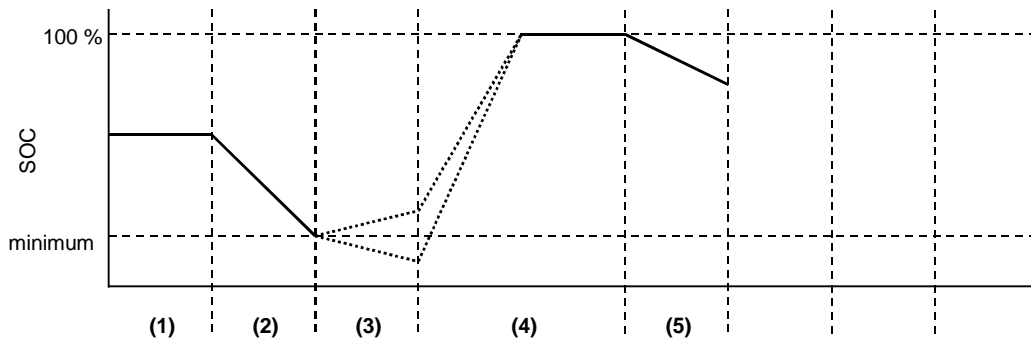

Condition A:

- (1) Initial electrical energy/power storage device state of charge
- (2) Discharge according to paragraph 3.1.2.1. or 3.2.2.2. of this annex
- (3) Vehicle conditioning according to paragraph 3.1.2.2. or 3.2.2.3. of this annex
- (4) Charge during soak according to paragraphs 3.1.2.3. and 3.1.2.4. of this annex, or paragraphs 3.2.2.4. and 3.2.2.5. of this annex
- (5) Test according to paragraph 3.1.2.5. or 3.2.2.6. of this annex

Condition B of the Type I test

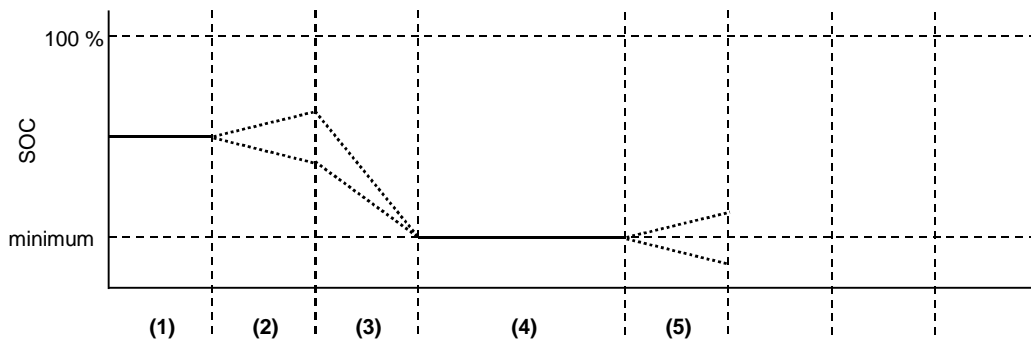

Condition B:

- (1) Initial state of charge
- (2) Vehicle conditioning according to paragraph 3.1.3.1. or 3.2.3.1. of this annex
- (3) Discharge according to paragraph 3.1.3.2. or 3.2.3.2. of this annex
- (4) Soak according to paragraph 3.1.3.3. or 3.2.3.3. of this annex
- (5) Test according to paragraph 3.1.3.4. or 3.2.3.4. of this annex