

Proposal for amendments to UN Regulation No. 107 (Buses and coaches).

The text reproduced below has been prepared by the expert of Germany to amend the Swedish Proposal ECE/TRANS/WP.29/GRSG/2014/6 to introduce fire suppression systems for buses and coaches upon detection of fire in the engine and/or heater compartment. The modifications to the current text of ECE/TRANS/WP.29/GRSG/2014/6 are marked in **bold** for new or strikethrough for deleted characters. In order to provide a possibility to distinguish the German changes, these are written in **Red**

I. Proposal

The list of Content, insert a new annex, to read:

"13 Requirements for type approval of fire suppression systems"

Insert a new paragraph 2.2.3., to read:

"2.2.3. "Fire suppression system type" for the purpose of Type-Approval as a component means a category of systems which does not essentially differ in the following aspects:

- (a) **fire suppression system manufacturer**
- (b) **extinguishing agent**
- (c) **nozzle type**
- (d) **type of propellant gas"**

Paragraph 2.3, amend to read:

"2.3. "Approval of a vehicle, ~~or~~ a separate technical unit **or a component** " means the approval of a vehicle type, ~~or~~ of a bodywork **or of a component** type as defined in paragraph 2.2. with regard to the constructional features specified in this Regulation; "

Paragraph 3.1., amend to read:

"3.1. The application for approval of:

- (a) A vehicle type or;
- (b) A separate technical unit type or;
- (c) A vehicle type fitted with bodywork type already approved as a separate technical unit **or**;
- (d) **A component type**

with regard to its constructional features shall be submitted by the responsible manufacturer or by his duly accredited representative. "

Insert a new paragraph 3.3.4., to read:

"3.3.4. Appendix 4: For a fire suppression system type."

Insert new paragraphs 3.4. to 3.4.2., to read:

"3.4. In case of application for approval of a type of vehicle, the manufacturer shall also provide the following documents:

3.4.1. A copy of the approval communication form (Annex 1, part 2, Appendix 4) for the fire suppression system, if applicable, as component which is installed according to paragraph 7.5.1.5 of Annex 3.

3.4.2. An analysis regarding the installation of the fire suppression system, (see Annex 3, item 7.5.1.5.4.2.)"

Paragraph 3.4. (former), renumber as paragraph 3.5. and amend to read:

"3.5. A vehicle(s), ~~or~~ a bodywork(s) **or a fire suppression system** representative of the type to be approved shall be submitted to the Technical Service responsible for conducting the Type Approval tests. "

Paragraphs 4.1. to 4.4., amend to read:

"4.1. If the vehicle, ~~or~~ bodywork **or fire suppression system** submitted for approval pursuant to this Regulation meets the requirements of paragraph 5., approval of that vehicle, ~~or~~ bodywork **or fire suppression system** type shall be granted.

4.2. An approval number shall be assigned to each ~~vehicle~~ type approved. Its first two digits (at present [06], corresponding to the [06] series of amendments) shall indicate the series of amendments incorporating the most recent major technical amendment made to the Regulation at the time of issue of the approval. The same Contracting Party shall not assign the same number to another vehicle, ~~or~~ bodywork **or fire suppression system** type within the meaning of paragraph 2.2.

4.3. Notice of approval or of extension of approval of a vehicle, ~~or~~ bodywork **or fire suppression system** type pursuant to this Regulation shall be communicated to the Contracting Parties to the Agreement applying this Regulation by means of a form conforming to the model in Annex 1 - **Part 2** to this Regulation.

4.4. There shall be affixed, conspicuously and in a readily accessible place specified on the approval form, to every vehicle, ~~or~~ bodywork **or fire suppression system** conforming to a vehicle, ~~or~~ bodywork **or fire suppression system** type approved under this Regulation, an international approval mark consisting of: "

Paragraph 4.7., amend to read:

"4.7. The approval mark shall be placed close to or on the vehicle or bodywork data plate affixed by the manufacturer.

Regarding fire suppression systems, the approval mark shall be affixed to the main part of the fire suppression system. The marking need not be visible when the system is installed in the vehicle. "

Paragraph 5.1., amend to read:

"5.1. All vehicles shall comply with the provisions set out in Annex 3 to this Regulation. Bodywork approved separately shall comply with Annex 10. The approval of a vehicle incorporating a bodywork approved in accordance with Annex 10 shall be completed in accordance with that annex. ~~Fire suppression systems shall comply with Annex 13.~~"

Paragraphs 6.1. to 6.1.1., amend to read:

"6.1. Every modification of the vehicle, ~~or~~ bodywork **or fire suppression system** type shall be notified to the Type Approval Authority which approved the ~~vehicle~~ type. That department may then either:

6.1.1. Consider that the modifications made are unlikely to have an appreciable adverse effect and that, in any case, the vehicle, ~~or~~ bodywork **or fire suppression system** still complies with the requirements; or"

Paragraph 6.3., amend to read:

"6.3. The Competent Authority issuing the extension of approval shall assign a series number for such an extension and inform thereof the other Contracting Parties to the 1958 Agreement applying this Regulation by means of a communication form conforming to the model in Annex 1, ~~Appendix Part 2~~ to this Regulation. "

Paragraph 7.1., amend to read:

"7.1. Vehicles, ~~and~~ bodyworks **and fire suppression systems** approved to this Regulation shall be so manufactured as to conform to the type approved by meeting the requirements set forth in paragraph 5. above."

Paragraphs 8.1. to 8.2., amend to read:

"8.1. The approval granted in respect of a vehicle, ~~or~~ bodywork **or fire suppression system** type pursuant to this Regulation may be withdrawn if the requirement laid down in paragraph 5. above is not complied with.

8.2. If a Contracting Party to the Agreement applying this Regulation withdraws an approval it has previously granted, it shall forthwith notify the other Contracting Parties applying this Regulation, by means of a communication form conforming to the model in Annex 1 ~~Appendix Part 2~~ to this Regulation."

Paragraph 9., amend to read:

"9. Production definitely discontinued

If the holder of the approval completely ceases to manufacture a type of vehicle, ~~or~~ bodywork **or fire suppression system** under this Regulation, he shall so inform the authority which granted the approval. Upon receiving the relevant communication, that authority shall inform thereof the other Parties to the 1958 Agreement applying this Regulation by means of a communication form conforming to the model in Annex 1, Part 2 ~~+~~ to this Regulation."

Annex 1, Part 1, Appendix 1, insert items 4.3 to 4.3.3., to read

"4.3. **Fire suppression system**

4.3.1. **Make and type of the fire suppression system:.....**

4.3.2. **Type approval number of the fire suppression system:....."**

Annex 1, Part 1, Appendix 3, insert items 4. to 4.2., to read

"4. **Fire suppression system**

4.1. **Make and type of the fire suppression system:.....**

4.2. **Type approval number of the fire suppression system:....."**

Annex 1, Part 1, insert a new Appendix 4, to read

" Annex 1

Part 1

Appendix 4

Model information document relation to Regulation No. 107 relating to Type Approval of a fire suppression system as a component.

The following information, if applicable, shall be supplied in triplicate and include a list of contents. Any drawings shall be supplied in appropriate scale and in sufficient detail on size A4 or on a folder of A4 format. Photographs, if any, shall show sufficient detail.

If the components have electronic controls, information concerning their performance shall be supplied.

1. **General**
 - 1.1. **Make (trade name of manufacturer):**
 - 1.2. **Type and general commercial description:**
 - 1.5. **Name and address of manufacturer:**

2. **Fire suppression system**
 - 2.1. **Extinguishing agent (make and type) :.....**
 - 2.2. **Mass of extinguishing agent (needed in a 4 m³ engine compartment):.....**
 - 2.3. **Nozzle (make and type):.....**
 - 2.4. **Number of nozzles (needed in a 4 m³ engine compartment):.....**
 - 2.5. **Type of propellant gas:**
 - 2.6. **Pressure of propellant gas (needed in a 4 m³ engine compartment):.....**
 - 2.7. **Minimum operating temperature :.....**
 - 2.8. **Dimensions of pipes and fittings :.....**
 - 2.9. **Detailed description, layout drawings and installation manual of the fire suppression system and its components:....."**

Annex 1, Part 2, insert a new Appendix 4, to read

"Annex 1

Part 2

Appendix 4

Communication

(Maximum format: A4 (210 x 297 mm))



issued by: Name of administration:
.....
.....
.....

concerning²: **APPROVAL GRANTED**
APPROVAL EXTENDED
APPROVAL REFUSED
APPROVAL WITHDRAWN
PRODUCTION DEFINITELY DISCONTINUED

of a type of a component with regard to Regulation No. 107

Approval No.: Extension No.:

Section I

1. **Make (trade name of manufacturer):**.....
2. **Type:**
3. **Means of identification of type if marked on the component:**
- 3.1. **Location of that marking:**
4. **Name and address of manufacturer:**
5. **If applicable, name and address of manufacturer's representative:**
5. **Location and method of affixing of the Type-Approval mark:**

Section II

1. **Additional information (where applicable): See addendum**
2. **Technical Service responsible for carrying out the tests:**
3. **Date of test report:**
4. **Number of test report:**
5. **Remarks (if any): See Addendum**
6. **Place:**
7. **Date:**
8. **Signature:**

9. The index to the information package lodged with the Approval Authority, which may be obtained on request, is attached.

**Addendum to Type-Approval certificate No.....
concerning the Type-Approval of a fire suppression system as a component
with regard to Regulation No. 107**

1. Additional information
- 1.1. Extinguishing agent (make and type):
- 1.2. Mass of extinguishing agent (needed in a 4 m³ engine compartment) :
- 1.3. Nozzle (make and type) :
- 1.4. Number of nozzles (needed in a 4 m³ engine compartment):
- 1.5. Type of propellant gas :
- 1.6. Pressure of propellant gas (needed in a 4 m³ engine compartment):
- 1.7. Minimum operating temperature:
- 1.8. Dimensions of pipes and fittings:
- "

Annex 2, insert a new paragraph Model D, to read

Model D



a = 8 mm min.

The above approval mark affixed to a fire suppression system shows that the fire suppression system type has been approved in the Netherlands (E4) as a component, pursuant to Regulation No. 107 under approval number [06]2439. The approval number indicates that the approval was granted according to the requirements of Regulation No. 107 as amended by the [06] series of amendments.

Annex 3, Paragraphs 7.5.1.5. to 7.5.1.5.2, amend to read:

- "7.5.1.5. ~~In the case of~~ **Vehicles having the engine located to the rear of the driver's compartment, shall be equipped with an alarm system providing the driver with both an acoustic and a visual signal in the event of excess temperature in the engine compartment and in each compartment where a combustion heater is located.**

~~Vehicles of class III, equipped with an internal combustion engine located to the rear of the driver's compartment,~~ shall be equipped with a fire suppression system in the engine compartment and in each compartment where a combustion heater is located. **Vehicles of classes I, II, A and B, may be equipped with a fire suppression system in the**

engine compartment and in each compartment where a combustion heater is located.

In case of approval of a fire suppression system as a separate technical unit the fire suppression system shall comply with the requirements in of Annex 13.

In case of approval of a vehicle equipped with a fire suppression system the system shall comply either with the requirements of Annex 13, appendix 2 to 5 or with requirements providing an equivalent level of safety applied to the individual engine compartment and each compartment where a combustion heater is located as specified by the manufacturer. These requirements shall be agreed with a Technical Service. The installation of the fire suppression system shall comply with para. 7.5.1.5.4.1, 7.5.1.5.4.2. and 7.5.1.5.4.3.

- 7.5.1.5.1. If fitted, the fire suppression system shall be automatically activated in the engine compartment and in each compartment where a combustion heater is located, through a in case of the activation of the alarm system according to 7.5.1.5. fire detection system. The engine compartment and each compartment where a combustion heater is located shall be equipped with the appropriate number of detectors or sufficient length of detector cable/tube in order to achieve fast detection of the fire. When placing the detectors and choosing their sensitivity, the risk of false alarms shall be taken into account.**

~~The alarm system shall be designed so as to detect a temperature in the engine compartment, and in each compartment where a combustion heater is located in excess of the temperature occurring during normal operation.~~

- ~~**7.5.1.5.2. The fire suppression system shall be equipped with an alarm system providing the driver with both an permanent acoustic and a visual signal in the event of fire detected.** Paragraph 7.5.1.5.1. is considered to be satisfied if the following areas of the engine compartment, and each compartment where a combustion heater is located, are monitored regarding excess temperature: "~~

~~Annex 3, paragraphs 7.5.1.5.2.1. to 7.5.1.5.2.3, shall be deleted.~~

~~Annex 3, Paragraph 7.5.1.5.3., amend to read:~~

- ~~"7.5.1.5.3. The **alarm system and the fire suppression** system shall be operational whenever the engine start device is operated, until such time as the engine stop device is operated, regardless of the vehicle's attitude. "~~

~~Annex 3, insert new paragraphs 7.5.1.5.4. to 7.5.1.5.4.3., to read:~~

- ~~"7.5.1.5.4. The installation of the fire suppression system shall comply with the following requirements;~~

- ~~7.5.1.5.4.1. The fire suppression system shall be installed according to the system manufacturer's **specification installation manual.**~~

- ~~7.5.1.5.4.2. An analysis shall be conducted prior to the installation in order to determine the location of nozzles and discharge points. Potential fire hazards within the engine - and **auxiliary—combustion** heater compartment shall be identified and nozzles and discharge points located such that the suppression agent is released to cover those hazards when the system is activated. The spray pattern and direction of nozzles or discharge points as well as the throwing distance shall be ensured to~~

cover identified fire hazards. The system shall also be ensured to work properly regardless of the vehicles altitude.

Fire hazards to be taken into account in the analysis shall at least consist of the following: Components which surface may reach temperatures above the auto-ignition temperature for fluids, gases or substances that are present within the compartment and electrical components and cables with a current or voltage high enough for an ignition to occur as well as hoses and containers with flammable liquid or gas (in particular if they are pressurized). The analysis shall be fully documented.

Maintenance instructions shall be a part of the analysis.

- 7.5.1.5.4.3. The **volume of suppression agent and number of nozzles or discharge points** ~~suppression system~~ shall be scaled **up or down** from the tested system, based on the total gross volume of the engine and ~~auxiliary combustion~~ heater compartments where the system is to be installed. When measuring the engine compartment and the ~~auxiliary combustion~~ heater compartment, the gross volume of those compartments shall be measured, i.e. the volume of the engine and its components should not be subtracted.

The system scaling includes mass of suppression agent, **and the number of nozzles or discharge points** ~~and mass of propellant gas~~. The system pressure shall remain the same as in the tested system. ~~It is acceptable if the suppression system have more suppression agent and/or more nozzles (or other discharge points used) and/or more propellant gas than required according to the scaling models found below.~~

If the gross volume of the engine and ~~auxiliary combustion~~ heater compartments exceeds 4 m³, the suppression system shall be scaled up using the following scaling factor (1). If the gross volume ~~are~~ is less than 4 m³ it is allowed to scale down the suppression system using the following scaling factor (2). S_x denotes the scaling factor and x [m³] denotes the total gross volume of the engine and ~~auxiliary combustion~~ heater compartments [m³]

$$S_x = 0,1 \cdot x + 0,6 \quad (1)$$

$$S_x = 0,15 \cdot x + 0,4 \quad (2)$$

~~The down-scaled number of nozzles or other discharge points shall be rounded up if less than 8 nozzles or discharge points are used in the test, to the closest whole number."~~

Insert a new Annex 13, to read:

"Annex 13

Requirements regarding fire suppression systems

1. Specifications
 - 1.1. Fire suppression systems shall be tested for high fire load, low fire load, high fire load with fan, **if a fan is fitted in the engine and/or combustion heater compartment**, and ~~re~~ self-ignition.
 - 1.2. The test apparatus, test fires and general test conditions are described in Appendix 1 of this annex.
 - 1.3. High fire load
 - 1.3.1. The high fire load test shall be conducted in accordance with Appendix 2 of this annex.

- 1.3.2. The test shall be conducted with extinguishing agent and propellant gas vessel cooled to the minimum operating temperature for the fire suppression system, as declared by the manufacturer.
- 1.3.3. The fires shall be fully extinguished either not later than 1 minute after activation or upon end of the discharge of the suppression system.
- 1.3.4. The test is considered passed either after success at first attempt or at two of three attempts in a case when first of these attempts fails.
- 1.4. Low fire load
 - 1.4.1. The low fire load test shall be conducted in accordance with Appendix 3 of this annex.
 - 1.4.2. The fires shall be fully extinguished either not later than 1 minute after activation or upon end of the discharge of the suppression system.
 - 1.4.3. The test is considered passed either after success at first attempt or at two of three attempts in a case when first of these attempts fails.
- 1.5. High fire load with fan (if a fan is fitted in the engine and/or combustion heater compartment)
 - 1.5.1. The high fire load test with fan shall be conducted in accordance with Appendix 4 of this annex.
 - 1.5.2. The fires shall be fully extinguished either not later than 1 minute after activation or upon end of the discharge of the suppression system.
 - 1.5.3. The test is considered passed either after success at first attempt or at two of three attempts in a case when first of these attempts fails.
- 1.6. **ReSelf**-ignition test
 - 1.6.1. The **reSelf**-ignition test shall be conducted in accordance with Appendix 5 of this annex.
 - 1.6.2. The fire shall be fully extinguished and no ~~reSelf~~-ignition shall occur within 45 seconds after activation of the fire suppression system.
 - 1.6.3. The test is considered passed either after success at first attempt or at two of three attempts in a case when first of these attempts fails.

Annex 13

Appendix 1

Test apparatus, test fires and general test specifications

- 1. Test apparatus
 - 1.1 The test apparatus is to be made of steel plate. The thickness of the steel plate shall be in accordance with Table 1. Figure 1 shows the test apparatus from the front side and figure 2 from the rear side. Note that the front side of the test apparatus simulates the rear side of a real engine compartment.

Figure 1 Coordinate system for the position of objects in test apparatus (view from front side)

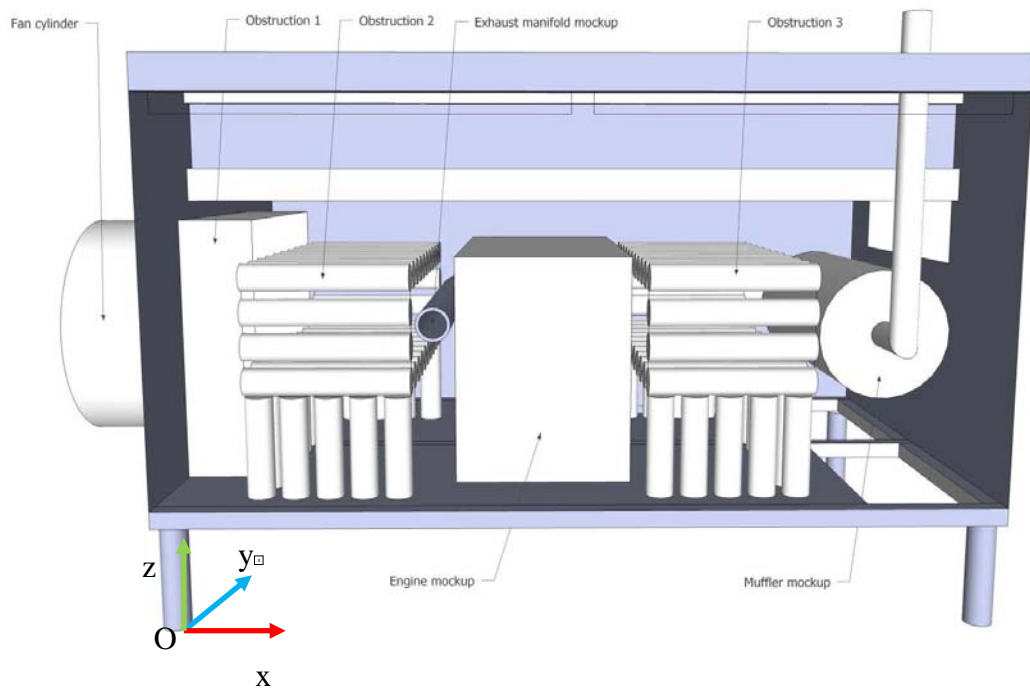

Figure 2 Test apparatus seen from rear side

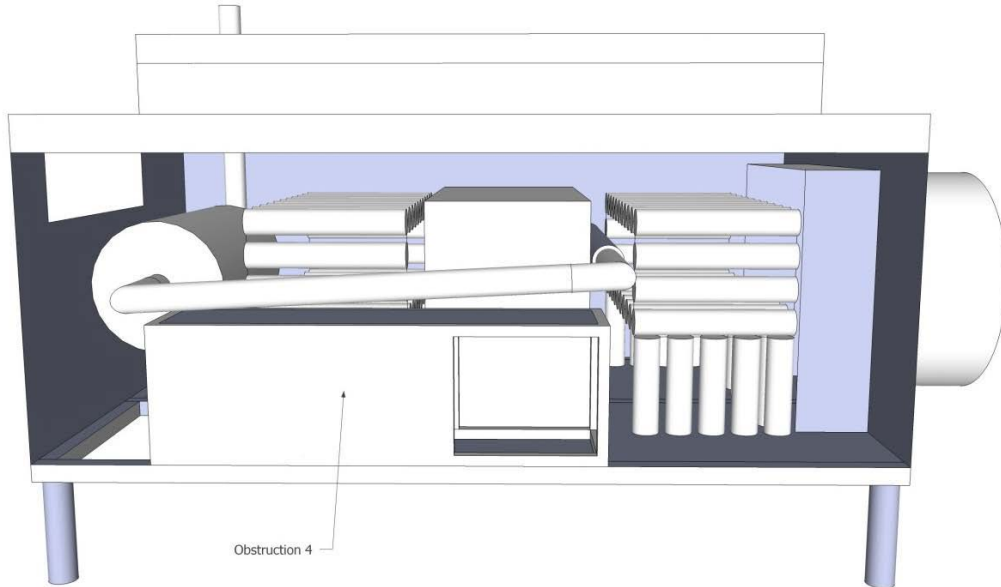

Table 1 Test apparatus objects

Objects	Plate thickness
Fan cylinder	1.5 – 3 mm
Obstructions	1.5 – 3 mm
Exhaust manifold mockup	8 mm
Engine mockup	2 – 3 mm
Muffler mockup	2 – 3 mm
Exhaust pipe	2 – 3 mm
Connection pipe	2 – 3 mm
Walls, ceiling and floor	1.5 mm – 5 mm

1.2 Object locations

1.2.1 All objects in the test apparatus are positioned according to coordinates (x, y, z) as shown in Table 2. Origin is the position marked (O) in Figure 1. The value of the coordinates is the distance in meter from origin (see Figure 1, i.e. left-front-bottom corner).

Table 2 Test apparatus objects

Objects	Coordinates
Fan cylinder	(-0.2, 0.80, 0.42)
Obstruction 1	(0.0, 0.35, 0.0)
Obstruction 2	(0.25, 0.25, 0.0)
Exhaust manifold mockup	(0.78, 0.78, 0.50)
Engine mockup	(0.86, 0.22, 0.05)
Obstruction 3	(1.4, 0.25, 0.0)
Muffler mockup	(2.1, 0.75, 0.45)

1.3 Framework

- 1.3.1 The framework of the test apparatus shall be constructed according to Figure 3. The sizes of the beams are $0.05\text{ m} \times 0.05\text{ m}$ and $0.10\text{ m} \times 0.05\text{ m}$ respectively.

Figure 3 Framework for the test apparatus

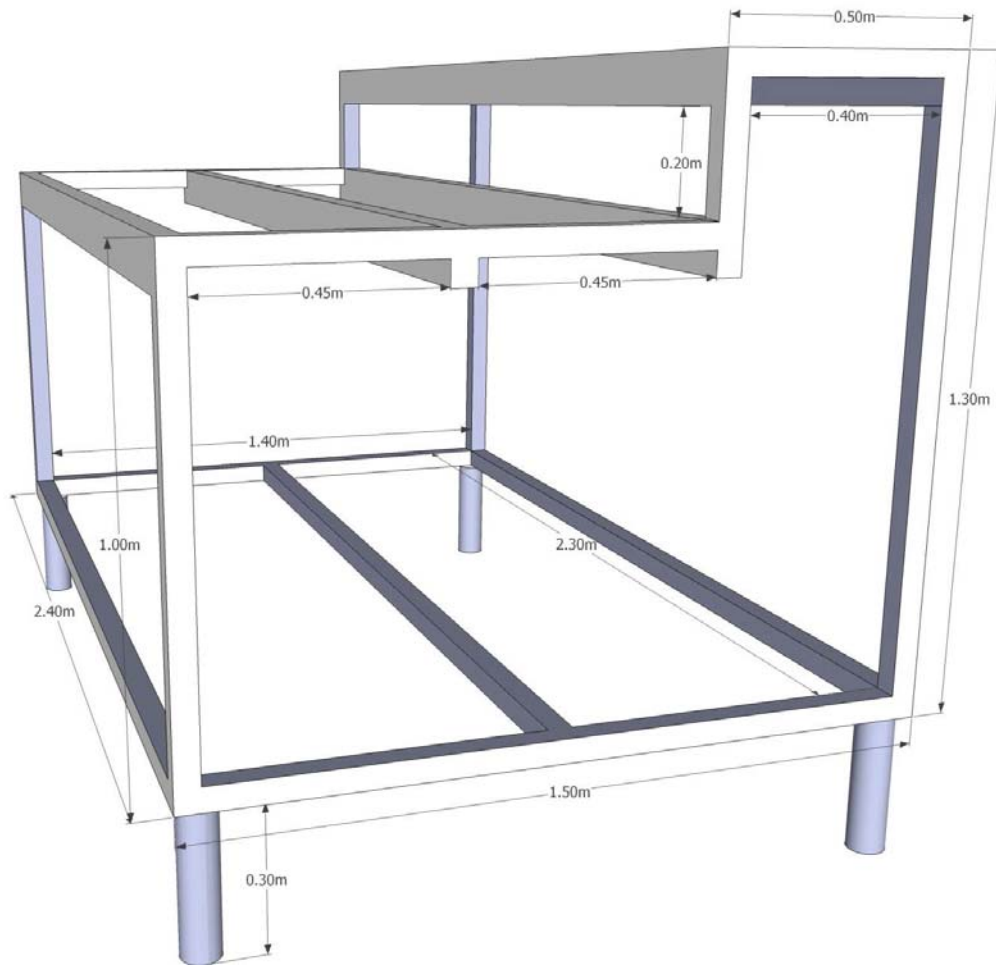

1.4. Apertures

- 1.4.1 In addition to the opening for the fan, the test apparatus includes six apertures, according to Figure 4. Note that all objects inside the test apparatus are hidden in Figure 4 in order to more clearly show the apertures. The dimensions and positions of the apertures are according to the coordinates in Table 3. The positions are given by referring to two diagonally opposite corners (all apertures are rectangular in shape).

Figure 4 Apertures in the test apparatus

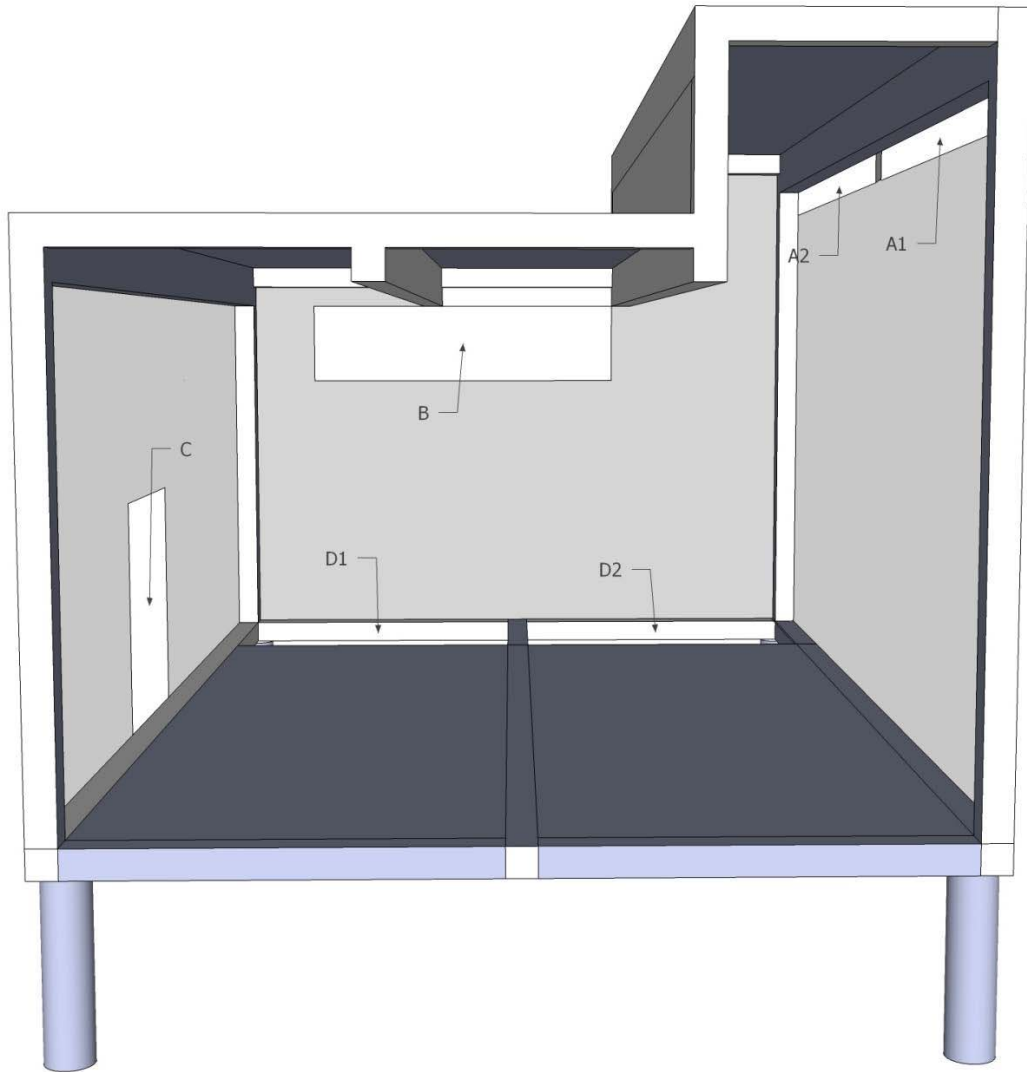

Table 3 Coordinates of Apertures in the test apparatus

Aperture	Coordinates (x, y, z – x, y, z)	Area of aperture
A1	0.05, 0.00, 1.14 – 1.17, 0.00, 1.20	0.07 m ²
A2	1.23, 0.00, 1.14 – 2.35, 0.00, 1.20	0.07 m ²
B	2.40, 0.50, 0.70 – 2.40, 1.30, 0.90	0.16 m ²
C	0.85, 1.50, 0.05 – 1.25, 1.50, 0.50	0.18 m ²
D1	1.95, 0.05, 0.05 – 2.35, 0.73, 0.05	0.27 m ²
D2	1.95, 0.78, 0.05 – 2.35, 1.45, 0.05	0.27 m ²
	Total area of apertures:	1.02 m ²

1.5. Fan

1.5.1. An axial fan with a diameter of 0.71 m (+0.00 m, -0.03 m) shall be mounted on the left side of the fan cylinder. The cylinder shall have a diameter of 0.71 m and a length of 0.4 m. The fan shall produce a certain

air flow rate through the cylinder according to the test scenarios in Appendix 2 to 6. A frequency converter may be used to adjust the fan speed.

Figure 5 Fan cylinder



1.6. Mockup components

- 1.6.1. The dimensions of the engine mockup are 1.00 m × 0.65 m × 0.50 m. The dimensions of the muffler mockup are Ø0.40 m × 0.80 m. The muffler and the engine mockup shall be hollowed. The exhaust manifold mockup shall have the inner dimensions of Ø0.080 m × 0.80 m. The exhaust manifold mockup shall be connected to the muffler mockup through a pipe with a diameter of 0.076 m (±0.01 m). A pipe from the muffler mockup should also be used to carry the exhaust gases from the pre-warming system out from the test apparatus. The whole exhaust gas system from the propane burner inlet to the exhaust gas outlet should be relatively smoke tight.

Figure 6 The exhaust system

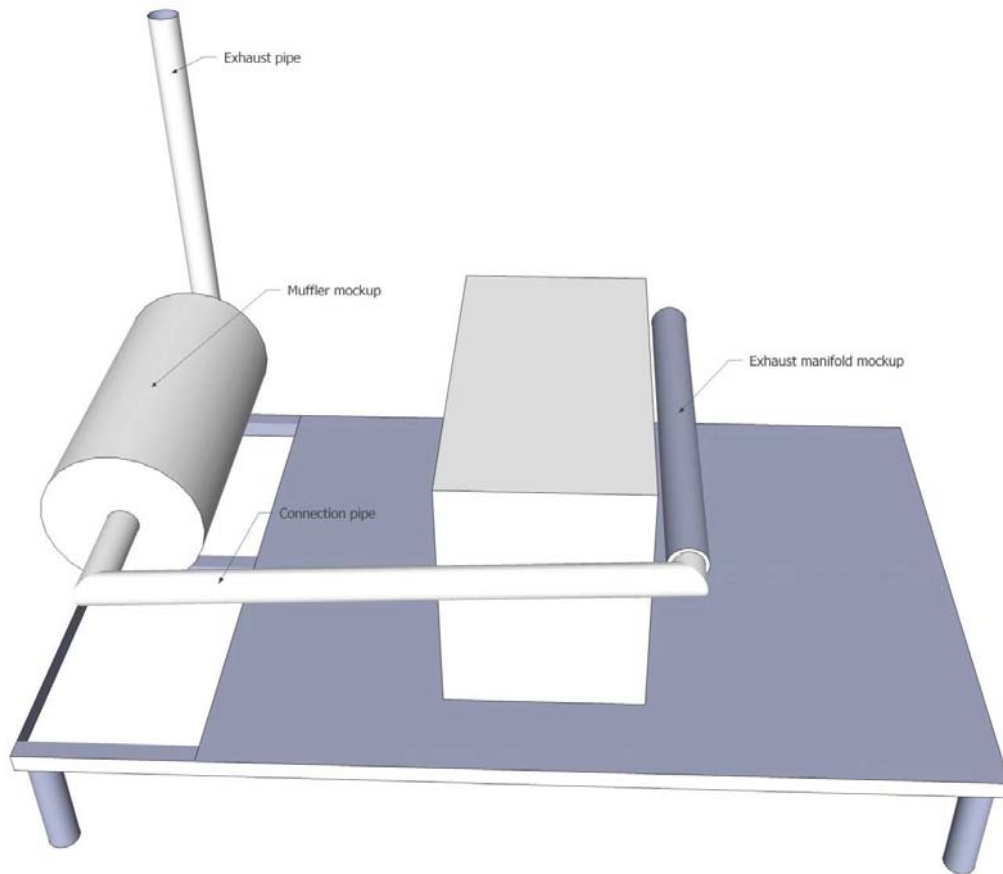

1.7. Thermocouples

1.7.1 Seven thermocouples (Tc) shall be mounted on the exhaust manifold mockup, drilled 2 mm into the tube from the outside. The location of the thermocouples shall be in accordance with Figure 7 and 8. Tc1 – Tc4 shall be located on top of the tube and Tc5 – Tc7 around the tube, on the same distance from the tube opening as Tc2.

Figure 7 Thermocouples on the exhaust manifold mockup

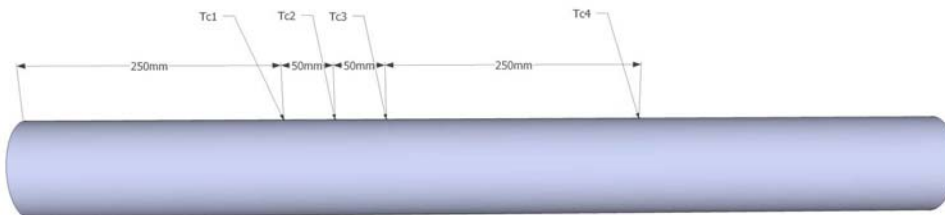
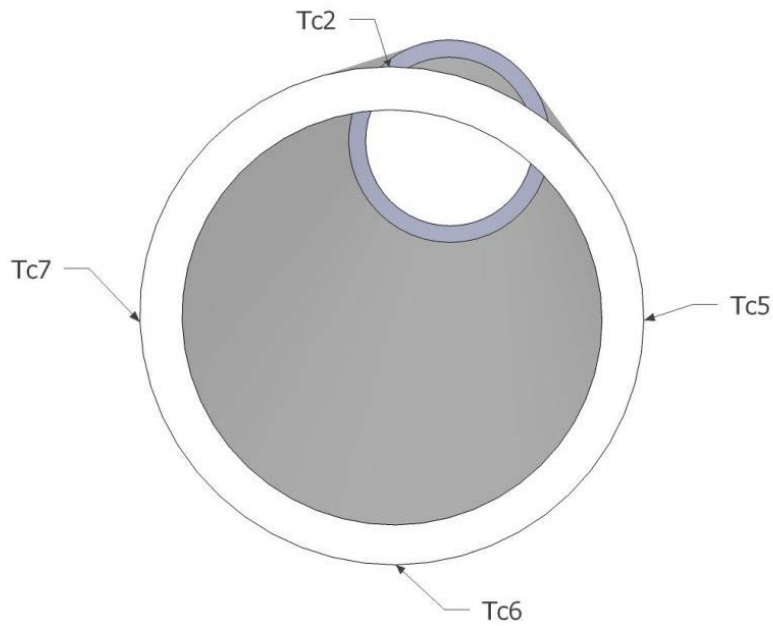

Figure 8 Thermocouples on the exhaust manifold mockup



1.8 Propane burner

1.8.1. The propane burner used to pre warm the exhaust system shall have a burner effect of 55 kW (± 10 kW).

1.9 Obstructions

1.9.1 Obstruction 1 has the dimensions of 0.80 m \times 0.80 m \times 0.22 m, as shown in Figure 9. Obstructions 2 and 3 consist of tubes as shown in Figure 10. The horizontal obstructions tubes are closed and hollow, with a diameter of 0.08 m and a length of 0.48 m. The vertical tubes are hollow and open in the bottom, with a diameter of 0.08 m and a length of 0.30 m. The open distance between every tube is 0.02 m. Obstruction 4 is a box measuring 1.25 m \times 0.30 m \times 0.39 m as shown in Figure 11.

Figure 9 Obstruction 1

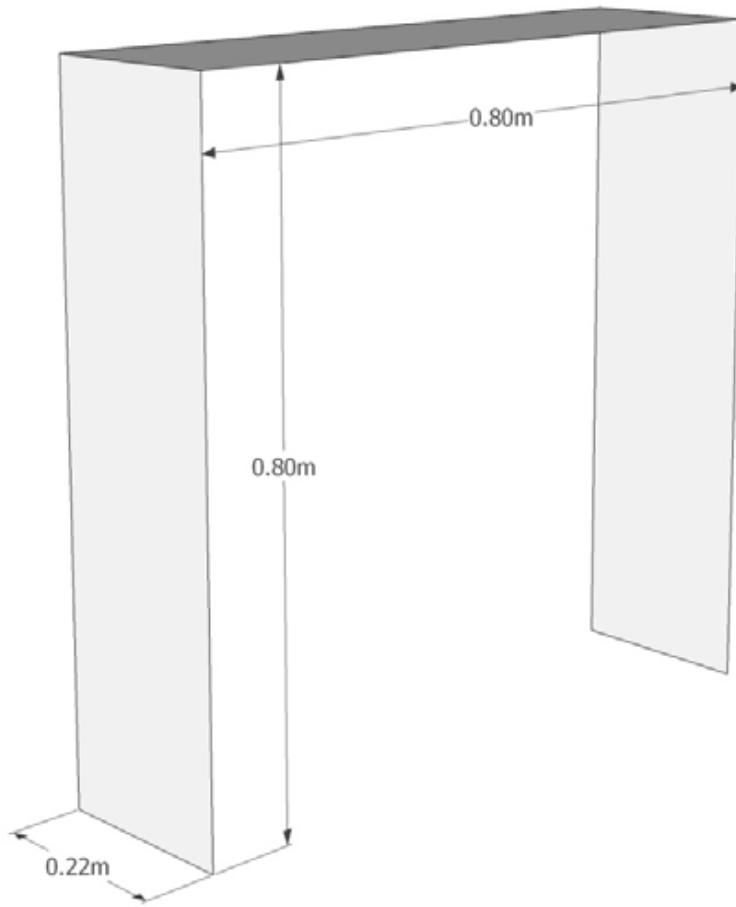

Figure 10 Obstruction 2 and 3

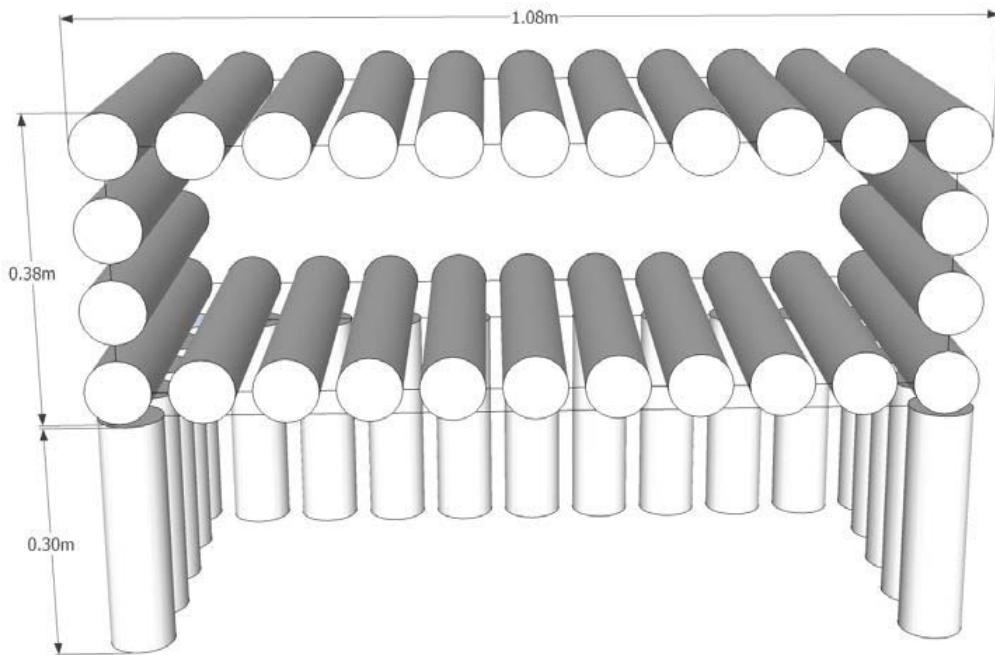
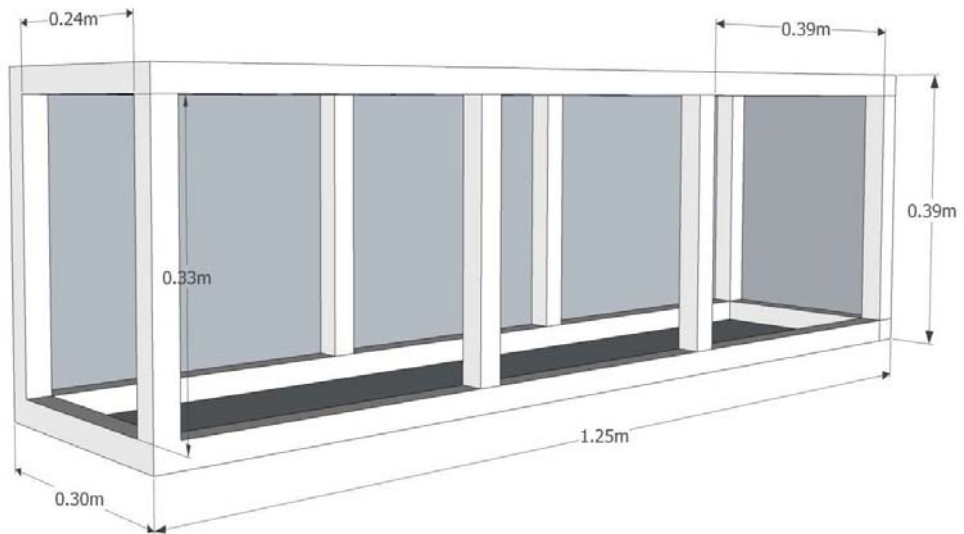

Figure 11 Obstruction 4



1.10. Pool fire trays

1.10.1 The square pool fire trays with fibreboards and the rectangular pool fire trays shall be positioned in its orientation according to the test scenarios in Appendix 2 to 5. Figures 12 and 13 show the lengthwise and transverse orientations of the pool fire trays with fibreboards. Figures 14 and 15 show the lengthwise and transverse orientation of the rectangular pool fire trays. Furthermore, the pool fire trays shall be positioned perpendicular to the long edge of the test apparatus. Diesel spray nozzles shall also be positioned perpendicular to the long edge of the test apparatus, spraying in the direction of the arrow according to the test scenarios in Appendix 2, 4 and 5.

Figure 12 Lengthwise orientation of the pool fire trays with fibreboards

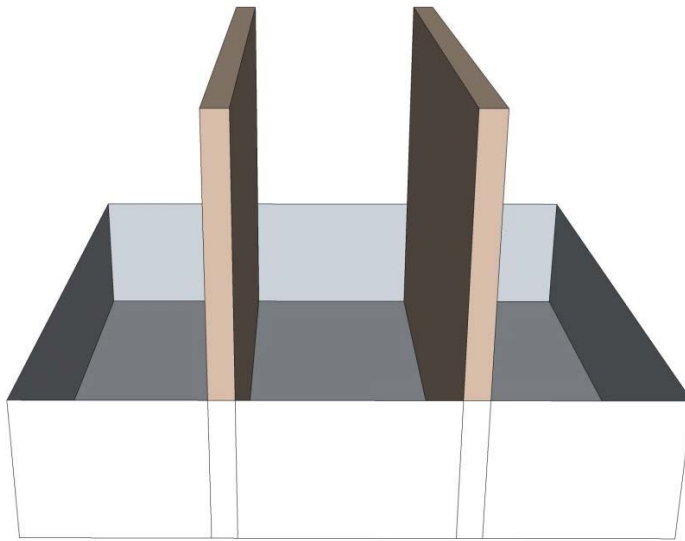

Figure 13 Transverse orientation of the pool fire trays with the fibreboards

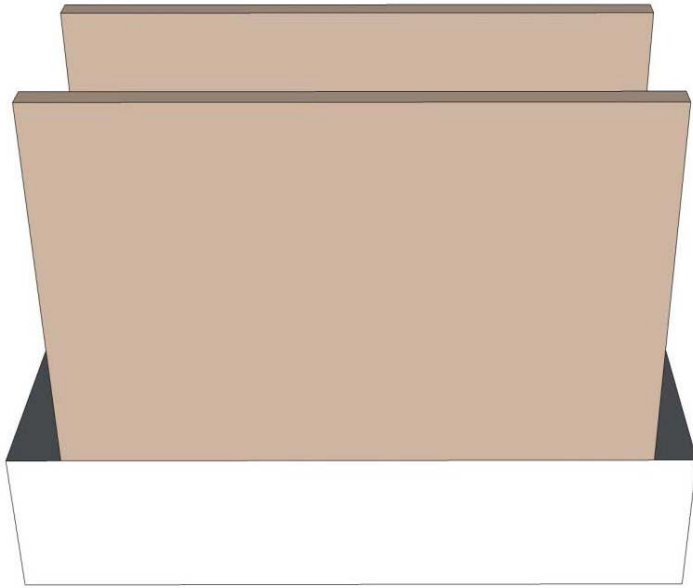

Figure 14 Lengthwise orientation of the rectangular pool fire tray

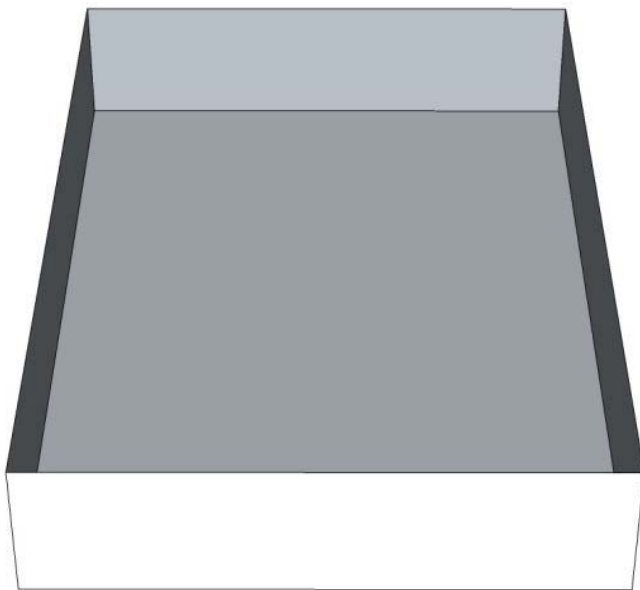
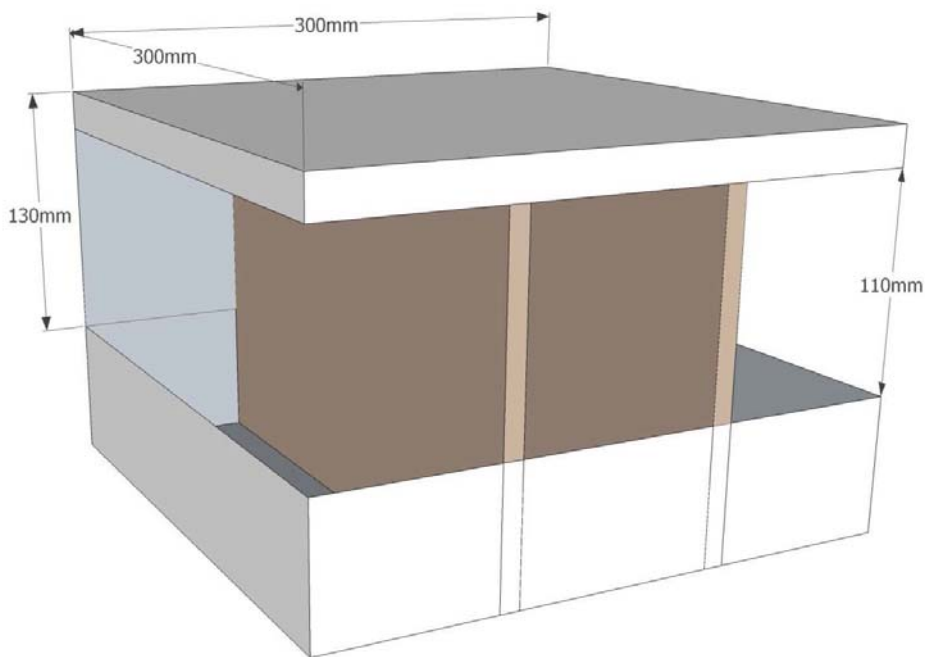

Figure 15 Transverse orientation of the rectangular pool fire tray



1.10.2 Test fire # 2 is concealed from the top and from the rear side with an steel plate obstruction according to Figure 16.

Figure 16 Test fire concealed from the top and from the rear side



2. Test fires

2.1 The test fires in Table 4 below are to be used in the different test scenarios described in Appendix 2 to 5. Diesel oil (commercial fuel oil or light diesel oil), heptane (C₇H₁₆) and engine oil 15W-40 with a flash point COC of 230°C and viscosity at 40°C of 107 mm²/s shall be used as test fuels.

Table 4 Test fires

Test fire	Description	Fuel	Approximate peak Heat Release Rate 60 sec after
-----------	-------------	------	---

			ignition
#1	Pool fire 0.3 m × 0.3 m	Diesel oil and heptane	60 kW
#2	Pool fire 0.3 m × 0.3 m and 2 Fibreboards	Diesel oil and heptane	110 kW
#3	Pool fire 0.2 m × 0.3 m	Diesel oil and heptane	40 kW
#4	Pool fire Ø 0.15 m	Diesel oil and heptane	7 kW
#5	Spray fire (4.5 bar, 0.73 kg/min)	Diesel oil	520 kW
#6	Spray fire (4.5 bar, 0.19 kg/min)	Diesel oil	140 kW
#7	Dripping oil fire (2 bar, 0.01 kg/min)	Engine oil	5 kW

2.2 Three different types of pool fire trays are applied in Table 4: square, rectangular and circular. Detailed descriptions of these trays are given in Table 5.

Table 5 Specification of pool fire trays

Dimensions	Rim height	Nominal thickness	Used for test fire
0.3 m × 0.3 m	0.07 m	1.5 mm	#1, #2
0.2 m × 0.3 m	0.07 m	2 mm	#3
Ø 0.15 m	0.1 m	1.5 mm	#4

2.3 The amount of water, diesel and heptane (±10 %) used in the tests should be in accordance with Table 6.

Table 6 Amount of fuel used in pool fire trays

Dimensions	Water	Diesel	Heptane	Used for test fire
0.3 m × 0.3 m	1.0 l	0.5 l	0.2 l	#1, #2,
0.2 m × 0.3 m	0.5 l	0.5 l	0.2 l	#3
Ø 0.15 m	0.2 l	0.2 l	0.1 l	#4

2.4. Test fire #2 consists of a heptane pool and two diesel soaked fibreboards with a dry density of 3.5 kg/m³. The dimensions of the fibreboards shall be 12 mm × 290 mm × 190 mm. The fibreboards shall consist of at least 90 % raw material from wood. The moisture content in the boards before they are soaked in diesel oil shall not exceed 7 %. The fibreboards shall be completely immersed in diesel oil for at least 10 minutes prior to the test and mounted vertically in the pool fire tray not more than 10 minutes before the start of the test.

2.5. Test fire #5 and #6 consist of diesel oil spray fires while Test fire #7 consists of a dripping oil fire (by hot surface ignition).

The spray nozzle for test fire #5 shall be Lechler 460.368.30 or equivalent. The spray nozzle for test fire #6 shall be Lechler 212.245.11 or equivalent. The nozzle for test fire #7 shall be Danfoss 0.60X80H or equivalent.

3. Installation of fire suppression system

3.1 To obtain the minimum discharge rate condition, an extinguishing system is to be assembled using its maximum piping limitations with

respect to the number of fittings and size and length of pipe. The cylinder is to be filled to its rated capacity and the cylinder or gas cartridge pressurized with the propellant gas to the normal operating pressure.

3.2. Nozzle positioning in the tests shall be done by the system manufacturer or supplier. The nozzles may only be positioned inside the test apparatus, at two different areas:

1) In the ceiling and at the rear wall. Nozzles positioned in the ceiling shall be positioned within 0.2 m of the lower part of the ceiling and outside of obstruction 1. Nozzles positioned at the rear wall shall be positioned within 0.3 m of the rear wall and not more than 0.5 m from the ceiling. Figure 17 and 18 shows the area where the nozzles may be located.

2) Inside the small box (referred to as obstruction 4) in the rear side of the test apparatus. Nozzles should be located in the ceiling of the box, and not more than 0.1 m of the ceiling. Figure 18 shows the area where the nozzles may be located.

Figure 17 Nozzle positioning seen from the front side of test apparatus

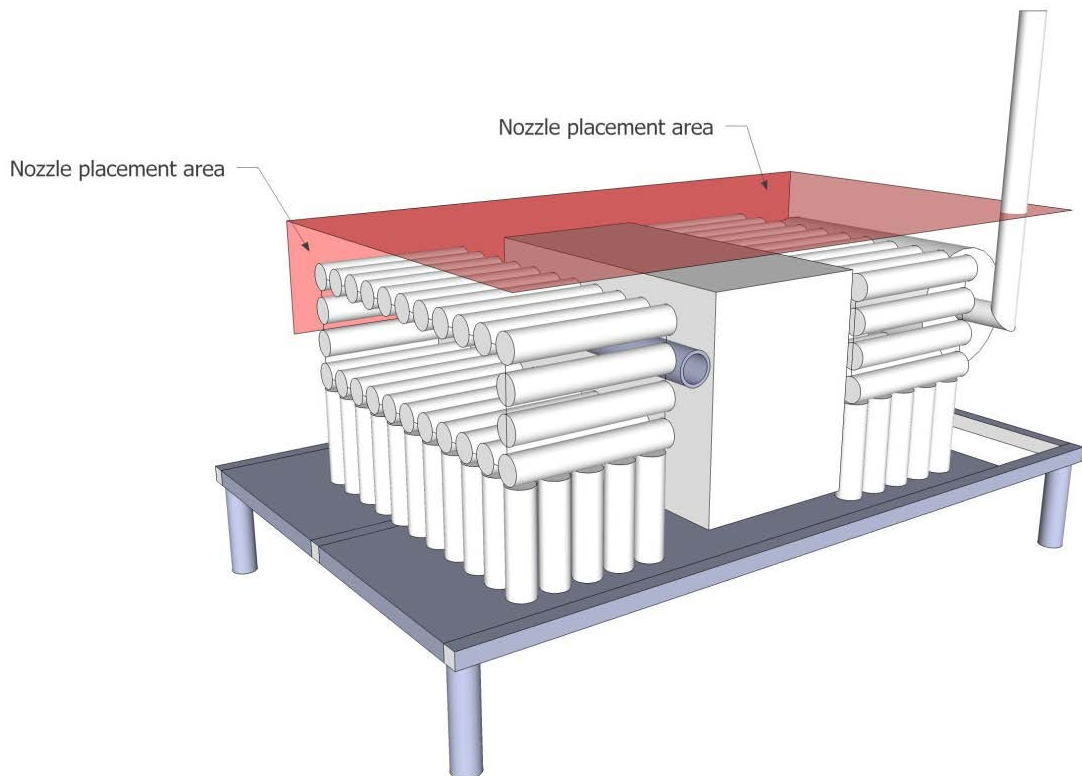
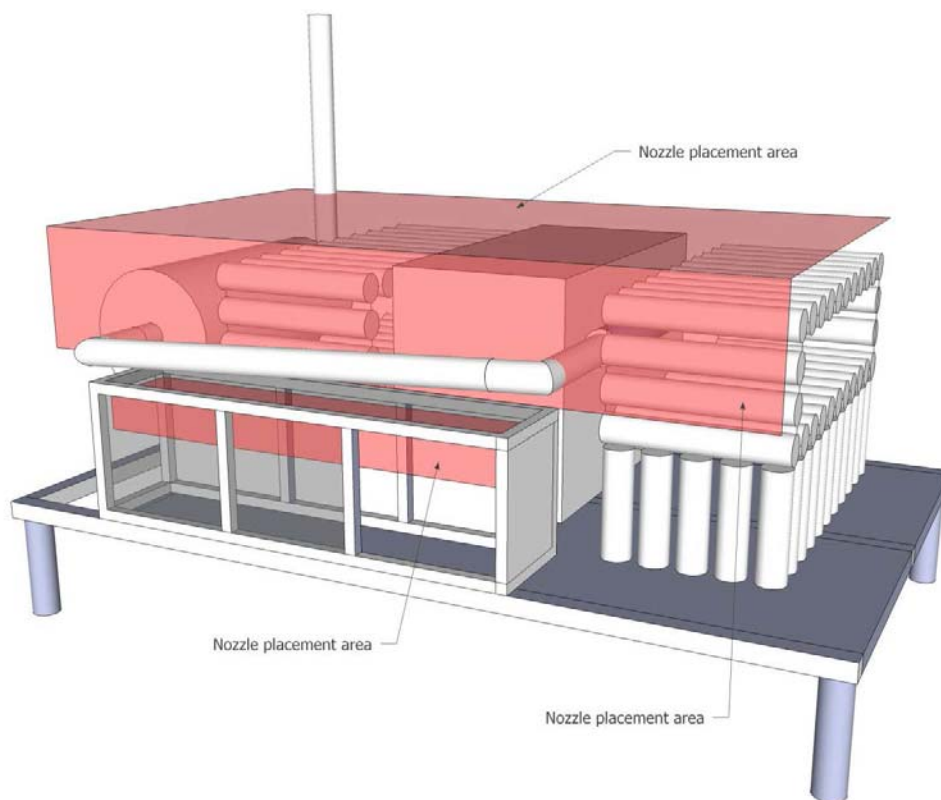

Figure 18 Nozzle positioning seen from the rear side of test apparatus



- 3.3** The system setup and configuration shall be observed and documented prior to the test (e. g. amount of suppression agent and propellant gas, system pressure, number, type and location of nozzles, length of pipes and number of fittings).
- Temperature shall be measured during the re-ignition tests at locations specified in Appendix 1.
- 3.4** Practical conduct of a test
- 3.4.1** The pool fire trays are to be filled with diesel and heptane on a base of water according to Table 6. If fibreboards are to be used as a fire source, the fibreboards shall be soaked in diesel oil, prior to the test, according to instructions in paragraph 2.4.
- 3.4.2** A pre-burn time based on the information in Appendix 2 to 5 is required. The pre-burn time is measured beginning from the time the first fire is ignited. All pool fires in the test scenario shall be ignited within the allowed ignition-time, according to Appendix 2 to 5, using a suitable ignition source.
- 3.4.3.** A fan is used in some of the test scenarios to obtain a specific air flow rate into the test apparatus. The fan shall be engaged 30 seconds before the suppression system is activated. The fan shall remain active until the test is complete, i.e. until it is determined whether the test is passed or failed.
- 3.4.4.** A diesel spray is used in some of the test scenarios. The diesel spray shall be activated 10 seconds prior to activation of the suppression system. The diesel spray shall remain active until the test is complete, i.e. until it is clarified if the test is passed or failed.

- 3.4.5. In test for ~~re~~-self-ignition, the exhaust manifold mockup tube is pre-heated prior to the test with a burner. Pressurized air may be added to the flame for better combustion. The tube shall be heated from the inner side until the temperature of Tc2 is above 600°C and Tc1 is above 570 °C and the temperatures of Tc5, Tc6 and Tc7 not are less than 520°C. When the predefined temperatures are reached the pre-heating procedure stops. After 30 seconds the engine oil start dripping and the suppression system activates 15 seconds later. The engine oil shall ignite before activation of the suppression system. The oil should continue to drip on to the tube until it is clarified if the test is passed or failed.

Appendix 2

High fire load scenario

Test fires:

Test fire (see Table 4 in appendix 1)	Description	Coordinate (x, y, z) (see Figure 1 in Appendix 1)	Orientation	Position denotation (order as x,y,z)
#6	Spray fire (4.5 bar, 0.19 kg/min)	(1.42, 0.75, 0.47)	Transverse	right spray fire
#3	Pool fire 0.2 m × 0.3 m	(0.95, 0.40, 0.70)	Transverse	central-middle-top
#4	Pool fire Ø 0.15 m	(0.95, 1.43, 0.00)	-	central-rear-most- bottom
#3	Pool fire 0.2 m × 0.3 m	(1.54, 0.60, 0.35)	Transverse	right-central-upper
#2	Pool fire 0.3 m × 0.3 m and 2 Fibreboards	(1.54, 0.80, 0.35)	Transverse	right-rear-upper
#3	Pool fire 0.2 m × 0.3 m	(1.54, 0.15, 0.00)	Transverse	right-front-bottom

Fan: The fan is not used

Test procedure:

Time	Action
00:00	Start measuring time
01:20	Ignite pool fires (within 20 seconds)
01:50	Start diesel spray
02:00	Activate suppression system

Figure 1 Test fire positioning, view from the front side

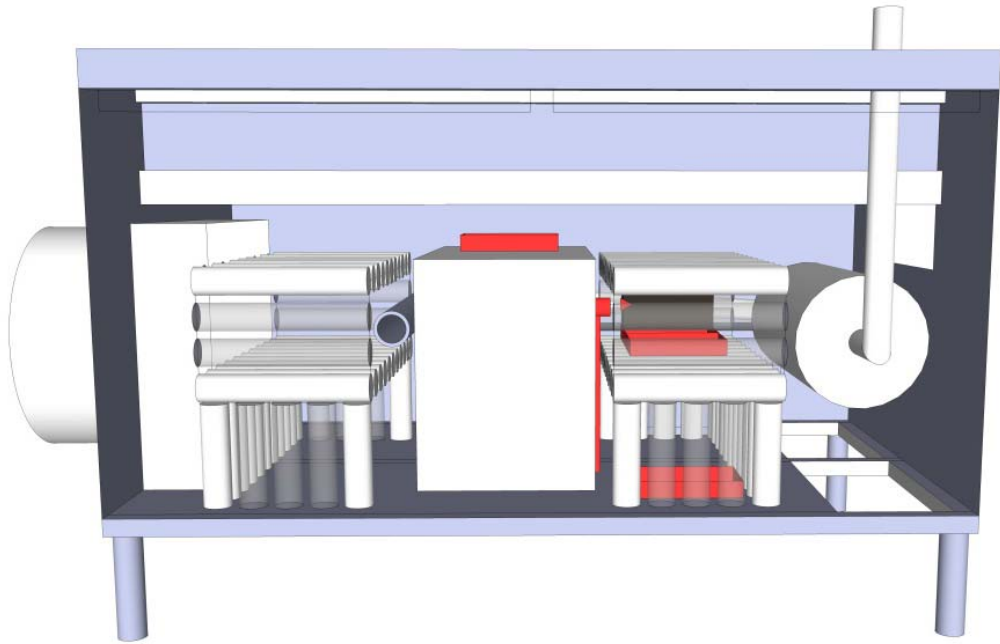
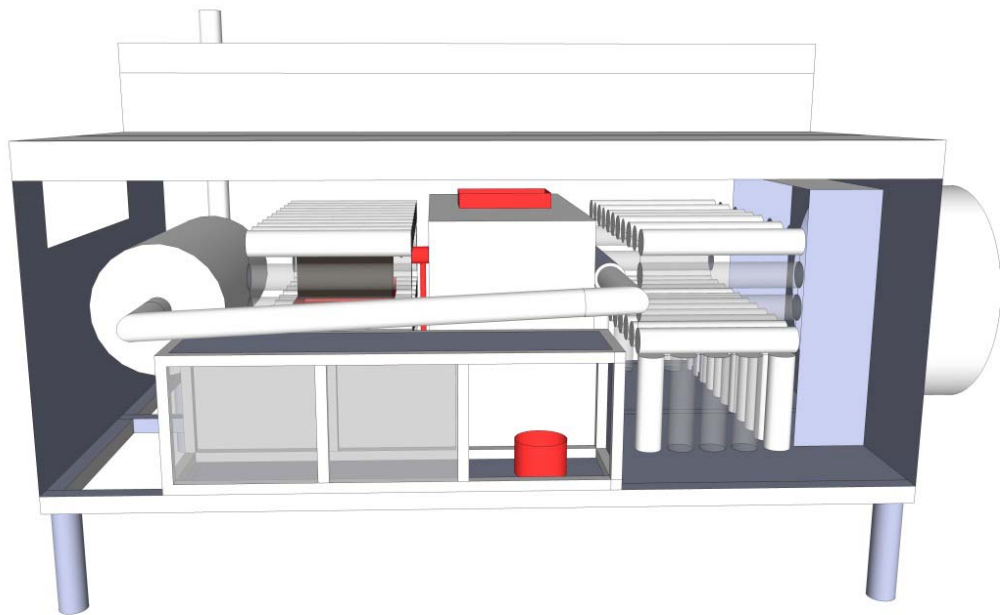

Figure 2 Test fire positioning, view from the rear side



Appendix 3

Low fire load scenario

Test fires:

Test fire (see Table 4 in appendix 1)	Description	Coordinate (x, y, z) (see Figure 1 in Appendix 1)	Orientation	Position denotation (order as x,y,z)

#4	Pool fire Ø 0.15 m	(0.02, 0.08, 0.00)	-	left-front-bottom corner
#3	Pool fire 0.3 m × 0.2 m	(0.37, 0.55, 0.00)	Transverse	left-central-bottom
#4	Pool fire Ø 0.15 m	(0.45, 1.23, 0.00)	-	left-rear-most-bottom
#4	Pool fire Ø 0.15 m	(0.95, 1.43, 0.00)	-	central-rear-most-bottom
#4	Pool fire Ø 0.15 m	(1.62, 0.55, 0.00)	-	right-central-bottom

Fan: The fan is producing an air flow of 1.5 m³/s

Test procedure:

Time	Action
00:00	Start measuring time
01:00	Ignite pool fires (within 30 seconds)
01:30	Engage the fan
02:00	Activate suppression system

Figure 1 Test fire positioning, view from the front side

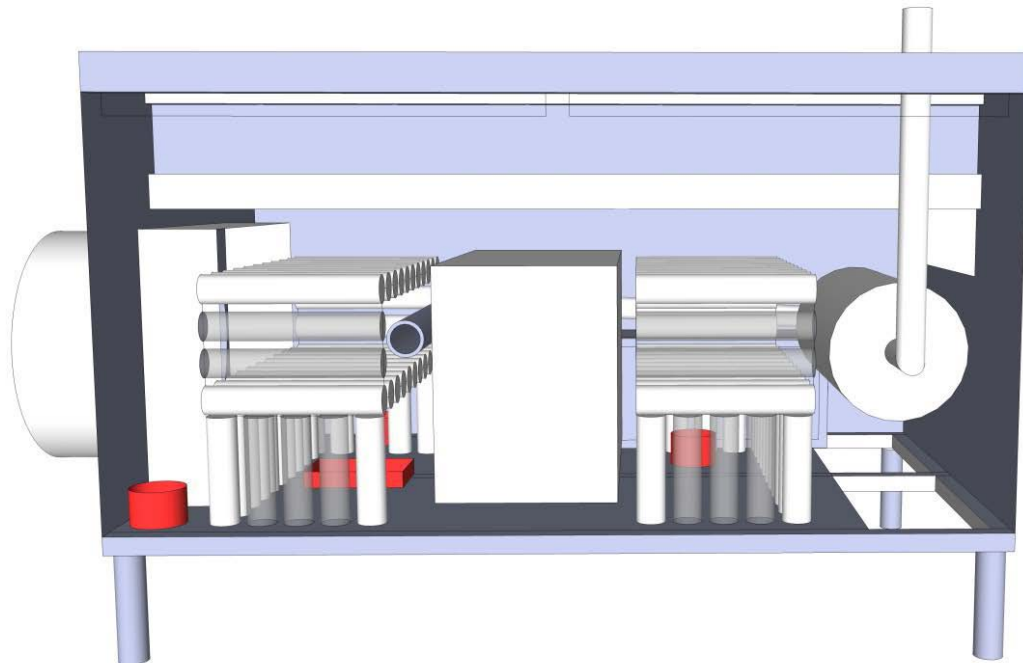
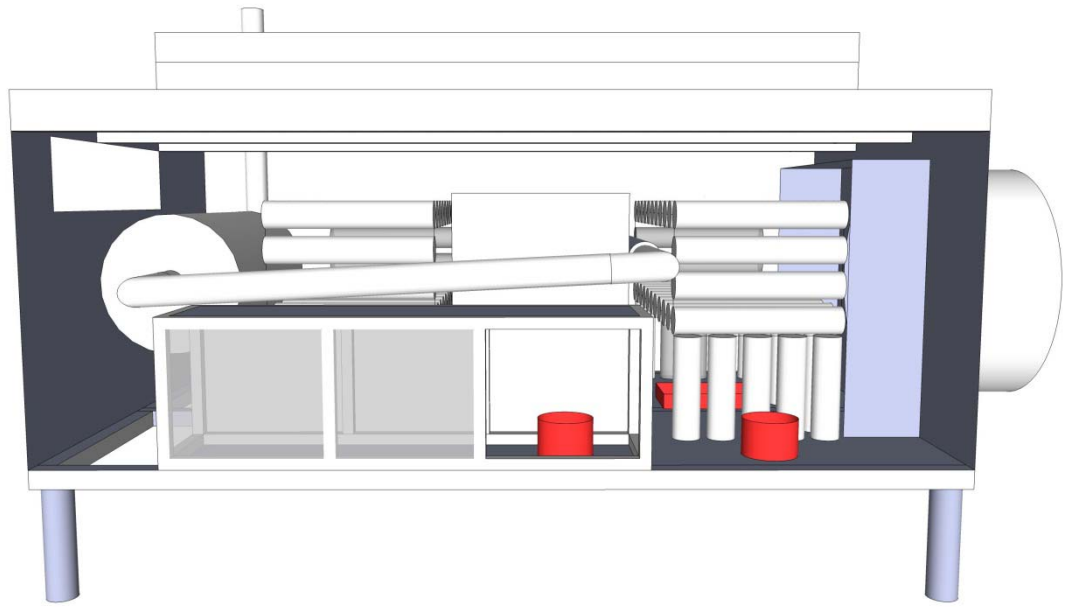

Figure 2 Test fire positioning, view from the rear side



Appendix 4

High fire load scenario with fan

Test fires:

Test fire (see Table 4 appendix 1)	Description	Coordinate (x, y, z) (see Figure 1 in Appendix 1)	Orientation	Position denotation (order as x,y,z)
#5	Spray fire (4.5 bar, 0.73 kg/min)	(0.35, 0.70, 0.47)	Transverse	left spray fire
#1	Pool fire 0.3 m × 0.3 m	(0.37, 0.50, 0.35)	-	left-central-upper
#2	Pool fire 0.3 m × 0.3 m and 2 Fibreboards	(0.37, 0.80, 0.35)	Transverse	left-rear-upper
#1	Pool fire 0.3 m × 0.3 m	(0.37, 0.15, 0.00)	-	left-front-bottom
#1	Pool fire 0.3 m × 0.3 m	(1.54, 0.15, 0.00)	-	right-front-bottom

Fan: The fan is producing an air flow of 1.5 m³/s

Test procedure:

Time	Action
00:00	Start measuring time
01:00	Ignite pool fires (within 20 seconds)
01:30	Engage the fan
01:50	Start diesel spray
02:00	Activate suppression system

Figure 1 Test fire positioning, view from the front side

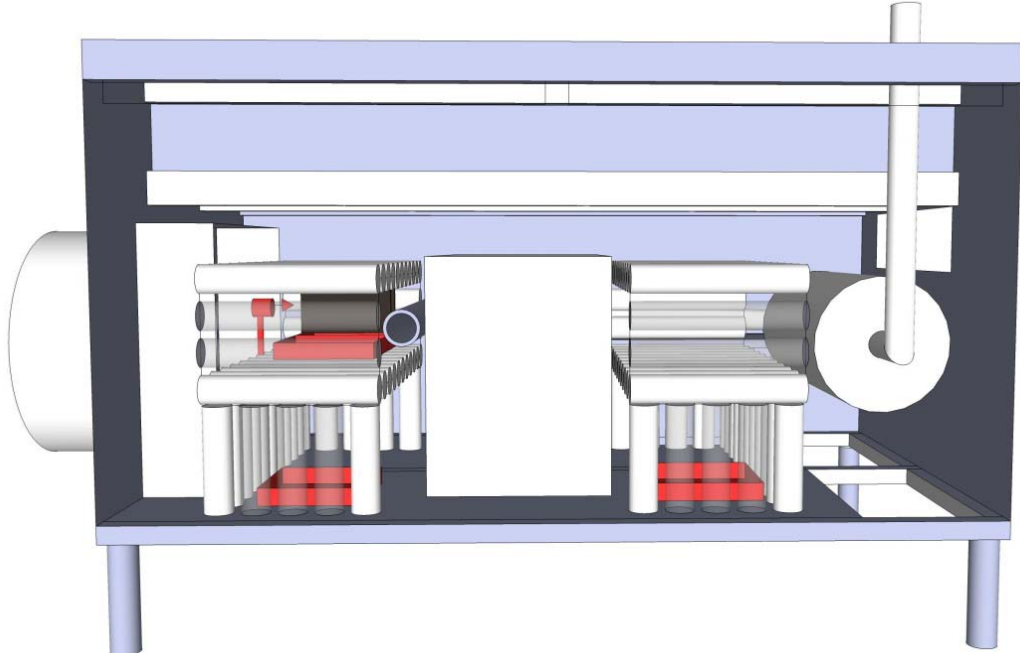

Appendix 5

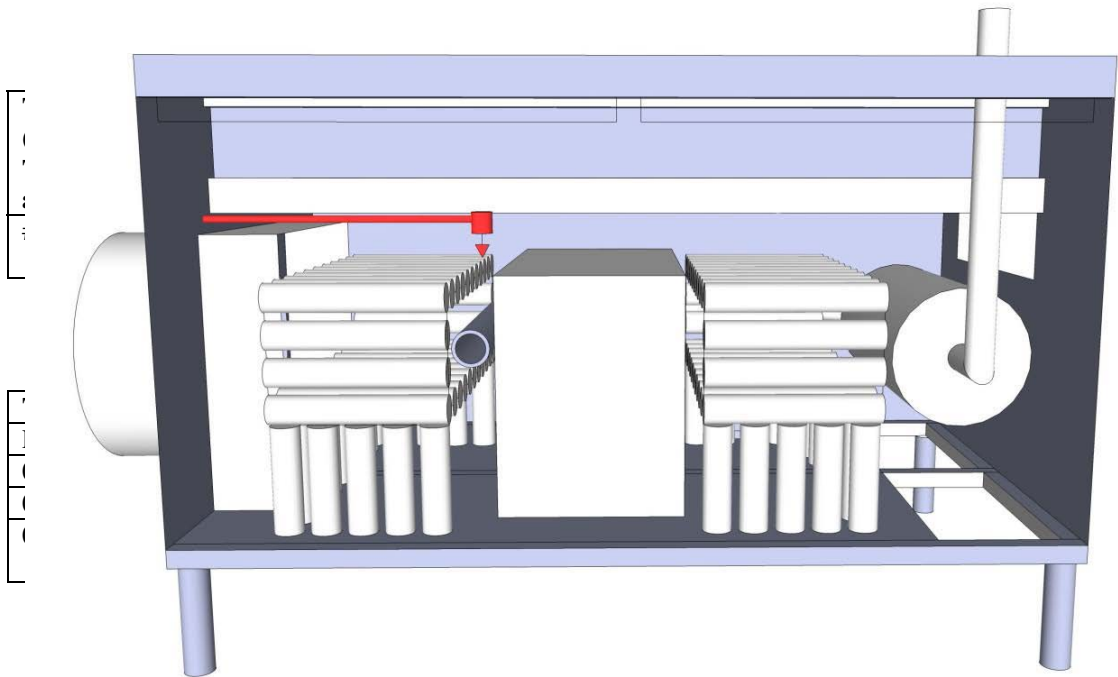

II. Justification

The changes which are introduced in the Swedish proposal amend the Proposal in certain aspects in order to provide a greater flexibility in testing and approving vehicles with fire suppression systems. This document limits the mandatory installation to Class III and therefore reintroduces requirements concerning vehicles that are not obliged to have such systems. It also clarifies the test procedure in case where a fan is fitted or not.
