

**Economic and Social Council**Distr.: General
22 September 2014

Original: English

Economic Commission for Europe

Inland Transport Committee

World Forum for Harmonization of Vehicle Regulations**Working Party on Passive Safety****Fifty-sixth session**

Geneva, 9-12 December 2014

Item 18 of the provisional agenda

Proposal for a new Regulation on Frontal Impact**Proposal of amendments to the draft new Regulation
(ECE/TRANS/WP.29/GRSP/2014/10)****Submitted by the expert from France as Chair of the Informal Working
Group on Frontal Impact***

The text reproduced below was prepared by the experts from the Informal Working Group on Frontal Impact (IWG FI) to introduce the needed modifications to the draft UN Regulation (ECE/TRANS/WP.29/GRSP/2014/10) on frontal impact focusing on requirements for restraint systems. It is based on a document without symbol (GRSP 55-20-Rev.1) distributed at the Working Party on Passive Safety (GRSP) at its fifty-fifth session (ECE/TRANS/WP29/GRSP/55, para. 38). The modifications to the text of the draft UN Regulation (ECE/TRANS/WP.29/GRSP/2014/10) are marked in bold for new or strikethrough for deleted characters.

* In accordance with the programme of work of the Inland Transport Committee for 2012–2016 (ECE/TRANS/224, para. 94 and ECE/TRANS/2012/12, programme activity 02.4), the World Forum will develop, harmonize and update Regulations in order to enhance the performance of vehicles. The present document is submitted in conformity with that mandate.

I. Proposal

Annex 2, amend to read:

"Annex 2

Arrangements of approval marks

Model A

(See paragraph 4.4. of this Regulation)

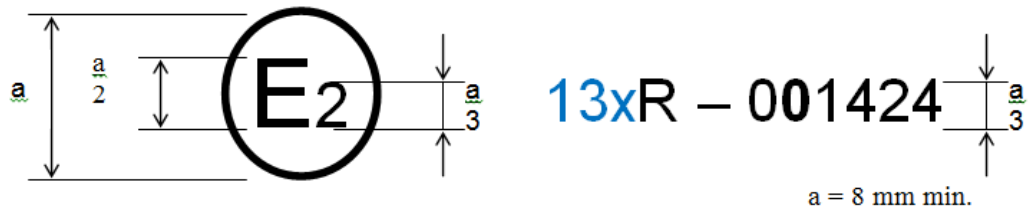

The above approval mark affixed to a vehicle shows that the vehicle type concerned has, with regard to the protection of the occupants in the event of a frontal collision, been approved in ~~the Netherlands (E 4)~~ **France (E2)** pursuant to Regulation No. **13x** ~~{X}~~ under approval number 001424. The approval number indicates that the approval was granted in accordance with the requirements of Regulation No. **13x** ~~{X}~~ as amended by the **020** series of amendments.

Model B

(See paragraph 4.5. of this Regulation)

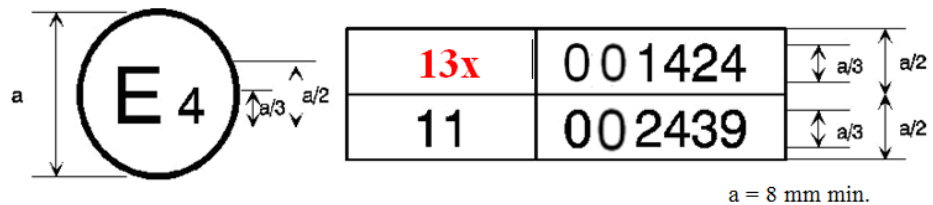

The above approval mark affixed to a vehicle shows that the vehicle type concerned has been approved in the Netherlands (E 4) pursuant to Regulations Nos. **13x** ~~{X}~~ and 11¹. The first two digits of the approval numbers indicate that, at the dates when the respective approvals were granted, Regulation No. **13x** ~~{X}~~ incorporated the **020** series of amendments and Regulation No. 11 incorporated the **020** series of amendments."

¹ The latter number is given only as an example.

Annex 3,

Paragraph 1.4.2.4., amend to read:

"1.4.2.4. If the mass of the measuring apparatus on board of the vehicle..."

Paragraph 1.4.3.10., amend to read:

"1.4.3.10. Head restraints

Head restraints adjustable for height shall be in their ~~uppermost~~ **appropriate** position."

Paragraph 1.4.3.11.2., amend to read:

"1.4.3.11.2. Position of front passenger seat

Seats adjustable longitudinally shall be placed so that their "H" point, determined in accordance with the procedure set out in annex 6, is: ~~in the [forward quarter] position of travel or in the nearest locking position thereto or~~

- (a) in the position given by the manufacturer, which ~~has to be at or in front of the~~ **shall be forward of the** middle position of travel, **or**
- (b) **in the absence of any particular recommendation by the manufacturer, as near as possible to a position which is midway between the forward-most position of the seat and the centre position of its travel.**

~~and at the height position defined by the manufacturer (if independently adjustable for height). In the case of a bench seat, the reference shall be to the "H" point of the driver's place."~~

Paragraph 2.1.1. and footnote 1, amend to read:

"2. Dummies

2.1. Front seats

2.1.1. A dummy corresponding to the specifications for HYBRID III ~~50th~~ **fiftieth percentile male dummy**¹ meeting the specifications for its adjustment shall be installed in the driver seat in accordance with the conditions set out in Annex 5.

A dummy corresponding to the specifications for HYBRID III ~~5th~~ **fifth percentile female dummy**¹ meeting the specifications for its adjustment shall be installed in the passenger seat in accordance with the conditions set out in Annex 5."

¹ The technical specifications and detailed drawings of ~~50th~~ **HYBRID III fiftieth percentile male dummy** and ~~5th~~ **HYBRID III fifth percentile female dummy**, shall correspond to those included in the ~~Mutual Resolution #1.~~

Annex 4

Paragraphs 1. to 1.1., amend to read:

- "1. Head Performance Criterion (HPC₃₆)
- 1.1. The Head Performance Criterion (HPC₃₆) is considered to be satisfied when, during the test, there is no contact between the head and any vehicle component."

Annex 5

Paragraphs 3. to 3.1., amend to read:

- "3. {Installation of the dummy HYBRID III ~~5th~~**fifth percentile female dummy** on the passenger seat }

The longitudinal and vertical dimension of "H" point are described as (X_{50thM}, Z_{50thM}) and the longitudinal and vertical dimension of "H 5th" point are described as (X_{5thF}, Z_{5thF}). XSCL is defined as the horizontal distance between the "H" point and the most forward point on the seat cushion (see Fig. 1). The following formula calculates the "H 5th" point. Note that X_{5thF} should always be more forward than the X_{50thM}.

$$X_{5thF} = X_{50thM} + (93mm - 0.323 \times XSCL)$$

$$Z_{5thF} = Z_{50thM}$$

Figure 1

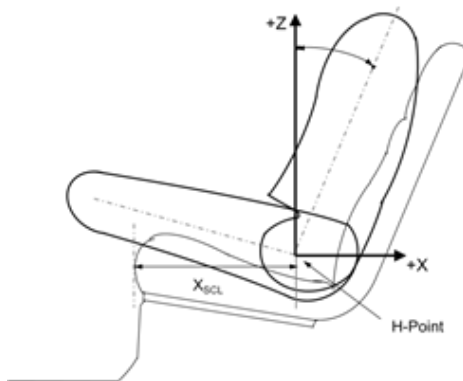

- {3.1. Head
- The transverse instrumentation platform of the head shall be horizontal within 2.5°. To level the head of the test dummy in vehicles with upright seats with non-adjustable backs, the following sequences must be followed. First adjust the position of the "H 5th" point within the limits set forth in paragraph 23.4.3.1. below to level the transverse instrumentation platform of the head of the test dummy. If the transverse instrumentation platform of the head is still not level, then adjust the pelvic angle of the test dummy within the limits provided in paragraph 23.4.3.2. below. If the transverse instrumentation platform of the head is still not level, then adjust the neck

bracket of the test dummy the minimum amount necessary to ensure that the transverse instrumentation platform of the head is horizontal within 2.5°.]”

Paragraphs 3.4.3. to 3.6.1., amend to read:

3.4.3. Lower torso

3.4.3.1. "H 5th" point

The "H 5th" point of passenger test dummy shall coincide within ~~[xx] mm in the vertical dimension and~~ 13 mm in the horizontal dimension with a point 6 mm below the position of the "H 5th" point determined using the procedure described in [Annex 6]. ~~except that the length of the lower leg and thigh segments of the "H" point machine shall be adjusted to 414 and 401 mm, instead of 417 and 432 mm respectively.~~

3.4.3.2. Pelvic angle

As determined using the pelvic angle gauge (GM) drawing 78051-532 ~~incorporated by reference in Part 572~~, as defined in the Mutual Resolution No. 1 which is inserted into the "H" point gauging hole of the dummy, the angle measured from the horizontal on the [76.2 mm (3 inch)] flat surface of the gauge shall be ~~22.5~~ 20 degrees plus or minus 2.5 degrees.

3.5. Legs

The upper legs of the passenger test dummy shall rest against the seat cushion to the extent permitted by placement of the feet. The initial distance between the outboard knee clevis flange surfaces shall be ~~[270 mm ± 10 mm]~~ **229 mm ± 5 mm** as shown in Figure 2. To the extent practicable, both legs of the passenger dummy shall be in vertical longitudinal planes. Final adjustment to accommodate placement of feet in accordance with paragraph 3.6. for various passenger compartment configurations is permitted.

Figure 2

The initial knee distance of Hybrid III 5th percentile female

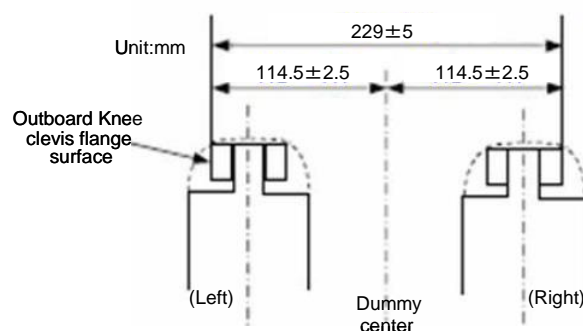

3.6. Feet

3.6.1. The heels of both feet of the passenger test dummy shall be placed as far forward as possible and shall rest on the floor pan. Both feet shall be positioned as flat as possible on the toe board. The longitudinal centreline of the feet shall be placed as parallel as possible to the longitudinal centreline of the vehicle.

The legs shall be positioned as far as possible from the front end of the rear seat cushion while the thighs are kept in contact with the seat cushion as shown in Fig.(a). As shown in Fig.(b), each leg shall be lowered until the foot comes in contact with the floor while the foot and tibia are kept at a right angle to one another and the thigh inclination angle kept constant. When each heel is in contact with the floor, the foot shall be rotated so that the toe comes into contact as much as possible with the floor as shown in Fig.(c).

If it is not possible to have each foot in contact with the floor, the foot shall be lowered until the calf comes in contact with the front end of the seat cushion or the back of the foot comes in contact with the vehicle interior. The foot shall be kept as parallel as possible to the floor as shown in Fig.(d).

In case of interference by a vehicle body protrusion, the foot shall be rotated as minimally as possible around the tibia. In case interference still remains, the femur shall be rotated to resolve or minimize the interference. The foot shall be moved inward or outward while the separation distance between the knees is kept constant.

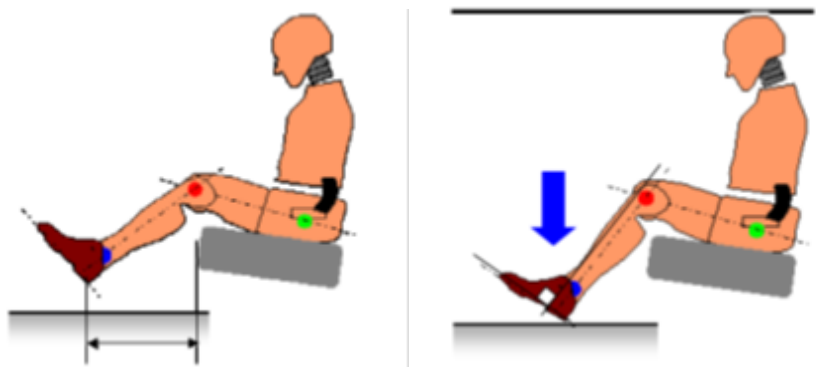

Fig.(a)

Fig. (b)

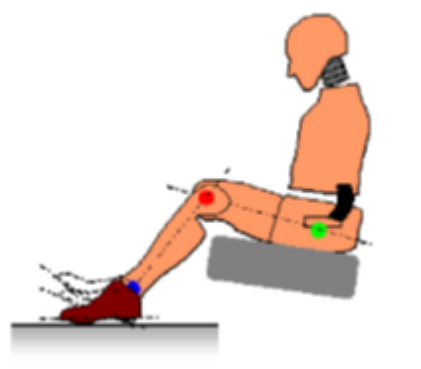

Fig. (c)

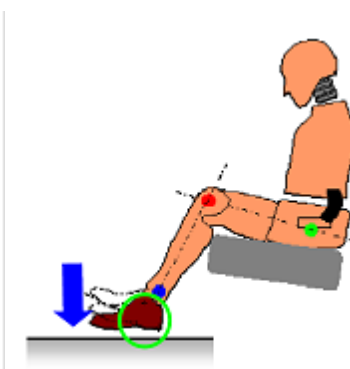

Fig. (d)"

Paragraphs 3.9. to 3.9.1., amend to read:

"3.9. ‡Dummy HYBRID III 5th clothing

- 3.9.1. The instrumented dummy will be clothed in formfitting cotton stretch garments with short sleeves and mid-calf length trousers ~~specified in FMVSS 208, drawings 78051-292 and 293 or their equivalent.~~
- 3.9.2. A size 7.5 W small female size shoe, which meets the configuration size, sole and heel thickness specifications of the US military standard MIL-S-21711E, revision P **and whose weight is 0.41 ± 0.09 kg**, shall be placed and fastened on each foot of the test dummies.}"

Paragraph 4., amend to read:

- "4. Adjustment of restraint system

The dummy jacket shall be installed at the appropriate position where the bolt hole of the neck lower bracket and the work hole of the dummy jacket should be at the same position. With the test dummy at its designated seating position, as specified by the appropriate requirements of paragraphs 2.1. to 2.6. and 3.1. to 3.6. above, place the belt around the test dummy and fasten the latch. Remove all slack from the lap belt. Pull the upper torso webbing out of the retractor horizontally at a position via the centre of the dummy and allow it to retract. Repeat this operation four times. **The shoulder belt should be at the position between the area which shall not be taken off of shoulder and shall not be in contact with the neck. The seat belt path shall be positioned: for the HYBRID III fiftieth percentile male dummy, the hole of the outer side dummy jacket shall not be fully hidden by the seat belt. For the HYBRID III fifth percentile female dummy, the seat belt shall lie between the breasts.** Apply a 9 to 18 N tension load to the lap belt. If the belt system is equipped with a tension-relieving device, introduce the maximum amount of slack into the upper torso belt that is recommended by the manufacturer for normal use in the owner's manual for the vehicle. If the belt system is not equipped with a tension-relieving device, allow the excess webbing in the shoulder belt to be retracted by the rewind force of the retractor. **Where the safety belt and safety belt anchorages are located such that the belt does not lie as required above, then the safety belt may be manually adjusted and retained by tape."**

II. Justification

During the last IWG FI meeting, the group agreed to introduce some amendments to the provisions on the position of the front passenger of the draft UN Regulation (ECE/TRANS/WP.29/GRSP/2014/10) on frontal impact.