

Submitted by the expert from the Netherlands  
(Chair of CMS-II) including amendments by the expert  
from France

Informal document **GRSG-108-46-Rev.2**  
(108<sup>th</sup> GRSG, 4-8 May 2015,  
agenda item 5)

## **Proposal for a draft Supplement to the 04 series of amendments to Regulation No. 46 (Devices for indirect vision)**

### **Submitted by the expert from the Netherlands**

The text reproduced below was prepared by the Informal Group on Camera-Monitor Systems (IGCMS-II) as a revised version of Regulation No. 46, to introduce the optional replacement of mirrors of Classes I to IV by camera-monitor systems. The modifications to the current text of Regulation No. 46 are marked in bold for new or as strikethrough for deleted characters.

## A. Proposal

### Regulation No. 46

#### Uniform provisions concerning the approval of devices for indirect vision and of motor vehicles with regard to the installation of these devices

#### Contents

	Page
1. Scope .....	5
I. Devices for indirect vision	
2. Definitions .....	5
3. Application for approval .....	8
4. Markings .....	8
5. Approval .....	8
6. Requirements .....	9
7. Modification of the type of device for indirect vision and extension of approval.....	19
8. Conformity of production .....	20
9. Penalties for non-conformity of production .....	20
10. Production definitively discontinued .....	20
11. Names and addresses of Technical Services responsible for conducting approval tests, and of Type Approval Authorities.....	20
II. Installation of devices for indirect vision	
12. Definitions .....	21
13. Application for approval .....	22
14. Approval .....	22
15. Requirements .....	22
16. <b>Requirements for devices for indirect vision other than mirrors</b> .....	49
167. Modifications of the vehicle type and extension of approval .....	39
178. Conformity of production .....	40
189. Penalties for non-conformity of production .....	40
1920. Production definitively discontinued .....	40
201. Names and addresses of Technical Services responsible for conducting approval tests, and of Type Approval Authorities .....	40
242. Transitional provisions .....	40

## Annexes

1	Information document for type approval of a device for indirect vision .....	43
2	Information document for type approval of vehicle with respect to the installation of devices for indirect vision .....	44
3	Communication concerning the approval or refusal or extension or withdrawal of approval or production definitively discontinued of a type of device for indirect vision, pursuant to Regulation No. 46 .....	46
4	Communication concerning the approval or refusal or extension or withdrawal of approval or production definitively discontinued of a type of vehicle with regard to the mounting of devices for indirect vision, pursuant to Regulation No. 46 .....	48
	Appendix .....	49
5	Arrangement of approval mark for a device for indirect vision .....	50
6	Test method for determining reflectivity .....	51
7	Procedure for determining the radius of curvature "r" of the reflecting surface of a mirror.....	57
8	Procedure for determining the "H" point and the actual torso angle for seating positions in motor vehicles .....	59
	Appendix 1 - Description of the three-dimensional "H" point machine (3-D H machine).....	59
	Appendix 2 - Three-dimensional reference system.....	59
	Appendix 3 - Reference data concerning seating positions .....	59
9	(Reserved) .....	60
10	Calculation of the detection distance .....	61
11	Determination of the displayed object size .....	64
12	<b>Test methods and safety provisions for CMS of Class I to IV .....</b>	<b>nn</b>

## 1. Scope

1.1 This Regulation applies:

- (a) To compulsory and optional devices for indirect vision, set out in the table under paragraph 15.2.1.1.1. of this Regulation for vehicles of category M and N<sup>1</sup> and to compulsory and optional devices for indirect vision mentioned in paragraphs 15.2.1.1.3. and 15.2.1.1.4. of this Regulation for vehicles of category L<sup>1</sup> with bodywork at least partly enclosing the driver;
- (b) To the installation of devices for indirect visions on vehicles of categories M and N and on vehicles of category L<sup>1</sup> with bodywork at least partly enclosing the driver.

1.2 This Regulation does not apply to devices other than those prescribed under paragraph 1.1 (a), and their installation, for observing the vision area(s) immediately adjacent to the front and/or the passenger's side of vehicles of category M<sub>1</sub>, M<sub>2</sub>, M<sub>3</sub>, N<sub>1</sub> and N<sub>2</sub> ≤ 7.5 t.

## I. Devices for indirect vision

### 2. Definitions

For the purposes of this Regulation:

- 2.1. "*Devices for indirect vision*" means devices ~~to observe the traffic area adjacent to the vehicle which cannot be observed by direct vision~~ **intended to give a clear view of the rear, side or front of the vehicle within the fields of vision defined in paragraph 15.2.4.** These can be conventional mirrors, camera-monitors or other devices able to present information about the indirect field of vision to the driver.
- 2.1.1. "*Mirror*" means any device, excluding devices such as periscopes, intended to give a clear view to the rear, side or front of the vehicle within the fields of vision defined in paragraph 15.2.4. **by means of a reflective surface of this Regulation.**
- 2.1.1.1. "*Interior mirror*" means a device as defined in paragraph 2.1.1. above, which can be fitted in the passenger compartment of a vehicle.
- 2.1.1.2. "*Exterior mirror*" means a device as defined in paragraph 2.1.1. above, which can be mounted on the external surface of a vehicle.
- 2.1.1.3. "*Surveillance mirror*" means a mirror other than the ones defined in paragraph 2.1.1. above which can be fitted to the inside or outside of the vehicle in order to provide fields of vision other than those specified in paragraph 15.2.4. of this Regulation.

---

<sup>1</sup> As defined in the Consolidated Resolution on the Construction of Vehicles (R.E.3.), document ECE/TRANS/WP.29/78/Rev.3, para. 2. - [www.unece.org/trans/main/wp29/wp29wgs/wp29gen/wp29resolutions.html](http://www.unece.org/trans/main/wp29/wp29wgs/wp29gen/wp29resolutions.html)

~~2.1.1.4. "Vision support system" means a system to enable the driver to detect and/or see objects in the area adjacent to the vehicle.~~

2.1.1.4. "r" means the average of the radii of curvature measured over the reflecting surface, in accordance with the method described in Annex 7.

2.1.1.5. "The principal radii of curvature at one point on the reflecting surface ( $r_i$ )" means the values obtained with the apparatus defined in Annex 7, measured on the arc of the reflecting surface passing through the centre of this surface parallel to the segment b, as defined in paragraph 6.1.2.1.2.1. of this Regulation and on the arc perpendicular to this segment.

2.1.1.6. "The radius of curvature at one point on the reflecting surface ( $r_p$ )" means the arithmetical average of the principal radii of curvature  $r_i$  and  $r_i'$  i.e.:

$$r_p = \frac{r_i + r_i'}{2}$$

2.1.1.7. "Spherical surface" means a surface, which has a constant and equal radius in all directions

2.1.1.8. "Aspherical surface" means a surface, which has only in one plane a constant radius.

2.1.1.9. "Aspherical mirror" means a mirror composed of a spherical and an aspherical part, in which the transition of the reflecting surface from the spherical to the aspherical part has to be marked. The curvature of the main axis of the mirror is defined in the x/y coordinate system defined by the radius of the spherical primary calotte with:

$$y = R - \sqrt{(R^2 - x^2) + k(x - a)^3}$$

Where:

R: nominal radius in the spherical part

k: constant for the change of curvature

a: constant for the spherical size of the spherical primary calotte

2.1.1.10. "Centre of the reflecting surface" means the centre of the visible area of the reflecting surface.

2.1.1.11. "The radius of curvature of the constituent parts of the mirror" means the radius "c" of the arc of the circle which most closely approximates to the curved form of the part in question.

~~2.1.1.13. "Class of mirror" means all devices having one or more common characteristics or functions. They are classified as follows:~~

~~(a) Class I: "Interior rear view mirror", giving the field of vision defined in paragraph 15.2.4.1. of this Regulation;~~

~~(b) Classes II and III: "Main exterior rear view mirror", giving the fields of vision defined in paragraphs 15.2.4.2. and 15.2.4.3. of this Regulation;~~

~~(c) Class IV: "Wide angle exterior mirror", giving the field of vision defined in paragraph 15.2.4.4. of this Regulation;~~

- (d) ~~Class V: "Close proximity exterior mirror", giving the field of vision defined in paragraph 15.2.4.5. of this Regulation;~~
- (e) ~~Class VI: "Front mirror", giving the field of vision defined in paragraph 15.2.4.6. of this Regulation;~~
- (f) ~~Class VII: Mirrors intended for L category vehicles with bodywork, giving the field of vision defined in paragraph 15.2.4.7. of this Regulation.~~
- 2.1.2. "Camera-monitor ~~device system (CMS) for indirect vision~~" means a device **for indirect vision** as defined in paragraph 2.1., where the field of vision is obtained by means of a camera-monitor combination as defined in paragraphs 2.1.2.1. and 2.1.2.2. below.
- 2.1.2.1. "Camera" means a device that renders an image of the outside world and then converts this image into a signal (e.g. video signal).
- 2.1.2.2. "Monitor" means a device that converts a signal into images that are rendered into the visual spectrum.
- 2.1.2.3. ~~"Detection" means the ability to distinguish an object from its background/surroundings at certain distance.~~
- 2.1.2.10. ~~(Reserved)~~
- 2.1.2.11. ~~(Reserved)~~
- 2.1.3. "Other devices for indirect vision" means devices as defined in paragraph 2.1. above, where the field of vision is not obtained by means of a mirror or a camera-monitor ~~type device for indirect vision.~~
- 2.1.4. "Vision support system" means a system to enable the driver to detect and/or see objects in the area adjacent to the vehicle.
- 2.1.5. "Luminance contrast" means the brightness ratio between an object and its immediate background/surrounding that allows the object to be distinguished from its background/surroundings. **The definition is in accordance with the definition given in ISO 9241-302:2008.**
- 2.1.6. "Resolution" means the smallest detail that can be discerned with a perceptual system, i.e. perceived as separate from the larger whole. The resolution of the human eye is indicated as "visual acuity".
- 2.1.7. "Critical object" means a cylindrical object with a height of 0.50 m and a diameter of 0.30 m.
- 2.1.8. "Critical perception" means the level of perception that can just be obtained under critical conditions via the viewing system used. This corresponds to the situation in which the representative scale of the critical object is multiple times larger than the smallest detail that can be perceived via the viewing system.
- 2.1.9. "Field of vision" means the section of the tri-dimensional space which is monitored with the help of a device for indirect vision. Unless otherwise stated, this is based on the view on ground level offered by a device and/or devices other than mirrors. This may be limited by the relevant detection distance corresponding to the critical object.

- 2.1.10. "*Detection distance*" means the distance measured from the centre of the lens of the camera to the point at which a critical object can just be perceived (as defined by the critical perception).
- 2.1.11. "*Visual spectrum*" means light with a wavelength within the range of the perceptual limits of the human eyes: 380-780 nm.
- 2.1.12. "*Smear*" is a ~~vertical bright bar~~ **line** displayed on the monitor while sun light or light from other bright light sources is directly hitting into the lens of the camera. ~~Smear is an optical artefact.~~
- 2.1.13. **"Mirror and CMS dual function system" means a CMS of Class I in which a monitor complying with this regulation is placed behind a semi-transparent mirror complying with this regulation. The monitor is visible in the CMS mode.**
- 2.2. "*Type of device for indirect vision*" means devices that do not differ on the following essential characteristics:
- Design of the device inclusive, if pertinent, the attachment to the bodywork;
  - In case of mirrors the class, the shape, the dimensions and radius of curvature of the mirror's reflecting surface;
  - In case of camera-monitor ~~systems~~**devices, the class, the field of view, the magnification and resolution** ~~the detection distance and the range of vision.~~
- 2.3. "*Surveillance camera-monitor-recording device*" means a camera and either a monitor or recording equipment other than the camera-monitor ~~system device~~ defined in paragraph 2.1.2. above which can be fitted to the inside or outside of the vehicle in order to provide fields of vision other than those specified in paragraph 15.2.4. of this Regulation or to provide a security system within or around the vehicle.
- 2.4. "*Class of ~~mirror~~ device for indirect vision*" means all devices having one or more common characteristics or functions. They are classified as follows:
- 2.4.1. Class I: "~~Interior~~ **Rear-view mirror device**", giving the field of vision defined in paragraph 15.2.4.1.
- 2.4.2. Class II and III: "~~Main exterior~~ **rear-view device mirror**", giving the fields of vision defined in paragraphs 15.2.4.2. and 15.2.4.3.
- 2.4.3. Class IV: "**Wide-angle view device** ~~exterior mirror~~", giving the field of vision defined in paragraph 15.2.4.4.
- 2.4.4. Class V: "**Close-proximity view device** ~~exterior mirror~~", giving the field of vision defined in paragraph 15.2.4.5.
- 2.4.5. Class VI: "**Front-view device** ~~mirror~~", giving the field of vision defined in paragraph 15.2.4.6.
- 2.4.6. Class VII: **Main rear-view** ~~M~~mirrors intended for L category vehicles with bodywork **giving the field of vision defined in paragraph 15.2.4.7.**
- 2.5. "*Point light source detection factor - PLSDF*" means the level of distinctness of a pair of point light sources, based on luminance intensities and horizontal and vertical dimension of the rendition on the monitor.

- 2.6. **"Point light source contrast factor - PLSCF"** means the level of distinctness of a pair of point light sources, based on luminance differences between the maximum luminance of the luminance profile  $L_{H,max}$  and the minimum luminance of the luminance profile  $L_{H,min}$  in the horizontal direction (see Figure 3 of Annex 12).

### 3. Application for approval

- 3.1. The application for approval of a type of device for indirect vision shall be submitted by the holder of the trade name or mark or by his duly accredited representative.
- 3.2. A model of information document is shown in Annex 1.
- 3.3. For each type of device for indirect vision the application shall be accompanied by **three samples of the parts**.
- ~~3.3.1. In case of mirrors, four samples: three for use in the tests and one to be retained by the laboratory for any further examination that might subsequently prove necessary. Additional specimens may be called for at the request of the laboratory;~~
- ~~3.3.2. In case of other devices for indirect vision: one sample of all the parts.~~
- 3.4. **The CMS shall be provided by the applicant with the following documents:**
- (a) **Technical specification of the CMS; and**
  - (b) **Operator's manual.**

### 4. Markings

- 4.1. The samples of devices for indirect vision submitted for approval shall bear the trade name or mark of the manufacturer; this marking shall be clearly legible and be indelible.
- 4.2. Every device **for indirect vision** shall possess, **on at least one of the main components** a space large enough to accommodate the approval mark, which shall be legible ~~when the device has been mounted on the vehicle~~; this space shall be shown on the drawings referred to in Annex 1. **The approval mark shall also be legible when the device is mounted on the vehicle with exception of camera-monitor devices as defined in paragraph 2.1.2. Other components of the device shall bear a means of identification. In case of limited space for the approval mark(s), other means of identification that link it to the approval mark shall be provided.**

### 5. Approval

- 5.1. If the samples submitted for approval meet the requirements of paragraph 6. of this Regulation, approval of the pertinent type of device for indirect vision shall be granted.
- 5.2. An approval number shall be assigned to each type-approved. Its first two digits (at present 04) shall indicate the series of amendments incorporating the most recent major technical amendments made to the Regulation at the



time of issue of the approval. The same Contracting Party shall not assign the same number to another type of device for indirect vision.

- 5.3. Notice of approval or of refusal or of extension or withdrawal of approval or of production definitively discontinued of a type of device for indirect vision pursuant to this Regulation shall be communicated to the Parties to the Agreement which apply this Regulation by means of a form conforming to the model in Annex 3 to this Regulation.
- 5.4. There shall be affixed, **on at least one of the main components**, conspicuously and in the space referred to in paragraph 4.2. above, to every device for indirect vision, conforming to a type-approved under this Regulation, in addition to the mark prescribed in paragraph 4.1. above, an international approval mark consisting of:
- 5.4.1. A circle surrounding the letter "E" followed by the distinguishing number of the country which has granted approval<sup>2</sup>;
- 5.4.2. An approval number;
- 5.4.3. ~~An~~ **Additional** symbol(s) I or II or **and** III or **and** IV or **and** V or **and** VI or **and** VII, specifying the class to which the type of ~~mirror~~ device for indirect vision belongs ~~or the symbol S in case of any device for indirect vision other than a mirror~~. The additional symbol shall be placed in any convenient position in the vicinity of the circle containing the letter "E".
- 5.5. The approval mark and the additional symbol(s) shall be clearly legible and be indelible.
- 5.6. Annex 5 to this Regulation gives an example of the arrangement of the aforesaid approval mark and additional symbol.

## 6. Requirements

- 6.1. Mirrors
- 6.1.1. General specifications
- 6.1.1.1. All mirrors shall be adjustable.
- 6.1.1.2. (a) ~~Exterior rear~~**Rear**-view mirrors (Classes II to VII)

The edge of the reflecting surface shall be enclosed in a protective housing (holder, etc.) which, on its perimeter, shall have a value "c" greater than or equal to 2.5 mm at all points and in all directions. If the reflecting surface projects beyond the protective housing, the radius of curvature "c" on the edge of the projecting part shall be not less than 2.5 mm and the reflecting surface shall return into the protective housing under a force of 50 N applied to the point of greatest projection, relative to the protective housing, in a horizontal direction, approximately parallel to the longitudinal median plane of the vehicle.

<sup>2</sup> The distinguishing numbers of the Contracting Parties to the 1958 Agreement are reproduced in Annex 3 to the Consolidated Resolution on the Construction of Vehicles (R.E.3), document ECE/TRANS/WP.29/78/Rev.2/Amend.3 - [www.unece.org/trans/main/wp29/wp29wgs/wp29gen/wp29resolutions.html](http://www.unece.org/trans/main/wp29/wp29wgs/wp29gen/wp29resolutions.html)

(b) ~~Interior-rear~~Rear-view mirrors (Class I)

In cases, where the edge of the reflecting surface is enclosed in a protective housing (holder, etc.), the radius of curvature "c" on its perimeter shall be not less than 2.5 mm at all points and in all directions. In cases, where the edge of the reflecting surface projects beyond the protective housing, this requirement shall apply to the edge of the projecting part.

- 6.1.1.3. When the mirror is mounted on a plane surface, all parts, irrespective of the adjustment position of the device, including those parts remaining attached to the support after the test provided for in paragraph ~~6.1.3.26.3.2.~~ below, which are in potential, static contact with a sphere either 165 mm in diameter in the case of an ~~interior~~ **Class I** mirror or 100 mm in diameter in the case of an ~~exterior~~ **Class II to VII** mirror, shall have a radius of curvature 'c' of not less than 2.5 mm.
- 6.1.1.4. The requirements in paragraphs 6.1.1.2. and 6.1.1.3. above shall not apply to parts of the external surface which protrude less than 5 mm, but the outward facing angles of such parts shall be blunted, save where such parts protrude less than 1.5 mm. For determining the dimension of the projection, the following method shall apply:
- 6.1.1.4.1. The dimension of the projection of a component which is mounted on a convex surface may be determined either directly or by reference to a drawing of an appropriate section of this component in its installed condition.
- 6.1.1.4.2. If the dimension of the projection of a component which is mounted on a surface other than convex cannot be determined by simple measurement, it shall be determined by the maximum variation of the distance of the centre of a 100 mm diameter sphere from the nominal line of the panel when the sphere is moved over and is in constant contact with that component. Figure 1 shows an example of the use of this procedure.

Figure 1

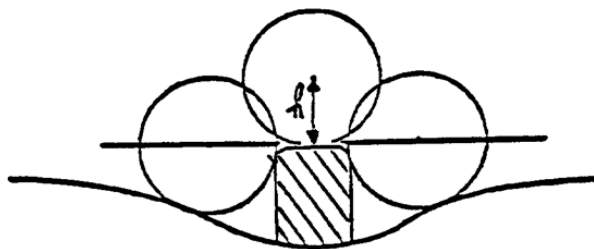
**Example for the measurement by maximum variation**

- 6.1.1.5. Edges of fixing holes or recesses of which the diameter or longest diagonal is less than 12 mm are exempt from the radius requirements of paragraph 6.1.1.3. above provided that they are blunted.
- 6.1.1.6. The device for the attachment of mirrors to the vehicle shall be so designed that a cylinder with a 70 mm radius (50 mm in the case of an L-category vehicle), having as its axis the axis, or one of the axes, of pivot or rotation which ensures deflection of the mirror in the direction of impact concerned, passes through at least part of the surface to which the device is attached.

- 6.1.1.7. The parts of **Class II to VII exterior** mirrors referred to in paragraphs 6.1.1.2. and 6.1.1.3. above which are made of a material with a Shore A hardness not exceeding 60 are exempt from the relevant provisions.
- 6.1.1.8. In the case of those parts of **Class I interior** mirrors which are made of a material with a Shore A hardness of less than 50 and which are mounted on a rigid support, the requirements of paragraphs 6.1.1.2. and 6.1.1.3. above shall only apply to the support.

6.1.2. Special specifications

6.1.2.1. Dimensions

6.1.2.1.1. ~~Interior~~ Rear-view mirrors (Class I)

The dimensions of the reflecting surface shall be such that it is possible to inscribe thereon a rectangle one side of which is 40 mm and the other 'a' mm in length, where

$$a = 150 \times \frac{1}{1 + \frac{1000}{r}} \text{ mm}$$

and "r" is the radius of curvature.

6.1.2.1.2. Main ~~exterior~~ rear-view mirrors (Classes II and III)

6.1.2.1.2.1. The dimensions of the reflecting surface shall be such that it is possible to inscribe therein:

- A rectangle 40 mm high the base length of which, measured in millimetres, has the value "a";
- A segment which is parallel to the height of the rectangle and the length of which, expressed in millimetres, has the value "b".

6.1.2.1.2.2. The minimum values of "a" and "b" are given in the table below:

<i>Class of rear-view mirror</i>	<i>a (mm)</i>	<i>b (mm)</i>
II	$\frac{170}{1 + \frac{1000}{r}}$	200
III	$\frac{130}{1 + \frac{1000}{r}}$	70

6.1.2.1.3. "Wide-angle" ~~view exterior~~ mirrors (Class IV)

The contours of the reflecting surface shall be of simple geometric form and its dimensions such that it provides, if necessary in conjunction with a Class II exterior mirror, the field of vision specified in paragraph 15.2.4.4. of this Regulation.

6.1.2.1.4. "Close-proximity" ~~view exterior~~ mirrors (Class V)

The contours of the reflecting surface shall be of simple geometric form and its dimensions such that the mirror provides the field of vision specified in paragraph 15.2.4.5. of this Regulation.

- 6.1.2.1.5. **Front-view mirrors (Class VI)**  
The contours of the reflecting surface shall be of simple geometric form and its dimensions such that the mirror provides the field of vision specified in paragraph 15.2.4.6. of this Regulation.
- 6.1.2.1.6. **Mirrors for category L vehicles with bodywork (Class VII)**
- 6.1.2.1.6.1. **"Main" rear view ~~exterior~~ mirrors (Class VII)**  
The minimum dimensions of the reflecting surface shall be such that:
- (a) Its area shall not be less than 6,900 mm<sup>2</sup>;
  - (b) The diameter of circular mirrors shall not be less than 94 mm;
  - (c) Where rear view mirrors are not circular, their dimensions shall enable a 78 mm-diameter circle to be prescribed on their reflecting surface.
- The maximum dimensions of the reflecting surface shall be such that:
- (a) The diameter of any circular rear view mirror shall not be greater than 150 mm;
  - (b) The reflecting surface of any non-circular rear view mirror shall lie within a rectangle measuring 120 mm x 200 mm.
- 6.1.2.2. **Reflecting surface and coefficients of reflection**
- 6.1.2.2.1. The reflecting surface of a mirror shall be either flat or spherically convex. Exterior mirrors may be equipped with an additional aspherical part provided that the main mirror fulfils the requirements of the indirect field of vision.
- 6.1.2.2.2. **Differences between the radii of curvature of mirrors**
- 6.1.2.2.2.1. The difference between  $r_i$  or  $r'_i$ , and  $r_p$  at each reference point shall not exceed 0.15 r.
- 6.1.2.2.2.2. The difference between any of the radii of curvature ( $r_{p1}$ ,  $r_{p2}$ , and  $r_{p3}$ ) and r shall not exceed 0.15 r.
- 6.1.2.2.2.3. When r is not less than 3,000 mm, the value of 0.15 r quoted in paragraphs 6.1.2.2.2.1. and 6.1.2.2.2.2. above is replaced by 0.25 r.
- 6.1.2.2.3. **Requirements for aspherical parts of mirrors**
- 6.1.2.2.3.1. Aspherical mirrors shall be of sufficient size and shape to provide useful information to the driver. This normally means a minimum width of 30 mm at some point.
- 6.1.2.2.3.2. The radius of curvature  $r_i$  of the aspherical part shall not be less than 150 mm.
- 6.1.2.2.4. **Value of "r" for spherical mirrors shall not be less than:**
- 6.1.2.2.4.1. 1,200 mm for ~~interior~~ rear-view mirrors (Class I);
  - 6.1.2.2.4.2. 1,200 mm for Class II and III main ~~exterior~~ rear-view mirrors;
  - 6.1.2.2.4.3. 300 mm for "wide-angle" ~~exterior~~ mirrors (Class IV) and "close-proximity" ~~exterior~~ mirrors (Class V);
  - 6.1.2.2.4.4. 200 mm for front mirrors (Class VI).
  - 6.1.2.2.4.5. 1,000 mm or more than 1,500 mm ~~in the case of~~ for Class VII **main rear-view** mirrors.

- 6.1.2.2.5. The value of the normal coefficient of reflection, as determined according to the method described in Annex 6, shall be not less than 40 per cent.
- In the case of reflecting surfaces with a changeable degree of reflection, the "day" position shall allow the colours of the signals used for road traffic to be recognized. The value of the normal coefficient of reflection in the "night" position shall be not less than 4 per cent.
- 6.1.2.2.6. The reflecting surface shall retain the characteristics laid down in paragraph 6.1.2.2.5. above in spite of prolonged exposure to adverse weather conditions in normal use.
- 6.2. Devices for indirect vision other than mirrors
- 6.2.1. General requirements
- 6.2.1.1. If adjustment by the user is needed, the device for indirect vision shall be adjustable without the use of tools.
- 6.2.1.2. If a device for indirect vision can only render the total prescribed field of vision by scanning the field of vision, the total process of scanning, rendering and reset to its initial position together shall not take more than 2 seconds.
- 6.2.1.3. The effectiveness of the CMS of Classes I to IV shall not be adversely affected by magnetic or electrical fields. This shall be demonstrated by compliance with the technical requirements and transitional provisions of Regulation No. 10, 04 series of amendments or any later series of amendments.**
- 6.2.2. ~~Camera-monitor systems devices for indirect vision~~
- The requirements of paragraph 6.2.2.1. shall be considered to be satisfied in the case of monitors of a vehicle that fulfills the provisions of Regulation No. 21.**
- 6.2.2.1. General requirements
- 6.2.2.1.1. ~~When the devices of the camera-monitor device system for indirect vision is are mounted on a plane surface in the position recommended by the manufacturer for normal driving,~~ all parts, irrespective of the adjustment position of the device which are in potential, static contact with a sphere either 165 mm in diameter in the case of a **CMS or parts of CMS installed inside the vehicle monitor** or 100 mm in diameter in the case of a **CMS or parts of CMS installed outside the vehicle camera**, shall have a radius of curvature "c" of not less than 2.5 mm.
- 6.2.2.1.2. Edges of fixing holes or recesses of which the diameter or longest diagonal is less than 12 mm are exempt from the radius requirements of paragraph 6.2.2.1.1. above provided that they are blunted.
- 6.2.2.1.3. For parts of the camera and the monitor which are made of a material with a Shore A hardness of less than 60 and which are mounted on a rigid support, the requirements of paragraph 6.2.2.1.1. above shall only apply to the support.
- 6.2.2.2. Functional requirements **for camera-monitor devices of Classes V and VI**
- 6.2.2.2.1. The camera shall function well in conditions in which sunlight falls on the camera. The saturated area, defined as the area in which the luminance contrast ratio ( $C=L_w/L_b$ ) of a high contrast pattern falls below 2.0, shall not

cover more than 15 per cent of the displayed image under the conditions of paragraphs 6.2.2.2.1.1. to 6.2.2.2.1.4. below.

In case the camera system shows dynamical changes in the blooming area during the test the maximum blooming area should fulfill the requirement.

- 6.2.2.2.1.1. A black and white test pattern, having a minimum contrast ratio of 20 shall be positioned in front of the camera.

The test pattern shall be evenly illuminated at an illumination of  $3,000 \pm 300$  Lx.

The test pattern shall be medium gray on average and cover the complete area viewed by the camera; the camera shall view no other objects than the test pattern.

- 6.2.2.2.1.2. The camera shall be hit by a (simulated sun) light of 40 kLx, spanning an angle between 0.6 and 0.9 degrees with an elevation angle of 10 degrees (directly or indirectly via a mirror) removed from the optical axis of the sensor.

The light source shall:

- (a) Have a spectrum D65 with a tolerance of  $\pm 1,500$  K;
- (b) Be homogeneous in space and time within a tolerance of 2 kLx.

The emission of the light source in infrared shall be negligible.

- 6.2.2.2.1.3. There shall be no ambient illumination of the monitor during the test.

- 6.2.2.2.1.4. An example of the set-up is given in the Figure A below.

Figure A  
Diagram of the blooming measurement set-up

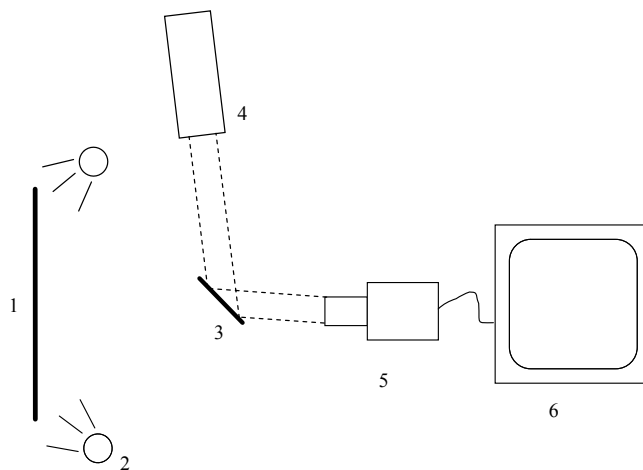

- 1: Black and white test pattern.
- 2: Lamps to make the test pattern evenly illuminated.
- 3: Mirror.
- 4: High intensity light.
- 5: Camera.
- 6: Monitor.

- 6.2.2.2.2. The monitor shall render a minimum contrast under various light conditions as specified by ISO 15008:2003.
- 6.2.2.2.3. It shall be possible to adjust the average luminance of the monitor either manually or automatically to the ambient conditions.
- 6.2.2.2.4. The measurements for the luminance contrast of the monitor shall be carried out according to ISO 15008:2009.
- 6.2.2.3. Functional requirements for camera-monitor devices of Classes I to IV (see Annex 12).

Unless otherwise specified in this Regulation, the definitions and symbols used in paragraph 6.2.2.3. are in accordance with ISO 16505:2015, Chapters 3 and 4.

Unless otherwise specified in this Regulation, the requirements given in paragraph 6.2.2.3. shall be verified according to the test procedures given in ISO 16505:2015, Chapter 7, where available.

6.2.2.3.1. Luminance adjustment

It shall be possible to adjust the average luminance of the monitor either manually or automatically to the ambient conditions.

6.2.2.3.2. Operating readiness (System availability)

If the system is not operational (e.g. CMS failure), it shall be indicated to the driver by i.e. warning indication, display information, absence of status indicator. The operator's manual shall explain the information indicated.

6.2.2.3.3. Image quality

6.2.2.3.3.1. Monitor isotropy

The monitor shall conform to optical requirements over the range of viewing directions that is specified in the following paragraphs.

6.2.2.3.3.1.1. Directional uniformity

When driven by an artificial 70 per cent grey-scale image, the deviation of the monitor luminance from the luminance white level with specific viewing direction  $(\Theta, \phi) = (\Theta_{\text{monitor}/D}, \phi_{\text{monitor}/D})$  shall be such that the ratio relative to the luminance white level for the same specific viewing direction  $L(\Theta_{\text{monitor}/D}, \phi_{\text{monitor}/D})$  does not exceed 35 per cent of the luminance white level for the monitor standard isotropy range and shall not exceed 50 per cent of the luminance white level for the monitor extended isotropy range.

For the standard isotropy range:

$$\frac{\max\{L_i - L(\Theta_{\text{monitor}/D}, \Phi_{\text{monitor}/D})\}}{L(\Theta_{\text{monitor}/D}, \Phi_{\text{monitor}/D})} < 35\%,$$

for points  $i = 1, 2, 3, 4, 5, 6, 7, 8, 9$  as defined in table below.

Table: Measurement directions for standard isotropy range

Direction i	horizontal/ degree	vertical/ degree
1	-7	+6

2	0	+6
3	+7	+6
4	-7	0
5	N/A	N/A
6	+7	0
7	-7	-6
8	0	-6
9	+7	-6

For the extended isotropy range:

$$\frac{\max\{L_{i'} - L(\Theta_{\text{monitor}/D}, \Phi_{\text{monitor}/D})\}}{L(\Theta_{\text{monitor}/D}, \Phi_{\text{monitor}/D})} < 50\%,$$

for points  $i' = 1, 2, 3, 4, 5, 6, 7, 8, 9$  as defined in table below.

Table: Measurement directions for extended isotropy range

Direction $i'$	horizontal/ degree	vertical/ degree
1	-12	+11
2	0	+11
3	+12	+11
4	-12	0
5	N/A	N/A
6	+12	0
7	-12	-11
8	0	-11
9	+12	-11

#### 6.2.2.3.3.1.2. Lateral uniformity

The luminance white lateral dependency shall satisfy:

$$\frac{\max\{L_{j/white}(\Theta, \Phi)\} - \min\{L_{j/white}(\Theta, \Phi)\}}{\max\{L_{j/white}(\Theta, \Phi)\}} < 35\%,$$

for points  $j = 1, 2, 3, 4, 5, 6, 7, 8, 9$  as defined in table below, where  $(\Theta, \phi) = (0, 0)$ .

Table: Measurement points for the lateral uniformity

Point $j$	Percentage of $W_{\text{monitor}/horizontal}$ from top left corner	Percentage of $H_{\text{monitor}/horizontal}$ from top left corner
1	20	20
2	50	20
3	80	20
4	20	50
5	50	50
6	80	50
7	20	80
8	50	80
9	80	80

#### 6.2.2.3.3.2. Luminance and contrast rendering



For luminance and contrast rendering the following requirements apply:

- (a) The minimum luminance contrast at the monitor (including any screen protector) reproducing a high contrast pattern shall be:
  - (i) for direct sunlight condition: 2:1
  - (ii) for day condition with diffuse ambient light: 3:1
  - (iii) for sunset condition: 2:1
  - (iv) for night condition: 10:1 **except in case of Mirror and CMS dual function system of class I: 5:1**
- (b) The night condition for the camera's field of view is replicated in a dark environment such that the maximum illuminance on the objects to be measured shall not exceed 2.0 lx,
- (c) The background luminance of the monitor shall be limited under the night condition. The maximum background luminance under the night condition shall be less than 2.0 cd/m<sup>2</sup>,
- (d) The instructions for use shall contain a note that sunlight or light from other intense light source upon the monitor reduces the luminance contrast which may require the driver to be particularly alert and attentive.

#### 6.2.2.3.3.2.1. Day condition with diffuse sky-light exposure test

For the day condition with diffuse sky-light exposure, the test method given in ISO 16505:2015, subclause 7.8.2., Test 2 shall be applied, but a value of 4,000 to 4,200 cd/m<sup>2</sup> for luminance diffuse illuminator shall be used.

**At the request of the manufacturer, the value for luminance diffuse illuminator may be determined by using the diagram of figure below.**

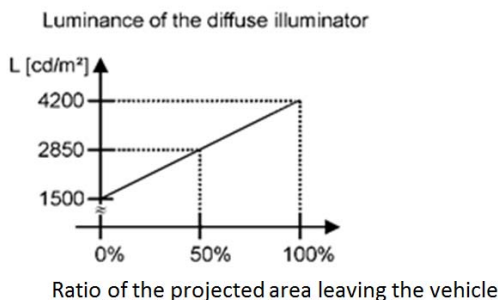

#### **Ratio of projected area vs. luminance of the diffuse illuminator**

**Procedure for determining the ration of the projected area leaving the vehicle:**

- (a) Determine the projected area in the vehicle that represents the mirror reflected direction from the monitor extended isotropy range.
- (b) Evaluation shall be made in the centre of the monitor defined size, under consideration of the monitor design viewing direction (see figure below).

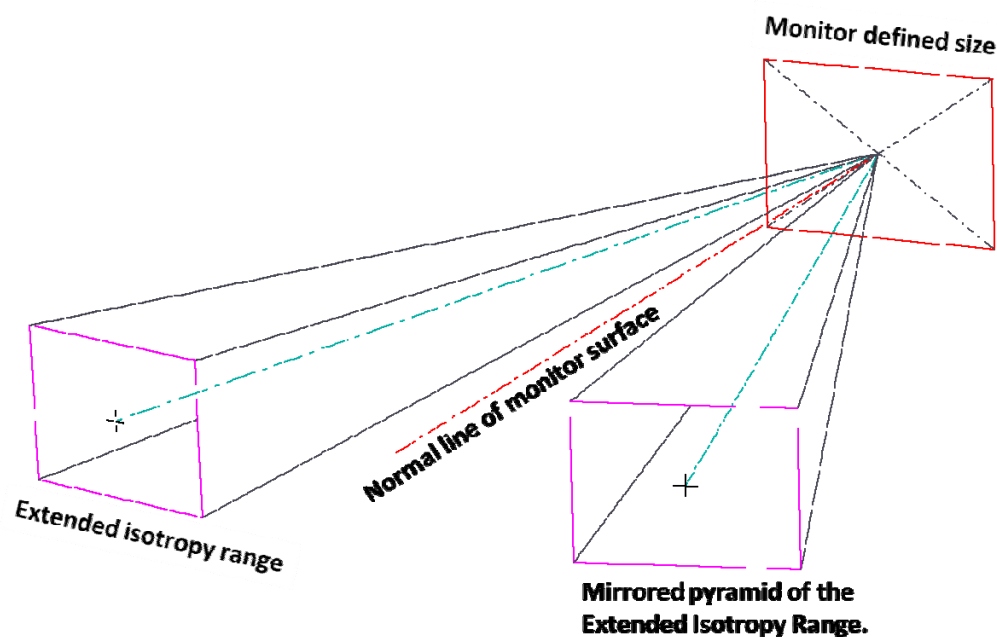

This projected area represents the 100 per cent of the surface to be considered.

Based on virtual testing, evaluate the ratio of the projected area that leaves the vehicle openings (e.g. through a side door window, rear window or sunroof; however, for example a sunroof having an opaque shutter shall not be considered an opening).

**Case when the orientation of the Mirror and CMS dual function system of class I is adjustable:**

**Based on virtual testing, if the applicant demonstrates that the Mirror and CMS dual function system of class I adjustment range permits a driver to avoid any incident specular light from the vehicle opening while a driver's eye is within any fixed position of the standard isotropy range, then the value for luminance diffuse illuminator shall be the one of ISO 16505:2015 subclause 7.8.2., Test 2: 1,300 to 1,500 cd/m<sup>2</sup>.**

#### 6.2.2.3.3.3. Grey scale rendering

A CMS shall have a sufficient grey scale rendering. CMS shall display a tonal range of at least eight distinguishable different grey tonal steps on the monitor.

For the grey scale rendering, the test method of paragraph 1.4. of Annex 12 shall be applied.

#### 6.2.2.3.3.4. Colour rendering

For colour rendering, the hue angle of reproduced colour of the chart patches on the monitor shall satisfy the following requirements. The colour coordinates are described based in the CIE 1976 uniform colour space:

- Red colour coordinates shall not exceed the range of (0°, 44.8°) or (332.2°, 360°)
- Green colour coordinates shall not exceed the range of (96.6°, 179.9°)
- Blue colour coordinates shall not exceed the range of (209.9°, 302.2°)
- Yellow colour coordinates shall not exceed the range of (44.8°, 96.6°)
- To distinguish from the white colour, define distance from white as  $R_i \geq 0.02$ , where  $R_i$  is the chromatic distance of each colour patch ( $i = \text{Red, Green, Blue, Yellow}$ ), relative to white ( $i = \text{White}$ ).

Figure B shows an illustrative tolerance range described on CIE 1976 uniform colour space.

Figure B

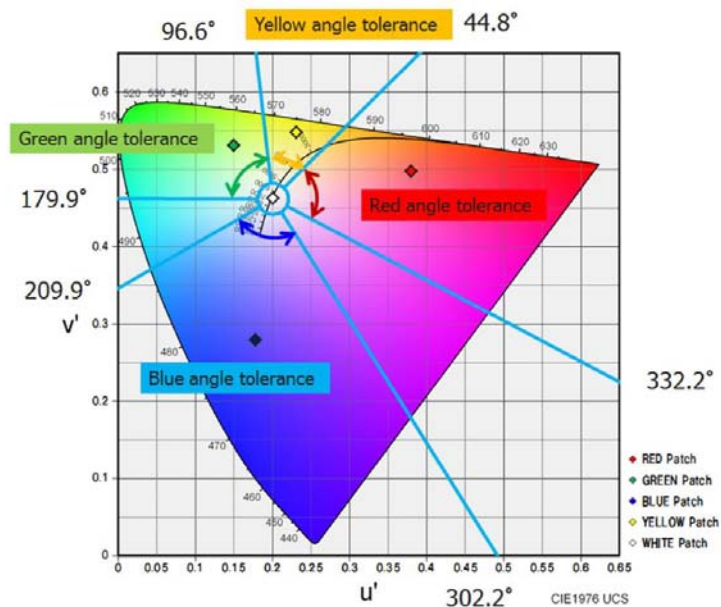

Amber, blue and red light signals shall be distinguishable from each other.

#### 6.2.2.3.3.5. Artefacts

The operator's manual shall refer to possible artefacts and their impact on the partial occlusion of the field of view and of the objects which may require the driver to be particularly alert and attentive.

##### 6.2.2.3.3.5.1. Smear

Smear shall be transparent and not be more than 10 per cent of the maximum luminance value of the displayed glare source luminance level, which causes smear effect.

#### 6.2.2.3.3.5.2. Blooming and lens flare

The total area of disturbing blooming and lens flare areas shall not cover more than 25 per cent of the displayed camera image.

#### 6.2.2.3.3.5.3. Point light sources

The CMS shall have an operation mode in which the driver of the vehicle equipped with CMS can recognize two point light sources (e.g. passing beam headlights) rendered as two distinguishable separate point light sources.

In this operation mode, a set of two point light sources corresponding to a vehicle passing beam headlamp each having a reference luminous intensity 1,750 cd and being separated each other laterally by 1.3 m and located at a distance of 250 m away from the CMS shall be distinguishable as two point light source. This requirement is applicable to Class I, Class II and Class III devices for indirect vision.

The point light source detection factor (PLSDF) shall be at least 2.7 or the point light source contrast factor (PLSCF) shall be at least 0.12, whichever is satisfied by the CMS test under the conditions and the test procedure described in Annex 12, paragraph 1.3.

If the system is in a mode where point light sources are not rendered as described above, this shall be indicated to the driver. The information indicated shall be explained in the operator's manual.

#### 6.2.2.3.3.6. Sharpness and depth of field

##### 6.2.2.3.3.6.1. Sharpness

The sharpness is represented by the  $MTF50_{(1:1)}$  and it shall satisfy:

- (a) Horizontal and vertical  $MTF50_{(1:1)}$  at center

$$MTF50_{(1:1)} \geq \frac{1}{2} MTF10_{MIN(1:1)} \langle LW / PH \rangle$$

- (b) Horizontal and vertical  $MTF50_{(1:1)}$  at corners (70 per cent of image height)

$$MTF50_{(1:1)} \geq \frac{1}{2} \cdot \frac{1}{2} (MTF10_{MIN(1:1)}) \langle LW / PH \rangle$$

##### 6.2.2.3.3.6.2. Depth of field

The CMS shall enable the driver to observe the occupied space by the object and perceive the content shown within the range of interest with detailed resolution. The  $MTF10_{(1:1)}$ , when measured at different distances to the object, shall satisfy at least the minimum resolution for the following points:

- (a) Resolution at point 1 (10 m as representative point for infinity) and point 2 (middle distance at 6 m)

$$MTF10_{(1)} \geq 0,9 \cdot MTF10_{MIN(1)} \langle LW / PH \rangle$$

(b) Resolution at point 3 (Close distance at 4 meters)

$$MTF10_{(1)} \geq \frac{1}{2} MTF10_{MIN(1)} \langle LW / PH \rangle$$

6.2.2.3.3.7. Geometric distortion

For CMS of Classes I, II and III the maximum distortion within the minimum required field of view shall not exceed 20 per cent relative to recto-linear or pinhole projection.

This performance shall be tested according to the method given in ISO 16505:2015, Annex G.3.

6.2.2.3.3.8. Further image quality requirements

6.2.2.3.3.8.1. Flicker

The entire image area of the monitor shall be free of flicker according to the test method of Annex 12, paragraph 1.2..

6.2.2.3.4. Time behaviour

6.2.2.3.4.1. Frame rate

Movements of objects in front of the camera shall be rendered smooth and fluid. The minimum frame rate of the system (update rate of the image information) shall be at least 30 Hz. At low light conditions or while maneuvering at low speed, the minimum frame rate of the system (i.e. update rate of the image information) shall be at least 15 Hz.

6.2.2.3.4.2. Image formation time

The image formation time of the monitor shall be less than 55 ms at a temperature of 22 °C ±5 °C.

This performance shall be tested according to the method given in ISO 9241-305:2008.

6.2.2.3.4.3. System latency

A CMS shall have a sufficient short latency to render the scenery nearly at the same time. The latency shall be lower than 200 ms at room temperature 22 °C ±5 °C.

6.2.2.3.5. Quality and further ergonomic requirements

6.2.2.3.5.1. Glare due to high luminance of the monitor

In order to avoid glare from a high luminance of the monitor, the luminance shall be dimmable in the night condition either manually or automatically.

6.2.3. Other devices for indirect vision

It has to be proved that the device meets the following requirements:

6.2.3.1. The device shall perceive the visual spectrum and shall always render this image without the need for interpretation into the visual spectrum.

6.2.3.2. The functionality shall be guaranteed under the circumstances of use in which the system shall be put into service. Depending on the technology used in obtaining images and presenting them paragraph 6.2.2.2. above shall be entirely or partly applicable. In other cases this can be achieved by establishing and demonstrating by means of system sensitivity analogous to paragraph 6.2.2.2. above that a function is ensured that is comparable to or better than what is required for and by demonstrating that a functionality is guaranteed that is equivalent or better than that required for mirror- or camera-monitor type devices for indirect vision.

### 6.3. Test

**The requirements of paragraph 6.3. shall be considered to be satisfied in the case of monitors of a vehicle fulfilling the provisions of Regulation No. 21.**

6.3.1. ~~Mirrors~~ **Devices for indirect vision** in Classes I to VI and Class VII **mirrors** (having fitments identical to Class III) shall be subjected to the tests described in paragraphs ~~6.1.3.2.1-6.3.2.1.~~ and ~~6.1.3.2.2-6.3.2.2.~~ below. Class VII mirrors with a stem, shall be subjected to the tests described in paragraph ~~6.1.3.2.3-6.3.2.3.~~ **6.3.2.3.** below.

6.3.1.1. The test provided for in paragraph ~~6.1.3.2-6.3.2.~~ **6.3.2.** below shall not be required in the case of any **Class II to IV** exterior ~~mirror~~ **device for indirect vision** of which no part is less than 2 m from the ground, regardless of the adjustment position, when the vehicle is under a load corresponding to its maximum technically permissible mass.

This derogation also applies to the attachments of ~~mirrors~~ **devices for indirect vision** (attachment plates, arms, swivel joints, etc.) which are situated less than 2 m from the ground and which do not project beyond the overall width of the vehicle, measured in the transverse plane passing through the lowest mirror attachments or any other point forward of this plane if this configuration produces a greater overall width.

In such cases, a description specifying that the ~~mirror~~ **device for indirect vision** shall be mounted so as to conform to the above-mentioned conditions for the positioning of its attachments on the vehicle shall be provided.

Where advantage is taken of this derogation, the arm shall be indelibly marked with the symbol

$$\frac{\Delta}{2m}$$

and the type approval certificate shall be endorsed to this effect.

6.3.2. Impact test

The test according to this paragraph is not to be carried out for devices integrated in the bodywork of the vehicle and providing a frontal deflecting area of an angle not more than 45° measured in relation to the longitudinal median plane of the vehicle, or devices not protruding more than 100 mm measured beyond the circumscribing bodywork of the vehicle according to Regulation No. 26.

6.3.2.1. Description of the test rig

- 6.3.2.1.1. The test rig consists of a pendulum capable of swinging about two horizontal axes at right angles to each other, one of which is perpendicular to the plane containing the "release" trajectory of the pendulum.

The end of the pendulum comprises a hammer formed by a rigid sphere with a diameter of  $165 \pm 1$  mm having a 5 mm thick rubber covering of Shore A hardness 50.

A device is provided which permits determination of the maximum angle assumed by the arm in the plane of release.

A support firmly fixed to the structure of the pendulum serves to hold the specimens in compliance with the impact requirements specified in paragraph 6.1.3.2.2.6. below.

Figure 1 below gives the dimensions (in mm) of the test rig and the special design specifications:

Figure 1

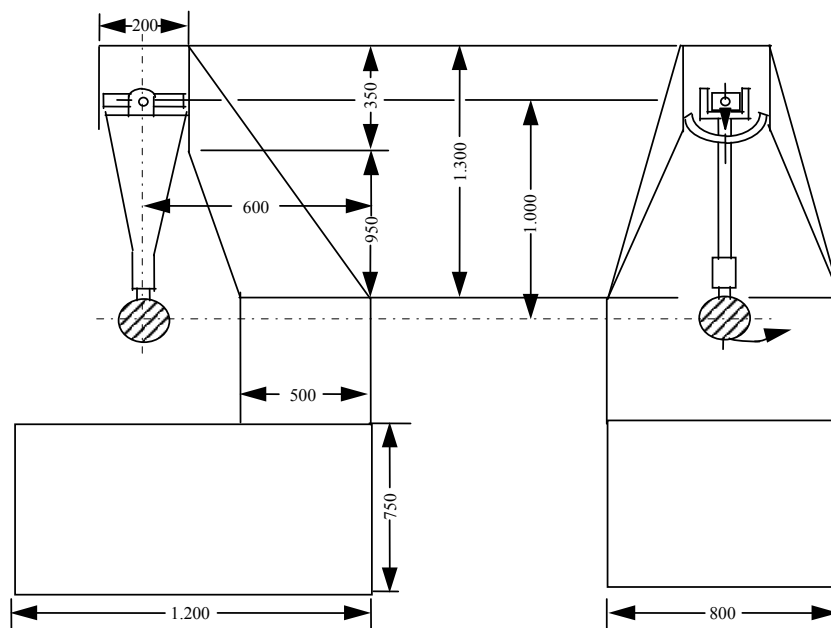

- 6.3.2.1.2. The centre of percussion of the pendulum coincides with the centre of the sphere, which forms the hammer. It is at a distance  $l$  from the axis of oscillation in the release plane, which is equal to  $1 \text{ m} \pm 5 \text{ mm}$ . The reduced mass of the pendulum is  $m_0 = 6.8 \pm 0.05$  kilograms. The relationship of  $m_0$  to the total mass  $m$  of the pendulum and to the distance  $d$  between the centre of gravity of the pendulum and its axis of rotation is expressed in the equation:

- 6.3.2.2. Description of the test

- 6.3.2.2.1. The procedure used to clamp the ~~mirror~~ **device for indirect vision** to the support shall be that recommended by the manufacturer of the device or, where appropriate, by the vehicle manufacturer.

- 6.3.2.2.2. Positioning of the ~~mirror~~ **device for indirect vision** for the test:

- 6.3.2.2.2.1.** ~~Mirrors~~ **Devices for indirect vision** shall be positioned on the pendulum impact rig in such a way that the axes which are horizontal and vertical when the mirror is installed on a vehicle in accordance with the applicant's mounting instructions are in a similar position;
- 6.3.2.2.2.2.** When a ~~mirror~~ **device for indirect vision** is adjustable with respect to the base, the test position shall be that in which any pivoting device is least likely to operate, within the limits of adjustment provided by the applicant;
- 6.3.2.2.2.3.** When the ~~mirror~~ **device for indirect vision** has a device for adjusting its distance from the base, the device shall be set in the position in which the distance between the housing and the base is shortest;
- 6.3.2.2.2.4.** **In case of mirrors,** ~~When~~ the reflecting surface is mobile in the housing, it shall be so adjusted that the upper corner, which is furthest from the vehicle, is in the position of greatest projection relative to the housing.
- 6.3.2.2.3.** **In case of mirrors,** ~~Except in the case of test 2 for interior~~ **Class I mirrors** (see paragraph ~~6.1.3.2.2.6.1.~~ **6.3.2.2.7.1.** below), when the pendulum is in a vertical position the horizontal and longitudinal vertical planes passing through the centre of the hammer shall pass through the centre of the reflecting surface as defined in paragraph ~~2.1.1.11.~~ **2.1.1.10.** of this Regulation. The longitudinal direction of oscillation of the pendulum shall be parallel to the longitudinal median plane of the vehicle.
- 6.3.2.2.4.** **In case of camera-monitor systems, when the pendulum is in a vertical position the horizontal and longitudinal vertical planes passing through the centre of the hammer shall pass through the centre of the lens or of the transparent protection part protecting the lens. The longitudinal direction of oscillation of the pendulum shall be parallel to the longitudinal median plane of the vehicle. If the test is performed with a shutter camera system, the shutter has to be open during the pendulum impact.**
- 6.3.2.2.5.** When, under the conditions governing adjustment laid down in paragraphs ~~6.1.3.2.2.1.~~ **6.3.2.2.1.** and ~~6.1.3.2.2.2.~~ **6.3.2.2.2.** above parts of the ~~mirror~~ **device for indirect vision** limit the return of the hammer, the point of impact shall be displaced in a direction perpendicular to the axis of rotation or pivoting in question.
- The displacement shall be no greater than is strictly necessary for the execution of the test; it shall be limited in such a way that:
- (a) Either the sphere delimiting the hammer remains at least tangential to the cylinder as defined in paragraph 6.1.1.6.;
  - (b) Or, **in case of mirrors,** the point of contact with the hammer is located at least 10 mm from the periphery of the reflecting surface.
- 6.3.2.2.6.** The test consists in allowing the hammer to fall from a height corresponding to a pendulum angle of 60° from the vertical so that the hammer strikes the ~~mirror~~ **device for indirect vision** at the moment when the pendulum reaches the vertical position.
- 6.3.2.2.7.** The ~~mirrors~~ **devices for indirect vision** are subjected to impact under the following different conditions:
- 6.3.2.2.7.1.** ~~Interior~~ **Class I rear-view mirrors**



- (a) Test 1: The points of impact shall be as defined in paragraph ~~6.1.3.2.2.3~~ **6.3.2.2.3**, above. The impact shall be such that the hammer strikes the mirror on the reflecting surface side.
- (b) Test 2: Point of impact on the edge of the protective housing, such that the impact produced makes an angle of 45° with the plane of the reflecting surface and is situated in the horizontal plane passing through the centre of that surface. The impact shall occur on the reflecting surface side.

#### **6.3.2.2.7.2. Exterior Class II to VII mirrors**

- (a) Test 1: The point of impact shall be as defined in paragraph ~~6.1.3.2.2.3~~ or ~~6.1.3.2.2.4~~ **6.3.2.2.3** or **6.3.2.2.5**, above. The impact shall be such that the hammer strikes the mirror on the reflecting surface side.
- (b) Test 2: The point of impact shall be as defined in paragraph ~~6.1.3.2.2.3~~ or ~~6.1.3.2.2.4~~ **6.3.2.2.3** or **6.3.2.2.5**, above. The impact shall be such that the hammer strikes the mirror on the side opposite to the reflecting surface.

Where Class II or III rear-view mirrors are fixed to the same mounting as Class IV rear-view mirrors, the above-mentioned tests shall be executed on the lower mirror. Nevertheless, the Technical Service responsible for testing may repeat one or both of these tests on the upper mirror if this is less than 2 m from the ground.

#### **6.3.2.2.7.3. Camera-Monitor Systems**

- (a) **Test 1: The point of impact shall be as defined in paragraph 6.3.2.2.4 or 6.3.2.2.5. The impact shall be such that the hammer strikes the camera on the lens side.**
- (b) **Test 2: The point of impact shall be as defined in paragraph 6.3.2.2.4 or 6.3.2.2.5. The impact shall be such that the hammer strikes the camera on the side opposite to the lens.**

**Where more than one camera is fixed to the same mounting, the above-mentioned tests shall be executed on the lower camera. Nevertheless, the Technical Service responsible for testing may repeat one or both of these tests on the upper camera if this is less than 2 m from the ground.**

#### **6.3.2.3. Bending test on the protective housing attached to the stem (Class VII)**

##### **6.3.2.3.1. Description of test**

The protective housing is placed horizontally in a device in such a way that it is possible to lock the attachment support adjusters firmly. In the direction of the largest dimension of the housing, the end closest to the point of attachment on the adjuster for the support shall be immobilized by a 15 mm-wide rigid stop covering the entire width of the housing.

At the other end, a stop identical to the one described above is placed on the housing so that the specified test load can be applied to it (Figure 2).

The end of the housing opposite to that where the force is exerted may be locked rather than held in position as shown in Figure 2.

Figure 2  
Example of rear view mirror bending-test rig

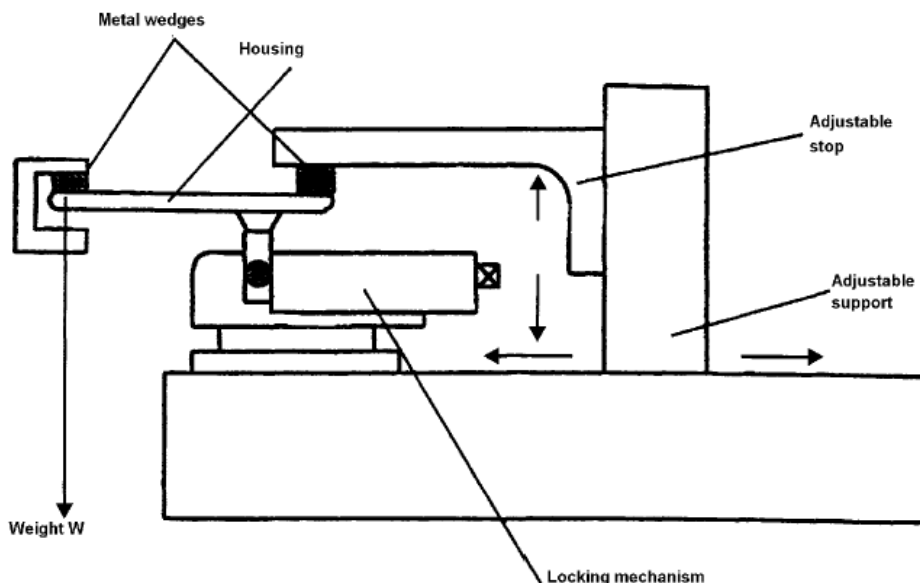

6.3.2.3.2. The test loading shall be 25 kilograms and shall be maintained for one minute.

6.3.3. Results of the tests

6.3.3.1. In the tests described in paragraph 6.1.3.2. 6.3.2. above, the pendulum shall continue to swing after impact in such a way that the projection of the position assumed by the arm on the plane of release makes an angle of at least 20° with the vertical. The accuracy of measurement of the angle shall be within  $\pm 1^\circ$ .

6.3.3.1.1. **In case of mirrors,** this requirement is not applicable to mirrors stuck to the windscreen, in respect of which the requirement stipulated in paragraph 6.1.3.2. 6.3.3.2. shall apply after the test.

6.3.3.1.2. The required angle to the vertical is reduced from 20° to 10° for all Class II and Class IV rear-view mirrors devices for indirect vision and for Class III rear-view mirrors devices for indirect vision which are attached to the same mounting as Class IV mirrors devices for indirect vision.

6.3.3.2. **In case of mirrors,** should the mounting of the mirror break during the tests described in paragraph 6.1.3.2. 6.3.2. above for mirrors stuck to the windscreen, the part remaining shall not project beyond the base by more than 10 mm and the configuration remaining after the test shall satisfy the conditions laid down in paragraph 6.1.1.3. 6.1.3. of this Regulation.

6.3.3.3. The reflecting surface shall not break during the tests described in paragraph 6.1.3.2. 6.3.2. However, breakage of the reflecting surface will be allowed if one of the following conditions is fulfilled:

6.3.3.3.1. The fragments of glass still adhere to the back of the housing or to a surface firmly attached to the housing; partial separation of the glass from its backing is admissible provided that this does not exceed 2.5 mm on either side of the

cracks. It is permissible for small splinters to become detached from the surface of the glass at the point of impact;

6.3.3.3.2. The reflecting surface is made of safety glass.

6.3.3.4. **In case of camera-monitor systems, the lens shall not break during the tests described in paragraph 6.3.2. above.**

## 7. **Modification of the type of device for indirect vision and extension of approval**

7.1. Every modification to an existing type of device for indirect vision including its connection to the bodywork shall be notified to the Type Approval Authority which approved the type of device for indirect vision. The Type Approval Authority shall then either:

- (a) Decide, in consultation with the manufacturer, that a new type-approval is to be granted, or
- (b) Apply the procedure contained in paragraph 7.1.1. (Revision) and, if applicable, the procedure contained in paragraph 7.1.2. (Extension).

7.1.1. Revision<sup>3</sup>

When particulars recorded in the information folder have changed and the Type Approval Authority considers that the modifications made are unlikely to have an appreciable adverse effect and that in any case the device for indirect vision still complies with the requirements, the modification shall be designated a "revision".

In such a case, the Type Approval Authority shall issue the revised pages of the information folder as necessary, marking each revised page to show clearly the nature of the modification and the date of re-issue. A consolidated, updated version of the information folder, accompanied by a detailed description of the modification, shall be deemed to meet this requirement.

7.1.2. Extension<sup>3</sup>

The modification shall be designated an "extension" if, in addition to the change of the particulars recorded in the information folder,

- (a) Further inspections or tests are required, or
- (b) Any information on the communication document (with the exception of its attachments) has changed, or
- (c) Approval to a later series of amendments is requested after its entry into force.

7.2. Confirmation or refusal of approval, specifying the alterations shall be communicated by the procedure specified in paragraph 5.3. above to the Parties to the Agreement which apply this Regulation. In addition, the index to the information package, attached to the communication document, shall

<sup>3</sup> Note by the secretariat: The provisions on revisions and extensions of type approvals shall only refer to new Schedule 3 of draft Revision 3 to the 1958 Agreement.

be amended accordingly to show the date of the most recent revision or extension.

- 7.3. (Reserved)
- 7.4. The Type Approval Authority issuing the extension of approval shall assign a series number to each communication form drawn up for such an extension.

## **8. Conformity of production**

- 8.1. The conformity of production procedure shall comply with those set out in the Agreement, Appendix 2 (E/ECE/324-E/ECE/TRANS/505/Rev.2).<sup>4</sup>
- 8.2. Every device for indirect vision approved under this Regulation shall be so manufactured as to conform to the type-approved by meeting the requirements set out in paragraph 6. above.

## **9. Penalties for non-conformity of production**

- 9.1. The approval granted in respect of a type of device for indirect vision pursuant to this Regulation may be withdrawn if the requirement laid down in paragraph 8.1. above is not complied with or if the type of device for indirect vision did not satisfy the requirements prescribed in paragraph 8.2. above.
- 9.2. If a Contracting Party to the Agreement which applies this Regulation withdraws an approval it has previously granted, it shall forthwith so notify the other Contracting Parties applying this Regulation by means of a copy of the communication form bearing at the end, in large letters, the signed and dated annotation "APPROVAL WITHDRAWN".

## **10. Production definitively discontinued**

If the holder of the approval completely ceases to manufacture a type of device for indirect vision approved in accordance with this Regulation, he shall so inform the Type Approval Authority which granted the approval. Upon receiving the relevant communication, the authority shall inform thereof the other Parties to the Agreement applying this Regulation by means of a copy of the approval form bearing at the end, in large letters, the signed and dated annotation "PRODUCTION DISCONTINUED".

## **11. Names and addresses of Technical Services responsible for conducting approval tests, and of Type Approval Authorities**

The Contracting Parties to the Agreement applying this Regulation shall communicate to the United Nations Secretariat the names and addresses of the Technical Services responsible for conducting approval tests and of the Type Approval Authorities which grant approval and to which forms

---

<sup>4</sup> Note by the secretariat: The provisions on conformity of production shall refer to new Schedule 1 of draft Revision 3 to the 1958 Agreement.

certifying approval or refusal or extension or withdrawal of approval, issued in other countries, are to be sent.

## II. Installation of devices for indirect vision

### 12. Definitions

For the purpose of this Regulation:

- 12.1. "The driver's ocular points" means two points 65 mm apart and 635 mm vertically above point R of the driver's seat as defined in Annex 8. The straight line joining these points runs perpendicular to the vertical longitudinal median plane of the vehicle. The centre of the segment joining the two ocular points is in a vertical longitudinal plane which shall pass through the centre of the driver's designated seating position, as specified by the vehicle manufacturer.
- 12.2. "Ambinocular vision" means the total field of vision obtained by the superimposition of the monocular fields of the right eye and the left eye (see Figure 3 below).

Figure 3

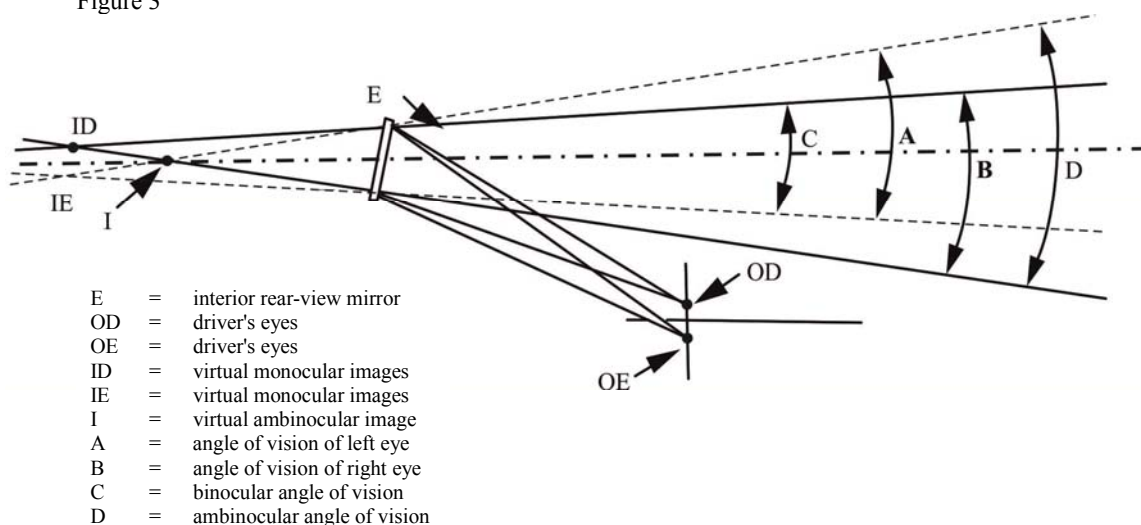

- 12.3. "Type of vehicle as regards indirect vision" means motor vehicles which are identical in respect of the following basic features:
- 12.3.1. Type of device for indirect vision;
- 12.3.2. The bodywork features which reduce the field of vision;
- 12.3.3. The coordinates of point R (where applicable);
- 12.3.4. The prescribed positions, and type-approval markings of compulsory and (if fitted) optional devices for indirect vision.
- 12.4. "Vehicles of categories  $L_2$ ,  $L_5$ ,  $M_1$ ,  $M_2$ ,  $M_3$ ,  $N_1$ ,  $N_2$  and  $N_3$ " means those defined in the Consolidated Resolution on the Construction of Vehicles (R.E.3), (document ECE/TRANS/WP.29/78/Rev.3, para. 2).

12.5. "Forward control" means a configuration in which more than half of the engine length is rearward of the foremost point of the windshield base and the steering wheel hub in the forward quarter of the vehicle length.

12.6. "Ocular reference point" means the middle point between the driver's ocular points.

### 13. Application for approval

13.1. The application for approval of a vehicle type with regard to the installation of devices for indirect vision shall be submitted by the vehicle manufacturer or by his duly accredited representative.

13.2. A model of information document is shown in Annex 2.

13.3. A vehicle representative of the vehicle type to be approved shall be submitted to the Technical Service responsible for conducting the approval tests.

13.4. The Type Approval Authority shall verify the existence of satisfactory arrangements for ensuring effective checks on conformity of production before type-approval is granted.

13.5. **The CMS shall be provided by the applicant with the following documents:**

- (a) **Technical specification of the CMS;**
- (b) **Operator's manual;**
- (c) **Documentation referred to in Annex 12, paragraph 2.3.**

### 14. Approval

14.1. If the vehicle type submitted for approval in accordance with paragraph 13. above meets the requirements of paragraph 15. of this Regulation, approval shall be granted.

14.2. An approval number shall be assigned to each type-approved. Its first two digits (at present 04) shall indicate the series of amendments incorporating the most recent or technical amendments made to the Regulation at the time of issue of the approval. The same Contracting Party shall not assign the same number to another vehicle type.

14.3. Notice of approval or of refusal or of extension or withdrawal of approval of a vehicle type pursuant to this Regulation shall be communicated to the Parties to the Agreement which apply this Regulation by means of a form conforming to the model in Annex 4 to this Regulation.

### 15. Requirements

15.1. General

15.1.1. The compulsory and optional devices for indirect vision, set out in the table under paragraph 15.2.1.1.1. below, installed on the vehicle shall be of a type-approved under this Regulation.

15.1.2. ~~Mirrors and other devices~~ Devices for indirect vision shall be fitted in such a way that the ~~mirror or other device does~~ devices **do** not move so as significantly to

change the field of vision as measured or vibrate to an extent which would cause the driver to misinterpret the nature of the image perceived.

15.1.3. The conditions laid down in paragraph 15.1.2. above shall be maintained when the vehicle is moving at speeds of up to 80 per cent of its maximum design speed, but not exceeding 150 km/h.

15.1.4. The fields of vision defined below shall be established using ambinoocular vision, the eyes being at the "driver's ocular points" as defined in paragraph 12.1. above. The fields of vision shall be determined when the vehicle is in running order as defined in the consolidated Resolution on the Construction of vehicles (R.E.3) (ECE/TRANS/WP.29/78/Rev.3, para. 2.2.5.4.), plus for M<sub>1</sub> and N<sub>1</sub> vehicles one front seat passenger (75 kg). When established through windows, the glazing shall have a total light transmission factor in accordance with Regulation No. 43, Annex 21.

15.2. ~~Mirrors~~ **Devices for indirect vision**

15.2.1. Number

15.2.1.1. Minimum number of compulsory ~~mirrors~~ **devices for indirect vision**

15.2.1.1.1. The fields of vision prescribed in paragraph 15.2.4. below shall be obtained from the minimum number ~~of~~ mandatory mirrors **or camera-monitor devices** set out in the following table. ~~Where the presence of a mirror is not requested on a mandatory base, this means that no other system for indirect vision can be requested on a mandatory base.~~

**A minimum number of camera-monitor systems is undefined, but they shall provide the same field of vision as given in the table below and the provision on the minimum mounting height does not apply.**

**In case of camera-monitor systems, the maximum number of monitors shall not exceed the corresponding number of mirrors.**

Vehicle category	Interior mirror		Exterior mirrors			
	Interior mirror Rear view Class I	Main mirror (large) rear view Class II	Main mirror (small) rear view Class III	Wide-angle mirror view Class IV	Close-proximity mirror view Class V	Front mirror view Class VI
M <sub>1</sub>	<b>Compulsory</b> Unless the vehicle is fitted with anything other than safety glazing material in the field of vision prescribed in paragraph 15.2.4.1.	<b>Optional</b>	<b>Compulsory</b> 1 on the driver's side and 1 on the passenger's side Class II mirrors may be fitted as an alternative.	<b>Optional</b> 1 on the driver's side and/or 1 on the passenger's side	<b>Optional</b> 1 on the driver's side and 1 on the passenger's side (both shall be fitted at least 2 m above the ground)	<b>Optional</b> (shall be fitted at least 2 m above the ground)
M <sub>2</sub>	<b>Optional</b> (no requirements for the field of view)	<b>Compulsory</b> 1 on the driver's side and 1 on the passenger's side	Not permitted	<b>Optional</b> 1 on the driver's side and/or 1 on the passenger's side	<b>Optional</b> 1 on the driver's side and 1 on the passenger's side (both shall be fitted at least 2 m above the ground)	<b>Optional</b> (shall be fitted at least 2 m above the ground)
M <sub>3</sub>	<b>Optional</b> (no requirements for the field of view)	<b>Compulsory</b> 1 on the driver's side and 1 on the passenger's side	Not permitted	<b>Optional</b> 1 on the driver's side and/or 1 on the passenger's side	<b>Optional</b> 1 on the driver's side and 1 on the passenger's side (both shall be fitted at least 2 m above the ground)	<b>Optional</b> (shall be fitted at least 2 m above the ground)
N <sub>1</sub>	<b>Compulsory</b> Unless the vehicle is fitted with anything other than safety glazing material in the field of vision prescribed in paragraph 15.2.4.1.	<b>Optional</b>	<b>Compulsory</b> 1 on the driver's side and 1 on the passenger's side Class II mirrors may be fitted as an alternative.	<b>Optional</b> 1 on the driver's side and/or 1 on the passenger's side	<b>Optional</b> 1 on the driver's side and 1 on the passenger's side (both shall be fitted at least 2 m above the ground)	<b>Optional</b> (shall be fitted at least 2 m above the ground)



Vehicle category	Interior mirror		Exterior mirrors			
	Interior mirror Rear view Class I	Main mirror (large) rear view Class II	Main mirror (small) rear view Class III	Wide-angle mirror view Class IV	Close-proximity mirror view Class V	Front mirror view Class VI
N <sub>2</sub> ≤ 7,5 t	<b>Optional</b> (no requirements for the field of view)	<b>Compulsory</b> 1 on the driver's side and 1 on the passenger's side	Not permitted	<b>Compulsory</b> For both sides if a Class V mirror can be fitted  <b>Optional</b> For both sides together if not  In addition according to paragraphs 15.2.4.5.6. to 15.2.4.5.11. for vehicles with a mounting height of the Class V mirror of not less than 2.4 m (see paragraph 15.2.4.5.12.): the required field of vision (paragraphs 15.2.4.5.6. to 15.2.4.5.9.) may be viewed using a combination of direct view and indirect vision devices (of Classes IV, V, VI).	<b>Compulsory</b> (see paragraphs 15.2.2.7. and 15.2.4.5.5.)  1 on the passenger's side  <b>Optional</b> 1 on the driver's side (both shall be fitted at least 2 m above the ground). A tolerance of +10 cm may be applied  In addition according to paragraphs 15.2.4.5.6. to 15.2.4.5.11. for vehicles with a mounting height of the Class V mirror of not less than 2.4 m (see paragraph 15.2.4.5.12.): the required field of vision (paragraphs 15.2.4.5.6. to 15.2.4.5.9.) may be viewed using a combination of direct view and indirect vision devices (of Classes IV, V, VI).	<b>Optional</b> 1 front mirror (shall be fitted at least 2 m above the ground)  In addition according to paragraphs 15.2.4.5.6. to 15.2.4.5.11. for vehicles with a mounting height of the Class V mirror of not less than 2.4 m (see paragraph 15.2.4.5.12.): the required field of vision (paragraphs 15.2.4.5.6. to 15.2.4.5.9.) may be viewed using a combination of direct view and indirect vision devices (of Classes IV, V, VI).

Vehicle category	Interior mirror		Exterior mirrors			
	Interior mirror Rear view Class I	Main mirror (large) rear view Class II	Main mirror (small) rear view Class III	Wide-angle mirror view Class IV	Close-proximity mirror view Class V	Front mirror view Class VI
N <sub>2</sub> > 7,5 t	<b>Optional</b> (no requirements for the field of view)	<b>Compulsory</b> 1 on the driver's side and 1 on the passenger's side	Not permitted	<b>Compulsory</b> 1 on the driver's side and 1 on the passenger's side  In addition according to paragraphs 15.2.4.5.6. to 15.2.4.5.11. for vehicles with a mounting height of the Class V mirror of not less than 2.4 m (see paragraph 15.2.4.5.12.): the required field of vision (paragraphs 15.2.4.5.6. to 15.2.4.5.9.) may be viewed using a combination of direct view and indirect vision devices (of Classes IV, V, VI).	<b>Compulsory</b> (see paragraph 15.2.2.7. and 15.2.4.5.5) 1 on the passenger's side  <b>Optional</b> 1 on Driver's side (both shall be fitted at least 2 m above the ground)  In addition according to paragraphs 15.2.4.5.6. to 15.2.4.5.11. for vehicles with a mounting height of the Class V mirror of not less than 2.4 m (see paragraph 15.2.4.5.12.): the required field of vision (paragraphs 15.2.4.5.6. to 15.2.4.5.9.) may be viewed using a combination of direct view and indirect vision devices (of Classes IV, V, VI).	<b>Compulsory</b> (see paragraph 15.2.1.1.2 1. front mirror (shall be fitted at least 2 m above the ground)  In addition according to paragraphs 15.2.4.5.6. to 15.2.4.5.11. for vehicles with a mounting height of the Class V mirror of not less than 2.4 m (see paragraph 15.2.4.5.12.): the required field of vision (paragraphs 15.2.4.5.6. to 15.2.4.5.9.) may be viewed using a combination of direct view and indirect vision devices (of Classes IV, V, VI).

Vehicle category	Interior mirror		Exterior mirrors				
	Interior mirror view Class I	Rear view Class II	Main mirror (large) rear view Class III	Main mirror (small) rear view Class III	Wide-angle mirror view Class IV	Close-proximity mirror view Class V	Front mirror view Class VI
N <sub>3</sub>	<b>Optional</b> (no requirements for the field of view)	<b>Compulsory</b> 1 on the driver's side and 1 on the passenger's side	Not permitted	<b>Compulsory</b> 1 on the driver's side and 1 on the passenger's side  In addition according to paragraphs 15.2.4.5.6. to 15.2.4.5.11. for vehicles with a mounting height of the Class V mirror of not less than 2.4 m (see paragraph 15.2.4.5.12.): the required field of vision (paragraphs 15.2.4.5.6. to 15.2.4.5.9.) may be viewed using a combination of direct view and indirect vision devices (of Classes IV, V, VI).	<b>Compulsory</b> 1 on the driver's side and 1 on the passenger's side  Optional 1 on driver's side (both shall be fitted at least 2 m above the ground)  In addition according to paragraphs 15.2.4.5.6. to 15.2.4.5.11. for vehicles with a mounting height of the Class V mirror of not less than 2.4 m (see paragraph 15.2.4.5.12.): the required field of vision (paragraphs 15.2.4.5.6. to 15.2.4.5.9.) may be viewed using a combination of direct view and indirect vision devices (of Classes IV, V, VI).	<b>Compulsory</b> (see paragraph 15.2.2.7. and 15.2.4.5.5) 1 on the passenger's side  Optional 1 on driver's side (both shall be fitted at least 2 m above the ground)  In addition according to paragraphs 15.2.4.5.6. to 15.2.4.5.11. for vehicles with a mounting height of the Class V mirror of not less than 2.4 m (see paragraph 15.2.4.5.12.): the required field of vision (paragraphs 15.2.4.5.6. to 15.2.4.5.9.) may be viewed using a combination of direct view and indirect vision devices (of Classes IV, V, VI).	<b>Compulsory</b> (see paragraph 15.2.1.1.2) 1. front mirror (shall be fitted at least 2 m above the ground)  In addition according to paragraphs 15.2.4.5.6. to 15.2.4.5.11. for vehicles with a mounting height of the Class V mirror of not less than 2.4 m (see paragraph 15.2.4.5.12.): the required field of vision (paragraphs 15.2.4.5.6. to 15.2.4.5.9.) may be viewed using a combination of direct view and indirect vision devices (of Classes IV, V, VI).

~~15.2.1.1.2. In case the described field of vision of a front mirror prescribed in paragraph 15.2.4.6. below and/or a close proximity mirror described in paragraph 15.2.4.5. below can be obtained by another device for indirect vision that is approved according to paragraph 6.2. of this Regulation and that is installed according to paragraph 15. above, this device can be used instead of the relevant mirror or mirrors.~~

~~In case a camera/monitor device is used, the monitor shall exclusively show:~~

- ~~(a) The field of vision prescribed in paragraph 15.2.4.5. below when the close proximity mirror has been substituted;~~
- ~~(b) The field of vision prescribed in paragraph 15.2.4.6. below when the front mirror has been substituted while the vehicle is moving forward with a speed of up to 10 km/h; or~~
- ~~(c) Simultaneously the fields of vision prescribed in paragraphs 15.2.4.5. and 15.2.4.6. below when the close proximity mirror and the front mirror have been substituted. In the case where the vehicle is moving forward at a higher speed than 10 km/h or moving backwards, the monitor may be used for other information, provided that the field of vision prescribed in paragraph 15.2.4.5. below is permanently displayed.~~

15.2.1.1.2. **In the case a camera-monitor system is used for rendering (the) field(s) of vision, the relevant field(s) of vision shall be permanently visible to the driver when the ignition is on or the vehicle master control switch is activated (whichever is applicable). However, when the vehicle is moving forward at a speed above 10 km/h or backwards, the monitor or the part of the monitor intended for rendering the Class VI field of vision may be used for other information. Multiple images may be used or displayed provided that the monitor has been approved in this mode.**

15.2.1.1.3. Rear view mirrors required for L-category vehicles with body work

<i>Category of vehicle</i>	<i>Interior mirror (Class I) Rear view Class I</i>	<i>Main rear view exterior mirror(s) (Classes III and VII)</i>
L category motor vehicles fitted with bodywork which partly or wholly encloses the driver	1 <sup>1</sup>	1, if there is <del>an interior mirror</del> <b>a Class I rear-view mirror</b> ; 2, if there is <del>not an interior mirror</del> <b>a Class I rear-view mirror</b>

<sup>1</sup> No ~~interior~~ rear-view mirror **Class I** is required if the visibility conditions referred to in paragraph 15.2.5.4.1. below cannot be met. In this case two **class III or VII exterior** rear-view mirrors are required, one **giving the view** on the left and one **giving the view** on the right hand side of the vehicle.

Where a single **Class III or VII exterior** rear view mirror is fitted this shall be located on the left hand side of the vehicle in those countries where the traffic drives on the right and on the right hand side of the vehicle in those countries where the traffic drives on the left.

15.2.1.1.4. Optional rear-view mirrors for L-category vehicles

The fitting of **a Class III or VII an exterior** rear-view mirror on the side of the vehicle opposite to that of the mandatory rear-view mirror referred to in

- paragraph 15.2.1.1.3. above, is permissible. The rear-view mirror shall meet the requirements of this Regulation.
- 15.2.1.2. The provisions of this Regulation do not apply to the surveillance mirrors defined in paragraph 2.1.1.3. of this Regulation. Nevertheless, the exterior surveillance mirrors shall be mounted at least 2 m above the ground when the vehicle is under a load corresponding to its maximum technical permissible mass.
- 15.2.2. Position
- 15.2.2.1. ~~Mirrors~~ **Devices for indirect vision** shall be so placed that the driver, when sitting on the driving seat in a normal driving position, has a clear view of the road to the rear, side(s) or front of the vehicle.
- 15.2.2.2. ~~Exterior~~ **Class II to VII** mirrors shall be visible through the side windows or through the portion of the windscreen that is swept by the windscreen wiper. Nevertheless, for design reasons, this last provision (i.e. the provisions relating the cleaned part of the windscreen) shall not apply to:
- (a) ~~Exterior~~ **Class II to VII** mirrors on the passenger side and optional exterior mirrors on the driver side of vehicles of categories M<sub>2</sub> and M<sub>3</sub>;
  - (b) Class VI **front-view** mirrors.
- 15.2.2.3. In the case of any vehicle, which is in chassis/cab form when the field of vision is measured, the minimum and maximum body widths shall be stated by the manufacturer and, if necessary, simulated by dummy headboards. All vehicles and ~~mirror~~ **devices for indirect vision** configurations taken into consideration during the tests shall be shown on the type-approval certificate for a vehicle with regard to the installation of ~~mirrors~~ **devices for indirect vision** (see Annex 4).
- 15.2.2.4. The prescribed ~~exterior~~ **Class II, III, IV and VII mirror or monitor** on the driver's side of the vehicle shall be so located that an angle of not more than 55° is formed between the vertical longitudinal median plane of the vehicle and the vertical plane passing through the centre of the mirror **or monitor** and through the centre of the straight line 65 mm long which joins the driver's two ocular points.
- 15.2.2.5. ~~Mirrors~~ **Devices for indirect vision** shall not project beyond the external bodywork of the vehicle substantially more than is necessary to comply with the requirements concerning fields of vision laid down in paragraph 15.2.4. below.
- 15.2.2.6. Where the lower edge of a **Class II to VII** ~~an exterior~~ mirror is less than 2 m above the ground when the vehicle is loaded to its technically permissible maximum laden mass, this mirror shall not project more than 250 mm beyond the overall width of the vehicle measured without mirrors.
- 15.2.2.7. Class V and Class VI mirrors shall be mounted on vehicles in such a way that, regardless of their position after adjustment, no part of these mirrors or their holders is less than 2 m from the ground when the vehicle is under a load corresponding to its technically permissible maximum laden mass.
- These mirrors shall not, however, be mounted on vehicles the cab height of which is such as to prevent compliance with this requirement. In this case another device for indirect vision is not ~~requested~~ **mandatory**.

- 15.2.2.8. Subject to the requirements of paragraphs 15.2.2.5., 15.2.2.6. and 15.2.2.7. above, ~~mirrors~~ **devices for indirect vision** may project beyond the permissible maximum widths of vehicles.
- 15.2.2.9. All Class VII mirrors shall be attached in such a way that they remain in a stable position under normal vehicle driving conditions.
- 15.2.3. Adjustment
  - 15.2.3.1. ~~The interior mirror~~ **If a Class I mirror is fitted, it shall be capable of being adjusted by the driver from his driving position.**
  - 15.2.3.2. ~~The exterior mirror situated~~ **If a Class II, III, IV or VII mirror is fitted on the driver's side, it shall be capable of being adjusted from inside the vehicle while the door is closed, although the window may be open. The mirror may, however, be locked in position from the outside.**
  - 15.2.3.3. The requirements of paragraph 15.2.3.2. above do not apply to ~~exterior~~ mirrors which, after having been knocked out of alignment, can be returned to their former position without the need for adjustment.
- 15.2.4. Fields of vision
  - 15.2.4.1. ~~Interior rear view mirror (Class I)~~ **Class I rear-view device**  
 The field of vision shall be such that the driver can see at least a 20 m wide, flat, horizontal portion of the road centred on the vertical longitudinal median plane of the vehicle and extending from 60 m behind the driver's ocular points (Figure 4) to the horizon.

Figure 4  
**Field of vision of Class I mirror Class I field of vision**

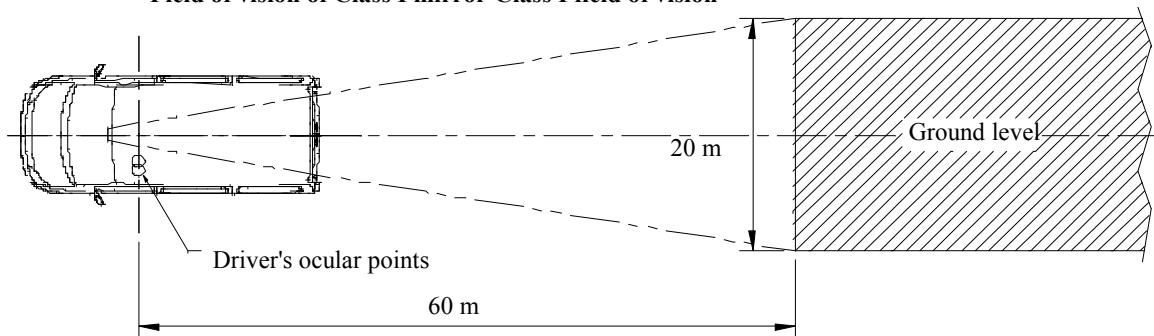

- 15.2.4.2. ~~Main exterior rear view mirrors~~ **Class II main rear-view device**
  - 15.2.4.2.1. ~~Exterior Main rear-view mirror device~~ **on the driver's side**  
 The field of vision shall be such that the driver can see at least a 5 m wide, flat, horizontal portion of the road, which is bounded by a plane which is parallel to the median longitudinal vertical plane and passing through the outermost point of the vehicle on the driver's side of the vehicle and extends from 30 m behind the driver's ocular points to the horizon.  
  
 In addition, the road shall be visible to the driver over a width of 1 m, which is bounded by a plane parallel to the median longitudinal vertical plane and passing through the outermost point of the vehicle starting from a point 4 m behind the vertical plane passing through the driver's ocular points (see Figure 5).
  - 15.2.4.2.2. ~~Exterior Main rear-view mirror device~~ **on the passenger's side**

The field of vision shall be such that the driver can see at least a 5 m wide, flat, horizontal portion of the road, which is bounded on the passenger's side by a plane parallel to the median longitudinal vertical plane of the vehicle and passing through the outermost point of the vehicle on the passenger's side and which extends from 30 m behind the driver's ocular points to the horizon.

In addition, the road shall be visible to the driver over a width of 1 m, which is bounded by a plane parallel to the median longitudinal vertical plane and passing through the outermost point of the vehicle starting from a point 4 m behind the vertical plane passing through the driver's ocular points (see Figure 5).

Figure 5  
Field of vision of Class II mirrors Class II fields of vision

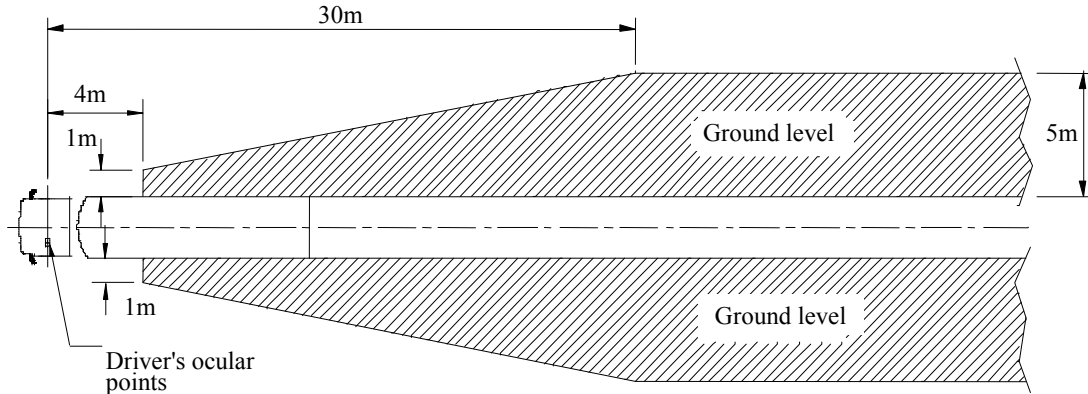

15.2.4.3. ~~Main exterior rear-view mirrors~~ Class III **main rear-view device**

15.2.4.3.1. ~~Exterior Main rear-view mirror device~~ on the driver's side

The field of vision shall be such that the driver can see at least a 4 m wide, flat, horizontal portion of the road, which is bounded by a plane parallel to the median longitudinal vertical plane and passing through the outermost point of the vehicle on the driver's side of the vehicle and extends from 20 m behind the driver's ocular points to the horizon (see Figure 6).

In addition, the road shall be visible to the driver over a width of 1 m, which is bounded by a plane parallel to the median longitudinal vertical plane and passing through the outermost point of the vehicle starting from a point 4 m behind the vertical plane passing through the driver's ocular points.

15.2.4.3.2. ~~Exterior Main rear-view mirror device~~ on the passenger's side

The field of vision shall be such that the driver can see at least a 4 m wide flat, horizontal portion of the road which is bounded by a plane parallel to the median longitudinal vertical plane passing through the outermost point of the vehicle on the passenger's side and which extends from 20 m behind the driver's ocular points to the horizon (see Figure 6).

In addition, the road shall be visible to the driver over a width of 1 m, which is bounded by a plane parallel to the median longitudinal vertical plane and passing through the outermost point of the vehicle starting from a point 4 m behind the vertical plane passing through the driver's ocular points.

Figure 6  
**Field of vision of Class III mirrors Class III fields of vision**

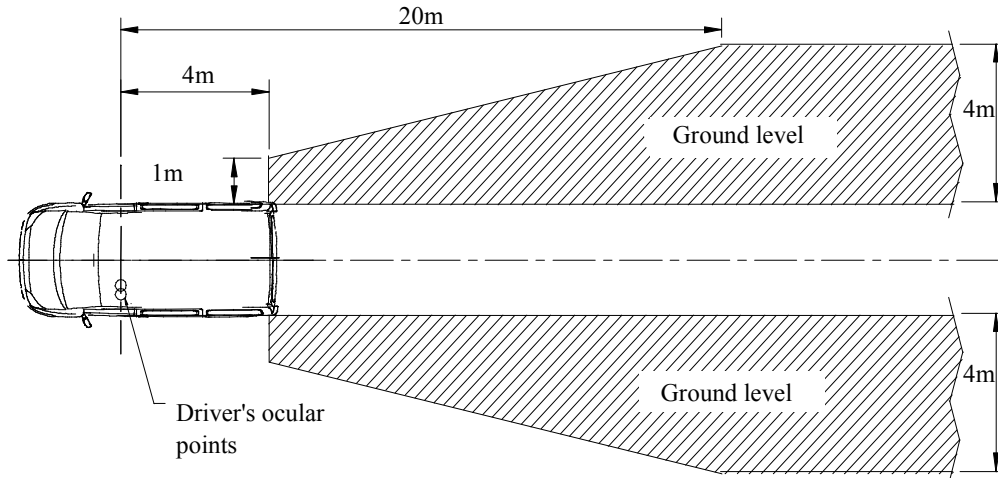

15.2.4.4. **"Wide angle" exterior mirror (Class IV) Class IV wide-angle view device**

15.2.4.4.1. **"Wide angle" exterior mirror Wide-angle view device on the driver's side**

The field of vision shall be such that the driver can see at least a 15 m wide, flat, horizontal portion of the road, which is bounded by a plane parallel to the median longitudinal vertical plane of the vehicle and passing through the outermost point of the vehicle on the driver's side and which extends from at least 10 m to 25 m behind the driver's ocular points.

In addition, the road shall be visible to the driver over a width of 4.5 m, which is bounded by a plane parallel to the median longitudinal vertical plane and passing through the outermost point of the vehicle starting from a point 1.5 m behind the vertical plane passing through the driver's ocular points (see Figure 7).

15.2.4.4.2. **"Wide angle" exterior mirror Wide-angle view device on the passenger's side**

The field of vision shall be such that the driver can see at least a 15 m wide, flat, horizontal portion of the road, which is bounded by a plane parallel to the median longitudinal vertical plane of the vehicle and passing through the outermost point of the vehicle on the passenger's side and which extends from at least 10 m to 25 m behind the driver's ocular points.

In addition, the road shall be visible to the driver over a width of 4.5 m, which is bounded by a plane parallel to the median longitudinal vertical plane and passing through the outermost point of the vehicle starting from a point 1.5 m behind the vertical plane passing through the driver's ocular points (see Figure 7).



Figure 7  
**Field of vision of Class IV wide-angle mirrors Class IV fields of vision**

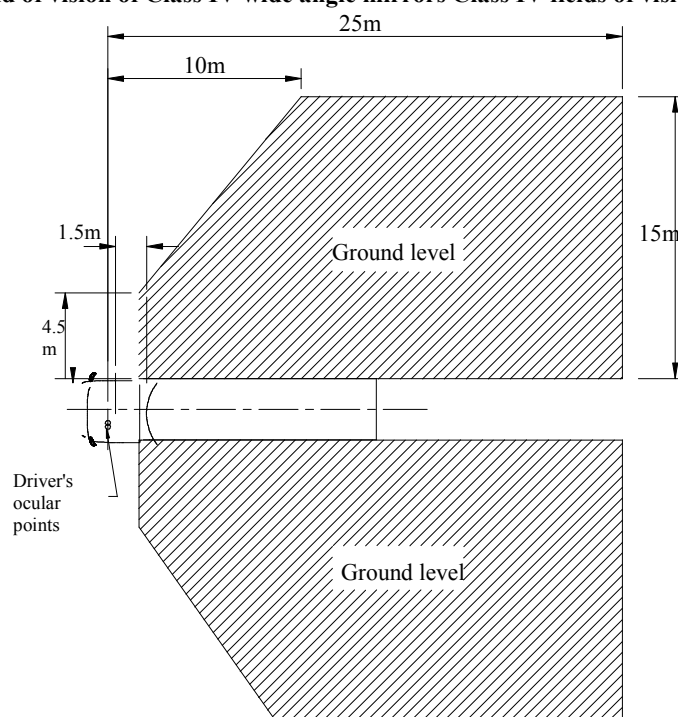

15.2.4.5. ~~"Close proximity" exterior mirror (Class V)~~ **Class V close-proximity view device**

The field of vision shall be such that the driver can see a flat horizontal portion of the road along the side of the vehicle, bounded by the following vertical planes (see Figures 8a and 8b):

- 15.2.4.5.1. The plane parallel to the median longitudinal vertical plane of the vehicle which passes through the outermost point of the vehicle cab on the passenger's side;
- 15.2.4.5.2. In the transverse direction, the parallel plane passing at a distance of 2 m in front of the plane mentioned in paragraph 15.2.4.5.1. above.
- 15.2.4.5.3. To the rear, the plane parallel to the vertical plane passing through the driver's ocular points and situated at a distance of 1.75 m behind that plane;
- 15.2.4.5.4. To the front, the plane parallel to the vertical plane passing through the driver's ocular points and situated at a distance of 1 m in front of that plane. If the vertical transverse plane passing through the leading edge of the vehicle bumper is less than 1 m in front of the vertical plane passing through the driver's ocular points, the field of vision shall be limited to that plane.
- 15.2.4.5.5. In case the field of vision described in Figures 8a and 8b can be perceived through the combination of the field of vision from a Class IV wide-angle ~~mirror~~ **view device** and that of a Class VI front-view ~~mirror~~ **device**, the installation of a Class V close-proximity ~~mirror~~ **view device** is not compulsory.

Figures 8a and 8b

**Field of vision of Class V close proximity mirror Class V field of vision**

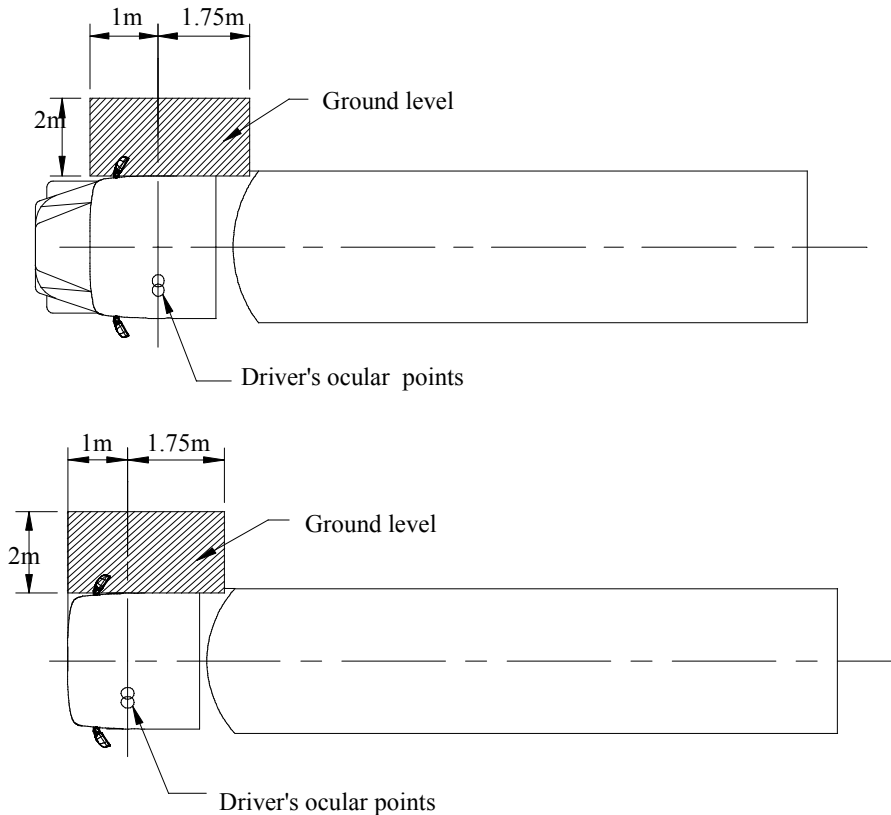

- 15.2.4.5.6. On the passenger side only, the field of vision shall also be such that the driver can see a flat horizontal portion of the road along the side of the vehicle which is outside the field defined in paragraphs 15.2.4.5.1. to 15.2.4.5.4. above but within the field bounded by the following vertical planes; the front of this field of vision may be rounded off with a radius of 2,000 mm (see Figures 8c and 8d):
- 15.2.4.5.7. In the transverse direction, the parallel plane passing at a distance of 4.5 m in front of the plane mentioned in paragraph 15.2.4.5.1. above.
- 15.2.4.5.8. To the rear, the plane parallel to the vertical plane passing through the driver's ocular points and situated at a distance of 1.75 m behind that plane.
- 15.2.4.5.9. To the front, the plane parallel to the vertical plane passing through the driver's ocular points and situated at a distance of 3 m in front of that plane. This field of vision may be partially provided by a front-view device ~~mirror~~ (Class VI).
- 15.2.4.5.10. The field of vision prescribed in paragraphs 15.2.4.5.6. to 15.2.4.5.9. above may be partially provided by a ~~"wide-angle" exterior mirror~~ **wide-angle view device** (Class IV) or a combination of a close-proximity ~~exterior mirror~~ **view device** (Class V) and a front ~~mirror-view device~~ (Class VI).
- 15.2.4.5.11. The area prescribed in paragraphs 15.2.4.5.6. to 15.2.4.5.9. above may be viewed using a combination of direct view and indirect vision devices (of Class IV, V, VI).
- 15.2.4.5.11.1. If an indirect vision device of Class IV is used to provide a part of the field of vision prescribed in paragraphs 15.2.4.5.6. to 15.2.4.5.9., it shall be adjusted

in a way that it simultaneously provides the field of vision prescribed in paragraph 15.2.4.4.2.

- 15.2.4.5.11.2. If an indirect vision device of Class V is used to provide a part of the field of vision prescribed in paragraphs 15.2.4.5.6. to 15.2.4.5.9., it shall be adjusted in a way that it simultaneously provides the field of vision prescribed in paragraphs 15.2.4.5.1. to 15.2.4.5.4.
- 15.2.4.5.11.3. If an indirect vision device of Class VI is used to provide a part of the field of vision prescribed in paragraphs 15.2.4.5.6. to 15.2.4.5.9., it shall be adjusted in a way that it simultaneously provides the field of vision prescribed in paragraph 15.2.4.6.1.
- 15.2.4.5.12. The field of vision prescribed in paragraphs 15.2.4.5.1. to 15.2.4.5.4. may be viewed using a combination of a close-proximity ~~exterior mirror~~ **view device** (Class V) and a "~~wide angle~~" ~~exterior mirror~~ **wide-angle view device** (Class IV).

In such cases the close-proximity ~~view exterior~~ mirror (Class V) shall provide at least 90 per cent of the field of vision prescribed in paragraphs 15.2.4.5.1 to 15.2.4.5.4. and the Class IV mirror shall be adjusted in a way that it simultaneously provides the field of vision prescribed in paragraph 15.2.4.4.2.

- 15.2.4.5.13. Paragraphs 15.2.4.5.6. to 15.2.4.5.12. above shall not apply to a vehicle where any part of ~~the a~~ Class V mirror, **if fitted**, or its holder, is less than 2.4 m above the ground, regardless of its position after adjustment.
- 15.2.4.5.14. Paragraphs 15.2.4.5.6. to 15.2.4.5. 12. above shall not apply to a vehicle of category M<sub>2</sub> or M<sub>3</sub>.

Figures 8c and 8d

**Larger field of vision on the passenger side**

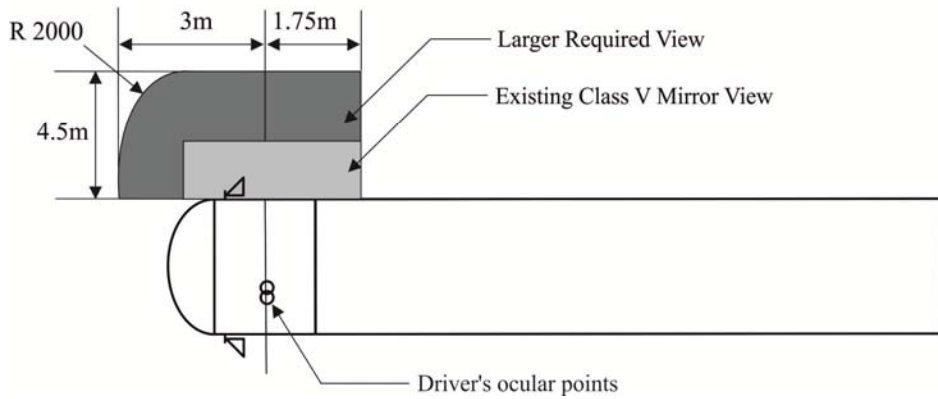
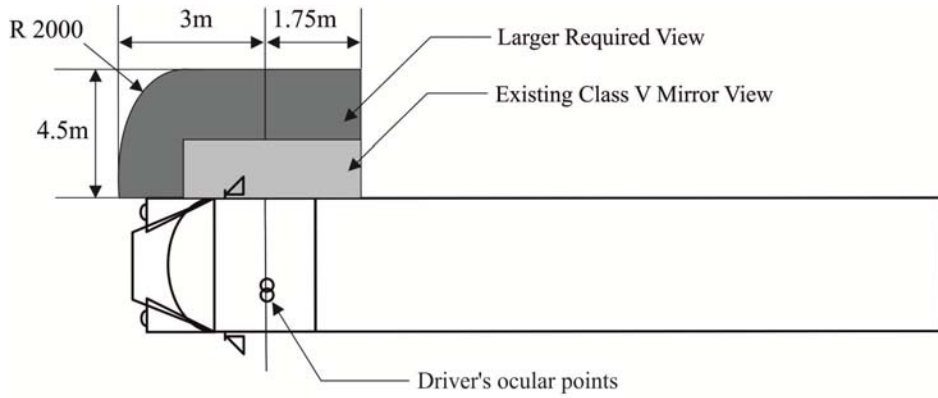

15.2.4.6. ~~Front mirror (Class VI)~~ **Class VI front-view device**

15.2.4.6.1. The field of vision shall be such that the driver can see at least a flat horizontal portion of the road, which is bounded by:

- (a) A transverse vertical plane through the outermost point of the front of the vehicle;
- (b) A transverse vertical plane 2,000 mm in front of the plane defined in (a);
- (c) A longitudinal vertical plane parallel to the longitudinal vertical median plane going through the outermost side of the vehicle at the driver's side; and
- (d) A longitudinal vertical plane parallel to the longitudinal vertical median plane 2,000 mm outside the outermost side of the vehicle opposite to the driver's side.

The front of this field of vision opposite to the driver's side may be rounded off with a radius of 2,000 mm (see Figure 9).

For the defined field of vision, see also paragraph 15.2.4.9.2. below.

The provisions for ~~front mirrors~~ **Class VI front-view devices** are compulsory for forward controlled (as defined in paragraph 12.5. of this Regulation) vehicles of categories  $N_2 > 7.5$  t and  $N_3$ .

If vehicles of these categories cannot fulfil the requirements by using a ~~front-view mirror or a camera/monitor device~~, a vision support system shall be

used. In the case of a vision support system this device shall be able to detect an object of 50 cm height and with a diameter of 30 cm within the field defined in Figure 9.

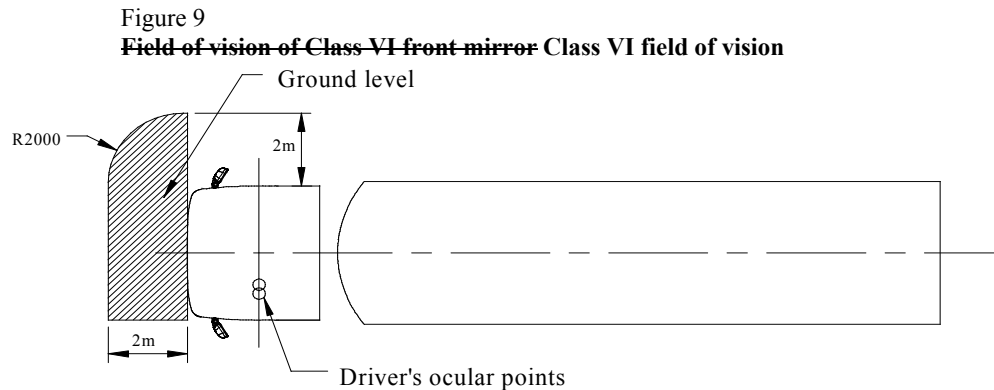

15.2.4.6.2. However, if the driver can see, taking into account the obstructions by the A-pillars, a straight line 300 mm in front of the vehicle at a height of 1,200 mm above the road surface and which is situated between a longitudinal vertical plane parallel to the longitudinal vertical median plane going through the outermost side of the vehicle at the driver's side and a longitudinal vertical plane parallel to the longitudinal vertical median plane 900 mm outside the outermost side of the vehicle opposite to the driver's side, a ~~front mirror of Class VI~~ **Class VI device for indirect vision** is not mandatory.

15.2.4.6.3. For the purpose of paragraphs 15.2.4.6.1. and 15.2.4.6.2. above parts permanently attached to the vehicle that are situated both above the driver's eye points and in front of the transverse vertical plane passing through the foremost surface of the vehicle's front bumper shall not be taken into account when defining the front of the vehicle.

15.2.4.7. ~~L-category mirror (Class VII)~~ **Class VII main rear-view mirror**

15.2.4.7.1. ~~Exterior rear-view mirror~~ **Main rear-view mirror** on the driver's side

The field of vision shall be such that the driver can see at least a 2.50 m wide, flat, horizontal portion of the road, which is bounded by a plane parallel to the median longitudinal vertical plane and passing through the outermost point of the vehicle on the driver's side of the vehicle and extends from 10 m behind the driver's ocular points to the horizon (see Figure 10).

15.2.4.7.2. ~~Exterior rear-view mirror~~ **Main rear-view mirror** on the passenger's side

The field of vision shall be such that the driver can see at least a 4 m wide flat, horizontal portion of the road which is bounded by a plane parallel to the median longitudinal vertical plane passing through the outermost point of the vehicle on the passenger's side and which extends from 20 m behind the driver's ocular points to the horizon (see Figure 10).

Figure 10  
Field of vision of Class VII mirrors-Class VII fields of vision

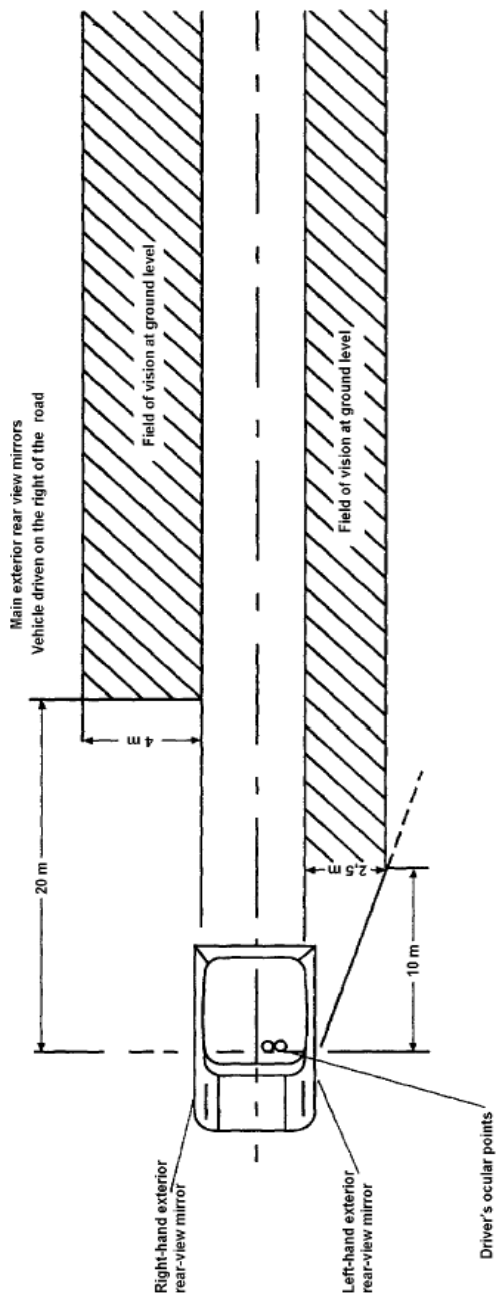

- 15.2.4.8. In the case of mirrors consisting of several reflecting surfaces which are either of different curvature or make an angle with each other, at least one of the reflecting surfaces shall provide the field of vision and have the dimensions (paragraph 6.1.2.1.2.2. of this Regulation) specified for the class to which they belong.
- 15.2.4.9. Obstructions
- 15.2.4.9.1. ~~Interior Class I rear-view devices mirror (Class I)~~
- The field of vision may be reduced by the presence of devices such as sun visors, windscreen wipers, heating elements and stop lamp of category S3, provided that all these devices together do not obscure more than 15 per cent of the prescribed field of vision. Headrests or framework or bodywork such as window columns of rear split doors, rear window frame shall be excluded from the calculation. This requirement shall be tested by projection on to a vertical plane at right angles to the longitudinal centre plane of the vehicle. The degree of obstruction shall be measured with the sun visors folded back.
- 15.2.4.9.2. ~~Exterior mirrors (Classes II, III, IV, V, and VI and VII) devices for indirect vision and Class VII mirrors~~
- In the fields of vision specified above, obstruction due to the bodywork and its components, such as other cab ~~mirrors-devices for indirect vision~~, door handles, outline marker lights, direction indicators and front and rear bumpers, as well as reflective-surface cleaning components, shall not be taken into account if they are responsible for a total obstruction of less than 10 per cent of the specified field of vision. In the case of a vehicle designed and constructed for special purposes where, due to its special features, it is not possible to meet this requirement, the obstruction of the required field of vision of a Class VI mirror caused by the special features may be more than 10 per cent but not more than necessary for its special function.
- 15.2.4.10. Test procedure
- The field of vision shall be determined by placing powerful light sources at the ocular points and examining the light reflected on the vertical monitoring screen. Other equivalent methods may be used.

## 16. Requirements for devices for indirect vision other than mirrors

### 16.1 Class I to IV camera-monitor devices (see Annex 12)

Unless otherwise provided in this Regulation, the definitions and symbols used in paragraph 16.1. are in accordance with ISO 16505:2015, Chapters 3 and 4.

Unless otherwise provided in this Regulation, the requirements given in paragraph 16.1. shall be verified according to the test procedures given in ISO 16505:2015, Chapter 7, where available.

#### 16.1.1. Intended use, activation and deactivation

The intended use shall be mentioned within the operator's manual. **The procedure for activation and deactivation of the CMS of class II and III shall allow a safe use of the vehicle.**

**The CMS shall be activated when the vehicle is opened (e.g. unlocking of the doors, opening of a front door or any other means by the choice of the manufacturer).**

**In addition to the requirements mentioned in paragraph 15.2.1.1.2., after each engine switch-off the system shall remain operational for a period of at least  $T1 = 120$  s. After  $T1$  period and for a period of at least  $T2 = (420 - T1)$  seconds the system shall be able to be reactivated such that the required field of vision is made available within 1 second by manoeuvring any front door opening automatically and, if available, manually by the driver. After  $T2$  period the system shall be able to be reactivated within 7 seconds (e.g. by initiating any front door opening process).**

**Notwithstanding the provisions above, any other concept to activate or deactivate the system shall be demonstrated to the satisfaction of the Technical Service within the safety concept that is provided according to the provisions in Annex 12, paragraph 2.**

**16.1.1.1. Default view**

In default view the CMS shall show the field of view at least as defined in paragraph 15.2.4., with at least the required magnification and resolution as defined in paragraph 16.1.3.

**In case of Mirror and CMS dual function system of class I, the CMS mode shall be set by the driver. Activation and deactivation device shall be located directly on the Mirror and CMS dual function system.**

**16.1.1.2. Luminance and contrast adjustment**

If manual adjustment is provided, the operator's manual shall provide information on how to change the luminance/contrast.

**16.1.1.3. Overlay requirements within the minimum required field of vision**

Overlays shall display only rearward driving-related visual information.

Only temporary overlays are allowed.

All overlays shall be considered as an obstruction regardless their transparency.

Each overlay shall not exceed 2.5 per cent of the required field of view displayed surface of the corresponding class.

The total surface of all obstructions shall not exceed the provision of paragraph 15.2.4.9.1. or 15.2.4.9.2. at the same time.

Overlay and any other obstruction surface shall be determined (for example on screenshots) taking into account the worst case(s).

**16.1.2. Operating readiness (System availability)**

Non-operation of the system shall be recognizable to the driver is (e.g. CMS failure by i.e. warning indication, display information, absence of status indicator). The information for the driver shall be explained in the operator's manual.

**16.1.3. Magnification and resolution**

**16.1.3.1. Magnification factor**

The minimum and the average magnification factors of the CMS, in both horizontal and vertical direction shall not be lower than the minimum average magnification factor indicated below.

The minimum magnification factor shall not be less than:

- (a) for Class I: 0.31,



- (b) for Class II (drivers side): 0.26,
- (c) for Class III (drivers side): 0.29,
- (d) for Class IV (drivers side): 0.054,
- (e) for Class II (passengers side): 0.13,
- (f) for Class III (passengers side): 0.19,
- (g) for Class IV (passengers side): 0.016.

The average magnification factor shall not be less than:

- (h) for Class I: 0.33,
- (i) for Class II (drivers side): 0.31,
- (j) for Class III (drivers side): 0.31,
- (k) for Class IV (drivers side): 0.091,
- (l) for Class II (passengers side): 0.16,
- (m) for Class III (passengers side): 0.20,
- (n) for Class IV (passengers side): 0.046.

#### 16.1.3.2. Resolution (MTF)

The resolution (MTF) defines the minimum distinguishable details observable in an image as is represented by the MTF10. For reasons of simplicity the requirement is defined assuming an aspect ratio of 1:1.

Resolution MTF10, at the centre of the monitor defined size shall fulfil the following requirements:

$$MTF10_{(1:1)/hor} \geq MTF10_{MIN(1:1)/hor}, \text{ in horizontal direction,}$$

$$MTF10_{(1:1)/ver} \geq MTF10_{MIN(1:1)/ver}, \text{ in vertical direction.}$$

Resolution MTF10, at the corner measurement points as illustrated in the figure below shall fulfil the following requirements:

$$MTF10_{(1:1)/hor} \geq \frac{1}{2} MTF10_{MIN(1:1)/hor}, \text{ in horizontal direction,}$$

$$MTF10_{(1:1)/ver} \geq \frac{1}{2} MTF10_{MIN(1:1)/ver}, \text{ in vertical direction,}$$

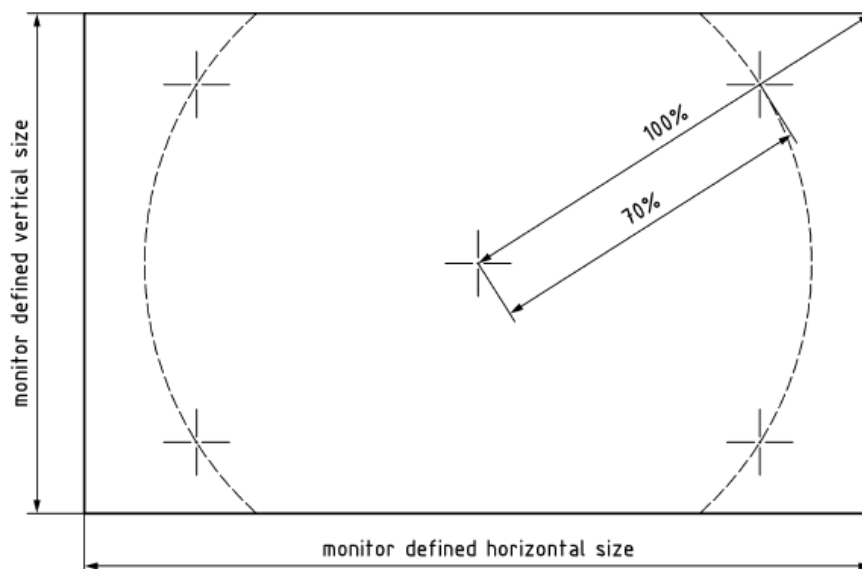

**16.1.4 Magnification aspect ratio**

In the required field of view, the difference between the average magnification factor for horizontal and vertical direction of a CMS shall satisfy the following equations depending on the individual mirror classes.

For devices Class I the acceptable range shall be:

$$-0,34 \leq 1 - \frac{M_{system/hor/avg}}{M_{system/ver/avg}} \leq 0,25$$

For devices Class II the acceptable range shall be:

$$-0,42 \leq 1 - \frac{M_{system/hor/avg}}{M_{system/ver/avg}} \leq 0,3$$

For devices Class III the acceptable range shall be:

$$-0,34 \leq 1 - \frac{M_{system/hor/avg}}{M_{system/ver/avg}} \leq 0,25$$

For devices Class IV no restriction in magnification ratio is required.

**16.1.5. Monitor inside the vehicle**

**16.1.5.1.** The centre of the monitor(s) shall not be below a plane passing through the driver's ocular points, as defined in paragraph 12.1., and declined 30° below.

**16.1.5.2.** The arrangement of the monitor(s) inside the vehicle shall be convenient to the driver.

Thus, the image of the right side field of view shall be presented to the right of the longitudinal vertical plane through the ocular reference

point, defined in paragraph 12.6. The image of the left side field of view shall be presented to the left of the longitudinal vertical plane through the ocular reference point.

If the CMS shows more than one field of vision on one display, non-continuous images shall be clearly separated from each other. Provided that the required field of vision of different classes of devices for indirect vision are shown on the monitor(s) without hiding any part of the required field of vision, a combined continuous image without clear separation is allowed.

**16.1.5.3.** The monitor defined size shall be visible without any obstruction from the ocular reference point. A virtual testing is acceptable.

**16.1.6.** Obstruction of the driver's direct view caused by the installation of a device for indirect vision shall be restricted to a minimum.

**16.1.7.** Decreasing accommodation

The installation of the monitor inside the vehicle should follow the needs of the intended user group. The operator's manual shall provide information on the decreasing capacity of the human being to accommodate and shall recommend suitable assistance to the user needs.

**16.1.8.** Safety of electronic systems for indirect vision

The requirements to be applied to the safety aspects of electronic systems for indirect vision are given in Annex 12, paragraph 2.

~~15.3.16.2.~~ **16.2.** Devices for indirect vision other than mirrors Class V and VI camera-monitor devices

~~15.3.1.~~**16.2.1.** A device for indirect vision shall give such performances that a critical object can be observed by the driver over the entire required field of vision, taking into account the critical perception according the procedure of Annex 10.

Alternatively, the determination of the displayed object size shall be performed according to Annex 11.

~~15.3.2.~~**16.2.2.** Obstruction of the driver's direct view caused by the installation of a device for indirect vision shall be restricted to a minimum.

~~15.3.3.~~ (Reserved)

~~15.3.4.~~**16.2.3.** Installation requirements for the monitor

The viewing direction of the monitor shall roughly be the same direction as the one for the main mirror.

~~15.3.5.~~**16.2.4.** Vehicles may be equipped with additional devices for indirect vision.

~~15.3.6.~~**16.2.5.** The provisions of this Regulation do not apply to the surveillance camera-monitor-recording devices defined in paragraph ~~2.3.2.1.2.13.~~ of this Regulation. Exterior surveillance cameras either shall be mounted at least 2 m above the ground when the vehicle is under a load corresponding to its maximum technical permissible mass, or, if their lower edge is less than 2 m from the ground, shall not project more than 50 mm beyond the overall width of the vehicle measured without this device and have a radii of curvature of not less than 2.5 mm.

## ~~16~~17. Modifications of the vehicle type and extension of approval

~~16~~17.1. Every modification of the vehicle type shall be notified to the Type Approval Authority which approved the vehicle type. Type Approval Authority shall then either:

- (a) Decide, in consultation with the manufacturer, that a new type approval is to be granted, or
- (b) Apply the procedure contained in paragraph ~~16.1.1~~17.1.1. (Revision) and, if applicable, the procedure contained in paragraph ~~16.1.2~~17.1.2. (Extension).

~~16~~17.1.1. Revision<sup>1</sup>

When particulars recorded in the information folder have changed and the Type Approval Authority considers that the modifications made are unlikely to have an appreciable adverse effect, and that in any case the vehicle still complies with the requirements, the modification shall be designated a "revision".

In such a case, the Type Approval Authority shall issue the revised pages of the information folder as necessary, marking each revised page to show clearly the nature of the modification and the date of re-issue. A consolidated, updated version of the information folder, accompanied by a detailed description of the modification, shall be deemed to meet this requirement.

~~16~~17.1.2. Extension<sup>1</sup>

The modification shall be designated an "extension" if, in addition to the change of the particulars recorded in the information folder,

- (a) Further inspections or tests are required, or
- (b) Any information on the communication document (with the exception of its attachments) has changed, or
- (c) Approval to a later series of amendments is requested after its entry into force.

~~16~~17.2. Confirmation or refusal of approval, specifying the alterations, shall be communicated to the Parties to the Agreement which apply this Regulation by means of a form conforming to the model in Annex 4 to this Regulation. In addition, the index to the information package, attached to the communication document, shall be amended accordingly to show the date of the most recent revision or extension.

~~16~~17.3. The Type Approval Authority issuing the extension of approval shall assign a series number to each communication form drawn up for such an extension.

## ~~17~~18. Conformity of production

~~17~~18.1. The conformity of production procedure shall comply with those set out in the Agreement, Appendix 2, (E/ECE/324-E/ECE/TRANS/505/Rev.2).<sup>2</sup>

<sup>1</sup> Note by the secretariat: The provisions on revisions and extensions of type approvals shall only refer to new Schedule 3 of draft Revision 3 to the 1958 Agreement.

- ~~17~~18.2. Every vehicle approved under this Regulation shall be so manufactured as to conform to the type-approved by meeting the requirements set out in paragraph 15., **and where applicable paragraph 16.** above.

## ~~18~~19. Penalties for non-conformity of production

- ~~18~~19.1. The approval granted in respect of a vehicle type pursuant to this Regulation may be withdrawn if the requirement laid down in paragraph ~~18.147.1.~~ above is not complied with or if the vehicle fails to pass the checks prescribed in paragraph ~~18.2.17.2~~ above.
- ~~18~~19.2. If a Party to the Agreement which applies this Regulation withdraws an approval it has previously granted, it shall forthwith so notify the other Contracting Parties applying this Regulation by means of a copy of the approval form bearing at the end, in large letters, the signed and dated annotation "APPROVAL WITHDRAWN".

## ~~19~~20. Production definitively discontinued

If the holder of the approval completely ceases to manufacture a type of vehicle approved in accordance with this Regulation, he shall so inform the Authority which granted the approval. Upon receiving the relevant communication, the Authority shall inform thereof the other Parties to the Agreement applying this Regulation by means of a copy of the approval form bearing at the end, in large letters, the signed and dated annotation "PRODUCTION DISCONTINUED".

## ~~20~~21. Names and addresses of Technical Services responsible for conducting approval tests, and of **Type Approval Authorities**

The Parties to the Agreement applying this Regulation shall communicate to the United Nations Secretariat the names and addresses of the Technical Services responsible for conducting approval tests and of the Type Approval Authorities which grant approval and to which forms certifying approval or refusal or extension or withdrawal of approval, issued in other countries, are to be sent.

## ~~21~~22. **Transitional provisions**

- ~~21~~22.1. As from the official date of entry into force of the 03 series of amendments to this Regulation, no Contracting Party applying this Regulation shall refuse an application for approval under this Regulation as amended by the 03 series of amendments.
- ~~21~~22.2. As from 12 months after entry into force of the 03 series of amendments to this Regulation, Contracting Parties applying this Regulation shall grant approvals to a type of device for indirect vision only if the type meets the requirements of this Regulation as amended by the 03 series of amendments.

<sup>2</sup> Note by the secretariat: The provisions on conformity of production shall refer to new Schedule 1 of draft Revision 3 to the 1958 Agreement.

- ~~2122.3.~~ As from 18 months after entry into force of the 03 series of amendments to this Regulation, Contracting Parties applying this Regulation shall grant approvals to a type of vehicle with regard to the installation of devices for indirect vision only if the type of vehicle meets the requirements of this Regulation as amended by the 03 series of amendments.
- ~~2122.4.~~ As from 24 months after entry into force of the 03 series of amendments to this Regulation, Contracting Parties applying this Regulation may refuse to recognize approvals of a type of vehicle with regard to the installation of a camera-monitor ~~system device~~ for indirect vision or type of camera-monitor ~~system device~~ for indirect vision which have not been granted in accordance with the 03 series of amendments to this Regulation.
- ~~2122.5.~~ As from 26 January 2010 for vehicles of category M<sub>1</sub> and N<sub>1</sub> and from 26 January 2007 for vehicles of other categories, Contracting Parties applying this Regulation may refuse to recognize approvals of a device for indirect vision which have not been granted in accordance with the 02 series of amendments to this Regulation.
- ~~2122.6.~~ Approvals which were granted to devices for indirect vision of Class I or III pursuant to this Regulation in its original form (00 series) or modified by the 01 or 02 series of amendments before the date of entry into force of the 03 series of amendments shall remain valid and Contracting Parties shall continue to accept them. Contracting Parties shall not refuse to grant extensions to approvals granted to the original version, the 01 or 02 series of amendments.
- ~~2122.7.~~ Notwithstanding the provisions of paragraph ~~2122.2.~~, approvals which were granted to mirrors of Class II, IV, V, VI or VII pursuant to this Regulation as modified by the 02 series of amendments before the date of entry into force of the 03 series of amendments shall remain valid and Contracting Parties shall continue to accept them. Contracting Parties shall not refuse to grant extensions to approvals granted to the 02 series of amendments.
- ~~2122.8.~~ The provisions of this Regulation shall not prohibit the approval of a type of vehicle with regard to the mounting of devices for indirect vision pursuant to this Regulation as modified by the 03 series of amendments, if all or part of the devices for indirect vision of Class I or III, with which it is fitted, bear the approval mark prescribed by this Regulation in its original form (00 series) or modified by the 01 or 02 series of amendments.
- ~~2122.9.~~ The provisions of this Regulation shall not prohibit the approval of a type of vehicle with regard to the mounting of devices for indirect vision pursuant to this Regulation as modified by the 03 series of amendments, if all or part of the rear-view mirrors of Class II, IV, V, VI or VII, with which it is fitted, bear the approval mark prescribed by the 02 series of amendments of this Regulation.
- ~~2122.10.~~ Notwithstanding the provisions of paragraphs ~~2122.2.~~, ~~2122.4.~~ and ~~2122.5.~~ above, for the purpose of replacement parts Contracting Parties applying this Regulation shall continue to grant approvals according 02 series of amendments to this Regulation, to devices for indirect vision for use on vehicle types which have been approved before the date mentioned in paragraph ~~2122.2.~~ above pursuant to the 02 series of amendments of Regulation No. 46, and, where applicable, subsequent extensions to these approvals.
- ~~2122.11.~~ As from the official date of entry into force of the 04 series of amendments to this Regulation, no Contracting Party applying this Regulation shall refuse an

- application for approval under this Regulation as amended by the 04 series of amendments.
- ~~21~~22.12. As from 30 June 2014, Contracting Parties applying this Regulation shall grant approvals to a type of device for indirect vision only if the type of device meets the requirements of this Regulation as amended by the 04 series of amendments.
- ~~21~~22.13. As from 30 June 2014, Contracting Parties applying this Regulation shall grant approvals to a type of vehicle with regard to the installation of devices for indirect vision only if the type of vehicle meets the requirements of this Regulation as amended by the 04 series of amendments.
- ~~21~~22.14. As from 30 June 2015, Contracting Parties applying this Regulation shall not be obliged to accept approvals of a type of vehicle or type of device for indirect vision which have not been granted in accordance with the 04 series of amendments to this Regulation.
- ~~21~~22.15. Notwithstanding paragraph ~~21.15~~**22.14.** above, type approvals granted to the preceding series of amendments to the Regulation, which are not affected by the 04 series of amendments, shall remain valid and Contracting Parties applying this Regulation shall continue to accept them.
- ~~21~~22.16. Contracting Parties applying this Regulation shall not refuse to grant extensions of type approvals for existing types of vehicles or devices, which are not affected by the 04 series of amendments, granted according to the 02 or 03 series of amendments to this Regulation.
- ~~21~~22.17. Notwithstanding the provisions of paragraphs ~~21.2., 21.4., 21.5., 21.13. and 21.15.~~ **22.2., 22.4., 22.5., 22.13. and 22.15.** above, for the purpose of replacement parts, Contracting Parties applying this Regulation shall continue to grant approvals according to the 01 series of amendments to this Regulation, to devices for indirect vision of Classes I to V for use on vehicle types which have been approved before 26 January 2006 pursuant to the 01 series of amendments of Regulation No. 46 and, where applicable, subsequent extensions to these approvals.

## Annex 1

### Information document for type approval of a device for indirect vision

The following information, if applicable, shall be supplied in triplicate and shall include a list of contents.

Any drawings shall be supplied in appropriate scale and in sufficient detail on size A4 paper or on a folder of A4 format.

Photographs, if any, shall show sufficient details.

1. Make (trade name of manufacturer): .....
2. Type and general commercial description(s): .....
3. Means of identification of the type, if indicated on the device: .....
4. Category of vehicle for which the device is intended: .....
5. Name and address of manufacturer: .....
6. Location and method of affixing of the approval mark: .....
- 6.1. Other mean of identification link to the approval mark: .....**
7. Address(es) of assembly plant(s): .....
8. Mirrors (state for each mirror): .....
- 8.1. Variant .....
- 8.2. Drawing(s) for the identification of the mirror: .....
- 8.3. Details of the method of attachment: .....
9. Devices for indirect vision other than mirrors:.....
- 9.1. Type and characteristics (such as a complete description of the device): .....
- 9.1.1. In the case of camera-monitor device systems **of classes V and VI, the class,** the detection distance (mm), contrast, luminance range, glare correction, display performance (black and white/colour) image repetition frequency, luminance reach of the monitor: .....
- 9.1.2. In the case of camera-monitor systems of classes I to IV, the class, field of view, magnification and resolution: .....**
- 9.2. Sufficiently detailed drawings to identify the complete device including installation instructions; the position for the type-approval mark has to be indicated on the drawings: .....



## Annex 2

### Information document for type-approval of a vehicle with respect to the installation of devices for indirect vision

The following information, if applicable, shall be supplied in triplicate and include a list of contents.

Any drawings shall be supplied in appropriate scale and in sufficient detail on size A4 paper or on a folder of A4 format.

Photographs, if any, shall show sufficient details.

#### General

1. Make (trade name of manufacturer):.....
2. Type and general commercial description(s): .....
3. Means of identification of type, if marked on the vehicle:.....
4. Location of that marking: .....
5. Category of vehicle:.....
6. Name and address of manufacturer:.....
7. Address(es) of assembly plant(s): .....

#### General construction characteristics of the vehicle

8. Photograph(s) and/or drawing(s) of a representative vehicle:.....
9. Driving cab (forward control or bonneted)<sup>1</sup>:.....
10. Driving position: left/right<sup>1</sup> .....
- 10.1. The vehicle is equipped to be driven in right-hand/left hand traffic<sup>1</sup>.....
11. Range of vehicle dimensions (overall):.....
- 11.1 For chassis without bodywork.....
- 11.1.1. Width<sup>2</sup>: .....
- 11.1.1.1. Maximum permissible width: .....
- 11.1.1.2. Minimum permissible width: .....

<sup>1</sup> Delete where not applicable

<sup>2</sup> "Overall width" of a vehicle means a dimension which is measured according to ISO standard 612-1978, term No. 6.2. In case of vehicles of category other than M<sub>1</sub>, in addition to the provisions of that standard, when measuring the vehicle width the following devices shall not be taken into account:

- (a) customs sealing devices and their protection,
- (b) devices for securing the tarpaulin and their protection,
- (c) tyre failure tell-tale devices,
- (d) protruding flexible parts of a spray-suppression system,
- (e) lighting equipment,
- (f) for buses, access ramps in running order, lifting platforms and similar equipment in running order provided that they do not exceed 10 mm from the side of the vehicle and the corners of the ramps facing forwards or rearwards are rounded to a radius of not less than 5 mm; the edges shall be rounded to a radius of not less than 2.5 mm,
- (g) devices for indirect vision,
- (h) tyre-pressure indicators,
- (i) retractable steps,
- (j) the deflected part of the tyre walls immediately above the point of contact with the ground.

11.2.	For chassis with bodywork: .....
11.2.1.	Width <sup>2</sup> .....
12.	Bodywork
12.1.	Devices for indirect vision
12.1.1.	Mirrors .....
12.1.1.1.	Drawing(s) showing the position of the mirror relative to the vehicle structure: .....
12.1.1.2.	Details of the method of attachment including that part of the vehicle structure to which it is attached: .....
12.1.1.3.	Optional equipment which may affect the rearward field of vision: .....
12.1.1.4.	A brief description of the electronic components (if any) of the adjustment device: .....
12.1.2.	Devices for indirect vision other than mirrors: .....
12.1.2.1.	Sufficiently detailed drawings with the installation instructions: .....
<b>12.1.2.2.</b>	<b>In the case of camera-monitor system of classes I to IV: .....</b>
<b>12.1.2.2.1.</b>	<b>Drawing(s)/photograph(s) showing the position of the camera(s) relative to the vehicle structure: .....</b>
<b>12.1.2.2.2.</b>	<b>Drawing(s)/photograph(s) showing the arrangement of the monitor(s) including surrounding interior parts: .....</b>
<b>12.1.2.2.3.</b>	<b>Drawing(s)/photograph(s) showing the drivers view onto the monitor(s): .....</b>
<b>12.1.2.2.4.</b>	<b>Drawing(s)/photograph(s) showing the setup and monitor image of the required field of view: .....</b>
<b>12.1.2.2.5.</b>	<b>Details of the method of attachment of the camera-monitor device(s) including that part of the vehicle structure to which it is attached: .....</b>
<b>12.1.2.2.6.</b>	<b>Optional equipment which may affect the rearward field of vision: .....</b>
<b>12.1.2.2.7.</b>	<b>A brief description of the electronic components (if any) of the adjustment device: .....</b>
<b>12.1.2.2.8.</b>	<b>A technical specification and operator's manual of the camera-monitor system according to ISO 16505:2015: .....</b>

## Annex 3

### Communication

(Maximum format: A4 (210 x 297 mm))

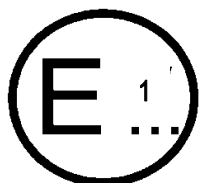

issued by :

Name of administration:

.....  
 .....  
 .....

1

concerning<sup>2</sup>:

- Approval granted
- Approval extended
- Approval refused
- Approval withdrawn
- Production definitively discontinued

of a type of device for indirect vision pursuant to Regulation No. 46

Approval No..... Extension No. ....

1. Trade name or mark of device: .....
  2. Manufacturer's name for the type of device: .....
  3. Manufacturer's name and address: .....
  4. If applicable, name and address of manufacturer's representative:.....
  5. Submitted for approval on: .....
  6. Technical Service responsible for conducting approval tests: .....
  7. Date of report issued by that Service .....
  8. Number of report issued by that Service .....
  9. Brief description .....
- Identification of the device: mirror, camera/monitor, other device<sup>2</sup>  
 Device for indirect vision of Classes I, II, III, IV, V, VI, S<sup>2</sup>  
 Symbol  $\frac{\Delta}{2m}$  as defined in paragraph 6.3.1.1. of this Regulation: yes/no<sup>2</sup>
10. Position of the approval mark: .....
  11. Reason(s) for extension (if applicable):.....
  12. Approval granted/refused/extended/withdrawn<sup>2</sup>:
  13. Place: .....
  14. Date:.....
  15. Signature:.....

<sup>1</sup> Distinguishing number of the country which has granted/extended/refused/withdrawn approval (see approval provisions in the Regulations).

<sup>2</sup> Strike out what does not apply.

16. The list of documents deposited with the Type Approval Authority which has granted approval is annexed to this communication and may be obtained on request.

**Annex 4**

**Communication**

(Maximum format: A4 (210 x 297 mm))



issued by :

Name of administration:

.....  
 .....  
 .....

1

- concerning<sup>2</sup>:
- Approval granted
  - Approval extended
  - Approval refused
  - Approval withdrawn
  - Production definitively discontinued

of a type of vehicle with regard to the mounting of devices for indirect vision pursuant to Regulation No. 46

Approval number: ..... Extension No.: .....

1. Make (trade name of manufacturer): .....
2. Type and general commercial description(s).....
3. Means of identification of type, if marked on the vehicle: .....
- 3.1. Location of that marking:.....
4. Category of vehicle: (M<sub>1</sub>, M<sub>2</sub>, M<sub>3</sub>, N<sub>1</sub>, N<sub>2</sub> ≤ 7.5t, N<sub>2</sub> > 7.5t, N<sub>3</sub>)<sup>2</sup>
5. Name and address of manufacturer: .....
6. Address(es) of the production plant(s).....
7. Additional information: (where applicable). See appendix
8. Technical Service responsible for carrying out the tests:.....
9. Date of test report:.....
10. Number of test report: .....
11. Remarks: (if any). See appendix
12. Place: .....
13. Date:.....
14. Signature:.....
15. The index to the information package lodged with the Type Approval Authority, which may be obtained on request is attached.

<sup>1</sup> Distinguishing number of the country which has granted/extended/refused/withdrawn approval (see approval provisions in the Regulations).

<sup>2</sup> Strike out what does not apply.

## Annex 4 – Appendix

Appendix to type approval communication form No. .... concerning the type approval of a vehicle with regard to the mounting of devices for indirect vision under Regulation No. 46

1. Trade name or mark of mirrors and supplementary devices for indirect vision and component type-approval number: .....
2. Class(es) of mirrors and devices for indirect vision (I, II, III, IV, V, VI, VII, S)<sup>1</sup>
3. Extension of type approval of the vehicle to cover the following device for indirect vision .....
4. Data for identification of the R point of the driver's seating position: .....
5. Maximum and minimum bodywork width in respect of which the mirror and the devices for indirect vision has been granted type-approval (in the case of chassis/cab referred to in paragraph 15.2.2.3. of this Regulation) .....
6. The following documents, bearing the type approval number shown above, are annexed to this certificate:.....
  - (a) Drawings showing the mounting of the devices for indirect vision .....
  - (b) Drawings and plans showing the mounting position and characteristics of the part of the structure where the devices for indirect vision are mounted.....
7. Remarks: (e.g. valid for right hand/left hand traffic<sup>1</sup>) .....

---

<sup>1</sup> Strike out what does not apply.

## Annex 5

### Arrangement of approval mark of a device for indirect vision

(See paragraph 5.4. of the Regulation)

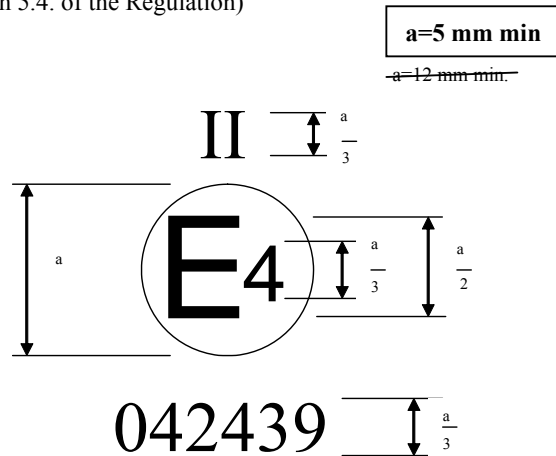

The above approval mark affixed to a device for indirect vision indicates that the ~~device mirror~~ is a **main rear view mirror device**, of Class II, which has been approved in the Netherlands (E4) pursuant to Regulation No. 46 and under approval number 042439. The first two digits of the approval number indicate that Regulation No. 46 already included the 04 series of amendments when the approval was granted.

*Note:* The approval number and the additional symbol shall be placed close to the circle and either above or below the "E" or to the left or right of that letter. The digits of the approval number shall be on the same side of the "E" and point in the same direction. The additional symbol shall be directly opposite the approval number. The use of Roman numerals as approval numbers shall be avoided so as to prevent any confusion with other symbols.

## Annex 6

### Test method for determining reflectivity

1. Definitions
  - 1.1. CIE standard illuminate A<sup>1</sup>: Colorimetric illuminate, respecting the full radiator at  $T_{68} = 2,855.6$  K.
    - 1.1.2. CIE standard source A<sup>1</sup>: Gas-filled tungsten filament lamp operating at a correlated colour temperature of  $T_{68} = 2,855.6$  K.
    - 1.1.3. CIE 1931 standard colorimetric observer<sup>1</sup>: Receptor of radiation whose colorimetric characteristics correspond to the spectral tristimulus values (see  $\bar{x}(\lambda)$ ,  $\bar{y}(\lambda)$ ,  $\bar{z}(\lambda)$  table).
    - 1.1.4. CIE spectral tristimulus values<sup>1</sup>: Tristimulus values of the spectral components of an equi energy spectrum in the CIE (XYZ) system.
    - 1.1.5. Photopic vision<sup>1</sup>: Vision by the normal eye when it is adapted to levels of luminance of at least several  $\text{cd/m}^2$ .
  2. Apparatus
    - 2.1. General
 

The apparatus shall consist of a light source, a holder for the test sample, a receiver unit with a photodetector and an indicating meter (see Figure 1), and means of eliminating the effects of extraneous light.

The receiver may incorporate a light-integrating sphere to facilitate measuring the reflectance of non-flat (convex) mirrors (see Figure 2).
    - 2.2. Spectral characteristics of light source and receiver
 

The light source shall consist of a CIE standard source A and associated optics to provide a near-collimated light beam. A voltage stabiliser is recommended in order to maintain a fixed lamp voltage during instrument operation.

The receiver shall have a photodetector with a spectral response proportional to the photopic luminosity function of the CIE (1931) standard colorimetric observer (see table). Any other combination of illuminate-filter-receptor giving the overall equivalent of CIE standard illuminate A and photopic vision may be used. When an integrating sphere is used in the receiver, the interior surface of the sphere shall be coated with a matt (diffusive) spectrally non-selective white coating.
    - 2.3. Geometrical conditions
 

The angle of the incident beam ( $\Theta$ ) should preferably be  $0.44 \pm 0.09$  rad ( $25 \pm 5^\circ$ ) from the perpendicular to the test surface and shall not exceed the upper limit of the tolerance (i.e.  $0.53$  rad or  $30^\circ$ ). The axis of the receptor shall make an angle ( $\Theta$ ) with this perpendicular equal to that of the incident beam (see Figure 1). The incident beam upon arrival at the test surface shall have a diameter of not less than  $13$  mm ( $0.5$  inch). The reflected beam shall not be wider than the sensitive area of the photodetector, shall not cover less than  $50$

<sup>1</sup> Definitions taken from CIE publication 50 (45), International Electrotechnical Vocabulary, Group 45, Lighting



per cent of such area, and as nearly as possible shall cover the same area segment as used during instrument calibration.

When an integrating sphere is used in the receiver section, the sphere shall have a minimum diameter of 127 mm (5 inch). The sample and incident beam apertures in the sphere wall shall be of such a size as to admit the entire incident and reflected light beams. The photodetector shall be so located as not to receive direct light from either the incident or the reflected beam.

2.4. Electrical characteristics of the photodetector-indicator unit

The photodetector output as read on the indicating meter shall be a linear function of the light intensity of the photosensitive area. Means (electrical and/or optical) shall be provided to facilitate zeroing and calibration adjustments. Such means shall not affect the linearity or the spectral characteristics of the instrument. The accuracy of the receptor indicator unit shall be within  $\pm 2$  per cent of full scale, or  $\pm 10$  per cent of the magnitude of the reading, whichever is the smaller.

2.5. Sample holder

The mechanism shall be capable of locating the test sample so that the axes of the source arm and receptor intersect at the reflecting surface. The reflecting surface may lie within or at either face of the mirror sample, depending on whether it is a first surface, second surface or prismatic "flip" type mirror.

3. Procedure

3.1. Direct calibration method

In the direct calibration method, air is used as the reference standard. This method is applicable for those instruments, which are so constructed as to permit calibration at the 100 per cent point by swinging the receiver to a position directly on the axis of the light source (see Figure 1).

It may be desired in some cases (such as when measuring low-reflectivity surfaces) to use an intermediate calibration point (between 0 and 100 per cent on the scale) with this method. In these cases, a neutral density filter of known transmittance shall be inserted in the optical path, and the calibration control shall then be adjusted until the meter reads the percentage transmission of the neutral density filter. This filter shall be removed before reflectivity measurements are performed.

3.2. Indirect calibration method

The indirect calibration method is applicable in the case of instruments with fixed source and receiver geometry. A properly calibrated and maintained reflectance standard is required. This reference standard should preferably be a flat mirror with a reflectance value as near as possible to that of the test samples.

3.3. Flat mirror measurement

The reflectance of flat mirror samples can be measured on instruments employing either the direct or the indirect calibration method. The reflectance value is read directly from the indicating meter.

3.4. Non-flat (convex) mirror measurement

Measurement of the reflectance of non-flat (convex) mirrors requires the use of instruments which incorporate an integrating sphere in the receiver unit (see Figure 2). If the instrument-indicating meter indicates  $n_e$  divisions with a standard mirror of E per cent reflectance, then, with a mirror of unknown reflectance,  $n_x$  divisions will correspond to a reflectance of X per cent, in accordance with the formula:

$$X = E \frac{n_x}{n_e}$$

Figure 1  
Generalised reflectometer showing experimental set-ups for the two calibration methods

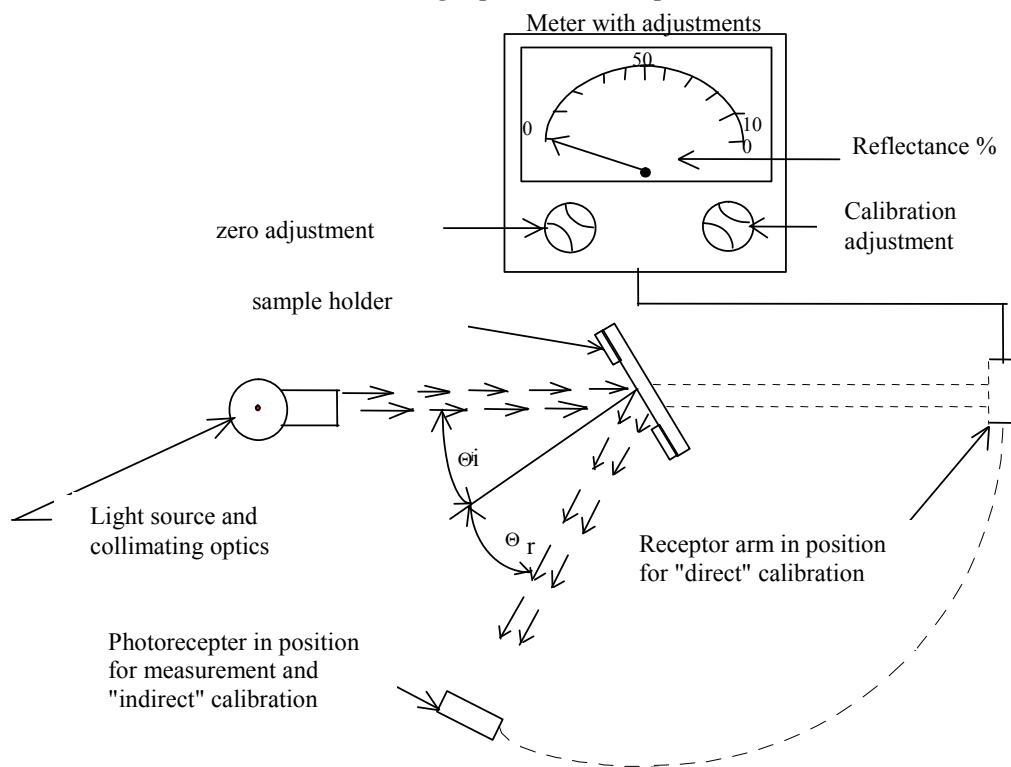
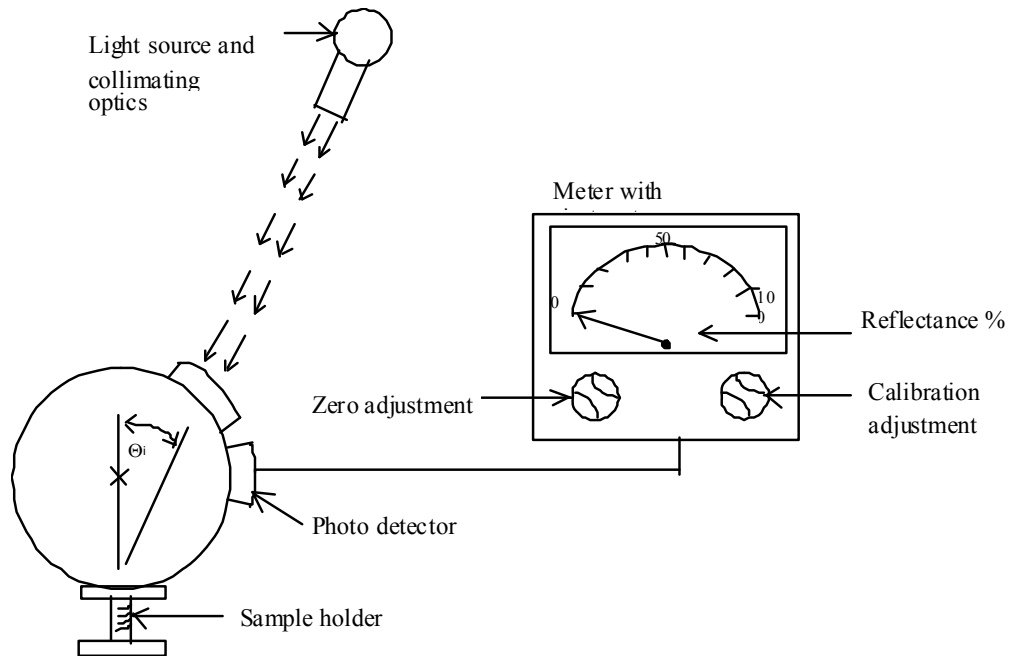

Figure 2  
**Generalised reflectometer, incorporating an integrating sphere in the receiver**



4. Spectral tristimulus values for the CIE 1931 standard colorimetric observer<sup>2</sup>

This table is taken from CIE publication 50 (45) (1970)

$\lambda$ nm	$\bar{x}(\lambda)$	$\bar{y}(\lambda)$	$\bar{z}(\lambda)$
380	0.001 4	0.000 0	0.006 5
390	0.004 2	0.000 1	0.020 1
400	0.014 3	0.000 4	0.067 9
410	0.043 5	0.001 2	0.207 4
420	0.134 4	0.004 0	0.645 6
430	0.283 9	0.011 6	1.385 6
440	0.348 3	0.023 0	1.747 1
450	0.336 2	0.038 0	1.772 1
460	0.290 8	0.060 0	1.669 2
470	0.195 4	0.091 0	1.287 6
480	0.095 6	0.139 0	0.813 0
490	0.032 0	0.208 0	0.465 2
500	0.004 9	0.323 0	0.272 0
510	0.009 3	0.503 0	0.158 2
520	0.063 3	0.710 0	0.078 2
530	0.165 5	0.862 0	0.042 2
540	0.290 4	0.954 0	0.020 3
550	0.433 4	0.995 0	0.008 7
560	0.594 5	0.995 0	0.003 9
570	0.762 1	0.952 0	0.002 1
580	0.916 3	0.870 0	0.001 7
590	1.026 3	0.757 0	0.001 1
600	1.062 2	0.631 0	0.000 8
610	1.002 6	0.503 0	0.000 3
620	0.854 4	0.381 0	0.000 2
630	0.642 4	0.265 0	0.000 0
640	0.447 9	0.175 0	0.000 0
650	0.283 5	0.107 0	0.000 0
660	0.164 9	0.061 0	0.000 0
670	0.087 4	0.032 0	0.000 0
680	0.046 8	0.017 0	0.000 0
690	0.022 7	0.008 2	0.000 0
700	0.011 4	0.004 1	0.000 0
710	0.005 8	0.002 1	0.000 0
720	0.002 9	0.001 0	0.000 0
730	0.001 4	0.000 5	0.000 0
740	0.000 7	0.000 2 (*)	0.000 0
750	0.000 3	0.000 1	0.000 0
760	0.000 2	0.000 1	0.000 0
770	0.000 1	0.000 0	0.000 0
780	0.000 0	0.000 0	0.000 0

(\*) Changed in 1966 (from 3 to 2)

<sup>2</sup> Abridged table. The values of  $\bar{y}(\lambda) = V(\lambda)$  are rounded off to four decimal places

Explanatory figure

**Example of device for measuring the reflection factor of spherical mirrors**

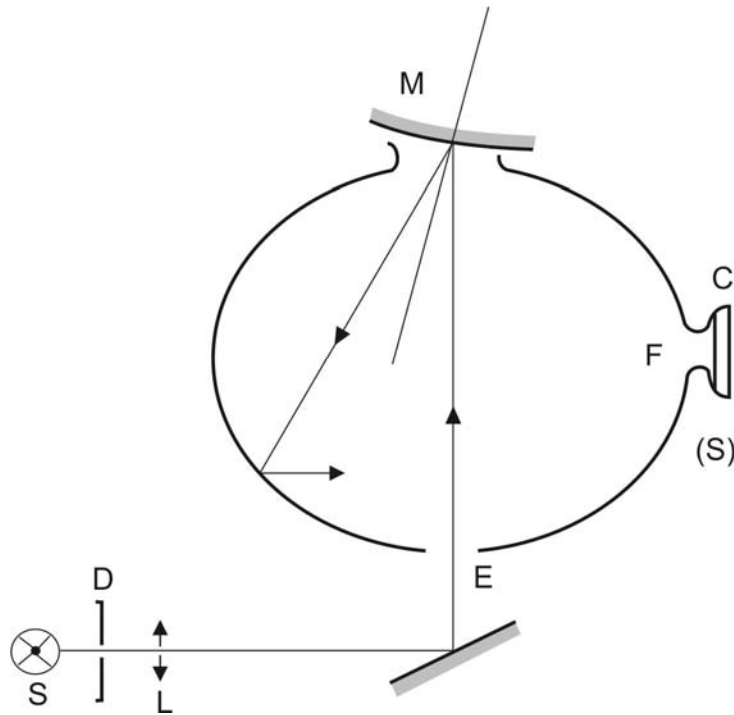

- C = Receiver
- D = Diaphragm
- E = Window of entry
- F = Window of measurement
- L = Lens
- M = Object window
- S = Light source
- (S) = Integrating sphere

## Annex 7

### Procedure for determining the radius of curvature "r" of the reflecting surface of a mirror

1. Measurement
  - 1.1. Equipment

A "spherometer" similar to the one described in Figure 1 of this annex having the indicated distances between the tracing pin of the dial gauge and the fixed legs of the bar is used.
  - 1.2. Measuring points
    - 1.2.1. The principal radii of curvature shall be measured at three points situated as close as possible to positions at one-third, one-half and two-thirds of the distance along the arc of the reflecting surface passing through the centre of this surface and parallel to segment b, or of the arc passing through the centre of the reflecting surface which is perpendicular to it if this arc is the longer.
    - 1.2.2. Where, owing to the size of the reflecting surface, it is impossible to obtain measurements in the directions defined in paragraph ~~2.1.1.6~~ **2.1.1.5.** of this Regulation, the Technical Services responsible for the tests may take measurements at the said point in two perpendicular directions as close as possible to those prescribed above.
2. Calculation of the radius of curvature "r"

"r" expressed in mm is calculated from the formula:

$$r = \frac{r_p 1 + r_p 2 + r_p 3}{3}$$

Where:

- $r_p 1$  = the radius of curvature at the first measuring point,  
 $r_p 2$  = the radius of curvature at the second measuring point,  
 $r_p 3$  = the radius of curvature at the third measuring point.

Figure 1

**Spherometer**

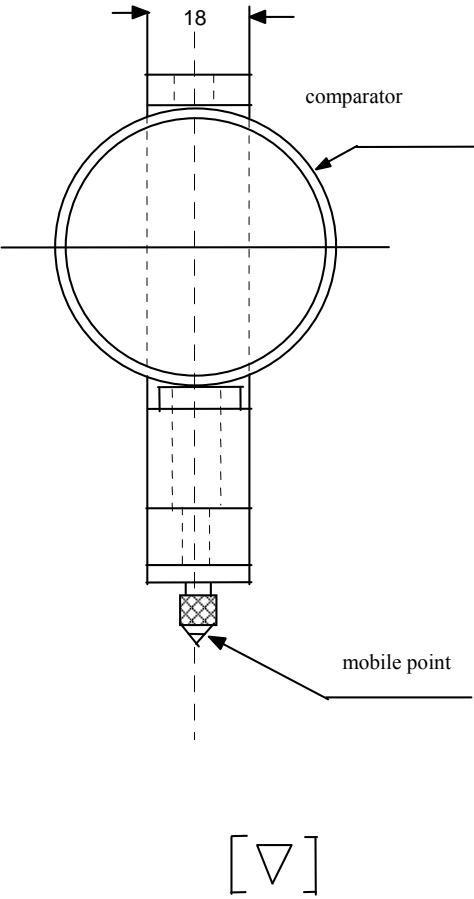
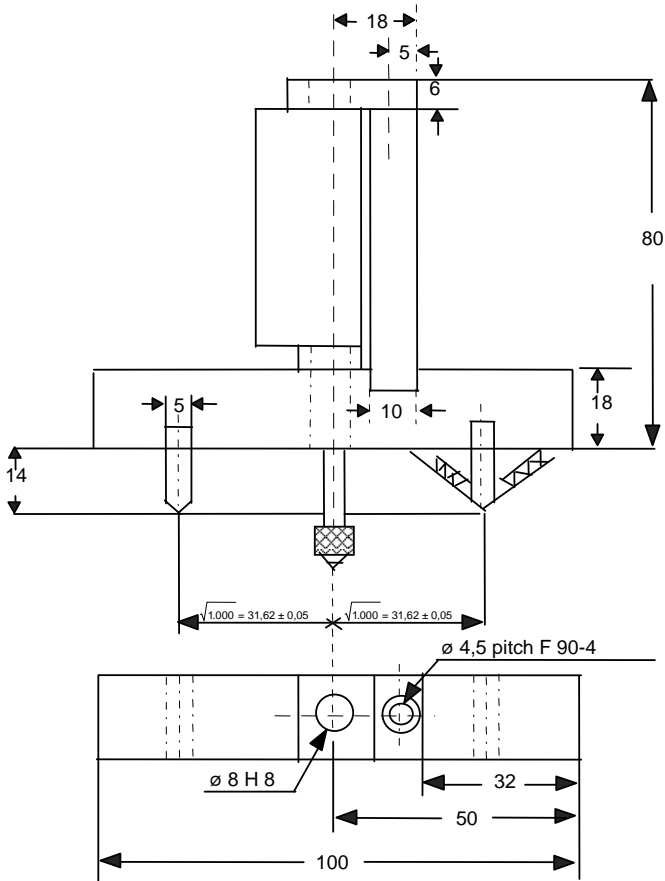

## **Annex 8**

### **Procedure for determining the "H" point and the actual torso angle for seating positions in motor vehicles<sup>1</sup>**

#### **Appendix 1 - Description of the three dimensional "H" point machine (3-D H machine)<sup>1</sup>**

#### **Appendix 2 - Three-dimensional reference system<sup>1</sup>**

#### **Appendix 3 - Reference data concerning seating positions<sup>1</sup>**

---

<sup>1</sup> The procedure is described in Annex 1 to the Consolidated Resolution on the Construction of Vehicles (RE.3) (document ECE/TRANS/WP.29/78/Rev.3).  
[www.unece.org/trans/main/wp29/wp29wgs/wp29gen/wp29resolutions.html](http://www.unece.org/trans/main/wp29/wp29wgs/wp29gen/wp29resolutions.html)



**Annex 9**

**(Reserved)**

## Annex 10

### Calculation of the detection distance for CMS of Classes V and VI

#### 1. Camera monitor device for indirect vision

##### 1.1. Determination of the smallest discernable detail

The smallest discernable detail of the naked eye shall be defined according to standard ophthalmologic tests like the Landolt C test or the Triangle Orientation Discrimination (TOD) test. The smallest discernable detail at the centre of the viewing system can be determined using the Landolt C test or the TOD test. In the rest of the viewing area the smallest discernable detail may be estimated from the centrally determined smallest discernable detail and the local image deformation. For instance, in the case of a digital camera the smallest discernable detail at a given pixel location (in the monitor) scales inversely with the solid angle of the pixel.

##### 1.1.1. Landolt-C test

In the Landolt-C test, test symbols are judged by the subject under test. In accordance with this test the smallest discernable detail is defined as the visual angle of the gap size of the Landolt C symbol at threshold size and is expressed in arcmin. The threshold size corresponds to the size at which the subject judges the orientation correctly in 75 per cent of the trials. The smallest discernable detail is determined in a test involving a human observer. A test chart containing test symbols is placed in front of the camera and the observer judges the orientation of test symbols from the monitor. From the threshold gap size of the Landolt C test symbol  $d$  (m) and the distance between the test pattern and the camera  $D$  (m) the smallest discernable detail  $\omega_c$  (arcmin) is calculated as follows:

$$\omega_c = \frac{d}{D} \cdot \frac{180 \cdot 60}{\pi}$$

##### 1.1.2. TOD test

The Landolt C test can be used to determine the smallest discernable detail of the camera-monitor system. However, for sensor systems it is more suitable to use the TOD (Triangle Orientation Discrimination) method which is similar to the Landolt C method, but involves equilateral triangular test patterns. The Triangle Orientation Discrimination method is described in detail by Bijl & Valetton (1999), who provide practical guidelines on how to perform a TOD measurement. In the method, triangular test patterns (see Figure 1) are viewed through the viewing system under test. Each triangle can have one out of four possible orientations (apex up, left, right or down) and the observer indicates/guesses for each triangle its orientation. When this procedure is repeated for many (randomly oriented) triangles of different sizes the fraction of correct responses can be plotted (see Figure 2), and increases with test pattern size. The threshold is defined as the point at which the fraction correct crosses the 0.75 level and can be obtained by fitting a smooth function through the data (see Bijl & Valetton, 1999). Critical perception is reached when the critical object diameter equals two times the

width of the triangle at threshold size. The smallest discernable detail ( $\omega_c$ ) is equal to 0.25 times the width of the triangle at threshold size. This means that, from the threshold triangle width  $w$  (in m) and the distance between test pattern and the camera  $D$  (in m) the smallest discernable detail  $\omega_c$  (in arcmin) is calculated as follows:

$$\omega_c = \frac{w}{4 \cdot D} \cdot \frac{180 \cdot 60}{\pi}$$

Figure 1  
**Triangular test patterns used in the Triangle Orientation Discrimination (TOD) method**

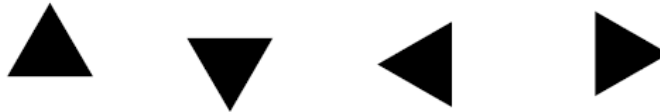
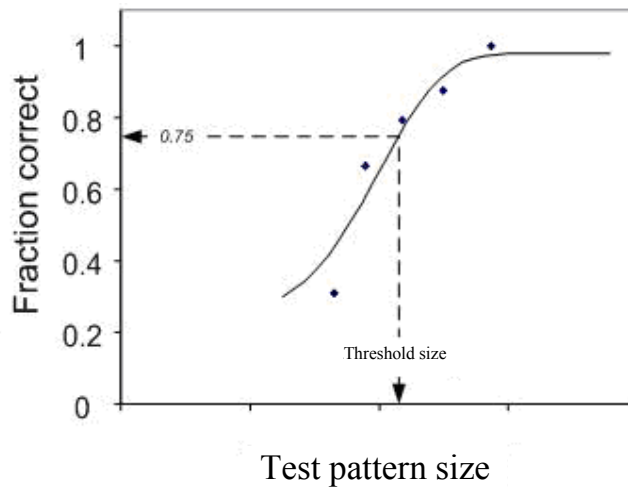

Figure 2  
**Typical relationship between the size of the triangle and the fraction of correct responses.**



1.2. Determination of the critical viewing distance of the monitor

For a monitor having certain dimensions and properties, the distance to the monitor can be calculated within which the detection distance is dependent only on the performances of the camera. The critical viewing distance  $r_{\text{merit}}$  is defined as the distance at which the smallest discernable detail displayed on the monitor spans 1 arcmin measured from the eye (the acuity threshold of a standard observer).

$$r_{\text{merit}} = \frac{\delta \cdot 60 \cdot 180}{\pi}$$

Where:

$r_{\text{merit}}$  : critical viewing distance of the monitor (m)

$\delta$  : size of the smallest discernable detail on the monitor (m)

- 1.3. Determination of the detection distance
- 1.3.1. Maximum detection distance within the critical viewing distance where, due to the installation, the distance eye-monitor is less than the critical viewing distance, the maximum attainable detection distance is defined as:

$$r_{\text{dclose}} = \frac{D_0 \cdot 60 \cdot 180}{\omega_c \cdot \pi \cdot f}$$

Where:

- $r_{\text{dclose}}$ : detection distance (m)
- $D_0$ : diameter of the critical object (m) according to paragraph 2.1.2.6. of this Regulation; for the calculation of  $r_{\text{dclose}}$  for class V and VI devices, a representative value of 0.30 m shall be used
- $f$ : threshold increasing factor, which is equal to 8
- $\omega_c$ : smallest discernable detail (arcmin)

- 1.3.2. Detection distance greater than the critical viewing distance. Where, due to the installation, the distance eye-monitor is more than the critical viewing distance, the maximum obtainable detection distance is defined as:

$$r_{\text{dfar}} = \frac{r_{\text{merit}}}{r_m} r_{\text{dclose}} \quad (\text{m})$$

Where:

- $r_{\text{dfar}}$ : detection distance for distances larger than the critical viewing distance (m)
- $r_{\text{dclose}}$ : detection distance for distances smaller than the critical viewing distance (m)
- $r_m$ : viewing distance, i.e. distance between eye and monitor (m)
- $r_{\text{merit}}$ : critical viewing distance (m)

2. Secondary functional requirements

Based on the installation conditions, a determination shall be made to discover whether the entire device can still satisfy the functional requirements listed in paragraph 6.2.2. of this Regulation, specifically the glare correction, the maximum and the minimum luminance of the monitor. It shall also be determined the degree to which the glare correction will be addressed and the angle at which sunlight can strike a monitor and these shall be compared to the corresponding measuring results from the system measurements. This can be either based on a CAD-generated model, a determination of the angles of light for the device when mounted on the relevant vehicle, or by carrying out relevant measurements on the relevant vehicle as described in paragraph 6.2.2.2. of this Regulation.

## Annex 11

### Determination of the displayed object size for CMS of Classes V and VI

1. Camera monitor device for indirect vision
  - 1.1. General
 

Determination of the displayed object size considers the possible appearance of smear. The impact on the monitors image and consequence is the occultation of the field of view and therefore of the object. The following differentiation is made:
  - 1.2. Case A: Smear appears
    - 1.2.1. Step 1: Under the condition described in paragraph 6.2.2.2.1.2. of this Regulation, measure the width (s) of the vertical bar displayed on the monitor e.g. with a measurement microscope.
    - 1.2.2. Step 2: Place the object at a defined distance from the camera. Measure the width of the object displayed on the monitor (b) in a situation without real sun light condition e.g. with a measurement microscope.
    - 1.2.3. Step 3: Calculate the residual object width ( $\alpha$ ) according to the following equation:

$$\alpha ['] = 60 \times 2 \times \arctan \frac{b-s}{2 \times r}$$

Where:

- $\alpha$ : residual width of the object displayed on the monitor (with smear) (minutes of arc)
- b: width of the object displayed on the monitor (without smear) (mm)
- s: width of the smear (mm)
- r: viewing distance (mm)

- 1.3. Case B: Smear does not appear
  - 1.3.1. Step 1: Place the object at a defined distance from the camera. Measure the width of the object displayed on the monitor (b) in a situation without real sun light condition e.g. with a measurement microscope.
  - 1.3.2. Step 2: Calculate the object width ( $\alpha$ ) according to the following equation:

$$\alpha ['] = 60 \times 2 \times \arctan \frac{b}{2 \times r}$$

Where:

- $\alpha$ : width of the object displayed on the monitor (without smear) (minutes of arc)
- b: width of the object displayed on the monitor (without smear) (mm)

r: viewing distance (mm)

1.4. Data supplied by the instructions for use

In case of Class V and VI camera monitor devices the instructions for use shall include a table that shows the minimum and maximum mounting height of the camera above ground under consideration of different viewing distances. The camera shall be mounted within the applicable height range. The viewing distances shall be selected from the intended context of use. The following table shows an example.

Viewing distance	0.5 m	1.0 m	1.5 m	2.0 m	2.5 m
Minimum mounting height	Para. 1.4.1.	Para. 1.4.1.	Para. 1.4.1.	Para. 1.4.1.	Para. 1.4.1.
Maximum mounting height	Para. 1.4.2.	Para. 1.4.2.	Para. 1.4.2.	Para. 1.4.2.	Para. 1.2.2.

1.4.1. The value of the minimum mounting height is the same for all viewing distances as it is independent of the viewing distance. It is determined by the dimensions of the field of vision and the field of view of the camera. Use the following working steps for determination of the minimum mounting height.

1.4.1.1. Step 1: Draw the intended field of vision on ground.

1.4.1.2. Step 2: Place the camera above the field of vision in such a way that the camera is viewing the field of vision. The lateral position shall be in accordance with the intended mounting position at the vehicle.

1.4.1.3. Step 3: Change the height of the camera above ground in such a way, that the field of vision displayed on the monitor covers an area at least as large as the field of vision. Furthermore, the field of vision display should encompass the entire monitor screen.

1.4.1.4. Step 4: Measure the height between camera and ground which is the minimum mounting height. Report the result value.

1.4.2. The value of the maximum mounting height is different for different viewing distances as the displayed object size varies with the mounting height. Use the following working steps for determination of the maximum mounting height:

1.4.2.1. Step 1: Determine the minimum width  $b_{\min}$  of the critical object displayed on the monitor for each viewing distance.

$$b_{\min} = 2 \times r \times \tan \frac{8'}{2 \times 60}$$

Where:

r: viewing distance in mm

$b_{\min}$ : minimum width of the critical object displayed on the monitor in mm

1.4.2.2. Step 2: Place the critical object inside the drawn intended field of vision in a position at which the distance between the critical object and the camera is

largest. The illumination conditions shall be in such a way that the critical object is clearly visible on the monitor.

- 1.4.2.3. Step 3: Select the first value of the possible viewing distances.
- 1.4.2.4. Step 4: Change the height of the camera above ground in such a way, that the residual width  $B$  of the object displayed on the monitor is equal to the minimum width allocated to that viewing distance.

$$B=b_{\min}$$

Where:

$B$ : residual width of the object displayed on the monitor (which is "b" in cases without smear and "b - s" in cases with smear) in mm (see paragraph 1.1. General)

- 1.4.2.5. Step 5: Measure the height between camera and ground which is the maximum mounting height allocated to that viewing distance. Report the result value.
- 1.4.2.6. Step 6: Repeat the aforementioned steps 4 and 5 for the other viewing distances.

## Annex 12

### Test methods and safety provisions for CMS of Class I to IV

#### 1. Test methods

##### 1.1. General specifications

The Technical Service shall use recognized test methods to check compliance with the requirements defined above in the Regulation. These test methods shall be agreed upon by the Type Approval Authority.

##### 1.2. Flicker test

**The entire image area of the monitor shall be free of flicker for at least 90 per cent of the user population.** The flicker evaluation uses the determination given in Annex B of ISO13406-2: 2001. The following measurement procedure applies:

- 1.2.1. Position the camera of the CMS in front of a still scene (e.g. chessboard chart). Use a scene illumination of about 500 lux. Measure the time resolved luminance value of a portion of the monitor that displays a white patch of the chessboard chart. The measurement location should be near the centre of the monitor defined size and the measurement direction is perpendicular onto the monitor. Perform a Fourier transform of the luminance-time function for determination of the amount of energy  $E_{obs}$  at various frequencies up to 120 Hz. These numbers are then compared to the amounts of energies that people will detect as flicker, the predicted flicker threshold  $E_{pred}$ .

If  $E_{obs} < E_{pred}$  at every frequency  $< 120$  Hz then it is likely that people will not see flicker.

If  $E_{obs} \geq E_{pred}$  at any frequency  $< 120$  Hz then it is likely that people will see flicker.

- 1.2.2. Determination of  $E_{obs}$ , which is the observed energy at every frequency  $< 120$  Hz:

$$E_{obs,n} = DC * AMP_n = A * c_0 * AMP_n = b_0 * L_t^{b_1} * c_0 * AMP_n$$

where:

$$b_0 = 12.45184$$

$$b_1 = -0.16032$$

For  $L_t$ , which is the adaption luminance:

Use  $L_t = L_{monitor/chart/white/ambient}$  from ISO 16505:2015 (subclause 7.8.2: Test 2: Day condition with diffuse sky-light exposure).

For  $c_0$ , which is the zero Fourier coefficient, and is the dark-room luminance averaged over time.

Use  $c_0 = L_{monitor/chart/white}$  from ISO 16505:2015



(see ISO 16505:2015, subclause 7.8.2.: Test 2: Day condition with diffuse sky-light exposure with the diffuse light source switched off).

For  $AMP_n$ :

$$AMP_n = \frac{2 * |c_n|}{c_0}$$

For  $c_n$ , which is the  $n^{\text{th}}$  Fourier coefficient. Take the  $n^{\text{th}}$  Fourier coefficient from the Fourier transform.

- 1.2.3. Determination of  $E_{\text{pred}}$ , which is the predicted energy at every frequency < 120 Hz:

$$E_{\text{pred},n} = a * e^{b * f_n}$$

The variables  $a$  and  $b$  depend on the monitor diagonal as seen from the driver's ocular reference point and is measured in degree (see Table B.1 in the standard ISO 13406-2:2001). For a monitor diagonal  $\alpha_{\text{monitor}/\text{Diagonal}}$  of less than  $20^\circ$ , variables  $a$  and  $b$  equals to  $a = 0.1276$  and  $b = 0.1424$ .

The monitor diagonal  $\alpha_{\text{monitor}/\text{Diagonal}}$  is given by the following equation:

$$\alpha_{\text{monitor}/\text{Diagonal}} = 2 * \arctan \frac{\text{Diagonal}}{2 * a_{\text{monitor}/D}}$$

Where:

**Diagonal** diagonal of the monitor, measured in meters

$a_{\text{monitor}/D}$  Distance of the ORP to the centre of the monitor coordinate system.

- 1.2.4. For every frequency < 120 Hz compare the observed energy  $E_{\text{obs}}$  with the predicted energy  $E_{\text{pred}}$  and report the result value for passed or failed.

- 1.3. Point light sources test method

Figure 1 shows the test arrangement for the point light source test.

Figure 1: test arrangement for the point light source test

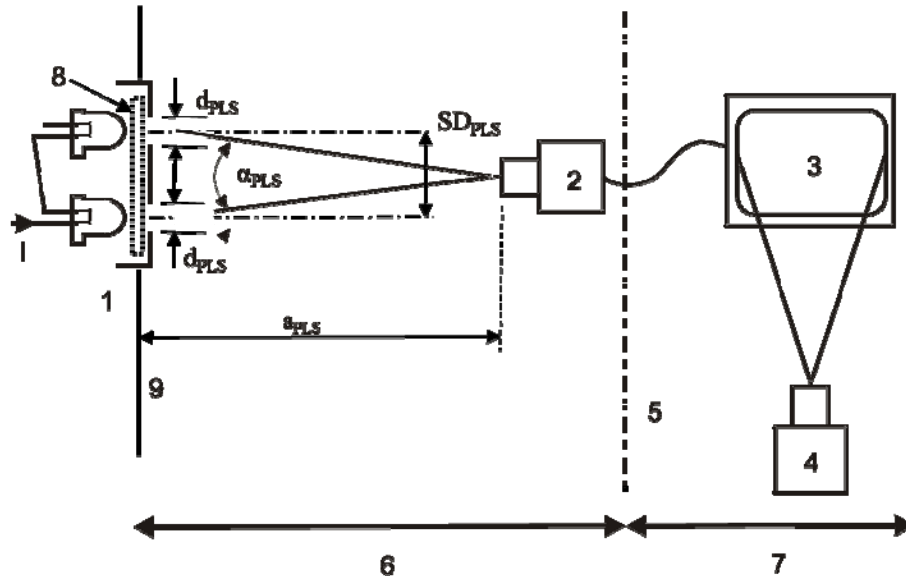

## Notes:

- 1: Point light source lab model to emulate passing beam headlamp at 250 m
- 2: Camera being tested
- 3: Monitor being tested
- 4: Reference camera
- 5: Optical or spatial isolation between camera and monitor display environment
- 6: Camera-side dark environment
- 7: Monitor-side dark room environment
- 8: LED light diffuser/aligner, according to necessity
- 9: Neutral black background

The point light source lab model is an emulation of a set of vehicle passing beam headlamps at a distance of 250 m with luminous intensity of 1,750 cd, in accordance to the maximum allowance of luminous intensity of a vehicle passing-beam headlamp at point "BR" described in Regulation No. 112, 01 series of amendments. The test is performed considering a set of lamps with 0.09 m diameter and separated by 1.3 m. This results in a luminance of 275,000 cd/m<sup>2</sup>. For laboratory evaluation purposes the light sources shall be adjusted to have a luminance within the range of 250,000 to 300,000 cd/m<sup>2</sup> by using a constant current source.

For laboratory evaluation purpose a shorter distance than 250 m can be used.

The distance  $a_{PLS}$  from the camera entrance pupil to the point light source lab model shall be within the depth of field of the camera. The point light source lab model shall be adjusted to the measuring distance  $a_{PLS}$  in terms of lamp size  $d_{PLS}$  and distance  $SD_{PLS}$ . The value for  $d_{PLS}$  and  $SD_{PLS}$  shall be rounded to the nearest 0.1 mm.

A typical white LED having a correlated colour temperature of 6,500 K with a tolerance of  $\pm 1,500$  K is used for this evaluation. The emitting surface of the LED shall keep an even luminance or it shall be diffused using an optional diffuser as shown in Figure 1.

The angular size corresponding to the headlamp of 0.09 m diameter and the angular orientation of the two point light source separated by 1.3 m of each other, at 250 m distance, are calculated as:

$$\alpha_{LampDia} = 2 \times \arctan \frac{(0.09/2)}{250} = 2 \times \arctan \frac{(d_{PLS}/2)}{a_{PLS}} = 1.24'$$

and

$$\alpha_{PLS} = 2 \times \arctan \frac{(1.3/2)}{250} = 2 \times \arctan \frac{(SD_{PLS}/2)}{a_{PLS}} = 17.9'$$

For example, at 6 m distance from CMS to this emulated LED, the corresponding aperture opening of the LED shall be  $d_{PLS} = 2.2$  mm in diameter and separated by  $SD_{PLS} = 31.2$  mm to emulate the set of passing beam headlamps located 250 m from the CMS.

Ambient illumination at the point light source lab model and at the monitor-side shall be less than 2 lux.

The luminance of the LED shall be measured at the same angular direction of the CMS to confirm that light emitted from the aperture delivers the correct luminance.

The luminance of the rendered point light sources on the monitor is measured by using a reference (luminance) camera according to ISO 16505:2015 providing a sufficient spatial resolution, or equivalent.

For the evaluation, the CMS shall be switched to the operation mode intended to observe the point light sources.

Position the camera of the CMS such that its optical axis is aligned to the perpendicular orientation of the point light source lab model (Figure 1). Target the CMS camera to display the point light sources in the middle of the monitor defined size. The distance from the camera entrance pupil to the point light source lab model shall be set to  $a_{PLS}$ .

For determination of the point light source detection factor PLSDF evaluate the luminance profile in horizontal and vertical direction (Figure 2).

**Figure 2: Luminance profile of the rendered point light sources for the determination of the PLSDF**

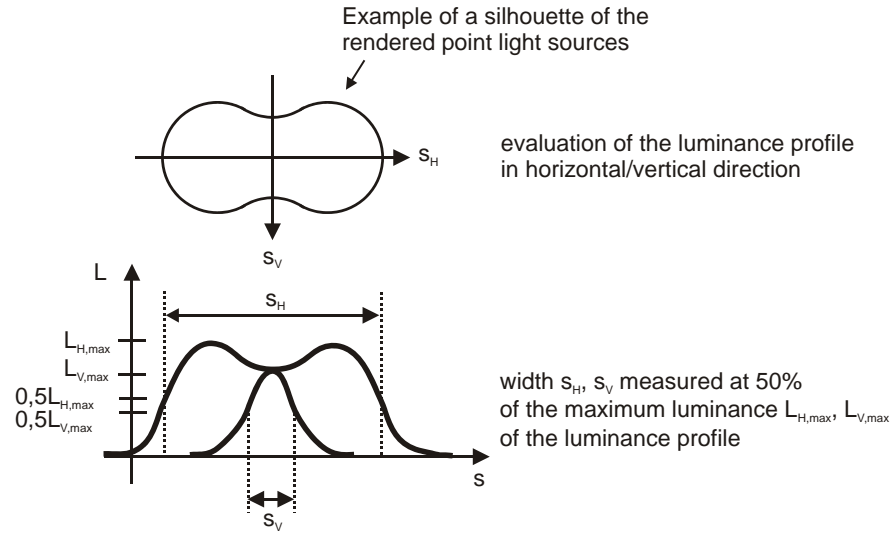

The point light source detection factor - PLSDF is determined by the following equation:

$$PLSDF = \frac{s_H \times L_{H,max}}{s_V \times L_{V,max}}$$

Where:

**sH** full width at half maximum of the luminance profile in horizontal direction at the vertical centre

**LH,max** maximum luminance of the luminance profile in horizontal direction at the vertical centre

**sV** full width at half maximum of the luminance profile in vertical direction at hourglass point

**LV,max** maximum luminance of the luminance profile in vertical direction at hourglass point

Verify the consistency of the result with slightly shifted position of the point light source lab model.

For determination of the point light source contrast factor PLSCF, evaluate the luminance profile in horizontal direction (Figure 3) at the vertical centre.

**Figure 3:**

**Luminance profile of the rendered point light sources for the determination of the PLSCF**

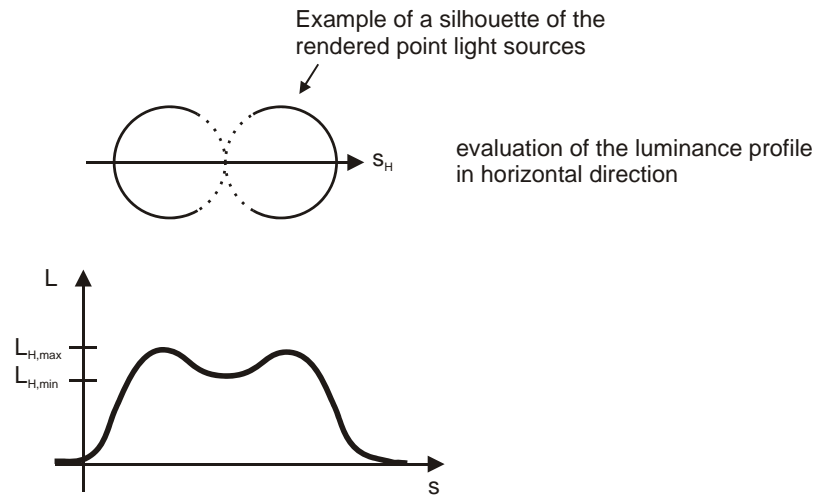

The point light source contrast factor PLSCF is determined by the following equation:

$$PLSCF = \left( 1 - \frac{L_{H,min}}{L_{H,max}} \right)$$

Where:

**LH,max** maximum luminance of the luminance profile in horizontal direction

**LH,min** luminance value at saddle point of the luminance profile, which is equivalent to the minimum luminance value between the two luminance peaks(see Figure 3)

Verify the consistency of the result with slightly shifted position of the point light source lab model.

#### 1.4. Grey scale rendering test method

The grey scale rendering test shall verify that CMS are capable of displaying at least 8 tonal grey steps distinguishable within the darkest and brightest output range from the reproduced chart on the CMS monitor. The grey scale rendering test is evaluated using a 20:1 low contrast grey scale chart as described in ISO 14524:2009, Table A.1, under 500 lx illuminated scene environment.

The distinguishable tonal difference described herein is defined as an display output signal whose lightness difference between two different tonal input through the CMS satisfy at least  $\Delta L^* \geq 3.0$ , with  $L^*$  defined as lightness according the definition in CIE 1976  $L^*a^*b^*$  colour space.

Figure 4 shows the test arrangement for the grey scale rendering test.

Figure 4: Test arrangement for the grey scale rendering test

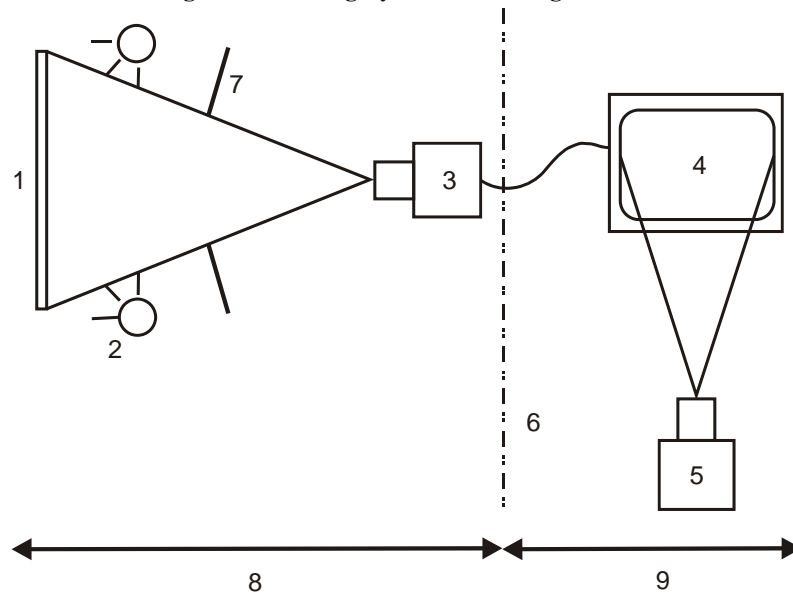

- 1: Test chart (grey scale rendering chart)
- 2: Illumination for test chart
- 3: Camera being tested
- 4: Monitor being tested
- 5: Reference camera
- 6: Optical or spatial isolation between camera and monitor display environment
- 7: Optical isolation barrier to avoid direct light into lens
- 8: Camera-side
- 9: Monitor-side

Figure 5 shows an example of a grey scale rendering chart to be used in this measurement. The grey scale rendering chart shall consist of 12 different tonal density grey patches.

The density value  $D_i$  shall follow the values as defined by ISO 14524:2009 Table A.1 for low contrast 20:1. The definition of  $D_i$  is given in the ISO 14524:2009.

The background of the patches should be covered with a neutral grey colour having a density value  $D_i$  of  $0.54 \pm 0.05$ .

Both reflective and transmissive charts with Lambertian characteristics can be used.

The whole camera image area shall be covered by the chart image. The grey scale rendering chart shall be placed in such a way so that the grey patches are visible in the centre of the monitor defined size.

Adjust the distance between the camera under test and the test chart to have individual patches of the chart displayed by at least  $50 \times 50$  pixels on the monitor under test, whenever possible. For Class IV devices exhibiting high distortion and/or optical vignetting, a reduced size area

may also be used to minimize the vignette effect on the measurement results.

The illumination shall be similar to the CIE D65 standard illuminant and have a correlated colour temperature of  $T = 6,500 \text{ K}$  with a tolerance of  $\pm 1,500 \text{ K}$ .

The test is performed with a scene illumination of 500 lux (this test condition is equivalent to test condition for colour rendering as defined in ISO 16505:2015 clause 7.8.3), and at room temperature  $22 \text{ }^\circ\text{C} \pm 5 \text{ }^\circ\text{C}$ .

Ambient illumination at the monitor-side shall be  $\leq 10 \text{ lux}$ , and glare light source to the monitor shall be avoided.

Figure 5:

Example of the grey scale rendering chart

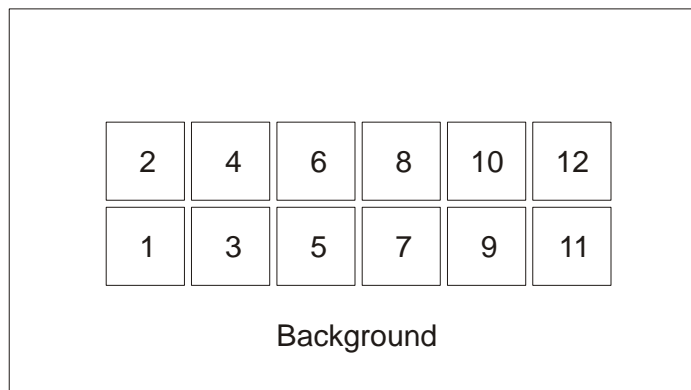

Each patch on the grey scale rendering chart shall have a size of 50 x 50 mm. The distance between the patches shall be 5 mm.

Table 1 shows density value  $D_i$  of the 12 different grey patches as well  $D_i$  of the background.

Table 1:

Density values  $D_i$

Grey patch No.	Density $D_i$
1	1.40
2	1.21
3	1.05
4	0.90
5	0.77
6	0.65
7	0.54
8	0.44
9	0.35
10	0.26
11	0.18
12	0.10
Background	$0.54 \pm 0.05$

Measure the luminance  $Y_i$  of each grey patch  $i = 1...12$  by using the reference camera. Then, calculate the lightness of each grey patch:

$$L_i^* = 116 \times \left( \frac{Y_i}{Y_{12}} \right)^{1/3} - 16, \text{ when } Y_i/Y_{12} > 0,008856$$

$$L_i^* = 903,3 \times \left( \frac{Y_i}{Y_{12}} \right), \text{ when } Y_i/Y_{12} \leq 0,008856$$

Calculate the lightness difference between each grey patch:

$$\Delta L^* = L_{i+1}^* - L_i^* \text{ and compare the result with the requirement.}$$

**2. Special requirements to be applied to the safety aspects of camera monitor systems for indirect vision**

**2.1. General**

The purpose of this paragraph is to specify the requirements for documentation and verification for CMS for indirect vision of Classes I to IV to replace mandatory rear-view mirrors for road vehicles.

"The System", referred to herein, is the one for which type approval is being sought.

This paragraph 2. does not specify the performance criteria for "The System" but covers the methodology applied to the design process and the information which shall be disclosed to the Technical Service, for type approval purposes.

This information shall show that "The System" respects, under normal and fault conditions, all the appropriate performance requirements specified elsewhere in this Regulation.

**2.2. Definitions**

**2.2.1. Camera Monitor System (CMS)**

A CMS is used in road vehicles to present the required outside information of a specific field of view to the driver. It replaces a conventional legally prescribed mirror system on the vehicle by means of electronic image capture and display systems.

It consists of a camera that is usually installed at the bodywork of a vehicle and a monitor that is usually placed inside the vehicle.

**2.2.2. Camera**

A camera is a device to capture colour images of a specific field of view. It mainly consists of two relevant items: imager and lens.

**2.2.3. Monitor**

A monitor is a device for displaying images. It either consists of a matrix of active areas that radiate light of different wavelengths or is a (usually diffuse) reflector that is illuminated in different wavelengths and in a matrix of specific points by a projector.

**2.2.4. Control unit**



A control unit is a component which controls communication and coordination between electronic components, e.g. a camera and a monitor.

**2.2.5. Safety concept**

A safety concept is a description of the measures designed into the system, for example within the electronic units, so as to address system integrity and thereby ensure safe operation even in the event of a system or electrical failure.

**2.2.6. "Boundary of functional operation"**

"Boundary of functional operation" defines the boundaries of the external physical limits within which the system is able to maintain functionality.

**2.3. Documentation**

**2.3.1. The vehicle manufacturer shall provide the following documentation:**

(a) A description of the camera monitor system which gives an explanation of the main function of the system, incl. drawings, pictures, block diagrams, etc.

(b) A description of the location of the camera and the monitor in the vehicle (system overview).

(c) Name of manufacturer of camera, monitor and electronic control units.

(d) Type of camera and monitor. Each unit shall be clearly and unambiguously identifiable (e.g. by marking for hardware and marking or software output for software content) to provide corresponding hardware and documentation association.

(e) The warning strategy and the safety concept, as defined by the manufacturer, shall be explained to the Technical Service and / or to the Type Approval Authority also covering at least the list of failures of paragraph 2.4.

**2.3.2. For periodic technical inspections, the documentation shall describe how the current operational status of "The System" can be verified.**

**2.3.3. The limits for the boundary of functional operation (e.g. environmental parameters) shall be stated where appropriate to the system performance.**

**2.3.4. Safety concept of the manufacturer**

The manufacturer shall provide a statement which affirms that the strategy chosen allows a safe operation of "The System".

In case of a failure, the driver shall be informed for example by a clear and visible warning signal or message display. When the system is activated, the warning shall be present as long as the fault condition persists.

The fault conditions shall be established and maintained by the manufacturer and shall be made open for inspection by the Technical Service at the time of the type approval.

- 2.3.5. **The chosen analytical approach(es) shall be established and maintained by the manufacturer and shall be made open for inspection by the Technical Service at the time of the type approval.**
- 2.4. **List of failures**
  - 2.4.1. **Camera**
    - (a) **Failure of the camera;**
    - (b) **Electronic noise, reduced detail resolution;**
    - (c) **Defocus of the optics, reduced detail resolution.**
  - 2.4.2. **Monitor**
    - (a) **Failure of monitor display, no image content is displayed;**
    - (b) **Freeze of displayed monitor content, image content is not refreshed;**
    - (c) **Enlarged image formation time, changing image content is blurred.**
  - 2.4.3. **Control unit**
    - (a) **Failure of the control unit;**
    - (b) **Failure in the communication between camera and control unit;**
    - (c) **Failure in the communication between control unit and monitor.**
- 2.5. **Verification**
  - 2.5.1. **Verification of the performance of the camera monitor system under no-fault and fault conditions shall be conducted against the manufacturer's specification.**
  - 2.5.2. **The verification of the safety concept of the reaction of the camera monitor system shall, at the discretion of the Type Approval Authority, be verified according to the influence of failures in paragraph 2.4. The verification results shall correspond with the documented summary of the failure analysis in paragraph 2.4., to a level of overall effect such that the safety concept and execution are confirmed as being adequate.**

## B. Justification

### I. General background

1. This proposal submitted by the Informal Group on Camera-Monitor Systems – Stage II (IGCMS-II) is based on document ECE/TRANS/WP.29/GRSG/2011/23/Rev.1 that had been submitted to the Working Party on General Safety Provisions (GRSG) by the informal group IGCMS-I as a result of the first stage. The document provided the amendments (technology neutral) needed to permit the optional replacement of conventional mirrors, while for the technical provisions a reference to an ISO standard (currently under development) is proposed. During the development of the ISO standard, of which the publication is expected for early beginning of 2015 as ISO 16505:2015, it became obvious that a one to one reference to the standard within the provisions for component type approval only would not be appropriate because:

- (a) a differentiation between provisions for component approval and installation approvals would be needed,
- (b) some provisions of ISO were seen as not appropriate or not acceptable for type approval purposes, and
- (c) the ISO standard contains recommendations which could lead to different interpretations.

2. Taking into account the guidance by WP.29 on references to standards of third parties like ISO, the informal group proposes to incorporate the relevant provisions of ISO, if needed in an amended manner, directly into the provisions of Regulation No. 46. With regard to the symbols, definitions and test procedures, IGCMS proposes a general statement containing a direct reference to the relevant parts of ISO 16505.

3. Concerning the introduction of relevant provisions from ISO into the text of Regulation No. 46, IGCMS-II took roughly the following approach:

- (a) relevant provisions for component approval for camera-monitor devices of Classes I to IV were introduced in a new paragraph 6.2.2.3.,
- (b) relevant provisions on the installation of a camera-monitor device of Classes I to IV were introduced in a new paragraph 16 that will also contain the installation provisions for Classes V and VI and
- (c) introduction of a new Annex 12 containing test methods that are not given or different than those in ISO 16505:2015.

4. The informal group focussed only on the provisions for the Class I to IV devices for indirect vision and did not change the existing provisions for Class V and VI camera-monitor systems. As ISO 16505 will not apply to Class VII mirrors the informal group kept the provisions for the category L vehicles unamended. As there will be no need to differentiate between existing approvals and approvals granted according the proposed provisions the proposals of IGCMS-II can be seen as a supplement to the present 04 series of amendments.

5. IGCMS-II emphasises that its proposals will be limited such that Regulation No. 46 will make the application of camera-monitor devices possible; improvements of the provisions or the application of further technical developments can be regulated separately as a second step.

## II. Detailed justifications

6. The amendments to definitions are mainly taken over from the proposals of IGCMS-I.

(a) The definitions have been reordered such that those related to mirrors are grouped as subparagraphs of paragraph 2.1.1.; those related to camera-monitor devices become subparagraphs of 2.1.2. and general definitions are numbered separately as paragraphs 2.1.3. to 2.4. The renumbering of paragraphs and references to paragraphs as a consequence of this re-shuffle of definitions, as well as renumbering due to new text that has been inserted, are not individually explained in these justifications.

(b) The definition of "device for indirect vision" (para. 2.1.) has been aligned with the text of paragraph 2.1.1. and relates to the required field of vision according to paragraph 15.2.4.

(c) The definition of mirror (para. 2.1.1.) has been amended to clarify that a mirror is only a device with a reflective surface for rendering the field of vision and excludes other devices.

(d) The definitions of interior mirror and exterior mirror have been clarified so as to relate to the definition of mirror (para. 2.1.1.) and not to the general definition of "device for indirect vision" (para. 2.1.).

(e) The names of the classes of devices have been amended as the mounting of a device for indirect vision in the case of a camera-monitor system is not by definition interior or exterior the vehicle. As a consequence the names of the classes have been amended throughout the document.

(f) Simplification of the definition for camera-monitor device (para. 2.1.2.) as "for indirect vision" is already included in the definition of paragraph 2.1. For editorial reasons, the abbreviation "CMS" has been added for use through the whole document.

(g) IGCMS-II suggests deleting the definition for "detection" (para. 2.1.2.3.) as this term is not used in Regulation No. 46.

(h) The specific parameters defining a camera monitor type device (para. 2.2.) have been limited to the class as the class defines the required field of vision.

(i) For camera-monitor devices the mounting position interior or exterior of the vehicle is not relevant, which justifies amending the definitions for the mirror classes in paragraph 2.4. The new text is made applicable to other devices than mirrors.

(j) In paragraphs 2.5. and 2.6., IGCMS-II proposes new definitions for "Point light source detection factor" and "Point light source contrast factor" that are needed for the recognition of headlamps as part of the provisions on artefacts.

(k) Finally IGCMS-II corrected the definition for "smear" in paragraph 2.1.12.

### 7. Paragraph 2.1.13.

Definition of "Mirror and CMS dual function system" was added to cover the content of revised paragraph 6.2.2.3.3.2. and 6.2.2.3.3.2.1. Such a system is limited to Class I.

### 8. Paragraph 2.2.

For camera-monitor systems, defining the type based on the class only, allows all kind of systems with completely different performances to be considered as of one and the same type.

To bring the type definition for camera-monitor systems in line with the intention of a type definition in general and, in particular in line with the description already existing for types of mirrors (2.2.(b)), the above is proposed.

9. Paragraphs 3.3. to 3.3.2.

In general, only three samples are needed to accompany the application of an approval as the retaining of one sample by the laboratory is not needed anymore.

10. Paragraph 3.4.

For verification of the provisions the application for approval shall be accompanied by detailed technical specifications of the system and the operator's manual.

11. Paragraph 4.2.

IGCMS recognizes the difficulties of approval markings on small parts of a CMS and proposes a simplification of the provisions without losing the possibility to identify the parts. Furthermore, the value of 12 mm for the letter "a" of the approval mark given in Annex IV has been reduced from 12 to 5 mm. The present technology permits the reduction of the approval mark without any reduction of the legibility.

12. Paragraph 5.4.

This amendment is a consequence of the new wording of paragraph 4.2.

13. Paragraphs 5.4.3.

The provisions on the additional symbols for the approval marks need an amendment to permit the approval of a CMS for more than one class.

14. Paragraph 6.1.3. (former)

The provisions on the impact test have been moved from former paragraph 6.1.3. to a new paragraph 6.3. by which the provisions become applicable to all devices for indirect vision. Moreover, the set-up for the impact test of camera-monitor systems has been described. Finally, it will be necessary to specify that, similar to mirrors, the lens of the camera will not be broken after the tests.

15. Paragraph 6.2.1.3.

IGCMS considers it necessary that a CMS meets the provisions on electromagnetic compatibility. As the basic thoughts of IGCMS are not to change the existing provisions for CMS of Classes V and VI, the requirement to meet Regulation No. 10, 04 series of amendments, will only be requested for Classes I to IV. **The preceding series 04 of amendments are also applicable. This prevents the requirement for re-homologation for vehicles with existing homologation of this series.**

16. Paragraph 6.2.2.

A CMS is by definition for indirect vision. Furthermore it has been clarified that the provisions and tests for the radius of curvature of the components do not apply in case a monitor fulfils the requirements according to Regulation No. 21.

17. Paragraph 6.2.2.1.1.

IGCMS prefers the verification of the radius of curvature of parts of the devices in a more realistic set-up instead of on a plane surface with also a distinction between parts inside and parts outside the vehicle.

18. Paragraph 6.2.2.1.1.

The intended installation has been replaced by a more defined description. Normal driving position is defined in paragraph 15.2.2.1.

19. Paragraph 6.2.2.2.

The existing functional requirements for CMS remain unamended for the Classes V and VI. The functional requirements for Classes I to IV are specified in paragraph 6.2.2.3.

20. Paragraph 6.2.2.3.

This paragraph provides the provisions for the component approval of a CMS of Classes I to IV which are derived from ISO 16505:2015. To limit the volume of the text for incorporation into Regulation No. 46, IGCMS proposes to refer for the definitions, symbols and tests given in paragraph 6.2.2.3. to the ISO standard as much as possible.

21. Paragraph 6.2.2.3.1.

The provisions on luminance adjustment have been taken over from ISO 16505:2015, providing a secure visibility of the CMS, according to driver's needs in different driving ambient light conditions.

22. Paragraph 6.2.2.3.2., operating readiness

This provision on system availability is derived from ISO 16505:2015.

23. Paragraph 6.2.2.3.3., image quality

The provisions on image quality concern the monitor isotropy, luminance and contrast rendering, grey scale rendering, colour rendering, artefacts, sharpness and depth of field, geometric distortion and further image quality requirements.

24. Paragraph 6.2.2.3.3.1.

Monitor isotropy is a provision taken over from ISO 16505:2015, and the provision secures enough visibility of the CMS monitor at different viewing condition of the driver.

25. Paragraph 6.2.2.3.3.1.1.

Directional uniformity is a provision taken over from ISO, and the provision secures enough visibility of the CMS monitor when monitor is viewed from different orientation expected within the driver eyellipses including head-movements. It is intended to restrict the degradation of the image when the flat panel display is viewed from different orientation.

26. Paragraph 6.2.2.3.3.1.2.

Lateral uniformity is a provision taken from ISO16505:2015 and secures enough visibility of the CMS monitor by limiting the maximum allowance range of the luminance variation within the monitor display. It is intended to restrict the degradation of the image in terms of luminance within the viewing area of the CMS.

27. Paragraph 6.2.2.3.3.2., luminance and contrast

A certain luminance and contrast capability of the CMS needs to be defined to achieve an appropriate image quality with distinguishable objects. The provision cares different environmental lighting condition that may affect the perceptibility to the scene. The requirements have been taken from ISO 16505:2015, however, with the following modification to ensure appropriate visibility under some severe lightning condition:

(a) the luminance contrast of the monitor during night conditions has been increased to 10:1 following ISO clause 6.9.2. recommendations for older driver needs.

(b) the value for the luminance diffuse illuminator for test under day condition with diffuse sky-light exposure test has been increased, but under certain conditions that value may be reduced.

28. Paragraph 6.2.2.3.3.2.1., day condition with diffuse sky-light exposure test

In order to define a safer provision under a worst case condition where the vehicle outer sky-light specular light reflects on the monitor to the driver's eye, the requirement from the ISO 16505 was modified and reinforced to satisfy higher value of 4,200 cd/m<sup>2</sup>. An addition provision is introduced to cover for installation design where the external incident specular light is properly restricted by the layout design and in such case, the requirement is adjusted accordingly to the affected percentage of the incident specular light through the opening of the vehicle.

29. Paragraph 6.2.2.3.3.3., grey scale rendering

The grey scale rendering is introduced as test to verify that enough tonal steps are secured for displaying the field of vision through the CMS. Test method is introduced in Annex 12, paragraph 1.4.

30. Paragraph 6.2.2.3.3.4., colour rendering

Colour rendering is a provision to secure that colours are properly reproduced through the CMS and daylight provision has been taken over from ISO 16505:2015; and the provision on the recognition of amber, red and blue lights have been amended to take account of the rendering of traffic critical lights, including night time.

31. Paragraph 6.2.2.3.3.5., artefacts

Artefacts are pretty much unknown from mirrors. For CMS, the key artefacts need to get described and defined. IGCMS proposes provisions with regard to smear, blooming and lens flare and point light sources.

32. Paragraph 6.2.2.3.3.5.1., smear

Smear is a disturbance; it causes partial occlusion of the field of view and of the objects. The requirement value from ISO 16505:2015 was modified from the original allowance of 50 per cent to a stricter 10 per cent to keep in line with other provision for Class V and VI.

33. Paragraph 6.2.2.3.3.5.2., blooming and lens flare

The blooming and lens flare provisions are a copy of the text provided by ISO 16505:2015, and this provision restrict the amount of the maximum allowance of the light expansion when a highlight illumination hits within the CMS field of vision. The provision suggested in ISO 16505:2015 takes into account additional effect of lens flare into consideration, which is not part of the effect in the blooming provision for Class V and VI devices for indirect vision. The provision had been reformulated to cover for the lens flare, making the evaluation of the system performance more accurately correlated to the visual effect, and criteria adapted to cover for the both effect of the device blooming plus the optical lens flare.

34. Paragraph 6.2.2.3.3.5.3., point light sources

A driver in night driving condition observes an overtaking car from behind by observing the passing beam headlamp of those vehicles. This provision is introduced to secure the driver equipped with CMS to observe the passing beam headlamps, or point light source. A mirror renders point light sources as point light sources, whereas CMS may not do so. Some driving scenario may require high reproducibility of the point light source from an overtaking vehicle passing beam light while driving scenario in urban environment

may require observation of the surrounding environment including the road, cyclist and pedestrian rather than observing the point light source itself. Therefore, IGCMS concluded that CMS shall have an operation mode enabling a distinguishable observation of the point light source, and also enable an operation with priority to observe the surrounding environment, rather than focusing only the point light source reproduction. The concept of permitting such operation is similar to the operation of dimming function available in some type of optical mirrors. An operation mode should be available to driver, either manually or automatically, to improve visibility and perception of the point light source of the passing beam according to the driver's needs. IGCMS considered that the provisions given in ISO 16505:2015 are not sufficient and lack a test procedure; IGCMS has developed such a test procedure including performance requirements.

IGCMS has taken into consideration the distance required for the overtaking car to stop the vehicle at relative speed as high as 130 km/h, and adopted 250 m condition to be detectable by the driver of a vehicle with CMS. Overtaking a car at night is expected to be equipped with passing beam according to Regulation No. 112 and test procedure generated to accordingly with additional safety margin considering scenario like road inclination, curves, load unbalance vehicle tilting.

Due to the difficulties in defining a technology independent provision, two different test methods, PLSDF and PLSCF, were adopted and introduced to verify the distinguishability of the point light source according to the output characteristics of the CMS, whichever is adequate.

35. Paragraph 6.2.2.3.3.6.1., sharpness and depth of field

The provisions on "Sharpness and depth of field" are from ISO 16505:2015, and the sharpness provision aims to verify that the system has enough image contrast reproducibility, which is essential to rapid perceptibility of the scene; and the provision on depth of field to secure that observed scene within the target distance are well focused and not blurred and defocused. **Sharp images enable faster perception of the content shown in an image.**

36. Paragraph 6.2.2.3.3.7., geometric distortion

Geometric distortion provisions are taken from ISO 16505:2015 and apply to CMS of Classes I, II and III only. Class IV devices are excluded from this provision as the Class IV mirror does exhibit a huge distortion and IGCMS considers that devices for indirect vision may as well exhibit a similar distortion.

The test procedure described in the ISO 16505 for distortion contain several different definition and informative. Therefore, IGCMS decided to use the specific definition given under Annex G.3 of ISO 16505:2015 for the verification of the distortion and enable a quantitative evaluation.

37. Paragraph 6.2.2.3.3.8.1., flicker

**The entire image area of the monitor shall be free of flicker for at least 90 per cent of the user population.** In the absence of a test method in ISO 16505:2015 for flicker evaluation, IG CMS developed a specific test procedure in Annex 12, paragraph 1.2.1.

38. Paragraph 6.2.2.3.4., time behaviour

The provisions on time behaviour concern frame rate, image formation time and system latency which are copied or derived from ISO. The aim of these provisions is to ensure that system delay is restricted to minimum and secure and enable the driver to make manoeuvring decision in time according to needs while driving. The motion observation through the CMS is likely not to a transversal flow and provision of frame rate requirement in the ISO 16505 is reasonable to secure a smooth flow of the image for the CMS. The



overall image latency is somehow restricted to technologies but it is nevertheless kept to secure the driving decision to be taken without considerable delay.

39. Paragraph 6.2.2.3.5.1., glare due to high luminance of the monitor

The provisions on "glare due to high luminance of the monitor" are copied from ISO without the maximum value of the luminance under night conditions to prevent discomfort glare.

40. Paragraph 6.3.

This section describes the impact test on devices for indirect vision. ~~It has been clarified that the test do not have to be repeated for monitors when the vehicle has already been approved according Regulation No. 21.~~

41. Paragraph 6.3.2.2.4.

This paragraph requires for a camera a similar pendulum test as already specified in Regulation No. 46 for mirrors.

42. Paragraph 6.3.2.2.7.3.

This paragraph requires for a camera a similar impact test as already specified in Regulation No. 46 for mirrors.

43. Paragraph 6.3.3.4.

This paragraph gives the pass criteria for the test above to be performed on a CMS.

44. Paragraph 12.6.

This paragraph gives a definition for ocular reference point to be used in the provisions given in paragraph 16.1.5.2. on the position of the monitor and in paragraph 16.1.5.3. on the obstruction of the driver's view on the monitor.

45. Paragraph 13.5.

For verification of the provisions the application for approval shall also be accompanied by detailed technical specifications of the system, the operator's manual and further documentation specified in Annex 12, paragraph 2.3.

46. Paragraph 15.1.2.

This paragraph is a simplification of the text.

47. Paragraphs 15.2. and 15.2.1.1.

This amendment is needed to make the provisions technology neutral.

48. Paragraph 15.2.1.1.1.

It is necessary to clarify that the minimum number of devices is not relevant for camera-monitor systems and that the number of monitors should not be more than the number of mirrors that would be needed for rendering the required field of vision.

49. Paragraph 15.2.1.1.2.

The text of the present provision has been adapted to take into account the general possibility to replace all classes (except Class VII) of mirrors by CMS and to permit split screen for rendering of more than one field of vision on the same monitor.

50. Paragraph 15.2.1.1.3

The provisions for category L vehicles are not changed with the exemption of the use of the standard terminology for the classes of mirrors.

51. Paragraph 15.2.1.1.4.  
This is an alignment of the text with the new definition of classes (para. 2.4.).
52. Paragraph 15.2.2.4.  
The provision has been adjusted to become technology neutral.
53. Paragraphs 15.2.3.1. and 15.2.3.2.  
These paragraphs specify that the provisions on adjustment apply only to mirrors.
54. Paragraph 15.2.4.4.2.  
Figure 7 has been corrected on the passenger's side so that the indicated dimensions are in correspondence with the front of the grey area.
55. Paragraph 15.2.4.5.13  
The present exemption for vehicles of which the class V mirror is fitted below 2.4 meter, is based on the technical incompatibility to meet the provisions for the extended field of vision on the driver's side. As such an incompatibility does not exist for a CMS the informal group proposes to limit that exemption to mirrors.
56. Paragraph 16.1.1  
The activation and deactivation from CMS are defined in a general manner for most of the use cases. But there might be other specific cases. For examples: cases in which there will be no occupants once a vehicle is locked from outside, or where no CMS is required being in a safe parking environment. Different manner of activation and deactivation may then be suitable and Technical Service shall check the safety concept of these different cases.
57. Paragraph 16.1.1.1.  
Case of Mirror and CMS dual function system is introduced clarifying that the driver must select the CMS mode.
58. Paragraph 16.1.8  
The paragraph in the main text has been deleted, so its justification is deleted accordingly. Renumbering of paragraphs is needed.
59. Paragraph 16.2.  
This section is a copy of the provisions of former paragraph 15.3. and should be part of the new paragraph 16. containing all installation provisions for a CMS.
60. Paragraph 16.2.5.  
This is a consequence of the renumbering of the definitions in paragraph 2.
61. Paragraphs 16. to 22.  
The former paragraphs 16. to 21. have been renumbered due to the insertion of a new paragraph 16. containing the installation provisions for CMS.
62. Paragraph 16.  
Paragraph 16.1. contains the new provisions for Classes I to IV while paragraph 16.2. includes the existing provisions on the installation of Classes V and VI. Where Regulation No. 46 requires for CMS of Classes V and VI the visibility of a critical object, ISO took the approach to use the resolutions and magnification as performance criteria.
63. Paragraph 16.1.

As the provisions in section 16.1. are mainly based on the provisions of ISO and for keeping the number of pages with new text limited, a general statement has been added that for this section the definitions, symbols and test methods from ISO 16505:2015 apply.

64. Paragraph 16.1.1., intended use

This paragraph specifies when the system shall be operational and when it can be de-activated. Most of vehicle occupants are expected to leave the vehicle soon after turning off the engine ignition key. Considering the power management and in combination of safety aspect, IGCMS concludes that a delay longer than (T1=) 120 seconds before turning off the image will permit a large population of vehicle occupant to leave the vehicle. And by an additional (T2=) 300 seconds until an occupant could decide whether they want to continue or recover the CMS operation with an image recovery time shorter than (RT=) one second, will enable the CMS to be used when an occupant leaves the vehicle with some delay after ignition key is turned off. Delay without a reconfirmation of the continuation of need may turn off, with recovery time no longer than 7 seconds, which is also defined as the maximum time allowance for the delay of CMS operation at cold start.

65. Paragraph 16.1.1.1., default view

The system shall have a default view rendering the required field of vision and required resolution and magnification.

66. Paragraph 16.1.1.3., luminance adjustment

For the driver's comfort and adaptation to different environment light condition adaptation, the CMS shall provide ways for the monitor luminance adjustment and such should be provided. The manual adjustment of the luminance shall be explained in the user's manual.

67. Paragraph 16.1.1.4., overlays

With respect to the given requirements on obstructions in Regulation No. 46 (paragraph 15.2.4.9.), the worst case of the obstruction from the required field of view is defined accordingly.

68. Paragraph 16.1.2., operating readiness

CMS being a required safety system for rear vision, the availability of the system shall be obvious and clearly displayed.

69. Paragraph 16.1.3., magnification and resolution

These properties of the CMS define visibility and recognition of objects in the required field of vision. The basic concept used to generate the requirements under ISO 16505:2015 used the viewing magnification and resolution of the scene when a driver observes the backward scene through a type-approved mirror. And the provision developed takes into account the performance of the CMS to keep at least the same spatial resolution to provide comparable scene distinguishability to the traditional mirror. As the magnification on traditional mirrors depends on each mirror class, the provisions for each CMS class were generated accordingly, taking into account the existing type-approved vehicle at the time of ISO 16505:2015 development.

The magnification factors in paragraph 16.1.3.1. were taken from standard ISO 16505:2015. This ISO standard gives in clause 6.5.1. the minimum requirements for the magnification factors for the different classes of devices for indirect view. Paragraph A.3.3. of Annex 3 of the ISO standard recommends the use of recommended requirements for the magnification factors. These recommended requirements were added to paragraph 16.1.3.1. of Regulation No. 46.

However there are currently limitations in the technology for CMS and the size of displays available specifically for CMS of Class II. This does not allow the use of the above-mentioned recommended magnification factors for devices for indirect vision of Class II for the driver and passenger. Instead of the recommended values 0.28 and 0.14 for Class II, the values 0.26 (driver's side) and 0.13 (passenger's side) were used in Regulation No. 46. It should be reviewed at a later phase if the future development of the technology of CMS and the availability of displays of larger size for the automotive sector will allow the use of the magnification factors for devices of Class II as recommended by ISO 16505:2015.

In the traditional mirror, the magnification slightly decreases according to viewing orientation. The generated magnification under ISO 16505:2015 takes the average magnification observed near the centre of the traditional mirror which is reasonable for CMS and secondary, a minimum magnification provision adopted to restrict the minimum equivalent to those observed in a traditional mirror at the peripheral viewing range.

Careful work to generate ISO 16505:2015 requirements provide a provision to secure scene distinguishability performance of the CMS comparable to a traditional type-approved mirror.

Details of the methodology, definition and test method are clearly and precisely provided in ISO 16505:2015. The evaluation takes into account the entire process through the CMS and evaluates the system performance as displayed on the monitor and IGCMS decides that referencing to self-contained ISO 16505:2015 is best to way to define the provision for the CMS.

70. Paragraph 16.1.4., magnification aspect ratio

This provision aims to avoid design of CMS where field of vision is displayed with horizontal and vertical aspect ratio far different from actual original scene, which may lead to a misinterpretation of the scene. The requirement given in ISO 16505:2015 takes into consideration such use cases and is appropriate as a provision for CMS in Regulation No. 46.

71. Paragraph 16.1.5., installation of monitor

These proposals are derived from ISO 16505; however obstruction of the driver's view on the monitor shall not be permitted. Compared to the traditional classes of mirror, the location of the monitor display are no longer restricted to the optical constrain to keep the optical view path to the rear field of vision and CMS have the possibility and capability to provide the required field of vision on a CMS monitor at different and multiple locations of the vehicle. Various studies were conducted by several organizations studying the new possibilities of CMS, considering the user acceptance of the monitor orientation layout and the results showed good acceptance with negligible differences for CMS layout compared to similar orientation layout of traditional optical mirrors regulated under Regulation No. 46, 03 series of amendments. More precisely, a CMS with the image of the right side rendered to the right of the longitudinal plane through the drivers ocular reference point and a similar for the field of view on the left side.

72. Paragraph 16.1.6.

Regulation No. 125 on the driver's direct view may be amended to permit the same exclusion of the obstruction caused by a CMS. That requires an alternative provision within Regulation No. 46 to limit that obstruction to a minimum.

73. Paragraph 16.1.7., decreasing accommodation

For obvious reasons the user's manual shall inform the users, in particular, older persons, that they might use a visual aid to have a sharp view on the monitor.

## 74. Paragraph 16.1.8., safety of electronic systems

IGCMS suggests a verification of the functional safety of CMS, in particular, the measures taken by the manufacturer in case of failures.

## 75. Paragraph 22.15., transitional provisions

This is to correct a wrong reference.

## 76. Dual function system: Paragraph 2.1.13., 6.2.2.3.3.2., 6.2.2.3.3.2.1., 16.1.1.1....

- Mirror and CMS dual function system of class I is introduced, considering that the system shall satisfy each of the requirement when independently operated. The definition is introduced as a new paragraph 2.1.13. In this system, Mirror and CMS dual function system may fully operate as conventional mirror of class I when monitor is not in operation. When the CMS monitor mounted beneath the mirror is operated with appropriate adjustment, it provides field of vision as per CMS. This enables the driver to keep the benefit of a mirror regulated under Regulation No.46 as today, and in addition use a CMS that provides the benefit of this technology whenever the driver wants. The driver is ensured to have the possibility to go back to the mirror mode if for any reason he/she does not feel comfortable with the CMS. This could be for example the case in a convertible vehicle when used without the soft top. The Mirror and CMS dual function system might ease the acceptance of the CMS by experienced drivers and thus the introduction of the CMS technology on the market.
- Including a mirror function, the Mirror and CMS Dual function system must be adjustable (existing requirement of 2.1.1.1). This particular provision is taken into account as an asset for the driver to adapt the orientation of CMS so that:
  - only the standard isotropy range shall be considered
  - the mirrored pyramid of the standard isotropy range may be oriented in a direction where it does not get out of the vehicle.
  - Doing this the driver can avoid any discomfort or disturbing glare, thus decreases the need for testing with high luminance values.
- Night condition contrast of 5:1 was the original requirement of the ISO16505 with the recommendation of 10:1 in consideration of possible human eye night performance alteration. Within the Mirror and CMS Dual Function system, any driver can switch back to mirror at night or at any time, as easily as he/she does it today with a day-night mirror, and the extreme cases may not be considered.
- Descriptive sections of paragraph 6.2.2.3.3.2 and 16.1.1 have been removed.

## 77. Annex 1 and Annex 2:

1. Information documents are necessary for type-approval to provide relevant and detailed specifications to identify the type and to distinguish between its variants. ECE/TRANS/WP.29/GRSG/2015/2 introduces camera-monitor systems for Classes I to IV, including specific requirements. Therefore, new specifications of the CMS become relevant in relation to the performance and compliance with these new requirements. These specifications need to be included in the type-approval documentation accordingly.

2. Annex 1 concerning ‘information documents for type-approval of a device for indirect vision’ already includes CMS of types V and VI. A general wording is added to request additional information for CMS of classes I to IV, where relevant for their performance and within the type definition (informal document GRSG-108-21).

3. Annex 2 concerning ‘information documents for type-approval of a vehicle with respect to the installation of devices for indirect vision’ includes at present only *installation instructions* for devices for indirect vision other than mirrors. Added hereto is the wording “(where appropriate)” since this may not apply to devices of classes I to IV incorporated in the design of the vehicle.

4. Also added is the requirement on detailing specifications of CMS for classes I to IV for the performance in relation to the viewing angle, obstruction, obstruction of direct view, impact testing, etc. This requirement for CMS is in line with the existing requirement for mirrors (items 12.1.1.1. to 4.). Item 12.1.2.2.8. is in line with the information to be submitted to the Technical Service and Approval Authority according to paragraph 3.4. "application for approval".

5. Since ECE/TRANS/WP.29/GRSG/2015/2 concerns the addition of CMS for classes I to IV only, no requirements have been added by this proposal for the classes V and VI.

78. Annex 5

The size of the value "a" of the approval mark may be reduced to 5 mm to permit a smaller marking if space is not sufficient for a marking with a value of 12 mm.

79. Annex 7, paragraph 1.2.2.

This is a consequence of the renumbering of the definitions of paragraph 2.

80. Annexes 10 and 11

The amendments clarify that the annexes will apply to CMS of Classes V and VI, only.

81. Annex 12

This annex contains test methods for CMS of Classes I to IV for which ISO 16505:2015 does not provide sufficient information for such a test. It concerns the flicker test, a test on the recognition of point light sources and a grey scale test. It also contains provisions on the verification of the functional safety aspects and aims at the evaluation of a system in case of failures.

