

EXPLANATIONS TO ECE/TRANS/WP.29/GRE/2016/18

OPTIONAL PERFORMANCE BASED CLASS B1 PASSING BEAM (REG. No 112)

Tomasz Targosinski Ph. D. Eng

Poland

73 GRE 14-17 April 2015

FIXED DESIGN FACTORS INCLUDED IN REQUIREMENTS OF REG. 112

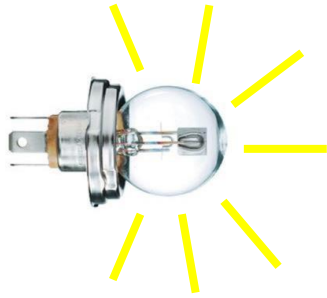

LUMINOUS FLUX
OF LIGHT SOURCE

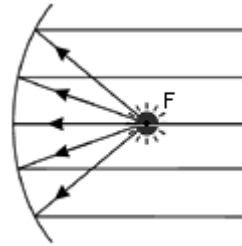

FOCAL DISTANCE
BETWEEN LIGHT SOURCE
AND REFLECTOR

**GEOMETRICAL
SHAPE AND SIZE
OF FILAMENT**



Shield for CUT-OFF

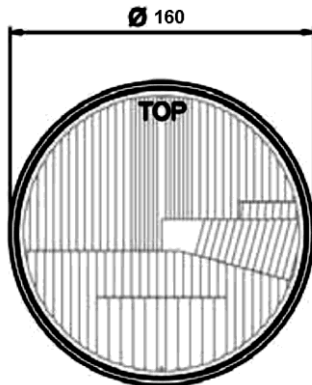

GEOMETRICAL SIZE
OF HEADLAMP

USE OF **„STANDARD” HEADLAMP** (an effective diameter not less than 160 mm)
AND **„ETALON” BULB**

FIXED DESIGN FACTORS

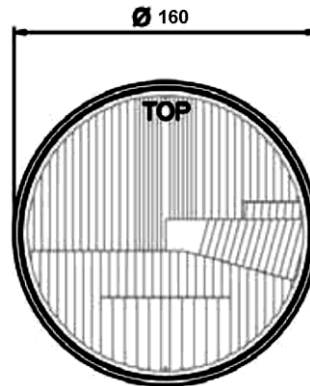
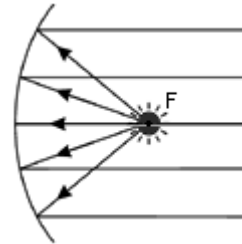
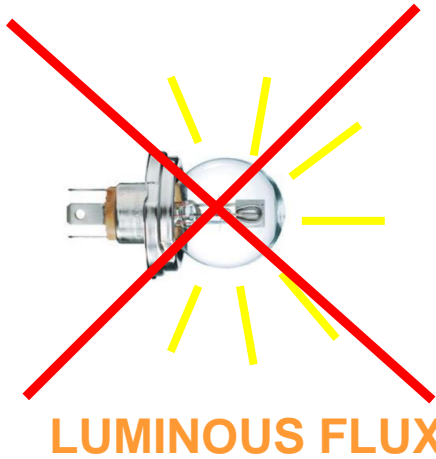

AFTER REMOVING FLUX THE OTHER FACTORS
WILL INFLUENCE THE FINAL QUALITY OF BEAM PATTERN

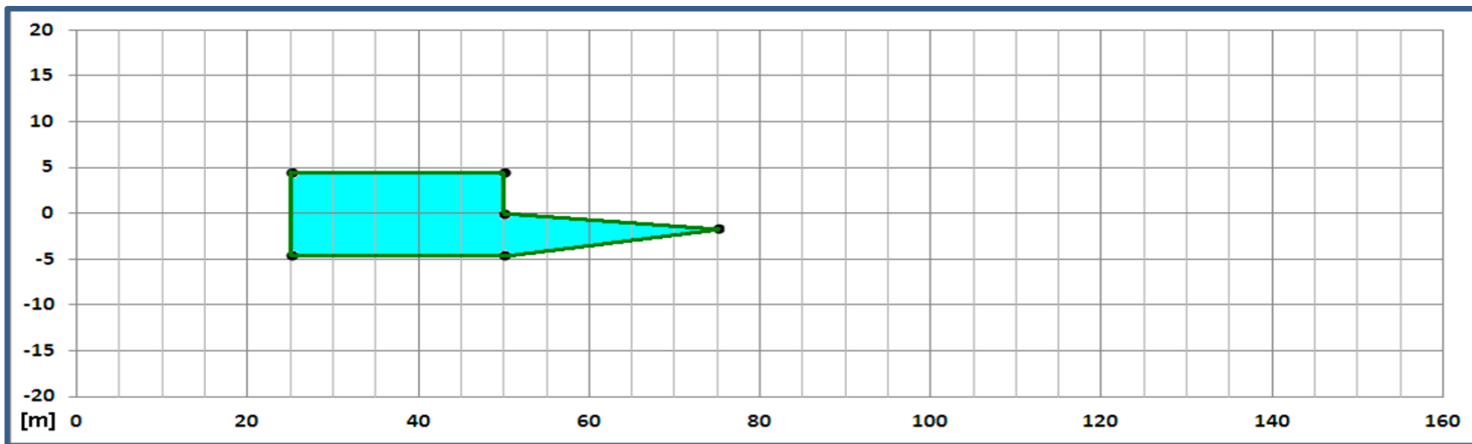

REQUIREMENTS AREA OF EXISTING REG. No. 112

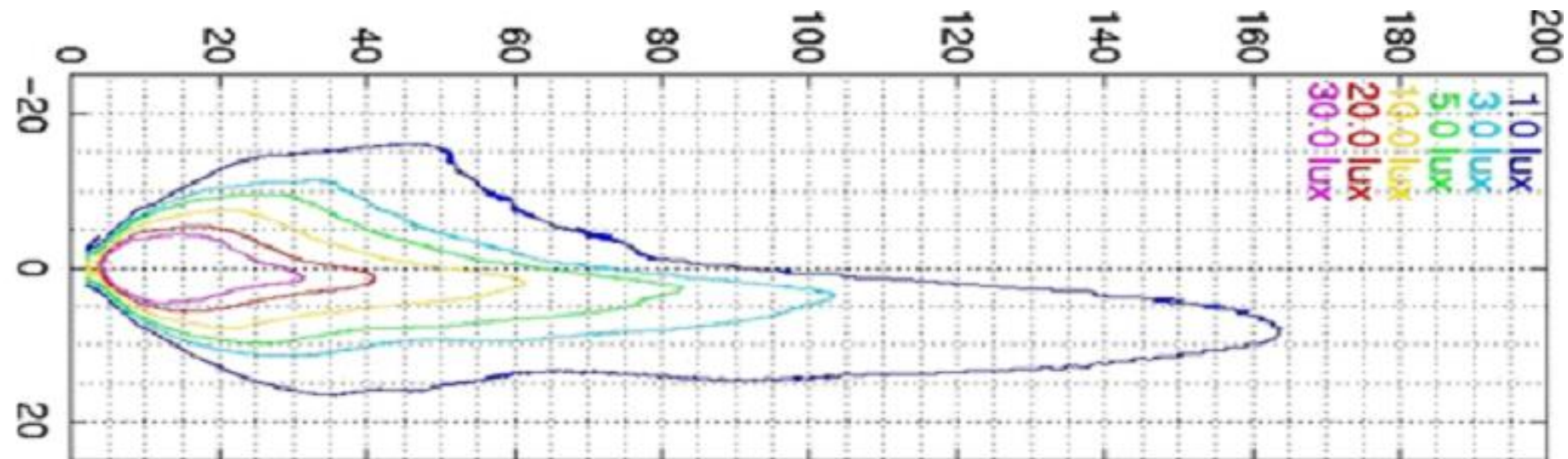

GOOD PERFORMING HALOGEN HEADLAMP
(2004 - TWELVE YEARS OLD)

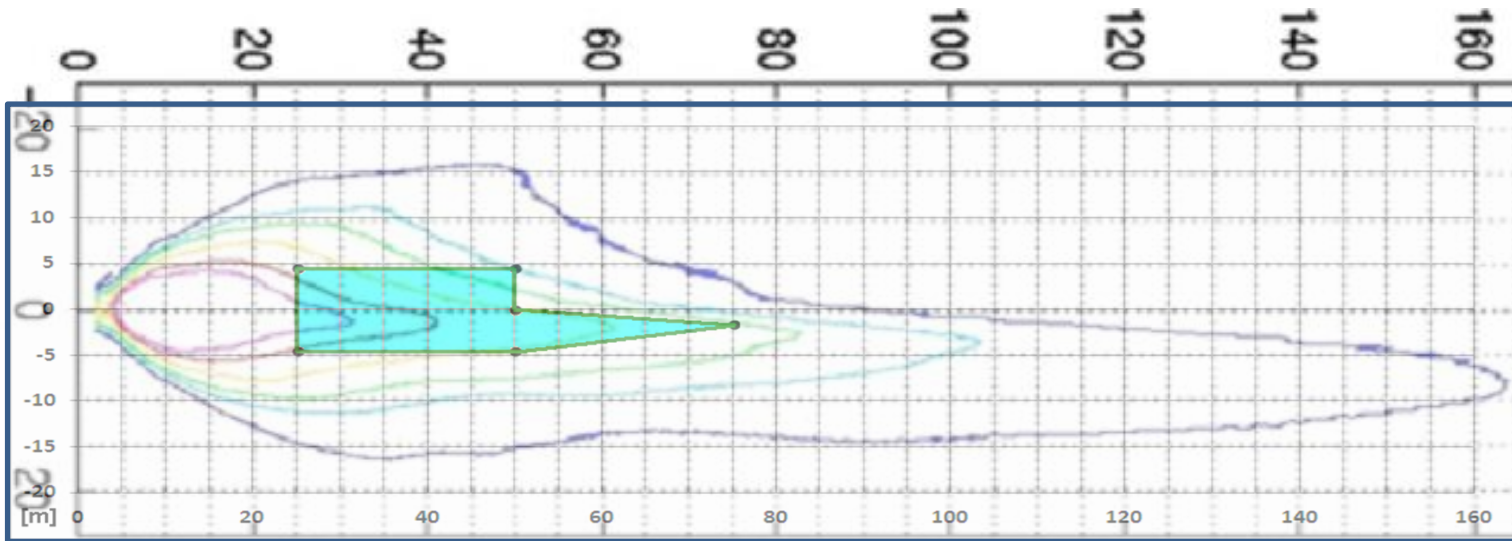

REQUIREMENTS AND TECHNOLOGY POSSIBILITY

Feedback received

PROPOSAL SLIGHTLY MODIFIED

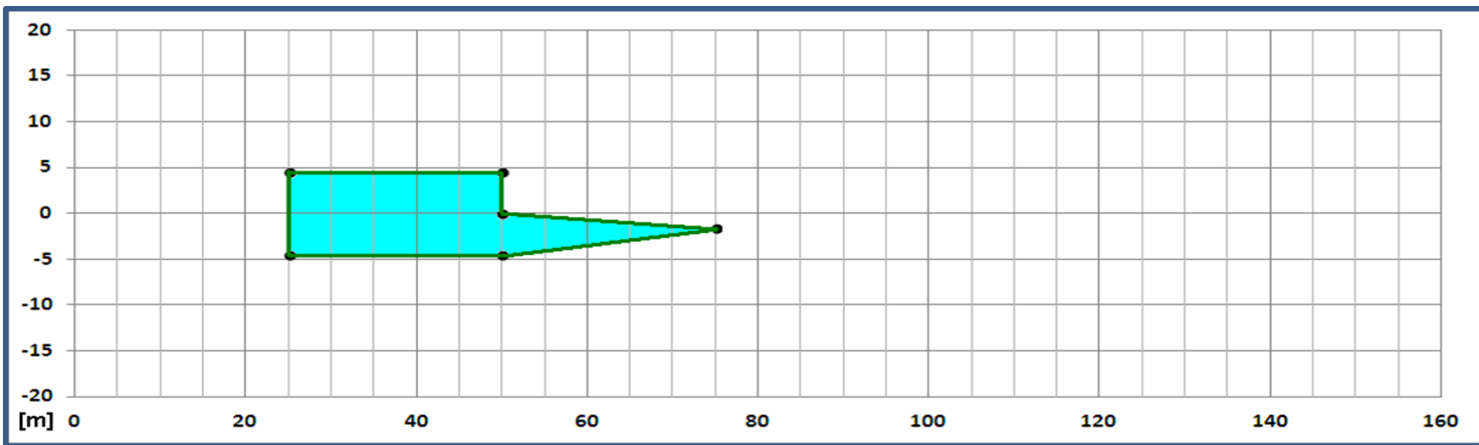

EXISTING AREA OF REQUIREMENTS IN REG. 112

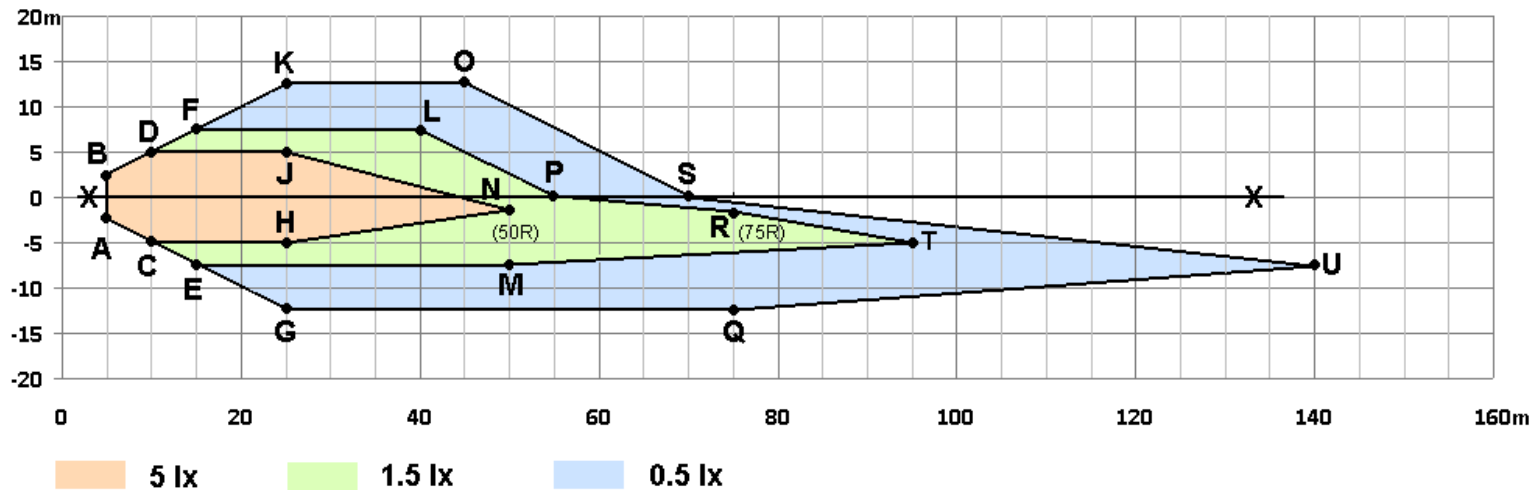

PROPOSED AREA OF REQUIREMENTS AND VALUES (SINGLE HEADLAMP)
Slightly modified according feedback

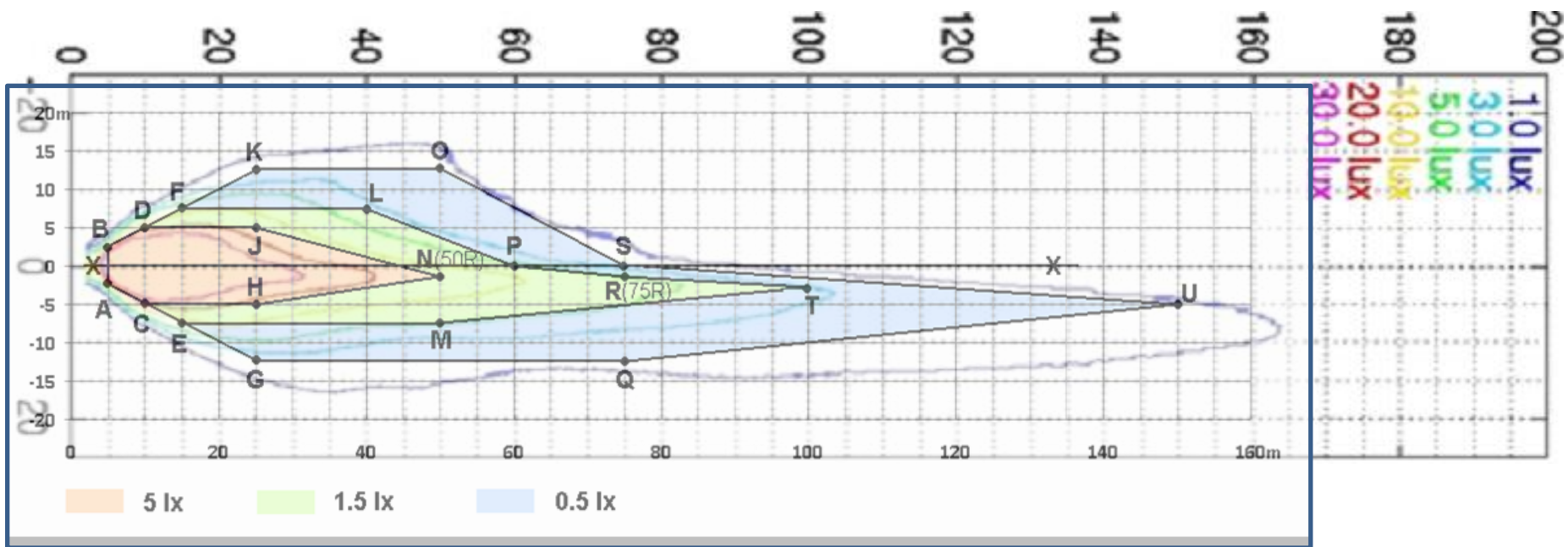

PROPOSED VALUES AND REAL POSSIBILITY
(HALOGEN HEADLAMP – 2004)

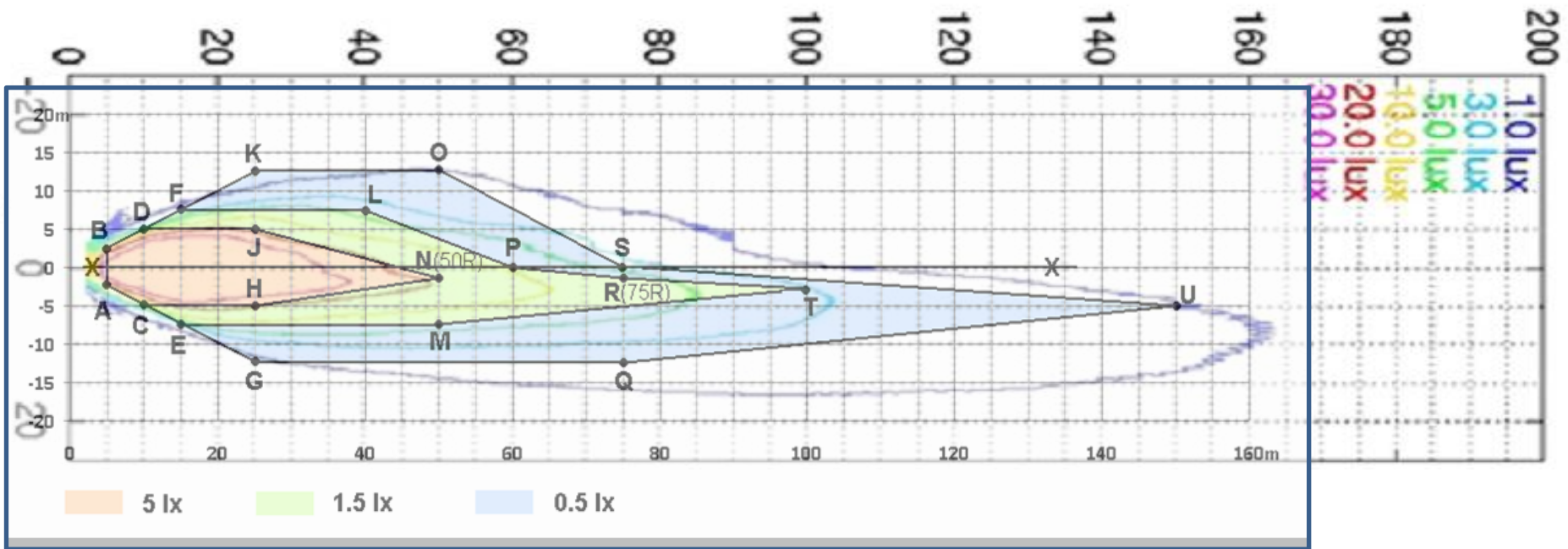

ANOTHER EXAMPLE

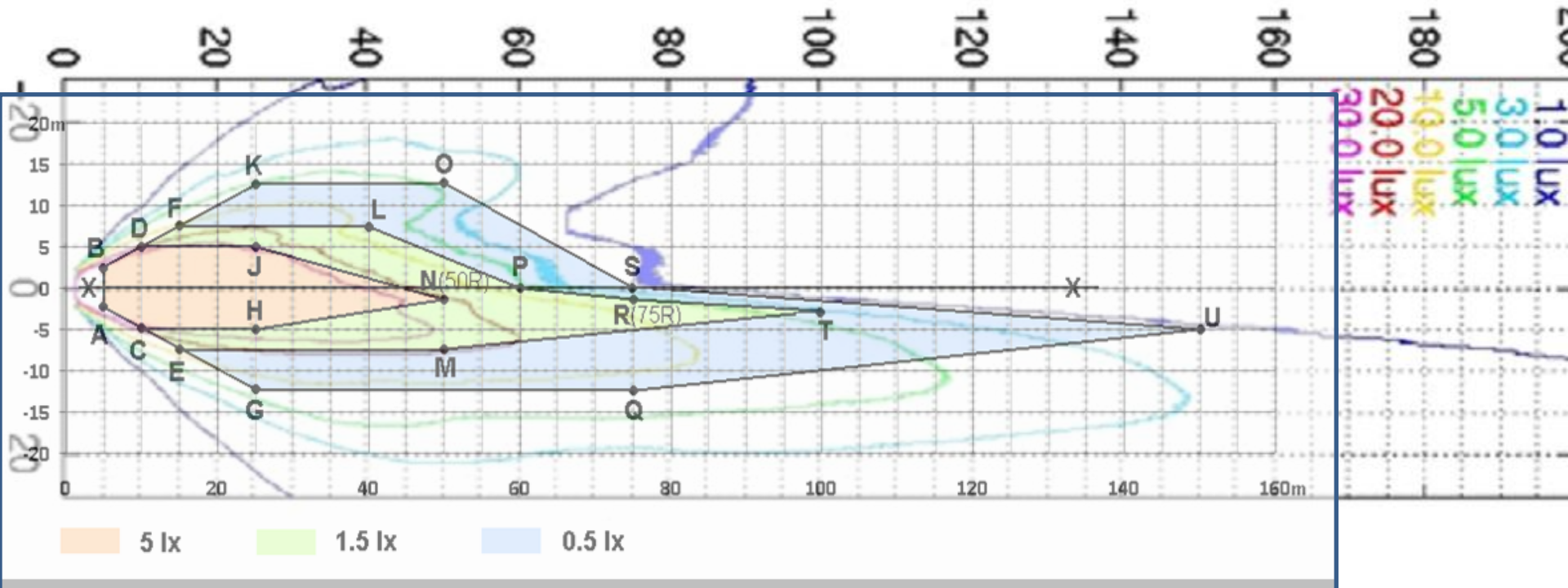

GOOD PERFORMING HID SYSTEM

OPTIONAL REQUIREMENTS (CLASS B1 Reg. 112)

PROFITS:

- REAL PERFORMANCE BASED REQUIREMENTS

- REMOVE ALL OLD "DESIGN" FACTORS

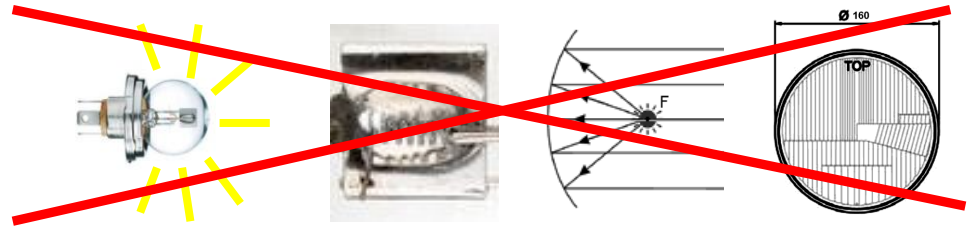

- ALLOW FOR USE ANY LIGHT SOURCE INDEPENDENTLY ON FLUX, POWER, SIZE ETC.

- **OPTIONAL – NO OBLIGATION TO FOLLOW BUT:**

PROFITS:

- OPTIONAL – NO OBLIGATION TO FOLLOW BUT:
 - IF HEADLAMP WILL MEET „STRONGER” (B1 – LED LEVEL) REQUIREMENTS CAN BE EFFECTIVELY PROMOTED/ADVERTISED TO THE CUSTOMERS
 - FREEDOM FOR LED HEADLAMPS - NO NEED TO FOLLOW „1000lm” FLUX REQUIREMENT
 - TIME TO THE FINISH OF SIMPLIFICATION PROCESS CAN BE USED TO COLLECT EXPERIENCE WITHOUT ADDITIONAL EFFORT
 - IN FUTURE WILL BE POSSIBLE CORRECTION (SIMPLIFICATION) OF REQUIREMENTS BEFORE EVENTUAL INTRODUCING IT AS OBLIGATORY
 - NO PROBLEM WITH OBJECTIONS FROM SOME MANUFACTURERS – IT IS NO OBLIGATION TO FOLLOW THIS REQUIREMENTS

**THANK YOU FOR YOUR
ATTENTION**