



Economic and Social Council

Distr.: General
12 April 2019

Original: English

Economic Commission for Europe

Inland Transport Committee

World Forum for Harmonization of Vehicle Regulations

178th session

Geneva, 25-28 June 2019

Item 14.2. of the provisional agenda

Consideration and vote by AC.3 of draft UN GTRs

and/or draft amendments to established UN GTRs, if any

Proposal for Amendment 5 to UN GTR No. 15 (Worldwide harmonized Light vehicles Test Procedures (WLTP))

Submitted by the Working Party on Pollution and Energy*

The text reproduced below was prepared by the Informal Working Group (IWG) on Worldwide harmonized Light vehicles Test Procedure (WLTP). It was adopted by the Working Party on Pollution and Energy (ECE/TRANS/WP.29/GRPE/78, para. 14). It is based on ECE/TRANS/WP.29/GRPE/2019/2 and Addendum 1 of the session report. It is submitted to the World Forum for Harmonization of Vehicle Regulations (WP.29) and to the Executive Committee (AC.3) of the 1998 Agreement for consideration at their June 2018 sessions.

* In accordance with the programme of work of the Inland Transport Committee for 2018–2019 (ECE/TRANS/274, para. 123 and ECE/TRANS/2018/21/Add.1, Cluster 3.1), the World Forum will develop, harmonize and update UN Regulations in order to enhance the performance of vehicles. The present document is submitted in conformity with that mandate.

Amendment 5 to UN GTR No. 15 (Worldwide harmonized Light vehicles Test Procedures (WLTP))

I. Statement of technical rationale and justification

A. Introduction

1. The compliance with emission standards is a central issue of vehicle certification worldwide. Emissions comprise criteria emissions having a direct (mainly local) negative impact on health and environment, as well as pollutants having a negative environmental impact on a global scale. Regulatory emission standards typically are complex documents, describing measurement procedures under a variety of well-defined conditions, setting limit values for emissions, but also defining other elements such as the durability and on-board monitoring of emission control devices.

2. Most manufacturers produce vehicles for a global clientele or at least for several regions. Albeit vehicles are not identical worldwide since vehicle types and models tend to cater to local tastes and living conditions, the compliance with different emission standards in each region creates high burdens from an administrative and vehicle design point of view. Vehicle manufacturers, therefore, have a strong interest in harmonising vehicle emission test procedures and performance requirements as much as possible on a global scale. Regulators also have an interest in global harmonization since it offers more efficient development and adaptation to technical progress, potential collaboration at market surveillance and facilitates the exchange of information between authorities.

3. As a consequence stakeholders launched the work for this United Nations global technical regulation (UN GTR) on Worldwide harmonized Light vehicle Test Procedures (WLTP) that aims at harmonising emission-related test procedures for light duty vehicles to the extent this is possible. Vehicle test procedures need to represent real driving conditions as much as possible to make the performance of vehicles at certification and in real life comparable. Unfortunately, this aspect puts some limitations on the level of harmonization to be achieved, since for instance, ambient temperatures vary widely on a global scale. In addition, due to the different levels of development, different population densities and the costs associated with emission control technology, the regulatory stringency of legislation is expected to be different from region to region for the foreseeable future. The setting of emission limit values, therefore, is not part of this UN GTR for the time being.

4. The purpose of a UN GTR is its implementation into regional legislation by as many Contracting Parties as possible. However, the scope of regional legislations in terms of vehicle categories concerned depends on regional conditions and cannot be predicted for the time being. On the other hand, according to the rules of the 1998 UNECE agreement, Contracting Parties implementing a UN GTR must include all equipment falling into the formal UN GTR scope. Care must be taken, so that an unduly large formal scope of the UN GTR does not prevent its regional implementation. Therefore the formal scope of this UN GTR is kept to the core of light duty vehicles. However, this limitation of the formal UN GTR scope does not indicate that it could not be applied to a larger group of vehicle categories by regional legislation. In fact, Contracting Parties are encouraged to extend the scope of regional implementations of this UN GTR if this is technically, economically and administratively appropriate.

5. This version of the WLTP UN GTR, in particular, does not contain any specific test requirements for dual fuel vehicles and hybrid vehicles not based on a combination of an internal combustion engine and an electric machine. Thus these vehicles are not included in the scope of the WLTP UN GTR. Contracting Parties may, however, apply the WLTP UN GTR provisions to such vehicles to the extent possible and complement them by additional provisions, e.g. emission testing with different fuel grades and types, in regional legislation.

B. Procedural background and future development of the WLTP

6. In its November 2007 session, WP.29 decided to set up an informal WLTP group under GRPE to prepare a road map for the development of WLTP. After various meetings and intense discussions, WLTP presented in June 2009 a first road map consisting of 3 phases, which was subsequently revised a number of times and contains the following main tasks:

(a) Phase 1 (2009 - 2015): development of the worldwide harmonized light duty driving cycle and associated test procedure for the common measurement of criteria compounds, CO₂, fuel and energy consumption;

(b) Phase 2 (2014 - 2018): low temperature/high altitude test procedure, durability, in-service conformity, technical requirements for on-board diagnostics (OBD), mobile air-conditioning (MAC) system energy efficiency, off-cycle/real driving emissions;

(c) Phase 3 (2018 - ...): emission limit values and OBD threshold limits, definition of reference fuels, comparison with regional requirements.

7. It should be noted that since the beginning of the WLTP process, the European Union had a strong political objective set by its own legislation (Regulations (EC) 443/2009 and 510/2011) to implement a new and more realistic test cycle by 2014, which was a major political driving factor for setting the time frame of phase 1.

8. For the work of phase 1 the following working groups and subgroups were established:

(a) Development of Harmonized Cycle (DHC): construction of a new Worldwide Light-duty Test Cycle (WLTC), i.e. the speed trace of the WLTP, based on statistical analysis of real driving data.

The DHC group started working in September 2009, launched the collection of driving data in 2010 and proposed a first version of the driving cycle by mid-2011, which was revised a number of times to take into consideration technical issues such as driveability and a better representation of driving conditions after a first validation.

(b) Development of Test Procedures (DTP): development of test procedures with the following specific expert groups:

(i) PM/PN: Mass of particulate matter and Particle Number (PN) measurements;

(ii) AP: Additional Pollutant measurements, i.e. measurement procedures for exhaust substances which are not yet regulated as compounds but may be regulated in the near future, such as NO₂, ethanol, formaldehyde, acetaldehyde, and ammonia;

(iii) LabProcICE: test conditions and measurement procedures of existing regulated compounds for vehicles equipped with internal combustion engines (other than PM and PN);

(iv) EV-HEV: specific test conditions and measurement procedures for electric and hybrid-electric vehicles;

- (v) Reference fuels: definition of reference fuels.

The DTP group started working in April 2010.

9. During the work of the DTP group it became clear that a number of issues, in particular but not only in relation to electric and hybrid-electric vehicles, could not be resolved in time for an adoption of the first version of the WLTP UN GTR by WP.29 in March 2014. Therefore, it was agreed that the work of Phase 1 would be divided into 2 sub-phases:

- (a) Phase 1a (2009 - 2013): development of the worldwide harmonized light duty driving cycle and the basic test procedure. This led to the first version of this UN GTR, which was published as official working document ECE/TRANS/WP.29/GRPE/2013/13 and a series of amendments published as informal document GRPE-67-04-Rev.1;

- (b) Phase 1b (2013-2015): further development and refinement of the test procedure, while including additional items into the UN GTR.

10. The work for phase 1b was structured according to the following expert groups under the WLTP informal working group:

- (a) UN GTR drafting: coordination over all groups, to ensure that the UN GTR is robust, coherent, and consistent;

- (b) E-lab: specific test conditions and measurement procedures for electric and hybrid-electric vehicles. This was a continuation of the EV-HEV group under phase 1a;

- (c) Taskforces: for each specific topic that has to be integrated in the UN GTR, the informal working group would designate a taskforce leader, who would work in a group with interested stakeholders on developing a testing methodology and a UN GTR text proposal.

An overview of the main topics that were addressed in phase 1b and added to the UN GTR is presented below:

- (a) Pure Internal Combustion Engine (ICE) vehicles:
 - (i) Normalisation methods and speed trace index;
 - (ii) Number of tests;
 - (iii) Wind tunnel as alternative method for road load determination;
 - (iv) Road load matrix family;
 - (v) Interpolation family and road load family concept;
 - (vi) On-board anemometry and wind speed conditions;
 - (vii) Alternative vehicle warm-up procedure;
 - (viii) Calculation and interpolation of fuel consumption.
- (b) Electric and hybrid-electric vehicles (E-lab expert group):
 - (i) Fuel cell vehicle test procedure;
 - (ii) Shortened test procedure for Pure Electric Vehicle (PEV) range test;
 - (iii) Phase-specific CO₂ (fuel consumption) for Off-Vehicle Charging Hybrid Electric Vehicles (OVC-HEVs);
 - (iv) End of Electric Vehicle (EV) range criteria;
 - (v) Interpolation method for OVC-HEVs and PEVs;
 - (vi) Utility factors;

- (vii) Predominant mode / mode selection.
- (c) Alternative pollutants:
Measurement method for ammonia, ethanol, formaldehyde and acetaldehyde.
- (d) Development of the Harmonized driving Cycle (DHC):
 - (i) Further downscaling in Wide Open Throttle (WOT) operation;
 - (ii) Gear shifting.

C. Background on driving cycles and test procedures

11. The development of the worldwide harmonized light duty vehicle driving cycle was based on experience gained from work on the Worldwide Heavy-Duty Certification procedure (WHDC), Worldwide Motorcycle Test Cycle (WMTC) and national cycles.

12. The WLTC is a transient cycle by design. To construct WLTC, driving data from all participating Contracting Parties were collected and weighted according to the relative contribution of regions to the globally driven mileage and data collected for WLTP purpose.

13. The resulting driving data were subsequently cut into idling periods and "short trips" (i.e. driving events between two idling periods). With the above-mentioned weightings the following unified frequency distributions were calculated:

- (a) Short trip duration distribution;
- (b) Stop phase duration distribution;
- (c) Joint vehicle speed acceleration (v, a) distribution.

These distributions together with the averages of vehicle speed, short trip and stop phase durations built the basis for the development of the WLTC speed trace.

By randomised combinations of these segments, a large number of "draft cycles" were generated. From the latter "draft cycle" family, the cycle best fitting the averages/distributions described above was selected as a first "raw WLTC". In the subsequent work, the "raw WLTC" was further processed, in particular with respect to its driveability and better representativeness, to obtain the final WLTC.

14. The driveability of WLTC was assessed extensively during the development process and was supported by three distinct validation phases. Specific cycle versions for certain vehicles with limited driving capabilities due to a low power-to-mass ratio or limited maximum vehicle speed have been introduced. In addition, the speed trace to be followed by a test vehicle will be downscaled according to a mathematically prescribed method if the vehicle would have to encounter an unduly high proportion of "full throttle" driving in order to follow the original speed trace. For vehicles equipped with a manual transmission gear shift points are determined according to a mathematical procedure that is based on the characteristics of individual vehicles, which also enhances the driveability of WLTC.

15. For the development of the test procedures, the DTP subgroup took into account existing emissions and energy consumption legislation, in particular those of the 1958 and 1998 Agreements, those of Japan and the United States Environmental Protection Agency (US EPA) Standard Part 1066. These test procedures were critically reviewed, compared to each other, updated to technical progress and complemented by new elements where necessary.

D. Technical feasibility, anticipated costs and benefits

16. In designing and validating the WLTP, strong emphasis has been put on its practicability, which is ensured by a number of measures explained above.

17. While in general WLTP has been defined on the basis of the best technology available at the moment of its drafting, the practical facilitation of WLTP procedures on a global scale has been kept in mind as well. The latter had some impact e.g. on the definition of set values and tolerances for several test parameters, such as the test temperature or deviations from the speed trace. Also, facilities without the most recent technical equipment should be able to perform WLTP certifications, leading to higher tolerances than those which would have been required just by best performing facilities.

18. The replacement of a regional test cycle by WLTP initially will bear some costs for vehicle manufacturers, technical services and authorities, at least considered on a local scale, since some test equipment and procedures will have to be upgraded. However, these costs should be limited since such upgrades are done regularly as adaptations to the technical progress. Related costs would have to be quantified on a regional level since they largely depend on the local conditions.

19. As pointed out in the technical rationale and justification, the principle of a globally harmonized light duty vehicle test procedure offers potential cost reductions for vehicle manufacturers. The design of vehicles can be better unified on a global scale and administrative procedures may be simplified. The monetary quantification of these benefits depends largely on the extent and timing of implementations of the WLTP in regional legislation.

20. The WLTP provides a higher representation of real driving conditions when compared to the previous regional driving cycles. Therefore, benefits are expected from the resulting consumer information regarding fuel and energy consumption. In addition, a more representative WLTP will set proper incentives for implementing those CO₂ saving vehicle technologies that are also the most effective in real driving. The effectiveness of technology costs relative to the real driving CO₂ savings will, therefore, be improved with respect to existing, less representative driving cycles.

II. Text of the UN GTR

1. Purpose

This United Nations global technical regulation (UN GTR) aims at providing a worldwide harmonized method to determine the levels of emissions of gaseous compounds, particulate matter, particle number, CO₂ emissions, fuel consumption, electric energy consumption and electric range from light-duty vehicles in a repeatable and reproducible manner designed to be representative of real-world vehicle operation. The results will provide the basis for the regulation of these vehicles within regional type approval and certification procedures.

2. Scope and application

This UN GTR applies to vehicles of categories 1-2 and 2, both having a technically permissible maximum laden mass not exceeding 3,500 kg, and to all vehicles of category 1-1.

3. Definitions

3.1. Test equipment

3.1.1. "*Accuracy*" means the difference between a measured value and a reference value, traceable to a national standard and describes the correctness of a result. See Figure 1.

3.1.2. "*Calibration*" means the process of setting a measurement system's response so that its output agrees with a range of reference signals.

3.1.3. "*Calibration gas*" means a gas mixture used to calibrate gas analysers.

3.1.4. "*Double dilution method*" means the process of separating a part of the diluted exhaust flow and mixing it with an appropriate amount of dilution air prior to the particulate sampling filter.

3.1.5. "*Full flow exhaust dilution system*" means the continuous dilution of the total vehicle exhaust with ambient air in a controlled manner using a Constant Volume Sampler (CVS).

3.1.6. "*Linearization*" means the application of a range of concentrations or materials to establish a mathematical relationship between concentration and system response.

3.1.7. "*Major maintenance*" means the adjustment, repair or replacement of a component or module that could affect the accuracy of a measurement.

3.1.8. "*Non-Methane Hydrocarbons*" (NMHC) are the Total Hydrocarbons (THC) minus the methane (CH₄) contribution.

3.1.9. "*Precision*" means the degree to which repeated measurements under unchanged conditions show the same results (Figure 1) and, in this UN GTR, always refers to one standard deviation.

3.1.10. "*Reference value*" means a value traceable to a national standard. See Figure 1.

- 3.1.11. "Set point" means the target value a control system aims to reach.
- 3.1.12. "Span" means to adjust an instrument so that it gives a proper response to a calibration standard that represents between 75 per cent and 100 per cent of the maximum value in the instrument range or expected range of use.
- 3.1.13. "Total hydrocarbons" (THC) means all volatile compounds measurable by a flame ionization detector (FID).
- 3.1.14. "Verification" means to evaluate whether or not a measurement system's outputs agrees with applied reference signals within one or more predetermined thresholds for acceptance.
- 3.1.15. "Zero gas" means a gas containing no analyte which is used to set a zero response on an analyser.
- 3.1.16. "Response time" means the difference in time between the change of the component to be measured at the reference point and a system response of 90 per cent of the final reading (t_{90}) with the sampling probe being defined as the reference point, whereby the change of the measured component is at least 60 per cent full scale (FS) and takes place in less than 0.1 second. The system response time consists of the delay time to the system and of the rise time of the system.
- 3.1.17. "Delay time" means the difference in time between the change of the component to be measured at the reference point and a system response of 10 per cent of the final reading (t_{10}) with the sampling probe being defined as the reference point. For gaseous components, this is the transport time of the measured component from the sampling probe to the detector.
- 3.1.18. "Rise time" means the difference in time between the 10 per cent and 90 per cent response of the final reading ($t_{90} - t_{10}$).

Figure 1
Definition of accuracy, precision and reference value

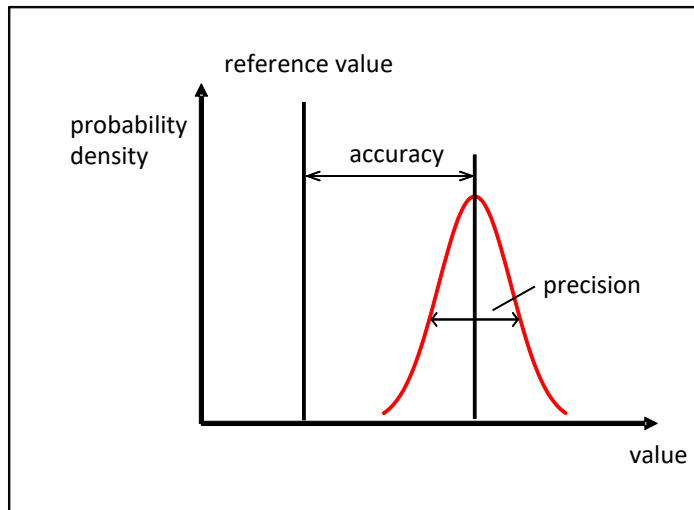

- 3.2. Road load and dynamometer setting
- 3.2.1. "Aerodynamic drag" means the force opposing a vehicle's forward motion through air.

- 3.2.2. "*Aerodynamic stagnation point*" means the point on the surface of a vehicle where wind velocity is equal to zero.
- 3.2.3. "*Anemometer blockage*" means the effect on the anemometer measurement due to the presence of the vehicle where the apparent air speed is different than the vehicle speed combined with wind speed relative to the ground.
- 3.2.4. "*Constrained analysis*" means the vehicle's frontal area and aerodynamic drag coefficient have been independently determined and those values shall be used in the equation of motion.
- 3.2.5. "*Mass in running order*" means the mass of the vehicle, with its fuel tank(s) filled to at least 90 per cent of its or their capacity/capacities, including the mass of the driver, fuel and liquids, fitted with the standard equipment in accordance with the manufacturer's specifications and, when they are fitted, the mass of the bodywork, the cabin, the coupling and the spare wheel(s) as well as the tools.
- 3.2.6. "*Mass of the driver*" means a mass rated at 75 kg located at the driver's seating reference point.
- 3.2.7. "*Maximum vehicle load*" means the technically permissible maximum laden mass minus the mass in running order, 25 kg and the mass of the optional equipment as defined in paragraph 3.2.8. of this UN GTR.
- 3.2.8. "*Mass of the optional equipment*" means maximum mass of the combinations of optional equipment which may be fitted to the vehicle in addition to the standard equipment in accordance with the manufacturer's specifications.
- 3.2.9. "*Optional equipment*" means all the features not included in the standard equipment which are fitted to a vehicle under the responsibility of the manufacturer, and that can be ordered by the customer.
- 3.2.10. "*Reference atmospheric conditions (regarding road load measurements)*" means the atmospheric conditions to which these measurement results are corrected:
- (a) Atmospheric pressure: $p_0 = 100$ kPa;
 - (b) Atmospheric temperature: $T_0 = 20$ °C;
 - (c) Dry air density: $\rho_0 = 1.189$ kg/m³;
 - (d) Wind speed: 0 m/s.
- 3.2.11. "*Reference speed*" means the vehicle speed at which road load is determined or chassis dynamometer load is verified.
- 3.2.12. "*Road load*" means the force resisting the forward motion of a vehicle as measured with the coastdown method or methods that are equivalent regarding the inclusion of frictional losses of the drivetrain.
- 3.2.13. "*Rolling resistance*" means the forces of the tyres opposing the motion of a vehicle.
- 3.2.14. "*Running resistance*" means the torque resisting the forward motion of a vehicle measured by torque meters installed at the driven wheels of a vehicle.
- 3.2.15. "*Simulated road load*" means the road load experienced by the vehicle on the chassis dynamometer which is intended to reproduce the road load measured on the road, and consists of the force applied by the chassis dynamometer and

- the forces resisting the vehicle while driving on the chassis dynamometer and is approximated by the three coefficients of a second order polynomial.
- 3.2.16. "*Simulated running resistance*" means the running resistance experienced by the vehicle on the chassis dynamometer which is intended to reproduce the running resistance measured on the road, and consists of the torque applied by the chassis dynamometer and the torque resisting the vehicle while driving on the chassis dynamometer and is approximated by the three coefficients of a second order polynomial.
- 3.2.17. "*Stationary anemometry*" means measurement of wind speed and direction with an anemometer at a location and height above road level alongside the test road where the most representative wind conditions will be experienced.
- 3.2.18. "*Standard equipment*" means the basic configuration of a vehicle which is equipped with all the features that are required under the regulatory acts of the Contracting Party including all features that are fitted without giving rise to any further specifications on configuration or equipment level.
- 3.2.19. "*Target road load*" means the road load to be reproduced on the chassis dynamometer.
- 3.2.20. "*Target running resistance*" means the running resistance to be reproduced.
- 3.2.21. "*Vehicle coastdown mode*" means a system of operation enabling an accurate and repeatable determination of road load and an accurate dynamometer setting.
- 3.2.22. "*Wind correction*" means correction of the effect of wind on road load based on input of the stationary or on-board anemometry.
- 3.2.23. "*Technically permissible maximum laden mass*" means the maximum mass allocated to a vehicle on the basis of its construction features and its design performances.
- 3.2.24. "*Actual mass of the vehicle*" means the mass in running order plus the mass of the fitted optional equipment to an individual vehicle.
- 3.2.25. "*Test mass of the vehicle*" means the sum of the actual mass of the vehicle, 25 kg and the mass representative of the vehicle load.
- 3.2.26. "*Mass representative of the vehicle load*" means x per cent of the maximum vehicle load where x is 15 per cent for category 1 vehicles and 28 per cent for category 2 vehicles.
- 3.2.27. "*Technically permissible maximum laden mass of the combination*" (MC) means the maximum mass allocated to the combination of a motor vehicle and one or more trailers on the basis of its construction features and its design performances or the maximum mass allocated to the combination of a tractor unit and a semi-trailer.
- 3.2.28. "*n/v ratio*" means the engine rotational speed divided by vehicle speed in a specific gear.
- 3.2.29. "*Single roller dynamometer*" means a dynamometer where each wheel on a vehicle's axle is in contact with one roller.
- 3.2.30. "*Twin-roller dynamometer*" means a dynamometer where each wheel on a vehicle's axle is in contact with two rollers.

- 3.3. Pure electric, pure ICE, hybrid electric, fuel cell and alternatively-fuelled vehicles
- 3.3.1. "*All-Electric Range*" (AER) means the total distance travelled by an OVC-HEV from the beginning of the charge-depleting test to the point in time during the test when the combustion engine starts to consume fuel.
- 3.3.2. "*Pure Electric Range*" (PER) means the total distance travelled by a PEV from the beginning of the charge-depleting test until the break-off criterion is reached.
- 3.3.3. "*Charge-Depleting Actual Range*" (R_{CDA}) means the distance travelled in a series of WLTCs in charge-depleting operating condition until the Rechargeable Electric Energy Storage System (REESS) is depleted.
- 3.3.4. "*Charge-Depleting Cycle Range*" (R_{CDC}) means the distance from the beginning of the charge-depleting test to the end of the last cycle prior to the cycle or cycles satisfying the break-off criterion, including the transition cycle where the vehicle may have operated in both depleting and sustaining conditions.
- 3.3.5. "*Charge-depleting operating condition*" means an operating condition in which the energy stored in the REESS may fluctuate but decreases on average while the vehicle is driven until transition to charge-sustaining operation.
- 3.3.6. "*Charge-sustaining operating condition*" means an operating condition in which the energy stored in the REESS may fluctuate but, on average, is maintained at a neutral charging balance level while the vehicle is driven.
- 3.3.7. "*Utility Factors*" are ratios based on driving statistics depending on the range achieved in charge-depleting condition and are used to weigh the charge-depleting and charge-sustaining exhaust emission compounds, CO₂ emissions and fuel consumption for OVC-HEVs.
- 3.3.8. "*Electric machine*" (EM) means an energy converter transforming between electrical and mechanical energy.
- 3.3.9. "*Energy converter*" means a system where the form of energy output is different from the form of energy input.
- 3.3.9.1. "*Propulsion energy converter*" means an energy converter of the powertrain which is not a peripheral device whose output energy is used directly or indirectly for the purpose of vehicle propulsion.
- 3.3.9.2. "*Category of propulsion energy converter*" means (i) an internal combustion engine, or (ii) an electric machine, or (iii) a fuel cell.
- 3.3.10. "*Energy storage system*" means a system which stores energy and releases it in the same form as was input.
- 3.3.10.1. "*Propulsion energy storage system*" means an energy storage system of the powertrain which is not a peripheral device and whose output energy is used directly or indirectly for the purpose of vehicle propulsion.
- 3.3.10.2. "*Category of propulsion energy storage system*" means (i) a fuel storage system, or (ii) a rechargeable electric energy storage system, or (iii) a rechargeable mechanical energy storage system.
- 3.3.10.3. "*Form of energy*" means (i) electrical energy, or (ii) mechanical energy, or (iii) chemical energy (including fuels).

- 3.3.10.4. "*Fuel storage system*" means a propulsion energy storage system that stores chemical energy as liquid or gaseous fuel.
- 3.3.11. "*Equivalent all-electric range*" (EAER) means that portion of the total charge-depleting actual range (R_{CDA}) attributable to the use of electricity from the REESS over the charge-depleting range test.
- 3.3.12. "*Hybrid electric vehicle*" (HEV) means a hybrid vehicle where one of the propulsion energy converters is an electric machine.
- 3.3.13. "*Hybrid vehicle*" (HV) means a vehicle equipped with a powertrain containing at least two different categories of propulsion energy converters and at least two different categories of propulsion energy storage systems.
- 3.3.14. "*Net energy change*" means the ratio of the REESS energy change divided by the cycle energy demand of the test vehicle.
- 3.3.15. "*Not off-vehicle charging hybrid electric vehicle*" (NOVC-HEV) means a hybrid electric vehicle that cannot be charged from an external source.
- 3.3.16. "*Off-vehicle charging hybrid electric vehicle*" (OVC-HEV) means a hybrid electric vehicle that can be charged from an external source.
- 3.3.17. "*Pure electric vehicle*" (PEV) means a vehicle equipped with a powertrain containing exclusively electric machines as propulsion energy converters and exclusively rechargeable electric energy storage systems as propulsion energy storage systems.
- 3.3.18. "*Fuel cell*" means an energy converter transforming chemical energy (input) into electrical energy (output) or vice versa.
- 3.3.19. "*Fuel cell vehicle*" (FCV) means a vehicle equipped with a powertrain containing exclusively fuel cell(s) and electric machine(s) as propulsion energy converter(s).
- 3.3.20. "*Fuel cell hybrid vehicle*" (FCHV) means a fuel cell vehicle equipped with a powertrain containing at least one fuel storage system and at least one rechargeable electric energy storage system as propulsion energy storage systems.
- 3.3.21. "*Bi-fuel vehicle*" means a vehicle with two separate fuel storage systems that is designed to run primarily on only one fuel at a time; however, the simultaneous use of both fuels is permitted in limited amount and duration.
- 3.3.22. "*Bi-fuel gas vehicle*" means a bi-fuel vehicle where the two fuels are petrol (petrol mode) and either LPG, NG/biomethane, or hydrogen.
- 3.3.23. "*Pure ICE vehicle*" means a vehicle where all of the propulsion energy converters are internal combustion engines.
- 3.3.24. "*On-board charger*" means the electric power converter between the traction REESS and the vehicle's recharging socket.
- 3.4. Powertrain
- 3.4.1. "*Powertrain*" means the total combination in a vehicle of propulsion energy storage system(s), propulsion energy converter(s) and the drivetrain(s) providing the mechanical energy at the wheels for the purpose of vehicle propulsion, plus peripheral devices.
- 3.4.2. "*Auxiliary devices*" means energy consuming, converting, storing or supplying non-peripheral devices or systems which are installed in the vehicle for

purposes other than the propulsion of the vehicle and are therefore not considered to be part of the powertrain.

- 3.4.3. "*Peripheral devices*" means any energy consuming, converting, storing or supplying devices, where the energy is not directly or indirectly used for the purpose of vehicle propulsion but which are essential to the operation of the powertrain and are therefore considered to be part of the powertrain.
- 3.4.4. "*Drivetrain*" means the connected elements of the powertrain for transmission of the mechanical energy between the propulsion energy converter(s) and the wheels.
- 3.4.5. "*Manual transmission*" means a transmission where gears can only be shifted by action of the driver.
- 3.5. General
- 3.5.1. "*Criteria emissions*" means those emission compounds for which limits are set in regional legislation.
- 3.5.2. "*Category 1 vehicle*" means a power-driven vehicle with four or more wheels designed and constructed primarily for the carriage of one or more persons.
- 3.5.3. "*Category 1-1 vehicle*" means a category 1 vehicle comprising not more than eight seating positions in addition to the driver's seating position. A category 1 - 1 vehicle may not have standing passengers.
- 3.5.4. "*Category 1-2 vehicle*" means a category 1 vehicle designed for the carriage of more than eight passengers, whether seated or standing, in addition to the driver.
- 3.5.5. "*Category 2 vehicle*" means a power-driven vehicle with four or more wheels designed and constructed primarily for the carriage of goods. This category shall also include:
- (a) Tractive units;
 - (b) Chassis designed specifically to be equipped with special equipment.
- 3.5.6. "*Cycle energy demand*" means the calculated positive energy required by the vehicle to drive the prescribed cycle.
- 3.5.7. "*Defeat device*" means any element of design which senses temperature, vehicle speed, engine rotational speed, drive gear, manifold vacuum or any other parameter for the purpose of activating, modulating, delaying or deactivating the operation of any part of the emission control system that reduces the effectiveness of the emission control system under conditions which may reasonably be expected to be encountered in normal vehicle operation and use. Such an element of design shall not be considered a defeat device if:
- (a) The need for the device is justified in terms of protecting the engine against damage or accident and for safe operation of the vehicle; or
 - (b) The device does not function beyond the requirements of engine starting; or
 - (c) Conditions are substantially included in the Type 1 test procedures.
- 3.5.8. "*Driver-selectable mode*" means a distinct driver-selectable condition which could affect emissions, or fuel and/or energy consumption.

- 3.5.9. "*Predominant mode*" for the purpose of this UN GTR means a single driver-selectable mode that is always selected when the vehicle is switched on, regardless of the driver-selectable mode in operation when the vehicle was previously shut down, and which cannot be redefined to another mode. After the vehicle is switched on, the predominant mode can only be switched to another driver-selectable mode by an intentional action of the driver.
- 3.5.10. "*Reference conditions (with regards to calculating mass emissions)*" means the conditions upon which gas densities are based, namely 101.325 kPa and 273.15 K (0 °C).
- 3.5.11. "*Exhaust emissions*" means the emission of gaseous, solid and liquid compounds from the tailpipe.
- 3.6. PM/PN
- The term "particle" is conventionally used for the matter being characterised (measured) in the airborne phase (suspended matter), and the term "particulate" for the deposited matter.
- 3.6.1. "*Particle number emissions*" (PN) means the total number of solid particles emitted from the vehicle exhaust quantified according to the dilution, sampling and measurement methods as specified in this UN GTR.
- 3.6.2. "*Particulate matter emissions*" (PM) means the mass of any particulate material from the vehicle exhaust quantified according to the dilution, sampling and measurement methods as specified in this UN GTR.
- 3.7. WLTC
- 3.7.1. "*Rated engine power*" (P_{rated}) means maximum net power of the engine or motor in kW as per the certification procedure based on current regional regulation. In the absence of a definition, the rated engine power shall be declared by the manufacturer according to Regulation No. 85.
- 3.7.2. "*Maximum speed*" (v_{max}) means the maximum speed of a vehicle as defined by the Contracting Party. In the absence of a definition, the maximum speed shall be declared by the manufacturer according to Regulation No. 68.
- 3.8. Procedure
- 3.8.1. "*Periodically regenerating system*" means an exhaust emissions control device (e.g. catalytic converter, particulate trap) that requires a periodical regeneration.

4. Abbreviations

- 4.1. General abbreviations
- | | |
|-----|------------------------------|
| AC | Alternating current |
| CFD | Computational fluid dynamics |
| CFV | Critical flow venturi |
| CFO | Critical flow orifice |
| CLD | Chemiluminescent detector |
| CLA | Chemiluminescent analyser |

| | |
|-------------------------|---|
| CVS | Constant volume sampler |
| DC | Direct current |
| EAF | Sum of ethanol, acetaldehyde and formaldehyde |
| ECD | Electron capture detector |
| ET | Evaporation tube |
| Extra High ₂ | Class 2 WLTC extra high speed phase |
| Extra High ₃ | Class 3 WLTC extra high speed phase |
| FCHV | Fuel cell hybrid vehicle |
| FID | Flame ionization detector |
| FSD | Full scale deflection |
| FTIR | Fourier transform infrared analyser |
| GC | Gas chromatograph |
| HEPA | High efficiency particulate air (filter) |
| HFID | Heated flame ionization detector |
| High ₂ | Class 2 WLTC high speed phase |
| High _{3a} | Class 3a WLTC high speed phase |
| High _{3b} | Class 3b WLTC high speed phase |
| ICE | Internal combustion engine |
| LoD | Limit of detection |
| LoQ | Limit of quantification |
| Low ₁ | Class 1 WLTC low speed phase |
| Low ₂ | Class 2 WLTC low speed phase |
| Low ₃ | Class 3 WLTC low speed phase |
| Medium ₁ | Class 1 WLTC medium speed phase |
| Medium ₂ | Class 2 WLTC medium speed phase |
| Medium _{3a} | Class 3a WLTC medium speed phase |
| Medium _{3b} | Class 3b WLTC medium speed phase |
| LC | Liquid chromatography |
| LDS | Laser diode spectrometer |
| LPG | Liquefied petroleum gas |
| NDIR | Non-dispersive infrared (analyser) |
| NDUV | Non-dispersive ultraviolet |
| NG/biomethane | Natural gas/biomethane |
| NMC | Non-methane cutter |
| NOVC-FCHV | Not off-vehicle charging fuel cell hybrid vehicle |

| | |
|------------------|---|
| NOVC | Not off-vehicle charging |
| NOVC-HEV | Not off-vehicle charging hybrid electric vehicle |
| OVC-HEV | Off-vehicle charging hybrid electric vehicle |
| P _a | Particulate mass collected on the background filter |
| P _e | Particulate mass collected on the sample filter |
| PAO | Poly-alpha-olefin |
| PCF | Particle pre-classifier |
| PCRF | Particle concentration reduction factor |
| PDP | Positive displacement pump |
| PER | Pure electric range |
| Per cent FS | Per cent of full scale |
| PM | Particulate matter emissions |
| PN | Particle number emissions |
| PNC | Particle number counter |
| PND ₁ | First particle number dilution device |
| PND ₂ | Second particle number dilution device |
| PTS | Particle transfer system |
| PTT | Particle transfer tube |
| QCL-IR | Infrared quantum cascade laser |
| R _{CDA} | Charge-depleting actual range |
| RCB | REESS charge balance |
| REESS | Rechargeable electric energy storage system |
| RRC | Rolling resistance coefficient |
| SSV | Subsonic venturi |
| USFM | Ultrasonic flow meter |
| VPR | Volatile particle remover |
| WLTC | Worldwide light-duty test cycle |

4.2. Chemical symbols and abbreviations

| | |
|----------------------------------|---------------------------------|
| C ₁ | Carbon 1 equivalent hydrocarbon |
| CH ₄ | Methane |
| C ₂ H ₆ | Ethane |
| C ₂ H ₅ OH | Ethanol |
| C ₃ H ₈ | Propane |
| CH ₃ CHO | Acetaldehyde |
| CO | Carbon monoxide |

| | |
|------------------|--------------------------|
| CO ₂ | Carbon dioxide |
| DOP | Di-octylphthalate |
| H ₂ O | Water |
| HCHO | Formaldehyde |
| NH ₃ | Ammonia |
| NMHC | Non-methane hydrocarbons |
| NO _x | Oxides of nitrogen |
| NO | Nitric oxide |
| NO ₂ | Nitrogen dioxide |
| N ₂ O | Nitrous oxide |
| THC | Total hydrocarbons |

5. General requirements

5.1. The vehicle and its components liable to affect the emissions of gaseous compounds, particulate matter and particle number shall be so designed, constructed and assembled as to enable the vehicle in normal use and under normal conditions of use such as humidity, rain, snow, heat, cold, sand, dirt, vibrations, wear, etc. to comply with the provisions of this UN GTR during its useful life.

This shall include the security of all hoses, joints and connections used within the emission control systems.

5.2. The test vehicle shall be representative in terms of its emissions-related components and functionality of the intended production series to be covered by the approval. The manufacturer and the responsible authority shall agree which vehicle test model is representative.

5.3. Vehicle testing condition

5.3.1. The types and amounts of lubricants and coolant for emissions testing shall be as specified for normal vehicle operation by the manufacturer.

5.3.2. The type of fuel for emissions testing shall be as specified in Annex 3 of this UN GTR.

5.3.3. All emissions controlling systems shall be in working order.

5.3.4. The use of any defeat device is prohibited.

5.3.5. The engine shall be designed to avoid crankcase emissions.

5.3.6. The tyres used for emissions testing shall be as defined in paragraph 2.4.5. of Annex 6 to this UN GTR.

5.4. Fuel tank inlet orifices

5.4.1. Subject to paragraph 5.4.2. of this UN GTR, the inlet orifice of the petrol or ethanol tank shall be so designed as to prevent the tank from being filled from a fuel pump delivery nozzle that has an external diameter of 23.6 mm or greater.

- 5.4.2. Paragraph 5.4.1. of this UN GTR shall not apply to a vehicle in respect of which both of the following conditions are satisfied:
- (a) The vehicle is so designed and constructed that no device designed to control the emissions shall be adversely affected by leaded petrol; and
 - (b) The vehicle is conspicuously, legibly and indelibly marked with the symbol for unleaded petrol, specified in ISO 2575:2010 "Road vehicles -- Symbols for controls, indicators and tell-tales", in a position immediately visible to a person filling the petrol tank. Additional markings are permitted.
- 5.5. Provisions for electronic system security
- 5.5.1. Any vehicle with an emission control computer shall include features to deter modification, except as authorised by the manufacturer. The manufacturer shall authorise modifications if those modifications are necessary for the diagnosis, servicing, inspection, retrofitting or repair of the vehicle. Any reprogrammable computer codes or operating parameters shall be resistant to tampering and afford a level of protection at least as good as the provisions in ISO 15031-7 (March 15, 2001). Any removable calibration memory chips shall be potted, encased in a sealed container or protected by electronic algorithms and shall not be changeable without the use of specialized tools and procedures.
- 5.5.2. Computer-coded engine operating parameters shall not be changeable without the use of specialized tools and procedures (e.g. soldered or potted computer components or sealed (or soldered) enclosures).
- 5.5.3. Manufacturers may seek approval from the responsible authority for an exemption to one of these requirements for those vehicles that are unlikely to require protection. The criteria that the responsible authority shall evaluate in considering an exemption shall include, but are not limited to, the current availability of performance chips, the high-performance capability of the vehicle and the projected sales volume of the vehicle.
- 5.5.4. Manufacturers using programmable computer code systems shall deter unauthorised reprogramming. Manufacturers shall include enhanced tamper protection strategies and write-protect features requiring electronic access to an off-site computer maintained by the manufacturer. Methods giving an adequate level of tamper protection shall be approved by the responsible authority.
- 5.6. Interpolation family
- 5.6.1. Interpolation family for pure ICE vehicles
- 5.6.1.1. Vehicles may be part of the same interpolation family in any of the following cases including combinations of these cases:
- (a) They belong to different vehicle classes as described in paragraph 2. of Annex 1;
 - (b) They have different levels of downscaling as described in paragraph 8. of Annex 1;
 - (c) They have different capped speeds as described in paragraph 9. of Annex 1.
- 5.6.1.2. Only vehicles that are identical with respect to the following vehicle/power-train/transmission characteristics may be part of the same interpolation family:

- (a) Type of internal combustion engine: fuel type (or types in the case of bi-fuel vehicles), combustion process, engine displacement, full-load characteristics, engine technology, and charging system, and also other engine subsystems or characteristics that have a non-negligible influence on CO₂ mass emission under WLTP conditions;
 - (b) Operation strategy of all CO₂ mass emission influencing components within the powertrain;
 - (c) Transmission type (e.g. manual, automatic, CVT) and transmission model (e.g. torque rating, number of gears, number of clutches, etc.);
 - (d) n/v ratios (engine rotational speed divided by vehicle speed). This requirement shall be considered fulfilled if, for all transmission ratios concerned, the difference with respect to n/v ratios of the most commonly installed transmission type is within 8 per cent;
 - (e) Number of powered axles.
- 5.6.1.3. If an alternative parameter such as a higher n_{\min_drive} , as specified in paragraph 2.(k) of Annex 2, or ASM, as defined in paragraph 3.4. of Annex 2 is used, this parameter shall be the same within an interpolation family.
- 5.6.2. Interpolation family for NOVC-HEVs and OVC-HEVs
- In addition to the requirements of paragraph 5.6.1. of this UN GTR, only OVC-HEVs and NOVC-HEVs that are identical with respect to the following characteristics may be part of the same interpolation family:
- (a) Type and number of electric machines: construction type (asynchronous/ synchronous, etc.), type of coolant (air, liquid) and any other characteristics having a non-negligible influence on CO₂ mass emission and electric energy consumption under WLTP conditions;
 - (b) Type of traction REESS (model, capacity, nominal voltage, nominal power, type of coolant (air, liquid));
 - (c) Type of electric energy converter between the electric machine and traction REESS, between the traction REESS and low voltage power supply and between the recharge-plug-in and traction REESS, and any other characteristics having a non-negligible influence on CO₂ mass emission and electric energy consumption under WLTP conditions;
 - (d) The difference between the number of charge-depleting cycles from the beginning of the test up to and including the transition cycle shall not be more than one.
- 5.6.3. Interpolation family for PEVs
- Only PEVs that are identical with respect to the following electric powertrain/transmission characteristics may be part of the same interpolation family:
- (a) Type and number of electric machines: construction type (asynchronous/ synchronous, etc.), type of coolant (air, liquid) and any other characteristics having a non-negligible influence on electric energy consumption and range under WLTP conditions;
 - (b) Type of traction REESS (model, capacity, nominal voltage, nominal power, type of coolant (air, liquid));

- (c) Transmission type (e.g. manual, automatic, CVT) and transmission model (e.g. torque rating, number of gears, numbers of clutches, etc.);
- (d) Number of powered axles;
- (e) Type of electric energy converter between the electric machine and traction REESS, between the traction REESS and low voltage power supply and between the recharge-plug-in and traction REESS, and any other characteristics having a non-negligible influence on electric energy consumption and range under WLTP conditions;
- (f) Operation strategy of all components influencing the electric energy consumption within the powertrain;
- (g) n/v ratios (engine rotational speed divided by vehicle speed). This requirement shall be considered fulfilled if, for all transmission ratios concerned, the difference with respect to the n/v ratios of the most commonly installed transmission type and model is within 8 per cent.

5.7. Road load family

Only vehicles that are identical with respect to the following characteristics may be part of the same road load family:

- (a) Transmission type (e.g. manual, automatic, CVT) and transmission model (e.g. torque rating, number of gears, number of clutches, etc.). At the request of the manufacturer and with approval of the responsible authority, a transmission with lower power losses may be included in the family;
- (b) n/v ratios (engine rotational speed divided by vehicle speed). This requirement shall be considered fulfilled if, for all transmission ratios concerned, the difference with respect to the transmission ratios of the most commonly installed transmission type is within 25 per cent;
- (c) Number of powered axles.

If at least one electric machine is coupled in the gearbox position neutral and the vehicle is not equipped with a vehicle coastdown mode (paragraph 4.2.1.8.5. of Annex 4) such that the electric machine has no influence on the road load, the criteria in paragraph 5.6.2. (a) of this UN GTR and paragraph 5.6.3. (a) of this UN GTR shall apply.

If there is a difference, apart from vehicle mass, rolling resistance and aerodynamics, that has a non-negligible influence on road load, that vehicle shall not be considered to be part of the family unless approved by the responsible authority.

5.8. Road load matrix family

The road load matrix family may be applied for vehicles with a technically permissible maximum laden mass $\geq 3,000$ kg.

Vehicles with a technically permissible maximum laden mass ≥ 2500 kg may be part of the road load matrix family provided the driver seat R-point height is above 850 mm from the ground.

“R-point” means “R” point or “seating reference point” as defined in paragraph 2.4. of Annex 1 to the Consolidated Resolution on the Construction of Vehicles (R.E.3.).

Only vehicles which are identical with respect to the following characteristics may be part of the same road load matrix family:

- (a) Transmission type (e.g. manual, automatic, CVT);
- (b) Number of powered axles.

5.9. Periodically regenerating systems (K_i) family

Only vehicles that are identical with respect to the following characteristics may be part of the same periodically regenerating systems family:

- (a) Type of internal combustion engine: fuel type, combustion process,
- (b) Periodically regenerating system (i.e. catalyst, particulate trap);
 - (i) Construction (i.e. type of enclosure, type of precious metal, type of substrate, cell density);
 - (ii) Type and working principle;
 - (iii) Volume ± 10 per cent;
 - (iv) Location (temperature ± 100 °C at the second highest reference speed).
- (c) The test mass of each vehicle in the family shall be less than or equal to the test mass of the vehicle used for the K_i demonstration test plus 250 kg.

6. Performance requirements

6.1. Limit values

When implementing the test procedure contained in this UN GTR as part of their national legislation, Contracting Parties to the 1998 Agreement are encouraged to use limit values that represent at least the same level of severity as their existing regulations, pending the development of harmonized limit values, by the Executive Committee (AC.3) of the 1998 Agreement, for inclusion in the UN GTR at a later date.

6.2. Testing

Testing shall be performed according to:

- (a) The WLTCs as described in Annex 1;
- (b) The gear selection and shift point determination as described in Annex 2;
- (c) The appropriate fuel as specified in Annex 3;
- (d) The road load and dynamometer settings as described in Annex 4;
- (e) The test equipment as described in Annex 5;
- (f) The test procedures as described in Annexes 6 and 8;
- (g) The methods of calculation as described in Annexes 7 and 8.

7. Rounding

- 7.1. When the digit immediately to the right of the last place to be retained is less than 5, that digit shall remain unchanged.

Example:

If a result is 1.234 grams but only two places of decimal are to be retained, the final result shall be 1.23 grams.

- 7.2. When the digit immediately to the right of the last place to be retained is greater than or equal to 5, that digit shall be increased by 1.

Example:

If a result is 1.236 grams but only two places of decimal are to be retained, and because 6 is greater than 5, the final result shall be 1.24 grams.

Annex 1

Worldwide light-duty test cycles (WLTC)

1. General requirements

The cycle to be driven depends on the ratio of the test vehicle's rated power to mass in running order minus 75 kg, W/kg, and its maximum velocity, v_{\max} .

The cycle resulting from the requirements described in this annex shall be referred to in other parts of this UN GTR as the "applicable cycle".
2. Vehicle classifications
 - 2.1. Class 1 vehicles have a power to mass in running order minus 75 kg ratio $P_{\text{mr}} \leq 22$ W/kg.
 - 2.2. Class 2 vehicles have a power to mass in running order minus 75 kg ratio > 22 but ≤ 34 W/kg.
 - 2.3. Class 3 vehicles have a power to mass in running order minus 75 kg ratio > 34 W/kg.
 - 2.3.1. Class 3 vehicles are divided into 2 subclasses according to their maximum speed, v_{\max} .
 - 2.3.1.1. Class 3a vehicles with $v_{\max} < 120$ km/h.
 - 2.3.1.2. Class 3b vehicles with $v_{\max} \geq 120$ km/h.
 - 2.3.2. All vehicles tested according to Annex 8 shall be considered to be Class 3 vehicles.
3. Test cycles
 - 3.1. Class 1 cycle
 - 3.1.1. A complete Class 1 cycle shall consist of a low phase (Low_1), a medium phase (Medium_1) and an additional low phase (Low_1).
 - 3.1.2. The Low_1 phase is described in Figure A1/1 and Table A1/1.
 - 3.1.3. The Medium_1 phase is described in Figure A1/2 and Table A1/2.
 - 3.2. Class 2 cycle
 - 3.2.1. A complete Class 2 cycle shall consist of a low phase (Low_2), a medium phase (Medium_2), a high phase (High_2) and an extra high phase (Extra High_2).
 - 3.2.2. The Low_2 phase is described in Figure A1/3 and Table A1/3.
 - 3.2.3. The Medium_2 phase is described in Figure A1/4 and Table A1/4.
 - 3.2.4. The High_2 phase is described in Figure A1/5 and Table A1/5.
 - 3.2.5. The Extra High_2 phase is described in Figure A1/6 and Table A1/6.
 - 3.2.6. At the option of the Contracting Party, the Extra High_2 phase may be excluded.
 - 3.3. Class 3 cycle

Class 3 cycles are divided into 2 subclasses to reflect the subdivision of Class 3 vehicles.

- 3.3.1. Class 3a cycle
 - 3.3.1.1. A complete cycle shall consist of a low phase (Low₃), a medium phase (Medium_{3a}), a high phase (High_{3a}) and an extra high phase (Extra High₃).
 - 3.3.1.2. The Low₃ phase is described in Figure A1/7 and Table A1/7.
 - 3.3.1.3. The Medium_{3a} phase is described in Figure A1/8 and Table A1/8.
 - 3.3.1.4. The High_{3a} phase is described in Figure A1/10 and Table A1/10.
 - 3.3.1.5. The Extra High₃ phase is described in Figure A1/12 and Table A1/12.
 - 3.3.1.6. At the option of the Contracting Party, the Extra High₃ phase may be excluded.
- 3.3.2. Class 3b cycle
 - 3.3.2.1. A complete cycle shall consist of a low phase (Low₃) phase, a medium phase (Medium_{3b}), a high phase (High_{3b}) and an extra high phase (Extra High₃).
 - 3.3.2.2. The Low₃ phase is described in Figure A1/7 and Table A1/7.
 - 3.3.2.3. The Medium_{3b} phase is described in Figure A1/9 and Table A1/9.
 - 3.3.2.4. The High_{3b} phase is described in Figure A1/11 and Table A1/11.
 - 3.3.2.5. The Extra High₃ phase is described in Figure A1/12 and Table A1/12.
 - 3.3.2.6. At the option of the Contracting Party, the Extra High₃ phase may be excluded.
- 3.4. Duration of all phases
 - 3.4.1. All low speed phases last 589 seconds.
 - 3.4.2. All medium speed phases last 433 seconds.
 - 3.4.3. All high speed phases last 455 seconds.
 - 3.4.4. All extra high speed phases last 323 seconds.
- 3.5. WLTC city cycles

OVC-HEVs and PEVs shall be tested using the appropriate Class 3a and Class 3b WLTC and WLTC city cycles (see Annex 8).

The WLTC city cycle consists of the low and medium speed phases only.

At the option of the Contracting Party, the WLTC city may be excluded.
- 4. WLTC Class 1 cycle

Figure A1/1
WLTC, Class 1 cycle, phase Low₁

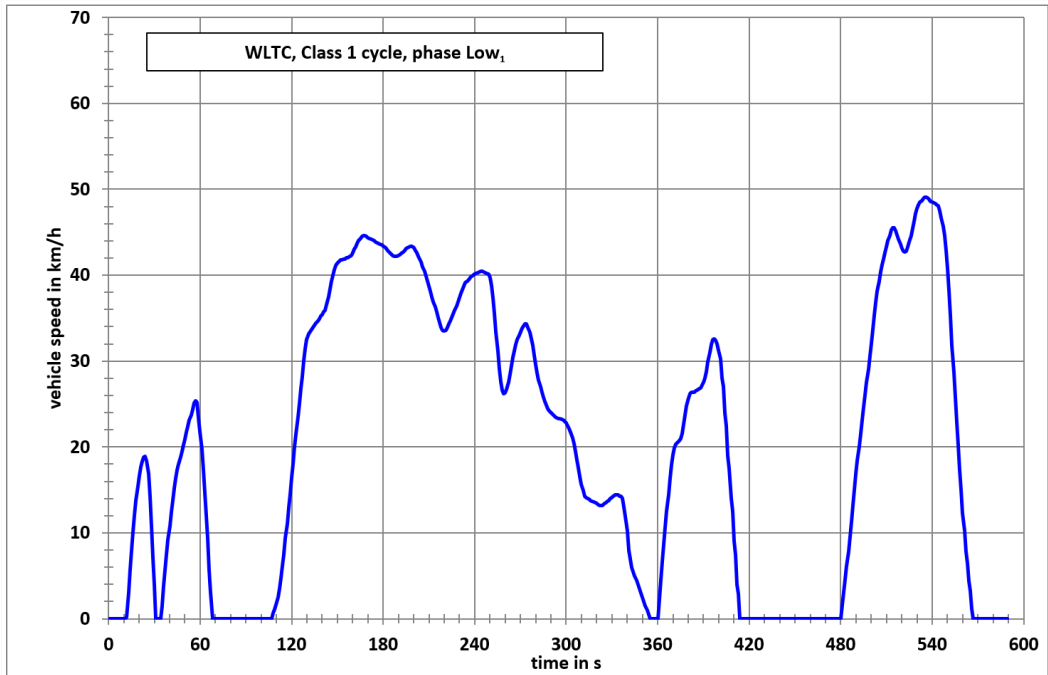

Figure A1/2
WLTC, Class 1 cycle, phase Medium₁

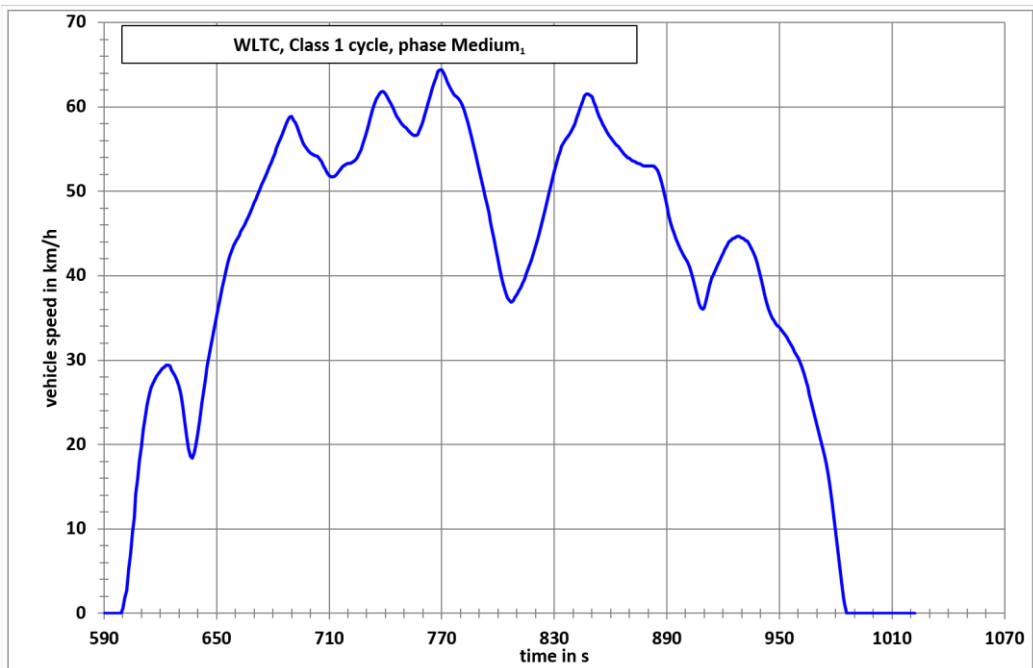

Table A1/1
 WLTC, Class 1 cycle, phase Low₁

| <i>Time in s</i> | <i>Speed in km/h</i> | <i>Time in s</i> | <i>Speed in km/h</i> | <i>Time in s</i> | <i>Speed in km/h</i> | <i>Time in s</i> | <i>Speed in km/h</i> |
|------------------|----------------------|------------------|----------------------|------------------|----------------------|------------------|----------------------|
| 0 | 0.0 | 47 | 18.8 | 94 | 0.0 | 141 | 35.7 |
| 1 | 0.0 | 48 | 19.5 | 95 | 0.0 | 142 | 35.9 |
| 2 | 0.0 | 49 | 20.2 | 96 | 0.0 | 143 | 36.6 |
| 3 | 0.0 | 50 | 20.9 | 97 | 0.0 | 144 | 37.5 |
| 4 | 0.0 | 51 | 21.7 | 98 | 0.0 | 145 | 38.4 |
| 5 | 0.0 | 52 | 22.4 | 99 | 0.0 | 146 | 39.3 |
| 6 | 0.0 | 53 | 23.1 | 100 | 0.0 | 147 | 40.0 |
| 7 | 0.0 | 54 | 23.7 | 101 | 0.0 | 148 | 40.6 |
| 8 | 0.0 | 55 | 24.4 | 102 | 0.0 | 149 | 41.1 |
| 9 | 0.0 | 56 | 25.1 | 103 | 0.0 | 150 | 41.4 |
| 10 | 0.0 | 57 | 25.4 | 104 | 0.0 | 151 | 41.6 |
| 11 | 0.0 | 58 | 25.2 | 105 | 0.0 | 152 | 41.8 |
| 12 | 0.2 | 59 | 23.4 | 106 | 0.0 | 153 | 41.8 |
| 13 | 3.1 | 60 | 21.8 | 107 | 0.0 | 154 | 41.9 |
| 14 | 5.7 | 61 | 19.7 | 108 | 0.7 | 155 | 41.9 |
| 15 | 8.0 | 62 | 17.3 | 109 | 1.1 | 156 | 42.0 |
| 16 | 10.1 | 63 | 14.7 | 110 | 1.9 | 157 | 42.0 |
| 17 | 12.0 | 64 | 12.0 | 111 | 2.5 | 158 | 42.2 |
| 18 | 13.8 | 65 | 9.4 | 112 | 3.5 | 159 | 42.3 |
| 19 | 15.4 | 66 | 5.6 | 113 | 4.7 | 160 | 42.6 |
| 20 | 16.7 | 67 | 3.1 | 114 | 6.1 | 161 | 43.0 |
| 21 | 17.7 | 68 | 0.0 | 115 | 7.5 | 162 | 43.3 |
| 22 | 18.3 | 69 | 0.0 | 116 | 9.4 | 163 | 43.7 |
| 23 | 18.8 | 70 | 0.0 | 117 | 11.0 | 164 | 44.0 |
| 24 | 18.9 | 71 | 0.0 | 118 | 12.9 | 165 | 44.3 |
| 25 | 18.4 | 72 | 0.0 | 119 | 14.5 | 166 | 44.5 |
| 26 | 16.9 | 73 | 0.0 | 120 | 16.4 | 167 | 44.6 |
| 27 | 14.3 | 74 | 0.0 | 121 | 18.0 | 168 | 44.6 |
| 28 | 10.8 | 75 | 0.0 | 122 | 20.0 | 169 | 44.5 |
| 29 | 7.1 | 76 | 0.0 | 123 | 21.5 | 170 | 44.4 |
| 30 | 4.0 | 77 | 0.0 | 124 | 23.5 | 171 | 44.3 |
| 31 | 0.0 | 78 | 0.0 | 125 | 25.0 | 172 | 44.2 |
| 32 | 0.0 | 79 | 0.0 | 126 | 26.8 | 173 | 44.1 |
| 33 | 0.0 | 80 | 0.0 | 127 | 28.2 | 174 | 44.0 |
| 34 | 0.0 | 81 | 0.0 | 128 | 30.0 | 175 | 43.9 |
| 35 | 1.5 | 82 | 0.0 | 129 | 31.4 | 176 | 43.8 |
| 36 | 3.8 | 83 | 0.0 | 130 | 32.5 | 177 | 43.7 |
| 37 | 5.6 | 84 | 0.0 | 131 | 33.2 | 178 | 43.6 |
| 38 | 7.5 | 85 | 0.0 | 132 | 33.4 | 179 | 43.5 |
| 39 | 9.2 | 86 | 0.0 | 133 | 33.7 | 180 | 43.4 |
| 40 | 10.8 | 87 | 0.0 | 134 | 33.9 | 181 | 43.3 |
| 41 | 12.4 | 88 | 0.0 | 135 | 34.2 | 182 | 43.1 |
| 42 | 13.8 | 89 | 0.0 | 136 | 34.4 | 183 | 42.9 |
| 43 | 15.2 | 90 | 0.0 | 137 | 34.7 | 184 | 42.7 |
| 44 | 16.3 | 91 | 0.0 | 138 | 34.9 | 185 | 42.5 |
| 45 | 17.3 | 92 | 0.0 | 139 | 35.2 | 186 | 42.3 |
| 46 | 18.0 | 93 | 0.0 | 140 | 35.4 | 187 | 42.2 |

| <i>Time in s</i> | <i>Speed in km/h</i> | <i>Time in s</i> | <i>Speed in km/h</i> | <i>Time in s</i> | <i>Speed in km/h</i> | <i>Time in s</i> | <i>Speed in km/h</i> |
|------------------|----------------------|------------------|----------------------|------------------|----------------------|------------------|----------------------|
| 188 | 42.2 | 237 | 39.7 | 286 | 25.3 | 335 | 14.3 |
| 189 | 42.2 | 238 | 39.9 | 287 | 24.9 | 336 | 14.3 |
| 190 | 42.3 | 239 | 40.0 | 288 | 24.5 | 337 | 14.0 |
| 191 | 42.4 | 240 | 40.1 | 289 | 24.2 | 338 | 13.0 |
| 192 | 42.5 | 241 | 40.2 | 290 | 24.0 | 339 | 11.4 |
| 193 | 42.7 | 242 | 40.3 | 291 | 23.8 | 340 | 10.2 |
| 194 | 42.9 | 243 | 40.4 | 292 | 23.6 | 341 | 8.0 |
| 195 | 43.1 | 244 | 40.5 | 293 | 23.5 | 342 | 7.0 |
| 196 | 43.2 | 245 | 40.5 | 294 | 23.4 | 343 | 6.0 |
| 197 | 43.3 | 246 | 40.4 | 295 | 23.3 | 344 | 5.5 |
| 198 | 43.4 | 247 | 40.3 | 296 | 23.3 | 345 | 5.0 |
| 199 | 43.4 | 248 | 40.2 | 297 | 23.2 | 346 | 4.5 |
| 200 | 43.2 | 249 | 40.1 | 298 | 23.1 | 347 | 4.0 |
| 201 | 42.9 | 250 | 39.7 | 299 | 23.0 | 348 | 3.5 |
| 202 | 42.6 | 251 | 38.8 | 300 | 22.8 | 349 | 3.0 |
| 203 | 42.2 | 252 | 37.4 | 301 | 22.5 | 350 | 2.5 |
| 204 | 41.9 | 253 | 35.6 | 302 | 22.1 | 351 | 2.0 |
| 205 | 41.5 | 254 | 33.4 | 303 | 21.7 | 352 | 1.5 |
| 206 | 41.0 | 255 | 31.2 | 304 | 21.1 | 353 | 1.0 |
| 207 | 40.5 | 256 | 29.1 | 305 | 20.4 | 354 | 0.5 |
| 208 | 39.9 | 257 | 27.6 | 306 | 19.5 | 355 | 0.0 |
| 209 | 39.3 | 258 | 26.6 | 307 | 18.5 | 356 | 0.0 |
| 210 | 38.7 | 259 | 26.2 | 308 | 17.6 | 357 | 0.0 |
| 211 | 38.1 | 260 | 26.3 | 309 | 16.6 | 358 | 0.0 |
| 212 | 37.5 | 261 | 26.7 | 310 | 15.7 | 359 | 0.0 |
| 213 | 36.9 | 262 | 27.5 | 311 | 14.9 | 360 | 0.0 |
| 214 | 36.3 | 263 | 28.4 | 312 | 14.3 | 361 | 2.2 |
| 215 | 35.7 | 264 | 29.4 | 313 | 14.1 | 362 | 4.5 |
| 216 | 35.1 | 265 | 30.4 | 314 | 14.0 | 363 | 6.6 |
| 217 | 34.5 | 266 | 31.2 | 315 | 13.9 | 364 | 8.6 |
| 218 | 33.9 | 267 | 31.9 | 316 | 13.8 | 365 | 10.6 |
| 219 | 33.6 | 268 | 32.5 | 317 | 13.7 | 366 | 12.5 |
| 220 | 33.5 | 269 | 33.0 | 318 | 13.6 | 367 | 14.4 |
| 221 | 33.6 | 270 | 33.4 | 319 | 13.5 | 368 | 16.3 |
| 222 | 33.9 | 271 | 33.8 | 320 | 13.4 | 369 | 17.9 |
| 223 | 34.3 | 272 | 34.1 | 321 | 13.3 | 370 | 19.1 |
| 224 | 34.7 | 273 | 34.3 | 322 | 13.2 | 371 | 19.9 |
| 225 | 35.1 | 274 | 34.3 | 323 | 13.2 | 372 | 20.3 |
| 226 | 35.5 | 275 | 33.9 | 324 | 13.2 | 373 | 20.5 |
| 227 | 35.9 | 276 | 33.3 | 325 | 13.4 | 374 | 20.7 |
| 228 | 36.4 | 277 | 32.6 | 326 | 13.5 | 375 | 21.0 |
| 229 | 36.9 | 278 | 31.8 | 327 | 13.7 | 376 | 21.6 |
| 230 | 37.4 | 279 | 30.7 | 328 | 13.8 | 377 | 22.6 |
| 231 | 37.9 | 280 | 29.6 | 329 | 14.0 | 378 | 23.7 |
| 232 | 38.3 | 281 | 28.6 | 330 | 14.1 | 379 | 24.8 |
| 233 | 38.7 | 282 | 27.8 | 331 | 14.3 | 380 | 25.7 |
| 234 | 39.1 | 283 | 27.0 | 332 | 14.4 | 381 | 26.2 |
| 235 | 39.3 | 284 | 26.4 | 333 | 14.4 | 382 | 26.4 |
| 236 | 39.5 | 285 | 25.8 | 334 | 14.4 | 383 | 26.4 |

| <i>Time in s</i> | <i>Speed in km/h</i> | <i>Time in s</i> | <i>Speed in km/h</i> | <i>Time in s</i> | <i>Speed in km/h</i> | <i>Time in s</i> | <i>Speed in km/h</i> |
|------------------|----------------------|------------------|----------------------|------------------|----------------------|------------------|----------------------|
| 384 | 26.4 | 433 | 0.0 | 482 | 3.1 | 531 | 48.2 |
| 385 | 26.5 | 434 | 0.0 | 483 | 4.6 | 532 | 48.5 |
| 386 | 26.6 | 435 | 0.0 | 484 | 6.1 | 533 | 48.7 |
| 387 | 26.8 | 436 | 0.0 | 485 | 7.8 | 534 | 48.9 |
| 388 | 26.9 | 437 | 0.0 | 486 | 9.5 | 535 | 49.1 |
| 389 | 27.2 | 438 | 0.0 | 487 | 11.3 | 536 | 49.1 |
| 390 | 27.5 | 439 | 0.0 | 488 | 13.2 | 537 | 49.0 |
| 391 | 28.0 | 440 | 0.0 | 489 | 15.0 | 538 | 48.8 |
| 392 | 28.8 | 441 | 0.0 | 490 | 16.8 | 539 | 48.6 |
| 393 | 29.9 | 442 | 0.0 | 491 | 18.4 | 540 | 48.5 |
| 394 | 31.0 | 443 | 0.0 | 492 | 20.1 | 541 | 48.4 |
| 395 | 31.9 | 444 | 0.0 | 493 | 21.6 | 542 | 48.3 |
| 396 | 32.5 | 445 | 0.0 | 494 | 23.1 | 543 | 48.2 |
| 397 | 32.6 | 446 | 0.0 | 495 | 24.6 | 544 | 48.1 |
| 398 | 32.4 | 447 | 0.0 | 496 | 26.0 | 545 | 47.5 |
| 399 | 32.0 | 448 | 0.0 | 497 | 27.5 | 546 | 46.7 |
| 400 | 31.3 | 449 | 0.0 | 498 | 29.0 | 547 | 45.7 |
| 401 | 30.3 | 450 | 0.0 | 499 | 30.6 | 548 | 44.6 |
| 402 | 28.0 | 451 | 0.0 | 500 | 32.1 | 549 | 42.9 |
| 403 | 27.0 | 452 | 0.0 | 501 | 33.7 | 550 | 40.8 |
| 404 | 24.0 | 453 | 0.0 | 502 | 35.3 | 551 | 38.2 |
| 405 | 22.5 | 454 | 0.0 | 503 | 36.8 | 552 | 35.3 |
| 406 | 19.0 | 455 | 0.0 | 504 | 38.1 | 553 | 31.8 |
| 407 | 17.5 | 456 | 0.0 | 505 | 39.3 | 554 | 28.7 |
| 408 | 14.0 | 457 | 0.0 | 506 | 40.4 | 555 | 25.8 |
| 409 | 12.5 | 458 | 0.0 | 507 | 41.2 | 556 | 22.9 |
| 410 | 9.0 | 459 | 0.0 | 508 | 41.9 | 557 | 20.2 |
| 411 | 7.5 | 460 | 0.0 | 509 | 42.6 | 558 | 17.3 |
| 412 | 4.0 | 461 | 0.0 | 510 | 43.3 | 559 | 15.0 |
| 413 | 2.9 | 462 | 0.0 | 511 | 44.0 | 560 | 12.3 |
| 414 | 0.0 | 463 | 0.0 | 512 | 44.6 | 561 | 10.3 |
| 415 | 0.0 | 464 | 0.0 | 513 | 45.3 | 562 | 7.8 |
| 416 | 0.0 | 465 | 0.0 | 514 | 45.5 | 563 | 6.5 |
| 417 | 0.0 | 466 | 0.0 | 515 | 45.5 | 564 | 4.4 |
| 418 | 0.0 | 467 | 0.0 | 516 | 45.2 | 565 | 3.2 |
| 419 | 0.0 | 468 | 0.0 | 517 | 44.7 | 566 | 1.2 |
| 420 | 0.0 | 469 | 0.0 | 518 | 44.2 | 567 | 0.0 |
| 421 | 0.0 | 470 | 0.0 | 519 | 43.6 | 568 | 0.0 |
| 422 | 0.0 | 471 | 0.0 | 520 | 43.1 | 569 | 0.0 |
| 423 | 0.0 | 472 | 0.0 | 521 | 42.8 | 570 | 0.0 |
| 424 | 0.0 | 473 | 0.0 | 522 | 42.7 | 571 | 0.0 |
| 425 | 0.0 | 474 | 0.0 | 523 | 42.8 | 572 | 0.0 |
| 426 | 0.0 | 475 | 0.0 | 524 | 43.3 | 573 | 0.0 |
| 427 | 0.0 | 476 | 0.0 | 525 | 43.9 | 574 | 0.0 |
| 428 | 0.0 | 477 | 0.0 | 526 | 44.6 | 575 | 0.0 |
| 429 | 0.0 | 478 | 0.0 | 527 | 45.4 | 576 | 0.0 |
| 430 | 0.0 | 479 | 0.0 | 528 | 46.3 | 577 | 0.0 |
| 431 | 0.0 | 480 | 0.0 | 529 | 47.2 | 578 | 0.0 |
| 432 | 0.0 | 481 | 1.6 | 530 | 47.8 | 579 | 0.0 |

| <i>Time in s</i> | <i>Speed in km/h</i> | <i>Time in s</i> | <i>Speed in km/h</i> | <i>Time in s</i> | <i>Speed in km/h</i> | <i>Time in s</i> | <i>Speed in km/h</i> |
|------------------|----------------------|------------------|----------------------|------------------|----------------------|------------------|----------------------|
| 580 | 0.0 | | | | | | |
| 581 | 0.0 | | | | | | |
| 582 | 0.0 | | | | | | |
| 583 | 0.0 | | | | | | |
| 584 | 0.0 | | | | | | |
| 585 | 0.0 | | | | | | |
| 586 | 0.0 | | | | | | |
| 587 | 0.0 | | | | | | |
| 588 | 0.0 | | | | | | |
| 589 | 0.0 | | | | | | |

Table A1/2
 WLTC, Class 1 cycle, phase Medium₁

| <i>Time in s</i> | <i>Speed in km/h</i> | <i>Time in s</i> | <i>Speed in km/h</i> | <i>Time in s</i> | <i>Speed in km/h</i> | <i>Time in s</i> | <i>Speed in km/h</i> |
|------------------|----------------------|------------------|----------------------|------------------|----------------------|------------------|----------------------|
| 590 | 0.0 | 637 | 18.4 | 684 | 56.2 | 731 | 57.9 |
| 591 | 0.0 | 638 | 19.0 | 685 | 56.7 | 732 | 58.8 |
| 592 | 0.0 | 639 | 20.1 | 686 | 57.3 | 733 | 59.6 |
| 593 | 0.0 | 640 | 21.5 | 687 | 57.9 | 734 | 60.3 |
| 594 | 0.0 | 641 | 23.1 | 688 | 58.4 | 735 | 60.9 |
| 595 | 0.0 | 642 | 24.9 | 689 | 58.8 | 736 | 61.3 |
| 596 | 0.0 | 643 | 26.4 | 690 | 58.9 | 737 | 61.7 |
| 597 | 0.0 | 644 | 27.9 | 691 | 58.4 | 738 | 61.8 |
| 598 | 0.0 | 645 | 29.2 | 692 | 58.1 | 739 | 61.8 |
| 599 | 0.0 | 646 | 30.4 | 693 | 57.6 | 740 | 61.6 |
| 600 | 0.6 | 647 | 31.6 | 694 | 56.9 | 741 | 61.2 |
| 601 | 1.9 | 648 | 32.8 | 695 | 56.3 | 742 | 60.8 |
| 602 | 2.7 | 649 | 34.0 | 696 | 55.7 | 743 | 60.4 |
| 603 | 5.2 | 650 | 35.1 | 697 | 55.3 | 744 | 59.9 |
| 604 | 7.0 | 651 | 36.3 | 698 | 55.0 | 745 | 59.4 |
| 605 | 9.6 | 652 | 37.4 | 699 | 54.7 | 746 | 58.9 |
| 606 | 11.4 | 653 | 38.6 | 700 | 54.5 | 747 | 58.6 |
| 607 | 14.1 | 654 | 39.6 | 701 | 54.4 | 748 | 58.2 |
| 608 | 15.8 | 655 | 40.6 | 702 | 54.3 | 749 | 57.9 |
| 609 | 18.2 | 656 | 41.6 | 703 | 54.2 | 750 | 57.7 |
| 610 | 19.7 | 657 | 42.4 | 704 | 54.1 | 751 | 57.5 |
| 611 | 21.8 | 658 | 43.0 | 705 | 53.8 | 752 | 57.2 |
| 612 | 23.2 | 659 | 43.6 | 706 | 53.5 | 753 | 57.0 |
| 613 | 24.7 | 660 | 44.0 | 707 | 53.0 | 754 | 56.8 |
| 614 | 25.8 | 661 | 44.4 | 708 | 52.6 | 755 | 56.6 |
| 615 | 26.7 | 662 | 44.8 | 709 | 52.2 | 756 | 56.6 |
| 616 | 27.2 | 663 | 45.2 | 710 | 51.9 | 757 | 56.7 |
| 617 | 27.7 | 664 | 45.6 | 711 | 51.7 | 758 | 57.1 |
| 618 | 28.1 | 665 | 46.0 | 712 | 51.7 | 759 | 57.6 |
| 619 | 28.4 | 666 | 46.5 | 713 | 51.8 | 760 | 58.2 |
| 620 | 28.7 | 667 | 47.0 | 714 | 52.0 | 761 | 59.0 |
| 621 | 29.0 | 668 | 47.5 | 715 | 52.3 | 762 | 59.8 |
| 622 | 29.2 | 669 | 48.0 | 716 | 52.6 | 763 | 60.6 |
| 623 | 29.4 | 670 | 48.6 | 717 | 52.9 | 764 | 61.4 |
| 624 | 29.4 | 671 | 49.1 | 718 | 53.1 | 765 | 62.2 |
| 625 | 29.3 | 672 | 49.7 | 719 | 53.2 | 766 | 62.9 |
| 626 | 28.9 | 673 | 50.2 | 720 | 53.3 | 767 | 63.5 |
| 627 | 28.5 | 674 | 50.8 | 721 | 53.3 | 768 | 64.2 |
| 628 | 28.1 | 675 | 51.3 | 722 | 53.4 | 769 | 64.4 |
| 629 | 27.6 | 676 | 51.8 | 723 | 53.5 | 770 | 64.4 |
| 630 | 26.9 | 677 | 52.3 | 724 | 53.7 | 771 | 64.0 |
| 631 | 26.0 | 678 | 52.9 | 725 | 54.0 | 772 | 63.5 |
| 632 | 24.6 | 679 | 53.4 | 726 | 54.4 | 773 | 62.9 |
| 633 | 22.8 | 680 | 54.0 | 727 | 54.9 | 774 | 62.4 |
| 634 | 21.0 | 681 | 54.5 | 728 | 55.6 | 775 | 62.0 |
| 635 | 19.5 | 682 | 55.1 | 729 | 56.3 | 776 | 61.6 |
| 636 | 18.6 | 683 | 55.6 | 730 | 57.1 | 777 | 61.4 |

| <i>Time in s</i> | <i>Speed in km/h</i> | <i>Time in s</i> | <i>Speed in km/h</i> | <i>Time in s</i> | <i>Speed in km/h</i> | <i>Time in s</i> | <i>Speed in km/h</i> |
|------------------|----------------------|------------------|----------------------|------------------|----------------------|------------------|----------------------|
| 778 | 61.2 | 827 | 49.7 | 876 | 53.2 | 925 | 44.4 |
| 779 | 61.0 | 828 | 50.6 | 877 | 53.1 | 926 | 44.5 |
| 780 | 60.7 | 829 | 51.6 | 878 | 53.0 | 927 | 44.6 |
| 781 | 60.2 | 830 | 52.5 | 879 | 53.0 | 928 | 44.7 |
| 782 | 59.6 | 831 | 53.3 | 880 | 53.0 | 929 | 44.6 |
| 783 | 58.9 | 832 | 54.1 | 881 | 53.0 | 930 | 44.5 |
| 784 | 58.1 | 833 | 54.7 | 882 | 53.0 | 931 | 44.4 |
| 785 | 57.2 | 834 | 55.3 | 883 | 53.0 | 932 | 44.2 |
| 786 | 56.3 | 835 | 55.7 | 884 | 52.8 | 933 | 44.1 |
| 787 | 55.3 | 836 | 56.1 | 885 | 52.5 | 934 | 43.7 |
| 788 | 54.4 | 837 | 56.4 | 886 | 51.9 | 935 | 43.3 |
| 789 | 53.4 | 838 | 56.7 | 887 | 51.1 | 936 | 42.8 |
| 790 | 52.4 | 839 | 57.1 | 888 | 50.2 | 937 | 42.3 |
| 791 | 51.4 | 840 | 57.5 | 889 | 49.2 | 938 | 41.6 |
| 792 | 50.4 | 841 | 58.0 | 890 | 48.2 | 939 | 40.7 |
| 793 | 49.4 | 842 | 58.7 | 891 | 47.3 | 940 | 39.8 |
| 794 | 48.5 | 843 | 59.3 | 892 | 46.4 | 941 | 38.8 |
| 795 | 47.5 | 844 | 60.0 | 893 | 45.6 | 942 | 37.8 |
| 796 | 46.5 | 845 | 60.6 | 894 | 45.0 | 943 | 36.9 |
| 797 | 45.4 | 846 | 61.3 | 895 | 44.3 | 944 | 36.1 |
| 798 | 44.3 | 847 | 61.5 | 896 | 43.8 | 945 | 35.5 |
| 799 | 43.1 | 848 | 61.5 | 897 | 43.3 | 946 | 35.0 |
| 800 | 42.0 | 849 | 61.4 | 898 | 42.8 | 947 | 34.7 |
| 801 | 40.8 | 850 | 61.2 | 899 | 42.4 | 948 | 34.4 |
| 802 | 39.7 | 851 | 60.5 | 900 | 42.0 | 949 | 34.1 |
| 803 | 38.8 | 852 | 60.0 | 901 | 41.6 | 950 | 33.9 |
| 804 | 38.1 | 853 | 59.5 | 902 | 41.1 | 951 | 33.6 |
| 805 | 37.4 | 854 | 58.9 | 903 | 40.3 | 952 | 33.3 |
| 806 | 37.1 | 855 | 58.4 | 904 | 39.5 | 953 | 33.0 |
| 807 | 36.9 | 856 | 57.9 | 905 | 38.6 | 954 | 32.7 |
| 808 | 37.0 | 857 | 57.5 | 906 | 37.7 | 955 | 32.3 |
| 809 | 37.5 | 858 | 57.1 | 907 | 36.7 | 956 | 31.9 |
| 810 | 37.8 | 859 | 56.7 | 908 | 36.2 | 957 | 31.5 |
| 811 | 38.2 | 860 | 56.4 | 909 | 36.0 | 958 | 31.0 |
| 812 | 38.6 | 861 | 56.1 | 910 | 36.2 | 959 | 30.6 |
| 813 | 39.1 | 862 | 55.8 | 911 | 37.0 | 960 | 30.2 |
| 814 | 39.6 | 863 | 55.5 | 912 | 38.0 | 961 | 29.7 |
| 815 | 40.1 | 864 | 55.3 | 913 | 39.0 | 962 | 29.1 |
| 816 | 40.7 | 865 | 55.0 | 914 | 39.7 | 963 | 28.4 |
| 817 | 41.3 | 866 | 54.7 | 915 | 40.2 | 964 | 27.6 |
| 818 | 41.9 | 867 | 54.4 | 916 | 40.7 | 965 | 26.8 |
| 819 | 42.7 | 868 | 54.2 | 917 | 41.2 | 966 | 26.0 |
| 820 | 43.4 | 869 | 54.0 | 918 | 41.7 | 967 | 25.1 |
| 821 | 44.2 | 870 | 53.9 | 919 | 42.2 | 968 | 24.2 |
| 822 | 45.0 | 871 | 53.7 | 920 | 42.7 | 969 | 23.3 |
| 823 | 45.9 | 872 | 53.6 | 921 | 43.2 | 970 | 22.4 |
| 824 | 46.8 | 873 | 53.5 | 922 | 43.6 | 971 | 21.5 |
| 825 | 47.7 | 874 | 53.4 | 923 | 44.0 | 972 | 20.6 |
| 826 | 48.7 | 875 | 53.3 | 924 | 44.2 | 973 | 19.7 |

| <i>Time in s</i> | <i>Speed in km/h</i> | <i>Time in s</i> | <i>Speed in km/h</i> | <i>Time in s</i> | <i>Speed in km/h</i> | <i>Time in s</i> | <i>Speed in km/h</i> |
|------------------|----------------------|------------------|----------------------|------------------|----------------------|------------------|----------------------|
| 974 | 18.8 | | | | | | |
| 975 | 17.7 | | | | | | |
| 976 | 16.4 | | | | | | |
| 977 | 14.9 | | | | | | |
| 978 | 13.2 | | | | | | |
| 979 | 11.3 | | | | | | |
| 980 | 9.4 | | | | | | |
| 981 | 7.5 | | | | | | |
| 982 | 5.6 | | | | | | |
| 983 | 3.7 | | | | | | |
| 984 | 1.9 | | | | | | |
| 985 | 1.0 | | | | | | |
| 986 | 0.0 | | | | | | |
| 987 | 0.0 | | | | | | |
| 988 | 0.0 | | | | | | |
| 989 | 0.0 | | | | | | |
| 990 | 0.0 | | | | | | |
| 991 | 0.0 | | | | | | |
| 992 | 0.0 | | | | | | |
| 993 | 0.0 | | | | | | |
| 994 | 0.0 | | | | | | |
| 995 | 0.0 | | | | | | |
| 996 | 0.0 | | | | | | |
| 997 | 0.0 | | | | | | |
| 998 | 0.0 | | | | | | |
| 999 | 0.0 | | | | | | |
| 1000 | 0.0 | | | | | | |
| 1001 | 0.0 | | | | | | |
| 1002 | 0.0 | | | | | | |
| 1003 | 0.0 | | | | | | |
| 1004 | 0.0 | | | | | | |
| 1005 | 0.0 | | | | | | |
| 1006 | 0.0 | | | | | | |
| 1007 | 0.0 | | | | | | |
| 1008 | 0.0 | | | | | | |
| 1009 | 0.0 | | | | | | |
| 1010 | 0.0 | | | | | | |
| 1011 | 0.0 | | | | | | |
| 1012 | 0.0 | | | | | | |
| 1013 | 0.0 | | | | | | |
| 1014 | 0.0 | | | | | | |
| 1015 | 0.0 | | | | | | |
| 1016 | 0.0 | | | | | | |
| 1017 | 0.0 | | | | | | |
| 1018 | 0.0 | | | | | | |
| 1019 | 0.0 | | | | | | |
| 1020 | 0.0 | | | | | | |
| 1021 | 0.0 | | | | | | |
| 1022 | 0.0 | | | | | | |

5. WLTC Class 2 cycle

Figure A1/3

WLTC, Class 2 cycle, phase Low₂

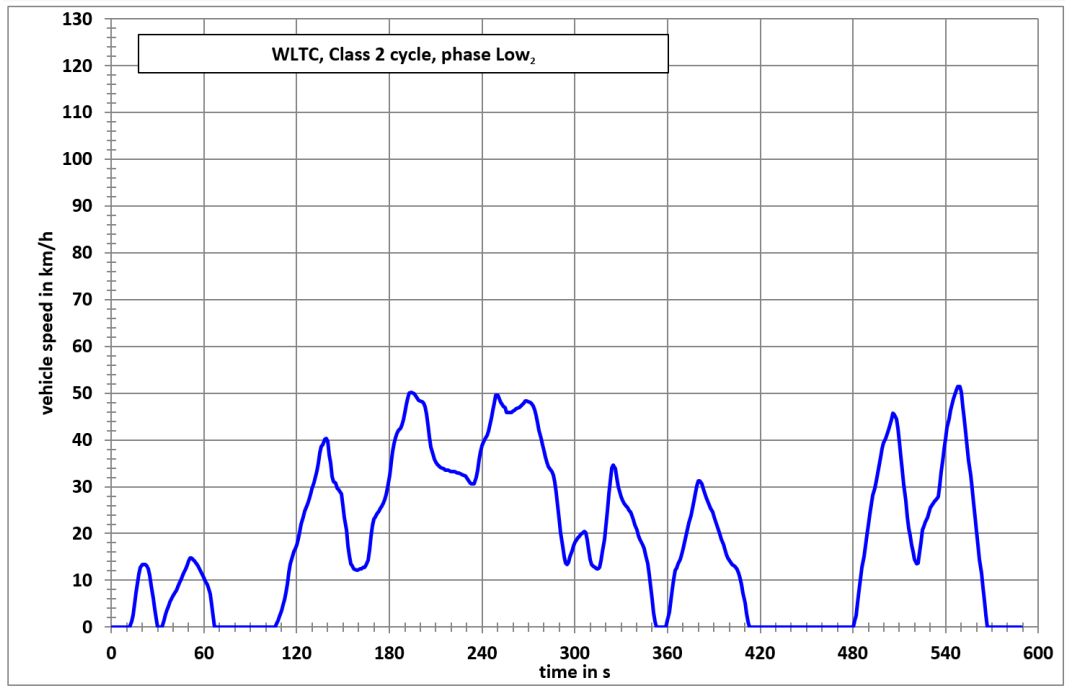

Figure A1/4

WLTC, Class 2 cycle, phase Medium₂

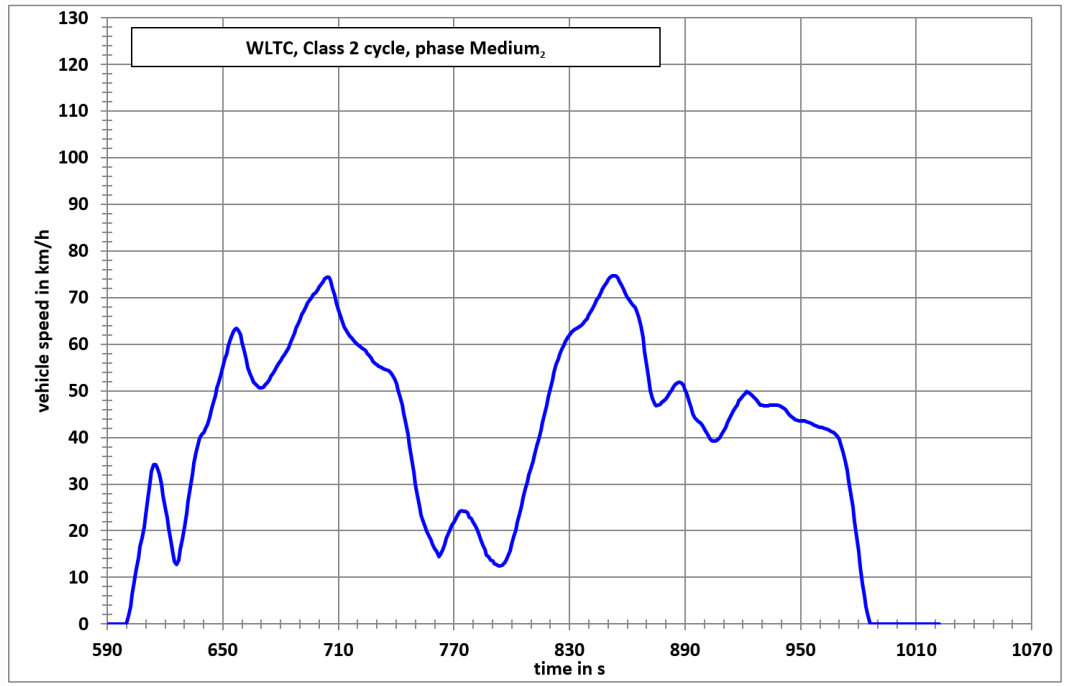

Figure A1/5
WLTC, Class 2 cycle, phase High₂

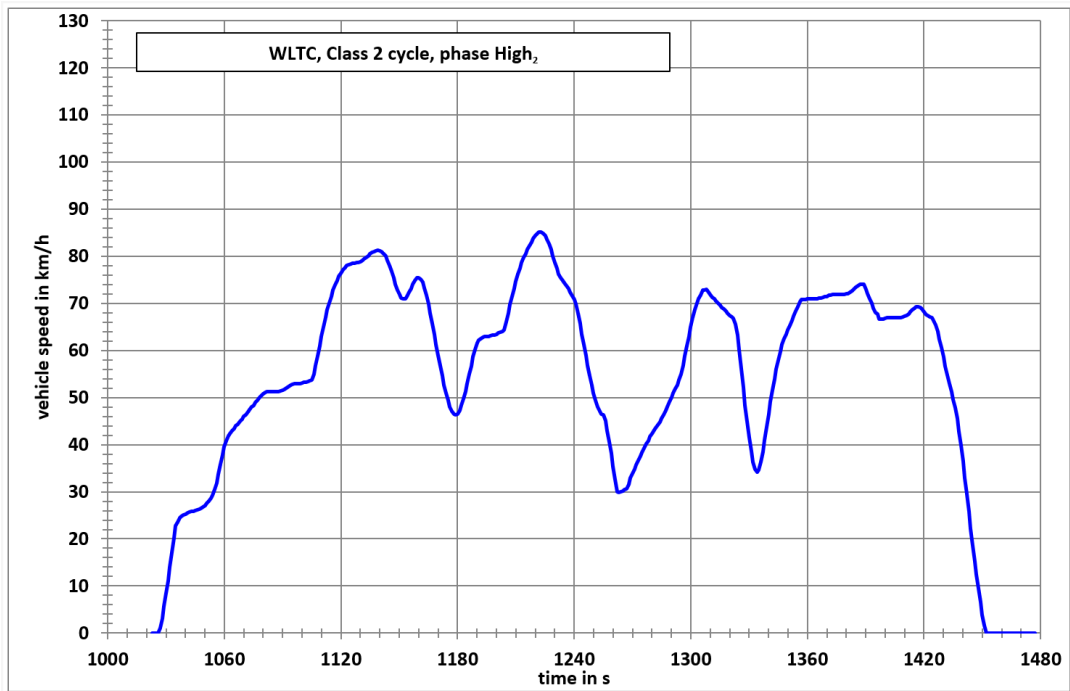

Figure A1/6
WLTC, Class 2 cycle, phase Extra High₂

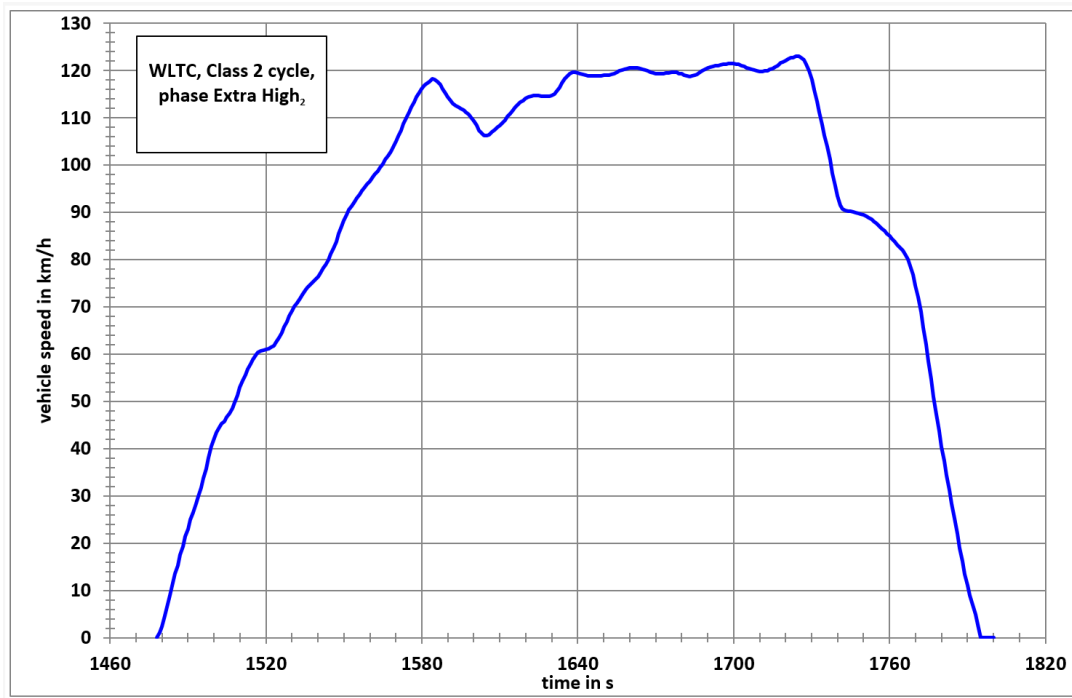

Table A1/3
 WLTC, Class 2 cycle, phase Low₂

| <i>Time in s</i> | <i>Speed in km/h</i> | <i>Time in s</i> | <i>Speed in km/h</i> | <i>Time in s</i> | <i>Speed in km/h</i> | <i>Time in s</i> | <i>Speed in km/h</i> |
|------------------|----------------------|------------------|----------------------|------------------|----------------------|------------------|----------------------|
| 0 | 0.0 | 47 | 11.6 | 94 | 0.0 | 141 | 36.8 |
| 1 | 0.0 | 48 | 12.4 | 95 | 0.0 | 142 | 35.1 |
| 2 | 0.0 | 49 | 13.2 | 96 | 0.0 | 143 | 32.2 |
| 3 | 0.0 | 50 | 14.2 | 97 | 0.0 | 144 | 31.1 |
| 4 | 0.0 | 51 | 14.8 | 98 | 0.0 | 145 | 30.8 |
| 5 | 0.0 | 52 | 14.7 | 99 | 0.0 | 146 | 29.7 |
| 6 | 0.0 | 53 | 14.4 | 100 | 0.0 | 147 | 29.4 |
| 7 | 0.0 | 54 | 14.1 | 101 | 0.0 | 148 | 29.0 |
| 8 | 0.0 | 55 | 13.6 | 102 | 0.0 | 149 | 28.5 |
| 9 | 0.0 | 56 | 13.0 | 103 | 0.0 | 150 | 26.0 |
| 10 | 0.0 | 57 | 12.4 | 104 | 0.0 | 151 | 23.4 |
| 11 | 0.0 | 58 | 11.8 | 105 | 0.0 | 152 | 20.7 |
| 12 | 0.0 | 59 | 11.2 | 106 | 0.0 | 153 | 17.4 |
| 13 | 1.2 | 60 | 10.6 | 107 | 0.8 | 154 | 15.2 |
| 14 | 2.6 | 61 | 9.9 | 108 | 1.4 | 155 | 13.5 |
| 15 | 4.9 | 62 | 9.0 | 109 | 2.3 | 156 | 13.0 |
| 16 | 7.3 | 63 | 8.2 | 110 | 3.5 | 157 | 12.4 |
| 17 | 9.4 | 64 | 7.0 | 111 | 4.7 | 158 | 12.3 |
| 18 | 11.4 | 65 | 4.8 | 112 | 5.9 | 159 | 12.2 |
| 19 | 12.7 | 66 | 2.3 | 113 | 7.4 | 160 | 12.3 |
| 20 | 13.3 | 67 | 0.0 | 114 | 9.2 | 161 | 12.4 |
| 21 | 13.4 | 68 | 0.0 | 115 | 11.7 | 162 | 12.5 |
| 22 | 13.3 | 69 | 0.0 | 116 | 13.5 | 163 | 12.7 |
| 23 | 13.1 | 70 | 0.0 | 117 | 15.0 | 164 | 12.8 |
| 24 | 12.5 | 71 | 0.0 | 118 | 16.2 | 165 | 13.2 |
| 25 | 11.1 | 72 | 0.0 | 119 | 16.8 | 166 | 14.3 |
| 26 | 8.9 | 73 | 0.0 | 120 | 17.5 | 167 | 16.5 |
| 27 | 6.2 | 74 | 0.0 | 121 | 18.8 | 168 | 19.4 |
| 28 | 3.8 | 75 | 0.0 | 122 | 20.3 | 169 | 21.7 |
| 29 | 1.8 | 76 | 0.0 | 123 | 22.0 | 170 | 23.1 |
| 30 | 0.0 | 77 | 0.0 | 124 | 23.6 | 171 | 23.5 |
| 31 | 0.0 | 78 | 0.0 | 125 | 24.8 | 172 | 24.2 |
| 32 | 0.0 | 79 | 0.0 | 126 | 25.6 | 173 | 24.8 |
| 33 | 0.0 | 80 | 0.0 | 127 | 26.3 | 174 | 25.4 |
| 34 | 1.5 | 81 | 0.0 | 128 | 27.2 | 175 | 25.8 |
| 35 | 2.8 | 82 | 0.0 | 129 | 28.3 | 176 | 26.5 |
| 36 | 3.6 | 83 | 0.0 | 130 | 29.6 | 177 | 27.2 |
| 37 | 4.5 | 84 | 0.0 | 131 | 30.9 | 178 | 28.3 |
| 38 | 5.3 | 85 | 0.0 | 132 | 32.2 | 179 | 29.9 |
| 39 | 6.0 | 86 | 0.0 | 133 | 33.4 | 180 | 32.4 |
| 40 | 6.6 | 87 | 0.0 | 134 | 35.1 | 181 | 35.1 |
| 41 | 7.3 | 88 | 0.0 | 135 | 37.2 | 182 | 37.5 |
| 42 | 7.9 | 89 | 0.0 | 136 | 38.7 | 183 | 39.2 |
| 43 | 8.6 | 90 | 0.0 | 137 | 39.0 | 184 | 40.5 |
| 44 | 9.3 | 91 | 0.0 | 138 | 40.1 | 185 | 41.4 |
| 45 | 10 | 92 | 0.0 | 139 | 40.4 | 186 | 42.0 |
| 46 | 10.8 | 93 | 0.0 | 140 | 39.7 | 187 | 42.5 |

| <i>Time in s</i> | <i>Speed in km/h</i> | <i>Time in s</i> | <i>Speed in km/h</i> | <i>Time in s</i> | <i>Speed in km/h</i> | <i>Time in s</i> | <i>Speed in km/h</i> |
|------------------|----------------------|------------------|----------------------|------------------|----------------------|------------------|----------------------|
| 188 | 43.2 | 237 | 33.5 | 286 | 32.5 | 335 | 25.0 |
| 189 | 44.4 | 238 | 35.8 | 287 | 30.9 | 336 | 24.6 |
| 190 | 45.9 | 239 | 37.6 | 288 | 28.6 | 337 | 23.9 |
| 191 | 47.6 | 240 | 38.8 | 289 | 25.9 | 338 | 23.0 |
| 192 | 49.0 | 241 | 39.6 | 290 | 23.1 | 339 | 21.8 |
| 193 | 50.0 | 242 | 40.1 | 291 | 20.1 | 340 | 20.7 |
| 194 | 50.2 | 243 | 40.9 | 292 | 17.3 | 341 | 19.6 |
| 195 | 50.1 | 244 | 41.8 | 293 | 15.1 | 342 | 18.7 |
| 196 | 49.8 | 245 | 43.3 | 294 | 13.7 | 343 | 18.1 |
| 197 | 49.4 | 246 | 44.7 | 295 | 13.4 | 344 | 17.5 |
| 198 | 48.9 | 247 | 46.4 | 296 | 13.9 | 345 | 16.7 |
| 199 | 48.5 | 248 | 47.9 | 297 | 15.0 | 346 | 15.4 |
| 200 | 48.3 | 249 | 49.6 | 298 | 16.3 | 347 | 13.6 |
| 201 | 48.2 | 250 | 49.6 | 299 | 17.4 | 348 | 11.2 |
| 202 | 47.9 | 251 | 48.8 | 300 | 18.2 | 349 | 8.6 |
| 203 | 47.1 | 252 | 48.0 | 301 | 18.6 | 350 | 6.0 |
| 204 | 45.5 | 253 | 47.5 | 302 | 19.0 | 351 | 3.1 |
| 205 | 43.2 | 254 | 47.1 | 303 | 19.4 | 352 | 1.2 |
| 206 | 40.6 | 255 | 46.9 | 304 | 19.8 | 353 | 0.0 |
| 207 | 38.5 | 256 | 45.8 | 305 | 20.1 | 354 | 0.0 |
| 208 | 36.9 | 257 | 45.8 | 306 | 20.5 | 355 | 0.0 |
| 209 | 35.9 | 258 | 45.8 | 307 | 20.2 | 356 | 0.0 |
| 210 | 35.3 | 259 | 45.9 | 308 | 18.6 | 357 | 0.0 |
| 211 | 34.8 | 260 | 46.2 | 309 | 16.5 | 358 | 0.0 |
| 212 | 34.5 | 261 | 46.4 | 310 | 14.4 | 359 | 0.0 |
| 213 | 34.2 | 262 | 46.6 | 311 | 13.4 | 360 | 1.4 |
| 214 | 34.0 | 263 | 46.8 | 312 | 12.9 | 361 | 3.2 |
| 215 | 33.8 | 264 | 47.0 | 313 | 12.7 | 362 | 5.6 |
| 216 | 33.6 | 265 | 47.3 | 314 | 12.4 | 363 | 8.1 |
| 217 | 33.5 | 266 | 47.5 | 315 | 12.4 | 364 | 10.3 |
| 218 | 33.5 | 267 | 47.9 | 316 | 12.8 | 365 | 12.1 |
| 219 | 33.4 | 268 | 48.3 | 317 | 14.1 | 366 | 12.6 |
| 220 | 33.3 | 269 | 48.3 | 318 | 16.2 | 367 | 13.6 |
| 221 | 33.3 | 270 | 48.2 | 319 | 18.8 | 368 | 14.5 |
| 222 | 33.2 | 271 | 48.0 | 320 | 21.9 | 369 | 15.6 |
| 223 | 33.1 | 272 | 47.7 | 321 | 25.0 | 370 | 16.8 |
| 224 | 33.0 | 273 | 47.2 | 322 | 28.4 | 371 | 18.2 |
| 225 | 32.9 | 274 | 46.5 | 323 | 31.3 | 372 | 19.6 |
| 226 | 32.8 | 275 | 45.2 | 324 | 34.0 | 373 | 20.9 |
| 227 | 32.7 | 276 | 43.7 | 325 | 34.6 | 374 | 22.3 |
| 228 | 32.5 | 277 | 42.0 | 326 | 33.9 | 375 | 23.8 |
| 229 | 32.3 | 278 | 40.4 | 327 | 31.9 | 376 | 25.4 |
| 230 | 31.8 | 279 | 39.0 | 328 | 30.0 | 377 | 27.0 |
| 231 | 31.4 | 280 | 37.7 | 329 | 29.0 | 378 | 28.6 |
| 232 | 30.9 | 281 | 36.4 | 330 | 27.9 | 379 | 30.2 |
| 233 | 30.6 | 282 | 35.2 | 331 | 27.1 | 380 | 31.2 |
| 234 | 30.6 | 283 | 34.3 | 332 | 26.4 | 381 | 31.2 |
| 235 | 30.7 | 284 | 33.8 | 333 | 25.9 | 382 | 30.7 |
| 236 | 32.0 | 285 | 33.3 | 334 | 25.5 | 383 | 29.5 |

| <i>Time in s</i> | <i>Speed in km/h</i> | <i>Time in s</i> | <i>Speed in km/h</i> | <i>Time in s</i> | <i>Speed in km/h</i> | <i>Time in s</i> | <i>Speed in km/h</i> |
|------------------|----------------------|------------------|----------------------|------------------|----------------------|------------------|----------------------|
| 384 | 28.6 | 433 | 0.0 | 482 | 2.5 | 531 | 26.0 |
| 385 | 27.7 | 434 | 0.0 | 483 | 5.2 | 532 | 26.5 |
| 386 | 26.9 | 435 | 0.0 | 484 | 7.9 | 533 | 26.9 |
| 387 | 26.1 | 436 | 0.0 | 485 | 10.3 | 534 | 27.3 |
| 388 | 25.4 | 437 | 0.0 | 486 | 12.7 | 535 | 27.9 |
| 389 | 24.6 | 438 | 0.0 | 487 | 15.0 | 536 | 30.3 |
| 390 | 23.6 | 439 | 0.0 | 488 | 17.4 | 537 | 33.2 |
| 391 | 22.6 | 440 | 0.0 | 489 | 19.7 | 538 | 35.4 |
| 392 | 21.7 | 441 | 0.0 | 490 | 21.9 | 539 | 38.0 |
| 393 | 20.7 | 442 | 0.0 | 491 | 24.1 | 540 | 40.1 |
| 394 | 19.8 | 443 | 0.0 | 492 | 26.2 | 541 | 42.7 |
| 395 | 18.8 | 444 | 0.0 | 493 | 28.1 | 542 | 44.5 |
| 396 | 17.7 | 445 | 0.0 | 494 | 29.7 | 543 | 46.3 |
| 397 | 16.6 | 446 | 0.0 | 495 | 31.3 | 544 | 47.6 |
| 398 | 15.6 | 447 | 0.0 | 496 | 33.0 | 545 | 48.8 |
| 399 | 14.8 | 448 | 0.0 | 497 | 34.7 | 546 | 49.7 |
| 400 | 14.3 | 449 | 0.0 | 498 | 36.3 | 547 | 50.6 |
| 401 | 13.8 | 450 | 0.0 | 499 | 38.1 | 548 | 51.4 |
| 402 | 13.4 | 451 | 0.0 | 500 | 39.4 | 549 | 51.4 |
| 403 | 13.1 | 452 | 0.0 | 501 | 40.4 | 550 | 50.2 |
| 404 | 12.8 | 453 | 0.0 | 502 | 41.2 | 551 | 47.1 |
| 405 | 12.3 | 454 | 0.0 | 503 | 42.1 | 552 | 44.5 |
| 406 | 11.6 | 455 | 0.0 | 504 | 43.2 | 553 | 41.5 |
| 407 | 10.5 | 456 | 0.0 | 505 | 44.3 | 554 | 38.5 |
| 408 | 9.0 | 457 | 0.0 | 506 | 45.7 | 555 | 35.5 |
| 409 | 7.2 | 458 | 0.0 | 507 | 45.4 | 556 | 32.5 |
| 410 | 5.2 | 459 | 0.0 | 508 | 44.5 | 557 | 29.5 |
| 411 | 2.9 | 460 | 0.0 | 509 | 42.5 | 558 | 26.5 |
| 412 | 1.2 | 461 | 0.0 | 510 | 39.5 | 559 | 23.5 |
| 413 | 0.0 | 462 | 0.0 | 511 | 36.5 | 560 | 20.4 |
| 414 | 0.0 | 463 | 0.0 | 512 | 33.5 | 561 | 17.5 |
| 415 | 0.0 | 464 | 0.0 | 513 | 30.4 | 562 | 14.5 |
| 416 | 0.0 | 465 | 0.0 | 514 | 27.0 | 563 | 11.5 |
| 417 | 0.0 | 466 | 0.0 | 515 | 23.6 | 564 | 8.5 |
| 418 | 0.0 | 467 | 0.0 | 516 | 21.0 | 565 | 5.6 |
| 419 | 0.0 | 468 | 0.0 | 517 | 19.5 | 566 | 2.6 |
| 420 | 0.0 | 469 | 0.0 | 518 | 17.6 | 567 | 0.0 |
| 421 | 0.0 | 470 | 0.0 | 519 | 16.1 | 568 | 0.0 |
| 422 | 0.0 | 471 | 0.0 | 520 | 14.5 | 569 | 0.0 |
| 423 | 0.0 | 472 | 0.0 | 521 | 13.5 | 570 | 0.0 |
| 424 | 0.0 | 473 | 0.0 | 522 | 13.7 | 571 | 0.0 |
| 425 | 0.0 | 474 | 0.0 | 523 | 16.0 | 572 | 0.0 |
| 426 | 0.0 | 475 | 0.0 | 524 | 18.1 | 573 | 0.0 |
| 427 | 0.0 | 476 | 0.0 | 525 | 20.8 | 574 | 0.0 |
| 428 | 0.0 | 477 | 0.0 | 526 | 21.5 | 575 | 0.0 |
| 429 | 0.0 | 478 | 0.0 | 527 | 22.5 | 576 | 0.0 |
| 430 | 0.0 | 479 | 0.0 | 528 | 23.4 | 577 | 0.0 |
| 431 | 0.0 | 480 | 0.0 | 529 | 24.5 | 578 | 0.0 |
| 432 | 0.0 | 481 | 1.4 | 530 | 25.6 | 579 | 0.0 |

| <i>Time in s</i> | <i>Speed in km/h</i> | <i>Time in s</i> | <i>Speed in km/h</i> | <i>Time in s</i> | <i>Speed in km/h</i> | <i>Time in s</i> | <i>Speed in km/h</i> |
|------------------|----------------------|------------------|----------------------|------------------|----------------------|------------------|----------------------|
| 580 | 0.0 | | | | | | |
| 581 | 0.0 | | | | | | |
| 582 | 0.0 | | | | | | |
| 583 | 0.0 | | | | | | |
| 584 | 0.0 | | | | | | |
| 585 | 0.0 | | | | | | |
| 586 | 0.0 | | | | | | |
| 587 | 0.0 | | | | | | |
| 588 | 0.0 | | | | | | |
| 589 | 0.0 | | | | | | |

Table A1/4
 WLTC, Class 2 cycle, phase Medium₂

| <i>Time in s</i> | <i>Speed in km/h</i> | <i>Time in s</i> | <i>Speed in km/h</i> | <i>Time in s</i> | <i>Speed in km/h</i> | <i>Time in s</i> | <i>Speed in km/h</i> |
|------------------|----------------------|------------------|----------------------|------------------|----------------------|------------------|----------------------|
| 590 | 0.0 | 637 | 38.6 | 684 | 59.3 | 731 | 55.3 |
| 591 | 0.0 | 638 | 39.8 | 685 | 60.2 | 732 | 55.1 |
| 592 | 0.0 | 639 | 40.6 | 686 | 61.3 | 733 | 54.8 |
| 593 | 0.0 | 640 | 41.1 | 687 | 62.4 | 734 | 54.6 |
| 594 | 0.0 | 641 | 41.9 | 688 | 63.4 | 735 | 54.5 |
| 595 | 0.0 | 642 | 42.8 | 689 | 64.4 | 736 | 54.3 |
| 596 | 0.0 | 643 | 44.3 | 690 | 65.4 | 737 | 53.9 |
| 597 | 0.0 | 644 | 45.7 | 691 | 66.3 | 738 | 53.4 |
| 598 | 0.0 | 645 | 47.4 | 692 | 67.2 | 739 | 52.6 |
| 599 | 0.0 | 646 | 48.9 | 693 | 68.0 | 740 | 51.5 |
| 600 | 0.0 | 647 | 50.6 | 694 | 68.8 | 741 | 50.2 |
| 601 | 1.6 | 648 | 52.0 | 695 | 69.5 | 742 | 48.7 |
| 602 | 3.6 | 649 | 53.7 | 696 | 70.1 | 743 | 47.0 |
| 603 | 6.3 | 650 | 55.0 | 697 | 70.6 | 744 | 45.1 |
| 604 | 9.0 | 651 | 56.8 | 698 | 71.0 | 745 | 43.0 |
| 605 | 11.8 | 652 | 58.0 | 699 | 71.6 | 746 | 40.6 |
| 606 | 14.2 | 653 | 59.8 | 700 | 72.2 | 747 | 38.1 |
| 607 | 16.6 | 654 | 61.1 | 701 | 72.8 | 748 | 35.4 |
| 608 | 18.5 | 655 | 62.4 | 702 | 73.5 | 749 | 32.7 |
| 609 | 20.8 | 656 | 63.0 | 703 | 74.1 | 750 | 30.0 |
| 610 | 23.4 | 657 | 63.5 | 704 | 74.3 | 751 | 27.5 |
| 611 | 26.9 | 658 | 63.0 | 705 | 74.3 | 752 | 25.3 |
| 612 | 30.3 | 659 | 62.0 | 706 | 73.7 | 753 | 23.4 |
| 613 | 32.8 | 660 | 60.4 | 707 | 71.9 | 754 | 22.0 |
| 614 | 34.1 | 661 | 58.6 | 708 | 70.5 | 755 | 20.8 |
| 615 | 34.2 | 662 | 56.7 | 709 | 68.9 | 756 | 19.8 |
| 616 | 33.6 | 663 | 55.0 | 710 | 67.4 | 757 | 18.9 |
| 617 | 32.1 | 664 | 53.7 | 711 | 66.0 | 758 | 18.0 |
| 618 | 30.0 | 665 | 52.7 | 712 | 64.7 | 759 | 17.0 |
| 619 | 27.5 | 666 | 51.9 | 713 | 63.7 | 760 | 16.1 |
| 620 | 25.1 | 667 | 51.4 | 714 | 62.9 | 761 | 15.5 |
| 621 | 22.8 | 668 | 51.0 | 715 | 62.2 | 762 | 14.4 |
| 622 | 20.5 | 669 | 50.7 | 716 | 61.7 | 763 | 14.9 |
| 623 | 17.9 | 670 | 50.6 | 717 | 61.2 | 764 | 15.9 |
| 624 | 15.1 | 671 | 50.8 | 718 | 60.7 | 765 | 17.1 |
| 625 | 13.4 | 672 | 51.2 | 719 | 60.3 | 766 | 18.3 |
| 626 | 12.8 | 673 | 51.7 | 720 | 59.9 | 767 | 19.4 |
| 627 | 13.7 | 674 | 52.3 | 721 | 59.6 | 768 | 20.4 |
| 628 | 16.0 | 675 | 53.1 | 722 | 59.3 | 769 | 21.2 |
| 629 | 18.1 | 676 | 53.8 | 723 | 59.0 | 770 | 21.9 |
| 630 | 20.8 | 677 | 54.5 | 724 | 58.6 | 771 | 22.7 |
| 631 | 23.7 | 678 | 55.1 | 725 | 58.0 | 772 | 23.4 |
| 632 | 26.5 | 679 | 55.9 | 726 | 57.5 | 773 | 24.2 |
| 633 | 29.3 | 680 | 56.5 | 727 | 56.9 | 774 | 24.3 |
| 634 | 32.0 | 681 | 57.1 | 728 | 56.3 | 775 | 24.2 |
| 635 | 34.5 | 682 | 57.8 | 729 | 55.9 | 776 | 24.1 |
| 636 | 36.8 | 683 | 58.5 | 730 | 55.6 | 777 | 23.8 |

| <i>Time in s</i> | <i>Speed in km/h</i> | <i>Time in s</i> | <i>Speed in km/h</i> | <i>Time in s</i> | <i>Speed in km/h</i> | <i>Time in s</i> | <i>Speed in km/h</i> |
|------------------|----------------------|------------------|----------------------|------------------|----------------------|------------------|----------------------|
| 778 | 23.0 | 827 | 59.9 | 876 | 46.9 | 925 | 49.0 |
| 779 | 22.6 | 828 | 60.7 | 877 | 47.1 | 926 | 48.5 |
| 780 | 21.7 | 829 | 61.4 | 878 | 47.5 | 927 | 48.0 |
| 781 | 21.3 | 830 | 62.0 | 879 | 47.8 | 928 | 47.5 |
| 782 | 20.3 | 831 | 62.5 | 880 | 48.3 | 929 | 47.0 |
| 783 | 19.1 | 832 | 62.9 | 881 | 48.8 | 930 | 46.9 |
| 784 | 18.1 | 833 | 63.2 | 882 | 49.5 | 931 | 46.8 |
| 785 | 16.9 | 834 | 63.4 | 883 | 50.2 | 932 | 46.8 |
| 786 | 16.0 | 835 | 63.7 | 884 | 50.8 | 933 | 46.8 |
| 787 | 14.8 | 836 | 64.0 | 885 | 51.4 | 934 | 46.9 |
| 788 | 14.5 | 837 | 64.4 | 886 | 51.8 | 935 | 46.9 |
| 789 | 13.7 | 838 | 64.9 | 887 | 51.9 | 936 | 46.9 |
| 790 | 13.5 | 839 | 65.5 | 888 | 51.7 | 937 | 46.9 |
| 791 | 12.9 | 840 | 66.2 | 889 | 51.2 | 938 | 46.9 |
| 792 | 12.7 | 841 | 67.0 | 890 | 50.4 | 939 | 46.8 |
| 793 | 12.5 | 842 | 67.8 | 891 | 49.2 | 940 | 46.6 |
| 794 | 12.5 | 843 | 68.6 | 892 | 47.7 | 941 | 46.4 |
| 795 | 12.6 | 844 | 69.4 | 893 | 46.3 | 942 | 46.0 |
| 796 | 13.0 | 845 | 70.1 | 894 | 45.1 | 943 | 45.5 |
| 797 | 13.6 | 846 | 70.9 | 895 | 44.2 | 944 | 45.0 |
| 798 | 14.6 | 847 | 71.7 | 896 | 43.7 | 945 | 44.5 |
| 799 | 15.7 | 848 | 72.5 | 897 | 43.4 | 946 | 44.2 |
| 800 | 17.1 | 849 | 73.2 | 898 | 43.1 | 947 | 43.9 |
| 801 | 18.7 | 850 | 73.8 | 899 | 42.5 | 948 | 43.7 |
| 802 | 20.2 | 851 | 74.4 | 900 | 41.8 | 949 | 43.6 |
| 803 | 21.9 | 852 | 74.7 | 901 | 41.1 | 950 | 43.6 |
| 804 | 23.6 | 853 | 74.7 | 902 | 40.3 | 951 | 43.5 |
| 805 | 25.4 | 854 | 74.6 | 903 | 39.7 | 952 | 43.5 |
| 806 | 27.1 | 855 | 74.2 | 904 | 39.3 | 953 | 43.4 |
| 807 | 28.9 | 856 | 73.5 | 905 | 39.2 | 954 | 43.3 |
| 808 | 30.4 | 857 | 72.6 | 906 | 39.3 | 955 | 43.1 |
| 809 | 32.0 | 858 | 71.8 | 907 | 39.6 | 956 | 42.9 |
| 810 | 33.4 | 859 | 71.0 | 908 | 40.0 | 957 | 42.7 |
| 811 | 35.0 | 860 | 70.1 | 909 | 40.7 | 958 | 42.5 |
| 812 | 36.4 | 861 | 69.4 | 910 | 41.4 | 959 | 42.4 |
| 813 | 38.1 | 862 | 68.9 | 911 | 42.2 | 960 | 42.2 |
| 814 | 39.7 | 863 | 68.4 | 912 | 43.1 | 961 | 42.1 |
| 815 | 41.6 | 864 | 67.9 | 913 | 44.1 | 962 | 42.0 |
| 816 | 43.3 | 865 | 67.1 | 914 | 44.9 | 963 | 41.8 |
| 817 | 45.1 | 866 | 65.8 | 915 | 45.6 | 964 | 41.7 |
| 818 | 46.9 | 867 | 63.9 | 916 | 46.4 | 965 | 41.5 |
| 819 | 48.7 | 868 | 61.4 | 917 | 47.0 | 966 | 41.3 |
| 820 | 50.5 | 869 | 58.4 | 918 | 47.8 | 967 | 41.1 |
| 821 | 52.4 | 870 | 55.4 | 919 | 48.3 | 968 | 40.8 |
| 822 | 54.1 | 871 | 52.4 | 920 | 48.9 | 969 | 40.3 |
| 823 | 55.7 | 872 | 50.0 | 921 | 49.4 | 970 | 39.6 |
| 824 | 56.8 | 873 | 48.3 | 922 | 49.8 | 971 | 38.5 |
| 825 | 57.9 | 874 | 47.3 | 923 | 49.6 | 972 | 37.0 |
| 826 | 59.0 | 875 | 46.8 | 924 | 49.3 | 973 | 35.1 |

| <i>Time in s</i> | <i>Speed in km/h</i> | <i>Time in s</i> | <i>Speed in km/h</i> | <i>Time in s</i> | <i>Speed in km/h</i> | <i>Time in s</i> | <i>Speed in km/h</i> |
|------------------|----------------------|------------------|----------------------|------------------|----------------------|------------------|----------------------|
| 974 | 33.0 | | | | | | |
| 975 | 30.6 | | | | | | |
| 976 | 27.9 | | | | | | |
| 977 | 25.1 | | | | | | |
| 978 | 22.0 | | | | | | |
| 979 | 18.8 | | | | | | |
| 980 | 15.5 | | | | | | |
| 981 | 12.3 | | | | | | |
| 982 | 8.8 | | | | | | |
| 983 | 6.0 | | | | | | |
| 984 | 3.6 | | | | | | |
| 985 | 1.6 | | | | | | |
| 986 | 0.0 | | | | | | |
| 987 | 0.0 | | | | | | |
| 988 | 0.0 | | | | | | |
| 989 | 0.0 | | | | | | |
| 990 | 0.0 | | | | | | |
| 991 | 0.0 | | | | | | |
| 992 | 0.0 | | | | | | |
| 993 | 0.0 | | | | | | |
| 994 | 0.0 | | | | | | |
| 995 | 0.0 | | | | | | |
| 996 | 0.0 | | | | | | |
| 997 | 0.0 | | | | | | |
| 998 | 0.0 | | | | | | |
| 999 | 0.0 | | | | | | |
| 1000 | 0.0 | | | | | | |
| 1001 | 0.0 | | | | | | |
| 1002 | 0.0 | | | | | | |
| 1003 | 0.0 | | | | | | |
| 1004 | 0.0 | | | | | | |
| 1005 | 0.0 | | | | | | |
| 1006 | 0.0 | | | | | | |
| 1007 | 0.0 | | | | | | |
| 1008 | 0.0 | | | | | | |
| 1009 | 0.0 | | | | | | |
| 1010 | 0.0 | | | | | | |
| 1011 | 0.0 | | | | | | |
| 1012 | 0.0 | | | | | | |
| 1013 | 0.0 | | | | | | |
| 1014 | 0.0 | | | | | | |
| 1015 | 0.0 | | | | | | |
| 1016 | 0.0 | | | | | | |
| 1017 | 0.0 | | | | | | |
| 1018 | 0.0 | | | | | | |
| 1019 | 0.0 | | | | | | |
| 1020 | 0.0 | | | | | | |
| 1021 | 0.0 | | | | | | |
| 1022 | 0.0 | | | | | | |

Table A1/5
 WLTC, Class 2 cycle, phase High₂

| <i>Time in s</i> | <i>Speed in km/h</i> | <i>Time in s</i> | <i>Speed in km/h</i> | <i>Time in s</i> | <i>Speed in km/h</i> | <i>Time in s</i> | <i>Speed in km/h</i> |
|------------------|----------------------|------------------|----------------------|------------------|----------------------|------------------|----------------------|
| 1023 | 0.0 | 1070 | 46.0 | 1117 | 73.9 | 1164 | 71.7 |
| 1024 | 0.0 | 1071 | 46.4 | 1118 | 74.9 | 1165 | 69.9 |
| 1025 | 0.0 | 1072 | 47.0 | 1119 | 75.7 | 1166 | 67.9 |
| 1026 | 0.0 | 1073 | 47.4 | 1120 | 76.4 | 1167 | 65.7 |
| 1027 | 1.1 | 1074 | 48.0 | 1121 | 77.1 | 1168 | 63.5 |
| 1028 | 3.0 | 1075 | 48.4 | 1122 | 77.6 | 1169 | 61.2 |
| 1029 | 5.7 | 1076 | 49.0 | 1123 | 78.0 | 1170 | 59.0 |
| 1030 | 8.4 | 1077 | 49.4 | 1124 | 78.2 | 1171 | 56.8 |
| 1031 | 11.1 | 1078 | 50.0 | 1125 | 78.4 | 1172 | 54.7 |
| 1032 | 14.0 | 1079 | 50.4 | 1126 | 78.5 | 1173 | 52.7 |
| 1033 | 17.0 | 1080 | 50.8 | 1127 | 78.5 | 1174 | 50.9 |
| 1034 | 20.1 | 1081 | 51.1 | 1128 | 78.6 | 1175 | 49.4 |
| 1035 | 22.7 | 1082 | 51.3 | 1129 | 78.7 | 1176 | 48.1 |
| 1036 | 23.6 | 1083 | 51.3 | 1130 | 78.9 | 1177 | 47.1 |
| 1037 | 24.5 | 1084 | 51.3 | 1131 | 79.1 | 1178 | 46.5 |
| 1038 | 24.8 | 1085 | 51.3 | 1132 | 79.4 | 1179 | 46.3 |
| 1039 | 25.1 | 1086 | 51.3 | 1133 | 79.8 | 1180 | 46.5 |
| 1040 | 25.3 | 1087 | 51.3 | 1134 | 80.1 | 1181 | 47.2 |
| 1041 | 25.5 | 1088 | 51.3 | 1135 | 80.5 | 1182 | 48.3 |
| 1042 | 25.7 | 1089 | 51.4 | 1136 | 80.8 | 1183 | 49.7 |
| 1043 | 25.8 | 1090 | 51.6 | 1137 | 81.0 | 1184 | 51.3 |
| 1044 | 25.9 | 1091 | 51.8 | 1138 | 81.2 | 1185 | 53.0 |
| 1045 | 26.0 | 1092 | 52.1 | 1139 | 81.3 | 1186 | 54.9 |
| 1046 | 26.1 | 1093 | 52.3 | 1140 | 81.2 | 1187 | 56.7 |
| 1047 | 26.3 | 1094 | 52.6 | 1141 | 81.0 | 1188 | 58.6 |
| 1048 | 26.5 | 1095 | 52.8 | 1142 | 80.6 | 1189 | 60.2 |
| 1049 | 26.8 | 1096 | 52.9 | 1143 | 80.0 | 1190 | 61.6 |
| 1050 | 27.1 | 1097 | 53.0 | 1144 | 79.1 | 1191 | 62.2 |
| 1051 | 27.5 | 1098 | 53.0 | 1145 | 78.0 | 1192 | 62.5 |
| 1052 | 28.0 | 1099 | 53.0 | 1146 | 76.8 | 1193 | 62.8 |
| 1053 | 28.6 | 1100 | 53.1 | 1147 | 75.5 | 1194 | 62.9 |
| 1054 | 29.3 | 1101 | 53.2 | 1148 | 74.1 | 1195 | 63.0 |
| 1055 | 30.4 | 1102 | 53.3 | 1149 | 72.9 | 1196 | 63.0 |
| 1056 | 31.8 | 1103 | 53.4 | 1150 | 71.9 | 1197 | 63.1 |
| 1057 | 33.7 | 1104 | 53.5 | 1151 | 71.2 | 1198 | 63.2 |
| 1058 | 35.8 | 1105 | 53.7 | 1152 | 70.9 | 1199 | 63.3 |
| 1059 | 37.8 | 1106 | 55.0 | 1153 | 71.0 | 1200 | 63.5 |
| 1060 | 39.5 | 1107 | 56.8 | 1154 | 71.5 | 1201 | 63.7 |
| 1061 | 40.8 | 1108 | 58.8 | 1155 | 72.3 | 1202 | 63.9 |
| 1062 | 41.8 | 1109 | 60.9 | 1156 | 73.2 | 1203 | 64.1 |
| 1063 | 42.4 | 1110 | 63.0 | 1157 | 74.1 | 1204 | 64.3 |
| 1064 | 43.0 | 1111 | 65.0 | 1158 | 74.9 | 1205 | 66.1 |
| 1065 | 43.4 | 1112 | 66.9 | 1159 | 75.4 | 1206 | 67.9 |
| 1066 | 44.0 | 1113 | 68.6 | 1160 | 75.5 | 1207 | 69.7 |
| 1067 | 44.4 | 1114 | 70.1 | 1161 | 75.2 | 1208 | 71.4 |
| 1068 | 45.0 | 1115 | 71.5 | 1162 | 74.5 | 1209 | 73.1 |
| 1069 | 45.4 | 1116 | 72.8 | 1163 | 73.3 | 1210 | 74.7 |

| <i>Time in s</i> | <i>Speed in km/h</i> | <i>Time in s</i> | <i>Speed in km/h</i> | <i>Time in s</i> | <i>Speed in km/h</i> | <i>Time in s</i> | <i>Speed in km/h</i> |
|------------------|----------------------|------------------|----------------------|------------------|----------------------|------------------|----------------------|
| 1211 | 76.2 | 1260 | 35.4 | 1309 | 72.3 | 1358 | 70.8 |
| 1212 | 77.5 | 1261 | 32.7 | 1310 | 71.9 | 1359 | 70.8 |
| 1213 | 78.6 | 1262 | 30.0 | 1311 | 71.3 | 1360 | 70.9 |
| 1214 | 79.7 | 1263 | 29.9 | 1312 | 70.9 | 1361 | 70.9 |
| 1215 | 80.6 | 1264 | 30.0 | 1313 | 70.5 | 1362 | 70.9 |
| 1216 | 81.5 | 1265 | 30.2 | 1314 | 70.0 | 1363 | 70.9 |
| 1217 | 82.2 | 1266 | 30.4 | 1315 | 69.6 | 1364 | 71.0 |
| 1218 | 83.0 | 1267 | 30.6 | 1316 | 69.2 | 1365 | 71.0 |
| 1219 | 83.7 | 1268 | 31.6 | 1317 | 68.8 | 1366 | 71.1 |
| 1220 | 84.4 | 1269 | 33.0 | 1318 | 68.4 | 1367 | 71.2 |
| 1221 | 84.9 | 1270 | 33.9 | 1319 | 67.9 | 1368 | 71.3 |
| 1222 | 85.1 | 1271 | 34.8 | 1320 | 67.5 | 1369 | 71.4 |
| 1223 | 85.2 | 1272 | 35.7 | 1321 | 67.2 | 1370 | 71.5 |
| 1224 | 84.9 | 1273 | 36.6 | 1322 | 66.8 | 1371 | 71.7 |
| 1225 | 84.4 | 1274 | 37.5 | 1323 | 65.6 | 1372 | 71.8 |
| 1226 | 83.6 | 1275 | 38.4 | 1324 | 63.3 | 1373 | 71.9 |
| 1227 | 82.7 | 1276 | 39.3 | 1325 | 60.2 | 1374 | 71.9 |
| 1228 | 81.5 | 1277 | 40.2 | 1326 | 56.2 | 1375 | 71.9 |
| 1229 | 80.1 | 1278 | 40.8 | 1327 | 52.2 | 1376 | 71.9 |
| 1230 | 78.7 | 1279 | 41.7 | 1328 | 48.4 | 1377 | 71.9 |
| 1231 | 77.4 | 1280 | 42.4 | 1329 | 45.0 | 1378 | 71.9 |
| 1232 | 76.2 | 1281 | 43.1 | 1330 | 41.6 | 1379 | 71.9 |
| 1233 | 75.4 | 1282 | 43.6 | 1331 | 38.6 | 1380 | 72.0 |
| 1234 | 74.8 | 1283 | 44.2 | 1332 | 36.4 | 1381 | 72.1 |
| 1235 | 74.3 | 1284 | 44.8 | 1333 | 34.8 | 1382 | 72.4 |
| 1236 | 73.8 | 1285 | 45.5 | 1334 | 34.2 | 1383 | 72.7 |
| 1237 | 73.2 | 1286 | 46.3 | 1335 | 34.7 | 1384 | 73.1 |
| 1238 | 72.4 | 1287 | 47.2 | 1336 | 36.3 | 1385 | 73.4 |
| 1239 | 71.6 | 1288 | 48.1 | 1337 | 38.5 | 1386 | 73.8 |
| 1240 | 70.8 | 1289 | 49.1 | 1338 | 41.0 | 1387 | 74.0 |
| 1241 | 69.9 | 1290 | 50.0 | 1339 | 43.7 | 1388 | 74.1 |
| 1242 | 67.9 | 1291 | 51.0 | 1340 | 46.5 | 1389 | 74.0 |
| 1243 | 65.7 | 1292 | 51.9 | 1341 | 49.1 | 1390 | 73.0 |
| 1244 | 63.5 | 1293 | 52.7 | 1342 | 51.6 | 1391 | 72.0 |
| 1245 | 61.2 | 1294 | 53.7 | 1343 | 53.9 | 1392 | 71.0 |
| 1246 | 59.0 | 1295 | 55.0 | 1344 | 56.0 | 1393 | 70.0 |
| 1247 | 56.8 | 1296 | 56.8 | 1345 | 57.9 | 1394 | 69.0 |
| 1248 | 54.7 | 1297 | 58.8 | 1346 | 59.7 | 1395 | 68.0 |
| 1249 | 52.7 | 1298 | 60.9 | 1347 | 61.2 | 1396 | 67.7 |
| 1250 | 50.9 | 1299 | 63.0 | 1348 | 62.5 | 1397 | 66.7 |
| 1251 | 49.4 | 1300 | 65.0 | 1349 | 63.5 | 1398 | 66.6 |
| 1252 | 48.1 | 1301 | 66.9 | 1350 | 64.3 | 1399 | 66.7 |
| 1253 | 47.1 | 1302 | 68.6 | 1351 | 65.3 | 1400 | 66.8 |
| 1254 | 46.5 | 1303 | 70.1 | 1352 | 66.3 | 1401 | 66.9 |
| 1255 | 46.3 | 1304 | 71.0 | 1353 | 67.3 | 1402 | 66.9 |
| 1256 | 45.1 | 1305 | 71.8 | 1354 | 68.3 | 1403 | 66.9 |
| 1257 | 43.0 | 1306 | 72.8 | 1355 | 69.3 | 1404 | 66.9 |
| 1258 | 40.6 | 1307 | 72.9 | 1356 | 70.3 | 1405 | 66.9 |
| 1259 | 38.1 | 1308 | 73.0 | 1357 | 70.8 | 1406 | 66.9 |

| <i>Time in s</i> | <i>Speed in km/h</i> | <i>Time in s</i> | <i>Speed in km/h</i> | <i>Time in s</i> | <i>Speed in km/h</i> | <i>Time in s</i> | <i>Speed in km/h</i> |
|------------------|----------------------|------------------|----------------------|------------------|----------------------|------------------|----------------------|
| 1407 | 66.9 | 1456 | 0.0 | | | | |
| 1408 | 67.0 | 1457 | 0.0 | | | | |
| 1409 | 67.1 | 1458 | 0.0 | | | | |
| 1410 | 67.3 | 1459 | 0.0 | | | | |
| 1411 | 67.5 | 1460 | 0.0 | | | | |
| 1412 | 67.8 | 1461 | 0.0 | | | | |
| 1413 | 68.2 | 1462 | 0.0 | | | | |
| 1414 | 68.6 | 1463 | 0.0 | | | | |
| 1415 | 69.0 | 1464 | 0.0 | | | | |
| 1416 | 69.3 | 1465 | 0.0 | | | | |
| 1417 | 69.3 | 1466 | 0.0 | | | | |
| 1418 | 69.2 | 1467 | 0.0 | | | | |
| 1419 | 68.8 | 1468 | 0.0 | | | | |
| 1420 | 68.2 | 1469 | 0.0 | | | | |
| 1421 | 67.6 | 1470 | 0.0 | | | | |
| 1422 | 67.4 | 1471 | 0.0 | | | | |
| 1423 | 67.2 | 1472 | 0.0 | | | | |
| 1424 | 66.9 | 1473 | 0.0 | | | | |
| 1425 | 66.3 | 1474 | 0.0 | | | | |
| 1426 | 65.4 | 1475 | 0.0 | | | | |
| 1427 | 64.0 | 1476 | 0.0 | | | | |
| 1428 | 62.4 | 1477 | 0.0 | | | | |
| 1429 | 60.6 | | | | | | |
| 1430 | 58.6 | | | | | | |
| 1431 | 56.7 | | | | | | |
| 1432 | 54.8 | | | | | | |
| 1433 | 53.0 | | | | | | |
| 1434 | 51.3 | | | | | | |
| 1435 | 49.6 | | | | | | |
| 1436 | 47.8 | | | | | | |
| 1437 | 45.5 | | | | | | |
| 1438 | 42.8 | | | | | | |
| 1439 | 39.8 | | | | | | |
| 1440 | 36.5 | | | | | | |
| 1441 | 33.0 | | | | | | |
| 1442 | 29.5 | | | | | | |
| 1443 | 25.8 | | | | | | |
| 1444 | 22.1 | | | | | | |
| 1445 | 18.6 | | | | | | |
| 1446 | 15.3 | | | | | | |
| 1447 | 12.4 | | | | | | |
| 1448 | 9.6 | | | | | | |
| 1449 | 6.6 | | | | | | |
| 1450 | 3.8 | | | | | | |
| 1451 | 1.6 | | | | | | |
| 1452 | 0.0 | | | | | | |
| 1453 | 0.0 | | | | | | |
| 1454 | 0.0 | | | | | | |
| 1455 | 0.0 | | | | | | |

Table A1/6
 WLTC, Class 2 cycle, phase Extra High₂

| <i>Time in s</i> | <i>Speed in km/h</i> | <i>Time in s</i> | <i>Speed in km/h</i> | <i>Time in s</i> | <i>Speed in km/h</i> | <i>Time in s</i> | <i>Speed in km/h</i> |
|------------------|----------------------|------------------|----------------------|------------------|----------------------|------------------|----------------------|
| 1478 | 0.0 | 1525 | 63.4 | 1572 | 107.4 | 1619 | 113.7 |
| 1479 | 1.1 | 1526 | 64.5 | 1573 | 108.7 | 1620 | 114.1 |
| 1480 | 2.3 | 1527 | 65.7 | 1574 | 109.9 | 1621 | 114.4 |
| 1481 | 4.6 | 1528 | 66.9 | 1575 | 111.2 | 1622 | 114.6 |
| 1482 | 6.5 | 1529 | 68.1 | 1576 | 112.3 | 1623 | 114.7 |
| 1483 | 8.9 | 1530 | 69.1 | 1577 | 113.4 | 1624 | 114.7 |
| 1484 | 10.9 | 1531 | 70.0 | 1578 | 114.4 | 1625 | 114.7 |
| 1485 | 13.5 | 1532 | 70.9 | 1579 | 115.3 | 1626 | 114.6 |
| 1486 | 15.2 | 1533 | 71.8 | 1580 | 116.1 | 1627 | 114.5 |
| 1487 | 17.6 | 1534 | 72.6 | 1581 | 116.8 | 1628 | 114.5 |
| 1488 | 19.3 | 1535 | 73.4 | 1582 | 117.4 | 1629 | 114.5 |
| 1489 | 21.4 | 1536 | 74.0 | 1583 | 117.7 | 1630 | 114.7 |
| 1490 | 23.0 | 1537 | 74.7 | 1584 | 118.2 | 1631 | 115.0 |
| 1491 | 25.0 | 1538 | 75.2 | 1585 | 118.1 | 1632 | 115.6 |
| 1492 | 26.5 | 1539 | 75.7 | 1586 | 117.7 | 1633 | 116.4 |
| 1493 | 28.4 | 1540 | 76.4 | 1587 | 117.0 | 1634 | 117.3 |
| 1494 | 29.8 | 1541 | 77.2 | 1588 | 116.1 | 1635 | 118.2 |
| 1495 | 31.7 | 1542 | 78.2 | 1589 | 115.2 | 1636 | 118.8 |
| 1496 | 33.7 | 1543 | 78.9 | 1590 | 114.4 | 1637 | 119.3 |
| 1497 | 35.8 | 1544 | 79.9 | 1591 | 113.6 | 1638 | 119.6 |
| 1498 | 38.1 | 1545 | 81.1 | 1592 | 113.0 | 1639 | 119.7 |
| 1499 | 40.5 | 1546 | 82.4 | 1593 | 112.6 | 1640 | 119.5 |
| 1500 | 42.2 | 1547 | 83.7 | 1594 | 112.2 | 1641 | 119.3 |
| 1501 | 43.5 | 1548 | 85.4 | 1595 | 111.9 | 1642 | 119.2 |
| 1502 | 44.5 | 1549 | 87.0 | 1596 | 111.6 | 1643 | 119.0 |
| 1503 | 45.2 | 1550 | 88.3 | 1597 | 111.2 | 1644 | 118.8 |
| 1504 | 45.8 | 1551 | 89.5 | 1598 | 110.7 | 1645 | 118.8 |
| 1505 | 46.6 | 1552 | 90.5 | 1599 | 110.1 | 1646 | 118.8 |
| 1506 | 47.4 | 1553 | 91.3 | 1600 | 109.3 | 1647 | 118.8 |
| 1507 | 48.5 | 1554 | 92.2 | 1601 | 108.4 | 1648 | 118.8 |
| 1508 | 49.7 | 1555 | 93.0 | 1602 | 107.4 | 1649 | 118.9 |
| 1509 | 51.3 | 1556 | 93.8 | 1603 | 106.7 | 1650 | 119.0 |
| 1510 | 52.9 | 1557 | 94.6 | 1604 | 106.3 | 1651 | 119.0 |
| 1511 | 54.3 | 1558 | 95.3 | 1605 | 106.2 | 1652 | 119.1 |
| 1512 | 55.6 | 1559 | 95.9 | 1606 | 106.4 | 1653 | 119.2 |
| 1513 | 56.8 | 1560 | 96.6 | 1607 | 107.0 | 1654 | 119.4 |
| 1514 | 57.9 | 1561 | 97.4 | 1608 | 107.5 | 1655 | 119.6 |
| 1515 | 58.9 | 1562 | 98.1 | 1609 | 107.9 | 1656 | 119.9 |
| 1516 | 59.7 | 1563 | 98.7 | 1610 | 108.4 | 1657 | 120.1 |
| 1517 | 60.3 | 1564 | 99.5 | 1611 | 108.9 | 1658 | 120.3 |
| 1518 | 60.7 | 1565 | 100.3 | 1612 | 109.5 | 1659 | 120.4 |
| 1519 | 60.9 | 1566 | 101.1 | 1613 | 110.2 | 1660 | 120.5 |
| 1520 | 61.0 | 1567 | 101.9 | 1614 | 110.9 | 1661 | 120.5 |
| 1521 | 61.1 | 1568 | 102.8 | 1615 | 111.6 | 1662 | 120.5 |
| 1522 | 61.4 | 1569 | 103.8 | 1616 | 112.2 | 1663 | 120.5 |
| 1523 | 61.8 | 1570 | 105.0 | 1617 | 112.8 | 1664 | 120.4 |
| 1524 | 62.5 | 1571 | 106.1 | 1618 | 113.3 | 1665 | 120.3 |

| <i>Time in s</i> | <i>Speed in km/h</i> | <i>Time in s</i> | <i>Speed in km/h</i> | <i>Time in s</i> | <i>Speed in km/h</i> | <i>Time in s</i> | <i>Speed in km/h</i> |
|------------------|----------------------|------------------|----------------------|------------------|----------------------|------------------|----------------------|
| 1666 | 120.1 | 1715 | 120.4 | 1764 | 82.6 | | |
| 1667 | 119.9 | 1716 | 120.8 | 1765 | 81.9 | | |
| 1668 | 119.6 | 1717 | 121.1 | 1766 | 81.1 | | |
| 1669 | 119.5 | 1718 | 121.6 | 1767 | 80.0 | | |
| 1670 | 119.4 | 1719 | 121.8 | 1768 | 78.7 | | |
| 1671 | 119.3 | 1720 | 122.1 | 1769 | 76.9 | | |
| 1672 | 119.3 | 1721 | 122.4 | 1770 | 74.6 | | |
| 1673 | 119.4 | 1722 | 122.7 | 1771 | 72.0 | | |
| 1674 | 119.5 | 1723 | 122.8 | 1772 | 69.0 | | |
| 1675 | 119.5 | 1724 | 123.1 | 1773 | 65.6 | | |
| 1676 | 119.6 | 1725 | 123.1 | 1774 | 62.1 | | |
| 1677 | 119.6 | 1726 | 122.8 | 1775 | 58.5 | | |
| 1678 | 119.6 | 1727 | 122.3 | 1776 | 54.7 | | |
| 1679 | 119.4 | 1728 | 121.3 | 1777 | 50.9 | | |
| 1680 | 119.3 | 1729 | 119.9 | 1778 | 47.3 | | |
| 1681 | 119.0 | 1730 | 118.1 | 1779 | 43.8 | | |
| 1682 | 118.8 | 1731 | 115.9 | 1780 | 40.4 | | |
| 1683 | 118.7 | 1732 | 113.5 | 1781 | 37.4 | | |
| 1684 | 118.8 | 1733 | 111.1 | 1782 | 34.3 | | |
| 1685 | 119.0 | 1734 | 108.6 | 1783 | 31.3 | | |
| 1686 | 119.2 | 1735 | 106.2 | 1784 | 28.3 | | |
| 1687 | 119.6 | 1736 | 104.0 | 1785 | 25.2 | | |
| 1688 | 120.0 | 1737 | 101.1 | 1786 | 22.0 | | |
| 1689 | 120.3 | 1738 | 98.3 | 1787 | 18.9 | | |
| 1690 | 120.5 | 1739 | 95.7 | 1788 | 16.1 | | |
| 1691 | 120.7 | 1740 | 93.5 | 1789 | 13.4 | | |
| 1692 | 120.9 | 1741 | 91.5 | 1790 | 11.1 | | |
| 1693 | 121.0 | 1742 | 90.7 | 1791 | 8.9 | | |
| 1694 | 121.1 | 1743 | 90.4 | 1792 | 6.9 | | |
| 1695 | 121.2 | 1744 | 90.2 | 1793 | 4.9 | | |
| 1696 | 121.3 | 1745 | 90.2 | 1794 | 2.8 | | |
| 1697 | 121.4 | 1746 | 90.1 | 1795 | 0.0 | | |
| 1698 | 121.5 | 1747 | 90.0 | 1796 | 0.0 | | |
| 1699 | 121.5 | 1748 | 89.8 | 1797 | 0.0 | | |
| 1700 | 121.5 | 1749 | 89.6 | 1798 | 0.0 | | |
| 1701 | 121.4 | 1750 | 89.4 | 1799 | 0.0 | | |
| 1702 | 121.3 | 1751 | 89.2 | 1800 | 0.0 | | |
| 1703 | 121.1 | 1752 | 88.9 | | | | |
| 1704 | 120.9 | 1753 | 88.5 | | | | |
| 1705 | 120.6 | 1754 | 88.1 | | | | |
| 1706 | 120.4 | 1755 | 87.6 | | | | |
| 1707 | 120.2 | 1756 | 87.1 | | | | |
| 1708 | 120.1 | 1757 | 86.6 | | | | |
| 1709 | 119.9 | 1758 | 86.1 | | | | |
| 1710 | 119.8 | 1759 | 85.5 | | | | |
| 1711 | 119.8 | 1760 | 85.0 | | | | |
| 1712 | 119.9 | 1761 | 84.4 | | | | |
| 1713 | 120.0 | 1762 | 83.8 | | | | |
| 1714 | 120.2 | 1763 | 83.2 | | | | |

6. WLTC Class 3 cycle

Figure A1/7

WLTC, Class 3 cycle, phase Low₃

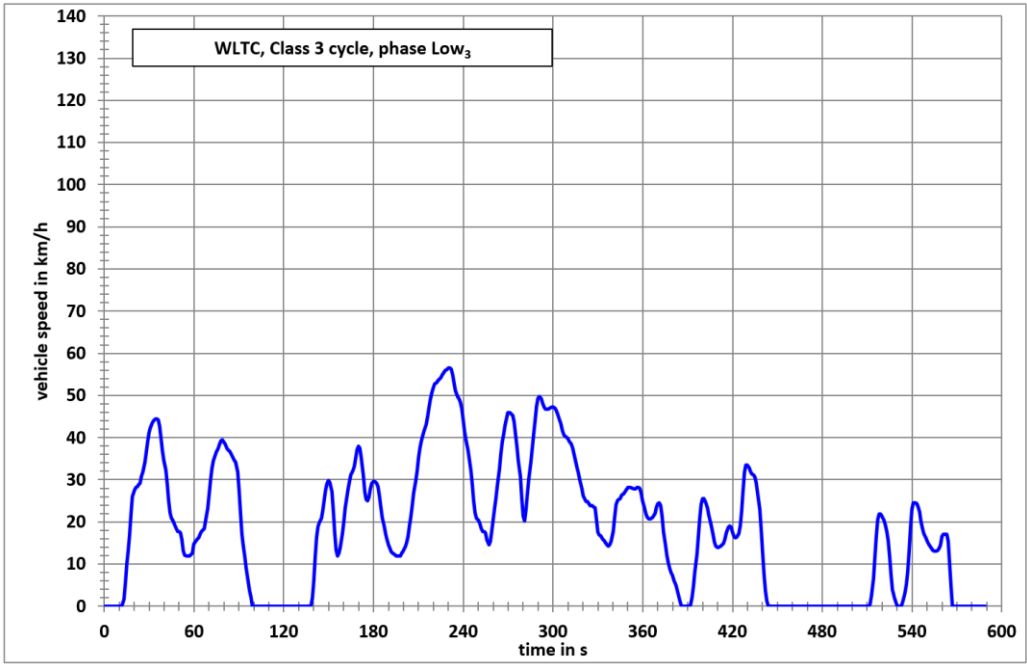

Figure A1/8

WLTC, Class 3a cycle, phase Medium_{3a}

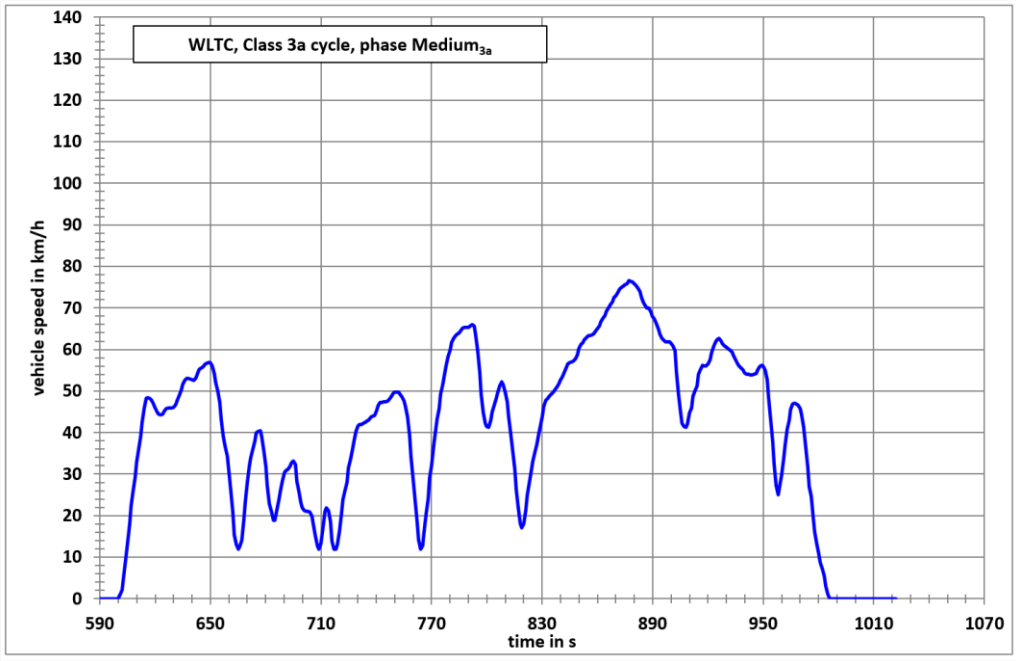

Figure A1/9
WLTC, Class 3b cycle, phase Medium_{3b}

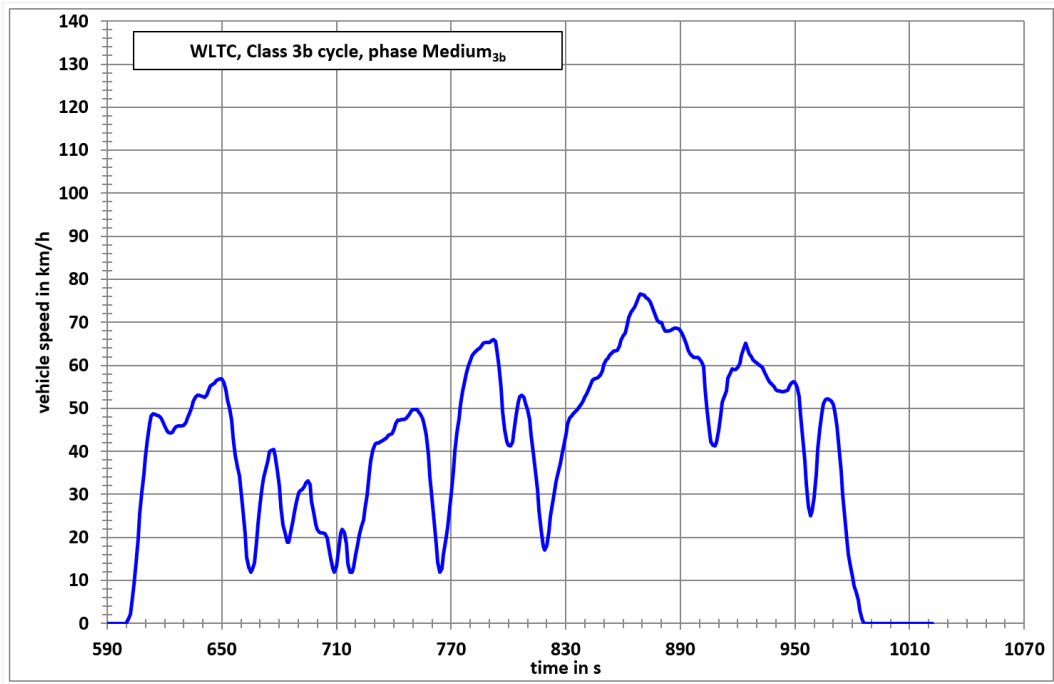

Figure A1/10
WLTC, Class 3a cycle, phase High_{3a}

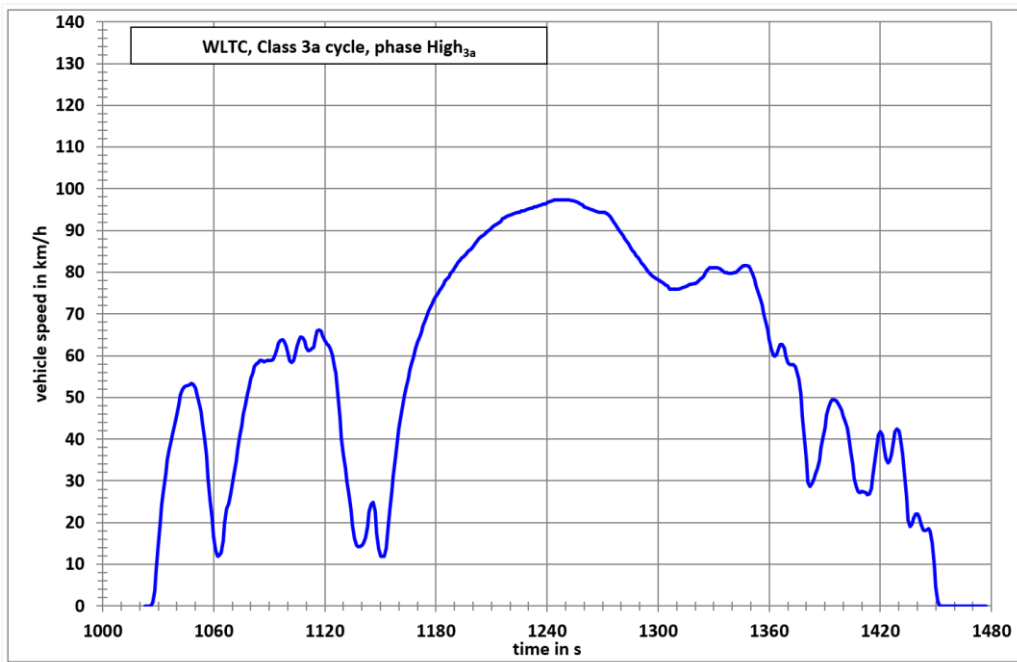

Figure A1/11
WLTC, Class 3b cycle, phase High_{3b}

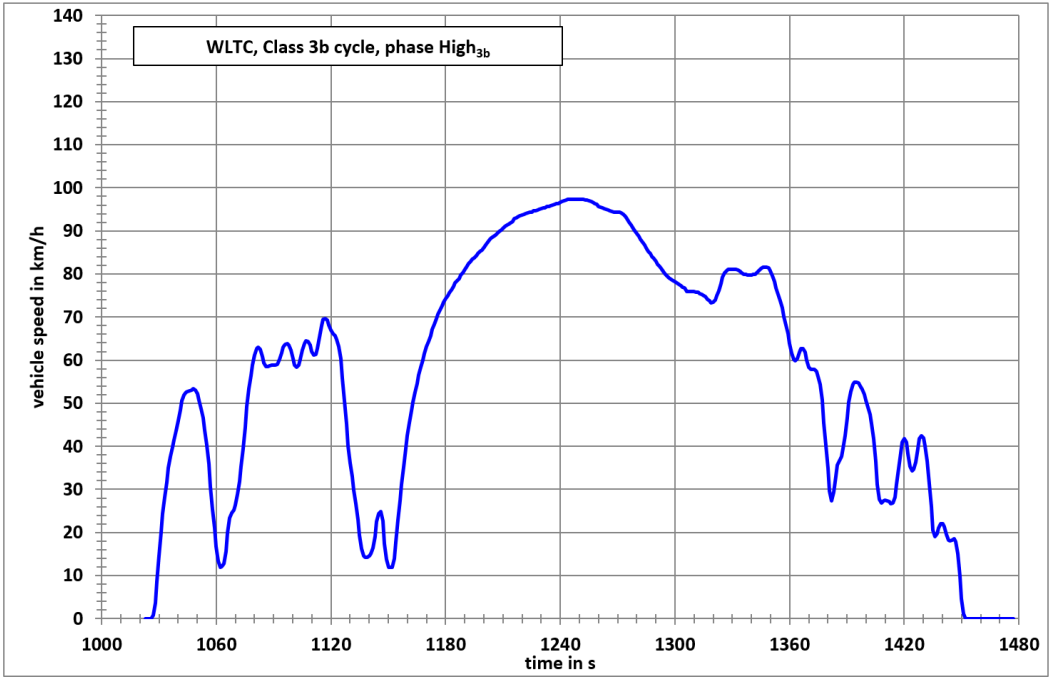

Figure A1/12
WLTC, Class 3 cycle, phase Extra High₃

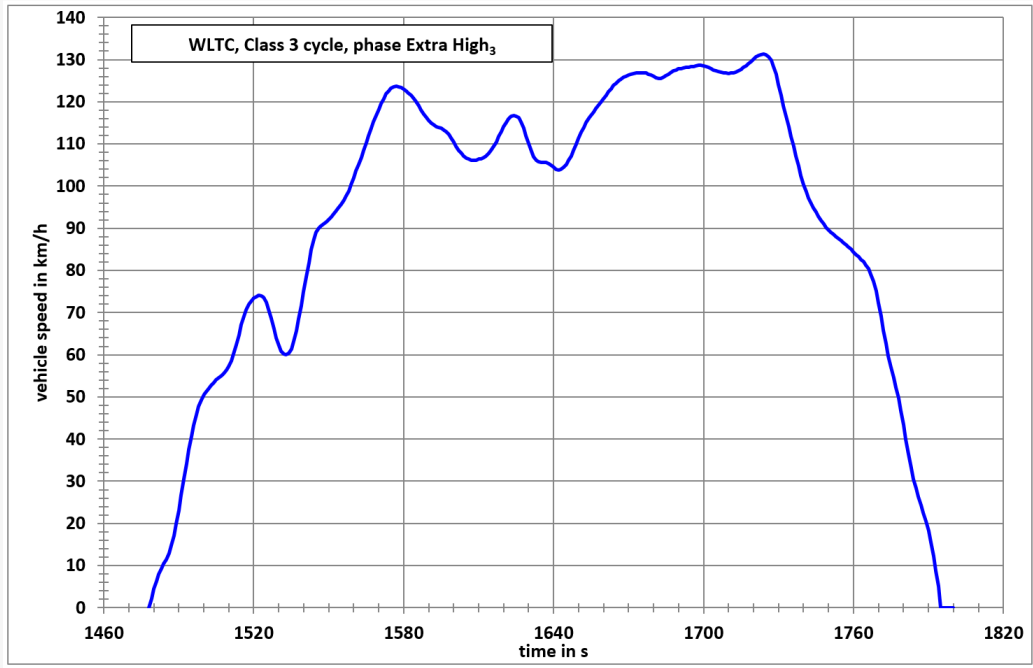

Table A1/7
 WLTC, Class 3 cycle, phase Low₃

| <i>Time in s</i> | <i>Speed in km/h</i> | <i>Time in s</i> | <i>Speed in km/h</i> | <i>Time in s</i> | <i>Speed in km/h</i> | <i>Time in s</i> | <i>Speed in km/h</i> |
|------------------|----------------------|------------------|----------------------|------------------|----------------------|------------------|----------------------|
| 0 | 0.0 | 47 | 19.5 | 94 | 12.0 | 141 | 11.7 |
| 1 | 0.0 | 48 | 18.4 | 95 | 9.1 | 142 | 16.4 |
| 2 | 0.0 | 49 | 17.8 | 96 | 5.8 | 143 | 18.9 |
| 3 | 0.0 | 50 | 17.8 | 97 | 3.6 | 144 | 19.9 |
| 4 | 0.0 | 51 | 17.4 | 98 | 2.2 | 145 | 20.8 |
| 5 | 0.0 | 52 | 15.7 | 99 | 0.0 | 146 | 22.8 |
| 6 | 0.0 | 53 | 13.1 | 100 | 0.0 | 147 | 25.4 |
| 7 | 0.0 | 54 | 12.1 | 101 | 0.0 | 148 | 27.7 |
| 8 | 0.0 | 55 | 12.0 | 102 | 0.0 | 149 | 29.2 |
| 9 | 0.0 | 56 | 12.0 | 103 | 0.0 | 150 | 29.8 |
| 10 | 0.0 | 57 | 12.0 | 104 | 0.0 | 151 | 29.4 |
| 11 | 0.0 | 58 | 12.3 | 105 | 0.0 | 152 | 27.2 |
| 12 | 0.2 | 59 | 12.6 | 106 | 0.0 | 153 | 22.6 |
| 13 | 1.7 | 60 | 14.7 | 107 | 0.0 | 154 | 17.3 |
| 14 | 5.4 | 61 | 15.3 | 108 | 0.0 | 155 | 13.3 |
| 15 | 9.9 | 62 | 15.9 | 109 | 0.0 | 156 | 12.0 |
| 16 | 13.1 | 63 | 16.2 | 110 | 0.0 | 157 | 12.6 |
| 17 | 16.9 | 64 | 17.1 | 111 | 0.0 | 158 | 14.1 |
| 18 | 21.7 | 65 | 17.8 | 112 | 0.0 | 159 | 17.2 |
| 19 | 26.0 | 66 | 18.1 | 113 | 0.0 | 160 | 20.1 |
| 20 | 27.5 | 67 | 18.4 | 114 | 0.0 | 161 | 23.4 |
| 21 | 28.1 | 68 | 20.3 | 115 | 0.0 | 162 | 25.5 |
| 22 | 28.3 | 69 | 23.2 | 116 | 0.0 | 163 | 27.6 |
| 23 | 28.8 | 70 | 26.5 | 117 | 0.0 | 164 | 29.5 |
| 24 | 29.1 | 71 | 29.8 | 118 | 0.0 | 165 | 31.1 |
| 25 | 30.8 | 72 | 32.6 | 119 | 0.0 | 166 | 32.1 |
| 26 | 31.9 | 73 | 34.4 | 120 | 0.0 | 167 | 33.2 |
| 27 | 34.1 | 74 | 35.5 | 121 | 0.0 | 168 | 35.2 |
| 28 | 36.6 | 75 | 36.4 | 122 | 0.0 | 169 | 37.2 |
| 29 | 39.1 | 76 | 37.4 | 123 | 0.0 | 170 | 38.0 |
| 30 | 41.3 | 77 | 38.5 | 124 | 0.0 | 171 | 37.4 |
| 31 | 42.5 | 78 | 39.3 | 125 | 0.0 | 172 | 35.1 |
| 32 | 43.3 | 79 | 39.5 | 126 | 0.0 | 173 | 31.0 |
| 33 | 43.9 | 80 | 39.0 | 127 | 0.0 | 174 | 27.1 |
| 34 | 44.4 | 81 | 38.5 | 128 | 0.0 | 175 | 25.3 |
| 35 | 44.5 | 82 | 37.3 | 129 | 0.0 | 176 | 25.1 |
| 36 | 44.2 | 83 | 37.0 | 130 | 0.0 | 177 | 25.9 |
| 37 | 42.7 | 84 | 36.7 | 131 | 0.0 | 178 | 27.8 |
| 38 | 39.9 | 85 | 35.9 | 132 | 0.0 | 179 | 29.2 |
| 39 | 37.0 | 86 | 35.3 | 133 | 0.0 | 180 | 29.6 |
| 40 | 34.6 | 87 | 34.6 | 134 | 0.0 | 181 | 29.5 |
| 41 | 32.3 | 88 | 34.2 | 135 | 0.0 | 182 | 29.2 |
| 42 | 29.0 | 89 | 31.9 | 136 | 0.0 | 183 | 28.3 |
| 43 | 25.1 | 90 | 27.3 | 137 | 0.0 | 184 | 26.1 |
| 44 | 22.2 | 91 | 22.0 | 138 | 0.2 | 185 | 23.6 |
| 45 | 20.9 | 92 | 17.0 | 139 | 1.9 | 186 | 21.0 |
| 46 | 20.4 | 93 | 14.2 | 140 | 6.1 | 187 | 18.9 |

| <i>Time in s</i> | <i>Speed in km/h</i> | <i>Time in s</i> | <i>Speed in km/h</i> | <i>Time in s</i> | <i>Speed in km/h</i> | <i>Time in s</i> | <i>Speed in km/h</i> |
|------------------|----------------------|------------------|----------------------|------------------|----------------------|------------------|----------------------|
| 188 | 17.1 | 237 | 49.2 | 286 | 37.4 | 335 | 15.0 |
| 189 | 15.7 | 238 | 48.4 | 287 | 40.7 | 336 | 14.5 |
| 190 | 14.5 | 239 | 46.9 | 288 | 44.0 | 337 | 14.3 |
| 191 | 13.7 | 240 | 44.3 | 289 | 47.3 | 338 | 14.5 |
| 192 | 12.9 | 241 | 41.5 | 290 | 49.2 | 339 | 15.4 |
| 193 | 12.5 | 242 | 39.5 | 291 | 49.8 | 340 | 17.8 |
| 194 | 12.2 | 243 | 37.0 | 292 | 49.2 | 341 | 21.1 |
| 195 | 12.0 | 244 | 34.6 | 293 | 48.1 | 342 | 24.1 |
| 196 | 12.0 | 245 | 32.3 | 294 | 47.3 | 343 | 25.0 |
| 197 | 12.0 | 246 | 29.0 | 295 | 46.8 | 344 | 25.3 |
| 198 | 12.0 | 247 | 25.1 | 296 | 46.7 | 345 | 25.5 |
| 199 | 12.5 | 248 | 22.2 | 297 | 46.8 | 346 | 26.4 |
| 200 | 13.0 | 249 | 20.9 | 298 | 47.1 | 347 | 26.6 |
| 201 | 14.0 | 250 | 20.4 | 299 | 47.3 | 348 | 27.1 |
| 202 | 15.0 | 251 | 19.5 | 300 | 47.3 | 349 | 27.7 |
| 203 | 16.5 | 252 | 18.4 | 301 | 47.1 | 350 | 28.1 |
| 204 | 19.0 | 253 | 17.8 | 302 | 46.6 | 351 | 28.2 |
| 205 | 21.2 | 254 | 17.8 | 303 | 45.8 | 352 | 28.1 |
| 206 | 23.8 | 255 | 17.4 | 304 | 44.8 | 353 | 28.0 |
| 207 | 26.9 | 256 | 15.7 | 305 | 43.3 | 354 | 27.9 |
| 208 | 29.6 | 257 | 14.5 | 306 | 41.8 | 355 | 27.9 |
| 209 | 32.0 | 258 | 15.4 | 307 | 40.8 | 356 | 28.1 |
| 210 | 35.2 | 259 | 17.9 | 308 | 40.3 | 357 | 28.2 |
| 211 | 37.5 | 260 | 20.6 | 309 | 40.1 | 358 | 28.0 |
| 212 | 39.2 | 261 | 23.2 | 310 | 39.7 | 359 | 26.9 |
| 213 | 40.5 | 262 | 25.7 | 311 | 39.2 | 360 | 25.0 |
| 214 | 41.6 | 263 | 28.7 | 312 | 38.5 | 361 | 23.2 |
| 215 | 43.1 | 264 | 32.5 | 313 | 37.4 | 362 | 21.9 |
| 216 | 45.0 | 265 | 36.1 | 314 | 36.0 | 363 | 21.1 |
| 217 | 47.1 | 266 | 39.0 | 315 | 34.4 | 364 | 20.7 |
| 218 | 49.0 | 267 | 40.8 | 316 | 33.0 | 365 | 20.7 |
| 219 | 50.6 | 268 | 42.9 | 317 | 31.7 | 366 | 20.8 |
| 220 | 51.8 | 269 | 44.4 | 318 | 30.0 | 367 | 21.2 |
| 221 | 52.7 | 270 | 45.9 | 319 | 28.0 | 368 | 22.1 |
| 222 | 53.1 | 271 | 46.0 | 320 | 26.1 | 369 | 23.5 |
| 223 | 53.5 | 272 | 45.6 | 321 | 25.6 | 370 | 24.3 |
| 224 | 53.8 | 273 | 45.3 | 322 | 24.9 | 371 | 24.5 |
| 225 | 54.2 | 274 | 43.7 | 323 | 24.9 | 372 | 23.8 |
| 226 | 54.8 | 275 | 40.8 | 324 | 24.3 | 373 | 21.3 |
| 227 | 55.3 | 276 | 38.0 | 325 | 23.9 | 374 | 17.7 |
| 228 | 55.8 | 277 | 34.4 | 326 | 23.9 | 375 | 14.4 |
| 229 | 56.2 | 278 | 30.9 | 327 | 23.6 | 376 | 11.9 |
| 230 | 56.5 | 279 | 25.5 | 328 | 23.3 | 377 | 10.2 |
| 231 | 56.5 | 280 | 21.4 | 329 | 20.5 | 378 | 8.9 |
| 232 | 56.2 | 281 | 20.2 | 330 | 17.5 | 379 | 8.0 |
| 233 | 54.9 | 282 | 22.9 | 331 | 16.9 | 380 | 7.2 |
| 234 | 52.9 | 283 | 26.6 | 332 | 16.7 | 381 | 6.1 |
| 235 | 51.0 | 284 | 30.2 | 333 | 15.9 | 382 | 4.9 |
| 236 | 49.8 | 285 | 34.1 | 334 | 15.6 | 383 | 3.7 |

| <i>Time in s</i> | <i>Speed in km/h</i> | <i>Time in s</i> | <i>Speed in km/h</i> | <i>Time in s</i> | <i>Speed in km/h</i> | <i>Time in s</i> | <i>Speed in km/h</i> |
|------------------|----------------------|------------------|----------------------|------------------|----------------------|------------------|----------------------|
| 384 | 2.3 | 433 | 31.3 | 482 | 0.0 | 531 | 0.0 |
| 385 | 0.9 | 434 | 31.1 | 483 | 0.0 | 532 | 0.0 |
| 386 | 0.0 | 435 | 30.6 | 484 | 0.0 | 533 | 0.2 |
| 387 | 0.0 | 436 | 29.2 | 485 | 0.0 | 534 | 1.2 |
| 388 | 0.0 | 437 | 26.7 | 486 | 0.0 | 535 | 3.2 |
| 389 | 0.0 | 438 | 23.0 | 487 | 0.0 | 536 | 5.2 |
| 390 | 0.0 | 439 | 18.2 | 488 | 0.0 | 537 | 8.2 |
| 391 | 0.0 | 440 | 12.9 | 489 | 0.0 | 538 | 13 |
| 392 | 0.5 | 441 | 7.7 | 490 | 0.0 | 539 | 18.8 |
| 393 | 2.1 | 442 | 3.8 | 491 | 0.0 | 540 | 23.1 |
| 394 | 4.8 | 443 | 1.3 | 492 | 0.0 | 541 | 24.5 |
| 395 | 8.3 | 444 | 0.2 | 493 | 0.0 | 542 | 24.5 |
| 396 | 12.3 | 445 | 0.0 | 494 | 0.0 | 543 | 24.3 |
| 397 | 16.6 | 446 | 0.0 | 495 | 0.0 | 544 | 23.6 |
| 398 | 20.9 | 447 | 0.0 | 496 | 0.0 | 545 | 22.3 |
| 399 | 24.2 | 448 | 0.0 | 497 | 0.0 | 546 | 20.1 |
| 400 | 25.6 | 449 | 0.0 | 498 | 0.0 | 547 | 18.5 |
| 401 | 25.6 | 450 | 0.0 | 499 | 0.0 | 548 | 17.2 |
| 402 | 24.9 | 451 | 0.0 | 500 | 0.0 | 549 | 16.3 |
| 403 | 23.3 | 452 | 0.0 | 501 | 0.0 | 550 | 15.4 |
| 404 | 21.6 | 453 | 0.0 | 502 | 0.0 | 551 | 14.7 |
| 405 | 20.2 | 454 | 0.0 | 503 | 0.0 | 552 | 14.3 |
| 406 | 18.7 | 455 | 0.0 | 504 | 0.0 | 553 | 13.7 |
| 407 | 17.0 | 456 | 0.0 | 505 | 0.0 | 554 | 13.3 |
| 408 | 15.3 | 457 | 0.0 | 506 | 0.0 | 555 | 13.1 |
| 409 | 14.2 | 458 | 0.0 | 507 | 0.0 | 556 | 13.1 |
| 410 | 13.9 | 459 | 0.0 | 508 | 0.0 | 557 | 13.3 |
| 411 | 14.0 | 460 | 0.0 | 509 | 0.0 | 558 | 13.8 |
| 412 | 14.2 | 461 | 0.0 | 510 | 0.0 | 559 | 14.5 |
| 413 | 14.5 | 462 | 0.0 | 511 | 0.0 | 560 | 16.5 |
| 414 | 14.9 | 463 | 0.0 | 512 | 0.5 | 561 | 17.0 |
| 415 | 15.9 | 464 | 0.0 | 513 | 2.5 | 562 | 17.0 |
| 416 | 17.4 | 465 | 0.0 | 514 | 6.6 | 563 | 17.0 |
| 417 | 18.7 | 466 | 0.0 | 515 | 11.8 | 564 | 15.4 |
| 418 | 19.1 | 467 | 0.0 | 516 | 16.8 | 565 | 10.1 |
| 419 | 18.8 | 468 | 0.0 | 517 | 20.5 | 566 | 4.8 |
| 420 | 17.6 | 469 | 0.0 | 518 | 21.9 | 567 | 0.0 |
| 421 | 16.6 | 470 | 0.0 | 519 | 21.9 | 568 | 0.0 |
| 422 | 16.2 | 471 | 0.0 | 520 | 21.3 | 569 | 0.0 |
| 423 | 16.4 | 472 | 0.0 | 521 | 20.3 | 570 | 0.0 |
| 424 | 17.2 | 473 | 0.0 | 522 | 19.2 | 571 | 0.0 |
| 425 | 19.1 | 474 | 0.0 | 523 | 17.8 | 572 | 0.0 |
| 426 | 22.6 | 475 | 0.0 | 524 | 15.5 | 573 | 0.0 |
| 427 | 27.4 | 476 | 0.0 | 525 | 11.9 | 574 | 0.0 |
| 428 | 31.6 | 477 | 0.0 | 526 | 7.6 | 575 | 0.0 |
| 429 | 33.4 | 478 | 0.0 | 527 | 4.0 | 576 | 0.0 |
| 430 | 33.5 | 479 | 0.0 | 528 | 2.0 | 577 | 0.0 |
| 431 | 32.8 | 480 | 0.0 | 529 | 1.0 | 578 | 0.0 |
| 432 | 31.9 | 481 | 0.0 | 530 | 0.0 | 579 | 0.0 |

| <i>Time in s</i> | <i>Speed in km/h</i> | <i>Time in s</i> | <i>Speed in km/h</i> | <i>Time in s</i> | <i>Speed in km/h</i> | <i>Time in s</i> | <i>Speed in km/h</i> |
|------------------|----------------------|------------------|----------------------|------------------|----------------------|------------------|----------------------|
| 580 | 0.0 | | | | | | |
| 581 | 0.0 | | | | | | |
| 582 | 0.0 | | | | | | |
| 583 | 0.0 | | | | | | |
| 584 | 0.0 | | | | | | |
| 585 | 0.0 | | | | | | |
| 586 | 0.0 | | | | | | |
| 587 | 0.0 | | | | | | |
| 588 | 0.0 | | | | | | |
| 589 | 0.0 | | | | | | |

Table A1/8
 WLTC, Class 3a cycle, phase Medium_{3a}

| <i>Time in s</i> | <i>Speed in km/h</i> | <i>Time in s</i> | <i>Speed in km/h</i> | <i>Time in s</i> | <i>Speed in km/h</i> | <i>Time in s</i> | <i>Speed in km/h</i> |
|------------------|----------------------|------------------|----------------------|------------------|----------------------|------------------|----------------------|
| 590 | 0.0 | 637 | 53.0 | 684 | 18.9 | 731 | 41.9 |
| 591 | 0.0 | 638 | 53.0 | 685 | 18.9 | 732 | 42.0 |
| 592 | 0.0 | 639 | 52.9 | 686 | 21.3 | 733 | 42.2 |
| 593 | 0.0 | 640 | 52.7 | 687 | 23.9 | 734 | 42.4 |
| 594 | 0.0 | 641 | 52.6 | 688 | 25.9 | 735 | 42.7 |
| 595 | 0.0 | 642 | 53.1 | 689 | 28.4 | 736 | 43.1 |
| 596 | 0.0 | 643 | 54.3 | 690 | 30.3 | 737 | 43.7 |
| 597 | 0.0 | 644 | 55.2 | 691 | 30.9 | 738 | 44.0 |
| 598 | 0.0 | 645 | 55.5 | 692 | 31.1 | 739 | 44.1 |
| 599 | 0.0 | 646 | 55.9 | 693 | 31.8 | 740 | 45.3 |
| 600 | 0.0 | 647 | 56.3 | 694 | 32.7 | 741 | 46.4 |
| 601 | 1.0 | 648 | 56.7 | 695 | 33.2 | 742 | 47.2 |
| 602 | 2.1 | 649 | 56.9 | 696 | 32.4 | 743 | 47.3 |
| 603 | 5.2 | 650 | 56.8 | 697 | 28.3 | 744 | 47.4 |
| 604 | 9.2 | 651 | 56.0 | 698 | 25.8 | 745 | 47.4 |
| 605 | 13.5 | 652 | 54.2 | 699 | 23.1 | 746 | 47.5 |
| 606 | 18.1 | 653 | 52.1 | 700 | 21.8 | 747 | 47.9 |
| 607 | 22.3 | 654 | 50.1 | 701 | 21.2 | 748 | 48.6 |
| 608 | 26.0 | 655 | 47.2 | 702 | 21.0 | 749 | 49.4 |
| 609 | 29.3 | 656 | 43.2 | 703 | 21.0 | 750 | 49.8 |
| 610 | 32.8 | 657 | 39.2 | 704 | 20.9 | 751 | 49.8 |
| 611 | 36.0 | 658 | 36.5 | 705 | 19.9 | 752 | 49.7 |
| 612 | 39.2 | 659 | 34.3 | 706 | 17.9 | 753 | 49.3 |
| 613 | 42.5 | 660 | 31.0 | 707 | 15.1 | 754 | 48.5 |
| 614 | 45.7 | 661 | 26.0 | 708 | 12.8 | 755 | 47.6 |
| 615 | 48.2 | 662 | 20.7 | 709 | 12.0 | 756 | 46.3 |
| 616 | 48.4 | 663 | 15.4 | 710 | 13.2 | 757 | 43.7 |
| 617 | 48.2 | 664 | 13.1 | 711 | 17.1 | 758 | 39.3 |
| 618 | 47.8 | 665 | 12.0 | 712 | 21.1 | 759 | 34.1 |
| 619 | 47.0 | 666 | 12.5 | 713 | 21.8 | 760 | 29.0 |
| 620 | 45.9 | 667 | 14.0 | 714 | 21.2 | 761 | 23.7 |
| 621 | 44.9 | 668 | 19.0 | 715 | 18.5 | 762 | 18.4 |
| 622 | 44.4 | 669 | 23.2 | 716 | 13.9 | 763 | 14.3 |
| 623 | 44.3 | 670 | 28.0 | 717 | 12.0 | 764 | 12.0 |
| 624 | 44.5 | 671 | 32.0 | 718 | 12.0 | 765 | 12.8 |
| 625 | 45.1 | 672 | 34.0 | 719 | 13.0 | 766 | 16.0 |
| 626 | 45.7 | 673 | 36.0 | 720 | 16.3 | 767 | 20.4 |
| 627 | 46.0 | 674 | 38.0 | 721 | 20.5 | 768 | 24.0 |
| 628 | 46.0 | 675 | 40.0 | 722 | 23.9 | 769 | 29.0 |
| 629 | 46.0 | 676 | 40.3 | 723 | 26.0 | 770 | 32.2 |
| 630 | 46.1 | 677 | 40.5 | 724 | 28.0 | 771 | 36.8 |
| 631 | 46.7 | 678 | 39.0 | 725 | 31.5 | 772 | 39.4 |
| 632 | 47.7 | 679 | 35.7 | 726 | 33.4 | 773 | 43.2 |
| 633 | 48.9 | 680 | 31.8 | 727 | 36.0 | 774 | 45.8 |
| 634 | 50.3 | 681 | 27.1 | 728 | 37.8 | 775 | 49.2 |
| 635 | 51.6 | 682 | 22.8 | 729 | 40.2 | 776 | 51.4 |
| 636 | 52.6 | 683 | 21.1 | 730 | 41.6 | 777 | 54.2 |

| <i>Time in s</i> | <i>Speed in km/h</i> | <i>Time in s</i> | <i>Speed in km/h</i> | <i>Time in s</i> | <i>Speed in km/h</i> | <i>Time in s</i> | <i>Speed in km/h</i> |
|------------------|----------------------|------------------|----------------------|------------------|----------------------|------------------|----------------------|
| 778 | 56.0 | 827 | 37.1 | 876 | 75.8 | 925 | 62.3 |
| 779 | 58.3 | 828 | 38.9 | 877 | 76.6 | 926 | 62.7 |
| 780 | 59.8 | 829 | 41.4 | 878 | 76.5 | 927 | 62.0 |
| 781 | 61.7 | 830 | 44.0 | 879 | 76.2 | 928 | 61.3 |
| 782 | 62.7 | 831 | 46.3 | 880 | 75.8 | 929 | 60.9 |
| 783 | 63.3 | 832 | 47.7 | 881 | 75.4 | 930 | 60.5 |
| 784 | 63.6 | 833 | 48.2 | 882 | 74.8 | 931 | 60.2 |
| 785 | 64.0 | 834 | 48.7 | 883 | 73.9 | 932 | 59.8 |
| 786 | 64.7 | 835 | 49.3 | 884 | 72.7 | 933 | 59.4 |
| 787 | 65.2 | 836 | 49.8 | 885 | 71.3 | 934 | 58.6 |
| 788 | 65.3 | 837 | 50.2 | 886 | 70.4 | 935 | 57.5 |
| 789 | 65.3 | 838 | 50.9 | 887 | 70.0 | 936 | 56.6 |
| 790 | 65.4 | 839 | 51.8 | 888 | 70.0 | 937 | 56.0 |
| 791 | 65.7 | 840 | 52.5 | 889 | 69.0 | 938 | 55.5 |
| 792 | 66.0 | 841 | 53.3 | 890 | 68.0 | 939 | 55.0 |
| 793 | 65.6 | 842 | 54.5 | 891 | 67.3 | 940 | 54.4 |
| 794 | 63.5 | 843 | 55.7 | 892 | 66.2 | 941 | 54.1 |
| 795 | 59.7 | 844 | 56.5 | 893 | 64.8 | 942 | 54.0 |
| 796 | 54.6 | 845 | 56.8 | 894 | 63.6 | 943 | 53.9 |
| 797 | 49.3 | 846 | 57.0 | 895 | 62.6 | 944 | 53.9 |
| 798 | 44.9 | 847 | 57.2 | 896 | 62.1 | 945 | 54.0 |
| 799 | 42.3 | 848 | 57.7 | 897 | 61.9 | 946 | 54.2 |
| 800 | 41.4 | 849 | 58.7 | 898 | 61.9 | 947 | 55.0 |
| 801 | 41.3 | 850 | 60.1 | 899 | 61.8 | 948 | 55.8 |
| 802 | 43.0 | 851 | 61.1 | 900 | 61.5 | 949 | 56.2 |
| 803 | 45.0 | 852 | 61.7 | 901 | 60.9 | 950 | 56.1 |
| 804 | 46.5 | 853 | 62.3 | 902 | 59.7 | 951 | 55.1 |
| 805 | 48.3 | 854 | 62.9 | 903 | 54.6 | 952 | 52.7 |
| 806 | 49.5 | 855 | 63.3 | 904 | 49.3 | 953 | 48.4 |
| 807 | 51.2 | 856 | 63.4 | 905 | 44.9 | 954 | 43.1 |
| 808 | 52.2 | 857 | 63.5 | 906 | 42.3 | 955 | 37.8 |
| 809 | 51.6 | 858 | 63.9 | 907 | 41.4 | 956 | 32.5 |
| 810 | 49.7 | 859 | 64.4 | 908 | 41.3 | 957 | 27.2 |
| 811 | 47.4 | 860 | 65.0 | 909 | 42.1 | 958 | 25.1 |
| 812 | 43.7 | 861 | 65.6 | 910 | 44.7 | 959 | 27.0 |
| 813 | 39.7 | 862 | 66.6 | 911 | 46.0 | 960 | 29.8 |
| 814 | 35.5 | 863 | 67.4 | 912 | 48.8 | 961 | 33.8 |
| 815 | 31.1 | 864 | 68.2 | 913 | 50.1 | 962 | 37.0 |
| 816 | 26.3 | 865 | 69.1 | 914 | 51.3 | 963 | 40.7 |
| 817 | 21.9 | 866 | 70.0 | 915 | 54.1 | 964 | 43.0 |
| 818 | 18.0 | 867 | 70.8 | 916 | 55.2 | 965 | 45.6 |
| 819 | 17.0 | 868 | 71.5 | 917 | 56.2 | 966 | 46.9 |
| 820 | 18.0 | 869 | 72.4 | 918 | 56.1 | 967 | 47.0 |
| 821 | 21.4 | 870 | 73.0 | 919 | 56.1 | 968 | 46.9 |
| 822 | 24.8 | 871 | 73.7 | 920 | 56.5 | 969 | 46.5 |
| 823 | 27.9 | 872 | 74.4 | 921 | 57.5 | 970 | 45.8 |
| 824 | 30.8 | 873 | 74.9 | 922 | 59.2 | 971 | 44.3 |
| 825 | 33.0 | 874 | 75.3 | 923 | 60.7 | 972 | 41.3 |
| 826 | 35.1 | 875 | 75.6 | 924 | 61.8 | 973 | 36.5 |

| <i>Time in s</i> | <i>Speed in km/h</i> | <i>Time in s</i> | <i>Speed in km/h</i> | <i>Time in s</i> | <i>Speed in km/h</i> | <i>Time in s</i> | <i>Speed in km/h</i> |
|------------------|----------------------|------------------|----------------------|------------------|----------------------|------------------|----------------------|
| 974 | 31.7 | | | | | | |
| 975 | 27.0 | | | | | | |
| 976 | 24.7 | | | | | | |
| 977 | 19.3 | | | | | | |
| 978 | 16.0 | | | | | | |
| 979 | 13.2 | | | | | | |
| 980 | 10.7 | | | | | | |
| 981 | 8.8 | | | | | | |
| 982 | 7.2 | | | | | | |
| 983 | 5.5 | | | | | | |
| 984 | 3.2 | | | | | | |
| 985 | 1.1 | | | | | | |
| 986 | 0.0 | | | | | | |
| 987 | 0.0 | | | | | | |
| 988 | 0.0 | | | | | | |
| 989 | 0.0 | | | | | | |
| 990 | 0.0 | | | | | | |
| 991 | 0.0 | | | | | | |
| 992 | 0.0 | | | | | | |
| 993 | 0.0 | | | | | | |
| 994 | 0.0 | | | | | | |
| 995 | 0.0 | | | | | | |
| 996 | 0.0 | | | | | | |
| 997 | 0.0 | | | | | | |
| 998 | 0.0 | | | | | | |
| 999 | 0.0 | | | | | | |
| 1000 | 0.0 | | | | | | |
| 1001 | 0.0 | | | | | | |
| 1002 | 0.0 | | | | | | |
| 1003 | 0.0 | | | | | | |
| 1004 | 0.0 | | | | | | |
| 1005 | 0.0 | | | | | | |
| 1006 | 0.0 | | | | | | |
| 1007 | 0.0 | | | | | | |
| 1008 | 0.0 | | | | | | |
| 1009 | 0.0 | | | | | | |
| 1010 | 0.0 | | | | | | |
| 1011 | 0.0 | | | | | | |
| 1012 | 0.0 | | | | | | |
| 1013 | 0.0 | | | | | | |
| 1014 | 0.0 | | | | | | |
| 1015 | 0.0 | | | | | | |
| 1016 | 0.0 | | | | | | |
| 1017 | 0.0 | | | | | | |
| 1018 | 0.0 | | | | | | |
| 1019 | 0.0 | | | | | | |
| 1020 | 0.0 | | | | | | |
| 1021 | 0.0 | | | | | | |
| 1022 | 0.0 | | | | | | |

Table A1/9
 WLTC, Class 3b cycle, phase Medium_{3b}

| <i>Time in s</i> | <i>Speed in km/h</i> | <i>Time in s</i> | <i>Speed in km/h</i> | <i>Time in s</i> | <i>Speed in km/h</i> | <i>Time in s</i> | <i>Speed in km/h</i> |
|------------------|----------------------|------------------|----------------------|------------------|----------------------|------------------|----------------------|
| 590 | 0.0 | 637 | 53.0 | 684 | 18.9 | 731 | 41.9 |
| 591 | 0.0 | 638 | 53.0 | 685 | 18.9 | 732 | 42.0 |
| 592 | 0.0 | 639 | 52.9 | 686 | 21.3 | 733 | 42.2 |
| 593 | 0.0 | 640 | 52.7 | 687 | 23.9 | 734 | 42.4 |
| 594 | 0.0 | 641 | 52.6 | 688 | 25.9 | 735 | 42.7 |
| 595 | 0.0 | 642 | 53.1 | 689 | 28.4 | 736 | 43.1 |
| 596 | 0.0 | 643 | 54.3 | 690 | 30.3 | 737 | 43.7 |
| 597 | 0.0 | 644 | 55.2 | 691 | 30.9 | 738 | 44.0 |
| 598 | 0.0 | 645 | 55.5 | 692 | 31.1 | 739 | 44.1 |
| 599 | 0.0 | 646 | 55.9 | 693 | 31.8 | 740 | 45.3 |
| 600 | 0.0 | 647 | 56.3 | 694 | 32.7 | 741 | 46.4 |
| 601 | 1.0 | 648 | 56.7 | 695 | 33.2 | 742 | 47.2 |
| 602 | 2.1 | 649 | 56.9 | 696 | 32.4 | 743 | 47.3 |
| 603 | 4.8 | 650 | 56.8 | 697 | 28.3 | 744 | 47.4 |
| 604 | 9.1 | 651 | 56.0 | 698 | 25.8 | 745 | 47.4 |
| 605 | 14.2 | 652 | 54.2 | 699 | 23.1 | 746 | 47.5 |
| 606 | 19.8 | 653 | 52.1 | 700 | 21.8 | 747 | 47.9 |
| 607 | 25.5 | 654 | 50.1 | 701 | 21.2 | 748 | 48.6 |
| 608 | 30.5 | 655 | 47.2 | 702 | 21.0 | 749 | 49.4 |
| 609 | 34.8 | 656 | 43.2 | 703 | 21.0 | 750 | 49.8 |
| 610 | 38.8 | 657 | 39.2 | 704 | 20.9 | 751 | 49.8 |
| 611 | 42.9 | 658 | 36.5 | 705 | 19.9 | 752 | 49.7 |
| 612 | 46.4 | 659 | 34.3 | 706 | 17.9 | 753 | 49.3 |
| 613 | 48.3 | 660 | 31.0 | 707 | 15.1 | 754 | 48.5 |
| 614 | 48.7 | 661 | 26.0 | 708 | 12.8 | 755 | 47.6 |
| 615 | 48.5 | 662 | 20.7 | 709 | 12.0 | 756 | 46.3 |
| 616 | 48.4 | 663 | 15.4 | 710 | 13.2 | 757 | 43.7 |
| 617 | 48.2 | 664 | 13.1 | 711 | 17.1 | 758 | 39.3 |
| 618 | 47.8 | 665 | 12.0 | 712 | 21.1 | 759 | 34.1 |
| 619 | 47.0 | 666 | 12.5 | 713 | 21.8 | 760 | 29.0 |
| 620 | 45.9 | 667 | 14.0 | 714 | 21.2 | 761 | 23.7 |
| 621 | 44.9 | 668 | 19.0 | 715 | 18.5 | 762 | 18.4 |
| 622 | 44.4 | 669 | 23.2 | 716 | 13.9 | 763 | 14.3 |
| 623 | 44.3 | 670 | 28.0 | 717 | 12.0 | 764 | 12.0 |
| 624 | 44.5 | 671 | 32.0 | 718 | 12.0 | 765 | 12.8 |
| 625 | 45.1 | 672 | 34.0 | 719 | 13.0 | 766 | 16.0 |
| 626 | 45.7 | 673 | 36.0 | 720 | 16.0 | 767 | 19.1 |
| 627 | 46.0 | 674 | 38.0 | 721 | 18.5 | 768 | 22.4 |
| 628 | 46.0 | 675 | 40.0 | 722 | 20.6 | 769 | 25.6 |
| 629 | 46.0 | 676 | 40.3 | 723 | 22.5 | 770 | 30.1 |
| 630 | 46.1 | 677 | 40.5 | 724 | 24.0 | 771 | 35.3 |
| 631 | 46.7 | 678 | 39.0 | 725 | 26.6 | 772 | 39.9 |
| 632 | 47.7 | 679 | 35.7 | 726 | 29.9 | 773 | 44.5 |
| 633 | 48.9 | 680 | 31.8 | 727 | 34.8 | 774 | 47.5 |
| 634 | 50.3 | 681 | 27.1 | 728 | 37.8 | 775 | 50.9 |
| 635 | 51.6 | 682 | 22.8 | 729 | 40.2 | 776 | 54.1 |
| 636 | 52.6 | 683 | 21.1 | 730 | 41.6 | 777 | 56.3 |

| <i>Time in s</i> | <i>Speed in km/h</i> | <i>Time in s</i> | <i>Speed in km/h</i> | <i>Time in s</i> | <i>Speed in km/h</i> | <i>Time in s</i> | <i>Speed in km/h</i> |
|------------------|----------------------|------------------|----------------------|------------------|----------------------|------------------|----------------------|
| 778 | 58.1 | 827 | 37.1 | 876 | 72.7 | 925 | 64.1 |
| 779 | 59.8 | 828 | 38.9 | 877 | 71.3 | 926 | 62.7 |
| 780 | 61.1 | 829 | 41.4 | 878 | 70.4 | 927 | 62.0 |
| 781 | 62.1 | 830 | 44.0 | 879 | 70.0 | 928 | 61.3 |
| 782 | 62.8 | 831 | 46.3 | 880 | 70.0 | 929 | 60.9 |
| 783 | 63.3 | 832 | 47.7 | 881 | 69.0 | 930 | 60.5 |
| 784 | 63.6 | 833 | 48.2 | 882 | 68.0 | 931 | 60.2 |
| 785 | 64.0 | 834 | 48.7 | 883 | 68.0 | 932 | 59.8 |
| 786 | 64.7 | 835 | 49.3 | 884 | 68.0 | 933 | 59.4 |
| 787 | 65.2 | 836 | 49.8 | 885 | 68.1 | 934 | 58.6 |
| 788 | 65.3 | 837 | 50.2 | 886 | 68.4 | 935 | 57.5 |
| 789 | 65.3 | 838 | 50.9 | 887 | 68.6 | 936 | 56.6 |
| 790 | 65.4 | 839 | 51.8 | 888 | 68.7 | 937 | 56.0 |
| 791 | 65.7 | 840 | 52.5 | 889 | 68.5 | 938 | 55.5 |
| 792 | 66.0 | 841 | 53.3 | 890 | 68.1 | 939 | 55.0 |
| 793 | 65.6 | 842 | 54.5 | 891 | 67.3 | 940 | 54.4 |
| 794 | 63.5 | 843 | 55.7 | 892 | 66.2 | 941 | 54.1 |
| 795 | 59.7 | 844 | 56.5 | 893 | 64.8 | 942 | 54.0 |
| 796 | 54.6 | 845 | 56.8 | 894 | 63.6 | 943 | 53.9 |
| 797 | 49.3 | 846 | 57.0 | 895 | 62.6 | 944 | 53.9 |
| 798 | 44.9 | 847 | 57.2 | 896 | 62.1 | 945 | 54.0 |
| 799 | 42.3 | 848 | 57.7 | 897 | 61.9 | 946 | 54.2 |
| 800 | 41.4 | 849 | 58.7 | 898 | 61.9 | 947 | 55.0 |
| 801 | 41.3 | 850 | 60.1 | 899 | 61.8 | 948 | 55.8 |
| 802 | 42.1 | 851 | 61.1 | 900 | 61.5 | 949 | 56.2 |
| 803 | 44.7 | 852 | 61.7 | 901 | 60.9 | 950 | 56.1 |
| 804 | 48.4 | 853 | 62.3 | 902 | 59.7 | 951 | 55.1 |
| 805 | 51.4 | 854 | 62.9 | 903 | 54.6 | 952 | 52.7 |
| 806 | 52.7 | 855 | 63.3 | 904 | 49.3 | 953 | 48.4 |
| 807 | 53.0 | 856 | 63.4 | 905 | 44.9 | 954 | 43.1 |
| 808 | 52.5 | 857 | 63.5 | 906 | 42.3 | 955 | 37.8 |
| 809 | 51.3 | 858 | 64.5 | 907 | 41.4 | 956 | 32.5 |
| 810 | 49.7 | 859 | 65.8 | 908 | 41.3 | 957 | 27.2 |
| 811 | 47.4 | 860 | 66.8 | 909 | 42.1 | 958 | 25.1 |
| 812 | 43.7 | 861 | 67.4 | 910 | 44.7 | 959 | 26.0 |
| 813 | 39.7 | 862 | 68.8 | 911 | 48.4 | 960 | 29.3 |
| 814 | 35.5 | 863 | 71.1 | 912 | 51.4 | 961 | 34.6 |
| 815 | 31.1 | 864 | 72.3 | 913 | 52.7 | 962 | 40.4 |
| 816 | 26.3 | 865 | 72.8 | 914 | 54.0 | 963 | 45.3 |
| 817 | 21.9 | 866 | 73.4 | 915 | 57.0 | 964 | 49.0 |
| 818 | 18.0 | 867 | 74.6 | 916 | 58.1 | 965 | 51.1 |
| 819 | 17.0 | 868 | 76.0 | 917 | 59.2 | 966 | 52.1 |
| 820 | 18.0 | 869 | 76.6 | 918 | 59.0 | 967 | 52.2 |
| 821 | 21.4 | 870 | 76.5 | 919 | 59.1 | 968 | 52.1 |
| 822 | 24.8 | 871 | 76.2 | 920 | 59.5 | 969 | 51.7 |
| 823 | 27.9 | 872 | 75.8 | 921 | 60.5 | 970 | 50.9 |
| 824 | 30.8 | 873 | 75.4 | 922 | 62.3 | 971 | 49.2 |
| 825 | 33.0 | 874 | 74.8 | 923 | 63.9 | 972 | 45.9 |
| 826 | 35.1 | 875 | 73.9 | 924 | 65.1 | 973 | 40.6 |

| <i>Time in s</i> | <i>Speed in km/h</i> | <i>Time in s</i> | <i>Speed in km/h</i> | <i>Time in s</i> | <i>Speed in km/h</i> | <i>Time in s</i> | <i>Speed in km/h</i> |
|------------------|----------------------|------------------|----------------------|------------------|----------------------|------------------|----------------------|
| 974 | 35.3 | | | | | | |
| 975 | 30.0 | | | | | | |
| 976 | 24.7 | | | | | | |
| 977 | 19.3 | | | | | | |
| 978 | 16.0 | | | | | | |
| 979 | 13.2 | | | | | | |
| 980 | 10.7 | | | | | | |
| 981 | 8.8 | | | | | | |
| 982 | 7.2 | | | | | | |
| 983 | 5.5 | | | | | | |
| 984 | 3.2 | | | | | | |
| 985 | 1.1 | | | | | | |
| 986 | 0.0 | | | | | | |
| 987 | 0.0 | | | | | | |
| 988 | 0.0 | | | | | | |
| 989 | 0.0 | | | | | | |
| 990 | 0.0 | | | | | | |
| 991 | 0.0 | | | | | | |
| 992 | 0.0 | | | | | | |
| 993 | 0.0 | | | | | | |
| 994 | 0.0 | | | | | | |
| 995 | 0.0 | | | | | | |
| 996 | 0.0 | | | | | | |
| 997 | 0.0 | | | | | | |
| 998 | 0.0 | | | | | | |
| 999 | 0.0 | | | | | | |
| 1000 | 0.0 | | | | | | |
| 1001 | 0.0 | | | | | | |
| 1002 | 0.0 | | | | | | |
| 1003 | 0.0 | | | | | | |
| 1004 | 0.0 | | | | | | |
| 1005 | 0.0 | | | | | | |
| 1006 | 0.0 | | | | | | |
| 1007 | 0.0 | | | | | | |
| 1008 | 0.0 | | | | | | |
| 1009 | 0.0 | | | | | | |
| 1010 | 0.0 | | | | | | |
| 1011 | 0.0 | | | | | | |
| 1012 | 0.0 | | | | | | |
| 1013 | 0.0 | | | | | | |
| 1014 | 0.0 | | | | | | |
| 1015 | 0.0 | | | | | | |
| 1016 | 0.0 | | | | | | |
| 1017 | 0.0 | | | | | | |
| 1018 | 0.0 | | | | | | |
| 1019 | 0.0 | | | | | | |
| 1020 | 0.0 | | | | | | |
| 1021 | 0.0 | | | | | | |
| 1022 | 0.0 | | | | | | |

Table A1/10
WLTC, Class 3a cycle, phase High_{3a}

| <i>Time in s</i> | <i>Speed in km/h</i> | <i>Time in s</i> | <i>Speed in km/h</i> | <i>Time in s</i> | <i>Speed in km/h</i> | <i>Time in s</i> | <i>Speed in km/h</i> |
|------------------|----------------------|------------------|----------------------|------------------|----------------------|------------------|----------------------|
| 1023 | 0.0 | 1070 | 29.0 | 1117 | 66.2 | 1164 | 52.6 |
| 1024 | 0.0 | 1071 | 32.0 | 1118 | 65.8 | 1165 | 54.5 |
| 1025 | 0.0 | 1072 | 34.8 | 1119 | 64.7 | 1166 | 56.6 |
| 1026 | 0.0 | 1073 | 37.7 | 1120 | 63.6 | 1167 | 58.3 |
| 1027 | 0.8 | 1074 | 40.8 | 1121 | 62.9 | 1168 | 60.0 |
| 1028 | 3.6 | 1075 | 43.2 | 1122 | 62.4 | 1169 | 61.5 |
| 1029 | 8.6 | 1076 | 46.0 | 1123 | 61.7 | 1170 | 63.1 |
| 1030 | 14.6 | 1077 | 48.0 | 1124 | 60.1 | 1171 | 64.3 |
| 1031 | 20.0 | 1078 | 50.7 | 1125 | 57.3 | 1172 | 65.7 |
| 1032 | 24.4 | 1079 | 52.0 | 1126 | 55.8 | 1173 | 67.1 |
| 1033 | 28.2 | 1080 | 54.5 | 1127 | 50.5 | 1174 | 68.3 |
| 1034 | 31.7 | 1081 | 55.9 | 1128 | 45.2 | 1175 | 69.7 |
| 1035 | 35.0 | 1082 | 57.4 | 1129 | 40.1 | 1176 | 70.6 |
| 1036 | 37.6 | 1083 | 58.1 | 1130 | 36.2 | 1177 | 71.6 |
| 1037 | 39.7 | 1084 | 58.4 | 1131 | 32.9 | 1178 | 72.6 |
| 1038 | 41.5 | 1085 | 58.8 | 1132 | 29.8 | 1179 | 73.5 |
| 1039 | 43.6 | 1086 | 58.8 | 1133 | 26.6 | 1180 | 74.2 |
| 1040 | 46.0 | 1087 | 58.6 | 1134 | 23.0 | 1181 | 74.9 |
| 1041 | 48.4 | 1088 | 58.7 | 1135 | 19.4 | 1182 | 75.6 |
| 1042 | 50.5 | 1089 | 58.8 | 1136 | 16.3 | 1183 | 76.3 |
| 1043 | 51.9 | 1090 | 58.8 | 1137 | 14.6 | 1184 | 77.1 |
| 1044 | 52.6 | 1091 | 58.8 | 1138 | 14.2 | 1185 | 77.9 |
| 1045 | 52.8 | 1092 | 59.1 | 1139 | 14.3 | 1186 | 78.5 |
| 1046 | 52.9 | 1093 | 60.1 | 1140 | 14.6 | 1187 | 79.0 |
| 1047 | 53.1 | 1094 | 61.7 | 1141 | 15.1 | 1188 | 79.7 |
| 1048 | 53.3 | 1095 | 63.0 | 1142 | 16.4 | 1189 | 80.3 |
| 1049 | 53.1 | 1096 | 63.7 | 1143 | 19.1 | 1190 | 81.0 |
| 1050 | 52.3 | 1097 | 63.9 | 1144 | 22.5 | 1191 | 81.6 |
| 1051 | 50.7 | 1098 | 63.5 | 1145 | 24.4 | 1192 | 82.4 |
| 1052 | 48.8 | 1099 | 62.3 | 1146 | 24.8 | 1193 | 82.9 |
| 1053 | 46.5 | 1100 | 60.3 | 1147 | 22.7 | 1194 | 83.4 |
| 1054 | 43.8 | 1101 | 58.9 | 1148 | 17.4 | 1195 | 83.8 |
| 1055 | 40.3 | 1102 | 58.4 | 1149 | 13.8 | 1196 | 84.2 |
| 1056 | 36.0 | 1103 | 58.8 | 1150 | 12.0 | 1197 | 84.7 |
| 1057 | 30.7 | 1104 | 60.2 | 1151 | 12.0 | 1198 | 85.2 |
| 1058 | 25.4 | 1105 | 62.3 | 1152 | 12.0 | 1199 | 85.6 |
| 1059 | 21.0 | 1106 | 63.9 | 1153 | 13.9 | 1200 | 86.3 |
| 1060 | 16.7 | 1107 | 64.5 | 1154 | 17.7 | 1201 | 86.8 |
| 1061 | 13.4 | 1108 | 64.4 | 1155 | 22.8 | 1202 | 87.4 |
| 1062 | 12.0 | 1109 | 63.5 | 1156 | 27.3 | 1203 | 88.0 |
| 1063 | 12.1 | 1110 | 62.0 | 1157 | 31.2 | 1204 | 88.3 |
| 1064 | 12.8 | 1111 | 61.2 | 1158 | 35.2 | 1205 | 88.7 |
| 1065 | 15.6 | 1112 | 61.3 | 1159 | 39.4 | 1206 | 89.0 |
| 1066 | 19.9 | 1113 | 61.7 | 1160 | 42.5 | 1207 | 89.3 |
| 1067 | 23.4 | 1114 | 62.0 | 1161 | 45.4 | 1208 | 89.8 |
| 1068 | 24.6 | 1115 | 64.6 | 1162 | 48.2 | 1209 | 90.2 |
| 1069 | 27.0 | 1116 | 66.0 | 1163 | 50.3 | 1210 | 90.6 |

| <i>Time in s</i> | <i>Speed in km/h</i> | <i>Time in s</i> | <i>Speed in km/h</i> | <i>Time in s</i> | <i>Speed in km/h</i> | <i>Time in s</i> | <i>Speed in km/h</i> |
|------------------|----------------------|------------------|----------------------|------------------|----------------------|------------------|----------------------|
| 1211 | 91.0 | 1260 | 95.7 | 1309 | 75.9 | 1358 | 68.2 |
| 1212 | 91.3 | 1261 | 95.5 | 1310 | 76.0 | 1359 | 66.1 |
| 1213 | 91.6 | 1262 | 95.3 | 1311 | 76.0 | 1360 | 63.8 |
| 1214 | 91.9 | 1263 | 95.2 | 1312 | 76.1 | 1361 | 61.6 |
| 1215 | 92.2 | 1264 | 95.0 | 1313 | 76.3 | 1362 | 60.2 |
| 1216 | 92.8 | 1265 | 94.9 | 1314 | 76.5 | 1363 | 59.8 |
| 1217 | 93.1 | 1266 | 94.7 | 1315 | 76.6 | 1364 | 60.4 |
| 1218 | 93.3 | 1267 | 94.5 | 1316 | 76.8 | 1365 | 61.8 |
| 1219 | 93.5 | 1268 | 94.4 | 1317 | 77.1 | 1366 | 62.6 |
| 1220 | 93.7 | 1269 | 94.4 | 1318 | 77.1 | 1367 | 62.7 |
| 1221 | 93.9 | 1270 | 94.3 | 1319 | 77.2 | 1368 | 61.9 |
| 1222 | 94.0 | 1271 | 94.3 | 1320 | 77.2 | 1369 | 60.0 |
| 1223 | 94.1 | 1272 | 94.1 | 1321 | 77.6 | 1370 | 58.4 |
| 1224 | 94.3 | 1273 | 93.9 | 1322 | 78.0 | 1371 | 57.8 |
| 1225 | 94.4 | 1274 | 93.4 | 1323 | 78.4 | 1372 | 57.8 |
| 1226 | 94.6 | 1275 | 92.8 | 1324 | 78.8 | 1373 | 57.8 |
| 1227 | 94.7 | 1276 | 92.0 | 1325 | 79.2 | 1374 | 57.3 |
| 1228 | 94.8 | 1277 | 91.3 | 1326 | 80.3 | 1375 | 56.2 |
| 1229 | 95.0 | 1278 | 90.6 | 1327 | 80.8 | 1376 | 54.3 |
| 1230 | 95.1 | 1279 | 90.0 | 1328 | 81.0 | 1377 | 50.8 |
| 1231 | 95.3 | 1280 | 89.3 | 1329 | 81.0 | 1378 | 45.5 |
| 1232 | 95.4 | 1281 | 88.7 | 1330 | 81.0 | 1379 | 40.2 |
| 1233 | 95.6 | 1282 | 88.1 | 1331 | 81.0 | 1380 | 34.9 |
| 1234 | 95.7 | 1283 | 87.4 | 1332 | 81.0 | 1381 | 29.6 |
| 1235 | 95.8 | 1284 | 86.7 | 1333 | 80.9 | 1382 | 28.7 |
| 1236 | 96.0 | 1285 | 86.0 | 1334 | 80.6 | 1383 | 29.3 |
| 1237 | 96.1 | 1286 | 85.3 | 1335 | 80.3 | 1384 | 30.5 |
| 1238 | 96.3 | 1287 | 84.7 | 1336 | 80.0 | 1385 | 31.7 |
| 1239 | 96.4 | 1288 | 84.1 | 1337 | 79.9 | 1386 | 32.9 |
| 1240 | 96.6 | 1289 | 83.5 | 1338 | 79.8 | 1387 | 35.0 |
| 1241 | 96.8 | 1290 | 82.9 | 1339 | 79.8 | 1388 | 38.0 |
| 1242 | 97.0 | 1291 | 82.3 | 1340 | 79.8 | 1389 | 40.5 |
| 1243 | 97.2 | 1292 | 81.7 | 1341 | 79.9 | 1390 | 42.7 |
| 1244 | 97.3 | 1293 | 81.1 | 1342 | 80.0 | 1391 | 45.8 |
| 1245 | 97.4 | 1294 | 80.5 | 1343 | 80.4 | 1392 | 47.5 |
| 1246 | 97.4 | 1295 | 79.9 | 1344 | 80.8 | 1393 | 48.9 |
| 1247 | 97.4 | 1296 | 79.4 | 1345 | 81.2 | 1394 | 49.4 |
| 1248 | 97.4 | 1297 | 79.1 | 1346 | 81.5 | 1395 | 49.4 |
| 1249 | 97.3 | 1298 | 78.8 | 1347 | 81.6 | 1396 | 49.2 |
| 1250 | 97.3 | 1299 | 78.5 | 1348 | 81.6 | 1397 | 48.7 |
| 1251 | 97.3 | 1300 | 78.2 | 1349 | 81.4 | 1398 | 47.9 |
| 1252 | 97.3 | 1301 | 77.9 | 1350 | 80.7 | 1399 | 46.9 |
| 1253 | 97.2 | 1302 | 77.6 | 1351 | 79.6 | 1400 | 45.6 |
| 1254 | 97.1 | 1303 | 77.3 | 1352 | 78.2 | 1401 | 44.2 |
| 1255 | 97.0 | 1304 | 77.0 | 1353 | 76.8 | 1402 | 42.7 |
| 1256 | 96.9 | 1305 | 76.7 | 1354 | 75.3 | 1403 | 40.7 |
| 1257 | 96.7 | 1306 | 76.0 | 1355 | 73.8 | 1404 | 37.1 |
| 1258 | 96.4 | 1307 | 76.0 | 1356 | 72.1 | 1405 | 33.9 |
| 1259 | 96.1 | 1308 | 76.0 | 1357 | 70.2 | 1406 | 30.6 |

| <i>Time in s</i> | <i>Speed in km/h</i> | <i>Time in s</i> | <i>Speed in km/h</i> | <i>Time in s</i> | <i>Speed in km/h</i> | <i>Time in s</i> | <i>Speed in km/h</i> |
|------------------|----------------------|------------------|----------------------|------------------|----------------------|------------------|----------------------|
| 1407 | 28.6 | 1456 | 0.0 | | | | |
| 1408 | 27.3 | 1457 | 0.0 | | | | |
| 1409 | 27.2 | 1458 | 0.0 | | | | |
| 1410 | 27.5 | 1459 | 0.0 | | | | |
| 1411 | 27.4 | 1460 | 0.0 | | | | |
| 1412 | 27.1 | 1461 | 0.0 | | | | |
| 1413 | 26.7 | 1462 | 0.0 | | | | |
| 1414 | 26.8 | 1463 | 0.0 | | | | |
| 1415 | 28.2 | 1464 | 0.0 | | | | |
| 1416 | 31.1 | 1465 | 0.0 | | | | |
| 1417 | 34.8 | 1466 | 0.0 | | | | |
| 1418 | 38.4 | 1467 | 0.0 | | | | |
| 1419 | 40.9 | 1468 | 0.0 | | | | |
| 1420 | 41.7 | 1469 | 0.0 | | | | |
| 1421 | 40.9 | 1470 | 0.0 | | | | |
| 1422 | 38.3 | 1471 | 0.0 | | | | |
| 1423 | 35.3 | 1472 | 0.0 | | | | |
| 1424 | 34.3 | 1473 | 0.0 | | | | |
| 1425 | 34.6 | 1474 | 0.0 | | | | |
| 1426 | 36.3 | 1475 | 0.0 | | | | |
| 1427 | 39.5 | 1476 | 0.0 | | | | |
| 1428 | 41.8 | 1477 | 0.0 | | | | |
| 1429 | 42.5 | | | | | | |
| 1430 | 41.9 | | | | | | |
| 1431 | 40.1 | | | | | | |
| 1432 | 36.6 | | | | | | |
| 1433 | 31.3 | | | | | | |
| 1434 | 26.0 | | | | | | |
| 1435 | 20.6 | | | | | | |
| 1436 | 19.1 | | | | | | |
| 1437 | 19.7 | | | | | | |
| 1438 | 21.1 | | | | | | |
| 1439 | 22.0 | | | | | | |
| 1440 | 22.1 | | | | | | |
| 1441 | 21.4 | | | | | | |
| 1442 | 19.6 | | | | | | |
| 1443 | 18.3 | | | | | | |
| 1444 | 18.0 | | | | | | |
| 1445 | 18.3 | | | | | | |
| 1446 | 18.5 | | | | | | |
| 1447 | 17.9 | | | | | | |
| 1448 | 15.0 | | | | | | |
| 1449 | 9.9 | | | | | | |
| 1450 | 4.6 | | | | | | |
| 1451 | 1.2 | | | | | | |
| 1452 | 0.0 | | | | | | |
| 1453 | 0.0 | | | | | | |
| 1454 | 0.0 | | | | | | |
| 1455 | 0.0 | | | | | | |

Table A1/11
WLTC, Class 3b cycle, phase High_{3b}

| <i>Time in s</i> | <i>Speed in km/h</i> | <i>Time in s</i> | <i>Speed in km/h</i> | <i>Time in s</i> | <i>Speed in km/h</i> | <i>Time in s</i> | <i>Speed in km/h</i> |
|------------------|----------------------|------------------|----------------------|------------------|----------------------|------------------|----------------------|
| 1023 | 0.0 | 1070 | 26.4 | 1117 | 69.7 | 1164 | 52.6 |
| 1024 | 0.0 | 1071 | 28.8 | 1118 | 69.3 | 1165 | 54.5 |
| 1025 | 0.0 | 1072 | 31.8 | 1119 | 68.1 | 1166 | 56.6 |
| 1026 | 0.0 | 1073 | 35.3 | 1120 | 66.9 | 1167 | 58.3 |
| 1027 | 0.8 | 1074 | 39.5 | 1121 | 66.2 | 1168 | 60.0 |
| 1028 | 3.6 | 1075 | 44.5 | 1122 | 65.7 | 1169 | 61.5 |
| 1029 | 8.6 | 1076 | 49.3 | 1123 | 64.9 | 1170 | 63.1 |
| 1030 | 14.6 | 1077 | 53.3 | 1124 | 63.2 | 1171 | 64.3 |
| 1031 | 20.0 | 1078 | 56.4 | 1125 | 60.3 | 1172 | 65.7 |
| 1032 | 24.4 | 1079 | 58.9 | 1126 | 55.8 | 1173 | 67.1 |
| 1033 | 28.2 | 1080 | 61.2 | 1127 | 50.5 | 1174 | 68.3 |
| 1034 | 31.7 | 1081 | 62.6 | 1128 | 45.2 | 1175 | 69.7 |
| 1035 | 35.0 | 1082 | 63.0 | 1129 | 40.1 | 1176 | 70.6 |
| 1036 | 37.6 | 1083 | 62.5 | 1130 | 36.2 | 1177 | 71.6 |
| 1037 | 39.7 | 1084 | 60.9 | 1131 | 32.9 | 1178 | 72.6 |
| 1038 | 41.5 | 1085 | 59.3 | 1132 | 29.8 | 1179 | 73.5 |
| 1039 | 43.6 | 1086 | 58.6 | 1133 | 26.6 | 1180 | 74.2 |
| 1040 | 46.0 | 1087 | 58.6 | 1134 | 23.0 | 1181 | 74.9 |
| 1041 | 48.4 | 1088 | 58.7 | 1135 | 19.4 | 1182 | 75.6 |
| 1042 | 50.5 | 1089 | 58.8 | 1136 | 16.3 | 1183 | 76.3 |
| 1043 | 51.9 | 1090 | 58.8 | 1137 | 14.6 | 1184 | 77.1 |
| 1044 | 52.6 | 1091 | 58.8 | 1138 | 14.2 | 1185 | 77.9 |
| 1045 | 52.8 | 1092 | 59.1 | 1139 | 14.3 | 1186 | 78.5 |
| 1046 | 52.9 | 1093 | 60.1 | 1140 | 14.6 | 1187 | 79.0 |
| 1047 | 53.1 | 1094 | 61.7 | 1141 | 15.1 | 1188 | 79.7 |
| 1048 | 53.3 | 1095 | 63.0 | 1142 | 16.4 | 1189 | 80.3 |
| 1049 | 53.1 | 1096 | 63.7 | 1143 | 19.1 | 1190 | 81.0 |
| 1050 | 52.3 | 1097 | 63.9 | 1144 | 22.5 | 1191 | 81.6 |
| 1051 | 50.7 | 1098 | 63.5 | 1145 | 24.4 | 1192 | 82.4 |
| 1052 | 48.8 | 1099 | 62.3 | 1146 | 24.8 | 1193 | 82.9 |
| 1053 | 46.5 | 1100 | 60.3 | 1147 | 22.7 | 1194 | 83.4 |
| 1054 | 43.8 | 1101 | 58.9 | 1148 | 17.4 | 1195 | 83.8 |
| 1055 | 40.3 | 1102 | 58.4 | 1149 | 13.8 | 1196 | 84.2 |
| 1056 | 36.0 | 1103 | 58.8 | 1150 | 12.0 | 1197 | 84.7 |
| 1057 | 30.7 | 1104 | 60.2 | 1151 | 12.0 | 1198 | 85.2 |
| 1058 | 25.4 | 1105 | 62.3 | 1152 | 12.0 | 1199 | 85.6 |
| 1059 | 21.0 | 1106 | 63.9 | 1153 | 13.9 | 1200 | 86.3 |
| 1060 | 16.7 | 1107 | 64.5 | 1154 | 17.7 | 1201 | 86.8 |
| 1061 | 13.4 | 1108 | 64.4 | 1155 | 22.8 | 1202 | 87.4 |
| 1062 | 12.0 | 1109 | 63.5 | 1156 | 27.3 | 1203 | 88.0 |
| 1063 | 12.1 | 1110 | 62.0 | 1157 | 31.2 | 1204 | 88.3 |
| 1064 | 12.8 | 1111 | 61.2 | 1158 | 35.2 | 1205 | 88.7 |
| 1065 | 15.6 | 1112 | 61.3 | 1159 | 39.4 | 1206 | 89.0 |
| 1066 | 19.9 | 1113 | 62.6 | 1160 | 42.5 | 1207 | 89.3 |
| 1067 | 23.4 | 1114 | 65.3 | 1161 | 45.4 | 1208 | 89.8 |
| 1068 | 24.6 | 1115 | 68.0 | 1162 | 48.2 | 1209 | 90.2 |
| 1069 | 25.2 | 1116 | 69.4 | 1163 | 50.3 | 1210 | 90.6 |

| <i>Time in s</i> | <i>Speed in km/h</i> | <i>Time in s</i> | <i>Speed in km/h</i> | <i>Time in s</i> | <i>Speed in km/h</i> | <i>Time in s</i> | <i>Speed in km/h</i> |
|------------------|----------------------|------------------|----------------------|------------------|----------------------|------------------|----------------------|
| 1211 | 91.0 | 1260 | 95.7 | 1309 | 75.9 | 1358 | 68.2 |
| 1212 | 91.3 | 1261 | 95.5 | 1310 | 75.9 | 1359 | 66.1 |
| 1213 | 91.6 | 1262 | 95.3 | 1311 | 75.8 | 1360 | 63.8 |
| 1214 | 91.9 | 1263 | 95.2 | 1312 | 75.7 | 1361 | 61.6 |
| 1215 | 92.2 | 1264 | 95.0 | 1313 | 75.5 | 1362 | 60.2 |
| 1216 | 92.8 | 1265 | 94.9 | 1314 | 75.2 | 1363 | 59.8 |
| 1217 | 93.1 | 1266 | 94.7 | 1315 | 75.0 | 1364 | 60.4 |
| 1218 | 93.3 | 1267 | 94.5 | 1316 | 74.7 | 1365 | 61.8 |
| 1219 | 93.5 | 1268 | 94.4 | 1317 | 74.1 | 1366 | 62.6 |
| 1220 | 93.7 | 1269 | 94.4 | 1318 | 73.7 | 1367 | 62.7 |
| 1221 | 93.9 | 1270 | 94.3 | 1319 | 73.3 | 1368 | 61.9 |
| 1222 | 94.0 | 1271 | 94.3 | 1320 | 73.5 | 1369 | 60.0 |
| 1223 | 94.1 | 1272 | 94.1 | 1321 | 74.0 | 1370 | 58.4 |
| 1224 | 94.3 | 1273 | 93.9 | 1322 | 74.9 | 1371 | 57.8 |
| 1225 | 94.4 | 1274 | 93.4 | 1323 | 76.1 | 1372 | 57.8 |
| 1226 | 94.6 | 1275 | 92.8 | 1324 | 77.7 | 1373 | 57.8 |
| 1227 | 94.7 | 1276 | 92.0 | 1325 | 79.2 | 1374 | 57.3 |
| 1228 | 94.8 | 1277 | 91.3 | 1326 | 80.3 | 1375 | 56.2 |
| 1229 | 95.0 | 1278 | 90.6 | 1327 | 80.8 | 1376 | 54.3 |
| 1230 | 95.1 | 1279 | 90.0 | 1328 | 81.0 | 1377 | 50.8 |
| 1231 | 95.3 | 1280 | 89.3 | 1329 | 81.0 | 1378 | 45.5 |
| 1232 | 95.4 | 1281 | 88.7 | 1330 | 81.0 | 1379 | 40.2 |
| 1233 | 95.6 | 1282 | 88.1 | 1331 | 81.0 | 1380 | 34.9 |
| 1234 | 95.7 | 1283 | 87.4 | 1332 | 81.0 | 1381 | 29.6 |
| 1235 | 95.8 | 1284 | 86.7 | 1333 | 80.9 | 1382 | 27.3 |
| 1236 | 96.0 | 1285 | 86.0 | 1334 | 80.6 | 1383 | 29.3 |
| 1237 | 96.1 | 1286 | 85.3 | 1335 | 80.3 | 1384 | 32.9 |
| 1238 | 96.3 | 1287 | 84.7 | 1336 | 80.0 | 1385 | 35.6 |
| 1239 | 96.4 | 1288 | 84.1 | 1337 | 79.9 | 1386 | 36.7 |
| 1240 | 96.6 | 1289 | 83.5 | 1338 | 79.8 | 1387 | 37.6 |
| 1241 | 96.8 | 1290 | 82.9 | 1339 | 79.8 | 1388 | 39.4 |
| 1242 | 97.0 | 1291 | 82.3 | 1340 | 79.8 | 1389 | 42.5 |
| 1243 | 97.2 | 1292 | 81.7 | 1341 | 79.9 | 1390 | 46.5 |
| 1244 | 97.3 | 1293 | 81.1 | 1342 | 80.0 | 1391 | 50.2 |
| 1245 | 97.4 | 1294 | 80.5 | 1343 | 80.4 | 1392 | 52.8 |
| 1246 | 97.4 | 1295 | 79.9 | 1344 | 80.8 | 1393 | 54.3 |
| 1247 | 97.4 | 1296 | 79.4 | 1345 | 81.2 | 1394 | 54.9 |
| 1248 | 97.4 | 1297 | 79.1 | 1346 | 81.5 | 1395 | 54.9 |
| 1249 | 97.3 | 1298 | 78.8 | 1347 | 81.6 | 1396 | 54.7 |
| 1250 | 97.3 | 1299 | 78.5 | 1348 | 81.6 | 1397 | 54.1 |
| 1251 | 97.3 | 1300 | 78.2 | 1349 | 81.4 | 1398 | 53.2 |
| 1252 | 97.3 | 1301 | 77.9 | 1350 | 80.7 | 1399 | 52.1 |
| 1253 | 97.2 | 1302 | 77.6 | 1351 | 79.6 | 1400 | 50.7 |
| 1254 | 97.1 | 1303 | 77.3 | 1352 | 78.2 | 1401 | 49.1 |
| 1255 | 97.0 | 1304 | 77.0 | 1353 | 76.8 | 1402 | 47.4 |
| 1256 | 96.9 | 1305 | 76.7 | 1354 | 75.3 | 1403 | 45.2 |
| 1257 | 96.7 | 1306 | 76.0 | 1355 | 73.8 | 1404 | 41.8 |
| 1258 | 96.4 | 1307 | 76.0 | 1356 | 72.1 | 1405 | 36.5 |
| 1259 | 96.1 | 1308 | 76.0 | 1357 | 70.2 | 1406 | 31.2 |

| <i>Time in s</i> | <i>Speed in km/h</i> | <i>Time in s</i> | <i>Speed in km/h</i> | <i>Time in s</i> | <i>Speed in km/h</i> | <i>Time in s</i> | <i>Speed in km/h</i> |
|------------------|----------------------|------------------|----------------------|------------------|----------------------|------------------|----------------------|
| 1407 | 27.6 | 1456 | 0.0 | | | | |
| 1408 | 26.9 | 1457 | 0.0 | | | | |
| 1409 | 27.3 | 1458 | 0.0 | | | | |
| 1410 | 27.5 | 1459 | 0.0 | | | | |
| 1411 | 27.4 | 1460 | 0.0 | | | | |
| 1412 | 27.1 | 1461 | 0.0 | | | | |
| 1413 | 26.7 | 1462 | 0.0 | | | | |
| 1414 | 26.8 | 1463 | 0.0 | | | | |
| 1415 | 28.2 | 1464 | 0.0 | | | | |
| 1416 | 31.1 | 1465 | 0.0 | | | | |
| 1417 | 34.8 | 1466 | 0.0 | | | | |
| 1418 | 38.4 | 1467 | 0.0 | | | | |
| 1419 | 40.9 | 1468 | 0.0 | | | | |
| 1420 | 41.7 | 1469 | 0.0 | | | | |
| 1421 | 40.9 | 1470 | 0.0 | | | | |
| 1422 | 38.3 | 1471 | 0.0 | | | | |
| 1423 | 35.3 | 1472 | 0.0 | | | | |
| 1424 | 34.3 | 1473 | 0.0 | | | | |
| 1425 | 34.6 | 1474 | 0.0 | | | | |
| 1426 | 36.3 | 1475 | 0.0 | | | | |
| 1427 | 39.5 | 1476 | 0.0 | | | | |
| 1428 | 41.8 | 1477 | 0.0 | | | | |
| 1429 | 42.5 | | | | | | |
| 1430 | 41.9 | | | | | | |
| 1431 | 40.1 | | | | | | |
| 1432 | 36.6 | | | | | | |
| 1433 | 31.3 | | | | | | |
| 1434 | 26.0 | | | | | | |
| 1435 | 20.6 | | | | | | |
| 1436 | 19.1 | | | | | | |
| 1437 | 19.7 | | | | | | |
| 1438 | 21.1 | | | | | | |
| 1439 | 22.0 | | | | | | |
| 1440 | 22.1 | | | | | | |
| 1441 | 21.4 | | | | | | |
| 1442 | 19.6 | | | | | | |
| 1443 | 18.3 | | | | | | |
| 1444 | 18.0 | | | | | | |
| 1445 | 18.3 | | | | | | |
| 1446 | 18.5 | | | | | | |
| 1447 | 17.9 | | | | | | |
| 1448 | 15.0 | | | | | | |
| 1449 | 9.9 | | | | | | |
| 1450 | 4.6 | | | | | | |
| 1451 | 1.2 | | | | | | |
| 1452 | 0.0 | | | | | | |
| 1453 | 0.0 | | | | | | |
| 1454 | 0.0 | | | | | | |
| 1455 | 0.0 | | | | | | |

Table A1/12
WLTC, Class 3 cycle, phase Extra High₃

| <i>Time in s</i> | <i>Speed in km/h</i> | <i>Time in s</i> | <i>Speed in km/h</i> | <i>Time in s</i> | <i>Speed in km/h</i> | <i>Time in s</i> | <i>Speed in km/h</i> |
|------------------|----------------------|------------------|----------------------|------------------|----------------------|------------------|----------------------|
| 1478 | 0.0 | 1525 | 72.5 | 1572 | 120.7 | 1619 | 113.0 |
| 1479 | 2.2 | 1526 | 70.8 | 1573 | 121.8 | 1620 | 114.1 |
| 1480 | 4.4 | 1527 | 68.6 | 1574 | 122.6 | 1621 | 115.1 |
| 1481 | 6.3 | 1528 | 66.2 | 1575 | 123.2 | 1622 | 115.9 |
| 1482 | 7.9 | 1529 | 64.0 | 1576 | 123.6 | 1623 | 116.5 |
| 1483 | 9.2 | 1530 | 62.2 | 1577 | 123.7 | 1624 | 116.7 |
| 1484 | 10.4 | 1531 | 60.9 | 1578 | 123.6 | 1625 | 116.6 |
| 1485 | 11.5 | 1532 | 60.2 | 1579 | 123.3 | 1626 | 116.2 |
| 1486 | 12.9 | 1533 | 60.0 | 1580 | 123.0 | 1627 | 115.2 |
| 1487 | 14.7 | 1534 | 60.4 | 1581 | 122.5 | 1628 | 113.8 |
| 1488 | 17.0 | 1535 | 61.4 | 1582 | 122.1 | 1629 | 112.0 |
| 1489 | 19.8 | 1536 | 63.2 | 1583 | 121.5 | 1630 | 110.1 |
| 1490 | 23.1 | 1537 | 65.6 | 1584 | 120.8 | 1631 | 108.3 |
| 1491 | 26.7 | 1538 | 68.4 | 1585 | 120.0 | 1632 | 107.0 |
| 1492 | 30.5 | 1539 | 71.6 | 1586 | 119.1 | 1633 | 106.1 |
| 1493 | 34.1 | 1540 | 74.9 | 1587 | 118.1 | 1634 | 105.8 |
| 1494 | 37.5 | 1541 | 78.4 | 1588 | 117.1 | 1635 | 105.7 |
| 1495 | 40.6 | 1542 | 81.8 | 1589 | 116.2 | 1636 | 105.7 |
| 1496 | 43.3 | 1543 | 84.9 | 1590 | 115.5 | 1637 | 105.6 |
| 1497 | 45.7 | 1544 | 87.4 | 1591 | 114.9 | 1638 | 105.3 |
| 1498 | 47.7 | 1545 | 89.0 | 1592 | 114.5 | 1639 | 104.9 |
| 1499 | 49.3 | 1546 | 90.0 | 1593 | 114.1 | 1640 | 104.4 |
| 1500 | 50.5 | 1547 | 90.6 | 1594 | 113.9 | 1641 | 104.0 |
| 1501 | 51.3 | 1548 | 91.0 | 1595 | 113.7 | 1642 | 103.8 |
| 1502 | 52.1 | 1549 | 91.5 | 1596 | 113.3 | 1643 | 103.9 |
| 1503 | 52.7 | 1550 | 92.0 | 1597 | 112.9 | 1644 | 104.4 |
| 1504 | 53.4 | 1551 | 92.7 | 1598 | 112.2 | 1645 | 105.1 |
| 1505 | 54.0 | 1552 | 93.4 | 1599 | 111.4 | 1646 | 106.1 |
| 1506 | 54.5 | 1553 | 94.2 | 1600 | 110.5 | 1647 | 107.2 |
| 1507 | 55.0 | 1554 | 94.9 | 1601 | 109.5 | 1648 | 108.5 |
| 1508 | 55.6 | 1555 | 95.7 | 1602 | 108.5 | 1649 | 109.9 |
| 1509 | 56.3 | 1556 | 96.6 | 1603 | 107.7 | 1650 | 111.3 |
| 1510 | 57.2 | 1557 | 97.7 | 1604 | 107.1 | 1651 | 112.7 |
| 1511 | 58.5 | 1558 | 98.9 | 1605 | 106.6 | 1652 | 113.9 |
| 1512 | 60.2 | 1559 | 100.4 | 1606 | 106.4 | 1653 | 115.0 |
| 1513 | 62.3 | 1560 | 102.0 | 1607 | 106.2 | 1654 | 116.0 |
| 1514 | 64.7 | 1561 | 103.6 | 1608 | 106.2 | 1655 | 116.8 |
| 1515 | 67.1 | 1562 | 105.2 | 1609 | 106.2 | 1656 | 117.6 |
| 1516 | 69.2 | 1563 | 106.8 | 1610 | 106.4 | 1657 | 118.4 |
| 1517 | 70.7 | 1564 | 108.5 | 1611 | 106.5 | 1658 | 119.2 |
| 1518 | 71.9 | 1565 | 110.2 | 1612 | 106.8 | 1659 | 120.0 |
| 1519 | 72.7 | 1566 | 111.9 | 1613 | 107.2 | 1660 | 120.8 |
| 1520 | 73.4 | 1567 | 113.7 | 1614 | 107.8 | 1661 | 121.6 |
| 1521 | 73.8 | 1568 | 115.3 | 1615 | 108.5 | 1662 | 122.3 |
| 1522 | 74.1 | 1569 | 116.8 | 1616 | 109.4 | 1663 | 123.1 |
| 1523 | 74.0 | 1570 | 118.2 | 1617 | 110.5 | 1664 | 123.8 |
| 1524 | 73.6 | 1571 | 119.5 | 1618 | 111.7 | 1665 | 124.4 |

| <i>Time in s</i> | <i>Speed in km/h</i> | <i>Time in s</i> | <i>Speed in km/h</i> | <i>Time in s</i> | <i>Speed in km/h</i> | <i>Time in s</i> | <i>Speed in km/h</i> |
|------------------|----------------------|------------------|----------------------|------------------|----------------------|------------------|----------------------|
| 1666 | 125.0 | 1715 | 127.7 | 1764 | 82.0 | | |
| 1667 | 125.4 | 1716 | 128.1 | 1765 | 81.3 | | |
| 1668 | 125.8 | 1717 | 128.5 | 1766 | 80.4 | | |
| 1669 | 126.1 | 1718 | 129.0 | 1767 | 79.1 | | |
| 1670 | 126.4 | 1719 | 129.5 | 1768 | 77.4 | | |
| 1671 | 126.6 | 1720 | 130.1 | 1769 | 75.1 | | |
| 1672 | 126.7 | 1721 | 130.6 | 1770 | 72.3 | | |
| 1673 | 126.8 | 1722 | 131.0 | 1771 | 69.1 | | |
| 1674 | 126.9 | 1723 | 131.2 | 1772 | 65.9 | | |
| 1675 | 126.9 | 1724 | 131.3 | 1773 | 62.7 | | |
| 1676 | 126.9 | 1725 | 131.2 | 1774 | 59.7 | | |
| 1677 | 126.8 | 1726 | 130.7 | 1775 | 57.0 | | |
| 1678 | 126.6 | 1727 | 129.8 | 1776 | 54.6 | | |
| 1679 | 126.3 | 1728 | 128.4 | 1777 | 52.2 | | |
| 1680 | 126.0 | 1729 | 126.5 | 1778 | 49.7 | | |
| 1681 | 125.7 | 1730 | 124.1 | 1779 | 46.8 | | |
| 1682 | 125.6 | 1731 | 121.6 | 1780 | 43.5 | | |
| 1683 | 125.6 | 1732 | 119.0 | 1781 | 39.9 | | |
| 1684 | 125.8 | 1733 | 116.5 | 1782 | 36.4 | | |
| 1685 | 126.2 | 1734 | 114.1 | 1783 | 33.2 | | |
| 1686 | 126.6 | 1735 | 111.8 | 1784 | 30.5 | | |
| 1687 | 127.0 | 1736 | 109.5 | 1785 | 28.3 | | |
| 1688 | 127.4 | 1737 | 107.1 | 1786 | 26.3 | | |
| 1689 | 127.6 | 1738 | 104.8 | 1787 | 24.4 | | |
| 1690 | 127.8 | 1739 | 102.5 | 1788 | 22.5 | | |
| 1691 | 127.9 | 1740 | 100.4 | 1789 | 20.5 | | |
| 1692 | 128.0 | 1741 | 98.6 | 1790 | 18.2 | | |
| 1693 | 128.1 | 1742 | 97.2 | 1791 | 15.5 | | |
| 1694 | 128.2 | 1743 | 95.9 | 1792 | 12.3 | | |
| 1695 | 128.3 | 1744 | 94.8 | 1793 | 8.7 | | |
| 1696 | 128.4 | 1745 | 93.8 | 1794 | 5.2 | | |
| 1697 | 128.5 | 1746 | 92.8 | 1795 | 0.0 | | |
| 1698 | 128.6 | 1747 | 91.8 | 1796 | 0.0 | | |
| 1699 | 128.6 | 1748 | 91.0 | 1797 | 0.0 | | |
| 1700 | 128.5 | 1749 | 90.2 | 1798 | 0.0 | | |
| 1701 | 128.3 | 1750 | 89.6 | 1799 | 0.0 | | |
| 1702 | 128.1 | 1751 | 89.1 | 1800 | 0.0 | | |
| 1703 | 127.9 | 1752 | 88.6 | | | | |
| 1704 | 127.6 | 1753 | 88.1 | | | | |
| 1705 | 127.4 | 1754 | 87.6 | | | | |
| 1706 | 127.2 | 1755 | 87.1 | | | | |
| 1707 | 127.0 | 1756 | 86.6 | | | | |
| 1708 | 126.9 | 1757 | 86.1 | | | | |
| 1709 | 126.8 | 1758 | 85.5 | | | | |
| 1710 | 126.7 | 1759 | 85.0 | | | | |
| 1711 | 126.8 | 1760 | 84.4 | | | | |
| 1712 | 126.9 | 1761 | 83.8 | | | | |
| 1713 | 127.1 | 1762 | 83.2 | | | | |
| 1714 | 127.4 | 1763 | 82.6 | | | | |

7. Cycle identification

In order to confirm if the correct cycle version was chosen or if the correct cycle was implemented into the test bench operation system, checksums of the vehicle speed values for cycle phases and the whole cycle are listed in Table A1/13.

Table A1/13
1Hz checksums

| <i>Cycle class</i> | <i>Cycle phase</i> | <i>Checksum of 1 Hz target vehicle speeds</i> |
|--------------------|--------------------|---|
| Class 1 | Low | 11988.4 |
| | Medium | 17162.8 |
| | Low | 11988.4 |
| | Total | 41139.6 |
| Class 2 | Low | 11162.2 |
| | Medium | 17054.3 |
| | High | 24450.6 |
| | Extra High | 28869.8 |
| | Total | 81536.9 |
| Class 3a | Low | 11140.3 |
| | Medium | 16995.7 |
| | High | 25646.0 |
| | Extra High | 29714.9 |
| | Total | 83496.9 |
| Class 3b | Low | 11140.3 |
| | Medium | 17121.2 |
| | High | 25782.2 |
| | Extra High | 29714.9 |
| | Total | 83758.6 |

8. Cycle modification

This paragraph shall not apply to OVC-HEVs, NOVC-HEVs and NOVC-FCHVs.

8.1. General remarks

Driveability problems may occur for vehicles with power to mass ratios close to the borderlines between Class 1 and Class 2, Class 2 and Class 3 vehicles, or very low powered vehicles in Class 1.

Since these problems are related mainly to cycle phases with a combination of high vehicle speed and high accelerations rather than to the maximum speed of the cycle, the downscaling procedure shall be applied to improve driveability.

8.2. This paragraph describes the method to modify the cycle profile using the downscaling procedure.

8.2.1. Downscaling procedure for Class 1 vehicles

Figure A1/14 shows an example of a downscaled medium speed phase of the Class 1 WLTC.

Figure A1/14

Downscaled medium speed phase of the Class 1 WLTC

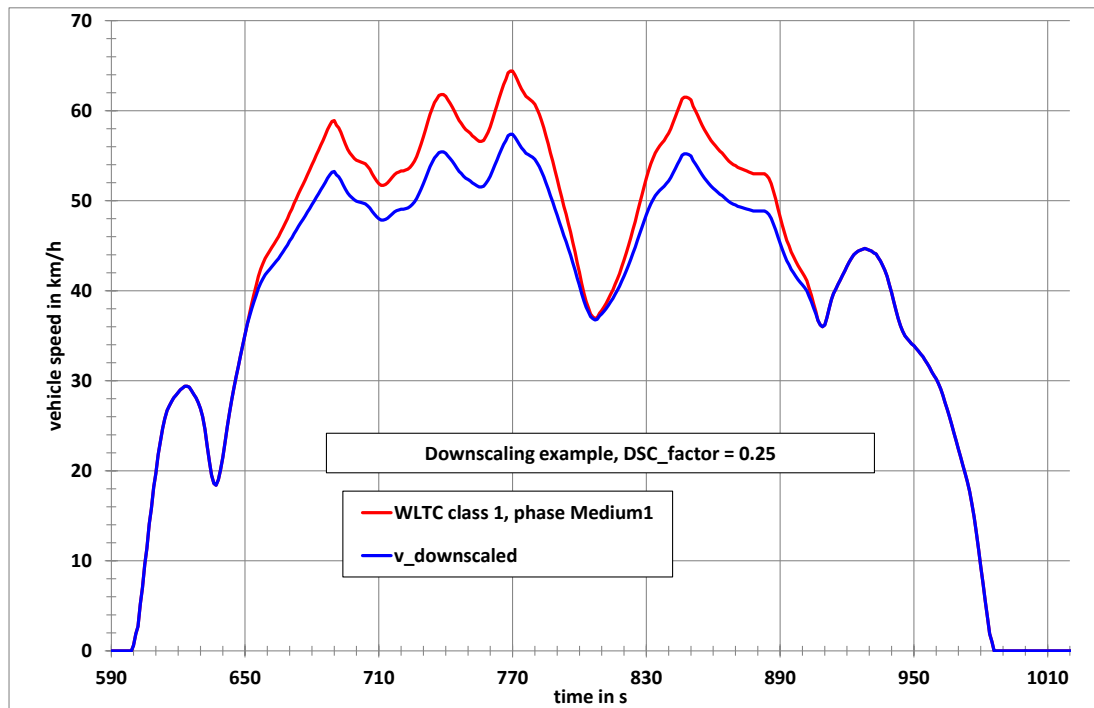

For the Class 1 cycle, the downscaling period is the time period between second 651 and second 906. Within this time period, the acceleration for the original cycle shall be calculated using the following equation:

$$a_{\text{orig}_i} = \frac{v_{i+1} - v_i}{3.6}$$

where:

v_i is the vehicle speed, km/h;

i is the time between second 651 and second 906.

The downscaling shall be applied first in the time period between second 651 and second 848. The downscaled speed trace shall be subsequently calculated using the following equation:

$$v_{\text{dsc}_{i+1}} = v_{\text{dsc}_i} + a_{\text{orig}_i} \times (1 - f_{\text{dsc}}) \times 3.6$$

with $i = 651$ to 847.

For $i = 651$, $v_{\text{dsc}_i} = v_{\text{orig}_i}$.

In order to meet the original vehicle speed at second 907, a correction factor for the deceleration shall be calculated using the following equation:

$$f_{\text{corr_dec}} = \frac{v_{\text{dsc_848}} - 36.7}{v_{\text{orig_848}} - 36.7}$$

where 36.7 km/h is the original vehicle speed at second 907.

The downscaled vehicle speed between second 849 and second 906 shall be subsequently calculated using the following equation:

$$v_{\text{dsc}_i} = v_{\text{dsc}_{i-1}} + a_{\text{orig}_{i-1}} \times f_{\text{corr_dec}} \times 3.6$$

For $i = 849$ to 906 .

8.2.2. Downscaling procedure for Class 2 vehicles

Since the driveability problems are exclusively related to the extra high speed phases of the Class 2 and Class 3 cycles, the downscaling is related to those time periods of the extra high speed phases where driveability problems are expected to occur (see Figures A1/15 and A1/16).

Figure A1/15

Downscaled extra high speed phase of the Class 2 WLTC

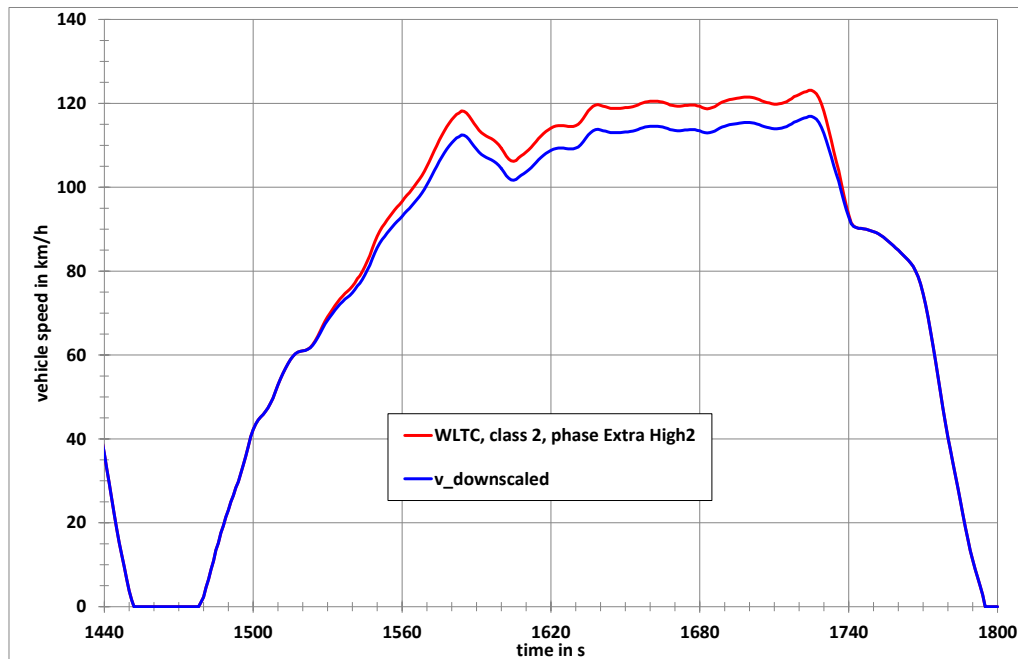

For the Class 2 cycle, the downscaling period is the time period between second 1520 and second 1742. Within this time period, the acceleration for the original cycle shall be calculated using the following equation:

$$a_{\text{orig}_i} = \frac{v_{i+1} - v_i}{3.6}$$

where:

v_i is the vehicle speed, km/h;

i is the time between second 1520 and second 1742.

The downscaling shall be applied first to the time period between second 1520 and second 1725. Second 1725 is the time when the maximum speed of the extra high speed phase is reached. The downscaled speed trace shall be subsequently calculated using the following equation:

$$v_{dsc_{i+1}} = v_{dsc_i} + a_{orig_i} \times (1 - f_{dsc}) \times 3.6$$

for $i = 1520$ to 1724.

For $i = 1520$, $v_{dsc_i} = v_{orig_i}$.

In order to meet the original vehicle speed at second 1743, a correction factor for the deceleration shall be calculated using the following equation:

$$f_{corr_dec} = \frac{v_{dsc_1725} - 90.4}{v_{orig_1725} - 90.4}$$

90.4 km/h is the original vehicle speed at second 1743.

The downscaled vehicle speed between second 1726 and second 1742 shall be calculated using the following equation:

$$v_{dsc_i} = v_{dsc_{i-1}} + a_{orig_{i-1}} \times f_{corr_dec} \times 3.6$$

for $i = 1726$ to 1742.

8.2.3. Downscaling procedure for Class 3 vehicles

Figure A1/16 shows an example for a downscaled extra high speed phase of the Class 3 WLTC.

Figure A1/16

Downscaled extra high speed phase of the Class 3 WLTC

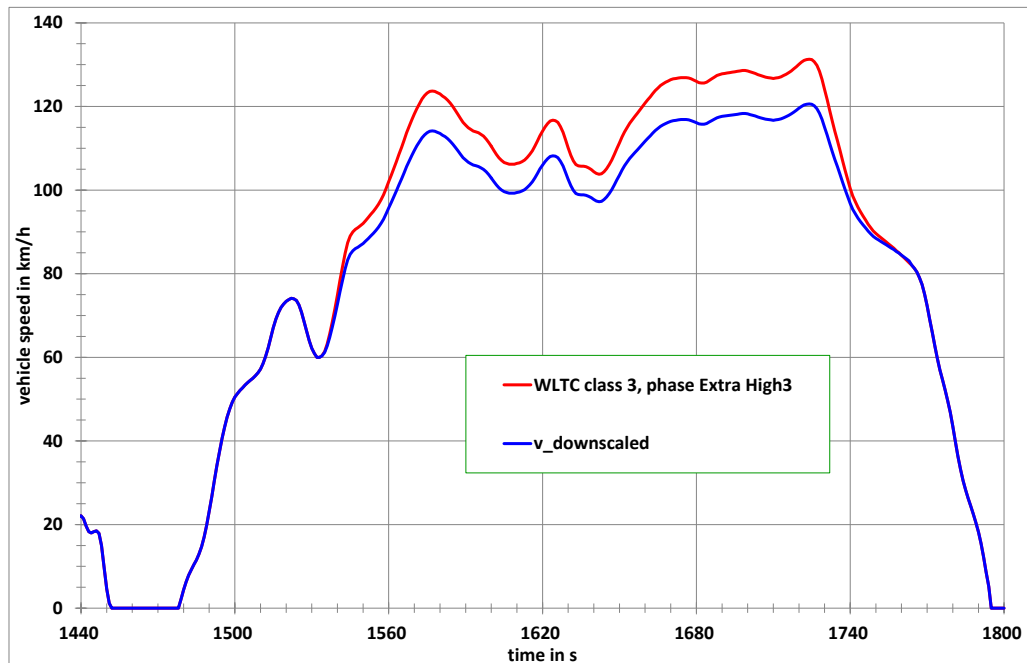

For the Class 3 cycle, the downscaling period is the time period between second 1533 and second 1762. Within this time period, the acceleration for the original cycle shall be calculated using the following equation:

$$a_{\text{orig}_i} = \frac{v_{i+1} - v_i}{3.6}$$

where:

v_i is the vehicle speed, km/h;

i is the time between second 1533 and second 1762.

The downscaling shall be applied first in the time period between second 1533 and second 1724. Second 1724 is the time when the maximum speed of the extra high speed phase is reached. The downscaled speed trace shall be subsequently calculated using the following equation:

$$v_{\text{dsc}_{i+1}} = v_{\text{dsc}_i} + a_{\text{orig}_i} \times (1 - f_{\text{dsc}}) \times 3.6$$

For $i = 1533$ to 1723 .

For $i = 1533$, $v_{\text{dsc}_i} = v_{\text{orig}_i}$.

In order to meet the original vehicle speed at second 1763, a correction factor for the deceleration shall be calculated using the following equation:

$$f_{\text{corr_dec}} = \frac{v_{\text{dsc_1724}} - 82.6}{v_{\text{orig_1724}} - 82.6}$$

82.6 km/h is the original vehicle speed at second 1763.

The downscaled vehicle speed between second 1725 and second 1762 shall be subsequently calculated using the following equation:

$$v_{\text{dsc}_i} = v_{\text{dsc}_{i-1}} + a_{\text{orig}_{i-1}} \times f_{\text{corr_dec}} \times 3.6$$

For $i = 1725$ to 1762 .

8.3. Determination of the downscaling factor

The downscaling factor f_{dsc} is a function of the ratio r_{max} between the maximum required power of the cycle phases where the downscaling is to be applied and the rated power of the vehicle, P_{rated} .

The maximum required power $P_{\text{req,max},i}$ (in kW) is related to a specific time i and the corresponding vehicle speed v_i in the cycle trace and is calculated using the following equation:

$$P_{\text{req,max},i} = \frac{\left((f_0 \times v_i) + (f_1 \times v_i^2) + (f_2 \times v_i^3) + (1.03 \times \text{TM} \times v_i \times a_i) \right)}{3,600}$$

where:

f_0, f_1, f_2 are the applicable road load coefficients, N, N/(km/h), and N/(km/h)² respectively;

TM is the applicable test mass, kg;

v_i is the speed at time i , km/h;

a_i is the acceleration at time i , km/h².

The cycle time i at which maximum power or power values close to maximum power is required is second 764 for the Class 1 cycle, second 1574 for the Class 2 cycle and second 1566 for the Class 3 cycle.

The corresponding vehicle speed values, v_i , and acceleration values, a_i , are as follows:

$v_i = 61.4$ km/h, $a_i = 0.22$ m/s² for Class 1,

$v_i = 109.9$ km/h, $a_i = 0.36$ m/s² for Class 2,

$v_i = 111.9$ km/h, $a_i = 0.50$ m/s² for Class 3.

r_{\max} shall be calculated using the following equation:

$$r_{\max} = \frac{P_{\text{req,max},i}}{P_{\text{rated}}}$$

The downscaling factor, f_{dsc} , shall be calculated using the following equations:

$$\text{if } r_{\max} < r_0, \text{ then } f_{\text{dsc}} = 0$$

and no downscaling shall be applied.

If $r_{\max} \geq r_0$, then $f_{\text{dsc}} = a_1 \times r_{\max} + b_1$.

The calculation parameter/coefficients, r_0 , a_1 and b_1 , are as follows:

Class 1 $r_0 = 0.978$, $a_1 = 0.680$, $b_1 = -0.665$

Class 2 $r_0 = 0.866$, $a_1 = 0.606$, $b_1 = -0.525$.

Class 3 $r_0 = 0.867$, $a_1 = 0.588$, $b_1 = -0.510$.

The resulting f_{dsc} shall be rounded according to paragraph 7. of this UN GTR to 3 places of decimal and shall be applied only if it exceeds 0.010.

The following data shall be recorded:

- (a) f_{dsc} ;
- (b) v_{\max} ;
- (c) distance driven, m.

The distance shall be calculated as the sum of v_i in km/h divided by 3.6 over the whole cycle trace.

8.4. Additional requirements

For different vehicle configurations in terms of test mass and driving resistance coefficients, downscaling shall be applied individually.

If, after application of downscaling, the vehicle's maximum speed is lower than the maximum speed of the cycle, the process described in paragraph 9. of this annex shall be applied with the applicable cycle.

If the vehicle cannot follow the speed trace of the applicable cycle within the tolerance at speeds lower than its maximum speed, it shall be driven with the accelerator control fully activated during these periods. During such periods of operation, speed trace violations shall be permitted.

9. Cycle modifications for vehicles with a maximum speed lower than the maximum speed of the cycle specified in the previous paragraphs of this annex

9.1. General remarks

This paragraph applies, if required by regional legislation, to vehicles that are technically able to follow the speed trace of the applicable cycle specified in paragraph 1. of this annex (base cycle) at speeds lower than its maximum speed, but whose maximum speed is limited to a value lower than the maximum speed of the base cycle for other reasons. For the purposes of this paragraph, this applicable cycle shall be referred to as the "base cycle" and is used to determine the capped speed cycle.

In the cases where downscaling according to paragraph 8.2. of this annex is applied, the downscaled cycle shall be used as the base cycle.

The maximum speed of the base cycle shall be referred to as $v_{\max, \text{cycle}}$.

The maximum speed of the vehicle shall be referred to as its capped speed v_{cap} .

If v_{cap} is applied to a Class 3b vehicle as defined in paragraph 3.3.2. of this annex, the Class 3b cycle shall be used as the base cycle. This shall apply even if v_{cap} is lower than 120 km/h.

In the cases where v_{cap} is applied, the base cycle shall be modified as described in paragraph 9.2. of this annex in order to achieve the same cycle distance for the capped speed cycle as for the base cycle.

9.2. Calculation steps

9.2.1. Determination of the distance difference per cycle phase

An interim capped speed cycle shall be derived by replacing all vehicle speed samples v_i where $v_i > v_{\text{cap}}$ by v_{cap} .

9.2.1.1. If $v_{\text{cap}} < v_{\max, \text{medium}}$, the distance of the medium speed phases of the base cycle $d_{\text{base, medium}}$ and the interim capped speed cycle $d_{\text{cap, medium}}$ shall be calculated using the following equation for both cycles:

$$d_{\text{medium}} = \sum \left(\frac{(v_i + v_{i-1})}{2 \times 3.6} \times (t_i - t_{i-1}) \right), \text{ for } i = 591 \text{ to } 1022$$

where:

$v_{\max, \text{medium}}$ is the maximum vehicle speed of the medium speed phase as listed in Table A1/2 for the Class 1 cycle, in Table A1/4 for the Class 2 cycle, in Table A1/8 for the Class 3a cycle and in Table A1/9 for the Class 3b cycle.

9.2.1.2. If $v_{\text{cap}} < v_{\max, \text{high}}$, the distances of the high speed phases of the base cycle $d_{\text{base, high}}$ and the interim capped speed cycle $d_{\text{cap, high}}$ shall be calculated using the following equation for both cycles:

$$d_{\text{high}} = \sum \left(\frac{(v_i + v_{i-1})}{2 \times 3.6} \times (t_i - t_{i-1}) \right), \text{ for } i = 1024 \text{ to } 1477$$

$v_{\max, \text{high}}$ is the maximum vehicle speed of the high speed phase as listed in Table A1/5 for the Class 2 cycle, in Table A1/10 for the Class 3a cycle and in Table A1/11 for the Class 3b cycle.

9.2.1.3. The distances of the extra high speed phase of the base cycle $d_{\text{base, exhigh}}$ and the interim capped speed cycle $d_{\text{cap, exhigh}}$ shall be calculated applying the following equation to the extra high speed phase of both cycles:

$$d_{\text{exhigh}} = \sum \left(\frac{v_i + v_{i-1}}{2 \times 3.6} \times (t_i - t_{i-1}) \right), \text{ for } i = 1479 \text{ to } 1800$$

- 9.2.2. Determination of the time periods to be added to the interim capped speed cycle in order to compensate for distance differences

In order to compensate for a difference in distance between the base cycle and the interim capped speed cycle, corresponding time periods with $v_i = v_{\text{cap}}$ shall be added to the interim capped speed cycle as described in paragraphs 9.2.2.1. to 9.2.2.3. inclusive of this annex.

- 9.2.2.1. Additional time period for the medium speed phase

If $v_{\text{cap}} < v_{\text{max,medium}}$, the additional time period to be added to the medium speed phase of the interim capped speed cycle shall be calculated using the following equation:

$$\Delta t_{\text{medium}} = \frac{(d_{\text{base,medium}} - d_{\text{cap,medium}})}{v_{\text{cap}}} \times 3.6$$

The number of time samples $n_{\text{add,medium}}$ with $v_i = v_{\text{cap}}$ to be added to the medium speed phase of the interim capped speed cycle equals Δt_{medium} , rounded according to paragraph 7. of this UN GTR to the nearest integer.

- 9.2.2.2. Additional time period for the high speed phase

If $v_{\text{cap}} < v_{\text{max,high}}$, the additional time period to be added to the high speed phases of the interim capped speed cycle shall be calculated using the following equation:

$$\Delta t_{\text{high}} = \frac{(d_{\text{base,high}} - d_{\text{cap,high}})}{v_{\text{cap}}} \times 3.6$$

The number of time samples $n_{\text{add,high}}$ with $v_i = v_{\text{cap}}$ to be added to the high speed phase of the interim capped speed cycle equals Δt_{high} , rounded according to paragraph 7. of this UN GTR to the nearest integer.

- 9.2.2.3. The additional time period to be added to the extra high speed phase of the interim capped speed cycle shall be calculated using the following equation:

$$\Delta t_{\text{exhigh}} = \frac{(d_{\text{base,exhigh}} - d_{\text{cap,exhigh}})}{v_{\text{cap}}} \times 3.6$$

The number of time samples $n_{\text{add,exhigh}}$ with $v_i = v_{\text{cap}}$ to be added to the extra high speed phase of the interim capped speed cycle equals Δt_{exhigh} , rounded according to paragraph 7. of this UN GTR to the nearest integer.

- 9.2.3. Construction of the final capped speed cycle

- 9.2.3.1. Class 1 cycle

The first part of the final capped speed cycle consists of the vehicle speed trace of the interim capped speed cycle up to the last sample in the medium speed phase where $v = v_{\text{cap}}$. The time of this sample is referred to as t_{medium} .

Then $n_{\text{add,medium}}$ samples with $v_i = v_{\text{cap}}$ shall be added, so that the time of the last sample is $(t_{\text{medium}} + n_{\text{add,medium}})$.

The remaining part of the medium speed phase of the interim capped speed cycle, which is identical with the same part of the base cycle, shall then be added, so that the time of the last sample is $(1022 + n_{\text{add,medium}})$.

- 9.2.3.2. Class 2 and Class 3 cycles

9.2.3.2.1. $v_{cap} < v_{max,medium}$

The first part of the final capped speed cycle consists of the vehicle speed trace of the interim capped speed cycle up to the last sample in the medium speed phase where $v = v_{cap}$. The time of this sample is referred to as t_{medium} .

Then $n_{add,medium}$ samples with $v_i = v_{cap}$ shall be added, so that the time of the last sample is $(t_{medium} + n_{add,medium})$.

The remaining part of the medium speed phase of the interim capped speed cycle, which is identical with the same part of the base cycle, shall then be added, so that the time of the last sample is $(1022 + n_{add,medium})$.

In a next step, the first part of the high speed phase of the interim capped speed cycle up to the last sample in the high speed phase where $v = v_{cap}$ shall be added. The time of this sample in the interim capped speed is referred to as t_{high} , so that the time of this sample in the final capped speed cycle is $(t_{high} + n_{add,medium})$.

Then, $n_{add,high}$ samples with $v_i = v_{cap}$ shall be added, so that the time of the last sample becomes $(t_{high} + n_{add,medium} + n_{add,high})$.

The remaining part of the high speed phase of the interim capped speed cycle, which is identical with the same part of the base cycle, shall then be added, so that the time of the last sample is $(1477 + n_{add,medium} + n_{add,high})$.

In a next step, the first part of the extra high speed phase of the interim capped speed cycle up to the last sample in the extra high speed phase where $v = v_{cap}$ shall be added. The time of this sample in the interim capped speed is referred to as t_{exhigh} , so that the time of this sample in the final capped speed cycle is $(t_{exhigh} + n_{add,medium} + n_{add,high})$.

Then $n_{add,exhigh}$ samples with $v_i = v_{cap}$ shall be added, so that the time of the last sample is $(t_{exhigh} + n_{add,medium} + n_{add,high} + n_{add,exhigh})$.

The remaining part of the extra high speed phase of the interim capped speed cycle, which is identical with the same part of the base cycle, shall then be added, so that the time of the last sample is $(1800 + n_{add,medium} + n_{add,high} + n_{add,exhigh})$.

The length of the final capped speed cycle is equivalent to the length of the base cycle except for differences caused by the rounding process according to paragraph 7. of this UN GTR for $n_{add,medium}$, $n_{add,high}$ and $n_{add,exhigh}$.

9.2.3.2.2. $v_{max,medium} \leq v_{cap} < v_{max,high}$

The first part of the final capped speed cycle consists of the vehicle speed trace of the interim capped speed cycle up to the last sample in the high speed phase where $v = v_{cap}$. The time of this sample is referred to as t_{high} .

Then, $n_{add,high}$ samples with $v_i = v_{cap}$ shall be added, so that the time of the last sample is $(t_{high} + n_{add,high})$.

The remaining part of the high speed phase of the interim capped speed cycle, which is identical with the same part of the base cycle, shall then be added, so that the time of the last sample is $(1477 + n_{add,high})$.

In a next step, the first part of the extra high speed phase of the interim capped speed cycle up to the last sample in the extra high speed phase where $v = v_{cap}$ shall be added. The time of this sample in the interim capped speed is referred

to as t_{exhigh} , so that the time of this sample in the final capped speed cycle is $(t_{\text{exhigh}} + n_{\text{add,high}})$.

Then $n_{\text{add,exhigh}}$ samples with $v_i = v_{\text{cap}}$ shall be added, so that the time of the last sample is $(t_{\text{exhigh}} + n_{\text{add,high}} + n_{\text{add,exhigh}})$.

The remaining part of the extra high speed phase of the interim capped speed cycle, which is identical with the same part of the base cycle, shall then be added, so that the time of the last sample is $(1800 + n_{\text{add,high}} + n_{\text{add,exhigh}})$.

The length of the final capped speed cycle is equivalent to the length of the base cycle except for differences caused by the rounding process according to paragraph 7. of this UN GTR for $n_{\text{add,high}}$ and $n_{\text{add,exhigh}}$.

9.2.3.2.3. $v_{\text{max, high}} \leq v_{\text{cap}} < v_{\text{max, exhigh}}$

The first part of the final capped speed cycle consists of the vehicle speed trace of the interim capped speed cycle up to the last sample in the extra high speed phase where $v = v_{\text{cap}}$. The time of this sample is referred to as t_{exhigh} .

Then, $n_{\text{add,exhigh}}$ samples with $v_i = v_{\text{cap}}$ shall be added, so that the time of the last sample is $(t_{\text{exhigh}} + n_{\text{add,exhigh}})$.

The remaining part of the extra high speed phase of the interim capped speed cycle, which is identical with the same part of the base cycle, shall then be added, so that the time of the last sample is $(1800 + n_{\text{add,exhigh}})$.

The length of the final capped speed cycle is equivalent to the length of the base cycle except for differences caused by the rounding process according to paragraph 7. of this UN GTR for $n_{\text{add,exhigh}}$.

10. Allocation of cycles to vehicles

- 10.1. A vehicle of a certain class shall be tested on the cycle of the same class, i.e. Class 1 vehicles on the Class 1 cycle, Class 2 vehicles on the Class 2 cycle, Class 3a vehicles on the Class 3a cycle, and Class 3b vehicles on the Class 3b cycle. However, at the request of the manufacturer and with approval of the responsible authority, a vehicle may be tested on a numerically higher cycle class, e.g. a Class 2 vehicle may be tested on a Class 3 cycle. In this case the differences between Classes 3a and 3b shall be respected and the cycle may be downscaled according to paragraphs 8. to 8.4. inclusive of this annex.

Annex 2

Gear selection and shift point determination for vehicles equipped with manual transmissions

1. General approach
 - 1.1. The shifting procedures described in this annex shall apply to vehicles equipped with manual shift transmissions.
 - 1.2. The prescribed gears and shifting points are based on the balance between the power required to overcome driving resistance and acceleration, and the power provided by the engine in all possible gears at a specific cycle phase.
 - 1.3. The calculation to determine the gears to use shall be based on engine speeds and full load power curves versus engine speed.
 - 1.4. For vehicles equipped with a dual-range transmission (low and high), only the range designed for normal on-road operation shall be considered for gear use determination.
 - 1.5. The prescriptions for clutch operation shall not be applied if the clutch is operated automatically without the need of an engagement or disengagement of the driver.
 - 1.6. This annex shall not apply to vehicles tested according to Annex 8.

2. Required data and precalculations

The following data are required and calculations shall be performed in order to determine the gears to be used when driving the cycle on a chassis dynamometer:

- (a) P_{rated} , the maximum rated engine power as declared by the manufacturer, kW;
- (b) n_{rated} , the rated engine speed declared by the manufacturer as the engine speed at which the engine develops its maximum power, min^{-1} ;
- (c) n_{idle} , idling speed, min^{-1} .

n_{idle} shall be measured over a period of at least 1 minute at a sampling rate of at least 1 Hz with the engine running in warm condition, the gear lever placed in neutral, and the clutch engaged. The conditions for temperature, peripheral and auxiliary devices, etc. shall be the same as described in Annex 6 for the Type 1 test.

The value to be used in this annex shall be the arithmetic average over the measuring period and rounded according to paragraph 7. of this UN GTR to the nearest 10 min^{-1} ;

- (d) n_g , the number of forward gears.

The forward gears in the transmission range designed for normal on-road operation shall be numbered in descending order of the ratio between engine speed in min^{-1} and vehicle speed in km/h. Gear 1 is the gear with the highest ratio, gear n_g is the gear with the lowest ratio. n_g determines the number of forward gears;

(e) $(n/v)_i$, the ratio obtained by dividing the engine speed n by the vehicle speed v for each gear i , for $i = 1$ to n_g , $\text{min}^{-1}/(\text{km/h})$. $(n/v)_i$ shall be calculated according to the equations in paragraph 8. of Annex 7;

(f) f_0, f_1, f_2 , road load coefficients selected for testing, $N, N/(\text{km/h})$, and $N/(\text{km/h})^2$ respectively;

(g) n_{max}

$n_{\text{max}1} = n_{95_high}$, the maximum engine speed where 95 per cent of rated power is reached, min^{-1} ;

If n_{95_high} cannot be determined because the engine speed is limited to a lower value n_{lim} for all gears and the corresponding full load power is higher than 95 per cent of rated power, n_{95_high} shall be set to n_{lim} .

$$n_{\text{max}2} = (n/v)(ng) \times v_{\text{max,cycle}}$$

$$n_{\text{max}3} = (n/v)(ng) \times v_{\text{max,vehicle}}$$

where:

$v_{\text{max,cycle}}$ is the maximum speed of the vehicle speed trace according to Annex 1, km/h ;

$v_{\text{max,vehicle}}$ is the maximum speed of the vehicle according to paragraph 2.(i) of this annex, km/h ;

$(n/v)(ng_{v_{\text{max}}})$ is the ratio obtained by dividing engine speed n by the vehicle speed v for the gear $ng_{v_{\text{max}}}$, $\text{min}^{-1}/(\text{km/h})$;

$ng_{v_{\text{max}}}$ is defined in paragraph 2.(i) of this annex;

n_{max} is the maximum of $n_{\text{max}1}$, $n_{\text{max}2}$ and $n_{\text{max}3}$, min^{-1} .

(h) $P_{\text{wot}}(n)$, the full load power curve over the engine speed range

The power curve shall consist of a sufficient number of data sets (n, P_{wot}) so that the calculation of interim points between consecutive data sets can be performed by linear interpolation. Deviation of the linear interpolation from the full load power curve according to Regulation No. 85 shall not exceed 2 per cent. The first data set shall be at $n_{\text{min_drive_set}}$ (see (k)(3) below) or lower. The last data set shall be at n_{max} or higher engine speed. Data sets need not be spaced equally but all data sets shall be reported.

The data sets and the values P_{rated} and n_{rated} shall be taken from the power curve as declared by the manufacturer.

The full load power at engine speeds not covered by Regulation No. 85 shall be determined according to the method described in Regulation No. 85;

(i) Determination of $ng_{v_{\text{max}}}$ and v_{max}

$ng_{v_{\text{max}}}$, the gear in which the maximum vehicle speed is reached and shall be determined as follows:

If $v_{\text{max}}(ng) \geq v_{\text{max}}(ng-1)$ and $v_{\text{max}}(ng-1) \geq v_{\text{max}}(ng-2)$, then:

$$ng_{v_{\text{max}}} = ng \text{ and } v_{\text{max}} = v_{\text{max}}(ng).$$

If $v_{\text{max}}(ng) < v_{\text{max}}(ng-1)$ and $v_{\text{max}}(ng-1) \geq v_{\text{max}}(ng-2)$, then:

$ng_{vmax} = ng-1$ and $v_{max} = v_{max}(ng-1)$,

otherwise, $ng_{vmax} = ng-2$ and $v_{max} = v_{max}(ng-2)$

where:

$v_{max}(ng)$ is the vehicle speed at which the required road load power equals the available power P_{wot} in gear ng (see Figure A2/1a).

$v_{max}(ng-1)$ is the vehicle speed at which the required road load power equals the available power P_{wot} in the next lower gear (gear $ng-1$). See Figure A2/1b.

$v_{max}(ng-2)$ is the vehicle speed at which the required road load power equals the available power P_{wot} in the gear $ng-2$.

Vehicle speed values rounded according to paragraph 7. of this UN GTR to one place of decimal shall be used for the determination of v_{max} and ng_{vmax} .

The required road load power, kW, shall be calculated using the following equation:

$$P_{required} = \frac{(f_0 \times v) + (f_1 \times v^2) + (f_2 \times v^3)}{3600}$$

where:

v is the vehicle speed specified above, km/h.

The available power at vehicle speed v_{max} in gear ng , gear $ng-1$ or gear $ng-2$ shall be determined from the full load power curve, $P_{wot}(n)$, by using the following equations:

$$n_{ng} = (n/v)_{ng} \times v_{max}(ng);$$

$$n_{ng-1} = (n/v)_{ng-1} \times v_{max}(ng-1);$$

$$n_{ng-2} = (n/v)_{ng-2} \times v_{max}(ng-2),$$

and by reducing the power values of the full load power curve by 10 per cent.

The method described above shall be extended to even lower gears, i.e. $ng-3$, $ng-4$, etc. if necessary.

If, for the purpose of limiting maximum vehicle speed, the maximum engine speed is limited to n_{lim} which is lower than the engine speed corresponding to the intersection of the road load power curve and the available power curve, then:

$$ng_{vmax} = ng \text{ and } v_{max} = n_{lim} / (n/v)(ng).$$

Figure A2/1a
 An example where $n_{g_{vmax}}$ is the highest gear

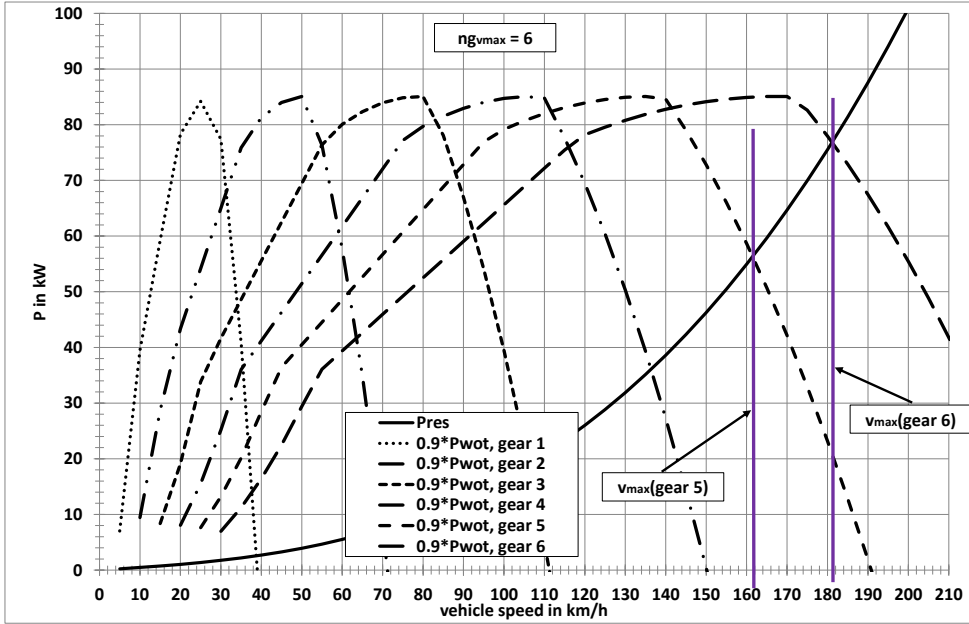
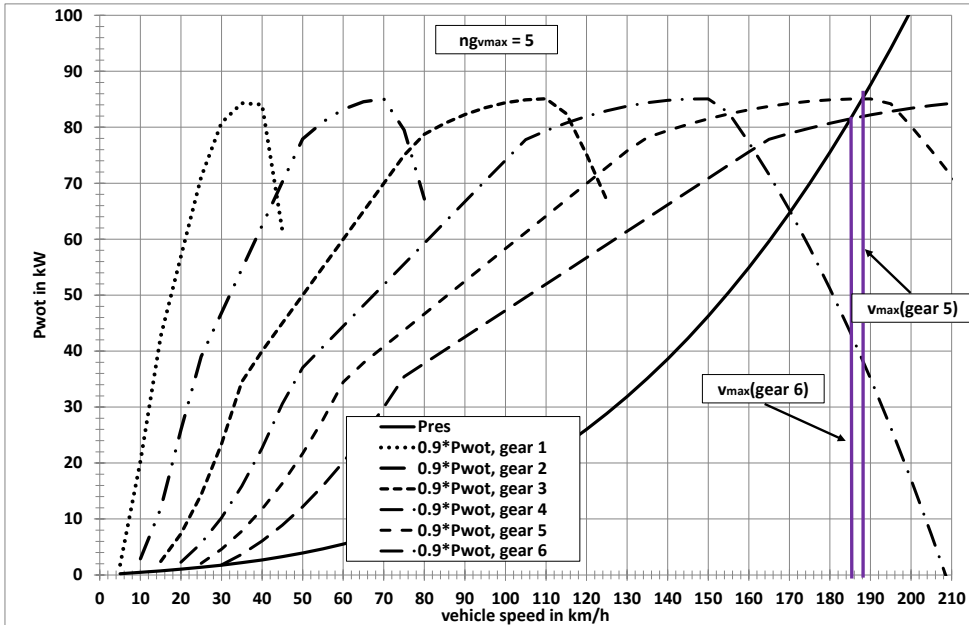

Figure A2/1b
 An example where $n_{g_{vmax}}$ is the 2nd highest gear



(j) Exclusion of a crawler gear

Gear 1 may be excluded at the request of the manufacturer if all of the following conditions are fulfilled:

- (1) The vehicle family is homologated to tow a trailer;
- (2) $(n/v)_1 \times (v_{max} / n_{95_high}) > 6.74$;

- (3) $(n/v)_2 \times (v_{\max} / n_{95_high}) > 3.85$;
- (4) The vehicle, having a mass m_t as defined in the equation below, is able to pull away from standstill within 4 seconds, on an uphill gradient of at least 12 per cent, on five separate occasions within a period of 5 minutes.

$$m_t = m_{r0} + 25 \text{ kg} + (MC - m_{r0} - 25 \text{ kg}) \times 0.28$$

(factor 0.28 in the above equation shall be used for category 2 vehicles with a gross vehicle mass up to 3.5 tons and shall be replaced by factor 0.15 in the case of category 1 vehicles),

where:

v_{\max} is the maximum vehicle speed as specified in paragraph 2. (i) of this annex. Only the v_{\max} value resulting from the intersection of the required road load power curve and the available power curve of the relevant gear shall be used for the conditions in (3) and (4) above. A v_{\max} value resulting from a limitation of the engine speed which prevents this intersection of curves shall not be used;

$(n/v)(ng_{v_{\max}})$ is the ratio obtained by dividing the engine speed n by the vehicle speed v for gear $ng_{v_{\max}}$, $\text{min}^{-1}/(\text{km/h})$;

m_{r0} is the mass in running order, kg;

MC is the technically permissible maximum laden mass of the combination (see paragraph 3.2.27. of this UN GTR), kg.

In this case, gear 1 shall not be used when driving the cycle on a chassis dynamometer and the gears shall be renumbered starting with the second gear as gear 1.

- (k) Definition of n_{\min_drive}

n_{\min_drive} is the minimum engine speed when the vehicle is in motion, min^{-1} ;

(1) For $n_{\text{gear}} = 1$, $n_{\min_drive} = n_{\text{idle}}$,

(2) For $n_{\text{gear}} = 2$,

(i) for transitions from first to second gear:

$$n_{\min_drive} = 1.15 \times n_{\text{idle}},$$

(ii) for decelerations to standstill:

$$n_{\min_drive} = n_{\text{idle}},$$

(iii) for all other driving conditions:

$$n_{\min_drive} = 0.9 \times n_{\text{idle}}.$$

(3) For $n_{\text{gear}} > 2$, n_{\min_drive} shall be determined by:

$$n_{\min_drive} = n_{\text{idle}} + 0.125 \times (n_{\text{rated}} - n_{\text{idle}}).$$

This value shall be referred to as $n_{\min_drive_set}$.

The final results for n_{\min_drive} shall be rounded according to paragraph 7. of this UN GTR to the nearest integer.

Values higher than $n_{\min_drive_set}$ may be used for $n_{gear} > 2$ if requested by the manufacturer. In this case, the manufacturer may specify one value for acceleration/constant speed phases ($n_{\min_drive_up}$) and a different value for deceleration phases ($n_{\min_drive_down}$).

Samples which have acceleration values ≥ -0.1389 m/s² shall belong to the acceleration/constant speed phases. This phase specification shall only be used for the determination of the initial gear according to paragraph 3.5. of this annex and shall not be applied to the requirements specified in paragraph 4. of this annex.

In addition, for an initial period of time (t_{start_phase}), the manufacturer may specify higher values ($n_{\min_drive_start}$ or $n_{\min_drive_up_start}$ and $n_{\min_drive_down_start}$) for the values n_{\min_drive} or $n_{\min_drive_up}$ and $n_{\min_drive_down}$ for $n_{gear} > 2$ than specified above.

The initial time period shall be specified by the manufacturer but shall not exceed the low speed phase of the cycle and shall end in a stop phase so that there is no change of n_{\min_drive} within a short trip.

All individually chosen n_{\min_drive} values shall be equal to or higher than $n_{\min_drive_set}$ but shall not exceed ($2 \times n_{\min_drive_set}$).

All individually chosen n_{\min_drive} values and t_{start_phase} shall be recorded.

Only $n_{\min_drive_set}$ shall be used as the lower limit for the full load power curve according to paragraph 2(h) above.

(l) TM, test mass of the vehicle, kg.

3. Calculations of required power, engine speeds, available power, and possible gear to be used

3.1. Calculation of required power

For each second j of the cycle trace, the power required to overcome driving resistance and to accelerate shall be calculated using the following equation:

$$P_{required,j} = \left(\frac{(f_0 \times v_j) + (f_1 \times v_j^2) + (f_2 \times v_j^3)}{3600} \right) + \frac{(kr \times a_j \times v_j \times TM)}{3600}$$

where:

$P_{required,j}$ is the required power at second j , kW;

a_j is the vehicle acceleration at second j , m/s², and is calculated as follows:

$$a_j = \frac{(v_{j+1} - v_j)}{3.6 \times (t_{j+1} - t_j)}$$

kr is a factor taking the inertial resistances of the drivetrain during acceleration into account and is set to 1.03.

3.2. Determination of engine speeds

For any $v_j < 1$ km/h, it shall be assumed that the vehicle is standing still and the engine speed shall be set to n_{idle} . The gear lever shall be placed in neutral with the clutch engaged except 1 second before beginning an acceleration from standstill where first gear shall be selected with the clutch disengaged.

For each $v_j \geq 1$ km/h of the cycle trace and each gear i , $i = 1$ to n_g , the engine speed, $n_{i,j}$, shall be calculated using the following equation:

$$n_{i,j} = (n/v)_i \times v_j$$

The calculation shall be performed with floating point numbers; the results shall not be rounded.

3.3. Selection of possible gears with respect to engine speed

The following gears may be selected for driving the speed trace at v_j :

- (a) All gears $i < n_{g_{vmax}}$ where $n_{min_drive} \leq n_{i,j} \leq n_{max1}$;
- (b) All gears $i \geq n_{g_{vmax}}$ where $n_{min_drive} \leq n_{i,j} \leq n_{max2}$;
- (c) Gear 1, if $n_{1,j} < n_{min_drive}$.

If $a_j < 0$ and $n_{i,j} \leq n_{idle}$, $n_{i,j}$ shall be set to n_{idle} and the clutch shall be disengaged.

If $a_j \geq 0$ and $n_{i,j} < \max(1.15 \times n_{idle}; \text{min. engine speed of the } P_{wot}(n) \text{ curve})$, $n_{i,j}$ shall be set to the maximum of $(1.15 \times n_{idle})$ or $((n/v)_i \times v_j)$, and the clutch shall be set to “undefined”.

“Undefined” covers any status of the clutch between disengaged and engaged, depending on the individual engine and transmission design. In such a case, the real engine speed may deviate from the calculated engine speed.

3.4. Calculation of available power

The available power for each possible gear i and each vehicle speed value of the cycle trace v_i shall be calculated using the following equation:

$$P_{available_i,j} = P_{wot}(n_{i,j}) \times (1 - (SM + ASM))$$

where:

- P_{rated} is the rated power, kW;
- P_{wot} is the power available at $n_{i,j}$ at full load condition from the full load power curve;
- SM is a safety margin accounting for the difference between the stationary full load condition power curve and the power available during transition conditions. SM shall be set to 10 per cent;
- ASM is an additional power safety margin which may be applied at the request of the manufacturer.

When requested, the manufacturer shall provide the ASM values (in per cent reduction of the wot power) together with data sets for $P_{wot}(n)$ as shown by the example in Table A2/1. Linear interpolation shall be used between consecutive data points. ASM is limited to 50 per cent.

The application of an ASM requires the approval of the responsible authority.

Table A2/1

| n | P_{wot} | SM per cent | ASM per cent | $P_{available}$ |
|------------|-----------|------------------|-------------------|-----------------|
| min^{-1} | kW | | | kW |
| 700 | 6.3 | 10.0 | 20.0 | 4.4 |
| 1000 | 15.7 | 10.0 | 20.0 | 11.0 |
| 1500 | 32.3 | 10.0 | 15.0 | 24.2 |

| n | P_{wot} | SM per cent | ASM per cent | $P_{available}$ |
|------------|-----------|------------------|-------------------|-----------------|
| min^{-1} | kW | | | kW |
| 1800 | 56.6 | 10.0 | 10.0 | 45.3 |
| 1900 | 59.7 | 10.0 | 5.0 | 50.8 |
| 2000 | 62.9 | 10.0 | 0.0 | 56.6 |
| 3000 | 94.3 | 10.0 | 0.0 | 84.9 |
| 4000 | 125.7 | 10.0 | 0.0 | 113.2 |
| 5000 | 157.2 | 10.0 | 0.0 | 141.5 |
| 5700 | 179.2 | 10.0 | 0.0 | 161.3 |
| 5800 | 180.1 | 10.0 | 0.0 | 162.1 |
| 6000 | 174.7 | 10.0 | 0.0 | 157.3 |
| 6200 | 169.0 | 10.0 | 0.0 | 152.1 |
| 6400 | 164.3 | 10.0 | 0.0 | 147.8 |
| 6600 | 156.4 | 10.0 | 0.0 | 140.8 |

3.5. Determination of possible gears to be used

The possible gears to be used shall be determined by the following conditions:

- (a) The conditions of paragraph 3.3. of this annex are fulfilled, and
- (b) For $n_{gear} > 2$, if $P_{available,i,j} \geq P_{required,j}$.

The initial gear to be used for each second j of the cycle trace is the highest final possible gear, i_{max} . When starting from standstill, only the first gear shall be used.

The lowest final possible gear is i_{min} .

4. Additional requirements for corrections and/or modifications of gear use

The initial gear selection shall be checked and modified in order to avoid too frequent gearshifts and to ensure driveability and practicality.

An acceleration phase is a time period of more than 2 seconds with a vehicle speed ≥ 1 km/h and with strictly monotonic increase of vehicle speed. A deceleration phase is a time period of more than 2 seconds with a vehicle speed ≥ 1 km/h and with strictly monotonic decrease of vehicle speed.

The end of an acceleration/deceleration phase is determined by the last time sample in which the vehicle speed is higher/lower than the vehicle speed of the previous time sample.

Corrections and/or modifications shall be made according to the following requirements:

- (a) If a one step higher gear ($n+1$) is required for only 1 second and the gears before and after are the same (n) or one of them is one step lower ($n - 1$), gear ($n + 1$) shall be corrected to gear n .

Examples:

Gear sequence $i - 1, i, i - 1$ shall be replaced by:

$i - 1, i - 1, i - 1$;

Gear sequence $i - 1, i, i - 2$ shall be replaced by:

$i - 1, i - 1, i - 2;$

Gear sequence $i - 2, i, i - 1$ shall be replaced by:

$i - 2, i - 1, i - 1.$

Gears used during accelerations or constant speed sections at vehicle speeds ≥ 1 km/h shall be used for a period of at least 2 seconds.

Examples:

Gear sequence 1, 2, 3, 3, 3, 3, 3 shall be replaced by:

1, 1, 2, 2, 3, 3, 3.

Gear sequence 1, 2, 3, 4, 5, 5, 6, 6, 6, 6 shall be replaced by:

1, 1, 2, 2, 3, 3, 4, 4, 5, 5, 6.

This requirement shall not be applied to downshifts during an acceleration phase or if the use of a gear for just one second follows immediately after such a downshift. In these cases, the downshifts shall be first corrected according to paragraph 4.(b) of this annex.

Example:

Gear sequence 4, 4, 3, 4, 5, 5, 5, where the first second determines the start of an acceleration phase, shall be replaced by:

4, 4, 4, 4, 5, 5, 5.

Gears shall not be skipped during acceleration phases.

However, an upshift by two gears is permitted at the transition from an acceleration phase to a constant speed phase if the duration of the constant speed phase exceeds 5 seconds.

- (b) If a downshift is required during an acceleration phase, the gear required during this downshift shall be noted (i_{DS}). The starting point of a correction procedure is defined by either the last previous second when i_{DS} was identified or by the starting point of the acceleration phase if all time samples before have gears $> i_{DS}$. The highest gear of the time samples before the downshift determines the reference gear i_{ref} for the downshift. A downshift where $i_{DS} = i_{ref} - 1$ is referred to as a one step downshift, a downshift where $i_{DS} = i_{ref} - 2$ is referred to as a two step downshift. The following check shall then be applied.

Working forward from the starting point of the correction procedure to the end of the acceleration phase, the latest occurrence of a 10 second window containing i_{DS} for either 2 or more consecutive seconds, or 2 or more individual seconds, shall be identified. The last usage of i_{DS} in this window defines the end point of the correction procedure. Between the start and end of the correction period, all requirements for gears greater than i_{DS} shall be corrected to a requirement of i_{DS} .

If one step downshifts as well as two step downshifts occur during an acceleration phase, two step downshifts shall be corrected before one step downshifts are corrected. In this case, the starting point of the correction procedure for the one step downshifts is the second immediately following the end of the correction period for the two step downshifts. If a two-step downshift occurs after a one step downshift,

it shall overrule the one step downshift in the time period before the two step downshift.

From the end of the correction period (in case of 10 second windows containing i_{DS} for either 2 or more consecutive seconds, or 2 or more individual seconds) or from the starting point of the correction procedure (in case that all 10 second windows contain i_{DS} only for one second or some 10 second windows contain no i_{DS} at all) to the end of the acceleration phase, if the downshift was a one-step downshift, all downshifts with a duration of only one second shall be removed. If the downshift was a two-step downshift, all requirements for gears greater than or equal to i_{DS} up to the latest occurrence of i_{DS} shall be corrected to $(i_{DS} + 1)$.

Examples are shown in Tables A2/2 to A2/6.

Table A2/2

| Time | j | j+1 | j+2 | j+3 | j+4 | j+5 | j+6 | j+7 | j+8 | j+9 | j+10 | j+11 | j+12 | j+13 | j+14 | j+15 | j+16 | j+17 | j+18 |
|--------------------|------------------------|-----|----------------------------------|---|-----|-----|-----|-----|--|-----|------|------|------|------|------|--|------|------|----------------------|
| | Start of accel. | | | | | | | | Down shift, $i_{DS} = 3$ | | | | | | | Down shift, $i_{DS} = 3$ | | | End of accel. |
| Initial gear use | 2 | 2 | 3 | 3 | 4 | 4 | 4 | 4 | 3 | 4 | 4 | 4 | 4 | 4 | 4 | 3 | 4 | 4 | 4 |
| | | | Start of correction check | | | | | | | | | | | | | | | | |
| | | | | $i_{ref} = 4$ | | | | | | | | | | | | | | | |
| | | | | First 10 second window for the correction check | | | | | | | | | | | | | | | |
| | | | | Latest 10 second window containing i_{DS} twice | | | | | | | | | | | | | | | |
| | | | | | | | | | | | | | | | | End of correction | | | |
| Correction Removal | | | | | 3 | 3 | 3 | 3 | | 3 | 3 | 3 | 3 | 3 | 3 | | | | |
| Final gear use | 2 | 2 | 3 | 3 | 3 | 3 | 3 | 3 | 3 | 3 | 3 | 3 | 3 | 3 | 3 | 3 | 4 | 4 | 4 |

Table A2/3

| Time | j | j+1 | j+2 | j+3 | j+4 | j+5 | j+6 | j+7 | j+8 | j+9 | j+10 | j+11 | j+12 | j+13 | j+14 | j+15 | j+16 | j+17 | j+18 |
|--------------------|------------------------|-----|----------------------------------|---|-----|-----|--|-----|-----|-----|------|------|------|------|------|------|------|--|----------------------|
| | Start of accel. | | | | | | Down shift, $i_{DS} = 3$ | | | | | | | | | | | Down shift, $i_{DS} = 3$ | End of accel. |
| Initial gear use | 2 | 2 | 3 | 3 | 4 | 4 | 3 | 4 | 4 | 4 | 4 | 4 | 4 | 4 | 4 | 4 | 4 | 3 | 4 |
| | | | Start of correction check | | | | | | | | | | | | | | | | |
| | | | | $i_{ref} = 4$ | | | | | | | | | | | | | | | |
| | | | | First 10 second window for the correction check | | | | | | | | | | | | | | | |
| | | | | Latest 10 second window containing i_{DS} twice | | | | | | | | | | | | | | | |
| | | | | | | | End of correction | | | | | | | | | | | | |
| Correction Removal | | | | | 3 | 3 | | | | | | | | | | | | | 4 |
| Final gear use | 2 | 2 | 3 | 3 | 3 | 3 | 3 | 4 | 4 | 4 | 4 | 4 | 4 | 4 | 4 | 4 | 4 | 4 | 4 |

Table A2/4

| Time | j | j+1 | j+2 | j+3 | j+4 | j+5 | j+6 | j+7 | j+8 | j+9 | j+10 | j+11 | j+12 | j+13 | j+14 | j+15 | j+16 | j+17 | j+18 | |
|------------------|---|-----|-----|--|-----|-----|-----|-----|-----|-----|--|------|------|------|--|------|------|------|----------------------|--|
| | Start of accel. | | | Down shift, $i_{DS} = 3$ | | | | | | | | | | | Down shift, $i_{DS} = 3$ | | | | End of accel. | |
| Initial gear use | 4 | 4 | 4 | 3 | 4 | 4 | 4 | 4 | 4 | 4 | 4 | 4 | 4 | 4 | 3 | 4 | 4 | 5 | 5 | |
| | Start of correction check | | | | | | | | | | | | | | | | | | | |
| | $i_{ref} = 4$ | | | | | | | | | | | | | | | | | | | |
| | First 10 second window for the correction check | | | | | | | | | | Last 10 second window for the correction check | | | | | | | | | |
| | no 10 second window containing i_{DS} twice | | | | | | | | | | | | | | | | | | | |
| Correction | | | | | | | | | | | | | | | | | | | | |
| Removal | | | | 4 | | | | | | | | | | | 4 | | | | | |
| Final gear use | 4 | 4 | 4 | 4 | 4 | 4 | 4 | 4 | 4 | 4 | 4 | 4 | 4 | 4 | 4 | 4 | 4 | 5 | 5 | |

Table A2/5

| Time | j | j+1 | j+2 | j+3 | j+4 | j+5 | j+6 | j+7 | j+8 | j+9 | j+10 | j+11 | j+12 | j+13 | j+14 | j+15 | j+16 | j+17 | j+18 | j+19 |
|------------------|--|-----|-----|---|-----|--|-----|-----|-----|-----|--|------|------|------|------|------|------|------|---|----------------------|
| | Start of accel. | | | Down-shift, $i_{DS1} = 5$ | | Down-shift by 2 steps, $i_{DS1} = 4$ | | | | | | | | | | | | | Down-shift by 1 step, $i_{DS2} = 5$ | End of accel. |
| Initial gear use | 6 | 6 | 6 | 5 | 5 | 4 | 4 | 4 | 4 | 4 | 5 | 6 | 6 | 6 | 6 | 6 | 6 | 6 | 5 | 5 |
| | Start of correction check for i_{DS1} | | | | | | | | | | Start of correction check for i_{DS2} | | | | | | | | | |
| | $i_{ref} = 6$ | | | | | | | | | | $i_{ref} = 6$ | | | | | | | | | |
| | Latest 10 second window containing i_{DS1} twice or more | | | | | | | | | | Latest 10 second window containing i_{DS2} twice or more | | | | | | | | | |
| | | | | End of correction for i_{DS1} | | | | | | | | | | | | | | | End of correction for i_{DS2} | |
| Correction | 4 | 4 | 4 | 4 | 4 | | | | | | 5 | 5 | 5 | 5 | 5 | 5 | 5 | 5 | 5 | |
| Removal | | | | | | | | | | | | | | | | | | | | |
| Final gear use | 4 | 4 | 4 | 4 | 4 | 4 | 4 | 4 | 4 | 4 | 5 | 5 | 5 | 5 | 5 | 5 | 5 | 5 | 5 | |

Table A2/6

| Time | j | j+1 | j+2 | j+3 | j+4 | j+5 | j+6 | j+7 | j+8 | j+9 | j+10 | j+11 | j+12 | j+13 | j+14 | j+15 | j+16 | j+17 | j+18 | |
|--------------------|--|---|-----|---|-----|-----|---|-----|---|---------------|--|------|------|---|------|------|------|------|----------------------|--|
| | Start of accel. | Down-shift, $i_{DS1} = 3$ | | | | | Down-shift, $i_{DS2} = 4$ | | | | | | | Down-shift, $i_{DS3} = 5$ | | | | | End of accel. | |
| Initial gear use | 4 | 3 | 3 | 4 | 5 | 5 | 4 | 5 | 5 | 6 | 6 | 6 | 6 | 5 | 5 | 6 | 6 | 6 | 6 | |
| | Start of correction check i_{DS1} | | | Start of correction check i_{DS2} | | | | | Start of correction check i_{DS3} | | | | | | | | | | | |
| | $i_{ref} = 4$ | | | $i_{ref} = 5$ | | | | | | $i_{ref} = 6$ | | | | | | | | | | |
| | Latest 10 second window containing i_{DS1} twice or more | | | | | | | | | | Latest 10 second window containing i_{DS3} twice or more | | | | | | | | | |
| | Latest 10 second window containing i_{DS2} twice or more | | | | | | | | | | Latest 10 second window containing i_{DS3} twice or more | | | | | | | | | |
| | End of correction i_{DS1} | | | | | | End of correction i_{DS2} | | | | | | | End of correction i_{DS3} | | | | | | |
| correction removal | 3 | | | | 4 | 4 | | | | 5 | 5 | 5 | 5 | | | | | | | |
| Final gear use | 3 | 3 | 3 | 4 | 4 | 4 | 4 | 5 | 5 | 5 | 5 | 5 | 5 | 5 | 5 | 6 | 6 | 6 | 6 | |

This correction shall not be performed for gear 1.

After the application of paragraph 4.(b) of this annex, a downshift by more than one gear could occur at the transition from a deceleration or constant speed phase to an acceleration phase.

In this case, the gear for the last sample of the deceleration or constant speed phase shall be replaced by gear 0 and the clutch shall be

disengaged. If the “suppress gear 0 during downshifts” option according to paragraph 4.(f) of this annex is chosen, the gear of the following second (first second of the acceleration phase) shall be used instead of gear 0.

This modification shall be applied immediately after the modifications according to paragraph 4.(d) of this annex.

- (c) The modification check described in paragraph 4.(c) of this annex shall be applied to the complete cycle trace twice prior to the application of paragraphs 4.(d) to 4.(f) of this annex.

If gear i is used for a time sequence of 1 to 5 seconds and the gear prior to this sequence is one step lower and the gear after this sequence is one or two steps lower than within this sequence or the gear prior to this sequence is two steps lower and the gear after this sequence is one step lower than within the sequence, the gear for the sequence shall be corrected to the maximum of the gears before and after the sequence.

Examples:

- (i) Gear sequence $i - 1, i, i - 1$ shall be replaced by:
 $i - 1, i - 1, i - 1$;
 Gear sequence $i - 1, i, i - 2$ shall be replaced by:
 $i - 1, i - 1, i - 2$;
 Gear sequence $i - 2, i, i - 1$ shall be replaced by:
 $i - 2, i - 1, i - 1$.
- (ii) Gear sequence $i - 1, i, i, i - 1$ shall be replaced by:
 $i - 1, i - 1, i - 1, i - 1$;
 Gear sequence $i - 1, i, i, i - 2$ shall be replaced by:
 $i - 1, i - 1, i - 1, i - 2$;
 Gear sequence $i - 2, i, i, i - 1$ shall be replaced by:
 $i - 2, i - 1, i - 1, i - 1$.
- (iii) Gear sequence $i - 1, i, i, i, i - 1$ shall be replaced by:
 $i - 1, i - 1, i - 1, i - 1, i - 1$;
 Gear sequence $i - 1, i, i, i, i - 2$ shall be replaced by:
 $i - 1, i - 1, i - 1, i - 1, i - 2$;
 Gear sequence $i - 2, i, i, i, i - 1$ shall be replaced by:
 $i - 2, i - 1, i - 1, i - 1, i - 1$.
- (iv) Gear sequence $i - 1, i, i, i, i, i - 1$ shall be replaced by:
 $i - 1, i - 1, i - 1, i - 1, i - 1, i - 1$;
 Gear sequence $i - 1, i, i, i, i, i - 2$ shall be replaced by:
 $i - 1, i - 1, i - 1, i - 1, i - 1, i - 2$;
 Gear sequence $i - 2, i, i, i, i, i - 1$ shall be replaced by:

$i - 2, i - 1, i - 1, i - 1, i - 1, i - 1$.

- (v) Gear sequence $i - 1, i, i, i, i, i - 1$ shall be replaced by:

$i - 1, i - 1, i - 1, i - 1, i - 1, i - 1, i - 1$;

Gear sequence $i - 1, i, i, i, i, i - 2$ shall be replaced by:

$i - 1, i - 1, i - 1, i - 1, i - 1, i - 1, i - 2$;

Gear sequence $i - 2, i, i, i, i, i - 1$ shall be replaced by:

$i - 2, i - 1, i - 1, i - 1, i - 1, i - 1, i - 1$.

In all cases (i) to (v), $i - 1 \geq i_{\min}$ shall be fulfilled.

- (d) No upshift to a higher gear at the transition from an acceleration or constant speed phase to a deceleration phase shall be performed if one of the gears in the first two seconds following the end of the deceleration phase is lower than the upshifted gear or is gear 0.

Example:

If $v_i \leq v_{i+1}$ and $v_{i+2} < v_{i+1}$ and gear $i = 4$ and gear $(i + 1 = 5)$ and gear $(i + 2 = 5)$, then gear $(i + 1)$ and gear $(i + 2)$ shall be set to 4 if the gear for the phase following the deceleration phase is gear 4 or lower. For all following cycle trace points with gear 5 within the deceleration phase, the gear shall also be set to 4. If the gear following the deceleration phase is gear 5, an upshift shall be performed.

If there is an upshift during the transition and the initial deceleration phase by 2 gears, an upshift by 1 gear shall be performed instead. In this case, no further modifications shall be performed in the following gear use checks.

No upshift to a higher gear shall be performed within a deceleration phase.

- (e) During a deceleration phase, gears with $n_{\text{gear}} > 2$ shall be used as long as the engine speed does not drop below $n_{\text{min_drive}}$.

Gear 2 shall be used during a deceleration phase within a short trip of the cycle (not at the end of a short trip) as long as the engine speed does not drop below $(0.9 \times n_{\text{idle}})$.

If the engine speed drops below n_{idle} , the clutch shall be disengaged.

If the deceleration phase is the last part of a short trip shortly before a stop phase, the second gear shall be used as long as the engine speed does not drop below n_{idle} .

- (f) If during a deceleration phase the duration of a gear sequence between two gear sequences of 3 seconds or more is only 1 second, it shall be replaced by gear 0 and the clutch shall be disengaged.

If during a deceleration phase the duration of a gear sequence between two gear sequences of 3 seconds or more is 2 seconds, it shall be replaced by gear 0 for the 1st second and for the 2nd second with the gear that follows after the 2 second period. The clutch shall be disengaged for the 1st second.

Example: A gear sequence 5, 4, 4, 2 shall be replaced by 5, 0, 2, 2.

This requirement shall only be applied if the gear that follows after the 2 second period is > 0 .

If several gear sequences with durations of 1 or 2 seconds follow one another, corrections shall be performed as follows:

A gear sequence $i, i, i, i - 1, i - 1, i - 2$ or $i, i, i, i - 1, i - 2, i - 2$ shall be changed to $i, i, i, 0, i - 2, i - 2$.

A gear sequence such as $i, i, i, i - 1, i - 2, i - 3$ or $i, i, i, i - 2, i - 2, i - 3$ or other possible combinations shall be changed to $i, i, i, 0, i - 3, i - 3$.

This change shall also be applied to gear sequences where the acceleration is ≥ 0 for the first 2 seconds and < 0 for the 3rd second or where the acceleration is ≥ 0 for the last 2 seconds.

For extreme transmission designs, it is possible that gear sequences with durations of 1 or 2 seconds following one another may last up to 7 seconds. In such cases, the correction above shall be complemented by the following correction requirements in a second step.

A gear sequence $j, 0, i, i, i - 1, k$ with $j > (i + 1)$ and $k \leq (i - 1)$ shall be changed to $j, 0, i - 1, i - 1, i - 1, k$, if gear $(i - 1)$ is one or two steps below i_{\max} for second 3 of this sequence (one after gear 0).

If gear $(i - 1)$ is more than two steps below i_{\max} for second 3 of this sequence, a gear sequence $j, 0, i, i, i - 1, k$ with $j > (i + 1)$ and $k \leq (i - 1)$ shall be changed to $j, 0, 0, k, k, k$.

A gear sequence $j, 0, i, i, i - 2, k$ with $j > (i + 1)$ and $k \leq (i - 2)$ shall be changed to $j, 0, i - 2, i - 2, i - 2, k$, if gear $(i - 2)$ is one or two steps below i_{\max} for second 3 of this sequence (one after gear 0).

If gear $(i - 2)$ is more than two steps below i_{\max} for second 3 of this sequence, a gear sequence $j, 0, i, i, i - 2, k$ with $j > (i + 1)$ and $k \leq (i - 2)$ shall be changed to $j, 0, 0, k, k, k$.

In all cases specified above in this sub-paragraph (paragraph 4.(f) of this annex), the clutch disengagement (gear 0) for 1 second is used in order to avoid too high engine speeds for this second. If this is not an issue and, if requested by the manufacturer, it is allowed to use the lower gear of the following second directly instead of gear 0 for downshifts of up to 3 steps. The use of this option shall be recorded.

If the deceleration phase is the last part of a short trip shortly before a stop phase and the last gear > 0 before the stop phase is used only for a period of up to 2 seconds, gear 0 shall be used instead and the gear lever shall be placed in neutral and the clutch shall be engaged.

Examples: A gear sequence of 4, 0, 2, 2, 0 for the last 5 seconds before a stop phase shall be replaced by 4, 0, 0, 0, 0. A gear sequence of 4, 3, 3, 0 for the last 4 seconds before a stop phase shall be replaced by 4, 0, 0, 0.

A downshift to first gear is not permitted during those deceleration phases. If such a downshift would be necessary in the last part of a short trip just before a stop phase, since the engine speed would drop below n_{idle} in 2nd gear, gear 0 shall be used instead and the gear lever shall be placed in neutral and the clutch shall be engaged.

If the first gear is required in the section of a short trip prior to the deceleration to stop, this gear should be used until the first sample of the deceleration phase. For the rest of the deceleration phase, gear 0 shall be used and the gear lever shall be placed in neutral and the clutch shall be engaged.

5. Paragraphs 4.(a) to 4.(f) inclusive of this annex shall be applied sequentially, scanning the complete cycle trace in each case. Since modifications to paragraphs 4.(a) to 4.(f) inclusive of this annex may create new gear use sequences, these new gear sequences shall be checked three times and modified if necessary.

In order to enable the assessment of the correctness of the calculation, the average gear for $v \geq 1$ km/h, rounded according to paragraph 7. of this UN GTR to four places of decimal, shall be calculated and recorded.

Annex 3

Reference fuels

1. As there are regional differences in the market specifications of fuels, regionally different reference fuels need to be recognised. Example reference fuels are however required in this UN GTR for the calculation of hydrocarbon emissions and fuel consumption. Reference fuels are therefore given as examples for such illustrative purposes.
2. It is recommended that Contracting Parties select their reference fuels from this annex and bring any regionally agreed amendments or alternatives into this UN GTR by amendment. This does not however limit the right of Contracting Parties to define individual reference fuels to reflect local market fuel specifications.
3. Liquid fuels for positive ignition engines
 - 3.1. Gasoline/Petrol (nominal 90 RON, E0)

Table A3/1
Gasoline/petrol (nominal 90 RON, E0)

| Fuel property or substance name | Unit | Standard | | Test method |
|---------------------------------|-------------------|--------------------|-----------|--|
| | | Minimum | Maximum | |
| Research octane number, RON | | 90 | 92 | JIS K2280 |
| Motor octane number, MON | | 80 | 82 | JIS K2280 |
| Density | g/cm ³ | 0.720 | 0.734 | JIS K2249 |
| Vapour pressure | kPa | 56 | 60 | JIS K2258 |
| Distillation: | | | | |
| — 10 % distillation temperature | K (°C) | 318 (45) | 328 (55) | JIS K2254 |
| — 50 % distillation temperature | K (°C) | 363 (90) | 373 (100) | JIS K2254 |
| — 90 % distillation temperature | K (°C) | 413 (140) | 443 (170) | JIS K2254 |
| — final boiling point | K (°C) | | 488 (215) | JIS K2254 |
| — olefins | % v/v | 15 | 25 | JIS K2536-1 JIS K2536-2 |
| — aromatics | % v/v | 20 | 45 | JIS K2536-1 JIS K2536-2 JIS K2536-3 |
| — benzene | % v/v | | 1.0 | JIS K2536-2 JIS K2536-3 JIS K2536-4 |
| Oxygen content | | not to be detected | | JIS K2536-2 JIS K2536-4 JIS K2536-6 |
| Existent gum | mg/100ml | | 5 | JIS K2261 |
| Sulphur content | wt ppm | | 10 | JIS K2541-1 JIS K2541-2 JIS K2541-6 JIS K2541-7 |
| Lead content | | not to be detected | | JIS K2255 |
| Ethanol | | not to be detected | | JIS K2536-2 JIS K2536-4 JIS K2536-6 |
| Methanol | | not to be detected | | JIS K2536-2 JIS K2536-4 JIS K2536-5 JIS K2536-6 |
| MTBE | | not to be detected | | JIS K2536-2 JIS K2536-4 JIS K2536-5 JIS K2536-6 |
| Kerosene | | not to be detected | | JIS K2536-2 JIS K2536-4 |

3.2. Gasoline/petrol (nominal 91 RON, E0)

Table A3/2

Gasoline/petrol (nominal 91 RON, E0)

| Fuel property or substance name | Unit | | Standard | | Test method |
|---------------------------------|----------|--------|----------|---------|---|
| | | | Minimum | Maximum | |
| Research octane number, RON | | | 91 | 94 | KS M 2039 |
| Vapour pressure | kPa | Summer | 44 | 60 | KS M ISO 3007 |
| | | Winter | 44 | 96 | |
| Distillation: | | | | | |
| — 10 % distillation temperature | °C | | - | 70 | ASTM D86 |
| — 50 % distillation temperature | °C | | - | 125 | ASTM D86 |
| — 90 % distillation temperature | °C | | - | 170 | ASTM D86 |
| — final boiling point | °C | | - | 225 | ASTM D86 |
| Residue | % v/v | | - | 2.0 | ASTM D86 |
| Water content | % v/v | | - | 0.01 | KS M 2115 |
| — olefins ^a | % v/v | | - | 16(19) | KS M 2085, ASTM D6296, D6293, D6839 |
| — aromatics ^a | % v/v | | - | 24 (21) | KS M 2407, ASTM D3606, D5580, D6293, D6839, PIONA |
| — benzene | % v/v | | - | 0.7 | KS M 2407, ASTM D3606, D5580, D6293, D6839, PIONA |
| Oxygen content | wt % | | - | 2.3 | KS M 2408, ASTM D4815, D6839 |
| Unwashed gum | mg/100ml | | - | 5 | KS M 2041 |
| Sulphur content | wt ppm | | - | 10 | KS M 2027, ASTM D5453 |
| Lead content | mg/l | | - | 13 | KS M 2402, ASTM D3237 |
| Phosphorus content | mg/l | | - | 1.3 | KS M 2403, ASTM D3231 |
| Methanol | wt % | | - | 0.01 | KS M 2408 |
| Oxidation stability | min | | 480 | - | KS M 2043 |
| Copper corrosion | 50°C, 3h | | - | 1 | KS M 2018 |
| Colour | Yellow | | - | - | Sensory test |

^a The standard in brackets may apply for olefins. In this case, the value in brackets for aromatics shall apply.

3.3. Gasoline/petrol (nominal 100 RON, E0)

Table A3/3

Gasoline/petrol (nominal 100 RON, E0)

| Fuel Property or Substance Name | Unit | Standard | | Test method |
|---------------------------------|-------------------|--------------------|-----------|--|
| | | Minimum | Maximum | |
| Research octane number, RON | | 99 | 101 | JIS K2280 |
| Motor octane number, MON | | 86 | 88 | JIS K2280 |
| Density | g/cm ³ | 0.740 | 0.754 | JIS K2249 |
| Vapour pressure | kPa | 56 | 60 | JIS K2258 |
| Distillation: | | | | |
| — 10 % distillation temperature | K (°C) | 318 (45) | 328 (55) | JIS K2254 |
| — 50 % distillation temperature | K (°C) | 363 (90) | 373 (100) | JIS K2254 |
| — 90 % distillation temperature | K (°C) | 413 (140) | 443 (170) | JIS K2254 |
| — final boiling point | K (°C) | | 488 (215) | JIS K2254 |
| — olefins | % v/v | 15 | 25 | JIS K2536-1 JIS K2536-2 |
| — aromatics | % v/v | 20 | 45 | JIS K2536-1 JIS K2536-2 JIS K2536-3 |
| — benzene | % v/v | | 1.0 | JIS K2536-2 JIS K2536-3 JIS K2536-4 |
| Oxygen content | | not to be detected | | JIS K2536-2 JIS K2536-4 JIS K2536-6 |
| Existent gum | mg/100ml | | 5 | JIS K2261 |
| Sulphur content | wt ppm | | 10 | JIS K2541-1 JIS K2541-2 JIS K2541-6 JIS K2541-7 |
| Lead content | | not to be detected | | JIS K2255 |
| Ethanol | | not to be detected | | JIS K2536-2 JIS K2536-4 JIS K2536-6 |
| Methanol | | not to be detected | | JIS K2536-2 JIS K2536-4 JIS K2536-5 JIS K2536-6 |
| MTBE | | not to be detected | | JIS K2536-2 JIS K2536-4 JIS K2536-5 JIS K2536-6 |
| Kerosene | | not to be detected | | JIS K2536-2 JIS K2536-4 |

3.4. Gasoline/petrol (nominal 94 RON, E0)

Table A3/4

Gasoline/petrol (nominal 94 RON, E0)

| Fuel Property or Substance Name | Unit | | Standard | | Test method |
|---------------------------------|----------|--------|----------|---------|---|
| | | | Minimum | Maximum | |
| Research octane number, RON | | | 94 | - | KS M 2039 |
| Vapour pressure | kPa | Summer | 44 | 60 | KS M ISO 3007 |
| | | Winter | 44 | 96 | |
| Distillation: | | | | | |
| — 10 % distillation temperature | °C | | - | 70 | ASTM D86 |
| — 50 % distillation temperature | °C | | - | 125 | ASTM D86 |
| — 90 % distillation temperature | °C | | - | 170 | ASTM D86 |
| — final boiling point | °C | | - | 225 | ASTM D86 |
| Residue | % v/v | | | 2.0 | ASTM D86 |
| Water content | % v/v | | | 0.01 | KS M 2115 |
| — olefins ^a | % v/v | | | 16 (19) | KS M 2085, ASTM D6296, D6293, D6839 |
| — aromatics ^a | % v/v | | | 24 (21) | KS M 2407, ASTM D3606, D5580, D6293, D6839, PIONA |
| — benzene | % v/v | | | 0.7 | KS M 2407, ASTM D3606, D5580, D6293, D6839, PIONA |
| Oxygen content | wt % | | | 2.3 | KS M 2408, ASTM D4815, D6839 |
| Unwashed gum | mg/100ml | | | 5 | KS M 2041 |
| Sulphur content | wt ppm | | | 10 | KS M 2027, ASTM D5453 |
| Lead content | mg/L | | | 13 | KS M 2402, ASTM D3237 |
| Phosphorus content | mg/L | | | 1.3 | KS M 2403, ASTM D3231 |
| Methanol | wt % | | | 0.01 | KS M 2408 |
| Oxidation stability | min | | 480 | - | KS M 2043 |
| Copper corrosion | 50°C, 3h | | | 1 | KS M 2018 |
| Colour | Green | | - | - | Sensory Test |

^a The standard in brackets may apply for olefins. In this case, the value in brackets for aromatics shall apply.

3.5. Gasoline/petrol (nominal 95 RON, E5)

Table A3/5

Gasoline/petrol (nominal 95 RON, E5)

| Parameter | Unit | Limits ^a | | Test method |
|---------------------------------|-------------------|---------------------|---------|------------------------------|
| | | Minimum | Maximum | |
| Research octane number, RON | | 95.0 | | EN 25164 EN ISO 5164 |
| Motor octane number, MON | | 85.0 | | EN 25163 EN ISO 5163 |
| Density at 15 °C | kg/m ³ | 743 | 756 | EN ISO 3675 EN ISO 12185 |
| Vapour pressure | kPa | 56.0 | 60.0 | EN ISO 13016-1 (DVPE) |
| Water content | % v/v | | 0.015 | ASTM E 1064 |
| Distillation: | | | | |
| — evaporated at 70 °C | % v/v | 24.0 | 44.0 | EN-ISO 3405 |
| — evaporated at 100 °C | % v/v | 48.0 | 60.0 | EN-ISO 3405 |
| — evaporated at 150 °C | % v/v | 82.0 | 90.0 | EN-ISO 3405 |
| — final boiling point | °C | 190 | 210 | EN-ISO 3405 |
| Residue | % v/v | | 2.0 | EN-ISO 3405 |
| Hydrocarbon analysis: | | | | |
| — olefins | % v/v | 3.0 | 13.0 | ASTM D 1319 |
| — aromatics | % v/v | 29.0 | 35.0 | ASTM D 1319 |
| — benzene | % v/v | | 1.0 | EN 12177 |
| — saturates | % v/v | To be recorded | | ASTM 1319 |
| Carbon/hydrogen ratio | | To be recorded | | |
| Carbon/oxygen ratio | | To be recorded | | |
| Induction period ^b | minutes | 480 | | EN-ISO 7536 |
| Oxygen content ^c | % m/m | To be recorded | | EN 1601 |
| Existent gum | mg/ml | | 0.04 | EN-ISO 6246 |
| Sulphur content ^d | mg/kg | | 10 | EN ISO 20846 EN ISO 20884 |
| Copper corrosion | | | Class 1 | EN-ISO 2160 |
| Lead content | mg/l | | 5 | EN 237 |
| Phosphorus content ^e | mg/l | | 1.3 | ASTM D 3231 |
| Ethanol ^c | % v/v | 4.7 | 5.3 | EN 1601 EN 13132 |

^a The values quoted in the specifications are 'true values'. In establishing of their limit values the terms of ISO 4259 "Petroleum products — Determination and application of precision data in relation to methods of test" have been applied and in fixing a minimum value, a minimum difference of 2R above zero has been taken into account; in fixing a maximum and minimum value, the minimum difference is 4R (R = reproducibility). Notwithstanding this measure, which is necessary for technical reasons, the manufacturer of fuels shall nevertheless aim at a zero value where the stipulated maximum value is 2R and at the mean value in the case of quotations of maximum and minimum limits. Should it be necessary to clarify whether a fuel meets the requirements of the specifications, the terms of ISO 4259 shall be applied.

^b The fuel may contain oxidation inhibitors and metal deactivators normally used to stabilise refinery gasoline streams, but detergent/dispersive additives and solvent oils shall not be added.

^c Ethanol meeting the specification of EN 15376 is the only oxygenate that shall be intentionally added to the reference fuel.

^d The actual sulphur content of the fuel used for the Type 1 test shall be recorded.

^e There shall be no intentional addition of compounds containing phosphorus, iron, manganese, or lead to this reference fuel.

3.6. Gasoline/petrol (nominal 95 RON, E10)

Table A3/6

Gasoline/petrol (nominal 95 RON, E10)

| Parameter | Unit | Limits ^a | | Test method ^b |
|--|-------------------|---------------------|----------------|------------------------------|
| | | Minimum | Maximum | |
| Research octane number, RON ^c | | 95.0 | 98.0 | EN ISO 5164 |
| Motor octane number, MON ^c | | 85.0 | 89.0 | EN ISO 5163 |
| Density at 15 °C | kg/m ³ | 743.0 | 756.0 | EN ISO 12185 |
| Vapour pressure | kPa | 56.0 | 60.0 | EN 13016-1 |
| Water content | % v/v | | 0.05 | EN 12937 |
| Appearance at -7 °C | | clear and bright | | |
| Distillation: | | | | |
| — evaporated at 70 °C | % v/v | 34.0 | 46.0 | EN-ISO 3405 |
| — evaporated at 100 °C | % v/v | 54.0 | 62.0 | EN-ISO 3405 |
| — evaporated at 150 °C | % v/v | 86.0 | 94.0 | EN-ISO 3405 |
| — final boiling point | °C | 170 | 195 | EN-ISO 3405 |
| Residue | % v/v | | 2.0 | EN-ISO 3405 |
| Hydrocarbon analysis: | | | | |
| — olefins | % v/v | 6.0 | 13.0 | EN 22854 |
| — aromatics | % v/v | 25.0 | 32.0 | EN 22854 |
| — benzene | % v/v | | 1.00 | EN 22854 EN 238 |
| — saturates | % v/v | | To be recorded | EN 22854 |
| Carbon/hydrogen ratio | | | To be recorded | |
| Carbon/oxygen ratio | | | To be recorded | |
| Induction period ^d | minutes | 480 | | EN-ISO 7536 |
| Oxygen content ^e | % m/m | 3.3 | 3.7 | EN 22854 |
| Solvent washed gum (Existent gum content) | mg/100ml | | 4 | EN-ISO 6246 |
| Sulphur content ^f | mg/kg | | 10 | EN ISO 20846 EN ISO 20884 |
| Copper corrosion | | | Class 1 | EN-ISO 2160 |
| Lead content | mg/l | | 5 | EN 237 |
| Phosphorus content ^g | mg/l | | 1.3 | ASTM D 3231 |
| Ethanol ^e | % v/v | 9.0 | 10.0 | EN 22854 |

^a The values quoted in the specifications are 'true values'. In establishing of their limit values the terms of ISO 4259 "Petroleum products - Determination and application of precision data in relation to methods of test" have been applied and in fixing a minimum value, a minimum difference of 2R above zero has been taken into account; in fixing a maximum and minimum value, the minimum difference is 4R (R = reproducibility).

Notwithstanding this measure, which is necessary for technical reasons, the manufacturer of fuels shall nevertheless aim at a zero value where the stipulated maximum value is 2R and at the mean value in the case of quotations of maximum and minimum limits. Should it be necessary to clarify whether a fuel meets the requirements of the specifications, the terms of ISO 4259 shall be applied.

^b Equivalent EN/ISO methods will be adopted when issued for properties listed above.

^c A correction factor of 0.2 for MON and RON shall be subtracted for the calculation of the final result in accordance with EN 228:2008.

^d The fuel may contain oxidation inhibitors and metal deactivators normally used to stabilise refinery gasoline streams, but detergent/dispersive additives and solvent oils shall not be added.

^e Ethanol is the only oxygenate that shall be intentionally added to the reference fuel. The Ethanol used shall conform to EN 15376.

^f The actual sulphur content of the fuel used for the Type 1 test shall be recorded.

^g There shall be no intentional addition of compounds containing phosphorus, iron, manganese, or lead to this reference fuel.

3.7. Ethanol (nominal 95 RON, E85)

Table A3/7

Ethanol (nominal 95 RON, E85)

| Parameter | Unit | Limits ^a | | Test method ^b |
|---|-------------------|--|----------|---------------------------------|
| | | Minimum | Maximum | |
| Research octane number, RON | | 95 | | EN ISO 5164 |
| Motor octane number, MON | | 85 | | EN ISO 5163 |
| Density at 15 °C | kg/m ³ | To be recorded | | ISO 3675 |
| Vapour pressure | kPa | 40 | 60 | EN ISO 13016-1 (DVPE) |
| Sulphur content ^{c, d} | mg/kg | | 10 | EN ISO 20846 EN ISO 20884 |
| Oxidation stability | minutes | 360 | | EN ISO 7536 |
| Existent gum content (solvent washed) | mg/100ml | | 5 | EN-ISO 6246 |
| Appearance: This shall be determined at ambient temperature or 15 °C whichever is higher. | | Clear and bright, visibly free of suspended or precipitated contaminants | | Visual inspection |
| Ethanol and higher alcohols ^g | % v/v | 83 | 85 | EN 1601 EN 13132 EN 14517 |
| Higher alcohols (C3-C8) | % v/v | | 2 | |
| Methanol | % v/v | | 0.5 | |
| Petrol ^e | % v/v | Balance | | EN 228 |
| Phosphorus | mg/l | 0.3 ^f | | ASTM D 3231 |
| Water content | % v/v | | 0.3 | ASTM E 1064 |
| Inorganic chloride content | mg/l | | 1 | ISO 6227 |
| pHe | | 6.5 | 9 | ASTM D 6423 |
| Copper strip corrosion (3h at 50 °C) | Rating | Class 1 | | EN ISO 2160 |
| Acidity, (as acetic acid CH ₃ COOH) | % (m/m) (mg/l) | | 0.005-40 | ASTM D 1613 |
| Carbon/hydrogen ratio | | Record | | |
| Carbon/oxygen ratio | | Record | | |

^a The values quoted in the specifications are 'true values'. In establishing of their limit values the terms of ISO 4259 "Petroleum products — Determination and application of precision data in relation to methods of test" have been applied and in fixing a minimum value, a minimum difference of 2R above zero has been taken into account; in fixing a maximum and minimum value, the minimum difference is 4R (R = reproducibility). Notwithstanding this measure, which is necessary for technical reasons, the manufacturer of fuels shall nevertheless aim at a zero value where the stipulated maximum value is 2R and at the mean value in the case of quotations of maximum and minimum limits. Should it be necessary to clarify whether a fuel meets the requirements of the specifications, the terms of ISO 4259 shall be applied.

^b In cases of dispute, the procedures for resolving the dispute and interpretation of the results based on test method precision, described in EN ISO 4259 shall be used.

^c In cases of national dispute concerning sulphur content, either EN ISO 20846 or EN ISO 20884 shall be called up (similar to the reference in the national Annex of EN 228).

^d The actual sulphur content of the fuel used for the Type 1 test shall be recorded.

^e The unleaded petrol content can be determined as 100 minus the sum of the percentage content of water and alcohols.

^f There shall be no intentional addition of compounds containing phosphorus, iron, manganese, or lead to this reference fuel.

^g Ethanol to meet specification of EN 15376 is the only oxygenate that shall be intentionally added to this reference fuel.

4. Gaseous fuels for positive ignition engines

4.1. LPG (A and B)

Table A3/8

LPG (A and B)

| <i>Parameter</i> | <i>Unit</i> | <i>Fuel E1</i> | <i>Fuel E2</i> | <i>Fuel J</i> | <i>Fuel K</i> | <i>Test method</i> |
|-------------------------------|-------------------|----------------|----------------|-------------------|--|--|
| Composition: | | | | | | ISO 7941 |
| C3-content | % vol | 30 ±2 | 85 ±2 | | Winter: min. 15, max. 35 Summer: max. 10 | KS M ISO 7941 |
| Propane and propylene content | % mole | | | Min 20, max 30 | | JIS K2240 |
| C4-content | % vol | Balance | | | Winter: min.60, Summer: min. 85 | KS M ISO 7941 |
| Butane and butylene content | | | | Min 70, max 80 | | JIS K2240 |
| Butadiene | | | | | max. 0.5 | KS M ISO 7941 |
| < C3, > C4 | % vol | Max. 2 | Max. 2 | | | |
| Olefins | % vol | Max. 12 | Max. 15 | | | |
| Evaporation residue | mg/kg | Max. 50 | Max. 50 | | | EN 15470 |
| Evaporation residue (100ml) | ml | - | | | 0.05 | ASTM D2158 |
| Water at 0 °C | | Free | | | | EN 15469 |
| Total sulphur content | mg/kg | Max. 10 | Max 10 | | | ASTM 6667 |
| | | | | | Max 40 | KS M 2150, ASTM D4486, ASTM D5504 |
| Hydrogen sulphide | | None | None | | | ISO 8819 |
| Copper strip corrosion | rating | Class 1 | Class 1 | | | ISO 6251 ^a |
| Copper corrosion | 40 °C, 1h | - | | | 1 | KS M ISO 6251 |
| Odour | | Characteristic | | | | |
| Motor octane number | | Min. 89 | Min. 89 | | | EN 589 Annex B |
| Vapour pressure (40 °C) | MPa | - | 1.27 | | | KS M ISO 4256 KS M ISO 8973 |
| Density (15 °C) | kg/m ³ | 500 | | | 620 | KS M 2150, KS M ISO 3993 KS M ISO 8973 |

^a This method may not accurately determine the presence of corrosive materials if the sample contains corrosion inhibitors or other chemicals which diminish the corrosivity of the sample to the copper strip. Therefore, the addition of such compounds for the sole purpose of biasing the test method is prohibited.

4.2. NG/biomethane

4.2.1. "G20" "High Gas" (nominal 100 per cent Methane)

Table A3/9

"G20" "High Gas" (nominal 100 per cent methane)

| Characteristics | Units | Basis | Limits | | Test method |
|----------------------|--------------------|-------|---------|---------|-------------|
| | | | Minimum | Maximum | |
| Composition: | | | | | |
| Methane | % mole | 100 | 99 | 100 | ISO 6974 |
| Balance ^a | % mole | — | — | 1 | ISO 6974 |
| N ₂ | % mole | | | | ISO 6974 |
| Sulphur content | mg/m ^{3b} | — | — | 10 | ISO 6326-5 |
| Wobbe Index (net) | MJ/m ^{3c} | 48.2 | 47.2 | 49.2 | |

^a Inerts (different from N₂) + C₂ + C₂+

^b Value to be determined at 293.15 K (20 °C) and 101.325 kPa.

^c Value to be determined at 273.15 K (0 °C) and 101.325 kPa.

4.2.2. "K-Gas" (nominal 88 per cent Methane)

Table A3/10

"K-Gas" (nominal 88 per cent methane)

| Characteristics | Units | Limits | | Test method |
|---|-------|---------|---------|---|
| | | Minimum | Maximum | |
| Methane | % v/v | 88.0 | - | KS M ISO 6974, ASTM D1946, ASTM D1945-81, JIS K 0114 |
| Ethane | % v/v | - | 7.0 | KS M ISO 6974, ASTM D1946, ASTM D1945-81, JIS K 0114 |
| C ₃ + hydrocarbon | % v/v | - | 5.0 | KS M ISO 6974, ASTM D1946, ASTM D1945-81, JIS K 0114 |
| C ₆ + hydrocarbon | % v/v | - | 0.2 | KS M ISO 6974, ASTM D1946, ASTM D1945-81, JIS K 0114 |
| Sulphur content | ppm | - | 40 | KS M ISO 6326-1, KS M ISO 19739, ASTM D5504, JIS K 0127 |
| Inert gas (CO ₂ , N ₂ , etc.) | vol % | - | 4.5 | KS M ISO 6974, ASTM D1946, ASTM D1945-81, JIS K 0114 |

4.2.3. "G25" "Low Gas" (nominal 86 per cent Methane)

Table A3/11

"G25" "Low Gas" (nominal 86 per cent methane)

| <i>Characteristics</i> | <i>Units</i> | <i>Basis</i> | <i>Limits</i> | | <i>Test method</i> |
|------------------------|--------------------|--------------|----------------|----------------|--------------------|
| | | | <i>Minimum</i> | <i>Maximum</i> | |
| Composition: | | | | | |
| Methane | % mole | 86 | 84 | 88 | ISO 6974 |
| Balance ^a | % mole | — | — | 1 | ISO 6974 |
| N ₂ | % mole | 14 | 12 | 16 | ISO 6974 |
| Sulphur content | mg/m ^{3b} | — | — | 10 | ISO 6326-5 |
| Wobbe Index (net) | MJ/m ^{3c} | 39.4 | 38.2 | 40.6 | |

^a Inerts (different from N₂) + C₂ + C₂+

^b Value to be determined at 293.15 K (20 °C) and 101.325 kPa.

^c Value to be determined at 273.15 K (0 °C) and 101.325 kPa.

4.2.4. "J-Gas" (nominal 85 per cent Methane)

Table A3/12

"J-Gas" (nominal 85 per cent methane)

| <i>Characteristics</i> | <i>Units</i> | <i>Limits</i> | |
|---|----------------------|----------------|----------------|
| | | <i>Minimum</i> | <i>Maximum</i> |
| Methane | % mole | 85 | |
| Ethane | % mole | | 10 |
| Propane | % mole | | 6 |
| Butane | % mole | | 4 |
| HC of C ₃ +C ₄ | % mole | | 8 |
| HC of C ₅ or more | % mole | | 0.1 |
| Other gases (H ₂ +O ₂ +N ₂ +CO+CO ₂) | % mole | | 1.0 |
| Sulphur content | mg/Nm ³ | | 10 |
| Wobbe Index | WI | 13.260 | 13.730 |
| Gross Calorific value | kcal/Nm ³ | 10.410 | 11.050 |
| Maximum combustion speed | MCP | 36.8 | 37.5 |

4.2.5. Hydrogen

Table A3/13

Hydrogen

| <i>Characteristics</i> | <i>Units</i> | <i>Limits</i> | | <i>Test method</i> |
|-------------------------------------|--------------|----------------|----------------|--------------------|
| | | <i>Minimum</i> | <i>Maximum</i> | |
| Hydrogen purity | % mole | 98 | 100 | ISO 14687-1 |
| Total hydrocarbon | µmol/mol | 0 | 100 | ISO 14687-1 |
| Water ^a | µmol/mol | 0 | <i>b</i> | ISO 14687-1 |
| Oxygen | µmol/mol | 0 | <i>b</i> | ISO 14687-1 |
| Argon | µmol/mol | 0 | <i>b</i> | ISO 14687-1 |
| Nitrogen | µmol/mol | 0 | <i>b</i> | ISO 14687-1 |
| CO | µmol/mol | 0 | 1 | ISO 14687-1 |
| Sulphur | µmol/mol | 0 | 2 | ISO 14687-1 |
| Permanent particulates ^c | | | | ISO 14687-1 |

^a Not to be condensed.

^b Combined water, oxygen, nitrogen and argon: 1.900 µmol/mol.

^c The hydrogen shall not contain dust, sand, dirt, gums, oils, or other substances in an amount sufficient to damage the fuelling station equipment or the vehicle (engine) being fuelled.

5. Liquid fuels for compression ignition engines

5.1. J-Diesel (nominal 53 Cetane, B0)

Table A3/14

J-Diesel (nominal 53 cetane, B0)

| Fuel Property or Substance Name | Units | Specification | | Test method |
|----------------------------------|--------------------|---------------|-----------|--|
| | | Minimum | Maximum | |
| Cetane number | | 53 | 57 | JIS K2280 |
| Density | g/cm ³ | 0.824 | 0.840 | JIS K2249 |
| Distillation: | | | | |
| — 50 % distillation temperature | K (°C) | 528 (255) | 568 (295) | JIS K2254 |
| — 90 % distillation temperature | K (°C) | 573 (300) | 618 (345) | JIS K2254 |
| — final boiling point | K (°C) | | 643 (370) | JIS K2254 |
| Flash point | K (°C) | 331(58) | | JIS K2265–3 |
| Kinematic viscosity at 30 °C | mm ² /s | 3.0 | 4.5 | JIS K2283 |
| All aromatic series | vol % | | 25 | JIS Method HPLC |
| Polycyclic aromatic hydrocarbons | vol % | | 5.0 | JIS Method HPLC |
| Sulphur content | wt ppm | | 10 | JIS K2541-1 JIS K2541-2 JIS K2541-6 JIS K2541-7 |
| FAME | % | | 0.1 | Method prescribed in the Japanese concentration measurement procedure announcement |
| Triglyceride | % | | 0.01 | Method prescribed in the Japanese concentration measurement procedure announcement |

5.2. E-Diesel (nominal 52 Cetane, B5)
Table A3/15
E-Diesel (nominal 52 cetane, B5)

| Parameter | Unit | Limits ^a | | Test method |
|--|--------------------|---------------------|---------|-------------------------------|
| | | Minimum | Maximum | |
| Cetane number ^b | | 52.0 | 54.0 | EN-ISO 5165 |
| Density at 15 °C | kg/m ³ | 833 | 837 | EN-ISO 3675 |
| Distillation: | | | | |
| — 50 % point | °C | 245 | — | EN-ISO 3405 |
| — 95 % point | °C | 345 | 350 | EN-ISO 3405 |
| — final boiling point | °C | — | 370 | EN-ISO 3405 |
| Flash point | °C | 55 | — | EN 22719 |
| CFPP | °C | — | -5 | EN 116 |
| Viscosity at 40 °C | mm ² /s | 2.3 | 3.3 | EN-ISO 3104 |
| Polycyclic aromatic hydrocarbons | % m/m | 2.0 | 6.0 | EN 12916 |
| Sulphur content ^c | mg/kg | — | 10 | EN ISO 20846/ EN ISO 20884 |
| Copper corrosion | | — | Class 1 | EN-ISO 2160 |
| Conradson carbon residue (10 % DR) | % m/m | — | 0.2 | EN-ISO10370 |
| Ash content | % m/m | — | 0.01 | EN-ISO 6245 |
| Water content | % m/m | — | 0.02 | EN-ISO12937 |
| Neutralization (strong acid) number | mg KOH/g | — | 0.02 | ASTM D 974 |
| Oxidation stability ^d | mg/ml | — | 0.025 | EN-ISO12205 |
| Lubricity (HFRR wear scan diameter at 60 °C) | µm | — | 400 | EN ISO 12156 |
| Oxidation stability at 110 °C ^{d,f} | h | 20.0 | | EN 14112 |
| FAME ^e | % v/v | 4.5 | 5.5 | EN 14078 |

^a The values quoted in the specifications are 'true values'. In establishing of their limit values the terms of ISO 4259 Petroleum products — Determination and application of precision data in relation to methods of test have been applied and in fixing a minimum value, a minimum difference of 2R above zero has been taken into account; in fixing a maximum and minimum value, the minimum difference is 4R (R = reproducibility). Notwithstanding this measure, which is necessary for technical reasons, the manufacturer of fuels shall nevertheless aim at a zero value where the stipulated maximum value is 2R and at the mean value in the case of quotations of maximum and minimum limits. Should it be necessary to clarify whether a fuel meets the requirements of the specifications, the terms of ISO 4259 shall be applied.

^b The range for cetane number is not in accordance with the requirements of a minimum range of 4R. However, in the case of a dispute between fuel supplier and fuel user, the terms of ISO 4259 may be used to resolve such disputes provided replicate measurements, of sufficient number to archive the necessary precision, are made in preference to single determinations.

^c The actual sulphur content of the fuel used for the Type 1 test shall be recorded.

^d Even though oxidation stability is controlled, it is likely that shelf life will be limited. Advice shall be sought from the supplier as to storage conditions and life.

^e FAME content to meet the specification of EN 14214.

^f Oxidation stability can be demonstrated by EN-ISO12205 or by EN 14112. This requirement shall be reviewed based on CEN/TC19 evaluations of oxidative stability performance and test limits.

5.3. K-Diesel (nominal 52 Cetane, B5)

Table A3/16

K-Diesel (nominal 52 cetane, B5)

| Fuel property or substance name | Units | Specification | | Test method |
|----------------------------------|--------------------|---------------|------------------------------|--|
| | | Minimum | Maximum | |
| Pour point | °C | - | 0.0 (winter: -17.5 °C) | ASTM D6749 |
| Flash point | °C | 40 | - | KS M ISO 2719 |
| Kinematic viscosity at 40 °C | mm ² /s | 1.9 | 5.5 | KS M 2014 |
| 90 % distillation temperature | °C | - | 360 | ASTM D86 |
| 10 % carbon residue | wt % | - | 0.15 | KS M 2017, ISO 4262, IP 14, ASTM D524 |
| Water content | vol % | - | 0.02 | KS M 2115 |
| Sulphur content | mg/kg | - | 10 | KS M 2027, ASTM D5453 |
| Ash | wt % | - | 0.02 | KS M ISO 6245 |
| Cetane number | | 52 | - | KS M 2610, |
| Copper corrosion | 100 °C, 3h | - | 1 | KS M 2018 |
| Lubricity (60 °C, micron)(HFRR) | | - | 400 | CFC F-06-A, ASTM D6079 |
| Density (15 °C) | kg/cm ³ | 815 | 835 | KS M 2002, ASTM D4052 |
| Polycyclic aromatic hydrocarbons | wt % | - | 5 | KS M 2456 |
| All aromatic series | wt % | - | 30 | IP 391, ASTM D5186 |
| Fatty acid methyl esters content | vol % | - | 5 | EN 14078 |

5.4. E-Diesel (nominal 52 Cetane, B7)

Table A3/17

E-Diesel (nominal 52 cetane, B7)

| Parameter | Unit | Limits ^a | | Test method |
|--|--------------------|---------------------|---------|-------------------------------|
| | | Minimum | Maximum | |
| Cetane Index | | 46.0 | | EN-ISO 4264 |
| Cetane number ^b | | 52.0 | 56.0 | EN-ISO 5165 |
| Density at 15 °C | kg/m ³ | 833.0 | 837.0 | EN-ISO 12185 |
| Distillation: | | | | |
| — 50 % point | °C | 245.0 | — | EN-ISO 3405 |
| — 95 % point | °C | 345.0 | 360.0 | EN-ISO 3405 |
| — final boiling point | °C | — | 370.0 | EN-ISO 3405 |
| Flash point | °C | 55 | — | EN ISO 2719 |
| Cloud point | °C | — | -10 | EN 116 |
| Viscosity at 40 °C | mm ² /s | 2.30 | 3.30 | EN-ISO 3104 |
| Polycyclic aromatic hydrocarbons | % m/m | 2.0 | 4.0 | EN 12916 |
| Sulphur content | mg/kg | — | 10.0 | EN ISO 20846/ EN ISO 20884 |
| Copper corrosion (3 hours, 50 °C) | | — | Class 1 | EN-ISO 2160 |
| Conradson carbon residue (10 % DR) | % m/m | — | 0.20 | EN-ISO10370 |
| Ash content | % m/m | — | 0.010 | EN-ISO 6245 |
| Total contamination | mg/kg | | 24 | EN 12662 |
| Water content | mg/kg | — | 200 | EN-ISO12937 |
| Acid number | mg KOH/g | — | 0.10 | EN ISO 6618 |
| Lubricity (HFRR wear scan diameter at 60 °C) | µm | — | 400 | EN ISO 12156 |
| Oxidation stability at 110 °C ^c | h | 20.0 | | EN 15751 |
| FAME ^d | % v/v | 6.0 | 7.0 | EN 14078 |

^a The values quoted in the specifications are 'true values'. In establishing of their limit values the terms of ISO 4259 Petroleum products – Determination and application of precision data in relation to methods of test have been applied and in fixing a minimum value, a minimum difference of 2R above zero has been taken into account; in fixing a maximum and minimum value, the minimum difference is 4R (R = reproducibility).

Notwithstanding this measure, which is necessary for technical reasons, the manufacturer of fuels shall nevertheless aim at a zero value where the stipulated maximum value is 2R and at the mean value in the case of quotations of maximum and minimum limits. Should it be necessary to clarify whether a fuel meets the requirements of the specifications, the terms of ISO 4259 shall be applied.

^b The range for cetane number is not in accordance with the requirements of a minimum range of 4R. However, in the case of a dispute between fuel supplier and fuel user, the terms of ISO 4259 may be used to resolve such disputes provided replicate measurements, of sufficient number to archive the necessary precision, are made in preference to single determinations.

^c Even though oxidation stability is controlled, it is likely that shelf life will be limited. Advice shall be sought from the supplier as to storage conditions and life.

^d FAME content to meet the specification of EN 14214.

6. Fuels for fuel cell vehicles

6.1. Compressed hydrogen gas for fuel cell vehicles

Table A3/18

Hydrogen for fuel cell vehicles

| Characteristics | Units | Limits | | Test Method |
|--|----------|---------|---------|--------------|
| | | Minimum | Maximum | |
| Hydrogen fuel index ^a | % mole | 99.97 | | |
| Total non-hydrogen gases | µmol/mol | | 300 | |
| Maximum concentration of individual contaminants ^f | | | | |
| Water (H ₂ O) | µmol/mol | | 5 | ^e |
| Total hydrocarbons ^b (Methane basis) | µmol/mol | | 2 | ^e |
| Oxygen (O ₂) | µmol/mol | | 5 | ^e |
| Helium (He) | µmol/mol | | 300 | ^e |
| Total Nitrogen (N ₂) and Argon (Ar) ^b | µmol/mol | | 100 | ^e |
| Carbon dioxide (CO ₂) | µmol/mol | | 2 | ^e |
| Carbon monoxide (CO) | µmol/mol | | 0.2 | ^e |
| Total sulfur compounds ^c (H ₂ S basis) | µmol/mol | | 0.004 | ^e |
| Formaldehyde (HCHO) | µmol/mol | | 0.01 | ^e |
| Formic acid (HCOOH) | µmol/mol | | 0.2 | ^e |
| Ammonia (NH ₃) | µmol/mol | | 0.1 | ^e |
| Total halogenated compounds ^d (Halogenate ion basis) | µmol/mol | | 0.05 | ^e |

For the constituents that are additive, such as total hydrocarbons and total sulfur compounds, the sum of the constituents are to be less than or equal to the acceptable limit.

^a The hydrogen fuel index is determined by subtracting the “total non-hydrogen gases” in this table, expressed in mole per cent, from 100 mole per cent.

^b Total hydrocarbons include oxygenated organic species. Total hydrocarbons shall be measured on a carbon basis (µmolC/mol). Total hydrocarbons may exceed 2 µmol/mol due only to the presence of methane, in which case the summation of methane, nitrogen and argon shall not exceed 100 µmol/mol.

^c As a minimum, total sulphur compounds include H₂S, COS, CS₂ and mercaptans, which are typically found in natural gas.

^d Total halogenated compounds include, for example, hydrogen bromide (HBr), hydrogen chloride (HCl), chlorine (Cl₂), and organic halides (R-X).

^e Test method shall be documented.

^f The analysis of specific contaminants depending on the production process shall be exempted. A vehicle manufacturer shall provide the responsible authority reasons for exempting specific contaminants.

Annex 4

Road load and dynamometer setting

1. Scope

This annex describes the determination of the road load of a test vehicle and the transfer of that road load to a chassis dynamometer.
2. Terms and definitions
 - 2.1. For the purpose of this document, the terms and definitions given in paragraph 3. of this UN GTR shall have primacy. Where definitions are not provided in paragraph 3. of this UN GTR, definitions given in ISO 3833:1977 "Road vehicles -- Types -- Terms and definitions" shall apply.
 - 2.2. Reference speed points shall start at 20 km/h in incremental steps of 10 km/h and with the highest reference speed according to the following provisions:
 - (a) The highest reference speed point shall be 130 km/h or the reference speed point immediately above the maximum speed of the applicable test cycle if this value is less than 130 km/h. In the case that the applicable test cycle contains less than the 4 cycle phases (Low, Medium, High and Extra High) and at the request of the manufacturer and with approval of the responsible authority, the highest reference speed may be increased to the reference speed point immediately above the maximum speed of the next higher phase, but no higher than 130 km/h; in this case road load determination and chassis dynamometer setting shall be done with the same reference speed points;
 - (b) If a reference speed point applicable for the cycle plus 14 km/h is more than or equal to the maximum vehicle speed v_{max} , this reference speed point shall be excluded from the coastdown test and from chassis dynamometer setting. The next lower reference speed point shall become the highest reference speed point for the vehicle.
 - 2.3. Unless otherwise specified, a cycle energy demand shall be calculated according to paragraph 5. of Annex 7 over the target speed trace of the applicable drive cycle.
 - 2.4. f_0 , f_1 , f_2 are the road load coefficients of the road load equation $F = f_0 + f_1 \times v + f_2 \times v^2$ determined according to this annex.

f_0 is the constant road load coefficient and shall be rounded according to paragraph 7. of this UN GTR to one place of decimal, N;

f_1 is the first order road load coefficient and shall be rounded according to paragraph 7. of this UN GTR to three places of decimal, N/(km/h);

f_2 is the second order road load coefficient and shall be rounded according to paragraph 7. of this UN GTR to five places of decimal, N/(km/h)².

Unless otherwise stated, the road load coefficients shall be calculated with a least square regression analysis over the range of the reference speed points.

- 2.5. Rotational mass
- 2.5.1. Determination of m_r
- m_r is the equivalent effective mass of all the wheels and vehicle components rotating with the wheels on the road while the gearbox is placed in neutral, in kilograms (kg). m_r shall be measured or calculated using an appropriate technique agreed upon by the responsible authority. Alternatively, m_r may be estimated to be 3 per cent of the sum of the mass in running order and 25 kg.
- 2.5.2. Application of rotational mass to the road load
- Coastdown times shall be transferred to forces and vice versa by taking into account the applicable test mass plus m_r . This shall apply to measurements on the road as well as on a chassis dynamometer.
- 2.5.3. Application of rotational mass for the inertia setting
- If the vehicle is tested on a four wheel drive dynamometer and if both axles are rotating and influencing the dynamometer measurement results, the equivalent inertia mass of the chassis dynamometer shall be set to the applicable test mass.
- Otherwise, the equivalent inertia mass of the chassis dynamometer shall be set to the test mass plus either the equivalent effective mass of the wheels not influencing the measurement results or 50 per cent of m_r .
- 2.6. Additional masses for setting the test mass shall be applied such that the weight distribution of that vehicle is approximately the same as that of the vehicle with its mass in running order. In the case of category 2 vehicles or passenger vehicles derived from category 2 vehicles, the additional masses shall be located in a representative manner and shall be justified to the responsible authority upon their request. The weight distribution of the vehicle shall be recorded and shall be used for any subsequent road load determination testing.
3. General requirements
- The manufacturer shall be responsible for the accuracy of the road load coefficients and shall ensure this for each production vehicle within the road load family. Tolerances within the road load determination, simulation and calculation methods shall not be used to underestimate the road load of production vehicles. At the request of the responsible authority, the accuracy of the road load coefficients of an individual vehicle shall be demonstrated.
- 3.1. Overall measurement accuracy, precision, resolution and frequency
- The required overall measurement accuracy shall be as follows:
- (a) Vehicle speed accuracy: ± 0.2 km/h with a measurement frequency of at least 10 Hz;
 - (b) Time: min. accuracy: ± 10 ms; min. precision and resolution: 10 ms;
 - (c) Wheel torque accuracy: ± 6 Nm or ± 0.5 per cent of the maximum measured total torque, whichever is greater, for the whole vehicle, with a measurement frequency of at least 10 Hz;
 - (d) Wind speed accuracy: ± 0.3 m/s, with a measurement frequency of at least 1 Hz;
 - (e) Wind direction accuracy: $\pm 3^\circ$, with a measurement frequency of at least 1 Hz;

- (f) Atmospheric temperature accuracy: $\pm 1\text{ }^\circ\text{C}$, with a measurement frequency of at least 0.1 Hz;
- (g) Atmospheric pressure accuracy: $\pm 0.3\text{ kPa}$, with a measurement frequency of at least 0.1 Hz;
- (h) Vehicle mass accuracy measured on the same weighing scale before and after the test: $\pm 10\text{ kg}$ ($\pm 20\text{ kg}$ for vehicles $> 4,000\text{ kg}$);
- (i) Tyre pressure accuracy: $\pm 5\text{ kPa}$;
- (j) Wheel rotational speed accuracy: $\pm 0.05\text{ s}^{-1}$ or 1 per cent, whichever is greater.

3.2. Wind tunnel criteria

3.2.1. Wind velocity

The wind velocity during a measurement shall remain within $\pm 2\text{ km/h}$ at the centre of the test section. The possible wind velocity shall be at least 140 km/h.

3.2.2. Air temperature

The air temperature during a measurement shall remain within $\pm 3\text{ }^\circ\text{C}$ at the centre of the test section. The air temperature distribution at the nozzle outlet shall remain within $\pm 3\text{ }^\circ\text{C}$.

3.2.3. Turbulence

For an equally-spaced 3 by 3 grid over the entire nozzle outlet, the turbulence intensity, Tu , shall not exceed 1 per cent. See Figure A4/1.

Figure A4/1
Turbulence intensity

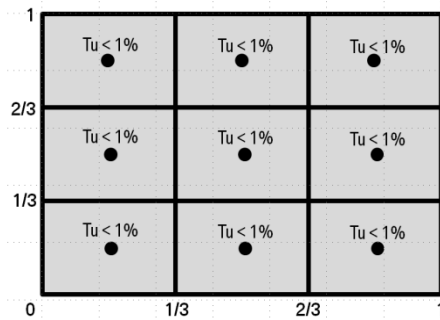

$$Tu = \frac{u'}{U_\infty}$$

where:

Tu is the turbulence intensity;

u' is the turbulent velocity fluctuation, m/s;

U_∞ is the free flow velocity, m/s.

3.2.4. Solid blockage ratio

The vehicle blockage ratio ϵ_{sb} expressed as the quotient of the vehicle frontal area and the area of the nozzle outlet as calculated using the following equation, shall not exceed 0.35.

$$\varepsilon_{sb} = \frac{A_f}{A_{nozzle}}$$

where:

ε_{sb} is the vehicle blockage ratio;

A_f is the frontal area of the vehicle, m²;

A_{nozzle} is the nozzle outlet area, m².

3.2.5. Rotating wheels

To properly determine the aerodynamic influence of the wheels, the wheels of the test vehicle shall rotate at such a speed that the resulting vehicle velocity is within ± 3 km/h of the wind velocity.

3.2.6. Moving belt

To simulate the fluid flow at the underbody of the test vehicle, the wind tunnel shall have a moving belt extending from the front to the rear of the vehicle. The speed of the moving belt shall be within ± 3 km/h of the wind velocity.

3.2.7. Fluid flow angle

At nine equally distributed points over the nozzle area, the root mean square deviation of both the pitch angle α and the yaw angle β (Y-, Z-plane) at the nozzle outlet shall not exceed 1°.

3.2.8. Air pressure

At nine equally distributed points over the nozzle outlet area, the standard deviation of the total pressure at the nozzle outlet shall be equal to or less than 0.02.

$$\sigma\left(\frac{\Delta P_t}{q}\right) \leq 0.02$$

where:

σ is the standard deviation of the pressure ratio $\left(\frac{\Delta P_t}{q}\right)$;

ΔP_t is the variation of total pressure between the measurement points, N/m²;

q is the dynamic pressure, N/ m².

The absolute difference of the pressure coefficient c_p over a distance 3 metres ahead and 3 metres behind the centre of the balance in the empty test section and at a height of the centre of the nozzle outlet shall not deviate more than ± 0.02 .

$$|c_{p_{x=+3m}} - c_{p_{x=-3m}}| \leq 0.02$$

where:

c_p is the pressure coefficient.

3.2.9. Boundary layer thickness

At $x = 0$ (balance center point), the wind velocity shall have at least 99 per cent of the inflow velocity 30 mm above the wind tunnel floor.

$$\delta_{99}(x = 0 \text{ m}) \leq 30 \text{ mm}$$

where:

δ_{99} is the distance perpendicular to the road where 99 per cent of free stream velocity is reached (boundary layer thickness).

3.2.10. Restraint blockage ratio

The restraint system mounting shall not be in front of the vehicle. The relative blockage ratio of the vehicle frontal area due to the restraint system, ϵ_{restr} , shall not exceed 0.10.

$$\epsilon_{\text{restr}} = \frac{A_{\text{restr}}}{A_f} \text{ where:}$$

ϵ_{restr} is the relative blockage ratio of the restraint system;

A_{restr} is the frontal area of the restraint system projected on the nozzle face, m²;

A_f is the frontal area of the vehicle, m².

3.2.11. Measurement accuracy of the balance in the x-direction

The inaccuracy of the resulting force in the x-direction shall not exceed ± 5 N. The resolution of the measured force shall be within ± 3 N.

3.2.12. Measurement precision

The precision of the measured force shall be within ± 3 N.

4. Road load measurement on road

4.1. Requirements for road test

4.1.1. Atmospheric conditions for road test

Atmospheric conditions (wind conditions, atmospheric temperature and atmospheric pressure) shall be measured according to paragraph 3.1. of this annex. Only those atmospheric conditions measured during coastdown time measurements and/or torque measurement shall be used for checking data validity and corrections.

4.1.1.1. Permissible wind conditions when using stationary anemometry and on-board anemometry

4.1.1.1.1. Permissible wind conditions when using stationary anemometry

The wind speed shall be measured at a location and height above the road level alongside the test road where the most representative wind conditions will be experienced. In cases where tests in opposite directions cannot be performed at the same part of the test track (e.g. on an oval test track with an obligatory driving direction), the wind speed and direction shall be measured at the opposite parts of the test track.

The wind conditions during run pairs shall meet all of the following criteria:

- (a) Wind speed shall be less than 5 m/s over a 5 second moving average period;
- (b) Peak wind speeds shall not exceed 8 m/s for more than 2 consecutive seconds;
- (c) The arithmetic average vector component of the wind speed across the test road shall be less than 2 m/s.

The wind correction shall be calculated according to paragraph 4.5.3. of this annex.

- 4.1.1.1.2. Permissible wind conditions when using on-board anemometry
- For testing with an on-board anemometer, a device as described in paragraph 4.3.2. of this annex shall be used.
- The wind conditions during run pairs shall meet all of the following criteria:
- (a) The arithmetic average of the wind speed shall be less than 7 m/s;
 - (b) Peak wind speeds shall not exceed 10 m/s for more than 2 consecutive seconds;
 - (c) The arithmetic average vector component of the wind speed across the road shall be less than 4 m/s.
- 4.1.1.2. Atmospheric temperature
- The atmospheric temperature should be within the range of 5 °C up to and including 40 °C. Contracting parties may deviate from the upper range by ± 5 °C on a regional level. At its option, a manufacturer may choose to perform coastdowns between 1 °C and 5 °C.
- If the difference between the highest and the lowest measured temperature during the coastdown test is more than 5 °C, the temperature correction shall be applied separately for each run with the arithmetic average of the ambient temperature of that run.
- In that case, the values of the road load coefficients f_0 , f_1 and f_2 shall be determined and corrected for each run pair. The final set of f_0 , f_1 and f_2 values shall be the arithmetic average of the individually corrected coefficients f_0 , f_1 and f_2 respectively. Contracting Parties may deviate from the upper range by ± 5 °C on a regional level.
- 4.1.2. Test road
- The road surface shall be flat, even, clean, dry and free of obstacles or wind barriers that might impede the measurement of the road load, and its texture and composition shall be representative of current urban and highway road surfaces, i.e. no airstrip-specific surface. The longitudinal slope of the test road shall not exceed ± 1 per cent. The local slope between any points 3 metres apart shall not deviate more than ± 0.5 per cent from this longitudinal slope. If tests in opposite directions cannot be performed at the same part of the test track (e.g. on an oval test track with an obligatory driving direction), the sum of the longitudinal slopes of the parallel test track segments shall be between 0 and an upward slope of 0.1 per cent. The maximum camber of the test road shall be 1.5 per cent.
- 4.2. Preparation
- 4.2.1. Test vehicle
- Each test vehicle shall conform in all its components with the production series, (e.g. side mirrors shall be same position as during normal vehicle operation, body gaps shall not be sealed), or, if the vehicle is different from the production vehicle, a full description shall be recorded.
- 4.2.1.1. Requirements for test vehicle selection
- 4.2.1.1.1. Without using the interpolation method
- A test vehicle (vehicle H) with the combination of road load relevant characteristics (i.e. mass, aerodynamic drag and tyre rolling resistance)

producing the highest cycle energy demand shall be selected from the family (see paragraphs 5.6. and 5.7. of this UN GTR).

If the aerodynamic influence of the different wheels within one interpolation family is not known, the selection shall be based on the highest expected aerodynamic drag. As a guideline, the highest aerodynamic drag may be expected for wheels with (a) the largest width, (b) the largest diameter, and (c) the most open structure design (in that order of importance).

The wheel selection shall be performed additional to the requirement of the highest cycle energy demand.

4.2.1.1.2. Using an interpolation method

At the request of the manufacturer, an interpolation method may be applied.

In this case, two test vehicles shall be selected from the family complying with the respective family requirement.

Test vehicle H shall be the vehicle producing the higher, and preferably highest, cycle energy demand of that selection, test vehicle L the one producing the lower, and preferably lowest, cycle energy demand of that selection.

All items of optional equipment and/or body shapes that are chosen not to be considered when applying the interpolation method shall be identical for both test vehicles H and L such that these items of optional equipment produce the highest combination of the cycle energy demand due to their road load relevant characteristics (i.e. mass, aerodynamic drag and tyre rolling resistance).

As a guidance, the following minimum deltas between vehicles H and L should be fulfilled for that road load relevant characteristic:

- (i) Mass of at least 30 kg;
- (ii) Rolling resistance of at least 1.0 kg/tonne;
- (iii) Aerodynamic drag ($C_D \times A_f$) of at least 0.05 m².

4.2.1.2. Requirements for families

4.2.1.2.1. Requirements for applying the interpolation family without using the interpolation method

For the criteria defining an interpolation family, see paragraph 5.6. of this UN GTR.

4.2.1.2.2. Requirements for applying the interpolation family using the interpolation method are:

- (a) Fulfilling the interpolation family criteria listed in paragraph 5.6. of this UN GTR;
- (b) Fulfilling the requirements in paragraphs 2.3.1. and 2.3.2. of Annex 6;
- (c) Performing the calculations in paragraph 3.2.3.2. of Annex 7.

4.2.1.2.3. Requirements for applying the road load family

4.2.1.2.3.1. At the request of the manufacturer and upon fulfilling the criteria of paragraph 5.7. of this UN GTR, the road load values for vehicles H and L of an interpolation family shall be calculated.

4.2.1.2.3.2. Test vehicles H and L as defined in paragraph 4.2.1.1.2. of this annex shall be referred to as H_R and L_R for the purpose of the road load family.

- 4.2.1.2.3.3. In addition to the requirements of an interpolation family in paragraphs 2.3.1. and 2.3.2. of Annex 6, the difference in cycle energy demand between H_R and L_R of the road load family shall be at least 4 per cent and shall not exceed 35 per cent based on H_R over a complete WLTC Class 3 cycle.

If more than one transmission is included in the road load family, a transmission with the highest power losses shall be used for road load determination.

- 4.2.1.2.3.4. If the road load delta of the vehicle option causing the friction difference is determined according to paragraph 6.8. of this annex, a new road load family shall be calculated which includes the road load delta in both vehicle L and vehicle H of that new road load family.

$$f_{0,N} = f_{0,R} + f_{0,\text{Delta}}$$

$$f_{1,N} = f_{1,R} + f_{1,\text{Delta}}$$

$$f_{2,N} = f_{2,R} + f_{2,\text{Delta}}$$

where:

N refers to the road load coefficients of the new road load family;

R refers to the road load coefficients of the reference road load family;
Delta refers to the delta road load coefficients determined in paragraph 6.8.1. of this annex.

- 4.2.1.3. Allowable combinations of test vehicle selection and family requirements

Table A4/1 shows the permissible combinations of test vehicle selection and family requirements as described in paragraphs 4.2.1.1. and 4.2.1.2. of this annex.

Table A4/1

Permissible combinations of test vehicle selection and family requirements

| <i>Requirements to be fulfilled:</i> | <i>(1) w/o interpolation method</i> | <i>(2) Interpolation method w/o road load family</i> | <i>(3) Applying the road load family</i> | <i>(4) Interpolation method using one or more road load families</i> |
|--------------------------------------|-------------------------------------|--|--|--|
| Road load test vehicle | Paragraph 4.2.1.1.1. of this annex. | Paragraph 4.2.1.1.2. of this annex. | Paragraph 4.2.1.1.2. of this annex. | n.a. |
| Family | Paragraph 4.2.1.2.1. of this annex. | Paragraph 4.2.1.2.2. of this annex. | Paragraph 4.2.1.2.3. of this annex. | Paragraph 4.2.1.2.2. of this annex. |
| Additional | none | none | none | Application of column (3) "Applying the road load family" and application of paragraph 4.2.1.3.1. of this annex. |

- 4.2.1.3.1. Deriving road loads of an interpolation family from a road load family

Road loads H_R and/or L_R shall be determined according to this annex.

The road load of vehicle H (and L) of an interpolation family within the road load family shall be calculated according to paragraphs 3.2.3.2.2. to 3.2.3.2.2.4. inclusive of Annex 7 by:

- (a) Using H_R and L_R of the road load family instead of H and L as inputs for the equations;
- (b) Using the road load parameters (i.e. test mass, $\Delta(C_D \times A_f)$ compared to vehicle L_R , and tyre rolling resistance) of vehicle H (or L) of the interpolation family as inputs for the individual vehicle;
- (c) Repeating this calculation for each H and L vehicle of every interpolation family within the road load family.

The road load interpolation shall only be applied on those road load-relevant characteristics that were identified to be different between test vehicle L_R and H_R . For other road load-relevant characteristic(s), the value of vehicle H_R shall apply.

H and L of the interpolation family may be derived from different road load families. If that difference between these road load families comes from applying the delta method, refer to paragraph 4.2.1.2.3.4. of this annex.

4.2.1.4. Application of the road load matrix family

A vehicle that fulfils the criteria of paragraph 5.8. of this UN GTR that is:

- (a) Representative of the intended series of complete vehicles to be covered by the road load matrix family in terms of estimated worst C_D value and body shape; and
- (b) Representative of the intended series of vehicles to be covered by the road load matrix family in terms of estimated average of the mass of optional equipment

shall be used to determine the road load.

In the case that no representative body shape for a complete vehicle can be determined, the test vehicle shall be equipped with a square box with rounded corners with radii of maximum of 25 mm and a width equal to the maximum width of the vehicles covered by the road load matrix family, and a total height of the test vehicle of 3.0 m \pm 0.1 m, including the box.

The manufacturer and the responsible authority shall agree which vehicle test model is representative.

The vehicle parameters test mass, tyre rolling resistance and frontal area of both a vehicle H_M and L_M shall be determined in such a way that vehicle H_M produces the highest cycle energy demand and vehicle L_M the lowest cycle energy from the road load matrix family. The manufacturer and the responsible authority shall agree on the vehicle parameters for vehicles H_M and L_M .

The road load of all individual vehicles of the road load matrix family, including H_M and L_M , shall be calculated according to paragraph 5.1. of this annex.

4.2.1.5. Movable aerodynamic body parts

Movable aerodynamic body parts on the test vehicles shall operate during road load determination as intended under WLTP Type 1 test conditions (test temperature, vehicle speed and acceleration range, engine load, etc.).

Every vehicle system that dynamically modifies the vehicle's aerodynamic drag (e.g. vehicle height control) shall be considered to be a movable aerodynamic body part. Appropriate requirements shall be added if future

vehicles are equipped with movable aerodynamic items of optional equipment whose influence on aerodynamic drag justifies the need for further requirements.

4.2.1.6. Weighing

Before and after the road load determination procedure, the selected vehicle shall be weighed, including the test driver and equipment, to determine the arithmetic average mass m_{av} . The mass of the vehicle shall be greater than or equal to the test mass of vehicle H or of vehicle L at the start of the road load determination procedure.

4.2.1.7. Test vehicle configuration

The test vehicle configuration shall be recorded and shall be used for any subsequent coastdown testing.

4.2.1.8. Test vehicle condition

4.2.1.8.1. Run-in

The test vehicle shall be suitably run-in for the purpose of the subsequent test for at least 10,000 but no more than 80,000 km.

At the request of the manufacturer, a vehicle with a minimum of 3,000 km may be used.

4.2.1.8.2. Manufacturer's specifications

The vehicle shall conform to the manufacturer's intended production vehicle specifications regarding tyre pressures described in paragraph 4.2.2.3. of this annex, wheel alignment described in paragraph 4.2.1.8.3. of this annex, ground clearance, vehicle height, drivetrain and wheel bearing lubricants, and brake adjustment to avoid unrepresentative parasitic drag.

4.2.1.8.3. Wheel alignment

Toe and camber shall be set to the maximum deviation from the longitudinal axis of the vehicle in the range defined by the manufacturer. If a manufacturer prescribes values for toe and camber for the vehicle, these values shall be used. At the request of the manufacturer, values with higher deviations from the longitudinal axis of the vehicle than the prescribed values may be used. The prescribed values shall be the reference for all maintenance during the lifetime of the vehicle.

Other adjustable wheel alignment parameters (such as caster) shall be set to the values recommended by the manufacturer. In the absence of recommended values, they shall be set to the arithmetic average of the range defined by the manufacturer.

Such adjustable parameters and set values shall be recorded.

4.2.1.8.4. Closed panels

During the road load determination, the engine compartment cover, luggage compartment cover, manually-operated movable panels and all windows shall be closed.

4.2.1.8.5. Vehicle coastdown mode

If the determination of dynamometer settings cannot meet the criteria described in paragraphs 8.1.3. or 8.2.3. of this annex due to non-reproducible

forces, the vehicle shall be equipped with a vehicle coastdown mode. The vehicle coastdown mode shall be approved and its use shall be recorded by the responsible authority.

If a vehicle is equipped with a vehicle coastdown mode, it shall be engaged both during road load determination and on the chassis dynamometer.

4.2.2. Tyres

4.2.2.1. Tyre rolling resistance

Tyre rolling resistances shall be measured according to Annex 6 to Regulation No. 117 - 02, or an internationally-accepted equivalent. The rolling resistance coefficients shall be aligned according to the respective regional procedures (e.g. EU 1235/2011), and categorised according to the rolling resistance classes in Table A4/2.

Table A4/2

Energy efficiency classes according to rolling resistance coefficients (RRC) for C1, C2 and C3 tyres and the RRC values to be used for those energy efficiency classes in the interpolation, kg/tonne

| <i>Energy efficiency class</i> | <i>Range of RRC for C1 tyres</i> | <i>Range of RRC for C2 tyres</i> | <i>Range of RRC for C3 tyres</i> |
|--------------------------------|----------------------------------|----------------------------------|----------------------------------|
| 1 | RRC ≤ 6.5 | RRC ≤ 5.5 | RRC ≤ 4.0 |
| 2 | 6.5 < RRC ≤ 7.7 | 5.5 < RRC ≤ 6.7 | 4.0 < RRC ≤ 5.0 |
| 3 | 7.7 < RRC ≤ 9.0 | 6.7 < RRC ≤ 8.0 | 5.0 < RRC ≤ 6.0 |
| 4 | 9.0 < RRC ≤ 10.5 | 8.0 < RRC ≤ 9.2 | 6.0 < RRC ≤ 7.0 |
| 5 | 10.5 < RRC ≤ 12.0 | 9.2 < RRC ≤ 10.5 | 7.0 < RRC ≤ 8.0 |
| 6 | RRC > 12.0 | RRC > 10.5 | RRC > 8.0 |

| <i>Energy efficiency class</i> | <i>Value of RRC to be used for interpolation for C1 tyres</i> | <i>Value of RRC to be used for interpolation for C2 tyres</i> | <i>Value of RRC to be used for interpolation for C3 tyres</i> |
|--------------------------------|---|---|---|
| 1 | RRC = 5.9 | RRC = 4.9 | RRC = 3.5 |
| 2 | RRC = 7.1 | RRC = 6.1 | RRC = 4.5 |
| 3 | RRC = 8.4 | RRC = 7.4 | RRC = 5.5 |
| 4 | RRC = 9.8 | RRC = 8.6 | RRC = 6.5 |
| 5 | RRC = 11.3 | RRC = 9.9 | RRC = 7.5 |
| 6 | RRC = 12.9 | RRC = 11.2 | RRC = 8.5 |

If the interpolation method is applied to rolling resistance for the purpose of the calculation in paragraph 3.2.3.2. in Annex 7, the actual rolling resistance values for the tyres fitted to the test vehicles L and H shall be used as input for the calculation procedure. For an individual vehicle within an interpolation family, the RRC value for the energy efficiency class of the tyres fitted shall be used.

4.2.2.2. Tyre condition

Tyres used for the test shall:

- (a) Not be older than 2 years after the production date;

- (b) Not be specially conditioned or treated (e.g. heated or artificially aged), with the exception of grinding in the original shape of the tread;
- (c) Be run-in on a road for at least 200 km before road load determination;
- (d) Have a constant tread depth before the test between 100 and 80 per cent of the original tread depth at any point over the full tread width of the tyre.

After measurement of tread depth, the driving distance shall be limited to 500 km. If 500 km are exceeded, the tread depth shall be measured again.

4.2.2.3. Tyre pressure

The front and rear tyres shall be inflated to the lower limit of the tyre pressure range for the respective axle for the selected tyre at the coastdown test mass, as specified by the vehicle manufacturer.

4.2.2.3.1. Tyre pressure adjustment

If the difference between ambient and soak temperature is more than 5 °C, the tyre pressure shall be adjusted as follows:

- (a) The tyres shall be soaked for more than 1 hour at 10 per cent above the target pressure;
- (b) Prior to testing, the tyre pressure shall be reduced to the inflation pressure as specified in paragraph 4.2.2.3. of this annex, adjusted for difference between the soaking environment temperature and the ambient test temperature at a rate of 0.8 kPa per 1 °C using the following equation:

$$\Delta p_t = 0.8 \times (T_{\text{soak}} - T_{\text{amb}})$$

where:

Δp_t is the tyre pressure adjustment added to the tyre pressure defined in paragraph 4.2.2.3. of this annex, kPa;

0.8 is the pressure adjustment factor, kPa/°C;

T_{soak} is the tyre soaking temperature, °C;

T_{amb} is the test ambient temperature, °C.

- (c) Between the pressure adjustment and the vehicle warm-up, the tyres shall be shielded from external heat sources including sun radiation.

4.2.3. Instrumentation

Any instruments shall be installed in such a manner as to minimise their effects on the aerodynamic characteristics of the vehicle.

If the effect of the installed instrument on $(C_D \times A_f)$ is expected to be greater than 0.015 m², the vehicle with and without the instrument shall be measured in a wind tunnel fulfilling the criteria in paragraph 3.2. of this annex. The corresponding difference shall be subtracted from f_2 . At the request of the manufacturer, and with approval of the responsible authority, the determined value may be used for similar vehicles where the influence of the equipment is expected to be the same.

- 4.2.4. Vehicle warm-up
- 4.2.4.1. On the road
- Warming up shall be performed by driving the vehicle only.
- 4.2.4.1.1. Before warm-up, the vehicle shall be decelerated with the clutch disengaged or an automatic transmission placed in neutral by moderate braking from 80 to 20 km/h within 5 to 10 seconds. After this braking, there shall be no further actuation or manual adjustment of the braking system.
- At the request of the manufacturer and upon approval of the responsible authority, the brakes may also be activated after the warm-up with the same deceleration as described in this paragraph and only if necessary.
- 4.2.4.1.2. Warming up and stabilization
- All vehicles shall be driven at 90 per cent of the maximum speed of the applicable WLTC. The vehicle may be driven at 90 per cent of the maximum speed of the next higher phase (see Table A4/3) if this phase is added to the applicable WLTC warm-up procedure as defined in paragraph 7.3.4. of this annex. The vehicle shall be warmed up for at least 20 minutes until stable conditions are reached.

Table A4/3

Warming-up and stabilization across phases

| <i>Cycle class</i> | <i>Applicable WLTC</i> | <i>90 per cent of maximum speed</i> | <i>Next higher phase</i> |
|--------------------|--|-------------------------------------|--------------------------|
| Class 1 | Low ₁ + Medium ₁ | 58 km/h | NA |
| Class 2 | Low ₂ + Medium ₂ + High ₂ + Extra High ₂ | 111 km/h | NA |
| | Low ₂ + Medium ₂ + High ₂ | 77 km/h | Extra High (111 km/h) |
| Class 3 | Low ₃ + Medium ₃ + High ₃ + Extra High ₃ | 118 km/h | NA |
| | Low ₃ + Medium ₃ + High ₃ | 88 km/h | Extra High (118 km/h) |

- 4.2.4.1.3. Criterion for stable condition
- Refer to paragraph 4.3.1.4.2. of this annex.
- 4.3. Measurement and calculation of road load using the coastdown method
- The road load shall be determined by using either the stationary anemometry (paragraph 4.3.1. of this annex) or the on-board anemometry (paragraph 4.3.2. of this annex) method.
- 4.3.1. Coastdown method using stationary anemometry
- 4.3.1.1. Selection of reference speeds for road load curve determination
- Reference speeds for road load determination shall be selected according to paragraph 2.2. of this annex.
- 4.3.1.2. Data collection
- During the test, elapsed time and vehicle speed shall be measured at a minimum frequency of 10 Hz.
- 4.3.1.3. Vehicle coastdown procedure

- 4.3.1.3.1. Following the vehicle warm-up procedure described in paragraph 4.2.4. of this annex and immediately prior to each coastdown run, the vehicle shall be accelerated to 10 to 15 km/h above the highest reference speed and shall be driven at that speed for a maximum of 1 minute. After that, the coastdown run shall be started immediately.
- 4.3.1.3.2. During a coastdown run, the transmission shall be in neutral. Any movement of the steering wheel shall be avoided as much as possible, and the vehicle brakes shall not be operated.
- 4.3.1.3.3. The test shall be repeated until the coastdown data satisfy the statistical precision requirements as specified in paragraph 4.3.1.4.2. of this annex.
- 4.3.1.3.4. Although it is recommended that each coastdown run should be performed without interruption, if data cannot be collected in a single run for all the reference speed points, the coastdown test may be performed with coastdown runs where the first and last reference speeds are not necessarily the highest and lowest reference speeds. In this case, the following additional requirements shall apply:
- (a) At least one reference speed in each coastdown run shall overlap with the immediately higher speed range coastdown run. This reference speed shall be referred to as a split point;
 - (b) At each overlapped reference speed, the average force of the immediately lower speed coastdown run shall not deviate from the average force of the immediately higher speed coastdown run by ± 10 N or ± 5 percent, whichever is greater;
 - (c) Overlapped reference speed data of the lower speed coastdown run shall be used only for checking criterion (b) and shall be excluded from evaluation of the statistical precision as defined in paragraph 4.3.1.4.2. of this annex;
 - (d) The overlapped speed may be less than 10 km/h but shall not be less than 5 km/h. In this case, overlap criterion (b) shall be checked by either extrapolating the polynomial curves for the lower and higher speed segment to a 10 km/h overlap, or by comparing the average force in the specific speed range.
- 4.3.1.3.5. It is recommended that coastdown runs should be conducted successively without undue delay between runs. If there is a delay between runs (e.g. for a driver break, checking vehicle integrity, etc.), the vehicle shall be warmed up again as described in paragraph 4.2.4. and the coastdown runs shall be recommenced from this point.
- 4.3.1.4. Coastdown time measurement
- 4.3.1.4.1. The coastdown time corresponding to reference speed v_j as the elapsed time from vehicle speed $(v_j + 5$ km/h) to $(v_j - 5$ km/h) shall be measured.
- 4.3.1.4.2. These measurements shall be carried out in opposite directions until a minimum of three pairs of measurements have been obtained that satisfy the statistical precision p_j defined in the following equation:

$$p_j = \frac{h \times \sigma_j}{\sqrt{n} \times \Delta t_{pj}} \leq 0.030$$

where:

p_j is the statistical precision of the measurements made at reference speed v_j ;

n is the number of pairs of measurements;

Δt_{pj} is the harmonic average of the coastdown time at reference speed v_j in seconds given by the following equation:

$$\Delta t_{pj} = \frac{n}{\sum_{i=1}^n \frac{1}{\Delta t_{ji}}}$$

where:

Δt_{ji} is the harmonic average coastdown time of the i^{th} pair of measurements at velocity v_j , seconds, s, given by the following equation:

$$\Delta t_{ji} = \frac{2}{\left(\frac{1}{\Delta t_{jai}}\right) + \left(\frac{1}{\Delta t_{jbi}}\right)}$$

where:

Δt_{jai} and Δt_{jbi} are the coastdown times of the i^{th} measurement at reference speed v_j , in seconds, s, in the respective directions a and b;

σ_j is the standard deviation, expressed in seconds, s, defined by:

$$\sigma_j = \sqrt{\frac{1}{n-1} \sum_{i=1}^n (\Delta t_{ji} - \Delta t_{pj})^2}$$

h is a coefficient given in Table A4/4.

Table A4/4
Coefficient h as a function of n

| <i>n</i> | <i>h</i> | <i>n</i> | <i>h</i> |
|----------|----------|----------|----------|
| 3 | 4.3 | 17 | 2.1 |
| 4 | 3.2 | 18 | 2.1 |
| 5 | 2.8 | 19 | 2.1 |
| 6 | 2.6 | 20 | 2.1 |
| 7 | 2.5 | 21 | 2.1 |
| 8 | 2.4 | 22 | 2.1 |
| 9 | 2.3 | 23 | 2.1 |
| 10 | 2.3 | 24 | 2.1 |
| 11 | 2.2 | 25 | 2.1 |
| 12 | 2.2 | 26 | 2.1 |
| 13 | 2.2 | 27 | 2.1 |
| 14 | 2.2 | 28 | 2.1 |
| 15 | 2.2 | 29 | 2.0 |
| 16 | 2.1 | 30 | 2.0 |

4.3.1.4.3. If during a measurement in one direction any external factor or driver action occurs that obviously influences the road load test, that measurement and the corresponding measurement in the opposite direction shall be rejected. All the rejected data and the reason for rejection shall be recorded, and the number of

rejected pairs of measurement shall not exceed 1/3 of the total number of measurement pairs. In the case of split runs, the rejection criteria shall be applied at each split run speed range.

Due to uncertainty of data validity and for practical reasons, more than the minimum number of run pairs required in paragraph 4.3.1.4.2. of this annex may be performed, but the total number of run pairs shall not exceed 30 runs including the rejected pairs as described in this paragraph. In this case, data evaluation shall be carried out as described in paragraph 4.3.1.4.2. of this annex starting from the first run pair, then including as many consecutive run pairs as needed to reach the statistical precision on a data set containing no more than 1/3 of rejected pairs. The remaining run pairs shall be disregarded.

4.3.1.4.4. The following equation shall be used to compute the arithmetic average of the road load where the harmonic average of the alternate coastdown times shall be used:

$$F_j = \frac{1}{3.6} \times (m_{av} + m_r) \times \frac{2 \times \Delta v}{\Delta t_j}$$

where:

Δv is 5
km/h;

Δt_j is the harmonic average of alternate coastdown time measurements at velocity v_j , seconds, s, given by:

$$\Delta t_j = \frac{2}{\frac{1}{\Delta t_{ja}} + \frac{1}{\Delta t_{jb}}}$$

where:

Δt_{ja} and Δt_{jb} are the harmonic average coastdown times in directions a and b, respectively, corresponding to reference speed v_j , in seconds, s, given by the following two equations:

$$\Delta t_{ja} = \frac{n}{\sum_{i=1}^n \frac{1}{t_{jai}}}$$

and:

$$\Delta t_{jb} = \frac{n}{\sum_{i=1}^n \frac{1}{t_{jbi}}}$$

where:

m_{av} is the arithmetic average of the test vehicle masses at the beginning and end of road load determination, kg;

m_r is the equivalent effective mass of rotating components according to paragraph 2.5.1. of this annex;

The coefficients, f_0 , f_1 and f_2 , in the road load equation shall be calculated with a least squares regression analysis.

In the case that the tested vehicle is the representative vehicle of a road load matrix family, the coefficient f_1 shall be set to zero and the coefficients f_0 and f_2 shall be recalculated with a least squares regression analysis.

- 4.3.2. Coastdown method using on-board anemometry
The vehicle shall be warmed up and stabilised according to paragraph 4.2.4. of this annex.
- 4.3.2.1. Additional instrumentation for on-board anemometry
The on-board anemometer and instrumentation shall be calibrated by means of operation on the test vehicle where such calibration occurs during the warm-up for the test.
- 4.3.2.1.1. Relative wind speed shall be measured at a minimum frequency of 1 Hz and to an accuracy of 0.3 m/s. Vehicle blockage shall be accounted for in the calibration of the anemometer.
- 4.3.2.1.2. Wind direction shall be relative to the direction of the vehicle. The relative wind direction (yaw) shall be measured with a resolution of 1 degree and an accuracy of 3 degrees; the dead band of the instrument shall not exceed 10 degrees and shall be directed towards the rear of the vehicle.
- 4.3.2.1.3. Before the coastdown, the anemometer shall be calibrated for speed and yaw offset as specified in ISO 10521-1:2006(E) Annex A.
- 4.3.2.1.4. Anemometer blockage shall be corrected for in the calibration procedure as described in ISO 10521-1:2006(E) Annex A in order to minimise its effect.
- 4.3.2.2. Selection of vehicle speed range for road load curve determination
The test vehicle speed range shall be selected according to paragraph 2.2. of this annex.
- 4.3.2.3. Data collection
During the procedure, elapsed time, vehicle speed, and air velocity (speed, direction) relative to the vehicle, shall be measured at a minimum frequency of 5 Hz. Ambient temperature shall be synchronised and sampled at a minimum frequency of 0.1 Hz.
- 4.3.2.4. Vehicle coastdown procedure
The measurements shall be carried out in run pairs in opposite directions until a minimum of ten consecutive runs (five pairs) have been obtained. Should an individual run fail to satisfy the required on-board anemometry test conditions, that pair, i.e. that run and the corresponding run in the opposite direction, shall be rejected. All valid pairs shall be included in the final analysis with a minimum of 5 pairs of coastdown runs. See paragraph 4.3.2.6.10. of this annex for statistical validation criteria.
The anemometer shall be installed in a position such that the effect on the operating characteristics of the vehicle is minimised.
The anemometer shall be installed according to one of the options below:
- (a) Using a boom approximately 2 metres in front of the vehicle's forward aerodynamic stagnation point;
 - (b) On the roof of the vehicle at its centreline. If possible, the anemometer shall be mounted within 30 cm from the top of the windshield;
 - (c) On the engine compartment cover of the vehicle at its centreline, mounted at the midpoint position between the vehicle front and the base of the windshield.

In all cases, the anemometer shall be mounted parallel to the road surface. In the event that positions (b) or (c) are used, the coastdown results shall be analytically adjusted for the additional aerodynamic drag induced by the anemometer. The adjustment shall be made by testing the coastdown vehicle in a wind tunnel both with and without the anemometer installed in the same position as used on the track., The calculated difference shall be the incremental aerodynamic drag coefficient C_D combined with the frontal area, which shall be used to correct the coastdown results.

- 4.3.2.4.1. Following the vehicle warm-up procedure described in paragraph 4.2.4. of this annex and immediately prior to each coastdown run, the vehicle shall be accelerated to 10 to 15 km/h above the highest reference speed and shall be driven at that speed for a maximum of 1 minute. After that, the coastdown run shall be started immediately.
- 4.3.2.4.2. During a coastdown run, the transmission shall be in neutral. Any steering wheel movement shall be avoided as much as possible, and the vehicle's brakes shall not be operated.
- 4.3.2.4.3. Although it is recommended that each coastdown run be performed without interruption, if data cannot be collected in a single run for all the reference speed points the coastdown test may be performed with coastdown runs where the first and last reference speeds are not necessarily the highest and lowest reference speeds. For split runs, the following additional requirements shall apply:
 - (a) At least one reference speed in each coastdown run shall overlap with the immediately higher speed range coastdown run. This reference speed shall be referred to as a split point;
 - (b) At each overlapped reference speed, the average force of the immediately lower speed coastdown run shall not deviate from the average force of the immediately higher speed range coastdown run by ± 10 N or ± 5 percent, whichever is greater;
 - (c) Overlapped reference speed data of the lower speed coastdown run shall be used only for checking criterion (b) and shall be excluded from evaluation of the statistical precision as defined in paragraph 4.3.1.4.2. of this annex;
 - (d) The overlapped speed may be less than 10 km/h but shall not be less than 5 km/h. In this case, overlap criterion (b) shall be checked by either extrapolating the polynomial curves for the lower and higher speed segment to a 10 km/h overlap, or by comparing the average force in the specific speed range.
- 4.3.2.4.4. It is recommended that coastdown runs should be conducted successively without undue delay between runs. If there is a delay between runs (e.g. for a driver break, checking vehicle integrity, etc.), the vehicle shall be warmed up again as described in paragraph 4.2.4. and the coastdown runs shall be re-commenced from this point.

4.3.2.5. Determination of the equation of motion

Symbols used in the on-board anemometer equations of motion are listed in Table A4/5.

Table A4/5

Symbols used in the on-board anemometer equations of motion

| <i>Symbol</i> | <i>Units</i> | <i>Description</i> |
|-----------------|-----------------------|--|
| A_f | m^2 | frontal area of the vehicle |
| $a_0 \dots a_n$ | degrees ⁻¹ | aerodynamic drag coefficients as a function of yaw angle |
| A_m | N | mechanical drag coefficient |
| B_m | N/(km/h) | mechanical drag coefficient |
| C_m | N/(km/h) ² | mechanical drag coefficient |
| $C_D(Y)$ | | aerodynamic drag coefficient at yaw angle Y |
| D | N | drag |
| D_{aero} | N | aerodynamic drag |
| D_f | N | front axle drag (including driveline) |
| D_{grav} | N | gravitational drag |
| D_{mech} | N | mechanical drag |
| D_r | N | rear axle drag (including driveline) |
| D_{tyre} | N | tyre rolling resistance |
| (dh/ds) | - | sine of the slope of the track in the direction of travel (+ indicates ascending) |
| (dv/dt) | m/s^2 | acceleration |
| g | m/s^2 | gravitational constant |
| m_{av} | kg | arithmetic average mass of the test vehicle before and after road load determination |
| m_e | kg | effective vehicle mass including rotating components |
| ρ | kg/m^3 | air density |
| t | s | time |
| T | K | Temperature |
| v | km/h | vehicle speed |
| v_r | km/h | relative wind speed |
| Y | degrees | yaw angle of apparent wind relative to direction of vehicle travel |

4.3.2.5.1. General form

The general form of the equation of motion is as follows:

$$-m_e \left(\frac{dv}{dt} \right) = D_{mech} + D_{aero} + D_{grav}$$

where:

$$D_{\text{mech}} = D_{\text{tyre}} + D_f + D_r;$$

$$D_{\text{aero}} = \left(\frac{1}{2}\right) \rho C_D(Y) A_f v_r^2;$$

$$D_{\text{grav}} = m \times g \times \left(\frac{dh}{ds}\right)$$

In the case that the slope of the test track is equal to or less than 0.1 per cent over its length, D_{grav} may be set to zero.

4.3.2.5.2. Mechanical drag modelling

Mechanical drag consisting of separate components representing tyre D_{tyre} and front and rear axle frictional losses D_f and D_r (including transmission losses) shall be modelled as a three-term polynomial as a function of vehicle speed v as in the equation below:

$$D_{\text{mech}} = A_m + B_m v + C_m v^2$$

where A_m , B_m , and C_m are determined in the data analysis using the least squares method. These constants reflect the combined driveline and tyre drag.

In the case that the tested vehicle is the representative vehicle of a road load matrix family, the coefficient B_m shall be set to zero and the coefficients A_m and C_m shall be recalculated with a least squares regression analysis.

4.3.2.5.3. Aerodynamic drag modelling

The aerodynamic drag coefficient $C_D(Y)$ shall be modelled as a four-term polynomial as a function of yaw angle Y as in the equation below:

$$C_D(Y) = a_0 + a_1 Y + a_2 Y^2 + a_3 Y^3 + a_4 Y^4$$

a_0 to a_4 are constant coefficients whose values are determined in the data analysis.

The aerodynamic drag shall be determined by combining the drag coefficient with the vehicle's frontal area A_f and the relative wind velocity v_r :

$$D_{\text{aero}} = \left(\frac{1}{2}\right) \times \rho \times A_f \times v_r^2 \times C_D(Y)$$

$$D_{\text{aero}} = \left(\frac{1}{2}\right) \times \rho \times A_f \times v_r^2 (a_0 + a_1 Y + a_2 Y^2 + a_3 Y^3 + a_4 Y^4)$$

4.3.2.5.4. Final equation of motion

Through substitution, the final form of the equation of motion becomes:

$$-m_e \left(\frac{dv}{dt}\right) = A_m + B_m v + C_m v^2 + \left(\frac{1}{2}\right) \times \rho \times A_f \times v_r^2 (a_0 + a_1 Y + a_2 Y^2 + a_3 Y^3 + a_4 Y^4) + (m \times g \times \frac{dh}{ds})$$

4.3.2.6. Data reduction

A three-term equation shall be generated to describe the road load force as a function of velocity, $F = A + Bv + Cv^2$, corrected to standard ambient temperature and pressure conditions, and in still air. The method for this analysis process is described in paragraphs 4.3.2.6.1. to 4.3.2.6.10. inclusive of this annex.

4.3.2.6.1. Determining calibration coefficients

If not previously determined, calibration factors to correct for vehicle blockage shall be determined for relative wind speed and yaw angle. Vehicle speed v ,

relative wind velocity v_r and yaw Y measurements during the warm-up phase of the test procedure shall be recorded. Paired runs in alternate directions on the test track at a constant velocity of 80 km/h shall be performed, and the arithmetic average values of v , v_r and Y for each run shall be determined. Calibration factors that minimize the total errors in head and cross winds over all the run pairs, i.e. the sum of $(\text{head}_i - \text{head}_{i+1})^2$, etc., shall be selected where head_i and head_{i+1} refer to wind speed and wind direction from the paired test runs in opposing directions during the vehicle warm-up/stabilization prior to testing.

4.3.2.6.2. Deriving second by second observations

From the data collected during the coastdown runs, values for v , $\left(\frac{dh}{ds}\right)\left(\frac{dv}{dt}\right)$, v_r^2 , and Y shall be determined by applying calibration factors obtained in paragraphs 4.3.2.1.3. and 4.3.2.1.4. of this annex. Data filtering shall be used to adjust samples to a frequency of 1 Hz.

4.3.2.6.3. Preliminary analysis

Using a linear least squares regression technique, all data points shall be analysed at once to determine A_m , B_m , C_m , a_0 , a_1 , a_2 , a_3 and a_4 given m_e , $\left(\frac{dh}{ds}\right)$, $\left(\frac{dv}{dt}\right)$, v , v_r , and ρ .

4.3.2.6.4. Data outliers

A predicted force $m_e\left(\frac{dv}{dt}\right)$ shall be calculated and compared to the observed data points. Data points with excessive deviations, e.g., over three standard deviations, shall be flagged.

4.3.2.6.5. Data filtering (optional)

Appropriate data filtering techniques may be applied and the remaining data points shall be smoothed out.

4.3.2.6.6. Data elimination

Data points gathered where yaw angles are greater than ± 20 degrees from the direction of vehicle travel shall be flagged. Data points gathered where relative wind is less than + 5 km/h (to avoid conditions where tailwind speed is higher than vehicle speed) shall also be flagged. Data analysis shall be restricted to vehicle speeds within the speed range selected according to paragraph 4.3.2.2. of this annex.

4.3.2.6.7. Final data analysis

All data that has not been flagged shall be analysed using a linear least squares regression technique. Given m_e , $\left(\frac{dh}{ds}\right)$, $\left(\frac{dv}{dt}\right)$, v , v_r , and ρ , A_m , B_m , C_m , a_0 , a_1 , a_2 , a_3 and a_4 shall be determined.

4.3.2.6.8. Constrained analysis (optional)

To better separate the vehicle aerodynamic and mechanical drag, a constrained analysis may be applied such that the vehicle's frontal area A_f and the drag coefficient C_D may be fixed if they have been previously determined.

4.3.2.6.9. Correction to reference conditions

Equations of motion shall be corrected to reference conditions as specified in paragraph 4.5. of this annex.

4.3.2.6.10. Statistical criteria for on-board anemometry

The exclusion of each single pair of coastdown runs shall change the calculated road load for each coastdown reference speed v_j less than the convergence requirement, for all i and j :

$$\Delta F_i(v_j)/F(v_j) \leq \frac{0.03}{\sqrt{n-1}}$$

where:

$\Delta F_i(v_j)$ is the difference between the calculated road load with all coastdown runs and the calculated road load with the i^{th} pair of coastdown runs excluded, N;

$F(v_j)$ is the calculated road load with all coastdown runs included, N;

v_j is the reference speed, km/h;

n is the number of pairs of coastdown runs, all valid pairs are included.

In the case that the convergence requirement is not met, pairs shall be removed from the analysis, starting with the pair giving the highest change in calculated road load, until the convergence requirement is met, as long as a minimum of 5 valid pairs are used for the final road load determination.

4.4. Measurement and calculation of running resistance using the torque meter method

As an alternative to the coastdown methods, the torque meter method may also be used in which the running resistance is determined by measuring wheel torque on the driven wheels at the reference speed points for time periods of at least 5 seconds.

4.4.1. Installation of torque meters

Wheel torque meters shall be installed between the wheel hub and the wheel of each driven wheel, measuring the required torque to keep the vehicle at a constant speed.

The torque meter shall be calibrated on a regular basis, at least once a year, traceable to national or international standards, in order to meet the required accuracy and precision.

4.4.2. Procedure and data sampling

4.4.2.1. Selection of reference speeds for running resistance curve determination

Reference speed points for running resistance determination shall be selected according to paragraph 2.2. of this annex.

The reference speeds shall be measured in descending order. At the request of the manufacturer, there may be stabilization periods between measurements but the stabilization speed shall not exceed the speed of the next reference speed.

4.4.2.2. Data collection

Data sets consisting of actual speed v_{ji} actual torque C_{ji} and time over a period of at least 5 seconds shall be measured for every v_j at a sampling frequency of at least 10 Hz. The data sets collected over one time period for a reference speed v_j shall be referred to as one measurement.

4.4.2.3. Vehicle torque meter measurement procedure

Prior to the torque meter method test measurement, a vehicle warm-up shall be performed according to paragraph 4.2.4. of this annex.

During test measurement, steering wheel movement shall be avoided as much as possible, and the vehicle brakes shall not be operated.

The test shall be repeated until the running resistance data satisfy the measurement precision requirements as specified in paragraph 4.4.3.2. of this annex.

4.4.2.4. Velocity deviation

During a measurement at a single reference speed point, the velocity deviation from the arithmetic average velocity ($v_{ji}-v_{jm}$) calculated according to paragraph 4.4.3. of this annex, shall be within the values in Table A4/6.

Additionally, the arithmetic average velocity v_{jm} at every reference speed point shall not deviate from the reference speed v_j by more than ± 1 km/h or 2 per cent of the reference speed v_j , whichever is greater.

Table A4/6

Velocity deviation

| <i>Time period, s</i> | <i>Velocity deviation, km/h</i> |
|-----------------------|---------------------------------|
| 5 - 10 | ± 0.2 |
| 10 - 15 | ± 0.4 |
| 15 - 20 | ± 0.6 |
| 20 - 25 | ± 0.8 |
| 25 - 30 | ± 1.0 |
| ≥ 30 | ± 1.2 |

4.4.2.5. Atmospheric temperature

Tests shall be performed under the same temperature conditions as defined in paragraph 4.1.1.2. of this annex.

4.4.3. Calculation of arithmetic average velocity and arithmetic average torque

4.4.3.1. Calculation process

Arithmetic average velocity v_{jm} , in km/h, and arithmetic average torque C_{jm} , in Nm, of each measurement shall be calculated from the data sets collected according to the requirements of paragraph 4.4.2.2. of this annex using the following equations:

$$v_{jm} = \frac{1}{k} \sum_{i=1}^k v_{ji}$$

and

$$C_{jm} = \frac{1}{k} \sum_{i=1}^k C_{ji} - C_{js}$$

where:

v_{ji} is the actual vehicle speed of the i^{th} data set at reference speed point j , km/h;

k is the number of data sets in a single measurement;

C_{ji} is the actual torque of the i^{th} data set, Nm;

C_{js} is the compensation term for speed drift, Nm, given by the following equation:

$$C_{js} = (m_{st} + m_r) \times \alpha_j r_j.$$

$\frac{C_{js}}{\frac{1}{k} \sum_{i=1}^k C_{ji}}$ shall be no greater than 0.05 and may be disregarded if α_j is not greater than ± 0.005 m/s²;

m_{st} is the test vehicle mass at the start of the measurements and shall be measured immediately before the warm-up procedure and no earlier, kg;

m_r is the equivalent effective mass of rotating components according to paragraph 2.5.1. of this annex, kg;

r_j is the dynamic radius of the tyre determined at a reference point of 80 km/h or at the highest reference speed point of the vehicle if this speed is lower than 80 km/h, calculated using the following equation:

$$r_j = \frac{1}{3.6} \times \frac{v_{jm}}{2 \times \pi n}$$

where:

n is the rotational frequency of the driven tyre, s⁻¹;

α_j is the arithmetic average acceleration, m/s², calculated using the following equation:

$$\alpha_j = \frac{1}{3.6} \times \frac{k \sum_{i=1}^k t_i v_{ji} - \sum_{i=1}^k t_i \sum_{i=1}^k v_{ji}}{k \times \sum_{i=1}^k t_i^2 - [\sum_{i=1}^k t_i]^2}$$

where:

t_i is the time at which the i^{th} data set was sampled, s.

4.4.3.2. Measurement precision

The measurements shall be carried out in opposite directions until a minimum of three pairs of measurements at each reference speed v_i have been obtained, for which \bar{C}_j satisfies the precision ρ_j according to the following equation:

$$\rho_j = \frac{h \times s}{\sqrt{n} \times \bar{C}_j} \leq 0.03$$

where:

n is the number pairs of measurements for C_{jm} ;

\bar{C}_j is the running resistance at the speed v_j , Nm, given by the equation:

$$\bar{C}_j = \frac{1}{n} \sum_{i=1}^n C_{jmi}$$

where:

C_{jmi} is the arithmetic average torque of the i^{th} pair of measurements at speed v_j , Nm, and given by:

$$C_{jmi} = \frac{1}{2} \times (C_{jmai} + C_{jm bi})$$

where:

C_{jmai} and C_{jmbi} are the arithmetic average torques of the i^{th} measurement at speed v_j determined in paragraph 4.4.3.1. of this annex for each direction, a and b respectively, Nm;

s is the standard deviation, Nm, calculated using the following equation:

$$s = \sqrt{\frac{1}{k-1} \sum_{i=1}^k (C_{jmi} - \bar{C}_j)^2}$$

h is a coefficient as a function of n as given in Table A4/4 in paragraph 4.3.1.4.2. of this annex.

4.4.4. Running resistance curve determination

The arithmetic average speed and arithmetic average torque at each reference speed point shall be calculated using the following equations:

$$V_{jm} = \frac{1}{2} \times (v_{jma} + v_{jmb})$$

$$C_{jm} = \frac{1}{2} \times (C_{jma} + C_{jmb})$$

The following least squares regression curve of arithmetic average running resistance shall be fitted to all the data pairs (v_{jm}, C_{jm}) at all reference speeds described in paragraph 4.4.2.1. of this annex to determine the coefficients c_0 , c_1 and c_2 .

The coefficients, c_0 , c_1 and c_2 , as well as the coastdown times measured on the chassis dynamometer (see paragraph 8.2.4. of this annex) shall be recorded.

In the case that the tested vehicle is the representative vehicle of a road load matrix family, the coefficient c_1 shall be set to zero and the coefficients c_0 and c_2 shall be recalculated with a least squares regression analysis.

4.5. Correction to reference conditions and measurement equipment

4.5.1. Air resistance correction factor

The correction factor for air resistance K_2 shall be determined using the following equation:

$$K_2 = \frac{T}{293 \text{ K}} \times \frac{100 \text{ kPa}}{P}$$

where:

T is the arithmetic average atmospheric temperature of all individual runs, Kelvin (K);

P is the arithmetic average atmospheric pressure, kPa.

4.5.2. Rolling resistance correction factor

The correction factor K_0 for rolling resistance, in Celsius⁻¹ (°C⁻¹), may be determined based on empirical data and approved by the responsible authority for the particular vehicle and tyre combination to be tested, or may be assumed to be as follows:

$$K_0 = 8.6 \times 10^{-3} \text{ °C}^{-1}$$

4.5.3. Wind correction

4.5.3.1. Wind correction with stationary anemometry

Wind correction may be waived when the arithmetic average wind speed for each valid run pair is 2 m/s or less. In the case that wind speed is measured at more than one part of the test track, such as when the test is performed on an oval test track (see paragraph 4.1.1.1.1. of this annex), the wind speed shall be averaged at each measurement location and the higher of two average wind speeds shall be used to determine whether a wind speed correction is to be applied or may be waived.

4.5.3.1.1. The wind correction resistance w_1 for the coastdown method or w_2 for the torque meter method shall be calculated using the following equations:

$$w_1 = 3.6^2 \times f_2 \times v_w^2$$

$$\text{or: } w_2 = 3.6^2 \times c_2 \times v_w^2$$

where:

- w_1 is the wind correction resistance for the coastdown method, N;
- f_2 is the coefficient of the aerodynamic term determined according to paragraph 4.3.1.4.4. of this annex;
- v_w in the case that wind speed is measured at only one point, v_w is the arithmetic average vector component of the wind speed parallel to the test road during all valid run pairs m/s;
- v_w in the case that the wind speed is measured at two points, v_w is the lower of the two arithmetic average vector components of the wind speed parallel to the test road during all valid run pairs, m/s;
- w_2 is the wind correction resistance for the torque meter method, Nm;
- c_2 is the coefficient of the aerodynamic term for the torque meter method determined according to paragraph 4.4.4. of this annex.

4.5.3.2. Wind correction with on-board anemometry

In the case that the coastdown method is based on on-board anemometry, w_1 and w_2 in the equations in paragraph 4.5.3.1.1. of this annex shall be set to zero, as the wind correction is already applied according to paragraph 4.3.2. of this annex.

4.5.4. Test mass correction factor

The correction factor K_1 for the test mass of the test vehicle shall be determined using the following equation:

$$K_1 = \left(1 - \frac{TM}{m_{av}}\right)$$

where:

- TM is the test mass of the test vehicle, kg;
- m_{av} is the arithmetic average of the test vehicle masses at the beginning and end of road load determination, kg.

4.5.5. Road load curve correction

4.5.5.1. The curve determined in paragraph 4.3.1.4.4. of this annex shall be corrected to reference conditions as follows:

$$F^* = ((f_0(1 - K_1) - w_1) + f_1v) \times (1 + K_0(T - 20)) + K_2f_2v^2$$

where:

- F^* is the corrected road load, N;
 f_0 is the constant road load coefficient, N;
 f_1 is the first order road load coefficient, N/(km/h);
 f_2 is the second order road load coefficient, N/(km/h)²;
 K_0 is the correction factor for rolling resistance as defined in paragraph 4.5.2. of this annex;
 K_1 is the test mass correction as defined in paragraph 4.5.4. of this annex;
 K_2 is the correction factor for air resistance as defined in paragraph 4.5.1. of this annex;
 T is the arithmetic average atmospheric temperature during all valid run pairs, °C;
 v is vehicle velocity, km/h;
 w_1 is the wind resistance correction as defined in paragraph 4.5.3. of this annex, N.

The result of the calculation below shall be used as the target road load coefficient A_t in the calculation of the chassis dynamometer load setting described in paragraph 8.1. of this annex:

$$((f_0(1 - K_1) - w_1) + f_1v) \times (1 + K_0(T - 20)).$$

The result of the calculation below shall be used as the target road load coefficient B_t in the calculation of the chassis dynamometer load setting described in paragraph 8.1. of this annex:

$$(f_1 \times (1 + K_0 \times (T-20))).$$

The result of the calculation below shall be used as the target road load coefficient C_t in the calculation of the chassis dynamometer load setting described in paragraph 8.1. of this annex:

$$(K_2 \times f_2).$$

4.5.5.2. The curve determined in paragraph 4.4.4. of this annex shall be corrected to reference conditions and measurement equipment installed according to the following procedure.

4.5.5.2.1. Correction to reference conditions

$$C^* = ((c_0(1 - K_1) - w_2) + c_1v) \times (1 + K_0(T - 20)) + K_2f_2v^2$$

where:

- C^* is the corrected running resistance, Nm;
 c_0 is the constant term as determined in paragraph 4.4.4. of this annex, Nm;

- c_1 is the coefficient of the first order term as determined in paragraph 4.4.4. of this annex, Nm/(km/h);
- c_2 is the coefficient of the second order term as determined in paragraph 4.4.4. of this annex, Nm/(km/h)²;
- K_0 is the correction factor for rolling resistance as defined in paragraph 4.5.2. of this annex;
- K_1 is the test mass correction as defined in paragraph 4.5.4. of this annex;
- K_2 is the correction factor for air resistance as defined in paragraph 4.5.1. of this annex;
- v is the vehicle velocity, km/h;
- T is the arithmetic average atmospheric temperature during all valid run pairs, °C;
- w_2 is the wind correction resistance as defined in paragraph 4.5.3. of this annex.

4.5.5.2.2. Correction for installed torque meters

If the running resistance is determined according to the torque meter method, the running resistance shall be corrected for effects of the torque measurement equipment installed outside the vehicle on its aerodynamic characteristics.

The running resistance coefficient c_2 shall be corrected using the following equation:

$$c_{2\text{corr}} = K_2 \times c_2 \times (1 + (\Delta(C_D \times A_f)) / (C_{D'} \times A_{f'}))$$

where:

$$\Delta(C_D \times A_f) = (C_D \times A_f) - (C_{D'} \times A_{f'});$$

$C_{D'} \times A_{f'}$ is the product of the aerodynamic drag coefficient multiplied by the frontal area of the vehicle with the torque meter measurement equipment installed measured in a wind tunnel fulfilling the criteria of paragraph 3.2. of this annex, m²;

$C_D \times A_f$ is the product of the aerodynamic drag coefficient multiplied by the frontal area of the vehicle with the torque meter measurement equipment not installed measured in a wind tunnel fulfilling the criteria of paragraph 3.2. of this annex, m².

4.5.5.2.3. Target running resistance coefficients

The result of the calculation below shall be used as the target running resistance coefficient a_t in the calculation of the chassis dynamometer load setting described in paragraph 8.2. of this annex:

$$((c_0(1 - K_1) - w_2) + c_1 v) \times (1 + K_0(T - 20)).$$

The result of the calculation below shall be used as the target running resistance coefficient b_t in the calculation of the chassis dynamometer load setting described in paragraph 8.2. of this annex:

$$(c_1 \times (1 + K_0 \times (T - 20))).$$

The result of the calculation below shall be used as the target running resistance coefficient c_t in the calculation of the chassis dynamometer load setting described in paragraph 8.2. of this annex:

$$(c_{2\text{corr}} \times r).$$

5. Method for the calculation of road load or running resistance based on vehicle parameters
- 5.1. Calculation of road load and running resistance for vehicles based on a representative vehicle of a road load matrix family
- If the road load of the representative vehicle is determined according to a coastdown method described in paragraph 4.3. of this annex or according to the wind tunnel method described in paragraph 6. of this annex, the road load of an individual vehicle shall be calculated according to paragraph 5.1.1. of this annex.
- If the running resistance of the representative vehicle is determined according to the torque meter method described in paragraph 4.4. of this annex, the running resistance of an individual vehicle shall be calculated according to paragraph 5.1.2. of this annex.
- 5.1.1. For the calculation of the road load of vehicles of a road load matrix family, the vehicle parameters described in paragraph 4.2.1.4. of this annex and the road load coefficients of the representative test vehicle determined in paragraph 4.3. of this annex shall be used.
- 5.1.1.1. The road load force for an individual vehicle shall be calculated using the following equation:

$$F_c = f_0 + (f_1 \times v) + (f_2 \times v^2)$$

where:

F_c is the calculated road load force as a function of vehicle velocity, N;

f_0 is the constant road load coefficient, N, defined by the equation:

$$f_0 = \text{Max}((0.05 \times f_{0r} + 0.95 \times (f_{0r} \times \text{TM}/\text{TM}_r + (\frac{\text{RR} - \text{RR}_r}{1000}) \times 9.81 \times \text{TM})); \\ (0.2 \times f_{0r} + 0.8 \times (f_{0r} \times \text{TM}/\text{TM}_r + (\frac{\text{RR} - \text{RR}_r}{1000}) \times 9.81 \times \text{TM})))$$

f_{0r} is the constant road load coefficient of the representative vehicle of the road load matrix family, N;

f_1 is the first order road load coefficient, N/(km/h), and shall be set to zero;

f_2 is the second order road load coefficient, N/(km/h)², defined by the equation:

$$f_2 = \text{Max}((0.05 \times f_{2r} + 0.95 \times f_{2r} \times A_f / A_{fr}); (0.2 \times f_{2r} + 0.8 \times f_{2r} \times A_f / A_{fr}))$$

f_{2r} is the second order road load coefficient of the representative vehicle of the road load matrix family, N/(km/h)²;

v is the vehicle speed, km/h;

TM is the actual test mass of the individual vehicle of the road load matrix family, kg;

TM_r is the test mass of the representative vehicle of the road load matrix family, kg;

A_f is the frontal area of the individual vehicle of the road load matrix family, m²,

A_{fr} is the frontal area of the representative vehicle of the road load matrix family, m²;

RR is the tyre rolling resistance of the individual vehicle of the road load matrix family, kg/tonne;

RR_r is the tyre rolling resistance of the representative vehicle of the road load matrix family, kg/tonne.

For the tyres fitted to an individual vehicle, the value of the rolling resistance RR shall be set to the class value of the applicable tyre energy efficiency class according to Table A4/2 of Annex 4.

If the tyres on the front and rear axles belong to different energy efficiency classes, the weighted mean shall be used, calculated using the equation in paragraph 3.2.3.2.2.2. of Annex 7.

If the same tyres were fitted to test vehicles L and H, the value of RR_{ind} when using the interpolation method shall be set to RR_H .

5.1.2. For the calculation of the running resistance of vehicles of a road load matrix family, the vehicle parameters described in paragraph 4.2.1.4. of this annex and the running resistance coefficients of the representative test vehicle determined in paragraph 4.4. of this annex shall be used.

5.1.2.1. The running resistance for an individual vehicle shall be calculated using the following equation:

$$C_c = c_0 + c_1 \times v + c_2 \times v^2$$

where:

C_c is the calculated running resistance as a function of vehicle velocity, Nm;

c_0 is the constant running resistance coefficient, Nm, defined by the equation:

$$c_0 = r'/1.02 \times \text{Max}((0.05 \times 1.02 \times c_{0r}/r' + 0.95 \times (1.02 \times c_{0r}/r' \times TM/TM_r + (\frac{RR - RR_r}{1000}) \times 9.81 \times TM)); (0.2 \times 1.02 \times c_{0r}/r' + 0.8 \times (1.02 \times c_{0r}/r' \times TM/TM_r + (\frac{RR - RR_r}{1000}) \times 9.81 \times TM)))$$

c_{0r} is the constant running resistance coefficient of the representative vehicle of the road load matrix family, Nm;

c_1 is the first order running resistance coefficient, Nm/(km/h), and shall be set to zero;

c_2 is the second order running resistance coefficient, Nm/(km/h)², defined by the equation:

$$c_2 = r'/1.02 \times \text{Max}((0.05 \times 1.02 \times c_{2r}/r' + 0.95 \times 1.02 \times c_{2r}/r' \times A_f / A_{fr}); (0.2 \times 1.02 \times c_{2r}/r' + 0.8 \times 1.02 \times c_{2r}/r' \times A_f / A_{fr}))$$

c_{2r} is the second order running resistance coefficient of the representative vehicle of the road load matrix family, N/(km/h)²;

v is the vehicle speed, km/h;

TM is the actual test mass of the individual vehicle of the road load matrix family, kg;

- TM_r is the test mass of the representative vehicle of the road load matrix family, kg;
- A_f is the frontal area of the individual vehicle of the road load matrix family, m²;
- A_{fr} is the frontal area of the representative vehicle of the road load matrix family, m²;
- RR is the tyre rolling resistance of the individual vehicle of the road load matrix family, kg/tonne;
- RR_r is the tyre rolling resistance of the representative vehicle of the road load matrix family, kg/tonne;
- r' is the dynamic radius of the tyre on the chassis dynamometer obtained at 80 km/h, m;
- 1.02 is an approximate coefficient compensating for drivetrain losses.

5.2. Calculation of the default road load based on vehicle parameters

- 5.2.1. As an alternative for determining road load with the coastdown or torque meter method, a calculation method for default road load may be used.

For the calculation of a default road load based on vehicle parameters, several parameters such as test mass, width and height of the vehicle shall be used. The default road load F_c shall be calculated for the reference speed points.

- 5.2.2. The default road load force shall be calculated using the following equation:

$$F_c = f_0 + (f_1 \times v) + (f_2 \times v^2)$$

where:

- F_c is the calculated default road load force as a function of vehicle velocity, N;
- f₀ is the constant road load coefficient, N, defined by the following equation:

$$f_0 = 0.140 \times TM;$$

- f₁ is the first order road load coefficient, N/(km/h), and shall be set to zero;
- f₂ is the second order road load coefficient, N/(km/h)², defined by the following equation:

$$f_2 = (2.8 \times 10^{-6} \times TM) + (0.0170 \times \text{width} \times \text{height});$$

- v is vehicle velocity, km/h;

TM test mass, kg;

width vehicle width as defined in 6.2. of Standard ISO 612:1978, m;

height vehicle height as defined in 6.3. of Standard ISO 612:1978, m.

6. Wind tunnel method

The wind tunnel method is a road load measurement method using a combination of a wind tunnel and a chassis dynamometer or of a wind tunnel and a flat belt dynamometer. The test benches may be separate facilities or integrated with one another.

- 6.1. Measurement method
- 6.1.1. The road load shall be determined by:
- (a) adding the road load forces measured in a wind tunnel and those measured using a flat belt dynamometer; or
 - (b) adding the road load forces measured in a wind tunnel and those measured on a chassis dynamometer.
- 6.1.2. Aerodynamic drag shall be measured in the wind tunnel.
- 6.1.3. Rolling resistance and drivetrain losses shall be measured using a flat belt or a chassis dynamometer, measuring the front and rear axles simultaneously.
- 6.2. Approval of the facilities by the responsible authority
- The results of the wind tunnel method shall be compared to those obtained using the coastdown method to demonstrate qualification of the facilities and recorded.
- 6.2.1. Three vehicles shall be selected by the responsible authority. The vehicles shall cover the range of vehicles (e.g. size, weight) planned to be measured with the facilities concerned.
- 6.2.2. Two separate coastdown tests shall be performed with each of the three vehicles according to paragraph 4.3. of this annex, and the resulting road load coefficients, f_0 , f_1 and f_2 , shall be determined according to that paragraph and corrected according to paragraph 4.5.5. of this annex. The coastdown test result of a test vehicle shall be the arithmetic average of the road load coefficients of its two separate coastdown tests. If more than two coastdown tests are necessary to fulfil the approval of facilities' criteria, all valid tests shall be averaged.
- 6.2.3. Measurement with the wind tunnel method according to paragraphs 6.3. to 6.7. inclusive of this annex shall be performed on the same three vehicles as selected in paragraph 6.2.1. of this annex and in the same conditions, and the resulting road load coefficients, f_0 , f_1 and f_2 , shall be determined.
- If the manufacturer chooses to use one or more of the available alternative procedures within the wind tunnel method (i.e. paragraph 6.5.2.1. on preconditioning, paragraphs 6.5.2.2. and 6.5.2.3. on the procedure, including paragraph 6.5.2.3.3. on dynamometer setting), these procedures shall also be used also for the approval of the facilities.
- 6.2.4. Approval criteria
- The facility or combination of facilities used shall be approved if both of the following two criteria are fulfilled:
- (a) The difference in cycle energy, expressed as ε_k , between the wind tunnel method and the coastdown method shall be within ± 0.05 for each of the three vehicles k according to the following equation:

$$\varepsilon_k = \frac{E_{k,WTM}}{E_{k,coastdown}} - 1$$

where:

ε_k is the difference in cycle energy over a complete Class 3 WLTC for vehicle k between the wind tunnel method and the coastdown method, per cent;

$E_{k,WTM}$ is the cycle energy over a complete Class 3 WLTC for vehicle k, calculated with the road load derived from the wind tunnel method (WTM) calculated according to paragraph 5. of Annex 7, J;

$E_{k,coastdown}$ is the cycle energy over a complete Class 3 WLTC for vehicle k, calculated with the road load derived from the coastdown method calculated according to paragraph 5. of Annex 7, J.; and

(b) The arithmetic average \bar{x} of the three differences shall be within 0.02.

$$\bar{x} = \left| \frac{\varepsilon_1 + \varepsilon_2 + \varepsilon_3}{3} \right|$$

The approval shall be recorded by the responsible authority including measurement data and the facilities concerned.

The facility may be used for road load determination for a maximum of two years after the approval has been granted.

Each combination of roller chassis dynamometer or moving belt and wind tunnel shall be approved separately.

Every combination of wind speeds (see paragraph 6.4.3. of this annex) used for the determination of road load values shall be validated separately.

6.3. Vehicle preparation and temperature

Conditioning and preparation of the vehicle shall be performed according to paragraphs 4.2.1. and 4.2.2. of this annex and applies to both the flat belt or roller chassis dynamometers and the wind tunnel measurements.

In the case that the alternative warm-up procedure described in paragraph 6.5.2.1. of this annex is applied, the target test mass adjustment, the weighing of the vehicle and the measurement shall all be performed without the driver in the vehicle.

The flat belt or the chassis dynamometer test cells shall have a temperature set point of 20 °C with a tolerance of ± 3 °C. At the request of the manufacturer, the set point may also be 23 °C with a tolerance of ± 3 °C.

6.4. Wind tunnel procedure

6.4.1. Wind tunnel criteria

The wind tunnel design, test methods and the corrections shall provide a value of $(C_D \times A_f)$ representative of the on-road $(C_D \times A_f)$ value and with a repeatability of ± 0.015 m².

For all $(C_D \times A_f)$ measurements, the wind tunnel criteria listed in paragraph 3.2. of this annex shall be met with the following modifications:

- (a) The solid blockage ratio described in paragraph 3.2.4. of this annex shall be less than 25 per cent;
- (b) The belt surface contacting any tyre shall exceed the length of that tyre's contact area by at least 20 per cent and shall be at least as wide as that contact patch;
- (c) The standard deviation of total air pressure at the nozzle outlet described in paragraph 3.2.8. of this annex shall be less than 1 per cent;

- (d) The restraint system blockage ratio described in paragraph 3.2.10. of this annex shall be less than 3 per cent;
- (e) Additionally to the requirement defined in paragraph 3.2.11. of this annex, when measuring Class 1 vehicles, the precision of the measured force shall not exceed ± 2.0 N.

6.4.2. Wind tunnel measurement

The vehicle shall be in the condition described in paragraph 6.3. of this annex.

The vehicle shall be placed parallel to the longitudinal centre line of the tunnel with a maximum tolerance of ± 10 mm.

The vehicle shall be placed with a yaw angle of 0° within a tolerance of $\pm 0.1^\circ$.

Aerodynamic drag shall be measured for at least for 60 seconds and at a minimum frequency of 5 Hz. Alternatively, the drag may be measured at a minimum frequency of 1 Hz and with at least 300 subsequent samples. The result shall be the arithmetic average of the drag.

Prior to a test it shall be checked that at the aerodynamic force measured at a wind speed of 0 km/h yields a result equal to 0 Newtons.

In the case that the vehicle has movable aerodynamic body parts, paragraph 4.2.1.5. of this annex shall apply. Where movable parts are velocity-dependent, every applicable position shall be measured in the wind tunnel and evidence shall be provided to the responsible authority indicating the relationship between reference speed, movable part position, and the corresponding ($C_D \times A_f$).

6.4.3. Wind speeds for wind tunnel measurement

The aerodynamic force shall be measured at two wind speeds under the following speed conditions:

- (a) Class 1 vehicles
 - Lower wind speed v_{low} to measure aerodynamic force shall be $v_{low} < 80$ km/h;
 - Higher wind speed v_{high} shall be $(v_{low} + 40 \text{ km/h} \leq v_{high} \leq 150 \text{ km/h})$.
- (b) Class 2 and 3 vehicles
 - Lower wind speed v_{low} to measure aerodynamic force shall be $80 \text{ km/h} \leq v_{low} \leq 100 \text{ km/h}$;
 - Higher wind speed shall be $(v_{low} + 40 \text{ km/h} \leq v_{high} \leq 150 \text{ km/h})$.

6.5. Flat belt applied for the wind tunnel method

6.5.1. Flat belt criteria

6.5.1.1. Description of the flat belt test bench

The wheels shall rotate on flat belts that do not change the rolling characteristics of the wheels compared to those on the road. The measured forces in the x-direction shall include the frictional forces in the drivetrain.

6.5.1.2. Vehicle restraint system

The dynamometer shall be equipped with a centring device aligning the vehicle within a tolerance of ± 0.5 degrees of rotation around the z-axis. The restraint system shall maintain the centred drive wheel position throughout the coastdown runs of the road load determination within the following limits:

- 6.5.1.2.1. Lateral position (y-axis)
The vehicle shall remain aligned in the y-direction and lateral movement shall be minimised.
- 6.5.1.2.2. Front and rear position (x-axis)
Additional to the requirement of paragraph 6.5.1.2.1. of this annex, both wheel axes shall be within ± 10 mm of the belt's lateral centre lines.
- 6.5.1.2.3. Vertical force
The restraint system shall be designed so as to impose no vertical force on the drive wheels.
- 6.5.1.3. Accuracy of measured forces
Only the reaction force for turning the wheels shall be measured. No external forces shall be included in the result (e.g. force of the cooling fan air, vehicle restraints, aerodynamic reaction forces of the flat belt, dynamometer losses, etc.).
The force in the x-direction shall be measured with an accuracy of ± 5 N.
- 6.5.1.4. Flat belt speed control
The belt speed shall be controlled with an accuracy of ± 0.1 km/h.
- 6.5.1.5. Flat belt surface
The flat belt surface shall be clean, dry and free from foreign material that might cause tyre slippage.
- 6.5.1.6. Cooling
A current of air of variable speed shall be blown towards the vehicle. The set point of the linear velocity of the air at the blower outlet shall be equal to the corresponding dynamometer speed above measurement speeds of 5 km/h. The linear velocity of the air at the blower outlet shall be within ± 5 km/h or ± 10 per cent of the corresponding measurement speed, whichever is greater.
- 6.5.2. Flat belt measurement
The measurement procedure may be performed according to either paragraph 6.5.2.2. or paragraph 6.5.2.3. of this annex.
- 6.5.2.1. Preconditioning
The vehicle shall be conditioned on the dynamometer as described in paragraphs 4.2.4.1.1. to 4.2.4.1.3. inclusive of this annex.
The dynamometer load setting F_d for the preconditioning shall be:
- $$F_d = a_d + (b_d \times v) + (c_d \times v^2)$$
- where:
- $a_d = 0$
- $b_d = f_{1a}$;
- $c_d = f_{2a}$
- The equivalent inertia of the dynamometer shall be the test mass.

The aerodynamic drag used for the load setting shall be taken from paragraph 6.7.2. of this annex and may be set directly as input. Otherwise, a_d , b_d , and c_d from this paragraph shall be used.

At the request of the manufacturer, as an alternative to paragraph 4.2.4.1.2. of this annex, the warm-up may be conducted by driving the vehicle with the flat belt.

In this case, the warm-up speed shall be 110 per cent of the maximum speed of the applicable WLTC and the duration shall exceed 1,200 seconds until the change of measured force over a period of 200 seconds is less than 5 N.

- 6.5.2.2. Measurement procedure with stabilised speeds
- 6.5.2.2.1. The test shall be conducted from the highest to the lowest reference speed point.
- 6.5.2.2.2. Immediately after the measurement at the previous speed point, the deceleration from the current to the next applicable reference speed point shall be performed in a smooth transition of approximately 1 m/s².
- 6.5.2.2.3. The reference speed shall be stabilised for at least 4 seconds and for a maximum of 10 seconds. The measurement equipment shall ensure that the signal of the measured force is stabilised after that period.
- 6.5.2.2.4. The force at each reference speed shall be measured for at least 6 seconds while the vehicle speed is kept constant. The resulting force for that reference speed point $F_{jD_{\text{dyno}}}$ shall be the arithmetic average of the force during the measurement.

The steps in paragraphs 6.5.2.2.2. to 6.5.2.2.4. inclusive of this annex shall be repeated for each reference speed.

- 6.5.2.3. Measurement procedure by deceleration
- 6.5.2.3.1. Preconditioning and dynamometer setting shall be performed according to paragraph 6.5.2.1. of this annex. Prior to each coastdown, the vehicle shall be driven at the highest reference speed or, in the case that the alternative warm-up procedure is used at 110 per cent of the highest reference speed, for at least 1 minute. The vehicle shall be subsequently accelerated to at least 10 km/h above the highest reference speed and the coastdown shall be started immediately.
- 6.5.2.3.2. The measurement shall be performed according to paragraphs 4.3.1.3.1. to 4.3.1.4.4. inclusive of this annex. If coasting down in opposite directions is not possible, then the equation used to calculate Δt_{ji} in paragraph 4.3.1.4.2. of this annex shall not apply. The measurement shall be stopped after two decelerations if the force of both coastdowns at each reference speed point is within ± 10 N, otherwise at least three coastdowns shall be performed using the criteria set out in paragraph 4.3.1.4.2. of this annex. 6.5.2.3.3. The force $f_{jD_{\text{dyno}}}$ at each reference speed v_j shall be calculated by removing the simulated aerodynamic force:

$$f_{jD_{\text{dyno}}} = f_{j\text{Decel}} - c_d \times v_j^2$$

where:

$f_{j\text{Decel}}$ is the force determined according to the equation calculating F_j in paragraph 4.3.1.4.4. of this annex at reference speed point j , N;

c_d is the dynamometer set coefficient as defined in paragraph 6.5.2.1. of this annex, $N/(km/h)^2$.

Alternatively, at the request of the manufacturer, c_d may be set to zero during the coastdown and for calculating f_{jDyno} .

6.5.2.4. Measurement conditions

The vehicle shall be in the condition described in paragraph 4.3.1.3.2. of this annex.

6.5.3. Measurement result of the flat belt method

The result of the flat belt dynamometer f_{jDyno} shall be referred to as f_j for the further calculations in paragraph 6.7. of this annex.

6.6. Chassis dynamometer applied for the wind tunnel method

6.6.1. Criteria

In addition to the descriptions in paragraphs 1. and 2. of Annex 5, the criteria described in paragraph 6.6.1. shall apply.

6.6.1.1. Description of a chassis dynamometer

The front and rear axles shall be equipped with a single roller with a diameter of not less than 1.2 metres.

6.6.1.2. Vehicle restraint system

The dynamometer shall be equipped with a centring device aligning the vehicle. The restraint system shall maintain the centred drive wheel position within the following recommended limits throughout the coastdown runs of the road load determination:

6.6.1.2.1. Vehicle position

The vehicle to be tested shall be installed on the chassis dynamometer roller as defined in paragraph 7.3.3. of this annex.

6.6.1.2.2. Vertical force

The restraint system shall fulfil the requirements of paragraph 6.5.1.2.3. of this annex.

6.6.1.3. Accuracy of measured forces

The accuracy of measured forces shall be as described in paragraph 6.5.1.3. of this annex apart from the force in the x-direction that shall be measured with an accuracy as described in paragraph 2.4.1. of Annex 5.

6.6.1.4. Dynamometer speed control

The roller speeds shall be controlled with an accuracy of ± 0.2 km/h.

6.6.1.5. Roller surface

The roller surface shall be clean, dry and free from foreign material that might cause tyre slippage.

6.6.1.6. Cooling

The cooling fan shall be as described in paragraph 6.5.1.6. of this annex.

6.6.2. Dynamometer measurement

The measurement shall be performed as described in paragraph 6.5.2. of this annex.

6.6.3. Correcting measured chassis dynamometer forces to those on a flat surface

The measured forces on the chassis dynamometer shall be corrected to a reference equivalent to the road (flat surface) and the result shall be referred to as f_j .

$$f_j = f_{j\text{Dyno}} \times c1 \times \sqrt{\frac{1}{\frac{R_{\text{Wheel}}}{R_{\text{Dyno}}} \times c2 + 1}} + f_{j\text{Dyno}} \times (1 - c1)$$

where:

$c1$ is the tyre rolling resistance fraction of $f_{j\text{Dyno}}$;

$c2$ is a chassis dynamometer-specific radius correction factor;

$f_{j\text{Dyno}}$ is the force calculated in paragraph 6.5.2.3.3. of this annex for each reference speed j , N;

R_{Wheel} is one-half of the nominal design tyre diameter, m;

R_{Dyno} is the radius of the chassis dynamometer roller, m.

The manufacturer and the responsible authority shall agree on the factors $c1$ and $c2$ to be used, based on correlation test evidence provided by the manufacturer for the range of tyre characteristics intended to be tested on the chassis dynamometer.

As an alternative the following conservative equation may be used:

$$f_j = f_{j\text{Dyno}} \times \sqrt{\frac{1}{\frac{R_{\text{Wheel}}}{R_{\text{Dyno}}} \times 0.2 + 1}}$$

$C2$ shall be 0.2 except that 2.0 shall be used if the road load delta method (see paragraph 6.8. of this annex) is used and the road load delta calculated according to paragraph 6.8.1. of this annex is negative.

6.7. Calculations

6.7.1. Correction of the flat belt and chassis dynamometer results

The measured forces determined in paragraphs 6.5. and 6.6. of this annex shall be corrected to reference conditions using the following equation:

$$F_{Dj} = (f_j - K_1) \times (1 + K_0(T - 293))$$

where:

F_{Dj} is the corrected resistance measured at the flat belt or chassis dynamometer at reference speed j , N;

f_j is the measured force at reference speed j , N;

K_0 is the correction factor for rolling resistance as defined in paragraph 4.5.2. of this annex, K^{-1} ;

K_1 is the test mass correction as defined in paragraph 4.5.4. of this annex, N;

T is the arithmetic average temperature in the test cell during the measurement, K.

6.7.2. Calculation of the aerodynamic force

The calculation in paragraph 6.7.2.1. shall be applied considering the results of both wind speeds. However, if the difference of the product of the drag coefficient and frontal area ($C_D \times A_f$) measured at the wind speeds v_{low} and v_{high} is less than 0.015 m^2 , the calculation in paragraph 6.7.2.2. may be applied at the request of the manufacturer.

6.7.2.1. The aerodynamic force of each wind speed F_{0wind} , F_{low} , and F_{high} shall be calculated using the equation below.

$$F_{Aw} = (C_D \times A_f)_w \times \frac{\rho_0}{2} \times \frac{v_w^2}{3.6^2}$$

where:

$(C_D \times A_f)_j$ is the product of the drag coefficient and frontal area measured in the wind tunnel at a certain reference speed point j, if applicable, m^2 ;

ρ_0 is the dry air density defined in paragraph 3.2.10. of this UN GTR, kg/m^3 ;

F_w is the aerodynamic force calculated at wind speed w, N;

v_w is the applicable wind speed, km/h.

w is the reference to the applicable wind speed "0wind", "low" and "high";

F_{0wind} is the aerodynamic force at 0 km/h, N;

F_{low} is the aerodynamic force at v_{low} , N;

F_{high} is the aerodynamic force at v_{high} , N.

The aerodynamic force coefficients f_{1a} and f_{2a} shall be calculated with a least square regression analysis using F_{0wind} , F_{low} , and F_{high} and the equation below:

$$F = f_{1a} \times v + f_{2a} \times v^2$$

The final result for the aerodynamic force F_{Aj} shall be calculated with the equation below at each reference speed point v_j . If the vehicle is equipped with velocity-dependent movable aerodynamic body parts, the corresponding aerodynamic force shall be applied for the reference speed points concerned.

$$F_{Aj} = f_{1a} \times v_j + f_{2a} \times v_j^2$$

6.7.2.2. The aerodynamic force shall be calculated using the equation below, where the final $(C_D \times A_f)$ of that wind speed shall be used, that is also used for determination of optional equipment within the interpolation method. If the vehicle is equipped with velocity-dependent movable aerodynamic body parts, the corresponding $(C_D \times A_f)$ values shall be applied for the reference speed points concerned.

$$F_{Aj} = (C_D \times A_f)_j \times \frac{\rho_0}{2} \times \frac{v_j^2}{3.6^2}$$

where:

- F_{Aj} is the aerodynamic force calculated at reference speed j , N;
- $(C_D \times A_f)_j$ is the product of the drag coefficient and frontal area measured in the wind tunnel at a certain reference speed point j , if applicable, m²;
- ρ_0 is the dry air density defined in paragraph 3.2.10. of this UN GTR, kg/m³;
- v_j is the reference speed j , km/h.

6.7.3. Calculation of road load values

The total road load as a sum of the results of paragraphs 6.7.1 and 6.7.2. of this annex shall be calculated using the following equation:

$$F_j^* = F_{Dj} + F_{Aj}$$

for all applicable reference speed points j , N.

For all calculated F_j^* , the coefficients f_0 , f_1 and f_2 in the road load equation shall be calculated with a least squares regression analysis and shall be used as the target coefficients in paragraph 8.1.1. of this annex.

In the case that the vehicle tested according to the wind tunnel method is representative of a road load matrix family vehicle, the coefficient f_1 shall be set to zero and the coefficients f_0 and f_2 shall be recalculated with a least squares regression analysis.

6.8. Road load delta method

For the purpose of including options when using the interpolation method which are not incorporated in the road load interpolation (i.e. aerodynamics, rolling resistance and mass), a delta in vehicle friction may be measured by the road load delta method (e.g. friction difference between brake systems). The following steps shall be performed:

- (a) The friction of reference vehicle R shall be measured;
- (b) The friction of the vehicle with the option (vehicle N) causing the difference in friction shall be measured;
- (c) The difference shall be calculated according to paragraph 6.8.1. of this annex.

These measurements shall be performed on a flat belt according to paragraph 6.5. of this annex or on a chassis dynamometer according to paragraph 6.6. of this annex, and the correction of the results (excluding aerodynamic force) calculated according to paragraph 6.7.1. of this annex.

The application of this method is permitted only if the following criterion is fulfilled:

$$\left| \frac{1}{n} \sum_{j=1}^n (F_{Dj,R} - F_{Dj,N}) \right| \leq 25 \text{ N}$$

where:

- $F_{Dj,R}$ is the corrected resistance of vehicle R measured on the flat belt or chassis dynamometer at reference speed j calculated according to paragraph 6.7.1. of this annex, N;

$F_{Dj,N}$ is the corrected resistance of vehicle N measured on the flat belt or chassis dynamometer at reference speed j calculated according to paragraph 6.7.1. of this annex, N;

n is the total number of speed points.

This alternative road load determination method may only be applied if vehicles R and N have identical aerodynamic resistance and if the measured delta appropriately covers the entire influence on the vehicle's energy consumption. This method shall not be applied if the overall accuracy of the absolute road load of vehicle N is compromised in any way.

6.8.1. Determination of delta flat belt or chassis dynamometer coefficients

The delta road load shall be calculated using the following equation:

$$F_{Dj,Delta} = F_{Dj,N} - F_{Dj,R}$$

where:

$F_{Dj,Delta}$ is the delta road load at reference speed j, N;

$F_{Dj,N}$ is the corrected resistance measured on the flat belt or chassis dynamometer at reference speed j calculated according to paragraph 6.7.1. of this annex for vehicle N, N;

$F_{Dj,R}$ is the corrected resistance of the reference vehicle measured on the flat belt or chassis dynamometer at reference speed j calculated according to paragraph 6.7.1. of this annex for reference vehicle R, N.

For all calculated $F_{Dj,Delta}$, the coefficients $f_{0,Delta}$, $f_{1,Delta}$ and $f_{2,Delta}$ in the road load equation shall be calculated with a least squares regression analysis.

6.8.2. Determination of total road load

If the interpolation method (see paragraph 3.2.3.2. of Annex 7) is not used, the road load delta method for vehicle N shall be calculated according to the following equations:

$$f_{0,N} = f_{0,R} + f_{0,Delta}$$

$$f_{1,N} = f_{1,R} + f_{1,Delta}$$

$$f_{2,N} = f_{2,R} + f_{2,Delta}$$

where:

N refers to the road load coefficients of vehicle N;

R refers to the road load coefficients of reference vehicle R;

Delta refers to the delta road load coefficients determined in paragraph 6.8.1. of this annex.

7. Transferring road load to a chassis dynamometer

7.1. Preparation for chassis dynamometer test

7.1.1. Laboratory conditions

7.1.1.1. Roller(s)

The chassis dynamometer roller(s) shall be clean, dry and free from foreign material that might cause tyre slippage. The dynamometer shall be run in the

same coupled or uncoupled state as the subsequent Type 1 test. Chassis dynamometer speed shall be measured from the roller coupled to the power absorption unit.

7.1.1.1.1. Tyre slippage

Additional weight may be placed on or in the vehicle to eliminate tyre slippage. The manufacturer shall perform the load setting on the chassis dynamometer with the additional weight. The additional weight shall be present for both load setting and the emissions and fuel consumption tests. The use of any additional weight shall be recorded.

7.1.1.2. Room temperature

The laboratory atmospheric temperature shall be at a set point of 23 °C and shall not deviate by more than ± 5 °C during the test unless otherwise required by any subsequent test.

7.2. Preparation of chassis dynamometer

7.2.1. Inertia mass setting

The equivalent inertia mass of the chassis dynamometer shall be set according to paragraph 2.5.3. of this annex. If the chassis dynamometer is not capable to meet the inertia setting exactly, the next higher inertia setting shall be applied with a maximum increase of 10 kg.

7.2.2. Chassis dynamometer warm-up

The chassis dynamometer shall be warmed up in accordance with the dynamometer manufacturer's recommendations, or as appropriate, so that the frictional losses of the dynamometer may be stabilized.

7.3. Vehicle preparation

7.3.1. Tyre pressure adjustment

The tyre pressure at the soak temperature of a Type 1 test shall be set to no more than 50 per cent above the lower limit of the tyre pressure range for the selected tyre, as specified by the vehicle manufacturer (see paragraph 4.2.2.3. of this annex), and shall be recorded.

7.3.2. If the determination of dynamometer settings cannot meet the criteria described in paragraph 8.1.3. of this annex due to non-reproducible forces, the vehicle shall be equipped with a vehicle coastdown mode. The vehicle coastdown mode shall be approved by the responsible authority and its use shall be recorded.

If a vehicle is equipped with a vehicle coastdown mode, it shall be engaged both during road load determination and on the chassis dynamometer.

7.3.3. Vehicle placement on the dynamometer

The tested vehicle shall be placed on the chassis dynamometer in a straight ahead position and restrained in a safe manner. In the case that a single roller chassis dynamometer is used, the centre of the tyre's contact patch on the roller shall be within ± 25 mm or ± 2 per cent of the roller diameter, whichever is smaller, from the top of the roller.

If the torque meter method is used, the tyre pressure shall be adjusted such that the dynamic radius is within 0.5 per cent of the dynamic radius r_j calculated using the equations in paragraph 4.4.3.1. of this annex at the 80 km/h reference

speed point. The dynamic radius on the chassis dynamometer shall be calculated according to the procedure described in paragraph 4.4.3.1. of this annex.

If this adjustment is outside the range defined in paragraph 7.3.1. of this annex, the torque meter method shall not apply.

7.3.4. Vehicle warm-up

7.3.4.1. The vehicle shall be warmed up with the applicable WLTC. In the case that the vehicle was warmed up at 90 per cent of the maximum speed of the next higher phase during the procedure defined in paragraph 4.2.4.1.2. of this annex, this higher phase shall be added to the applicable WLTC.

Table A4/7
Vehicle warm-up

| Vehicle class | Applicable WLTC | Adopt next higher phase | Warm-up cycle |
|---------------|--|--|--|
| Class 1 | Low ₁ + Medium ₁ | NA | Low ₁ + Medium ₁ |
| Class 2 | Low ₂ + Medium ₂ + High ₂ + Extra High ₂ | NA | Low ₂ + Medium ₂ + High ₂ + Extra High ₂ |
| | Low ₂ + Medium ₂ + High ₂ | Yes (Extra High ₂) | Low ₂ + Medium ₂ + High ₂ |
| No | | | |
| Class 3 | Low ₃ + Medium ₃ + High ₃ + Extra High ₃ | Low ₃ + Medium ₃ + High ₃ + Extra High ₃ | Low ₃ + Medium ₃ + High ₃ + Extra High ₃ |
| | Low ₃ + Medium ₃ + High ₃ | Yes (Extra High ₃) | Low ₃ + Medium ₃ + High ₃ |
| | | No | |

7.3.4.2. If the vehicle is already warmed up, the WLTC phase applied in paragraph 7.3.4.1. of this annex, with the highest speed, shall be driven.

7.3.4.3. Alternative warm-up procedure

7.3.4.3.1. At the request of the vehicle manufacturer and with approval of the responsible authority, an alternative warm-up procedure may be used. The approved alternative warm-up procedure may be used for vehicles within the same road load family and shall satisfy the requirements outlined in paragraphs 7.3.4.3.2. to 7.3.4.3.5. inclusive of this annex.

7.3.4.3.2. At least one vehicle representing the road load family shall be selected.

7.3.4.3.3. The cycle energy demand calculated according to paragraph 5. of Annex 7 with corrected road load coefficients f_{0a} , f_{1a} and f_{2a} , for the alternative warm-up procedure shall be equal to or higher than the cycle energy demand calculated with the target road load coefficients f_0 , f_1 , and f_2 , for each applicable phase.

The corrected road load coefficients f_{0a} , f_{1a} and f_{2a} , shall be calculated according to the following equations:

$$f_{0a} = f_0 + A_{d,alt} - A_{d,WLTC}$$

$$f_{1a} = f_1 + B_{d,alt} - B_{d,WLTC}$$

$$f_{2a} = f_2 + C_{d,alt} - C_{d,WLTC}$$

where:

A_{d_alt} , B_{d_alt} and C_{d_alt} are the chassis dynamometer setting coefficients after the alternative warm-up procedure;

A_{d_WLTC} , B_{d_WLTC} and C_{d_WLTC} are the chassis dynamometer setting coefficients after a WLTC warm-up procedure described in paragraph 7.3.4.1. of this annex and a valid chassis dynamometer load setting according to paragraph 8. of this annex.

7.3.4.3.4. The corrected road load coefficients f_{0a} , f_{1a} and f_{2a} , shall be used only for the purpose of paragraph 7.3.4.3.3. of this annex. For other purposes, the target road load coefficients f_0 , f_1 and f_2 , shall be used as the target road load coefficients.

7.3.4.3.5. Details of the procedure and of its equivalency shall be provided to the responsible authority.

8. Chassis dynamometer load setting

8.1. Chassis dynamometer load setting using the coastdown method

This method is applicable when the road load coefficients f_0 , f_1 and f_2 have been determined.

In the case of a road load matrix family, this method shall be applied when the road load of the representative vehicle is determined using the coastdown method described in paragraph 4.3. of this annex. The target road load values are the values calculated using the method described in paragraph 5.1. of this annex.

8.1.1. Initial load setting

For a chassis dynamometer with coefficient control, the chassis dynamometer power absorption unit shall be adjusted with the arbitrary initial coefficients, A_d , B_d and C_d , of the following equation:

$$F_d = A_d + B_d v + C_d v^2$$

where:

F_d is the chassis dynamometer setting load, N;

v is the speed of the chassis dynamometer roller, km/h.

The following are recommended coefficients to be used for the initial load setting:

(a) $A_d = 0.5 \times A_t$, $B_d = 0.2 \times B_t$, $C_d = C_t$

for single-axis chassis dynamometers, or

$A_d = 0.1 \times A_t$, $B_d = 0.2 \times B_t$, $C_d = C_t$

for dual-axis chassis dynamometers, where A_t , B_t and C_t are the target road load coefficients;

(b) Empirical values, such as those used for the setting for a similar type of vehicle.

For a chassis dynamometer of polygonal control, adequate load values at each reference speed shall be set to the chassis dynamometer power absorption unit.

8.1.2. Coastdown

The coastdown test on the chassis dynamometer shall be performed with the procedure given in paragraphs 8.1.3.4.1. or 8.1.3.4.2. of this annex and shall start no later than 120 seconds after completion of the warm-up procedure. Consecutive coastdown runs shall be started immediately. At the request of the manufacturer and with approval of the responsible authority, the time between the warm-up procedure and coastdowns using the iterative method may be extended to ensure a proper vehicle setting for the coastdown. The manufacturer shall provide the responsible authority with evidence for requiring additional time and evidence that the chassis dynamometer load setting parameters (e.g. coolant and/or oil temperature, force on a dynamometer) are not affected.

8.1.3. Verification

8.1.3.1. The target road load value shall be calculated using the target road load coefficient, A_t , B_t and C_t , for each reference speed, v_j :

$$F_{tj} = A_t + B_tv_j + C_tv_j^2$$

where:

A_t , B_t and C_t are the target road load parameters;

F_{tj} is the target road load at reference speed v_j , N;

v_j is the j^{th} reference speed, km/h.

8.1.3.2. The measured road load shall be calculated using the following equation:

$$F_{mj} = \frac{1}{3.6} \times (TM + m_r) \times \frac{2 \times \Delta v}{\Delta t_j}$$

where:

Δv is 5 km/h;

F_{mj} is the measured road load for each reference speed v_j , N;

TM is the test mass of the vehicle, kg;

m_r is the equivalent effective mass of rotating components according to paragraph 2.5.1. of this annex, kg;

Δt_j is the coastdown time corresponding to speed v_j , s.

8.1.3.3. The coefficients A_s , B_s and C_s in the road load equation of the simulated road load on the chassis dynamometer shall be calculated using a least squares regression analysis:

$$F_s = A_s + (B_s \times v) + (C_s \times v^2)$$

The simulated road load for each reference speed v_j shall be determined using the following equation, using the calculated A_s , B_s and C_s :

$$F_{sj} = A_s + (B_s \times v_j) + (C_s \times v_j^2)$$

8.1.3.4. For dynamometer load setting, two different methods may be used. If the vehicle is accelerated by the dynamometer, the methods described in paragraph 8.1.3.4.1. of this annex shall be used. If the vehicle is accelerated

under its own power, the methods in paragraphs 8.1.3.4.1. or 8.1.3.4.2. of this annex shall be used and the minimum acceleration multiplied by speed shall be $6 \text{ m}^2/\text{sec}^3$. Vehicles which are unable to achieve $6 \text{ m}^2/\text{s}^3$ shall be driven with the acceleration control fully applied.

8.1.3.4.1. Fixed run method

8.1.3.4.1.1. The dynamometer software shall perform a total of four coastdowns. From the first coastdown, the dynamometer setting coefficients for the second run shall be calculated according to paragraph 8.1.4. of this annex. Following the first coastdown, the software shall perform three additional coastdowns with either the fixed dynamometer setting coefficients determined after the first coastdown or the adjusted dynamometer setting coefficients according to paragraph 8.1.4. of this annex.

8.1.3.4.1.2. The final dynamometer setting coefficients A, B and C shall be calculated using the following equations:

$$A = A_t - \frac{\sum_{n=2}^4 (A_{s_n} - A_{d_n})}{3}$$

$$B = B_t - \frac{\sum_{n=2}^4 (B_{s_n} - B_{d_n})}{3}$$

$$C = C_t - \frac{\sum_{n=2}^4 (C_{s_n} - C_{d_n})}{3}$$

where:

A_t , B_t and C_t are the target road load parameters;

A_{s_n} , B_{s_n} and C_{s_n} are the simulated road load coefficients of the n^{th} run;

A_{d_n} , B_{d_n} and C_{d_n} are the dynamometer setting coefficients of the n^{th} run;

n is the index number of coastdowns including the first stabilisation run.

8.1.3.4.2. Iterative method

The calculated forces in the specified speed ranges shall either be within $\pm 10 \text{ N}$ after a least squares regression of the forces for two consecutive coastdowns when compared with the target values, or additional coastdowns shall be performed after adjusting the chassis dynamometer load setting according to paragraph 8.1.4. of this annex until the tolerance is satisfied.

8.1.4. Adjustment

The chassis dynamometer setting load shall be adjusted according to the following equations:

$$\begin{aligned} F_{dj}^* &= F_{dj} - F_j = F_{dj} - F_{sj} + F_{tj} \\ &= (A_d + B_d v_j + C_d v_j^2) - (A_s + B_s v_j + C_s v_j^2) + (A_t + B_t v_j + C_t v_j^2) \\ &= (A_d + A_t - A_s) + (B_d + B_t - B_s) v_j + (C_d + C_t - C_s) v_j^2 \end{aligned}$$

Therefore:

$$A_d^* = A_d + A_t - A_s$$

$$B_d^* = B_d + B_t - B_s$$

$$C_d^* = C_d + C_t - C_s$$

where:

F_{dj} is the initial chassis dynamometer setting load, N;

F_{dj}^* is the adjusted chassis dynamometer setting load, N;

F_j is the adjustment road load equal to $(F_{sj} - F_{tj})$, N;

F_{sj} is the simulated road load at reference speed v_j , N;

F_{tj} is the target road load at reference speed v_j , N;

A_d^* , B_d^* and C_d^* are the new chassis dynamometer setting coefficients.

8.1.5. A_t , B_t and C_t shall be used as the final values of f_0 , f_1 and f_2 , and shall be used for the following purposes:

- (a) Determination of downscaling, paragraph 8. of Annex 1;
- (b) Determination of gearshift points, Annex 2;
- (c) Interpolation of CO₂ and fuel consumption, paragraph 3.2.3. of Annex 7;
- (d) Calculation of results of electric and hybrid-electric vehicles, paragraph 4. of Annex 8.

8.2. Chassis dynamometer load setting using the torque meter method

This method is applicable when the running resistance is determined using the torque meter method described in paragraph 4.4. of this annex.

In the case of a road load matrix family, this method shall be applied when the running resistance of the representative vehicle is determined using the torque meter method as specified in paragraph 4.4. of this annex. The target running resistance values are the values calculated using the method specified in paragraph 5.1. of this annex.

8.2.1. Initial load setting

For a chassis dynamometer of coefficient control, the chassis dynamometer power absorption unit shall be adjusted with the arbitrary initial coefficients, A_d , B_d and C_d , of the following equation:

$$F_d = A_d + B_d v + C_d v^2$$

where:

F_d is the chassis dynamometer setting load, N;

v is the speed of the chassis dynamometer roller, km/h.

The following coefficients are recommended for the initial load setting:

$$(a) \quad A_d = 0.5 \times \frac{a_t}{r'}, B_d = 0.2 \times \frac{b_t}{r'}, C_d = \frac{c_t}{r'}$$

For single-axis chassis dynamometers, or

$$A_d = 0.1 \times \frac{a_t}{r'}, B_d = 0.2 \times \frac{b_t}{r'}, C_d = \frac{c_t}{r'}$$

For dual-axis chassis dynamometers, where:

a_t , b_t and c_t are the target running resistance coefficients; and

r' is the dynamic radius of the tyre on the chassis dynamometer obtained at 80 km/h, m, or

- (b) Empirical values, such as those used for the setting for a similar type of vehicle.

For a chassis dynamometer of polygonal control, adequate load values at each reference speed shall be set for the chassis dynamometer power absorption unit.

8.2.2. Wheel torque measurement

The torque measurement test on the chassis dynamometer shall be performed with the procedure defined in paragraph 4.4.2. of this annex. The torque meter(s) shall be identical to the one(s) used in the preceding road test.

8.2.3. Verification

- 8.2.3.1. The target running resistance (torque) curve shall be determined using the equation in paragraph 4.5.5.2.1. of this annex and may be written as follows:

$$C_t^* = a_t + b_t \times v_j + c_t \times v_j^2$$

- 8.2.3.2. The simulated running resistance (torque) curve on the chassis dynamometer shall be calculated according to the method described and the measurement precision specified in paragraph 4.4.3.2. of this annex, and the running resistance (torque) curve determination as described in paragraph 4.4.4. of this annex with applicable corrections according to paragraph 4.5. of this annex, all with the exception of measuring in opposite directions, resulting in a simulated running resistance curve:

$$C_s^* = C_{0s} + C_{1s} \times v_j + C_{2s} \times v_j^2$$

The simulated running resistance (torque) shall be within a tolerance of $\pm 10 N \times r'$ from the target running resistance at every speed reference point where r' is the dynamic radius of the tyre in metres on the chassis dynamometer obtained at 80 km/h.

If the tolerance at any reference speed does not satisfy the criterion of the method described in this paragraph, the procedure specified in paragraph 8.2.3.3. of this annex shall be used to adjust the chassis dynamometer load setting.

8.2.3.3. Adjustment

The chassis dynamometer load setting shall be adjusted using the following equation:

$$\begin{aligned} F_{dj}^* &= F_{dj} - \frac{F_{ej}}{r'} = F_{dj} - \frac{F_{sj}}{r'} + \frac{F_{tj}}{r'} \\ &= (A_d + B_d v_j + C_d v_j^2) - \frac{(a_s + b_s v_j + c_s v_j^2)}{r'} + \frac{(a_t + b_t v_j + c_t v_j^2)}{r'} \\ &= \left\{ A_d + \frac{(a_t - a_s)}{r'} \right\} + \left\{ B_d + \frac{(b_t - b_s)}{r'} \right\} v_j + \left\{ C_d + \frac{(c_t - c_s)}{r'} \right\} v_j^2 \end{aligned}$$

therefore:

$$A_d^* = A_d + \frac{a_t - a_s}{r'}$$

$$B_d^* = B_d + \frac{b_t - b_s}{r'}$$

$$C_d^* = C_d + \frac{c_t - c_s}{r'}$$

where:

- F_{dj}^* is the new chassis dynamometer setting load, N;
 F_{ej} is the adjustment road load equal to $(F_{sj} - F_{tj})$, Nm;
 F_{sj} is the simulated road load at reference speed v_j , Nm;
 F_{tj} is the target road load at reference speed v_j , Nm;
 A_d^* , B_d^* and C_d^* are the new chassis dynamometer setting coefficients;
 r' is the dynamic radius of the tyre on the chassis dynamometer obtained at 80 km/h, m.

Paragraphs 8.2.2. and 8.2.3. of this annex shall be repeated until the tolerance in paragraph 8.2.3.2. of this annex is met.

8.2.3.4. The mass of the driven axle(s), tyre specifications and chassis dynamometer load setting shall be recorded when the requirement of paragraph 8.2.3.2. of this annex is fulfilled.

8.2.4. Transforming running resistance coefficients to road load coefficients f_0 , f_1 , f_2

8.2.4.1 If the vehicle does not coast down in a repeatable manner and a vehicle coastdown mode according to paragraph 4.2.1.8.5. of this annex is not feasible, the coefficients f_0 , f_1 and f_2 in the road load equation shall be calculated using the equations in paragraph 8.2.4.1.1. of this annex. In any other case, the procedure described in paragraphs 8.2.4.2. to 8.2.4.4. inclusive of this annex shall be performed.

8.2.4.1.1. $f_0 = \frac{c_0}{r} \times 1.02$

$$f_1 = \frac{c_1}{r} \times 1.02$$

$$f_2 = \frac{c_2}{r} \times 1.02$$

where:

c_0 , c_1 , c_2 are the running resistance coefficients determined in paragraph 4.4.4. of this annex, Nm, Nm/(km/h), Nm/(km/h)²;

r is the dynamic tyre radius of the vehicle with which the running resistance was determined, m;

1.02 is an approximate coefficient compensating for drivetrain losses.

8.2.4.1.2. The determined f_0 , f_1 , f_2 values shall not be used for a chassis dynamometer setting or any emission or range testing. They shall be used only in the following cases:

- (a) Determination of downscaling, paragraph 8. of Annex 1;
- (b) Determination of gearshift points, Annex 2;
- (c) Interpolation of CO₂ and fuel consumption, paragraph 3.2.3 of Annex 7;
- (d) Calculation of results of electric and hybrid-electric vehicles, paragraph 4. of Annex 8.

8.2.4.2. Once the chassis dynamometer has been set within the specified tolerances, a vehicle coastdown procedure shall be performed on the chassis dynamometer as outlined in paragraph 4.3.1.3. of this annex. The coastdown times shall be recorded.

8.2.4.3. The road load F_j at reference speed v_j , N, shall be determined using the following equation:

$$F_j = \frac{1}{3.6} \times (TM + m_r) \times \frac{2 \times \Delta v}{\Delta t_j}$$

where:

F_j is the road load at reference speed v_j , N;

TM is the test mass of the vehicle, kg;

m_r is the equivalent effective mass of rotating components according to paragraph 2.5.1. of this annex, kg;

$\Delta v = 5$ km/h

Δt_j is the coastdown time corresponding to speed v_j , s.

8.2.4.4. The coefficients f_0 , f_1 and f_2 in the road load equation shall be calculated with a least squares regression analysis over the reference speed range.

Annex 5

Test equipment and calibrations

1. Test bench specifications and settings
 - 1.1. Cooling fan specifications
 - 1.1.1. A variable speed current of air shall be blown towards the vehicle. The set point of the linear velocity of the air at the blower outlet shall be equal to the corresponding roller speed above roller speeds of 5 km/h. The linear velocity of the air at the blower outlet shall be within ± 5 km/h or ± 10 per cent of the corresponding roller speed, whichever is greater.
 - 1.1.2. The above-mentioned air velocity shall be determined as an averaged value of a number of measuring points that:
 - (a) For fans with rectangular outlets, are located at the centre of each rectangle dividing the whole of the fan outlet into 9 areas (dividing both horizontal and vertical sides of the fan outlet into 3 equal parts). The centre area shall not be measured (as shown in Figure A5/1);

Figure A5/1

Fan with rectangular outlet

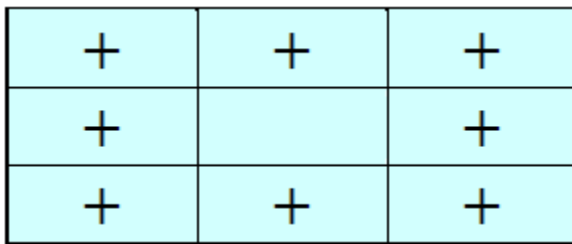

- (b) For fans with circular outlets, the outlet shall be divided into 8 equal sectors by vertical, horizontal and 45° lines. The measurement points shall lie on the radial centre line of each sector (22.5°) at two-thirds of the outlet radius (as shown in Figure A5/2).

Figure A5/2

Fan with circular outlet

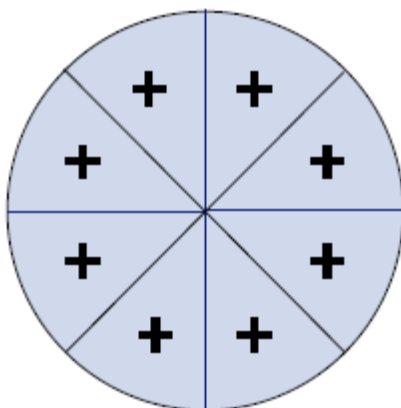

These measurements shall be made with no vehicle or other obstruction in front of the fan. The device used to measure the linear velocity of the air shall be located between 0 and 20 cm from the air outlet.

- 1.1.3. The outlet of the fan shall have the following characteristics:
- (a) An area of at least 0.3 m²; and
 - (b) A width/diameter of at least 0.8 metre.
- 1.1.4. The position of the fan shall be as follows:
- (a) Height of the lower edge above ground: approximately 20 cm;
 - (b) Distance from the front of the vehicle: approximately 30 cm;
 - (c) Approximately on the longitudinal centreline of the vehicle.
- 1.1.5. At the request of the manufacturer and if considered appropriate by the responsible authority, the height, lateral position and distance from the vehicle of the cooling fan may be modified.

If the specified fan configuration is impractical for special vehicle designs, such as vehicles with rear-mounted engines or side air intakes, or it does not provide adequate cooling to properly represent in-use operation, at the request of the manufacturer and if considered appropriate by the responsible authority, the height, capacity, longitudinal and lateral position of the cooling fan may be modified and additional fans which may have different specifications (including constant speed fans) may be used.

- 1.1.6. In the cases described in paragraph 1.1.5. of this annex, the position and capacity of the cooling fan(s) and details of the justification supplied to the responsible authority shall be recorded. For any subsequent testing, similar positions and specifications shall be used in consideration of the justification to avoid non-representative cooling characteristics.

2. Chassis dynamometer

2.1. General requirements

- 2.1.1. The dynamometer shall be capable of simulating road load with three road load coefficients that can be adjusted to shape the load curve.

- 2.1.2. The chassis dynamometer may have a single or twin-roller configuration. In the case that twin-roller chassis dynamometers are used, the rollers shall be permanently coupled or the front roller shall drive, directly or indirectly, any inertial masses and the power absorption device.

2.2. Specific requirements

The following specific requirements relate to the dynamometer manufacturer's specifications.

- 2.2.1. The roller run-out shall be less than 0.25 mm at all measured locations.
- 2.2.2. The roller diameter shall be within ± 1.0 mm of the specified nominal value at all measurement locations.
- 2.2.3. The dynamometer shall have a time measurement system for use in determining acceleration rates and for measuring vehicle/dynamometer coastdown times. This time measurement system shall not exceed an accuracy of ± 0.001 per cent after at least 1,000 seconds of operation. This shall be verified upon initial installation.

- 2.2.4. The dynamometer shall have a speed measurement system with an accuracy of at least ± 0.080 km/h. This shall be verified upon initial installation.
- 2.2.5. The dynamometer shall have a response time (90 per cent response to a tractive effort step change) of less than 100 ms with instantaneous accelerations that are at least 3 m/s^2 . This shall be verified upon initial installation and after major maintenance.
- 2.2.6. The base inertia of the dynamometer shall be stated by the dynamometer manufacturer and shall be confirmed to within ± 1.0 per cent for each measured base inertia and ± 0.2 per cent relative to any arithmetic average value by dynamic derivation from trials at constant acceleration, deceleration and force.
- 2.2.7. Roller speed shall be measured at a frequency of not less than 10 Hz.
- 2.3. Additional specific requirements for chassis dynamometers for vehicles to be tested in four wheel drive (4WD) mode
 - 2.3.1. The 4WD control system shall be designed such that the following requirements are fulfilled when tested with a vehicle driven over the WLTC.
 - 2.3.1.1. Road load simulation shall be applied such that operation in 4WD mode reproduces the same proportioning of forces as would be encountered when driving the vehicle on a smooth, dry, level road surface.
 - 2.3.1.2. Upon initial installation and after major maintenance, the requirements of paragraph 2.3.1.2.1. of this annex and of either paragraph 2.3.1.2.2. or 2.3.1.2.3. of this annex shall be satisfied. The speed difference between the front and rear rollers shall be assessed by applying a 1 second moving average filter to roller speed data acquired at a minimum frequency of 20 Hz.
 - 2.3.1.2.1. The difference in distance covered by the front and rear rollers shall be less than 0.2 per cent of the distance driven over the WLTC. The absolute number shall be integrated for the calculation of the total difference in distance over the WLTC.
 - 2.3.1.2.2. The difference in distance covered by the front and rear rollers shall be less than 0.1 m in any 200 ms time period.
 - 2.3.1.2.3. The speed difference of all roller speeds shall be within ± 0.16 km/h.
 - 2.4. Chassis dynamometer calibration
 - 2.4.1. Force measurement system

The accuracy of the force transducer shall be at least ± 10 N for all measured increments. This shall be verified upon initial installation, after major maintenance and within 370 days before testing.
 - 2.4.2. Dynamometer parasitic loss calibration

The dynamometer's parasitic losses shall be measured and updated if any measured value differs from the current loss curve by more than 9.0 N. This shall be verified upon initial installation, after major maintenance and within 35 days before testing.
 - 2.4.3. Verification of road load simulation without a vehicle

The dynamometer performance shall be verified by performing an unloaded coastdown test upon initial installation, after major maintenance, and within 7 days before testing. The arithmetic average coastdown force error shall be less than 10 N or 2 per cent, whichever is greater, at each reference speed point.

3. Exhaust gas dilution system
 - 3.1. System specification
 - 3.1.1. Overview
 - 3.1.1.1. A full flow exhaust dilution system shall be used. The total vehicle exhaust shall be continuously diluted with ambient air under controlled conditions using a constant volume sampler. A critical flow venturi (CFV) or multiple critical flow venturis arranged in parallel, a positive displacement pump (PDP), a subsonic venturi (SSV), or an ultrasonic flow meter (UFM) may be used. The total volume of the mixture of exhaust and dilution air shall be measured and a continuously proportional sample of the volume shall be collected for analysis. The quantities of exhaust gas compounds shall be determined from the sample concentrations, corrected for their respective content of the dilution air and the totalised flow over the test period.
 - 3.1.1.2. The exhaust dilution system shall consist of a connecting tube, a mixing device and dilution tunnel, dilution air conditioning, a suction device and a flow measurement device. Sampling probes shall be fitted in the dilution tunnel as specified in paragraphs 4.1., 4.2. and 4.3. of this annex.
 - 3.1.1.3. The mixing device referred to in paragraph 3.1.1.2. of this annex shall be a vessel such as that illustrated in Figure A5/3 in which vehicle exhaust gases and the dilution air are combined so as to produce a homogeneous mixture at the sampling position.
 - 3.2. General requirements
 - 3.2.1. The vehicle exhaust gases shall be diluted with a sufficient amount of ambient air to prevent any water condensation in the sampling and measuring system at all conditions that may occur during a test.
 - 3.2.2. The mixture of air and exhaust gases shall be homogeneous at the point where the sampling probes are located (see paragraph 3.3.3. of this annex). The sampling probes shall extract representative samples of the diluted exhaust gas.
 - 3.2.3. The system shall enable the total volume of the diluted exhaust gases to be measured.
 - 3.2.4. The sampling system shall be gas-tight. The design of the variable dilution sampling system and the materials used in its construction shall be such that the concentration of any compound in the diluted exhaust gases is not affected. If any component in the system (heat exchanger, cyclone separator, suction device, etc.) changes the concentration of any of the exhaust gas compounds and the systematic error cannot be corrected, sampling for that compound shall be carried out upstream from that component.
 - 3.2.5. All parts of the dilution system in contact with raw or diluted exhaust gas shall be designed to minimise deposition or alteration of the particulate or particles. All parts shall be made of electrically conductive materials that do not react with exhaust gas components, and shall be electrically grounded to prevent electrostatic effects.
 - 3.2.6. If the vehicle being tested is equipped with an exhaust pipe comprising several branches, the connecting tubes shall be connected as near as possible to the vehicle without adversely affecting their operation.

- 3.3. Specific requirements
- 3.3.1. Connection to vehicle exhaust
- 3.3.1.1. The start of the connecting tube is the exit of the tailpipe. The end of the connecting tube is the sample point, or first point of dilution.
- For multiple tailpipe configurations where all the tailpipes are combined, the start of the connecting tube shall be taken at the last joint of where all the tailpipes are combined. In this case, the tube between the exit of the tailpipe and the start of the connecting tube may or may not be insulated or heated.
- 3.3.1.2. The connecting tube between the vehicle and dilution system shall be designed so as to minimize heat loss.
- 3.3.1.3. The connecting tube shall satisfy the following requirements:
- (a) Be less than 3.6 metres long, or less than 6.1 metres long if heat-insulated. Its internal diameter shall not exceed 105 mm; the insulating materials shall have a thickness of at least 25 mm and thermal conductivity shall not exceed $0.1 \text{ W/m}^1\text{K}^{-1}$ at $400 \text{ }^\circ\text{C}$. Optionally, the tube may be heated to a temperature above the dew point. This may be assumed to be achieved if the tube is heated to $70 \text{ }^\circ\text{C}$;
 - (b) Not cause the static pressure at the exhaust outlets on the vehicle being tested to differ by more than $\pm 0.75 \text{ kPa}$ at 50 km/h , or more than $\pm 1.25 \text{ kPa}$ for the duration of the test from the static pressures recorded when nothing is connected to the vehicle exhaust pipes. The pressure shall be measured in the exhaust outlet or in an extension having the same diameter and as near as possible to the end of the tailpipe. Sampling systems capable of maintaining the static pressure to within $\pm 0.25 \text{ kPa}$ may be used if a written request from a manufacturer to the responsible authority substantiates the need for the tighter tolerance;
 - (c) No component of the connecting tube shall be of a material that might affect the gaseous or solid composition of the exhaust gas. To avoid generation of any particles from elastomer connectors, elastomers employed shall be as thermally stable as possible and have minimum exposure to the exhaust gas. It is recommended not to use elastomer connectors to bridge the connection between the vehicle exhaust and the connecting tube.
- 3.3.2. Dilution air conditioning
- 3.3.2.1. The dilution air used for the primary dilution of the exhaust in the CVS tunnel shall pass through a medium capable of reducing particles of the most penetrating particle size in the filter material by ≤ 99.95 per cent, or through a filter of at least Class H13 of EN 1822:2009. This represents the specification of High Efficiency Particulate Air (HEPA) filters. The dilution air may optionally be charcoal-scrubbed before being passed to the HEPA filter. It is recommended that an additional coarse particle filter be situated before the HEPA filter and after the charcoal scrubber, if used.
- 3.3.2.2. At the vehicle manufacturer's request, the dilution air may be sampled according to good engineering practice to determine the tunnel contribution to background particulate and, if applicable, particle levels, which can be subsequently subtracted from the values measured in the diluted exhaust. See paragraph 2.1.3. of Annex 6.

- 3.3.3. Dilution tunnel
- 3.3.3.1. Provision shall be made for the vehicle exhaust gases and the dilution air to be mixed. A mixing device may be used.
- 3.3.3.2. The homogeneity of the mixture in any cross-section at the location of the sampling probe shall not vary by more than ± 2 per cent from the arithmetic average of the values obtained for at least five points located at equal intervals on the diameter of the gas stream.
- 3.3.3.3. For PM and PN (if applicable) emissions sampling, a dilution tunnel shall be used that:
- Consists of a straight tube of electrically-conductive material that is grounded;
 - Causes turbulent flow (Reynolds number $\geq 4,000$) and be of sufficient length to cause complete mixing of the exhaust and dilution air;
 - Is at least 200 mm in diameter;
 - May be insulated and/or heated.
- 3.3.4. Suction device
- 3.3.4.1. This device may have a range of fixed speeds to ensure sufficient flow to prevent any water condensation. This result is obtained if the flow is either:
- Twice as high as the maximum flow of exhaust gas produced by accelerations of the driving cycle; or
 - Sufficient to ensure that the CO₂ concentration in the dilute exhaust sample bag is less than 3 per cent by volume for petrol and diesel, less than 2.2 per cent by volume for LPG and less than 1.5 per cent by volume for NG/biomethane.
- 3.3.4.2. Compliance with the requirements in paragraph 3.3.4.1. of this annex may not be necessary if the CVS system is designed to inhibit condensation by such techniques, or combination of techniques, as:
- Reducing water content in the dilution air (dilution air dehumidification);
 - Heating of the CVS dilution air and of all components up to the diluted exhaust flow measurement device and, optionally, the bag sampling system including the sample bags and also the system for the measurement of the bag concentrations.
- In such cases, the selection of the CVS flow rate for the test shall be justified by showing that condensation of water cannot occur at any point within the CVS, bag sampling or analytical system.
- 3.3.5. Volume measurement in the primary dilution system
- 3.3.5.1. The method of measuring total dilute exhaust volume incorporated in the constant volume sampler shall be such that measurement is accurate to ± 2 per cent under all operating conditions. If the device cannot compensate for variations in the temperature of the mixture of exhaust gases and dilution air at the measuring point, a heat exchanger shall be used to maintain the temperature to within ± 6 °C of the specified operating temperature for a PDP CVS, ± 11 °C for a CFV CVS, ± 6 °C for a UFM CVS, and ± 11 °C for an SSV CVS.

- 3.3.5.2. If necessary, some form of protection for the volume measuring device may be used e.g. a cyclone separator, bulk stream filter, etc.
- 3.3.5.3. A temperature sensor shall be installed immediately before the volume measuring device. This temperature sensor shall have an accuracy of ± 1 °C and a response time of 1 second or less at 62 per cent of a given temperature variation (value measured in water or silicone oil).
- 3.3.5.4. Measurement of the pressure difference from atmospheric pressure shall be taken upstream from and, if necessary, downstream from the volume measuring device.
- 3.3.5.5. The pressure measurements shall have a precision and an accuracy of ± 0.4 kPa during the test. See Table A5/5.

3.3.6. Recommended system description

Figure A5/3 is a schematic drawing of exhaust dilution systems that meet the requirements of this annex.

The following components are recommended:

- (a) A dilution air filter, which may be pre-heated if necessary. This filter shall consist of the following filters in sequence: an optional activated charcoal filter (inlet side), and a HEPA filter (outlet side). It is recommended that an additional coarse particle filter be situated before the HEPA filter and after the charcoal filter, if used. The purpose of the charcoal filter is to reduce and stabilize the hydrocarbon concentrations of ambient emissions in the dilution air;
- (b) A connecting tube by which vehicle exhaust is admitted into a dilution tunnel;
- (c) An optional heat exchanger as described in paragraph 3.3.5.1. of this annex;
- (d) A mixing device in which exhaust gas and dilution air are mixed homogeneously, and which may be located close to the vehicle so that the length of the connecting tube is minimized;
- (e) A dilution tunnel from which particulate and, if applicable, particles are sampled;
- (f) Some form of protection for the measurement system may be used e.g. a cyclone separator, bulk stream filter, etc.;
- (g) A suction device of sufficient capacity to handle the total volume of diluted exhaust gas.

Exact conformity with these figures is not essential. Additional components such as instruments, valves, solenoids and switches may be used to provide additional information and co-ordinate the functions of the component system.

Figure A5/3
Exhaust dilution system

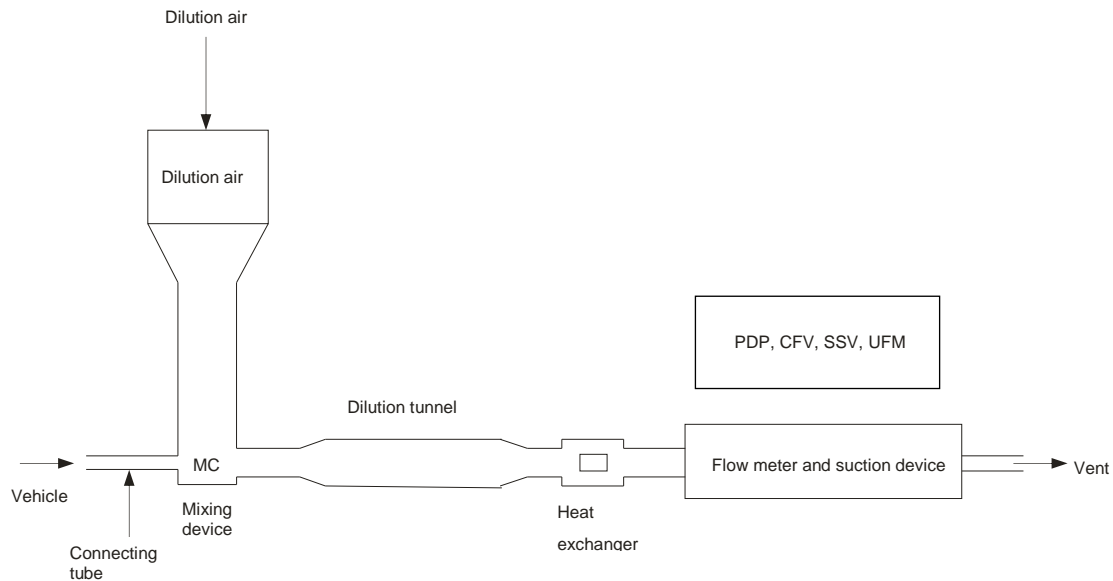

3.3.6.1. Positive displacement pump (PDP)

A positive displacement pump (PDP) full flow exhaust dilution system satisfies the requirements of this annex by metering the flow of gas through the pump at constant temperature and pressure. The total volume is measured by counting the revolutions made by the calibrated positive displacement pump. The proportional sample is achieved by sampling with pump, flow meter and flow control valve at a constant flow rate.

3.3.6.2. Critical flow venturi (CFV)

3.3.6.2.1. The use of a CFV for the full flow exhaust dilution system is based on the principles of flow mechanics for critical flow. The variable mixture flow rate of dilution and exhaust gas is maintained at sonic velocity that is directly proportional to the square root of the gas temperature. Flow is continually monitored, computed and integrated throughout the test.

3.3.6.2.2. The use of an additional critical flow sampling venturi ensures the proportionality of the gas samples taken from the dilution tunnel. As both pressure and temperature are equal at the two venturi inlets, the volume of the gas flow diverted for sampling is proportional to the total volume of diluted exhaust gas mixture produced, and thus the requirements of this annex are fulfilled.

3.3.6.2.3. A measuring CFV tube shall measure the flow volume of the diluted exhaust gas.

3.3.6.3. Subsonic flow venturi (SSV)

3.3.6.3.1. The use of an SSV (Figure A5/4) for a full flow exhaust dilution system is based on the principles of flow mechanics. The variable mixture flow rate of dilution and exhaust gas is maintained at a subsonic velocity that is calculated from the physical dimensions of the subsonic venturi and measurement of the absolute temperature (T) and pressure (P) at the venturi inlet and the pressure in the throat of the venturi. Flow is continually monitored, computed and integrated throughout the test.

3.3.6.3.2. An SSV shall measure the flow volume of the diluted exhaust gas.

Figure A5/4

Schematic of a subsonic venturi tube (SSV)

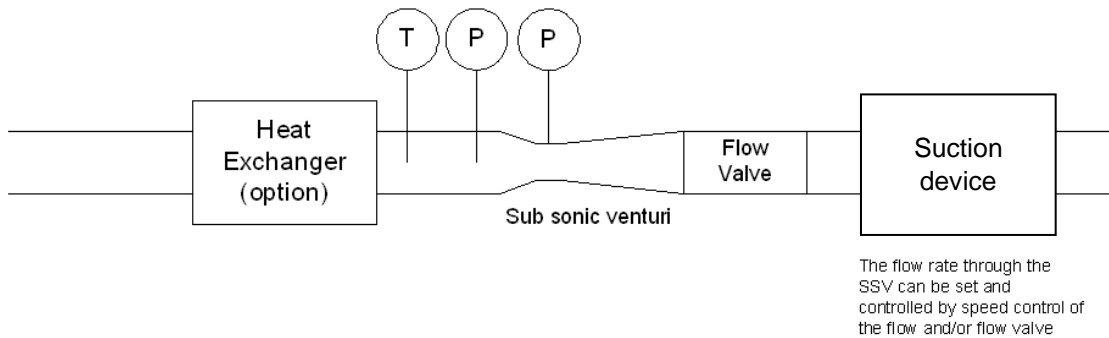

3.3.6.4. Ultrasonic flow meter (UFM)

3.3.6.4.1. A UFM measures the velocity of the diluted exhaust gas in the CVS piping using the principle of ultrasonic flow detection by means of a pair, or multiple pairs, of ultrasonic transmitters/receivers mounted within the pipe as in Figure A5/5. The velocity of the flowing gas is determined by the difference in the time required for the ultrasonic signal to travel from transmitter to receiver in the upstream direction and the downstream direction. The gas velocity is converted to standard volumetric flow using a calibration factor for the tube diameter with real time corrections for the diluted exhaust temperature and absolute pressure.

3.3.6.4.2. Components of the system include:

- (a) A suction device fitted with speed control, flow valve or other method for setting the CVS flow rate and also for maintaining constant volumetric flow at standard conditions;
- (b) A UFM;
- (c) Temperature and pressure measurement devices, T and P, required for flow correction;
- (d) An optional heat exchanger for controlling the temperature of the diluted exhaust to the UFM. If installed, the heat exchanger shall be capable of controlling the temperature of the diluted exhaust to that specified in paragraph 3.3.5.1. of this annex. Throughout the test, the temperature of the air/exhaust gas mixture measured at a point immediately upstream of the suction device shall be within ± 6 °C of the arithmetic average operating temperature during the test.

Figure A5/5

Schematic of an ultrasonic flow meter (UFM)

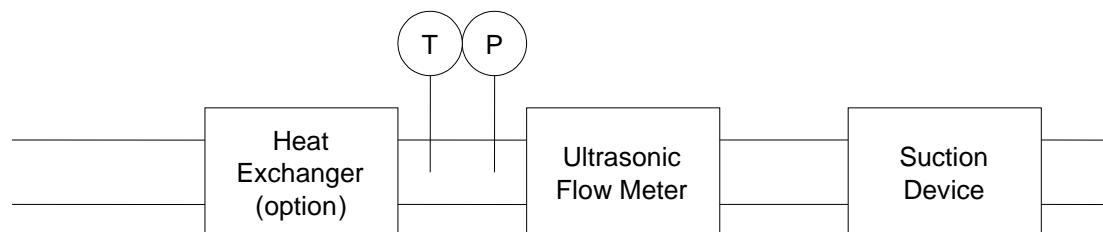

- 3.3.6.4.3. The following conditions shall apply to the design and use of the UFM type CVS:
- (a) The velocity of the diluted exhaust gas shall provide a Reynolds number higher than 4,000 in order to maintain a consistent turbulent flow before the ultrasonic flow meter;
 - (b) An ultrasonic flow meter shall be installed in a pipe of constant diameter with a length of 10 times the internal diameter upstream and 5 times the diameter downstream;
 - (c) A temperature sensor (T) for the diluted exhaust shall be installed immediately before the ultrasonic flow meter. This sensor shall have an accuracy of ± 1 °C and a response time of 0.1 seconds at 62 per cent of a given temperature variation (value measured in silicone oil);
 - (d) The absolute pressure (P) of the diluted exhaust shall be measured immediately before the ultrasonic flow meter to within ± 0.3 kPa;
 - (e) If a heat exchanger is not installed upstream of the ultrasonic flow meter, the flow rate of the diluted exhaust, corrected to standard conditions, shall be maintained at a constant level during the test. This may be achieved by control of the suction device, flow valve or other method.
- 3.4. CVS calibration procedure
- 3.4.1. General requirements
- 3.4.1.1. The CVS system shall be calibrated by using an accurate flow meter and a restricting device and at the intervals listed in Table A5/4. The flow through the system shall be measured at various pressure readings and the control parameters of the system measured and related to the flows. The flow metering device (e.g. calibrated venturi, laminar flow element (LFE), calibrated turbine meter) shall be dynamic and suitable for the high flow rate encountered in constant volume sampler testing. The device shall be of certified accuracy.
- 3.4.1.2. The following paragraphs describe methods for calibrating PDP, CFV, SSV and UFM units using a laminar flow meter, which gives the required accuracy, along with a statistical check on the calibration validity.
- 3.4.2. Calibration of a positive displacement pump (PDP)
- 3.4.2.1. The following calibration procedure outlines the equipment, the test configuration and the various parameters that are measured to establish the flow rate of the CVS pump. All the parameters related to the pump are simultaneously measured with the parameters related to the flow meter that is connected in series with the pump. The calculated flow rate (given in m³/min at pump inlet for the measured absolute pressure and temperature) shall be subsequently plotted versus a correlation function that includes the relevant pump parameters. The linear equation that relates the pump flow and the correlation function shall be subsequently determined. In the case that a CVS has a multiple speed drive, a calibration for each range used shall be performed.

- 3.4.2.2. This calibration procedure is based on the measurement of the absolute values of the pump and flow meter parameters relating the flow rate at each point. The following conditions shall be maintained to ensure the accuracy and integrity of the calibration curve:
- 3.4.2.2.1. The pump pressures shall be measured at tapplings on the pump rather than at the external piping on the pump inlet and outlet. Pressure taps that are mounted at the top centre and bottom centre of the pump drive head plate are exposed to the actual pump cavity pressures, and therefore reflect the absolute pressure differentials.
- 3.4.2.2.2. Temperature stability shall be maintained during the calibration. The laminar flow meter is sensitive to inlet temperature oscillations that cause data points to be scattered. Gradual changes of ± 1 °C in temperature are acceptable as long as they occur over a period of several minutes.
- 3.4.2.2.3. All connections between the flow meter and the CVS pump shall be free of leakage.
- 3.4.2.3. During an exhaust emissions test, the measured pump parameters shall be used to calculate the flow rate from the calibration equation.
- 3.4.2.4. Figure A5/6 of this annex shows an example of a calibration set-up. Variations are permissible, provided that the responsible authority approves them as being of comparable accuracy. If the set-up shown in Figure A5/6 is used, the following data shall be found within the limits of accuracy given:

| | |
|--|---------------------------|
| Barometric pressure (corrected), P_b | ± 0.03 kPa |
| Ambient temperature, T | ± 0.2 °C |
| Air temperature at LFE, ETI | ± 0.15 °C |
| Pressure depression upstream of LFE, EPI | ± 0.01 kPa |
| Pressure drop across the LFE matrix, EDP | ± 0.0015 kPa |
| Air temperature at CVS pump inlet, PTI | ± 0.2 °C |
| Air temperature at CVS pump outlet, PTO | ± 0.2 °C |
| Pressure depression at CVS pump inlet, PPI | ± 0.22 kPa |
| Pressure head at CVS pump outlet, PPO | ± 0.22 kPa |
| Pump revolutions during test period, n | ± 1 min ⁻¹ |
| Elapsed time for period (minimum 250 s), t | ± 0.1 s |

Figure A5/6
PDP calibration configuration

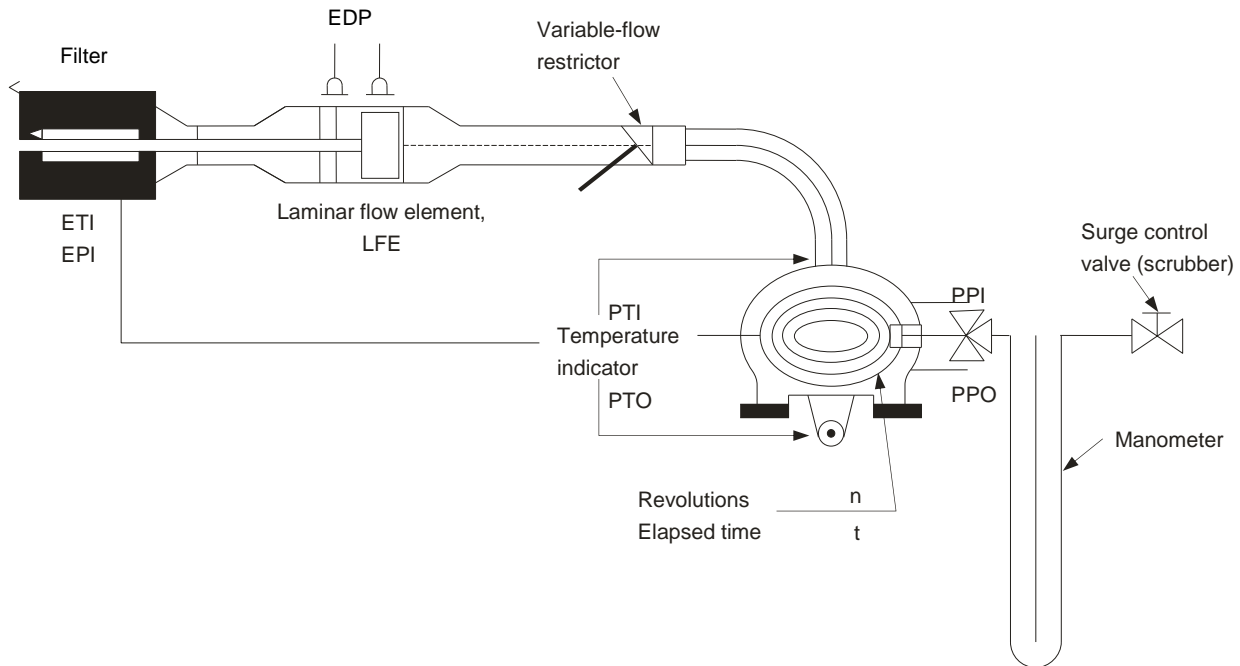

- 3.4.2.5. After the system has been connected as shown in Figure A5/6, the variable restrictor shall be set in the wide-open position and the CVS pump shall run for 20 minutes before starting the calibration.
- 3.4.2.5.1. The restrictor valve shall be reset to a more restricted condition in increments of pump inlet depression (about 1 kPa) that will yield a minimum of six data points for the total calibration. The system shall be allowed to stabilize for 3 minutes before the data acquisition is repeated.
- 3.4.2.5.2. The air flow rate Q_s at each test point shall be calculated in standard m^3/min from the flow meter data using the manufacturer's prescribed method.
- 3.4.2.5.3. The air flow rate shall be subsequently converted to pump flow V_0 in m^3/rev at absolute pump inlet temperature and pressure.

$$V_0 = \frac{Q_s}{n} \times \frac{T_p}{273.15 \text{ K}} \times \frac{101.325 \text{ kPa}}{P_p}$$

where:

- V_0 is the pump flow rate at T_p and P_p , m^3/rev ;
- Q_s is the air flow at 101.325 kPa and 273.15 K (0 °C), m^3/min ;
- T_p is the pump inlet temperature, Kelvin (K);
- P_p is the absolute pump inlet pressure, kPa;
- n is the pump speed, min^{-1} .

- 3.4.2.5.4. To compensate for the interaction of pump speed pressure variations at the pump and the pump slip rate, the correlation function x_0 between the pump speed n , the pressure differential from pump inlet to pump outlet and the absolute pump outlet pressure shall be calculated using the following equation:

$$x_0 = \frac{1}{n} \sqrt{\frac{\Delta P_p}{P_e}}$$

where:

x_0 is the correlation function;

ΔP_p is the pressure differential from pump inlet to pump outlet, kPa;

P_e absolute outlet pressure ($PPO + P_b$), kPa.

A linear least squares fit shall be performed to generate the calibration equations having the following form:

$$V_0 = D_0 - M \times x_0$$

$$n = A - B \times \Delta P_p$$

where B and M are the slopes, and A and D_0 are the intercepts of the lines.

- 3.4.2.6. A CVS system having multiple speeds shall be calibrated at each speed used. The calibration curves generated for the ranges shall be approximately parallel and the intercept values D_0 shall increase as the pump flow range decreases.
- 3.4.2.7. The calculated values from the equation shall be within 0.5 per cent of the measured value of V_0 . Values of M will vary from one pump to another. A calibration shall be performed at initial installation and after major maintenance.
- 3.4.3. Calibration of a critical flow venturi (CFV)
- 3.4.3.1. Calibration of a CFV is based upon the flow equation for a critical venturi:

$$Q_s = \frac{K_v P}{\sqrt{T}}$$

where:

Q_s is the flow, m³/min;

K_v is the calibration coefficient;

P is the absolute pressure, kPa;

T is the absolute temperature, Kelvin (K).

Gas flow is a function of inlet pressure and temperature.

The calibration procedure described in paragraphs 3.4.3.2. to 3.4.3.3.4. inclusive of this annex establishes the value of the calibration coefficient at measured values of pressure, temperature and air flow.

3.4.3.2. Measurements for flow calibration of a critical flow venturi are required and the following data shall be within the limits of accuracy given:

| | |
|--|---------------------|
| Barometric pressure (corrected), P_b | ± 0.03 kPa, |
| LFE air temperature, flow meter, ETI | ± 0.15 °C, |
| Pressure depression upstream of LFE, EPI | ± 0.01 kPa, |
| Pressure drop across LFE matrix, EDP | ± 0.0015 kPa, |
| Air flow, Q_s | ± 0.5 per cent, |
| CFV inlet depression, PPI | ± 0.02 kPa, |
| Temperature at venturi inlet, T_v | ± 0.2 °C. |

3.4.3.3. The equipment shall be set up as shown in Figure A5/7 and checked for leaks. Any leaks between the flow-measuring device and the critical flow venturi will seriously affect the accuracy of the calibration and shall therefore be prevented.

Figure A5/7

CFV calibration configuration

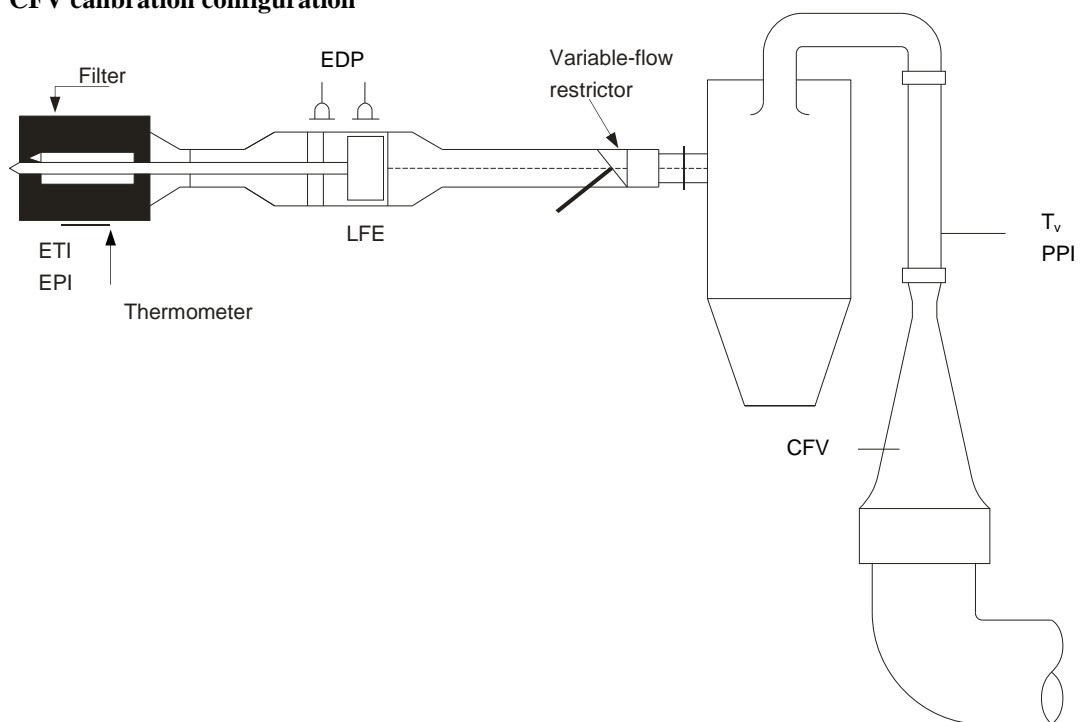

3.4.3.3.1. The variable-flow restrictor shall be set to the open position, the suction device shall be started and the system stabilized. Data from all instruments shall be collected.

3.4.3.3.2. The flow restrictor shall be varied and at least eight readings across the critical flow range of the venturi shall be made.

3.4.3.3.3. The data recorded during the calibration shall be used in the following calculation:

3.4.3.3.3.1. The air flow rate Q_s at each test point shall be calculated from the flow meter data using the manufacturer's prescribed method.

Values of the calibration coefficient shall be calculated for each test point:

$$K_v = \frac{Q_s \sqrt{T_v}}{P_v}$$

where:

Q_s is the flow rate, m³/min at 273.15 K (0 °C) and 101.325, kPa;

T_v is the temperature at the venturi inlet, Kelvin (K);

P_v is the absolute pressure at the venturi inlet, kPa.

3.4.3.3.3.2. K_v shall be plotted as a function of venturi inlet pressure P_v . For sonic flow K_v will have a relatively constant value. As pressure decreases (vacuum increases), the venturi becomes unchoked and K_v decreases. These values of K_v shall not be used for further calculations.

3.4.3.3.3.3. For a minimum of eight points in the critical region, an arithmetic average K_v and the standard deviation shall be calculated.

3.4.3.3.3.4. If the standard deviation exceeds 0.3 per cent of the arithmetic average K_v , corrective action shall be taken.

3.4.4. Calibration of a subsonic venturi (SSV)

3.4.4.1. Calibration of the SSV is based upon the flow equation for a subsonic venturi. Gas flow is a function of inlet pressure and temperature, and the pressure drop between the SSV inlet and throat.

3.4.4.2. Data analysis

3.4.4.2.1. The airflow rate, Q_{SSV} , at each restriction setting (minimum 16 settings) shall be calculated in standard m³/s from the flow meter data using the manufacturer's prescribed method. The discharge coefficient C_d shall be calculated from the calibration data for each setting using the following equation:

$$C_d = \frac{Q_{SSV}}{d_v^2 \times p_p \times \sqrt{\left\{ \frac{1}{T} \times (r_p^{1.426} - r_p^{1.713}) \times \left(\frac{1}{1 - r_D^4 \times r_p^{1.426}} \right) \right\}}}$$

where:

Q_{SSV} is the airflow rate at standard conditions (101.325 kPa, 273.15 K (0 °C)), m³/s;

T is the temperature at the venturi inlet, Kelvin (K);

d_v is the diameter of the SSV throat, m;

r_p is the ratio of the SSV throat pressure to inlet absolute static pressure, $1 - \frac{\Delta p}{p_p}$;

r_D is the ratio of the SSV throat diameter d_v to the inlet pipe inner diameter D ;

C_d is the discharge coefficient of the SSV;

p_p is the absolute pressure at venturi inlet, kPa.

To determine the range of subsonic flow, C_d shall be plotted as a function of Reynolds number Re at the SSV throat. The Reynolds number at the SSV throat shall be calculated using the following equation:

$$\text{Re} = A_1 \times \frac{Q_{\text{SSV}}}{d_v \times \mu}$$

where:

$$\mu = \frac{b \times T^{1.5}}{S + T}$$

A_1 is 25.55152 in SI, $\left(\frac{1}{\text{m}^3}\right) \left(\frac{\text{min}}{\text{s}}\right) \left(\frac{\text{mm}}{\text{m}}\right)$;

Q_{SSV} is the airflow rate at standard conditions (101.325 kPa, 273.15 K (0 °C)), m³/s;

d_v is the diameter of the SSV throat, m;

μ is the absolute or dynamic viscosity of the gas, kg/ms;

b is 1.458×10^6 (empirical constant), kg/ms K^{0.5};

S is 110.4 (empirical constant), Kelvin (K).

3.4.4.2.2. Because Q_{SSV} is an input to the Re equation, the calculations shall be started with an initial guess for Q_{SSV} or C_d of the calibration venturi, and repeated until Q_{SSV} converges. The convergence method shall be accurate to at least 0.1 per cent.

3.4.4.2.3. For a minimum of sixteen points in the region of subsonic flow, the calculated values of C_d from the resulting calibration curve fit equation shall be within ± 0.5 per cent of the measured C_d for each calibration point.

3.4.5. Calibration of an ultrasonic flow meter (UFM)

3.4.5.1. The UFM shall be calibrated against a suitable reference flow meter.

3.4.5.2. The UFM shall be calibrated in the CVS configuration that will be used in the test cell (diluted exhaust piping, suction device) and checked for leaks. See Figure A5/8.

3.4.5.3. A heater shall be installed to condition the calibration flow in the event that the UFM system does not include a heat exchanger.

3.4.5.4. For each CVS flow setting that will be used, the calibration shall be performed at temperatures from room temperature to the maximum that will be experienced during vehicle testing.

3.4.5.5. The manufacturer's recommended procedure shall be followed for calibrating the electronic portions (temperature (T) and pressure (P) sensors) of the UFM.

3.4.5.6. Measurements for flow calibration of the ultrasonic flow meter are required and the following data (in the case that a laminar flow element is used) shall be found within the limits of accuracy given:

| | |
|--|---------------------|
| Barometric pressure (corrected), P_b | ± 0.03 kPa, |
| LFE air temperature, flow meter, ETI | ± 0.15 °C, |
| Pressure depression upstream of LFE, EPI | ± 0.01 kPa, |
| Pressure drop across (EDP) LFE matrix | ± 0.0015 kPa, |
| Air flow, Q_s | ± 0.5 per cent, |
| UFM inlet depression, P_{act} | ± 0.02 kPa, |
| Temperature at UFM inlet, T_{act} | ± 0.2 °C. |

3.4.5.7. Procedure

3.4.5.7.1. The equipment shall be set up as shown in Figure A5/8 and checked for leaks. Any leaks between the flow-measuring device and the UFM will seriously affect the accuracy of the calibration.

Figure A5/8
UFM calibration configuration

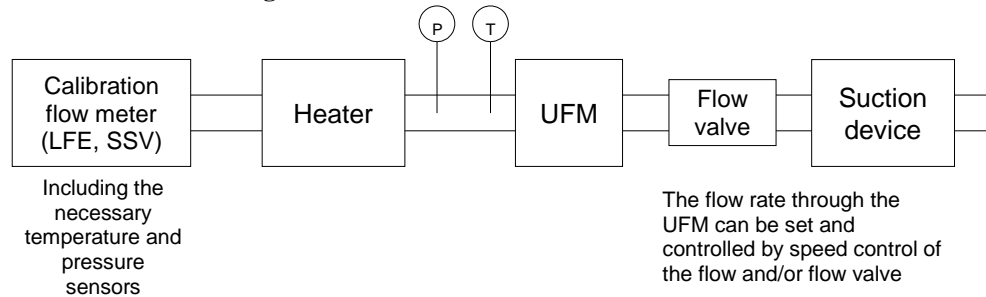

3.4.5.7.2. The suction device shall be started. Its speed and/or the position of the flow valve shall be adjusted to provide the set flow for the validation and the system stabilised. Data from all instruments shall be collected.

3.4.5.7.3. For UFM systems without a heat exchanger, the heater shall be operated to increase the temperature of the calibration air, allowed to stabilise and data from all the instruments recorded. The temperature shall be increased in reasonable steps until the maximum expected diluted exhaust temperature expected during the emissions test is reached.

3.4.5.7.4. The heater shall be subsequently turned off and the suction device speed and/or flow valve shall be adjusted to the next flow setting that will be used for vehicle emissions testing after which the calibration sequence shall be repeated.

3.4.5.8. The data recorded during the calibration shall be used in the following calculations. The air flow rate Q_s at each test point shall be calculated from the flow meter data using the manufacturer's prescribed method.

$$K_v = \frac{Q_{\text{reference}}}{Q_s}$$

where:

Q_s is the air flow rate at standard conditions (101.325 kPa, 273.15 K (0 °C)), m³/s;

$Q_{\text{reference}}$ is the air flow rate of the calibration flow meter at standard conditions (101.325 kPa, 273.15 K (0 °C)), m³/s;

K_v is the calibration coefficient.

For UFM systems without a heat exchanger, K_v shall be plotted as a function of T_{act} .

The maximum variation in K_v shall not exceed 0.3 per cent of the arithmetic average K_v value of all the measurements taken at the different temperatures.

- 3.5. System verification procedure
 - 3.5.1. General requirements
 - 3.5.1.1. The total accuracy of the CVS sampling system and analytical system shall be determined by introducing a known mass of an emissions gas compound into the system whilst it is being operated under normal test conditions and subsequently analysing and calculating the emission gas compounds according to the equations of Annex 7. The CFO method described in paragraph 3.5.1.1.1. of this annex and the gravimetric method described in paragraph 3.5.1.1.2. of this annex are both known to give sufficient accuracy.

The maximum permissible deviation between the quantity of gas introduced and the quantity of gas measured is ± 2 per cent.
 - 3.5.1.1.1. Critical flow orifice (CFO) method

The CFO method meters a constant flow of pure gas (CO, CO₂, or C₃H₈) using a critical flow orifice device.

A known mass of pure carbon monoxide, carbon dioxide or propane gas shall be introduced into the CVS system through the calibrated critical orifice. If the inlet pressure is high enough, the flow rate q which is restricted by means of the critical flow orifice, is independent of orifice outlet pressure (critical flow). The CVS system shall be operated as in a normal exhaust emissions test and enough time shall be allowed for subsequent analysis. The gas collected in the sample bag shall be analysed by the usual equipment (see paragraph 4.1. of this annex) and the results compared to the concentration of the known gas samples. If deviations exceed ± 2 per cent, the cause of the malfunction shall be determined and corrected.
 - 3.5.1.1.2. Gravimetric method

The gravimetric method weighs a quantity of pure gas (CO, CO₂, or C₃H₈).

The weight of a small cylinder filled with either pure carbon monoxide, carbon dioxide or propane shall be determined with a precision of ± 0.01 g. The CVS system shall operate under normal exhaust emissions test conditions while the pure gas is injected into the system for a time sufficient for subsequent analysis. The quantity of pure gas involved shall be determined by means of differential weighing. The gas accumulated in the bag shall be analysed by means of the equipment normally used for exhaust gas analysis as described in paragraph 4.1. of this annex. The results shall be subsequently compared to the concentration figures computed previously. If deviations exceed ± 2 per cent, the cause of the malfunction shall be determined and corrected.
- 4. Emissions measurement equipment
 - 4.1. Gaseous emissions measurement equipment
 - 4.1.1. System overview
 - 4.1.1.1. A continuously proportional sample of the diluted exhaust gases and the dilution air shall be collected for analysis.
 - 4.1.1.2. The mass of gaseous emissions shall be determined from the proportional sample concentrations and the total volume measured during the test. Sample concentrations shall be corrected to take into account the respective compound concentrations in dilution air.
 - 4.1.2. Sampling system requirements

- 4.1.2.1. The sample of diluted exhaust gases shall be taken upstream from the suction device.
- With the exception of paragraphs 4.1.3.1. (hydrocarbon sampling system), paragraph 4.2. (PM measurement equipment) and paragraph 4.3. (PN measurement equipment) of this annex, the dilute exhaust gas sample may be taken downstream of the conditioning devices (if any).
- 4.1.2.2. The bag sampling flow rate shall be set to provide sufficient volumes of dilution air and diluted exhaust in the CVS bags to allow concentration measurement and shall not exceed 0.3 per cent of the flow rate of the dilute exhaust gases, unless the diluted exhaust bag fill volume is added to the integrated CVS volume.
- 4.1.2.3. A sample of the dilution air shall be taken near the dilution air inlet (after the filter if one is fitted).
- 4.1.2.4. The dilution air sample shall not be contaminated by exhaust gases from the mixing area.
- 4.1.2.5. The sampling rate for the dilution air shall be comparable to that used for the dilute exhaust gases.
- 4.1.2.6. The materials used for the sampling operations shall be such as not to change the concentration of the emissions compounds.
- 4.1.2.7. Filters may be used in order to extract the solid particles from the sample.
- 4.1.2.8. Any valve used to direct the exhaust gases shall be of a quick-adjustment, quick-acting type.
- 4.1.2.9. Quick-fastening, gas-tight connections may be used between three-way valves and the sample bags, the connections sealing themselves automatically on the bag side. Other systems may be used for conveying the samples to the analyser (e.g. three-way stop valves).
- 4.1.2.10. Sample storage
- 4.1.2.10.1. The gas samples shall be collected in sample bags of sufficient capacity so as not to impede the sample flow.
- 4.1.2.10.2. The bag material shall be such as to affect neither the measurements themselves nor the chemical composition of the gas samples by more than ± 2 per cent after 30 minutes (e.g., laminated polyethylene/polyamide films, or fluorinated polyhydrocarbons).
- 4.1.3. Sampling systems
- 4.1.3.1. Hydrocarbon sampling system (heated flame ionisation detector, HFID)
- 4.1.3.1.1. The hydrocarbon sampling system shall consist of a heated sampling probe, line, filter and pump. The sample shall be taken upstream of the heat exchanger (if fitted). The sampling probe shall be installed at the same distance from the exhaust gas inlet as the particulate sampling probe and in such a way that neither interferes with samples taken by the other. It shall have a minimum internal diameter of 4 mm.
- 4.1.3.1.2. All heated parts shall be maintained at a temperature of $190\text{ }^{\circ}\text{C} \pm 10\text{ }^{\circ}\text{C}$ by the heating system.

- 4.1.3.1.3. The arithmetic average concentration of the measured hydrocarbons shall be determined by integration of the second-by-second data divided by the phase or test duration.
- 4.1.3.1.4. The heated sampling line shall be fitted with a heated filter F_H having a 99 per cent efficiency for particles $\geq 0.3 \mu\text{m}$ to extract any solid particles from the continuous flow of gas required for analysis.
- 4.1.3.1.5. The sampling system delay time (from the probe to the analyser inlet) shall be no more than 4 seconds.
- 4.1.3.1.6. The HFID shall be used with a constant mass flow (heat exchanger) system to ensure a representative sample, unless compensation for varying CVS volume flow is made.
- 4.1.3.2. NO or NO₂ sampling system (where applicable)
- 4.1.3.2.1. A continuous sample flow of diluted exhaust gas shall be supplied to the analyser.
- 4.1.3.2.2. The arithmetic average concentration of the NO or NO₂ shall be determined by integration of the second-by-second data divided by the phase or test duration.
- 4.1.3.2.3. The continuous NO or NO₂ measurement shall be used with a constant flow (heat exchanger) system to ensure a representative sample, unless compensation for varying CVS volume flow is made.
- 4.1.4. Analysers
- 4.1.4.1. General requirements for gas analysis
- 4.1.4.1.1. The analysers shall have a measuring range compatible with the accuracy required to measure the concentrations of the exhaust gas sample compounds.
- 4.1.4.1.2. If not defined otherwise, measurement errors shall not exceed ± 2 per cent (intrinsic error of analyser) disregarding the reference value for the calibration gases.
- 4.1.4.1.3. The ambient air sample shall be measured on the same analyser with the same range.
- 4.1.4.1.4. No gas drying device shall be used before the analysers unless it is shown to have no effect on the content of the compound in the gas stream.
- 4.1.4.2. Carbon monoxide (CO) and carbon dioxide (CO₂) analysis
The analysers shall be of the non-dispersive infrared (NDIR) absorption type.
- 4.1.4.3. Hydrocarbons (HC) analysis for all fuels other than diesel fuel
The analyser shall be of the flame ionization (FID) type calibrated with propane gas expressed in equivalent carbon atoms (C_1).
- 4.1.4.4. Hydrocarbons (HC) analysis for diesel fuel and optionally for other fuels
The analyser shall be of the heated flame ionization type with detector, valves, pipework, etc., heated to $190 \text{ }^\circ\text{C} \pm 10 \text{ }^\circ\text{C}$. It shall be calibrated with propane gas expressed equivalent to carbon atoms (C_1).

- 4.1.4.5. Methane (CH₄) analysis
The analyser shall be either a gas chromatograph combined with a flame ionization detector (FID), or a flame ionization detector (FID) combined with a non-methane cutter (NMC-FID), calibrated with methane or propane gas expressed equivalent to carbon atoms (C₁).
- 4.1.4.6. Nitrogen oxides (NO_x) analysis
The analysers shall be of chemiluminescent (CLA) or non-dispersive ultra-violet resonance absorption (NDUV) types.
- 4.1.4.7. Nitrogen oxide (NO) analysis (if applicable)
The analysers shall be of chemiluminescent (CLA) or non-dispersive ultra-violet resonance absorption (NDUV) types.
- 4.1.4.8. Nitrogen dioxide (NO₂) analysis (if applicable)
- 4.1.4.8.1. Measurement of NO from continuously diluted exhausts
- 4.1.4.8.1.1. A CLA analyser may be used to measure the NO concentration continuously from diluted exhaust.
- 4.1.4.8.1.2. The CLA analyser shall be calibrated (zero/calibrated) in the NO mode using the NO certified concentration in the calibration gas cylinder with the NO_x converter bypassed (if installed).
- 4.1.4.8.1.3. The NO₂ concentration shall be determined by subtracting the NO concentration from the NO_x concentration in the CVS sample bags.
- 4.1.4.8.2. Measurement of NO₂ from continuously diluted exhausts
- 4.1.4.8.2.1. A specific NO₂ analyser (NDUV, QCL) may be used to measure the NO₂ concentration continuously from diluted exhaust.
- 4.1.4.8.2.2. The analyser shall be calibrated (zeroed/ calibrated) in the NO₂ mode using the NO₂ certified concentration in the calibration gas cylinder.
- 4.1.4.9. Nitrous oxide (N₂O) analysis with GC-ECD (if applicable)
A gas chromatograph with an electron-capture detector (GC-ECD) may be used to measure N₂O concentrations of diluted exhaust by batch sampling from exhaust and ambient bags. Refer to paragraph 7.2. of this annex.
- 4.1.4.10. Nitrous oxide (N₂O) analysis with IR-absorption spectrometry (if applicable)
The analyser shall be a laser infrared spectrometer defined as modulated high resolution narrow band infrared analyser (e.g. QCL). An NDIR or FTIR may also be used but water, CO and CO₂ interference shall be taken into consideration.
- 4.1.4.10.1. If the analyser shows interference to compounds present in the sample, this interference shall be corrected. Analysers shall have combined interference within 0.0 ±0.1 ppm.
- 4.1.4.11. Hydrogen (H₂) analysis (if applicable)
The analyser shall be of the sector field mass spectrometer type.
- 4.1.5. Recommended system descriptions
- 4.1.5.1. Figure A5/9 is a schematic drawing of the gaseous emissions sampling system.

Figure A5/9
Full flow exhaust dilution system schematic

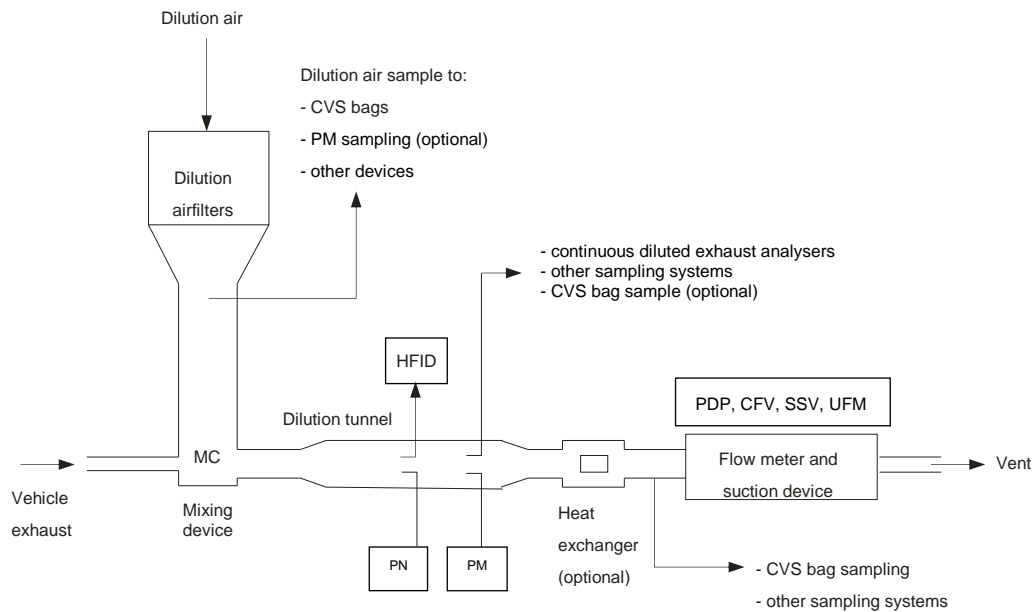

- 4.1.5.2. Examples of system components are as listed below.
- 4.1.5.2.1. Two sampling probes for continuous sampling of the dilution air and of the diluted exhaust gas/air mixture.
- 4.1.5.2.2. A filter to extract solid particles from the flows of gas collected for analysis.
- 4.1.5.2.3. Pumps and flow controller to ensure constant uniform flow of diluted exhaust gas and dilution air samples taken during the course of the test from sampling probes and flow of the gas samples shall be such that, at the end of each test, the quantity of the samples is sufficient for analysis.
- 4.1.5.2.4. Quick-acting valves to divert a constant flow of gas samples into the sample bags or to the outside vent.
- 4.1.5.2.5. Gas-tight, quick-lock coupling elements between the quick-acting valves and the sample bags. The coupling shall close automatically on the sampling bag side. As an alternative, other methods of transporting the samples to the analyser may be used (three-way stopcocks, for instance).
- 4.1.5.2.6. Bags for collecting samples of the diluted exhaust gas and of the dilution air during the test.
- 4.1.5.2.7. A sampling critical flow venturi to take proportional samples of the diluted exhaust gas (CFV-CVS only).
- 4.1.5.3. Additional components required for hydrocarbon sampling using a heated flame ionization detector (HFID) as shown in Figure A5/10.
- 4.1.5.3.1. Heated sample probe in the dilution tunnel located in the same vertical plane as the particulate and, if applicable, particle sample probes.
- 4.1.5.3.2. Heated filter located after the sampling point and before the HFID.
- 4.1.5.3.3. Heated selection valves between the zero/calibration gas supplies and the HFID.

- 4.1.5.3.4. Means of integrating and recording instantaneous hydrocarbon concentrations.
- 4.1.5.3.5. Heated sampling lines and heated components from the heated probe to the HFID.

Figure A5/10

Components required for hydrocarbon sampling using an HFID

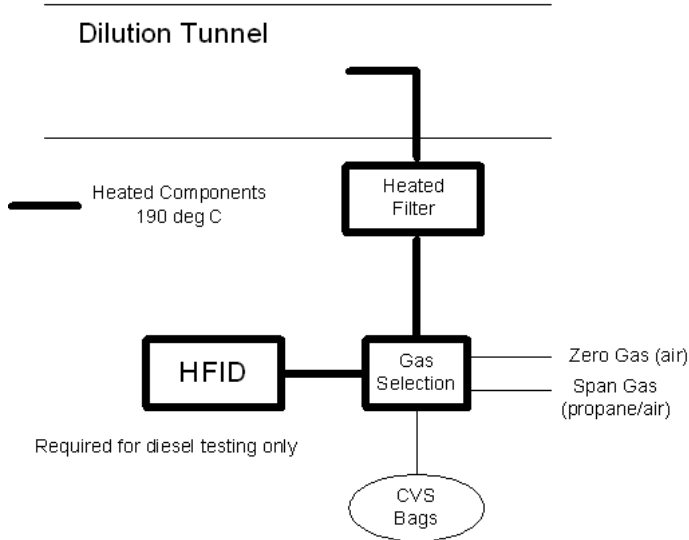

- 4.2. PM measurement equipment
 - 4.2.1. Specification
 - 4.2.1.1. System overview
 - 4.2.1.1.1. The particulate sampling unit shall consist of a sampling probe (PSP), located in the dilution tunnel, a particle transfer tube (PTT), a filter holder(s) (FH), pump(s), flow rate regulators and measuring units. See Figures A5/11, A5/12 and A5/13.
 - 4.2.1.1.2. A particle size pre-classifier (PCF), (e.g. cyclone or impactor) may be used. In such case, it is recommended that it be employed upstream of the filter holder.

Figure A5/11

Alternative particulate sampling probe configuration

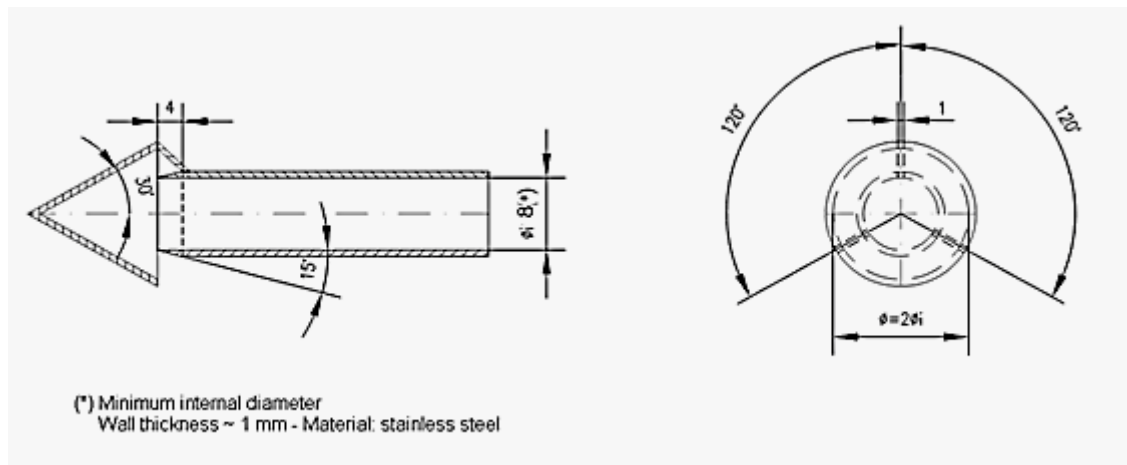

- 4.2.1.2. General requirements
- 4.2.1.2.1. The sampling probe for the test gas flow for particulate shall be arranged within the dilution tunnel so that a representative sample gas flow can be taken from the homogeneous air/exhaust mixture and shall be upstream of a heat exchanger (if any).
- 4.2.1.2.2. The particulate sample flow rate shall be proportional to the total mass flow of diluted exhaust gas in the dilution tunnel to within a tolerance of ± 5 per cent of the particulate sample flow rate. The verification of the proportionality of the particulate sampling shall be made during the commissioning of the system and as required by the responsible authority.
- 4.2.1.2.3. The sampled dilute exhaust gas shall be maintained at a temperature above 20 °C and below 52 °C within 20 cm upstream or downstream of the particulate sampling filter face. Heating or insulation of components of the particulate sampling system to achieve this is permitted.
- In the event that the 52 °C limit is exceeded during a test where periodic regeneration event does not occur, the CVS flow rate shall be increased or double dilution shall be applied (assuming that the CVS flow rate is already sufficient so as not to cause condensation within the CVS, sample bags or analytical system).
- 4.2.1.2.4. The particulate sample shall be collected on a single filter mounted within a holder in the sampled dilute exhaust gas flow.
- 4.2.1.2.5. All parts of the dilution system and the sampling system from the exhaust pipe up to the filter holder that are in contact with raw and diluted exhaust gas shall be designed to minimise deposition or alteration of the particulate. All parts shall be made of electrically conductive materials that do not react with exhaust gas components, and shall be electrically grounded to prevent electrostatic effects.
- 4.2.1.2.6. If it is not possible to compensate for variations in the flow rate, provision shall be made for a heat exchanger and a temperature control device as specified in paragraphs 3.3.5.1. or 3.3.6.4.2. of this annex, so as to ensure that the flow rate in the system is constant and the sampling rate accordingly proportional.
- 4.2.1.2.7. Temperatures required for the measurement of PM shall be measured with an accuracy of ± 1 °C and a response time ($t_{90} - t_{10}$) of 15 seconds or less.
- 4.2.1.2.8. The sample flow from the dilution tunnel shall be measured with an accuracy of ± 2.5 per cent of reading or ± 1.5 per cent full scale, whichever is the least.
- The accuracy specified above of the sample flow from the CVS tunnel is also applicable where double dilution is used. Consequently, the measurement and control of the secondary dilution air flow and diluted exhaust flow rates through the filter shall be of a higher accuracy.
- 4.2.1.2.9. All data channels required for the measurement of PM shall be logged at a frequency of 1 Hz or faster. Typically, these would include:
- Diluted exhaust temperature at the particulate sampling filter;
 - Sampling flow rate;
 - Secondary dilution air flow rate (if secondary dilution is used);
 - Secondary dilution air temperature (if secondary dilution is used).

4.2.1.2.10. For double dilution systems, the accuracy of the diluted exhaust transferred from the dilution tunnel V_{ep} defined in paragraph 3.3.2. of Annex 7 in the equation is not measured directly but determined by differential flow measurement.

The accuracy of the flow meters used for the measurement and control of the double diluted exhaust passing through the particulate sampling filters and for the measurement/control of secondary dilution air shall be sufficient so that the differential volume V_{ep} shall meet the accuracy and proportional sampling requirements specified for single dilution.

The requirement that no condensation of the exhaust gas occur in the CVS dilution tunnel, diluted exhaust flow rate measurement system, CVS bag collection or analysis systems shall also apply in the case that double dilution systems are used.

4.2.1.2.11. Each flow meter used in a particulate sampling and double dilution system shall be subjected to a linearity verification as required by the instrument manufacturer.

Figure A5/12
Particulate sampling system

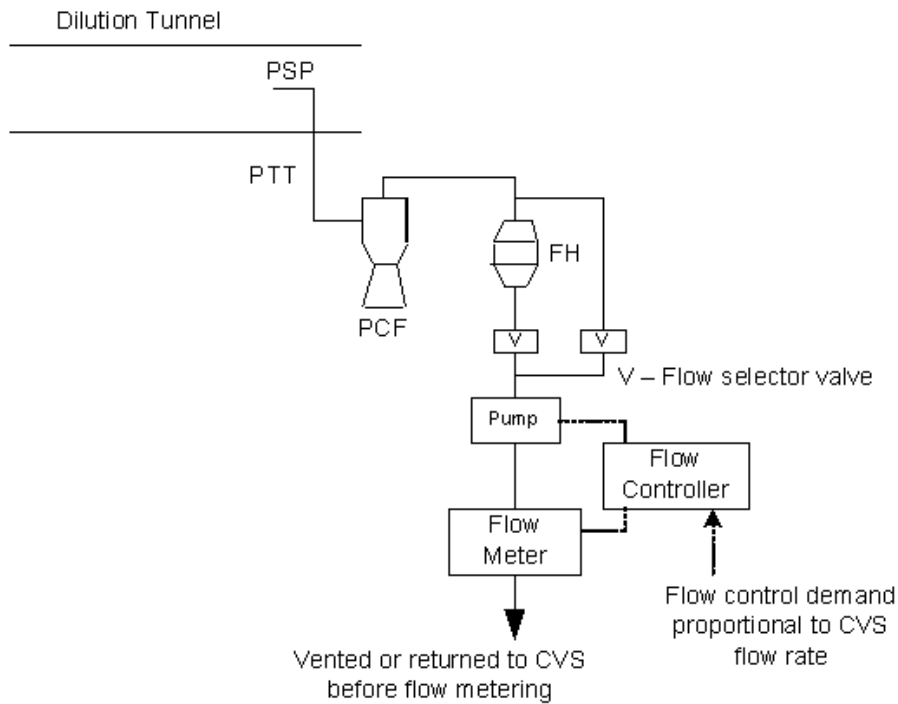
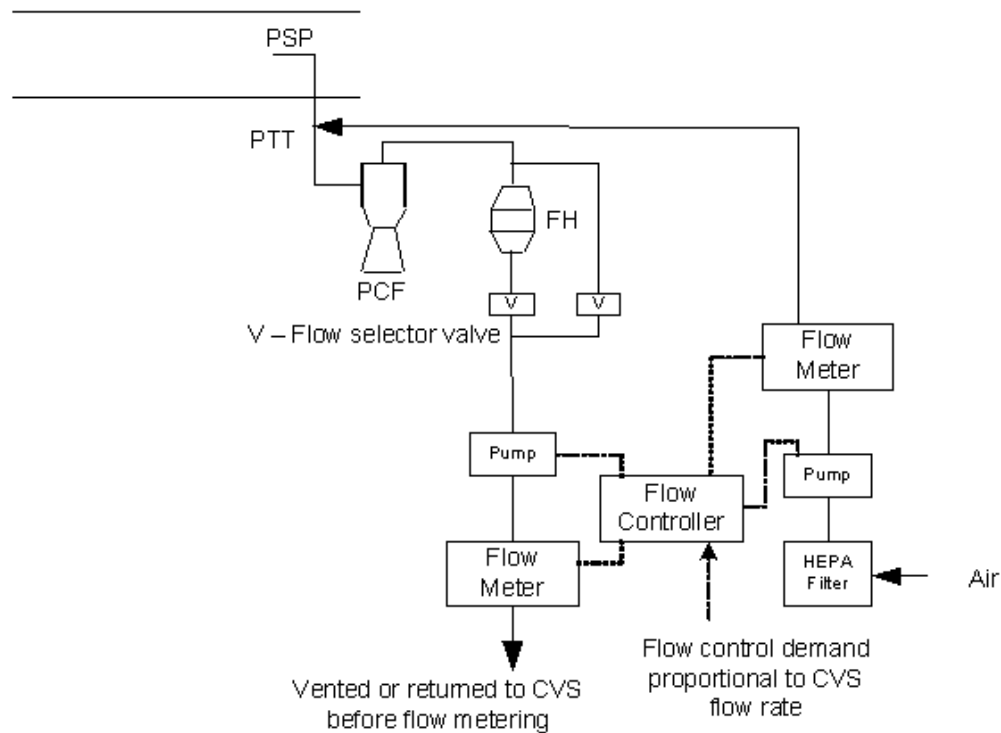

Figure A5/13
Double dilution particulate sampling system



4.2.1.3. Specific requirements

4.2.1.3.1. Sample probe

4.2.1.3.1.1. The sample probe shall deliver the particle size classification performance specified in paragraph 4.2.1.3.1.4. of this annex. It is recommended that this performance be achieved by the use of a sharp-edged, open-ended probe facing directly into the direction of flow plus a pre-classifier (cyclone impactor, etc.). An appropriate sample probe, such as that indicated in Figure A5/11, may alternatively be used provided it achieves the pre-classification performance specified in paragraph 4.2.1.3.1.4. of this annex.

4.2.1.3.1.2. The sample probe shall be installed at least 10 tunnel diameters downstream of the exhaust gas inlet to the tunnel and have an internal diameter of at least 8 mm.

If more than one simultaneous sample is drawn from a single sample probe, the flow drawn from that probe shall be split into identical sub-flows to avoid sampling artefacts.

If multiple probes are used, each probe shall be sharp-edged, open-ended and facing directly into the direction of flow. Probes shall be equally spaced around the central longitudinal axis of the dilution tunnel, with a spacing between probes of at least 5 cm.

4.2.1.3.1.3. The distance from the sampling tip to the filter mount shall be at least five probe diameters, but shall not exceed 2,000 mm.

- 4.2.1.3.1.4. The pre-classifier (e.g. cyclone, impactor, etc.) shall be located upstream of the filter holder assembly. The pre-classifier 50 per cent cut point particle diameter shall be between 2.5 μm and 10 μm at the volumetric flow rate selected for sampling PM. The pre-classifier shall allow at least 99 per cent of the mass concentration of 1 μm particles entering the pre-classifier to pass through the exit of the pre-classifier at the volumetric flow rate selected for sampling PM.
- 4.2.1.3.2. Particle transfer tube (PTT)
Any bends in the PTT shall be smooth and have the largest possible radii.
- 4.2.1.3.3. Secondary dilution
- 4.2.1.3.3.1. As an option, the sample extracted from the CVS for the purpose of PM measurement may be diluted at a second stage, subject to the following requirements:
- 4.2.1.3.3.1.1. Secondary dilution air shall be filtered through a medium capable of reducing particles in the most penetrating particle size of the filter material by ≥ 99.95 per cent, or through a HEPA filter of at least Class H13 of EN 1822:2009. The dilution air may optionally be charcoal-scrubbed before being passed to the HEPA filter. It is recommended that an additional coarse particle filter be situated before the HEPA filter and after the charcoal scrubber, if used.
- 4.2.1.3.3.1.2. The secondary dilution air should be injected into the PTT as close to the outlet of the diluted exhaust from the dilution tunnel as possible.
- 4.2.1.3.3.1.3. The residence time from the point of secondary diluted air injection to the filter face shall be at least 0.25 seconds, but no longer than 5 seconds.
- 4.2.1.3.3.1.4. If the double diluted sample is returned to the CVS, the location of the sample return shall be selected so that it does not interfere with the extraction of other samples from the CVS.
- 4.2.1.3.4. Sample pump and flow meter
- 4.2.1.3.4.1. The sample gas flow measurement unit shall consist of pumps, gas flow regulators and flow measuring units.
- 4.2.1.3.4.2. The temperature of the gas flow in the flow meter may not fluctuate by more than ± 3 $^{\circ}\text{C}$ except:
- (a) When the sampling flow meter has real time monitoring and flow control operating at a frequency of 1 Hz or faster;
- (b) During regeneration tests on vehicles equipped with periodically regenerating after-treatment devices.
- Should the volume of flow change unacceptably as a result of excessive filter loading, the test shall be invalidated. When it is repeated, the flow rate shall be decreased.
- 4.2.1.3.5. Filter and filter holder
- 4.2.1.3.5.1. A valve shall be located downstream of the filter in the direction of flow. The valve shall open and close within 1 second of the start and end of test.

4.2.1.3.5.2. For a given test, the gas filter face velocity shall be set to an initial value within the range 20 cm/s to 105 cm/s and shall be set at the start of the test so that 105 cm/s will not be exceeded when the dilution system is being operated with sampling flow proportional to CVS flow rate.

4.2.1.3.5.3. Fluorocarbon coated glass fibre filters or fluorocarbon membrane filters shall be used.

All filter types shall have a 0.3 μm DOP (di-octylphthalate) or PAO (poly-alpha-olefin) CS 68649-12-7 or CS 68037-01-4 collection efficiency of at least 99 per cent at a gas filter face velocity of 5.33 cm/s measured according to one of the following standards:

- (a) U.S.A. Department of Defense Test Method Standard, MIL-STD-282 method 102.8: DOP-Smoke Penetration of Aerosol-Filter Element;
- (b) U.S.A. Department of Defense Test Method Standard, MIL-STD-282 method 502.1.1: DOP-Smoke Penetration of Gas-Mask Canisters;
- (c) Institute of Environmental Sciences and Technology, IEST-RP-CC021: Testing HEPA and ULPA Filter Media.

4.2.1.3.5.4. The filter holder assembly shall be of a design that provides an even flow distribution across the filter stain area. The filter shall be round and have a stain area of at least 1,075 mm².

4.2.2. Weighing chamber (or room) and analytical balance specifications

4.2.2.1. Weighing chamber (or room) conditions

- (a) The temperature of the weighing chamber (or room) in which the particulate sampling filters are conditioned and weighed shall be maintained to within 22 °C \pm 2 °C (22 °C \pm 1 °C if possible) during all filter conditioning and weighing;
- (b) Humidity shall be maintained at a dew point of less than 10.5 °C and a relative humidity of 45 per cent \pm 8 per cent;
- (c) Limited deviations from weighing chamber (or room) temperature and humidity specifications shall be permitted provided their total duration does not exceed 30 minutes in any one filter conditioning period;
- (d) The levels of ambient contaminants in the weighing chamber (or room) environment that would settle on the particulate sampling filters during their stabilisation shall be minimised;
- (e) During the weighing operation no deviations from the specified conditions are permitted.

4.2.2.2. Linear response of an analytical balance

The analytical balance used to determine the filter weight shall meet the linearity verification criteria of Table A5/1 applying a linear regression. This implies a precision of at least \pm 2 μg and a resolution of at least 1 μg (1 digit = 1 μg). At least 4 equally-spaced reference weights shall be tested. The zero value shall be within \pm 1 μg .

Table A5/1
Analytical balance verification criteria

| Measurement system | Intercept a_0 | Slope a_1 | Standard error of estimate (SEE) | Coefficient of determination r^2 |
|---------------------|----------------------|-------------|----------------------------------|------------------------------------|
| Particulate balance | $\leq 1 \mu\text{g}$ | 0.99 – 1.01 | ≤ 1 per cent max | ≥ 0.998 |

4.2.2.3. Elimination of static electricity effects

The effects of static electricity shall be nullified. This may be achieved by grounding the balance through placement upon an antistatic mat and neutralization of the particulate sampling filters prior to weighing using a polonium neutraliser or a device of similar effect. Alternatively, nullification of static effects may be achieved through equalization of the static charge.

4.2.2.4. Buoyancy correction

The sample and reference filter weights shall be corrected for their buoyancy in air. The buoyancy correction is a function of sampling filter density, air density and the density of the balance calibration weight, and does not account for the buoyancy of the particulate matter itself.

If the density of the filter material is not known, the following densities shall be used:

- (a) PTFE coated glass fibre filter: 2,300 kg/m³;
- (b) PTFE membrane filter: 2,144 kg/m³;
- (c) PTFE membrane filter with polymethylpentene support ring: 920 kg/m³.

For stainless steel calibration weights, a density of 8,000 kg/m³ shall be used. If the material of the calibration weight is different, its density shall be known and be used. International Recommendation OIML R 111-1 Edition 2004(E) (or equivalent) from International Organization of Legal Metrology on calibration weights should be followed.

The following equation shall be used:

$$Pe_f = Pe_{\text{uncorr}} \times \left(\frac{1 - \frac{\rho_a}{\rho_w}}{1 - \frac{\rho_a}{\rho_f}} \right)$$

where:

Pe_f is the corrected particulate sample mass, mg;

Pe_{uncorr} is the uncorrected particulate sample mass, mg;

ρ_a is the density of the air, kg/m³;

ρ_w is the density of balance calibration weight, kg/m³;

ρ_f is the density of the particulate sampling filter, kg/m³.

The density of the air ρ_a shall be calculated using the following equation:

$$\rho_a = \frac{p_b \times M_{\text{mix}}}{R \times T_a}$$

p_b is the total atmospheric pressure, kPa;

- T_a is the air temperature in the balance environment, Kelvin (K);
- M_{mix} is the molar mass of air in a balanced environment, 28.836 g mol⁻¹;
- R is the molar gas constant, 8.3144 J mol⁻¹ K⁻¹.
- 4.3. PN measurement equipment (if applicable)
- 4.3.1. Specification
- 4.3.1.1. System overview
- 4.3.1.1.1. The particle sampling system shall consist of a probe or sampling point extracting a sample from a homogeneously mixed flow in a dilution system, a volatile particle remover (VPR) upstream of a particle number counter (PNC) and suitable transfer tubing. See Figure A5/14.
- 4.3.1.1.2. It is recommended that a particle size pre-classifier (PCF) (e.g. cyclone, impactor, etc.) be located prior to the inlet of the VPR. The PCF 50 per cent cut point particle diameter shall be between 2.5 µm and 10 µm at the volumetric flow rate selected for particle sampling. The PCF shall allow at least 99 per cent of the mass concentration of 1 µm particles entering the PCF to pass through the exit of the PCF at the volumetric flow rate selected for particle sampling.
- A sample probe acting as an appropriate size-classification device, such as that shown in Figure A5/11, is an acceptable alternative to the use of a PCF.
- 4.3.1.2. General requirements
- 4.3.1.2.1. The particle sampling point shall be located within a dilution system. In the case that a double dilution system is used, the particle sampling point shall be located within the primary dilution system.
- 4.3.1.2.1.1. The sampling probe tip or PSP, and the PTT, together comprise the particle transfer system (PTS). The PTS conducts the sample from the dilution tunnel to the entrance of the VPR. The PTS shall meet the following conditions:
- The sampling probe shall be installed at least 10 tunnel diameters downstream of the exhaust gas inlet, facing upstream into the tunnel gas flow with its axis at the tip parallel to that of the dilution tunnel;
 - The sampling probe shall be upstream of any conditioning device (e.g. heat exchanger);
 - The sampling probe shall be positioned within the dilution tunnel so that the sample is taken from a homogeneous diluent/exhaust mixture.
- 4.3.1.2.1.2. Sample gas drawn through the PTS shall meet the following conditions:
- In the case that a full flow exhaust dilution system, is used it shall have a flow Reynolds number Re lower than 1,700;
 - In the case that a double dilution system is used, it shall have a flow Reynolds number Re lower than 1,700 in the PTT i.e. downstream of the sampling probe or point;
 - Shall have a residence time ≤ 3 seconds.
- 4.3.1.2.1.3. Any other sampling configuration for the PTS for which equivalent particle penetration at 30 nm can be demonstrated shall be considered acceptable.

- 4.3.1.2.1.4. The outlet tube (OT), conducting the diluted sample from the VPR to the inlet of the PNC, shall have the following properties:
- (a) An internal diameter ≥ 4 mm;
 - (b) A sample gas flow residence time of ≤ 0.8 seconds.
- 4.3.1.2.1.5. Any other sampling configuration for the OT for which equivalent particle penetration at 30 nm can be demonstrated shall be considered acceptable.
- 4.3.1.2.2. The VPR shall include devices for sample dilution and for volatile particle removal.
- 4.3.1.2.3. All parts of the dilution system and the sampling system from the exhaust pipe up to the PNC, which are in contact with raw and diluted exhaust gas, shall be designed to minimize deposition of the particles. All parts shall be made of electrically conductive materials that do not react with exhaust gas components, and shall be electrically grounded to prevent electrostatic effects.
- 4.3.1.2.4. The particle sampling system shall incorporate good aerosol sampling practice that includes the avoidance of sharp bends and abrupt changes in cross-section, the use of smooth internal surfaces and the minimization of the length of the sampling line. Gradual changes in the cross-section are permitted.
- 4.3.1.3. Specific requirements
- 4.3.1.3.1. The particle sample shall not pass through a pump before passing through the PNC.
- 4.3.1.3.2. A sample pre-classifier is recommended.
- 4.3.1.3.3. The sample preconditioning unit shall:
- (a) Be capable of diluting the sample in one or more stages to achieve a particle number concentration below the upper threshold of the single particle count mode of the PNC and a gas temperature below 35 °C at the inlet to the PNC;
 - (b) Include an initial heated dilution stage that outputs a sample at a temperature of ≥ 150 °C and ≤ 350 °C ± 10 °C, and dilutes by a factor of at least 10;
 - (c) Control heated stages to constant nominal operating temperatures, within the range ≥ 150 °C and ≤ 400 °C ± 10 °C;
 - (d) Provide an indication of whether or not heated stages are at their correct operating temperatures;
 - (e) Be designed to achieve a solid particle penetration efficiency of at least 70 per cent for particles of 100 nm electrical mobility diameter;
 - (f) Achieve a particle concentration reduction factor $f_r(d_i)$ for particles of 30 nm and 50 nm electrical mobility diameters that is no more than 30 per cent and 20 per cent respectively higher, and no more than 5 per cent lower than that for particles of 100 nm electrical mobility diameter for the VPR as a whole;

The particle concentration reduction factor at each particle size $f_r(d_i)$ shall be calculated using the following equation:

$$f_r(d_i) = \frac{N_{in}(d_i)}{N_{out}(d_i)}$$

where:

$N_{in}(d_i)$ is the upstream particle number concentration for particles of diameter d_i ;

$N_{out}(d_i)$ is the downstream particle number concentration for particles of diameter d_i ;

d_i is the particle electrical mobility diameter (30, 50 or 100 nm).

$N_{in}(d_i)$ and $N_{out}(d_i)$ shall be corrected to the same conditions.

The arithmetic average particle concentration reduction factor at a given dilution setting \bar{f}_r shall be calculated using the following equation:

$$\bar{f}_r = \frac{f_r(30 \text{ nm}) + f_r(50 \text{ nm}) + f_r(100 \text{ nm})}{3}$$

It is recommended that the VPR is calibrated and validated as a complete unit;

- (g) Be designed according to good engineering practice to ensure particle concentration reduction factors are stable across a test;
- (h) Also achieve more than 99.0 per cent vaporization of 30 nm tetracontane ($\text{CH}_3(\text{CH}_2)_{38}\text{CH}_3$) particles, with an inlet concentration of $\geq 10,000$ per cm^3 , by means of heating and reduction of partial pressures of the tetracontane.

4.3.1.3.4. The PNC shall:

- (a) Operate under full flow operating conditions;
- (b) Have a counting accuracy of ± 10 per cent across the range 1 per cm^3 to the upper threshold of the single particle count mode of the PNC against a suitable traceable standard. At concentrations below 100 per cm^3 , measurements averaged over extended sampling periods may be required to demonstrate the accuracy of the PNC with a high degree of statistical confidence;
- (c) Have a resolution of at least 0.1 particles per cm^3 at concentrations below 100 per cm^3 ;
- (d) Have a linear response to particle number concentrations over the full measurement range in single particle count mode;
- (e) Have a data reporting frequency equal to or greater than a frequency of 0.5 Hz;
- (f) Have a t_{90} response time over the measured concentration range of less than 5 seconds;
- (g) Incorporate a coincidence correction function up to a maximum 10 per cent correction, and may make use of an internal calibration factor as determined in paragraph 5.7.1.3. of this annex but shall not make use of any other algorithm to correct for or define the counting efficiency;
- (h) Have counting efficiencies at the different particle sizes as specified in Table A5/2.

Table A5/2
PNC counting efficiency

| <i>Particle size electrical mobility diameter (nm)</i> | <i>PNC counting efficiency (per cent)</i> |
|--|---|
| 23 ±1 | 50 ±12 |
| 41 ±1 | > 90 |

- 4.3.1.3.5. If the PNC makes use of a working liquid, it shall be replaced at the frequency specified by the instrument manufacturer.
- 4.3.1.3.6. Where not held at a known constant level at the point at which PNC flow rate is controlled, the pressure and/or temperature at the PNC inlet shall be measured for the purposes of correcting particle number concentration measurements to standard conditions.
- 4.3.1.3.7. The sum of the residence time of the PTS, VPR and OT plus the t_{90} response time of the PNC shall be no greater than 20 seconds.

4.3.1.4. Recommended system description

The following paragraph contains the recommended practice for measurement of PN. However, systems meeting the performance specifications in paragraphs 4.3.1.2. and 4.3.1.3. of this annex are acceptable.

Figure A5/14

A recommended particle sampling system

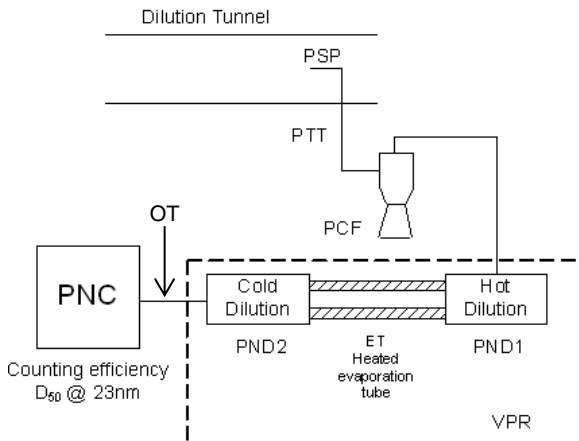

- 4.3.1.4.1. Sampling system description
 - 4.3.1.4.1.1. The particle sampling system shall consist of a sampling probe tip or particle sampling point in the dilution system, a PTT, a PCF, and a VPR, upstream of the PNC unit.
 - 4.3.1.4.1.2. The VPR shall include devices for sample dilution (particle number diluters: PND₁ and PND₂) and particle evaporation (evaporation tube, ET).
 - 4.3.1.4.1.3. The sampling probe or sampling point for the test gas flow shall be arranged within the dilution tunnel so that a representative sample gas flow is taken from a homogeneous diluent/exhaust mixture.

5. Calibration intervals and procedures

5.1. Calibration intervals

All instruments in Table A5/3 shall be calibrated at/after major maintenance intervals.

Table A5/3

Instrument calibration intervals

| <i>Instrument checks</i> | <i>Interval</i> | <i>Criterion</i> |
|--|---------------------------------------|---|
| Gas analyser linearization (calibration) | Every 6 months | ±2 per cent of reading |
| Mid-span | Every 6 months | ±2 per cent |
| CO NDIR: CO ₂ /H ₂ O interference | Monthly | -1 to 3 ppm |
| NO _x converter check | Monthly | > 95 per cent |
| CH ₄ cutter check | Yearly | 98 per cent of ethane |
| FID CH ₄ response | Yearly | See paragraph 5.4.3. of this annex. |
| FID air/fuel flow | At major maintenance | According to the instrument manufacturer. |
| NO/NO ₂ NDUV: H ₂ O, HC interference | At major maintenance | According to the instrument manufacturer. |
| Laser infrared spectrometers (modulated high resolution narrow band infrared analysers): interference check | Yearly | According to the instrument manufacturer. |
| QCL | Yearly | According to the instrument manufacturer. |
| GC methods | See paragraph 7.2. of this annex. | See paragraph 7.2. of this annex. |
| LC methods | Yearly | According to the instrument manufacturer. |
| Photoacoustics | Yearly | According to the instrument manufacturer. |
| FTIR: linearity verification | Within 370 days before testing | See paragraph 7.1. of this annex. |
| Microgram balance linearity | Yearly | See paragraph 4.2.2.2. of this annex. |
| PNC (particle number counter) | See paragraph 5.7.1.1. of this annex | See paragraph 5.7.1.3. of this annex. |
| VPR (volatile particle remover) | See paragraph 5.7.2.1. of this annex. | See paragraph 5.7.2. of this annex. |

Table A5/4
Constant volume sampler (CVS) calibration intervals

| <i>CVS</i> | <i>Interval</i> | <i>Criterion</i> |
|--------------------|-----------------|------------------|
| CVS flow | After overhaul | ±2 per cent |
| Temperature sensor | Yearly | ±1 °C |
| Pressure sensor | Yearly | ±0.4 kPa |
| Injection check | Weekly | ±2 per cent |

Table A5/5
Environmental data calibration intervals

| <i>Climate</i> | <i>Interval</i> | <i>Criterion</i> |
|------------------|-----------------|--|
| Temperature | Yearly | ±1 °C |
| Moisture dew | Yearly | ±5 per cent RH |
| Ambient pressure | Yearly | ±0.4 kPa |
| Cooling fan | After overhaul | According to paragraph 1.1.1. of this annex. |

- 5.2. Analyser calibration procedures
- 5.2.1. Each analyser shall be calibrated as specified by the instrument manufacturer or at least as often as specified in Table A5/3.
- 5.2.2. Each normally used operating range shall be linearized by the following procedure:
- 5.2.2.1. The analyser linearization curve shall be established by at least five calibration points spaced as uniformly as possible. The nominal concentration of the calibration gas of the highest concentration shall be not less than 80 per cent of the full scale.
- 5.2.2.2. The calibration gas concentration required may be obtained by means of a gas divider, diluting with purified N₂ or with purified synthetic air.
- 5.2.2.3. The linearization curve shall be calculated by the least squares method. If the resulting polynomial degree is greater than 3, the number of calibration points shall be at least equal to this polynomial degree plus 2.
- 5.2.2.4. The linearization curve shall not differ by more than ±2 per cent from the nominal value of each calibration gas.
- 5.2.2.5. From the trace of the linearization curve and the linearization points it is possible to verify that the calibration has been carried out correctly. The different characteristic parameters of the analyser shall be indicated, particularly:
- (a) Analyser and gas component;
 - (b) Range;
 - (c) Date of linearisation.

- 5.2.2.6. If the responsible authority is satisfied that alternative technologies (e.g. computer, electronically controlled range switch, etc.) give equivalent accuracy, these alternatives may be used.
- 5.3. Analyser zero and calibration verification procedure
- 5.3.1. Each normally used operating range shall be checked prior to each analysis in accordance with paragraphs 5.3.1.1. and 5.3.1.2. of this annex
- 5.3.1.1. The calibration shall be checked by use of a zero gas and by use of a calibration gas according to paragraph 2.14.2.3. of Annex 6.
- 5.3.1.2. After testing, zero gas and the same calibration gas shall be used for re-checking according to paragraph 2.14.2.4. of Annex 6.
- 5.4. FID hydrocarbon response check procedure
- 5.4.1. Detector response optimization
- The FID shall be adjusted as specified by the instrument manufacturer. Propane in air shall be used on the most common operating range.
- 5.4.2. Calibration of the HC analyser
- 5.4.2.1. The analyser shall be calibrated using propane in air and purified synthetic air.
- 5.4.2.2. A calibration curve as described in paragraph 5.2.2. of this annex shall be established.
- 5.4.3. Response factors of different hydrocarbons and recommended limits
- 5.4.3.1. The response factor R_f for a particular hydrocarbon compound is the ratio of the FID C_1 reading to the gas cylinder concentration, expressed as ppm C_1 .
- The concentration of the test gas shall be at a level to give a response of approximately 80 per cent of full-scale deflection for the operating range. The concentration shall be known to an accuracy of ± 2 per cent in reference to a gravimetric standard expressed in volume. In addition, the gas cylinder shall be preconditioned for 24 hours at a temperature between 20 and 30 °C.
- 5.4.3.2. The methane factor $R_{f_{CH_4}}$ shall be measured and determined when introducing an analyser into service, and yearly thereafter or after major maintenance intervals, whichever comes first.
- The propylene response factor $R_{f_{C_3H_6}}$ and the toluene response factor $R_{f_{C_7H_8}}$ shall be measured when introducing an analyser into service. It is recommended that they be measured at or after major maintenance which might possibly affect the response factors.
- The test gases to be used and the recommended response factors are:
- Methane and purified air: $0.95 < R_{f_{CH_4}} < 1.15$
- Propylene and purified air: $0.85 < R_{f_{C_3H_6}} < 1.10$
- Toluene and purified air: $0.85 < R_{f_{C_7H_8}} < 1.10$
- The factors are relative to an R_f of 1.00 for propane and purified air.
- 5.5. NO_x converter efficiency test procedure
- 5.5.1. Using the test set up as shown in Figure A5/15 and the procedure described below, the efficiency of converters for the conversion of NO_2 into NO shall be tested by means of an ozonator as follows:

- 5.5.1.1. The analyser shall be calibrated in the most common operating range following the manufacturer's specifications using zero and calibration gas (the NO content of which shall amount to approximately 80 per cent of the operating range and the NO₂ concentration of the gas mixture shall be less than 5 per cent of the NO concentration). The NO_x analyser shall be in the NO mode so that the calibration gas does not pass through the converter. The indicated concentration shall be recorded.
- 5.5.1.2. Via a T-fitting, oxygen or synthetic air shall be added continuously to the calibration gas flow until the concentration indicated is approximately 10 per cent less than the indicated calibration concentration given in paragraph 5.5.1.1. of this annex. The indicated concentration (c) shall be recorded. The ozonator shall be kept deactivated throughout this process.
- 5.5.1.3. The ozonator shall now be activated to generate enough ozone to bring the NO concentration down to 20 per cent (minimum 10 per cent) of the calibration concentration given in paragraph 5.5.1.1. of this annex. The indicated concentration (d) shall be recorded.
- 5.5.1.4. The NO_x analyser shall be subsequently switched to the NO_x mode, whereby the gas mixture (consisting of NO, NO₂, O₂ and N₂) now passes through the converter. The indicated concentration (a) shall be recorded.
- 5.5.1.5. The ozonator shall now be deactivated. The mixture of gases described in paragraph 5.5.1.2. of this annex shall pass through the converter into the detector. The indicated concentration (b) shall be recorded.

Figure A5/15

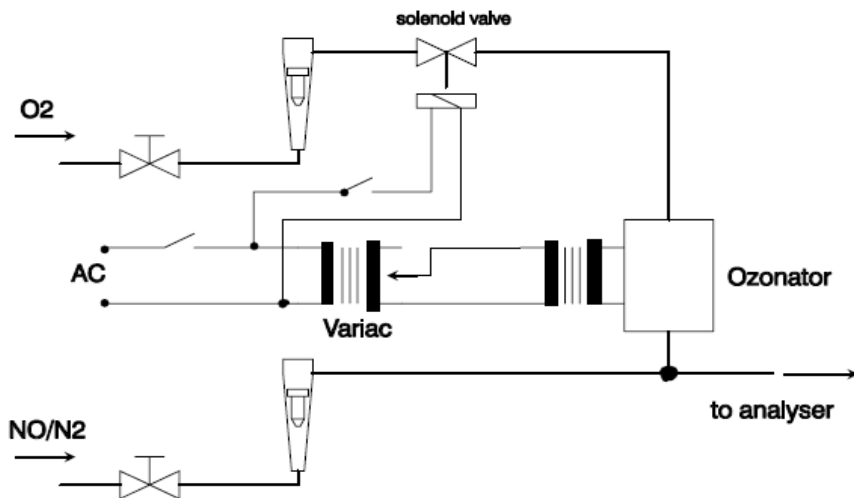
NO_x converter efficiency test configuration

- 5.5.1.6. With the ozonator deactivated, the flow of oxygen or synthetic air shall be shut off. The NO₂ reading of the analyser shall then be no more than 5 per cent above the figure given in paragraph 5.5.1.1. of this annex.
- 5.5.1.7. The per cent efficiency of the NO_x converter shall be calculated using the concentrations a, b, c and d determined in paragraphs 5.5.1.2. to 5.5.1.5. inclusive of this annex using the following equation:

$$\text{Efficiency} = \left(1 + \frac{a - b}{c - d}\right) \times 100$$

The efficiency of the converter shall not be less than 95 per cent. The efficiency of the converter shall be tested in the frequency defined in Table A5/3.

5.6. Calibration of the microgram balance

The calibration of the microgram balance used for particulate sampling filter weighing shall be traceable to a national or international standard. The balance shall comply with the linearity requirements given in paragraph 4.2.2.2. of this annex. The linearity verification shall be performed at least every 12 months or whenever a system repair or change is made that could influence the calibration.

5.7. Calibration and validation of the particle sampling system (if applicable)

Examples of calibration/validation methods are available at: <http://www.unece.org/trans/main/wp29/wp29wgs/wp29grpe/pmpFCP.html>.

5.7.1. Calibration of the PNC

- 5.7.1.1. The responsible authority shall ensure the existence of a calibration certificate for the PNC demonstrating compliance with a traceable standard within a 13-month period prior to the emissions test. Between calibrations either the counting efficiency of the PNC shall be monitored for deterioration or the PNC wick shall be routinely changed every 6 months. See Figures A5/16 and A5/17. PNC counting efficiency may be monitored against a reference PNC or against at least two other measurement PNCs. If the PNC reports particle number concentrations within ± 10 per cent of the arithmetic average of the concentrations from the reference PNC, or a group of two or more PNCs, the PNC shall subsequently be considered stable, otherwise maintenance of the PNC is required. Where the PNC is monitored against two or more other measurement PNCs, it is permitted to use a reference vehicle running sequentially in different test cells each with its own PNC.

Figure A5/16

Nominal PNC annual sequence

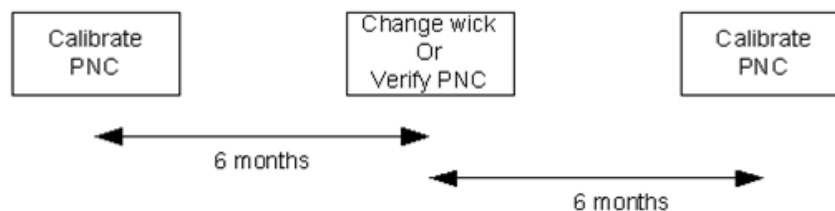
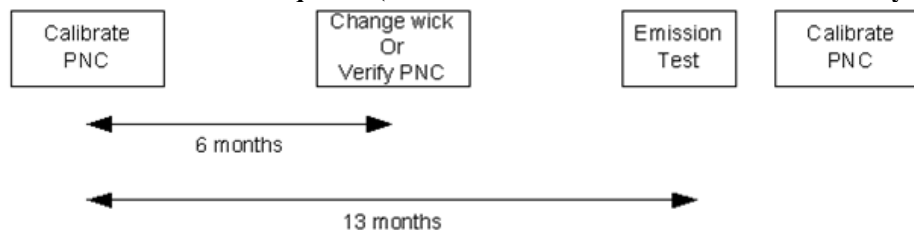

Figure A5/17

Extended PNC annual sequence (in the case that a full PNC calibration is delayed)



- 5.7.1.2. The PNC shall also be recalibrated and a new calibration certificate issued following any major maintenance.

- 5.7.1.3. Calibration shall be traceable to a national or international standard calibration method by comparing the response of the PNC under calibration with that of:

- (a) A calibrated aerosol electrometer when simultaneously sampling electrostatically classified calibration particles; or
 - (b) A second PNC that has been directly calibrated by the method described above.
- 5.7.1.3.1. In paragraph 5.7.1.3. (a) of this annex, calibration shall be undertaken using at least six standard concentrations spaced as uniformly as possible across the PNC's measurement range.
- 5.7.1.3.2. In paragraph 5.7.1.3. (b) of this annex, calibration shall be undertaken using at least six standard concentrations across the PNC's measurement range. At least 3 points shall be at concentrations below 1,000 per cm³, the remaining concentrations shall be linearly spaced between 1,000 per cm³ and the maximum of the PNC's range in single particle count mode.
- 5.7.1.3.3. In paragraphs 5.7.1.3.(a) and 5.7.1.3.(b) of this annex, the selected points shall include a nominal zero concentration point produced by attaching HEPA filters of at least Class H13 of EN 1822:2008, or equivalent performance, to the inlet of each instrument. With no calibration factor applied to the PNC under calibration, measured concentrations shall be within ± 10 per cent of the standard concentration for each concentration, with the exception of the zero point, otherwise the PNC under calibration shall be rejected. The gradient from a linear least squares regression of the two data sets shall be calculated and recorded. A calibration factor equal to the reciprocal of the gradient shall be applied to the PNC under calibration. Linearity of response is calculated as the square of the Pearson product moment correlation coefficient (r) of the two data sets and shall be equal to or greater than 0.97. In calculating both the gradient and r^2 , the linear regression shall be forced through the origin (zero concentration on both instruments).
- 5.7.1.4. Calibration shall also include a check, according to the requirements of paragraph 4.3.1.3.4.(h) of this annex, on the PNC's detection efficiency with particles of 23 nm electrical mobility diameter. A check of the counting efficiency with 41 nm particles is not required.
- 5.7.2. Calibration/validation of the VPR
- 5.7.2.1. Calibration of the VPR's particle concentration reduction factors across its full range of dilution settings, at the instrument's fixed nominal operating temperatures, shall be required when the unit is new and following any major maintenance. The periodic validation requirement for the VPR's particle concentration reduction factor is limited to a check at a single setting, typical of that used for measurement on particulate filter-equipped vehicles. The responsible authority shall ensure the existence of a calibration or validation certificate for the VPR within a 6-month period prior to the emissions test. If the VPR incorporates temperature monitoring alarms, a 13-month validation interval is permitted.

It is recommended that the VPR is calibrated and validated as a complete unit.

The VPR shall be characterised for particle concentration reduction factor with solid particles of 30, 50 and 100 nm electrical mobility diameter. Particle concentration reduction factors $f_r(d)$ for particles of 30 nm and 50 nm electrical mobility diameters shall be no more than 30 per cent and 20 per cent higher respectively, and no more than 5 per cent lower than that for particles of 100 nm electrical mobility diameter. For the purposes of validation, the arithmetic average of the particle concentration reduction factor shall be

within ± 10 per cent of the arithmetic average particle concentration reduction factor \bar{f}_r determined during the primary calibration of the VPR.

- 5.7.2.2. The test aerosol for these measurements shall be solid particles of 30, 50 and 100 nm electrical mobility diameter and a minimum concentration of 5,000 particles per cm^3 at the VPR inlet. As an option, a polydisperse aerosol with an electrical mobility median diameter of 50 nm may be used for validation. The test aerosol shall be thermally stable at the VPR operating temperatures. Particle number concentrations shall be measured upstream and downstream of the components.

The particle concentration reduction factor for each monodisperse particle size, $f_r(d_i)$, shall be calculated using the following equation:

$$f_r(d_i) = \frac{N_{in}(d_i)}{N_{out}(d_i)}$$

where:

$N_{in}(d_i)$ is the upstream particle number concentration for particles of diameter d_i ;

$N_{out}(d_i)$ is the downstream particle number concentration for particles of diameter d_i ;

d_i is the particle electrical mobility diameter (30, 50 or 100 nm).

$N_{in}(d_i)$ and $N_{out}(d_i)$ shall be corrected to the same conditions.

The arithmetic average particle concentration reduction factor \bar{f}_r at a given dilution setting shall be calculated using the following equation:

$$\bar{f}_r = \frac{f_r(30\text{nm}) + f_r(50\text{nm}) + f_r(100\text{nm})}{3}$$

Where a polydisperse 50 nm aerosol is used for validation, the arithmetic average particle concentration reduction factor \bar{f}_v at the dilution setting used for validation shall be calculated using the following equation:

$$\bar{f}_v = \frac{N_{in}}{N_{out}}$$

where:

N_{in} is the upstream particle number concentration;

N_{out} is the downstream particle number concentration.

- 5.7.2.3. The VPR shall demonstrate greater than 99.0 per cent removal of tetracontane ($\text{CH}_3(\text{CH}_2)_{38}\text{CH}_3$) particles of at least 30 nm electrical mobility diameter with an inlet concentration $\geq 10,000$ per cm^3 when operated at its minimum dilution setting and manufacturer's recommended operating temperature.

- 5.7.3. PN measurement system check procedures

On a monthly basis, the flow into the PNC shall have a measured value within 5 per cent of the PNC nominal flow rate when checked with a calibrated flow meter.

- 5.8. Accuracy of the mixing device

In the case that a gas divider is used to perform the calibrations as defined in paragraph 5.2. of this annex, the accuracy of the mixing device shall be such

that the concentrations of the diluted calibration gases may be determined to within ± 2 per cent. A calibration curve shall be verified by a mid-span check as described in paragraph 5.3. of this annex. A calibration gas with a concentration below 50 per cent of the analyser range shall be within 2 per cent of its certified concentration.

6. Reference gases
 - 6.1. Pure gases
 - 6.1.1. All values in ppm mean volume-ppm (vpm)
 - 6.1.2. The following pure gases shall be available, if necessary, for calibration and operation:
 - 6.1.2.1. Nitrogen:
Purity: ≤ 1 ppm C₁, ≤ 1 ppm CO, ≤ 400 ppm CO₂, ≤ 0.1 ppm NO, ≤ 0.1 ppm N₂O, ≤ 0.1 ppm NH₃.
 - 6.1.2.2. Synthetic air:
Purity: ≤ 1 ppm C₁, ≤ 1 ppm CO, ≤ 400 ppm CO₂, ≤ 0.1 ppm NO, ≤ 0.1 ppm NO₂; oxygen content between 18 and 21 per cent volume.
 - 6.1.2.3. Oxygen:
Purity: > 99.5 per cent vol. O₂.
 - 6.1.2.4. Hydrogen (and mixture containing helium or nitrogen):
Purity: ≤ 1 ppm C₁, ≤ 400 ppm CO₂; hydrogen content between 39 and 41 per cent volume.
 - 6.1.2.5. Carbon monoxide:
Minimum purity 99.5 per cent.
 - 6.1.2.6. Propane:
Minimum purity 99.5 per cent.
 - 6.2. Calibration gases

The true concentration of a calibration gas shall be within ± 1 per cent of the stated value or as given below, and shall be traceable to national or international standards.

Mixtures of gases having the following compositions shall be available with bulk gas specifications according to paragraphs 6.1.2.1. or 6.1.2.2. of this annex:

 - (a) C₃H₈ in synthetic air (see paragraph 6.1.2.2. of this annex);
 - (b) CO in nitrogen;
 - (c) CO₂ in nitrogen;
 - (d) CH₄ in synthetic air;
 - (e) NO in nitrogen (the amount of NO₂ contained in this calibration gas shall not exceed 5 per cent of the NO content);
 - (f) NO₂ in synthetic air or nitrogen (tolerance: ± 2 per cent), if applicable;

- (g) N₂O in nitrogen (tolerance: ±2 per cent or 0.25 ppm, whichever is greater), if applicable;
 - (h) NH₃ in nitrogen (tolerance: ±3 per cent), if applicable;
 - (i) C₂H₅OH in synthetic air or nitrogen (tolerance: ±2 per cent), if applicable;
 - (j) HCHO (tolerance: ±10 per cent), if applicable;
 - (k) CH₃CHO (tolerance: ±5 per cent), if applicable.
7. Additional sampling and analysis methods
- 7.1. Sampling and analysis methods for NH₃ (if applicable)
- Two measurement principles are specified for NH₃ measurement; either may be used provided the criteria specified in paragraphs 7.1.1. or 7.1.2. of this annex are fulfilled.
- Gas dryers are not permitted for NH₃ measurement. For non-linear analysers, the use of linearising circuits is permitted.
- 7.1.1. Laser diode spectrometer (LDS) or quantum cascade laser (QCL)
- 7.1.1.1. Measurement principle
- The LDS/QCL employs the single line spectroscopy principle. The NH₃ absorption line is chosen in the near infrared (LDS) or mid-infrared spectral range (QCL).
- 7.1.1.2. Installation
- The analyser shall be installed either directly in the exhaust pipe (in-situ) or within an analyser cabinet using extractive sampling in accordance with the instrument manufacturer's instructions.
- Where applicable, sheath air used in conjunction with an in-situ measurement for protection of the instrument shall not affect the concentration of any exhaust component measured downstream of the device, or, if the sheath air affects the concentration, the sampling of other exhaust components shall be made upstream of the device.
- 7.1.1.3. Cross interference
- The spectral resolution of the laser shall be within 0.5 per cm in order to minimize cross interference from other gases present in the exhaust gas.
- 7.1.2. Fourier transform infrared (FTIR) analyser
- 7.1.2.1. Measurement principle
- An FTIR employs the broad waveband infrared spectroscopy principle. It allows simultaneous measurement of exhaust components whose standardised spectra are available in the instrument. The absorption spectrum (intensity/wavelength) is calculated from the measured interferogram (intensity/time) by means of the Fourier transform method.
- 7.1.2.2. The internal analyser sample stream up to the measurement cell and the cell itself shall be heated.
- 7.1.2.3. Extractive sampling
- The sample path upstream of the analyser (sampling line, prefilter(s), pumps and valves) shall be made of stainless steel or PTFE, and shall be heated to set

points between 110 °C and 190 °C in order to minimise NH₃ losses and sampling artefacts. In addition, the sampling line shall be as short as possible. At the request of the manufacturer, temperatures between 110 °C and 133 °C may be chosen.

- 7.1.2.4. Measurement cross interference
 - 7.1.2.4.1. The spectral resolution of the target wavelength shall be within 0.5 per cm in order to minimize cross interference from other gases present in the exhaust gas.
 - 7.1.2.4.2. Analyser response shall not exceed ±2 ppm at the maximum CO₂ and H₂O concentration expected during the vehicle test.
- 7.1.2.5. In order not to influence the results of the downstream measurements in the CVS system, the amount of raw exhaust extracted for the NH₃ measurement shall be limited. This may be achieved by in-situ measurement, a low sample flow analyser, or the return of the NH₃ sample flow back to the CVS.

The maximum allowable NH₃ sample flow not returned to the CVS shall be calculated by:

$$\text{Flow_lost_max} = \frac{0.005 \times V_{\text{mix}}}{\text{DF}}$$

where:

- Flow_lost_max is the volume of sample not returned to the CVS, m³;
- V_{mix} is the volume of diluted exhaust per phase, m³;
- DF is the dilution factor.

If the unreturned volume of the NH₃ sample flow exceeds the maximum allowable for any phase of the test, the downstream measurements of the CVS are not valid and cannot be considered. An additional test without the ammonia measurement shall be performed.

If the extracted flow is returned to the CVS, an upper limit of 10 standard l/min shall apply. If this limit is exceeded, an additional test is therefore necessary without the ammonia measurement.

- 7.2. Sampling and analysis methods for N₂O
 - 7.2.1. Gas chromatographic method
 - 7.2.1.1. General description

Followed by gas chromatographic separation, N₂O shall be analysed by an electron capture detector (ECD).
 - 7.2.1.2. Sampling

During each phase of the test, a gas sample shall be taken from the corresponding diluted exhaust bag and dilution air bag for analysis. Alternatively, analysis of the dilution air bag from phase 1 or a single composite dilution background sample may be performed assuming that the N₂O content of the dilution air is constant.
 - 7.2.1.2.1. Sample transfer

Secondary sample storage media may be used to transfer samples from the test cell to the GC lab. Good engineering judgement shall be used to avoid

additional dilution when transferring the sample from sample bags to secondary sample bags.

- 7.2.1.2.2. Secondary sample storage media
- Gas volumes shall be stored in sufficiently clean containers that minimise off-gassing and permeation. Good engineering judgment shall be used to determine acceptable processes and thresholds regarding storage media cleanliness and permeation.
- 7.2.1.2.3. Sample storage
- Secondary sample storage bags shall be analysed within 24 hours and shall be stored at room temperature.
- 7.2.1.3. Instrumentation and apparatus
- 7.2.1.3.1. A gas chromatograph with an electron capture detector (GC-ECD) shall be used to measure N₂O concentrations of diluted exhaust for batch sampling.
- 7.2.1.3.2. The sample may be injected directly into the GC or an appropriate pre-concentrator may be used. In the case of pre-concentration, this shall be used for all necessary verifications and quality checks.
- 7.2.1.3.3. A porous layer open tubular or a packed column phase of suitable polarity and length shall be used to achieve adequate resolution of the N₂O peak for analysis.
- 7.2.1.3.4. Column temperature profile and carrier gas selection shall be taken into consideration when setting up the method to achieve adequate N₂O peak resolution. Whenever possible, the operator shall aim for baseline separated peaks.
- 7.2.1.3.5. Good engineering judgement shall be used to zero the instrument and to correct for drift.
- Example: A calibration gas measurement may be performed before and after sample analysis without zeroing and using the arithmetic average area counts of the pre-calibration and post-calibration measurements to generate a response factor (area counts/calibration gas concentration), which shall be subsequently multiplied by the area counts from the sample to generate the sample concentration.
- 7.2.1.4. Reagents and material
- All reagents, carrier and make up gases shall be of 99.995 per cent purity. Make up gas shall be N₂ or Ar/CH₄.
- 7.2.1.5. Peak integration procedure
- 7.2.1.5.1. Peak integrations shall be corrected as necessary in the data system. Any misplaced baseline segments shall be corrected in the reconstructed chromatogram.
- 7.2.1.5.2. Peak identifications provided by a computer shall be checked and corrected if necessary.
- 7.2.1.5.3. Peak areas shall be used for all evaluations. Alternatively, peak heights may be used with approval of the responsible authority.
- 7.2.1.6. Linearity

- 7.2.1.6.1. A multipoint calibration to confirm instrument linearity shall be performed for the target compound:
- For new instruments;
 - After performing instrument modifications that could affect linearity; and,
 - At least once per year.
- 7.2.1.6.2. The multipoint calibration shall consist of at least three concentrations, each above the limit of detection LoD distributed over the range of expected sample concentration.
- 7.2.1.6.3. Each concentration level shall be measured at least twice.
- 7.2.1.6.4. A linear least squares regression analysis shall be performed using concentration and arithmetic average area counts to determine the regression correlation coefficient r . The regression correlation coefficient shall be greater than 0.995 in order to be considered linear for one point calibrations.
- If the weekly check of the instrument response indicates that the linearity may have changed, a multipoint calibration shall be performed.
- 7.2.1.7. Quality control
- 7.2.1.7.1. The calibration standard shall be analysed each day of analysis to generate the response factors used to quantify the sample concentrations.
- 7.2.1.7.2. A quality control standard shall be analysed within 24 hours before the analysis of the sample.
- 7.2.1.8. Limit of detection, limit of quantification
- The detection limit shall be based on the noise measurement close to the retention time of N_2O (reference DIN 32645, 01.11.2008):
- Limit of Detection: $LoD = \text{avg. (noise)} + 3 \times \text{std. dev.}$
- where std. dev. is considered to be equal to noise.
- Limit of Quantification: $LoQ = 3 \times LoD$
- For the purpose of calculating the mass of N_2O , the concentration below LoD shall be considered to be zero.
- 7.2.1.9. Interference verification.
- Interference is any component present in the sample with a retention time similar to that of the target compound described in this method. To reduce interference error, proof of chemical identity may require periodic confirmations using an alternate method or instrumentation.
- 7.3. Sampling and analysis methods for ethanol (C_2H_5OH) (if applicable)
- 7.3.1. Impinger and gas chromatograph analysis of the liquid sample
- 7.3.1.1. Sampling
- Depending on the analytical method, samples may be taken from the diluted exhaust from the CVS.
- From each test phase, a gas sample shall be taken for analysis from the diluted exhaust and dilution air bag for analysis. Alternatively, a single composite dilution background sample may be analysed.

The temperature of the diluted exhaust sample lines shall be more than 3 °C above the maximum dew point of the diluted exhaust and less than 121 °C.

7.3.1.2. Gas chromatographic method

A sample shall be introduced into a gas chromatograph, GC. The alcohols in the sample shall be separated in a GC capillary column and ethanol shall be detected and quantified by a flame ionization detector, FID.

7.3.1.2.1. Sample transfer

Secondary sample storage media may be used to transfer samples from the test cell to the GC lab. Good engineering judgement shall be used to avoid additional dilution when transferring the sample from the sample bags to secondary sample bags.

7.3.1.2.1.1. Secondary sample storage media.

Gas volumes shall be stored in sufficiently clean containers that minimize off-gassing and permeation. Good engineering judgment shall be used to determine acceptable processes and thresholds regarding storage media cleanliness and permeation.

7.3.1.2.1.2. Sample storage

Secondary sample storage bags shall be analysed within 24 hours and shall be stored at room temperature.

7.3.1.2.2. Sampling with impingers

7.3.1.2.2.1. For each test phase, two impingers shall be filled with 15 ml of deionized water and connected in series, and an additional pair of impingers shall be used for background sampling.

7.3.1.2.2.2. Impingers shall be conditioned to ice bath temperature before the sampling collection and shall be kept at that temperature during sample collection.

7.3.1.2.2.3. After sampling, the solution contained in each impinger shall be transferred to a vial and sealed for storage and/or transport before analysis in the laboratory.

7.3.1.2.2.4. Samples shall be refrigerated at a temperature below 5 °C if immediate analysis is not possible and shall be analysed within 6 days.

7.3.1.2.2.5. Good engineering practice shall be used for sample volume and handling.

7.3.1.3. Instrumentation and apparatus

7.3.1.3.1. The sample may be injected directly into the GC or an appropriate pre-concentrator may be used, in which case the pre-concentrator shall be used for all necessary verifications and quality checks.

7.3.1.3.2. A GC column with an appropriate stationary phase of suitable length to achieve adequate resolution of the C₂H₅OH peak shall be used for analysis. The column temperature profile and carrier gas selection shall be taken into consideration when setting up the method selected to achieve adequate C₂H₅OH peak resolution. The operator shall aim for baseline separated peaks.

7.3.1.3.3. Good engineering judgment shall be used to zero the instrument and to correct for drift. An example of good engineering judgement is given in paragraph 7.2.1.3.5. of this annex.

- 7.3.1.4. Reagents and materials
Carrier gases shall have the following minimum purity:
Nitrogen: 99.998 per cent.
Helium: 99.995 per cent.
Hydrogen: 99.995 per cent.
In the case that sampling is performed with impingers:
Liquid standards of C₂H₅OH in pure water: C₂H₅OH 100 per cent, analysis grade.
- 7.3.1.5. Peak integration procedure
The peak integration procedure shall be performed as in paragraph 7.2.1.5. of this annex.
- 7.3.1.6. Linearity
A multipoint calibration to confirm instrument linearity shall be performed according to paragraph 7.2.1.6. of this annex.
- 7.3.1.7. Quality control
- 7.3.1.7.1. A nitrogen or air blank sample run shall be performed before running the calibration standard.
A weekly blank sample run shall provide a check on contamination of the complete system.
A blank sample run shall be performed within one week of the test.
- 7.3.1.7.2. The calibration standard shall be analysed each day of analysis to generate the response factors used to quantify the sample concentrations.
- 7.3.1.7.3. A quality control standard shall be analysed within 24 hours before the analysis of the samples.
- 7.3.1.8. Limit of detection and limit of quantification
The limits of detection and quantification shall be determined according to paragraph 7.2.1.8. of this annex.
- 7.3.1.9. Interference verification
Interference and reducing interference error is described in paragraph 7.2.1.9. of this annex.
- 7.3.2. Alternative methods for the sampling and analysis of ethanol (C₂H₅OH)
- 7.3.2.1. Sampling
Depending on the analytical method, samples may be taken from the diluted exhaust from the CVS.
From each test phase, a gas sample shall be taken for analysis from the diluted exhaust and dilution air bag. Alternatively, a single composite dilution background sample may be analysed.
The temperature of the diluted exhaust sample lines shall be more than 3 °C above the maximum dew point of the diluted exhaust and less than 121 °C.

Frequency of calibration and calibration methods will be adapted to each instrument for the best practice and always respecting the quality control standards.

7.3.2.2. FTIR method

The FTIR system shall be designed for the measurement of diluted exhaust gas directly from the CVS system on a continuous basis and also from the CVS dilution air source, or from the dilution air sample bags.

7.3.2.2.1. Measurement cross interference

The spectral resolution of the target wavelength shall be within 0.5 per cm in order to minimize cross interference from other gases present in the exhaust gas.

The FTIR shall be specifically optimised for the measurement of ethanol in terms of linearization against a traceable standard and also for correction and/or compensation of co-existing interfering gases.

7.3.2.3. Photo-acoustic method

The photo-acoustic analyser shall be specifically designed for the measurement of ethanol in terms of linearization against a traceable standard and also for the correction and/or compensation of co-existing interfering gases.

Calibration shall be performed two times per year using span calibration gas (e.g., ethanol in dry N₂).

7.3.2.4. Proton transfer reaction - mass spectrometry (PTR-MS) method

PTR-MS is a technique based on soft chemical ionization via proton transfer for the detection of volatile organic compounds (VOCs).

The reagent ions should be chosen specifically for the measurement of ethanol e.g., hydronium (H₃O⁺) and to minimize the measurement cross interference of co-existing gases.

The system should be linearised against a traceable standard.

7.3.2.4.1. Calibration method

The analyser response should be periodically calibrated, at least once per month, using a gas consisting of the target analyte of known concentration balanced by a mixture of the coexisting gases at concentrations typically expected from the diluted exhaust sample (e.g. N₂, O₂, H₂O).

7.3.2.5. Direct gas chromatography method

Diluted exhaust shall be collected on a trap and injected into a chromatography column in order to separate its component gases. Calibration of the trap shall be performed by determining the linearity of the system within the range of the expected concentrations from the diluted exhaust (including zero) and confirming the maximum concentration that can be measured without over-charging and saturating the trap.

Ethanol is detected from the column by means of a photo-ionisation detector (PID) or flame ionisation detector (FID).

The system shall be configured to perform specific measurement of ethanol from the applicable WLTC phases.

The system shall be linearised against a traceable standard.

- 7.3.2.5.1. Calibration frequency
Calibrating shall be performed once per week or after maintenance. No compensation is needed.
- 7.4. Sampling and analysis methods for formaldehyde and acetaldehyde (if applicable)
Aldehydes shall be sampled with DNPH-impregnated cartridges. Elution of the cartridges shall be done with acetonitrile. Analysis shall be carried out by high performance liquid chromatography (HPLC), with an ultraviolet (UV) detector at 360 nm or diode array detector (DAD). Carbonyl masses ranging between 0.02 to 200 µg are measured using this method.
- 7.4.1.1. Sampling
Depending on the analytical method, samples may be taken from the diluted exhaust from the CVS.
From each test phase, a gas sample shall be taken from the diluted exhaust and dilution air bag for analysis. Alternatively, a single composite dilution background sample may be analysed.
The temperature of the diluted exhaust sample lines shall be more than 3 °C above the maximum dew point of the diluted exhaust and less than 121 °C.
- 7.4.1.2. Cartridges
DNPH-impregnated cartridges shall be sealed and refrigerated at a temperature less than 4 °C upon receipt from manufacturer until ready for use.
- 7.4.1.2.1. System capacity
The formaldehyde and acetaldehyde sampling system shall be of sufficient capacity so as to enable the collection of samples of adequate size for analysis without significant impact on the volume of the diluted exhaust passing through the CVS.
- 7.4.1.2.2. Sample storage
Samples not analysed within 24 hours of being taken shall be refrigerated at a temperature below 4°C. Refrigerated samples shall not be analysed after more than 30 days of storage.
- 7.4.1.2.3. Sample preparation
The cartridges shall be eluted by removing their caps, extracting with acetonitrile and running the extract into glass storage bottles. The solution shall be transferred from each cartridge to glass vials and sealed with new septum screw caps.
- 7.4.1.2.4. Good engineering practice shall be used to avoid sample breakthrough.
- 7.4.1.3. Instrumentation
A liquid autosampler and either a HPLC-UV or HPLC-DAD shall be used.
- 7.4.1.4. Reagents
The following reagents shall be used:
(a) Acetonitrile, HPLC grade;
(b) Water, HPLC grade;

- (c) 2,4 DNPB, purified; unpurified DNPB shall be recrystallized twice from acetonitrile. The recrystallized DNPB shall be checked for contaminants by injecting a diluted solution of DNPB in contaminant free acetonitrile into the HPLC;
 - (d) Carbonyl/2,4-dinitrophenylhydrazone complexes may be sourced externally or prepared in the laboratory. In-house standards shall be recrystallized at least three times from 95 per cent ethanol;
 - (e) Sulphuric acid, or perchloric acid, analytical reagent grade;
 - (f) DNPB-impregnated cartridges.
- 7.4.1.4.1. Stock solution and calibration standard
- 7.4.1.4.1.1. A stock calibration standard shall be prepared by diluting the target carbonyl/2,4-DNPB complexes with acetonitrile. A typical stock calibration standard contains 3.0 µg/ml of each target carbonyl compound.
- 7.4.1.4.1.2. Stock calibration standards of other concentrations may also be used.
- 7.4.1.4.1.3. A calibration standard shall be prepared when required by diluting the stock calibration solution, ensuring that the highest concentration of the standard is above the expected test level.
- 7.4.1.4.2. Control standard
- A quality control standard, containing all target carbonyls/2,4 DNPB complexes within the typical concentration range of real samples, shall be analysed to monitor the precision of the analysis of each target carbonyl.
- The control standard may be sourced externally, prepared in the laboratory from a stock solution different from the calibration standard, or prepared by batch mixing old samples. The control standard shall be spiked with a stock solution of target compounds and stirred for a minimum of 2 hours. If necessary, the solution shall be filtered using filter paper to remove precipitation.
- 7.4.1.5. Procedure
- 7.4.1.5.1. Vials containing the field blank, calibration standard, control standard, and samples for subsequent injection into the HPLC shall be prepared.
- 7.4.1.5.2. Columns, temperatures and solvent/eluents shall be chosen to achieve adequate peak resolution. Columns of suitable polarity and length shall be used. The method shall specify column, temperature, detector, sample volume, solvents and flow.
- 7.4.1.5.3. Good analytical judgment shall be used to evaluate the quality of the performance of the instrument and all elements of the protocol.
- 7.4.1.6. Linearity
- A multipoint calibration to confirm instrument linearity shall be performed according to paragraph 7.2.1.6.
- 7.4.1.7. Quality control
- 7.4.1.7.1. Field blank
- One cartridge shall be analysed as a field blank for each emission test. If the field blank shows a peak greater than the limit of detection (LOD) in the region of interest, the source of the contamination shall be investigated and remedied.

- 7.4.1.7.2. Calibration run
The calibration standard shall be analysed each day of analysis to generate the response factors used to quantify the sample concentrations.
- 7.4.1.7.3. Control standard
A quality control standard shall be analysed at least once every 7 days.
- 7.4.1.8. Limit of detection and limit of quantification
The LoD for the target analytes shall be determined:
- (a) For new instruments;
 - (b) After making instrument modifications that could affect the LoD; and
 - (c) At least once per year.
- 7.4.1.8.1. A multipoint calibration consisting of at least four “low” concentration levels, each above the LoD, with at least five replicate determinations of the lowest concentration standard, shall be performed.
- 7.4.1.8.2. The maximum allowable LoD of the hydrazine derivative is 0.0075 µg/ml.
- 7.4.1.8.3. The calculated laboratory LoD shall be equal to or lower than the maximum allowable LoD.
- 7.4.1.8.4. All peaks identified as target compounds that are equal to or exceed the maximum allowable LoD shall be recorded.
- 7.4.1.8.5. For the purpose of calculating the total mass of all species, the concentrations of the compounds below the LoD are considered to be zero.

The final mass calculation shall be calculated according to the equation in paragraph 3.2.1.7. of Annex 7.
- 7.4.1.9. Interference verification
To reduce interference error, proof of chemical identity may require periodic confirmations using an alternate method and/or instrumentation, e.g. alternative HPLC columns or mobile phase compositions
- 7.4.2. Alternative methods for sampling and analysing formaldehyde and acetaldehyde
- 7.4.2.1. Sampling
Depending on the analytical method, samples may be taken from the diluted exhaust from the CVS.

From each test phase, a gas sample shall be taken from the diluted exhaust and dilution air bag for analysis. Alternatively, a single composite dilution background sample may be analysed.

The temperature of the diluted exhaust sample lines shall be more than 3 °C above the maximum dew point of the diluted exhaust and less than 121 °C.

Frequency of calibration and calibration methods shall be adapted to each instrument for the best practice and adhering to the quality control standards.
- 7.4.2.2. FTIR method

The FTIR system shall be designed for the measurement of diluted exhaust gas directly from the CVS system on a continuous basis and also from the CVS dilution air source, or from the dilution air sample bags.

7.4.2.2.1. Measurement cross interference

The spectral resolution of the target wavelength shall be within 0.5 per cm in order to minimize cross interference from other gases present in the exhaust gas.

The FTIR shall be specifically optimised for the measurement of acetaldehyde and formaldehyde in terms of linearization against a traceable standard and also for the correction and/or compensation of co-existing interfering gases.

7.4.2.3. Proton transfer reaction - mass spectrometry (PTR-MS) method

PTR-MS is a technique based on soft chemical ionization via proton transfer for the detection of volatile organic compounds (VOCs).

Reagent ions shall be chosen specifically for the measurement of acetaldehyde and formaldehyde, e.g. hydronium (H_3O^+) and to minimize the measurement cross interference of co-existing gases. The system should be linearised against a traceable standard.

7.4.2.3.1. Calibration method

The analyser response should be calibrated periodically, at least once per month, using a gas consisting of the target analyte of known concentration balanced by a mixture of the coexisting gases at concentrations typically expected from the diluted exhaust sample (e.g. N_2 , O_2 , H_2O).

Annex 6

Type 1 test procedures and test conditions

1. Description of tests
 - 1.1. The Type 1 test is used to verify the emissions of gaseous compounds, particulate matter, particle number (if applicable), CO₂ mass emission, fuel consumption, electric energy consumption and electric ranges over the applicable WLTP test cycle.
 - 1.1.1. The tests shall be carried out according to the method described in paragraph 2. of this annex or paragraph 3. of Annex 8 for pure electric, hybrid electric and compressed hydrogen fuel cell hybrid vehicles. Exhaust gases, particulate matter and particle number (if applicable) shall be sampled and analysed by the prescribed methods.
 - 1.2. The number of tests shall be determined according to the flowchart in Figure A6/1. The limit value is the maximum allowed value for the respective criteria emission as defined by the Contracting Party.
 - 1.2.1. The flowchart in Figure A6/1 shall be applicable only to the whole applicable WLTP test cycle and not to single phases.
 - 1.2.2. The test results shall be the values after the REESS energy change-based, Ki and other regional corrections (if applicable) are applied.
 - 1.2.3. Determination of total cycle values
 - 1.2.3.1. If during any of the tests a criteria emissions limit is exceeded, the vehicle shall be rejected.
 - 1.2.3.2. Depending on the vehicle type, the manufacturer shall declare as applicable the total cycle value of the CO₂ mass emission, the electric energy consumption, fuel consumption for NOVC-FCHVs as well as PER and AER according to Table A6/1.
 - 1.2.3.3. The declared value of the electric energy consumption for OVC-HEVs under charge-depleting operating condition shall not be determined according to Figure A6/1. It shall be taken as the type approval value if the declared CO₂ value is accepted as the approval value. If that is not the case, the measured value of electric energy consumption shall be taken as the type approval value. Evidence of a correlation between declared CO₂ mass emission and electric energy consumption shall be submitted to the responsible authority in advance, if applicable.
 - 1.2.3.4. If after the first test all criteria in row 1 of the applicable Table A6/2 are fulfilled, all values declared by the manufacturer shall be accepted as the type approval value. If any one of the criteria in row 1 of the applicable Table A6/2 is not fulfilled, a second test shall be performed with the same vehicle.
 - 1.2.3.5. After the second test, the arithmetic average results of the two tests shall be calculated. If all criteria in row 2 of the applicable Table A6/2 are fulfilled by these arithmetic average results, all values declared by the manufacturer shall be accepted as the type approval value. If any one of the criteria in row 2 of the applicable Table A6/2 is not fulfilled, a third test shall be performed with the same vehicle.

- 1.2.3.6. After the third test, the arithmetic average results of the three tests shall be calculated. For all parameters which fulfil the corresponding criterion in row 3 of the applicable Table A6/2, the declared value shall be taken as the type approval value. For any parameter which does not fulfil the corresponding criterion in row 3 of the applicable Table A6/2, the arithmetic average result shall be taken as the type approval value.
- 1.2.3.7. In the case that any one of the criterion of the applicable Table A6/2 is not fulfilled after the first or second test, at the request of the manufacturer and with the approval of the responsible authority, the values may be re-declared as higher values for emissions or consumption, or as lower values for electric ranges, in order to reduce the required number of tests for type approval.
- 1.2.3.8. Determination of the acceptance values dCO_{21} , dCO_{22} and dCO_{23}
- 1.2.3.8.1. Additional to the requirement of paragraph 1.2.3.8.2., the Contracting Party shall determine a value for dCO_{21} ranging from 0.990 to 1.020, a value for dCO_{22} ranging from 0.995 to 1.020, and a value for dCO_{23} ranging from 1.000 to 1.020 in the Table A6/2.
- 1.2.3.8.2. If the charge depleting Type 1 test for OVC-HEVs consists of two or more applicable WLTP test cycles and the dCO_{2x} value is below 1.0, the dCO_{2x} value shall be replaced by 1.0.
- 1.2.3.9. In the case that a test result or an average of test results was taken and confirmed as the type approval value, this result shall be referred to as the “declared value” for further calculations.

Table A6/1

Applicable rules for a manufacturer’s declared values (total cycle values)^a

| Vehicle type | | $M_{CO_2}^b$ (g/km) | FC (kg/100 km) | Electric energy consumption ^c (Wh/km) | All electric range / Pure Electric Range ^c (km) |
|---|----|--|---|---|--|
| Vehicles tested according to Annex 6 (pure ICE) | | M_{CO_2} Paragraph 3. of Annex 7. | - | - | - |
| NOVC-FCHV | | - | FC _{cs} Paragraph 4.2.1.2.1. of Annex 8. | - | - |
| NOVC-HEV | | $M_{CO_2,CS}$ Paragraph 4.1.1. of Annex 8. | - | - | - |
| OVC-HEV | CD | $M_{CO_2,CD}$ Paragraph 4.1.2. of Annex 8. | - | EC _{AC,CD}} Paragraph 4.3.1. of Annex 8. | AER Paragraph 4.4.1.1. of Annex 8. |
| | CS | $M_{CO_2,CS}$ Paragraph 4.1.1. of Annex 8. | - | - | - |

| Vehicle type | M_{CO_2} ^b (g/km) | FC (kg/100 km) | Electric energy consumption ^c (Wh/km) | All electric range / Pure Electric Range ^c (km) |
|--------------|-----------------------------------|-------------------|---|--|
| PEV | - | - | EC _{WLTC} Paragraph 4.3.4.2. of Annex 8. | PER _{WLTC} Paragraph 4.4.2. of Annex 8. |

^a The declared value shall be the value to which the necessary corrections are applied (i.e. Ki correction and the other regional corrections)

^b Rounding to 2 places of decimal according to paragraph 7. of this UN GTR

^c Rounding to one place of decimal according to paragraph 7. of this UN GTR

Figure A6/1

Flowchart for the number of Type 1 tests

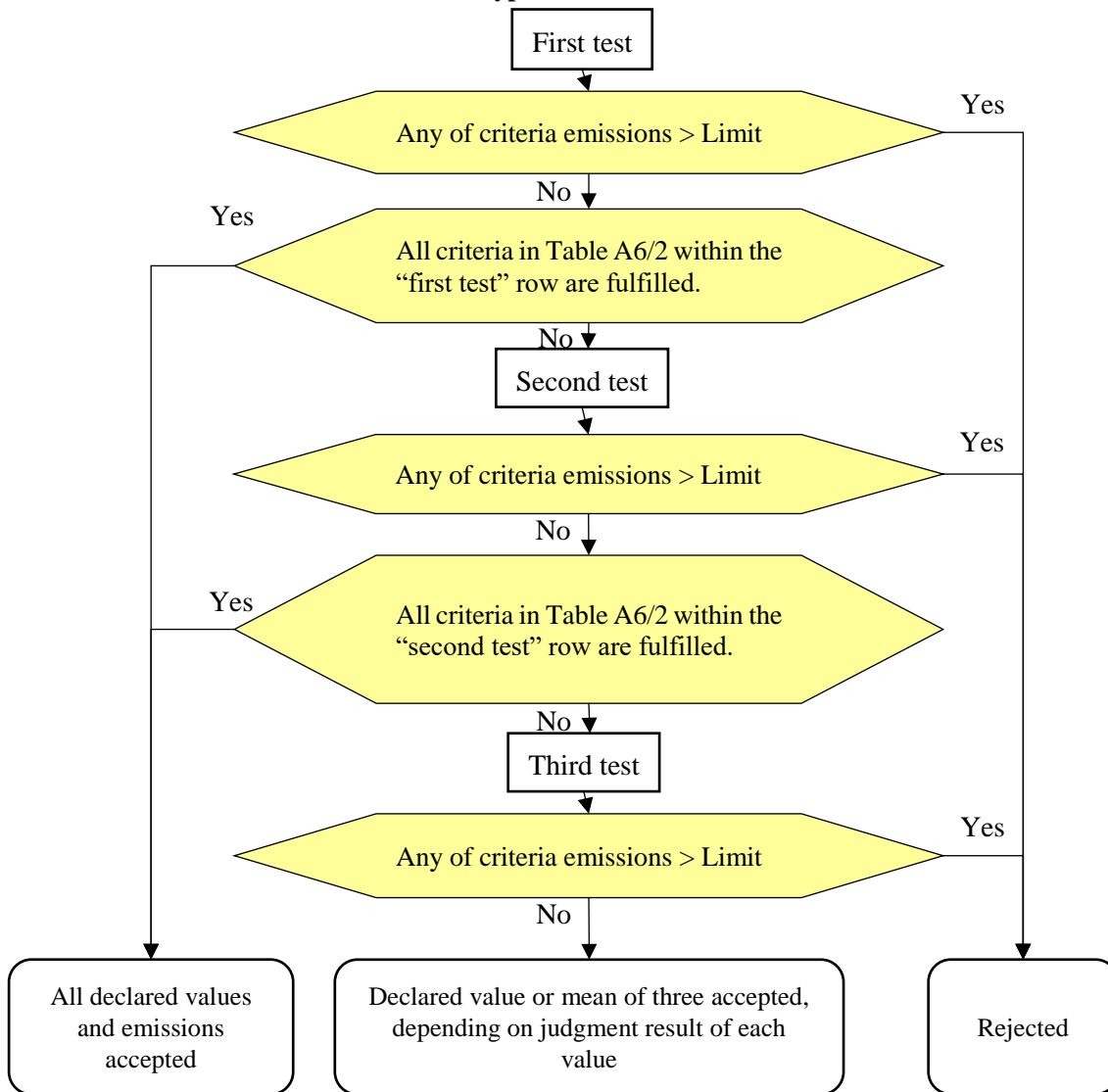

Table A6/2

Criteria for number of tests

For pure ICE vehicles, NOVC-HEVs and OVC-HEVs charge-sustaining Type 1 test.

| | <i>Test</i> | <i>Judgement parameter</i> | <i>Criteria emission</i> | <i>M_{CO2}</i> |
|-------|-------------|---|---|---|
| Row 1 | First test | First test results | \leq Regulation limit \times 0.9 | \leq Declared value \times dCO ₂₁ ^b |
| Row 2 | Second test | Arithmetic average of the first and second test results | \leq Regulation limit \times 1.0 ^a | \leq Declared value \times dCO ₂₂ ^b |
| Row 3 | Third test | Arithmetic average of three test results | \leq Regulation limit \times 1.0 ^a | \leq Declared value \times dCO ₂₃ ^b |

^a Each test result shall fulfil the regulation limit.^b dCO₂₁, dCO₂₂ and dCO₂₃ shall be determined according to paragraph 1.2.3.8. of this annex

For OVC-HEVs charge-depleting Type 1 test.

| | <i>Test</i> | <i>Judgement parameter</i> | <i>Criteria emissions</i> | <i>M_{CO2,CD}</i> | <i>AER</i> |
|-------|-------------|---|---|---|------------------------------------|
| Row 1 | First test | First test results | \leq Regulation limit \times 0.9 ^a | \leq Declared value \times dCO ₂₁ ^c | \geq Declared value \times 1.0 |
| Row 2 | Second test | Arithmetic average of the first and second test results | \leq Regulation limit \times 1.0 ^b | \leq Declared value \times dCO ₂₂ ^c | \geq Declared value \times 1.0 |
| Row 3 | Third test | Arithmetic average of three test results | \leq Regulation limit \times 1.0 ^b | \leq Declared value \times dCO ₂₃ ^c | \geq Declared value \times 1.0 |

^a "0.9" shall be replaced by "1.0" for charge-depleting Type 1 test for OVC-HEVs, only if the charge-depleting test contains two or more applicable WLTC cycles.^b Each test result shall fulfil the regulation limit.^c dCO₂₁, dCO₂₂ and dCO₂₃ shall be determined according to paragraph 1.2.3.8. of this annex.

For PEVs

| | <i>Test</i> | <i>Judgement parameter</i> | <i>Electric energy consumption</i> | <i>PER</i> |
|-------|-------------|---|------------------------------------|------------------------------------|
| Row 1 | First test | First test results | \leq Declared value \times 1.0 | \geq Declared value \times 1.0 |
| Row 2 | Second test | Arithmetic average of the first and second test results | \leq Declared value \times 1.0 | \geq Declared value \times 1.0 |
| Row 3 | Third test | Arithmetic average of three test results | \leq Declared value \times 1.0 | \geq Declared value \times 1.0 |

For NOVC-FCHVs

| | <i>Test</i> | <i>Judgement parameter</i> | <i>FC_{CS}</i> |
|-------|-------------|---|------------------------------------|
| Row 1 | First test | First test results | \leq Declared value \times 1.0 |
| Row 2 | Second test | Arithmetic average of the first and second test results | \leq Declared value \times 1.0 |
| Row 3 | Third test | Arithmetic average of three test results | \leq Declared value \times 1.0 |

1.2.4. Determination of phase-specific values

1.2.4.1. Phase-specific value for CO₂

- 1.2.4.1.1. After the total cycle declared value of the CO₂ mass emission is accepted, the arithmetic average of the phase-specific values of the test results in g/km shall be multiplied by the adjustment factor CO₂_AF to compensate for the difference between the declared value and the test results. This corrected value shall be the type approval value for CO₂.

$$\text{CO}_2\text{_AF} = \frac{\text{Declared value}}{\text{Phase combined value}}$$

where:

$$\text{Phase combined value} = \frac{(\text{CO}_{2\text{aveL}} \times D_L) + (\text{CO}_{2\text{aveM}} \times D_M) + (\text{CO}_{2\text{aveH}} \times D_H) + (\text{CO}_{2\text{aveexH}} \times D_{\text{exH}})}{D_L + D_M + D_H + D_{\text{exH}}}$$

where:

CO_{2aveL} is the arithmetic average CO₂ mass emission result for the L phase test result(s), g/km;

CO_{2aveM} is the arithmetic average CO₂ mass emission result for the M phase test result(s), g/km;

CO_{2aveH} is the arithmetic average CO₂ mass emission result for the H phase test result(s), g/km;

CO_{2aveexH} is the arithmetic average CO₂ mass emission result for the exH phase test result(s), g/km;

D_L is theoretical distance of phase L, km;

D_M is theoretical distance of phase M, km;

D_H is theoretical distance of phase H, km;

D_{exH} is theoretical distance of phase exH, km.

- 1.2.4.1.2. If the total cycle declared value of the CO₂ mass emission is not accepted, the type approval phase-specific CO₂ mass emission value shall be calculated by taking the arithmetic average of the all test results for the respective phase.

1.2.4.2. Phase-specific values for fuel consumption

The fuel consumption value shall be calculated by the phase-specific CO₂ mass emission using the equations in paragraph 1.2.4.1. of this annex and the arithmetic average of the emissions.

1.2.4.3. Phase-specific value for electric energy consumption, PER and AER

The phase-specific electric energy consumption and the phase-specific electric ranges are calculated by taking the arithmetic average of the phase specific values of the test result(s), without an adjustment factor.

2. Type 1 test

2.1. Overview

- 2.1.1. The Type 1 test shall consist of prescribed sequences of dynamometer preparation, fuelling, soaking, and operating conditions.

- 2.1.2. The Type 1 test shall consist of vehicle operation on a chassis dynamometer on the applicable WLTC for the interpolation family. A proportional part of the diluted exhaust emissions shall be collected continuously for subsequent analysis using a constant volume sampler.
- 2.1.3. Background concentrations shall be measured for all compounds for which dilute mass emissions measurements are conducted. For exhaust emissions testing, this requires sampling and analysis of the dilution air.
- 2.1.3.1. Background particulate measurement
- 2.1.3.1.1. Where the manufacturer requests and the Contracting Party permits subtraction of either dilution air or dilution tunnel background particulate mass from emissions measurements, these background levels shall be determined according to the procedures listed in paragraphs 2.1.3.1.1.1. to 2.1.3.1.1.3. inclusive of this annex.
- 2.1.3.1.1.1. The maximum permissible background correction shall be a mass on the filter equivalent to 1 mg/km at the flow rate of the test.
- 2.1.3.1.1.2. If the background exceeds this level, the default figure of 1 mg/km shall be subtracted.
- 2.1.3.1.1.3. Where subtraction of the background contribution gives a negative result, the background level shall be considered to be zero.
- 2.1.3.1.2. Dilution air background particulate mass level shall be determined by passing filtered dilution air through the particulate background filter. This shall be drawn from a point immediately downstream of the dilution air filters. Background levels in $\mu\text{g}/\text{m}^3$ shall be determined as a rolling arithmetic average of at least 14 measurements with at least one measurement per week.
- 2.1.3.1.3. Dilution tunnel background particulate mass level shall be determined by passing filtered dilution air through the particulate background filter. This shall be drawn from the same point as the particulate matter sample. Where secondary dilution is used for the test, the secondary dilution system shall be active for the purposes of background measurement. One measurement may be performed on the day of test, either prior to or after the test.
- 2.1.3.2. Background particle number determination (if applicable)
- 2.1.3.2.1. Where the Contracting Party permits subtraction of either dilution air or dilution tunnel background particle number from emissions measurements and a manufacturer requests a background correction, these background levels shall be determined as follows:
- 2.1.3.2.1.1. The background value may be either calculated or measured. The maximum permissible background correction shall be related to the maximum allowable leak rate of the particle number measurement system (0.5 particles per cm^3) scaled from the particle concentration reduction factor, PCRf, and the CVS flow rate used in the actual test;
- 2.1.3.2.1.2. Either the Contracting Party or the manufacturer may request that actual background measurements are used instead of calculated ones.
- 2.1.3.2.1.3. Where subtraction of the background contribution gives a negative result, the PN result shall be considered to be zero.
- 2.1.3.2.2. The dilution air background particle number level shall be determined by sampling filtered dilution air. This shall be drawn from a point immediately

downstream of the dilution air filters into the PN measurement system. Background levels in particles per cm³ shall be determined as a rolling arithmetic average of least 14 measurements with at least one measurement per week.

2.1.3.2.3. The dilution tunnel background particle number level shall be determined by sampling filtered dilution air. This shall be drawn from the same point as the PN sample. Where secondary dilution is used for the test the secondary dilution system shall be active for the purposes of background measurement. One measurement may be performed on the day of test, either prior to or after the test using the actual PCRF and the CVS flow rate utilised during the test.

2.2. General test cell equipment

2.2.1. Parameters to be measured

2.2.1.1. The following temperatures shall be measured with an accuracy of ± 1.5 °C:

- (a) Test cell ambient air;
- (b) Dilution and sampling system temperatures as required for emissions measurement systems defined in Annex 5.

2.2.1.2. Atmospheric pressure shall be measurable with a precision of ± 0.1 kPa.

2.2.1.3. Specific humidity H shall be measurable with a precision of ± 1 g H₂O/kg dry air.

2.2.2. Test cell and soak area

2.2.2.1. Test cell

2.2.2.1.1. The test cell shall have a temperature set point of 23 °C. The tolerance of the actual value shall be within ± 5 °C. The air temperature and humidity shall be measured at the test cell's cooling fan outlet at a minimum frequency of 0.1 Hz. For the temperature at the start of the test, see paragraph 2.8.1. of this annex.

2.2.2.1.2. The specific humidity H of either the air in the test cell or the intake air of the engine shall be such that:

$$5.5 \leq H \leq 12.2 \text{ (g H}_2\text{O/kg dry air)}$$

2.2.2.1.3. Humidity shall be measured continuously at a minimum frequency of 0.1 Hz.

2.2.2.2. Soak area

The soak area shall have a temperature set point of 23 °C and the tolerance of the actual value shall be within ± 3 °C on a 5-minute running arithmetic average and shall not show a systematic deviation from the set point. The temperature shall be measured continuously at a minimum frequency of 0.033 Hz (every 30 s).

2.3. Test vehicle

2.3.1. General

The test vehicle shall conform in all its components with the production series, or, if the vehicle is different from the production series, a full description shall be recorded. In selecting the test vehicle, the manufacturer and the responsible authority shall agree which vehicle model is representative for the interpolation family.

For the measurement of emissions, the road load as determined with test vehicle H shall be applied. In the case of a road load matrix family, for the measurement of emissions, the road load as calculated for vehicle H_M according to paragraph 5.1. of Annex 4 shall be applied.

If at the request of the manufacturer the interpolation method is used (see paragraph 3.2.3.2. of Annex 7), an additional measurement of emissions shall be performed with the road load as determined with test vehicle L. Tests on vehicles H and L should be performed with the same test vehicle and shall be tested with the shortest n/v ratio (with a tolerance of ± 1.5 per cent) within the interpolation family. In the case of a road load matrix family, an additional measurement of emissions shall be performed with the road load as calculated for vehicle L_M according to paragraph 5.1. of Annex 4.

Road load coefficients and the test mass of test vehicle L and H may be taken from different road load families, as long as the difference between these road load families results from applying paragraph 6.8. of Annex 4, and the requirements in paragraph 2.3.2. of this annex are maintained.

2.3.2. CO₂ interpolation range

2.3.2.1. The interpolation method shall only be used if the difference in CO₂ over the applicable cycle resulting from step 9 in Table A7/1 of Annex 7 between test vehicles L and H is between a minimum of 5 g/km and a maximum defined in paragraph 2.3.2.2. of this annex.

2.3.2.2. The maximum difference in CO₂ emissions allowed over the applicable cycle resulting from step 9 in Table A7/1 of Annex 7 between test vehicles L and H shall be 20 per cent plus 5 g/km of the CO₂ emissions from vehicle H, but at least 15 g/km and not exceeding 30 g/km. See Figure A6/2.

Figure A6/2

Interpolation range for pure ICE vehicles

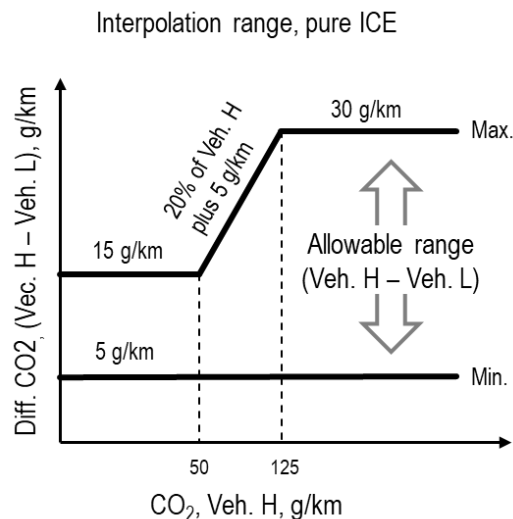

This restriction does not apply for the application of a road load matrix family or when the calculation of the road load of vehicles L and H is based on the default road load.

2.3.2.2.1. The allowed interpolation range defined in paragraph 2.3.2.2. of this annex may be increased by 10 g/km CO₂ (see Figure A6/3) if a vehicle M is tested

within that family and the conditions according to paragraph 2.3.2.4. of this annex are fulfilled. This increase is allowed only once within an interpolation family.

Figure A6/3

Interpolation range for pure ICE vehicles with vehicle M

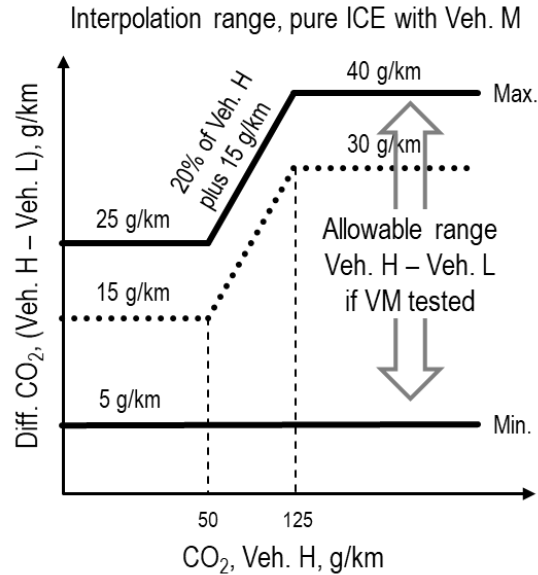

2.3.2.3. At the request of the manufacturer and with approval of the responsible authority, the application of the interpolation method on individual vehicle values within a family may be extended if the maximum extrapolation is not more than 3 g/km above the CO₂ emission of vehicle H and/or is not more than 3 g/km below the CO₂ emission of vehicle L. This extrapolation is valid only within the absolute boundaries of the interpolation range specified in paragraph 2.3.2.2.

For the application of a road load matrix family, extrapolation is not permitted.

2.3.2.4. Vehicle M

Vehicle M is a vehicle within the interpolation family between the vehicles L and H with a cycle energy demand which is preferably closest to the average of vehicles L and H.

The limits of the selection of vehicle M (see Figure A6/4) are such that neither the difference in CO₂ emission values between vehicles H and M nor the difference in CO₂ emission values between vehicles M and L is greater than the allowed CO₂ range in accordance with paragraph 2.3.2.2. of this annex. The defined road load coefficients and the defined test mass shall be recorded.

Figure A6/4
Limits for the selection of vehicle M

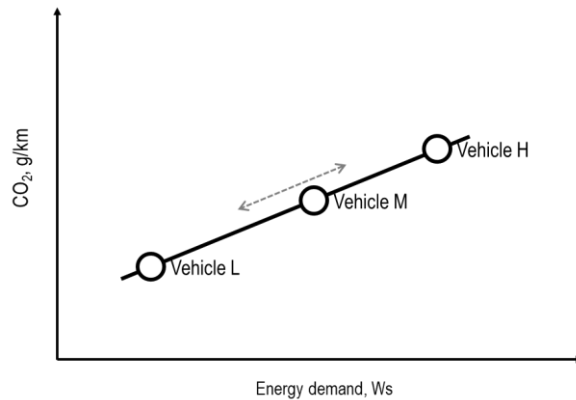

The linearity of CO₂ mass emission for vehicle M shall be verified against the linearly interpolated CO₂ mass emission between vehicles L and H over the applicable cycle by using the corrected measured values referring to the step used in Table 7/1 of Annex 7.

The linearity criterion for vehicle M (see Figure A6/5) shall be considered fulfilled, if the CO₂ mass emission of the vehicle M over the applicable WLTC minus the CO₂ mass emission derived by interpolation is less 2 g/km or 3 per cent of the interpolated value, whichever value is lower, but at least 1 g/km.

Figure A6/5
Linearity criterion for vehicle M

Tolerance, Vehicle M measured vs. calculated

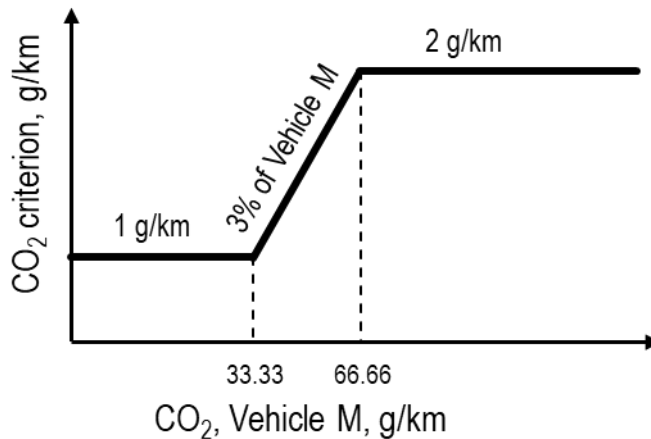

If the linearity criterion is fulfilled, the CO₂ values of individual vehicles shall be interpolated between vehicles L and H.

If the linearity criterion is not fulfilled, the interpolation family shall be split into two sub-families for vehicles with a cycle energy demand between vehicles L and M, and vehicles with a cycle energy demand between vehicles M and H. In such a case, the final CO₂ mass emissions of vehicle M shall be determined in accordance with the same process as for vehicles L or H. See step 9 in Table 7/1 of Annex 7.

For vehicles with a cycle energy demand between that of vehicles L and M, each parameter of vehicle H necessary for the application of the interpolation method on individual values shall be substituted by the corresponding parameter of vehicle M.

For vehicles with a cycle energy demand between that of vehicles M and H, each parameter of vehicle L necessary for the application of the interpolation method on individual values shall be substituted by the corresponding parameter of vehicle M.

2.3.3. Run-in

The vehicle shall be presented in good technical condition. It shall have been run-in and driven between 3,000 and 15,000 km before the test. The engine, transmission and vehicle shall be run-in in accordance with the manufacturer's recommendations.

2.4. Settings

2.4.1. Dynamometer settings and verification shall be performed according to Annex 4.

2.4.2. Dynamometer operation

2.4.2.1. Auxiliary devices shall be switched off or deactivated during dynamometer operation unless their operation is required by regional legislation.

2.4.2.2. The vehicle's dynamometer operation mode, if any, shall be activated by using the manufacturer's instruction (e.g. using vehicle steering wheel buttons in a special sequence, using the manufacturer's workshop tester, removing a fuse).

The manufacturer shall provide the responsible authority a list of the deactivated devices and justification for the deactivation. The dynamometer operation mode shall be approved by the responsible authority and the use of a dynamometer operation mode shall be recorded.

2.4.2.3. The vehicle's dynamometer operation mode shall not activate, modulate, delay or deactivate the operation of any part that affects the emissions and fuel consumption under the test conditions. Any device that affects the operation on a chassis dynamometer shall be set to ensure a proper operation.

2.4.3. The vehicle's exhaust system shall not exhibit any leak likely to reduce the quantity of gas collected.

2.4.4. The settings of the powertrain and vehicle controls shall be those prescribed by the manufacturer for series production.

2.4.5. Tyres shall be of a type specified as original equipment by the vehicle manufacturer. Tyre pressure may be increased by up to 50 per cent above the pressure specified in paragraph 4.2.2.3. of Annex 4. The same tyre pressure shall be used for the setting of the dynamometer and for all subsequent testing. The tyre pressure used shall be recorded.

2.4.6. Reference fuel

The appropriate reference fuel as specified in Annex 3 shall be used for testing.

2.4.7. Test vehicle preparation

2.4.7.1. The vehicle shall be approximately horizontal during the test so as to avoid any abnormal distribution of the fuel.

- 2.4.7.2. If necessary, the manufacturer shall provide additional fittings and adapters, as required to accommodate a fuel drain at the lowest point possible in the tank(s) as installed on the vehicle, and to provide for exhaust sample collection.
- 2.4.7.3. For PM sampling during a test when the regenerating device is in a stabilized loading condition (i.e. the vehicle is not undergoing a regeneration), it is recommended that the vehicle has completed more than 1/3 of the mileage between scheduled regenerations or that the periodically regenerating device has undergone equivalent loading off the vehicle.
- 2.5. Preliminary testing cycles
- Preliminary testing cycles may be carried out if requested by the manufacturer to follow the speed trace within the prescribed limits.
- 2.6. Test vehicle preconditioning
- 2.6.1. Vehicle preparation
- 2.6.1.1. Fuel tank filling
- The fuel tank(s) shall be filled with the specified test fuel. If the existing fuel in the fuel tank(s) does not meet the specifications contained in paragraph 2.4.6. of this annex, the existing fuel shall be drained prior to the fuel fill. The evaporative emission control system shall neither be abnormally purged nor abnormally loaded.
- 2.6.1.2. REESSs charging
- Before the preconditioning test cycle, the REESSs shall be fully charged. At the request of the manufacturer, charging may be omitted before preconditioning. The REESSs shall not be charged again before official testing.
- 2.6.1.3. Tyre pressures
- The tyre pressure of the driving wheels shall be set in accordance with paragraph 2.4.5. of this annex.
- 2.6.1.4. Gaseous fuel vehicles
- Between the tests on the first gaseous reference fuel and the second gaseous reference fuel, for vehicles with positive ignition engines fuelled with LPG or NG/biomethane or so equipped that they can be fuelled with either petrol or LPG or NG/biomethane, the vehicle shall be preconditioned again before the test on the second reference fuel. Between the tests on the first gaseous reference fuel and the second gaseous reference fuel, for vehicles with positive ignition engines fuelled with LPG or NG/biomethane or so equipped that they can be fuelled with either petrol or LPG or NG/biomethane, the vehicle shall be preconditioned again before the test on the second reference fuel.
- 2.6.2. Test cell
- 2.6.2.1. Temperature
- During preconditioning, the test cell temperature shall be the same as defined for the Type 1 test (paragraph 2.2.2.1.1. of this annex).
- 2.6.2.2. Background measurement
- In a test facility in which there may be possible contamination of a low particulate emitting vehicle test with residue from a previous test on a high

particulate emitting vehicle, it is recommended, for the purpose of sampling equipment preconditioning, that a 120 km/h steady state drive cycle of 20 minutes duration be driven by a low particulate emitting vehicle. Longer and/or higher speed running is permissible for sampling equipment preconditioning if required. Dilution tunnel background measurements, if applicable, shall be taken after the tunnel preconditioning, and prior to any subsequent vehicle testing.

2.6.3. Procedure

2.6.3.1. The test vehicle shall be placed, either by being driven or pushed, on a dynamometer and operated through the applicable WLTCs. The vehicle need not be cold, and may be used to set the dynamometer load.

2.6.3.2. The dynamometer load shall be set according to paragraphs 7. and 8. of Annex 4.

2.6.4. Operating the vehicle

2.6.4.1. The powertrain start procedure shall be initiated by means of the devices provided for this purpose according to the manufacturer's instructions.

A non-vehicle initiated switching of mode of operation during the test shall not be permitted unless otherwise specified.

2.6.4.1.1. If the initiation of the powertrain start procedure is not successful, e.g. the engine does not start as anticipated or the vehicle displays a start error, the test is void, preconditioning tests shall be repeated and a new test shall be driven.

2.6.4.1.2. In the cases where LPG or NG/biomethane is used as a fuel, it is permissible that the engine is started on petrol and switched automatically to LPG or NG/biomethane after a predetermined period of time that cannot be changed by the driver. This period of time shall not exceed 60 seconds.

It is also permissible to use petrol only or simultaneously with gas when operating in gas mode provided that the energy consumption of gas is higher than 80 per cent of the total amount of energy consumed during the Type 1 test. This percentage shall be calculated in accordance with the method set out in Appendix 3 to this annex.

2.6.4.2. The cycle starts on initiation of the powertrain start procedure.

2.6.4.3. For preconditioning, the applicable WLTC shall be driven.

At the request of the manufacturer or the responsible authority, additional WLTCs may be performed in order to bring the vehicle and its control systems to a stabilized condition.

The extent of such additional preconditioning shall be recorded.

2.6.4.4. Accelerations

The vehicle shall be operated with the necessary accelerator control movement to accurately follow the speed trace.

The vehicle shall be operated smoothly following representative shift speeds and procedures.

For manual transmissions, the accelerator control shall be released during each shift and the shift shall be accomplished in minimum time.

If the vehicle cannot follow the speed trace, it shall be operated at maximum available power until the vehicle speed reaches the respective target speed again.

2.6.4.5. Deceleration

During decelerations, the driver shall deactivate the accelerator control but shall not manually disengage the clutch until the point specified in paragraphs 4.(d), 4.(e) or 4.(f) of Annex 2.

If the vehicle decelerates faster than prescribed by the speed trace, the accelerator control shall be operated such that the vehicle accurately follows the speed trace.

If the vehicle decelerates too slowly to follow the intended deceleration, the brakes shall be applied such that it is possible to accurately follow the speed trace.

2.6.4.6. Brake application

During stationary/idling vehicle phases, the brakes shall be applied with appropriate force to prevent the drive wheels from turning.

2.6.5. Use of the transmission

2.6.5.1. Manual shift transmissions

2.6.5.1.1. The gear shift prescriptions specified in Annex 2 shall be followed. Vehicles tested according to Annex 8 shall be driven according to paragraph 1.5. of that annex.

2.6.5.1.2. The gear change shall be started and completed within ± 1.0 second of the prescribed gear shift point.

2.6.5.1.3. The clutch shall be depressed within ± 1.0 second of the prescribed clutch operating point.

2.6.5.2. Automatic shift transmissions

2.6.5.2.1. After initial engagement, the selector shall not be operated at any time during the test. Initial engagement shall be done 1 second before beginning the first acceleration.

2.6.5.2.2. Vehicles with an automatic transmission with a manual mode shall not be tested in manual mode.

2.6.6. Driver-selectable modes

2.6.6.1. Vehicles equipped with a predominant mode shall be tested in that mode. At the request of the manufacturer, the vehicle may alternatively be tested with the driver-selectable mode in the worst-case position for CO₂ emissions.

2.6.6.2. The manufacturer shall provide evidence to the responsible authority of the existence of a mode that fulfils the requirements of paragraph 3.5.9. of this UN GTR. With the agreement of the responsible authority, the predominant mode may be used as the only mode for the determination of criteria emissions, CO₂ emissions, and fuel consumption.

2.6.6.3. If the vehicle has no predominant mode or the requested predominant mode is not agreed by the responsible authority as being a predominant mode, the vehicle shall be tested in the best case mode and worst case mode for criteria emissions, CO₂ emissions, and fuel consumption. Best and worst case modes

shall be identified by the evidence provided on the CO₂ emissions and fuel consumption in all modes. CO₂ emissions and fuel consumption shall be the arithmetic average of the test results in both modes. Test results for both modes shall be recorded.

At the request of the manufacturer, the vehicle may alternatively be tested with the driver-selectable mode in the worst case position for CO₂ emissions.

- 2.6.6.4. On the basis of technical evidence provided by the manufacturer and with the agreement of the responsible authority, the dedicated driver-selectable modes for very special limited purposes shall not be considered (e.g. maintenance mode, crawler mode). All remaining modes used for forward driving shall be considered and the criteria emissions limits shall be fulfilled in all these modes.
- 2.6.6.5. Paragraphs 2.6.6.1. to 2.6.6.4. inclusive of this annex shall apply to all vehicle systems with driver-selectable modes, including those not solely specific to the transmission.
- 2.6.7. Voiding of the Type 1 test and completion of the cycle
- If the engine stops unexpectedly, the preconditioning or Type 1 test shall be declared void.
- After completion of the cycle, the engine shall be switched off. The vehicle shall not be restarted until the beginning of the test for which the vehicle has been preconditioned.
- 2.6.8. Data required, quality control
- 2.6.8.1. Speed measurement
- During the preconditioning, speed shall be measured against time or collected by the data acquisition system at a frequency of not less than 1 Hz so that the actual driven speed can be assessed.
- 2.6.8.2. Distance travelled
- The distance actually driven by the vehicle shall be recorded for each WLTC phase.
- 2.6.8.3. Speed trace tolerances
- Vehicles that cannot attain the acceleration and maximum speed values required in the applicable WLTC shall be operated with the accelerator control fully activated until they once again reach the required speed trace. Speed trace violations under these circumstances shall not void a test. Deviations from the driving cycle shall be recorded.
- 2.6.8.3.1. The following tolerances shall be permitted between the actual vehicle speed and the prescribed speed of the applicable test cycles, but shall not be shown to the driver:
- (a) Upper limit: 2.0 km/h higher than the highest point of the trace within ± 1.0 second of the given point in time;
- (b) Lower limit: 2.0 km/h lower than the lowest point of the trace within ± 1.0 second of the given time.
- See Figure A6/6.
- Speed tolerances greater than those prescribed shall be accepted provided the tolerances are never exceeded for more than 1 second on any one occasion.

There shall be no more than ten such deviations per test cycle.

Figure A6/6
Speed trace tolerances

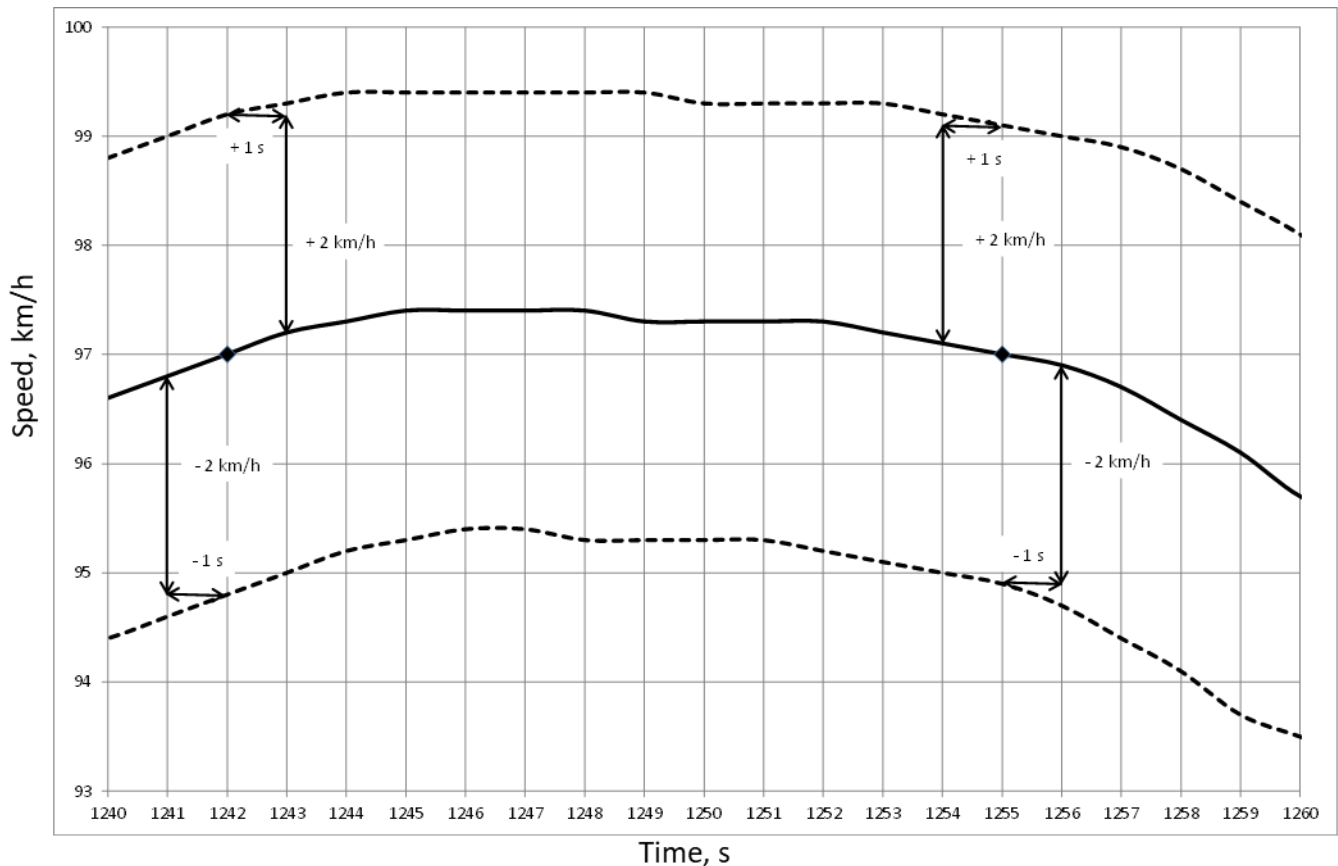

- 2.7. Soaking
- 2.7.1. After preconditioning and before testing, the test vehicle shall be kept in an area with ambient conditions as specified in paragraph 2.2.2.2. of this annex.
- 2.7.2. The vehicle shall be soaked for a minimum of 6 hours and a maximum of 36 hours with the engine compartment cover opened or closed. If not excluded by specific provisions for a particular vehicle, cooling may be accomplished by forced cooling down to the set point temperature. If cooling is accelerated by fans, the fans shall be placed so that the maximum cooling of the drive train, engine and exhaust after-treatment system is achieved in a homogeneous manner.
- 2.8. Emission and fuel consumption test (Type 1 test)
- 2.8.1. The test cell temperature at the start of the test shall be $23\text{ °C} \pm 3\text{ °C}$. The engine oil temperature and coolant temperature, if any, shall be within $\pm 2\text{ °C}$ of the set point of 23 °C .
- 2.8.2. The test vehicle shall be pushed onto a dynamometer.
- 2.8.2.1. The drive wheels of the vehicle shall be placed on the dynamometer without starting the engine.

- 2.8.2.2. The drive-wheel tyre pressures shall be set in accordance with the provisions of paragraph 2.4.5. of this annex.
- 2.8.2.3. The engine compartment cover shall be closed.
- 2.8.2.4. An exhaust connecting tube shall be attached to the vehicle tailpipe(s) immediately before starting the engine.
- 2.8.3. Starting of the powertrain and driving
 - 2.8.3.1. The powertrain start procedure shall be initiated by means of the devices provided for this purpose according to the manufacturer's instructions.
 - 2.8.3.2. The vehicle shall be driven as described in paragraphs 2.6.4. to 2.6.8. inclusive of this annex over the applicable WLTC, as described in Annex 1.
- 2.8.4. RCB data shall be measured for each phase of the WLTC as defined in Appendix 2 to this annex.
- 2.8.5. Actual vehicle speed shall be sampled with a measurement frequency of 10 Hz and the drive trace indices described in paragraph 7. of Annex 7 shall be calculated and documented. If either IWR or RMSSE is outside the respective validity range, the Type 1 test shall be considered invalid.
- 2.9. Gaseous sampling
 - Gaseous samples shall be collected in bags and the compounds analysed at the end of the test or a test phase, or the compounds may be analysed continuously and integrated over the cycle.
 - 2.9.1. The following steps shall be taken prior to each test:
 - 2.9.1.1. The purged, evacuated sample bags shall be connected to the dilute exhaust and dilution air sample collection systems.
 - 2.9.1.2. Measuring instruments shall be started according to the instrument manufacturer's instructions.
 - 2.9.1.3. The CVS heat exchanger (if installed) shall be pre-heated or pre-cooled to within its operating test temperature tolerance as specified in paragraph 3.3.5.1. of Annex 5.
 - 2.9.1.4. Components such as sample lines, filters, chillers and pumps shall be heated or cooled as required until stabilised operating temperatures are reached.
 - 2.9.1.5. CVS flow rates shall be set according to paragraph 3.3.4. of Annex 5, and sample flow rates shall be set to the appropriate levels.
 - 2.9.1.6. Any electronic integrating device shall be zeroed and may be re-zeroed before the start of any cycle phase.
 - 2.9.1.7. For all continuous gas analysers, the appropriate ranges shall be selected. These may be switched during a test only if switching is performed by changing the calibration over which the digital resolution of the instrument is applied. The gains of an analyser's analogue operational amplifiers may not be switched during a test.
 - 2.9.1.8. All continuous gas analysers shall be zeroed and calibrated using gases fulfilling the requirements of paragraph 6. of Annex 5.
 - 2.10. Sampling for PM determination

- 2.10.1. The steps described in paragraphs 2.10.1.1. to 2.10.1.2.2. inclusive of this annex shall be taken prior to each test.
- 2.10.1.1. Filter selection
- A single particulate sample filter without back-up shall be employed for the complete applicable WLTC. In order to accommodate regional cycle variations, a single filter may be employed for the first three phases and a separate filter for the fourth phase.
- 2.10.1.2. Filter preparation
- 2.10.1.2.1. At least 1 hour before the test, the filter shall be placed in a petri dish protecting against dust contamination and allowing air exchange, and placed in a weighing chamber (or room) for stabilization.
- At the end of the stabilization period, the filter shall be weighed and its weight shall be recorded. The filter shall subsequently be stored in a closed petri dish or sealed filter holder until needed for testing. The filter shall be used within 8 hours of its removal from the weighing chamber (or room).
- The filter shall be returned to the stabilization room within 1 hour after the test and shall be conditioned for at least 1 hour before weighing.
- 2.10.1.2.2. The particulate sample filter shall be carefully installed into the filter holder. The filter shall be handled only with forceps or tongs. Rough or abrasive filter handling will result in erroneous weight determination. The filter holder assembly shall be placed in a sample line through which there is no flow.
- 2.10.1.2.3. It is recommended that the microbalance be checked at the start of each weighing session, within 24 hours of the sample weighing, by weighing one reference item of approximately 100 mg. This item shall be weighed three times and the arithmetic average result recorded. If the arithmetic average result of the weighings is $\pm 5 \mu\text{g}$ of the result from the previous weighing session, the weighing session and balance are considered valid.
- 2.11. PN sampling (if applicable)
- 2.11.1. The steps described in paragraphs 2.11.1.1. to 2.11.1.2. inclusive of this annex shall be taken prior to each test:
- 2.11.1.1. The particle specific dilution system and measurement equipment shall be started and made ready for sampling;
- 2.11.1.2. The correct function of the PNC and VPR elements of the particle sampling system shall be confirmed according to the procedures listed in paragraphs 2.11.1.2.1. to 2.11.1.2.4. inclusive of this annex.
- 2.11.1.2.1. A leak check, using a filter of appropriate performance attached to the inlet of the entire PN measurement system, VPR and PNC, shall report a measured concentration of less than 0.5 particles per cm^3 .
- 2.11.1.2.2. Each day, a zero check on the PNC, using a filter of appropriate performance at the PNC inlet, shall report a concentration of ≤ 0.2 particles per cm^3 . Upon removal of the filter, the PNC shall show an increase in measured concentration to at least 100 particles per cm^3 when sampling ambient air and a return to ≤ 0.2 particles per cm^3 on replacement of the filter.
- 2.11.1.2.3. It shall be confirmed that the measurement system indicates that the evaporation tube, where featured in the system, has reached its correct operating temperature.

- 2.11.1.2.4. It shall be confirmed that the measurement system indicates that the diluter PND₁ has reached its correct operating temperature.
- 2.12. Sampling during the test
 - 2.12.1. The dilution system, sample pumps and data collection system shall be started.
 - 2.12.2. The PM and, if applicable, PN sampling systems shall be started.
 - 2.12.3. Particle number, if applicable, shall be measured continuously. The arithmetic average concentration shall be determined by integrating the analyser signals over each phase.
 - 2.12.4. Sampling shall begin before or at the initiation of the powertrain start procedure and end on conclusion of the cycle.
 - 2.12.5. Sample switching
 - 2.12.5.1. Gaseous emissions

Sampling from the diluted exhaust and dilution air shall be switched from one pair of sample bags to subsequent bag pairs, if necessary, at the end of each phase of the applicable WLTC to be driven.
 - 2.12.5.2. Particulate

The requirements of paragraph 2.10.1.1. of this annex shall apply.
 - 2.12.6. Dynamometer distance shall be recorded for each phase.
- 2.13. Ending the test
 - 2.13.1. The engine shall be turned off immediately after the end of the last part of the test.
 - 2.13.2. The constant volume sampler, CVS, or other suction device shall be turned off, or the exhaust tube from the tailpipe or tailpipes of the vehicle shall be disconnected.
 - 2.13.3. The vehicle may be removed from the dynamometer.
- 2.14. Post-test procedures
 - 2.14.1. Gas analyser check

Zero and calibration gas reading of the analysers used for continuous diluted measurement shall be checked. The test shall be considered acceptable if the difference between the pre-test and post-test results is less than 2 per cent of the calibration gas value.
 - 2.14.2. Bag analysis
 - 2.14.2.1. Exhaust gases and dilution air contained in the bags shall be analysed as soon as possible. Exhaust gases shall, in any event, be analysed not later than 30 minutes after the end of the cycle phase.

The gas reactivity time for compounds in the bag shall be taken into consideration.
 - 2.14.2.2. As soon as practical prior to analysis, the analyser range to be used for each compound shall be set to zero with the appropriate zero gas.
 - 2.14.2.3. The calibration curves of the analysers shall be set by means of calibration gases of nominal concentrations of 70 to 100 per cent of the range.

- 2.14.2.4. The zero settings of the analysers shall be subsequently rechecked: if any reading differs by more than 2 per cent of the range from that set in paragraph 2.14.2.2. of this annex, the procedure shall be repeated for that analyser.
- 2.14.2.5. The samples shall be subsequently analysed.
- 2.14.2.6. After the analysis, zero and calibration points shall be rechecked using the same gases. The test shall be considered acceptable if the difference is less than 2 per cent of the calibration gas value.
- 2.14.2.7. The flow rates and pressures of the various gases through analysers shall be the same as those used during calibration of the analysers.
- 2.14.2.8. The content of each of the compounds measured shall be recorded after stabilization of the measuring device.
- 2.14.2.9. The mass and number of all emissions, where applicable, shall be calculated according to Annex 7.
- 2.14.2.10. Calibrations and checks shall be performed either:
- (a) Before and after each bag pair analysis; or
 - (b) Before and after the complete test.
- In case (b), calibrations and checks shall be performed on all analysers for all ranges used during the test.
- In both cases, (a) and (b), the same analyser range shall be used for the corresponding ambient air and exhaust bags.
- 2.14.3. Particulate sample filter weighing
- 2.14.3.1. The particulate sample filter shall be returned to the weighing chamber (or room) no later than 1 hour after completion of the test. It shall be conditioned in a petri dish, which is protected against dust contamination and allows air exchange, for at least 1 hour, and weighed. The gross weight of the filter shall be recorded.
- 2.14.3.2. At least two unused reference filters shall be weighed within 8 hours of, but preferably at the same time as, the sample filter weighings. Reference filters shall be of the same size and material as the sample filter.
- 2.14.3.3. If the specific weight of any reference filter changes by more than $\pm 5\mu\text{g}$ between sample filter weighings, the sample filter and reference filters shall be reconditioned in the weighing chamber (or room) and reweighed.
- 2.14.3.4. The comparison of reference filter weighings shall be made between the specific weights and the rolling arithmetic average of that reference filter's specific weights. The rolling arithmetic average shall be calculated from the specific weights collected in the period after the reference filters were placed in the weighing chamber (or room). The averaging period shall be at least one day but not more than 15 days.
- 2.14.3.5. Multiple reconditionings and reweighings of the sample and reference filters are permitted until a period of 80 hours has elapsed following the measurement of gases from the emissions test. If, prior to or at the 80-hour point, more than half the number of reference filters meet the $\pm 5\mu\text{g}$ criterion, the sample filter weighing may be considered valid. If, at the 80-hour point, two reference filters are employed and one filter fails the $\pm 5\mu\text{g}$ criterion, the sample filter weighing

may be considered valid under the condition that the sum of the absolute differences between specific and rolling means from the two reference filters shall be less than or equal to 10 µg.

- 2.14.3.6. In the case that less than half of the reference filters meet the ± 5 µg criterion, the sample filter shall be discarded, and the emissions test repeated. All reference filters shall be discarded and replaced within 48 hours. In all other cases, reference filters shall be replaced at least every 30 days and in such a manner that no sample filter is weighed without comparison to a reference filter that has been present in the weighing chamber (or room) for at least one day.
- 2.14.3.7. If the weighing chamber (or room) stability criteria outlined in paragraph 4.2.2.1. of Annex 5 are not met, but the reference filter weighings meet the above criteria, the vehicle manufacturer has the option of accepting the sample filter weights or voiding the tests, repairing the weighing chamber (or room) control system and re-running the test.

Annex 6 - Appendix 1

Emissions test procedure for all vehicles equipped with periodically regenerating systems

1. General
 - 1.1. This appendix defines the specific provisions regarding testing a vehicle equipped with periodically regenerating systems as defined in paragraph 3.8.1. of this UN GTR.
 - 1.2. During cycles where regeneration occurs, emission standards need not apply. If a periodic regeneration occurs at least once per Type 1 test and has already occurred at least once during vehicle preparation or the distance between two successive periodic regenerations is more than 4,000 km of driving repeated Type 1 tests, it does not require a special test procedure. In this case, this appendix does not apply and a K_i factor of 1.0 shall be used.
 - 1.3. The provisions of this appendix shall not apply to PN emissions.
 - 1.4. At the request of the manufacturer, and with approval of the responsible authority, the test procedure specific to periodically regenerating systems need not apply to a regenerative device if the manufacturer provides data demonstrating that, during cycles where regeneration occurs, emissions remain below the emissions limits applied by the Contracting Party for the relevant vehicle category. In this case, a fixed K_i value of 1.05 shall be used for CO₂ and fuel consumption.
 - 1.5. At the option of the Contracting Party, the Extra High₂ phase may be excluded for determining the regenerative factor K_i for Class 2 vehicles.
 - 1.6. At the option of the Contracting Party, the Extra High₃ phase may be excluded for determining the regenerative factor K_i for Class 3 vehicles.
2. Test procedure

The test vehicle shall be capable of inhibiting or permitting the regeneration process provided that this operation has no effect on original engine calibrations. Prevention of regeneration is only permitted during loading of the

regeneration system and during the preconditioning cycles. It is not permitted during the measurement of emissions during the regeneration phase. The emission test shall be carried out with the unchanged, original equipment manufacturer's (OEM) control unit. At the request of the manufacturer and with agreement of the responsible authority, an "engineering control unit" which has no effect on original engine calibrations may be used during K_i determination.

- 2.1. Exhaust emissions measurement between two WLTCs with regeneration events
 - 2.1.1. The arithmetic average emissions between regeneration events and during loading of the regenerative device shall be determined from the arithmetic mean of several approximately equidistant (if more than two) Type 1 tests. As an alternative, the manufacturer may provide data to show that the emissions remain constant (± 15 per cent) on WLTCs between regeneration events. In this case, the emissions measured during the Type 1 test may be used. In any other case, emissions measurements for at least two Type 1 cycles shall be completed: one immediately after regeneration (before new loading) and one as close as possible prior to a regeneration phase. All emissions measurements shall be carried out according to this annex and all calculations shall be carried out according to paragraph 3. of this appendix.
 - 2.1.2. The loading process and K_i determination shall be made during the Type 1 driving cycle on a chassis dynamometer or on an engine test bench using an equivalent test cycle. These cycles may be run continuously (i.e. without the need to switch the engine off between cycles). After any number of completed cycles, the vehicle may be removed from the chassis dynamometer and the test continued at a later time. Upon request of the manufacturer and with approval of the responsible authority, a manufacturer may develop an alternative procedure and demonstrate its equivalency, including filter temperature, loading quantity and distance driven. This may be done on an engine bench or on a chassis dynamometer.
 - 2.1.3. The number of cycles D between two WLTCs where regeneration events occur, the number of cycles over which emission measurements are made n and the mass emissions measurement M'_{sij} for each compound i over each cycle j shall be recorded.
- 2.2. Measurement of emissions during regeneration events
 - 2.2.1. Preparation of the vehicle, if required, for the emissions test during a regeneration phase, may be completed using the preconditioning cycles in paragraph 2.6. of this annex or equivalent engine test bench cycles, depending on the loading procedure chosen in paragraph 2.1.2. of this appendix.
 - 2.2.2. The test and vehicle conditions for the Type 1 test described in this UN GTR apply before the first valid emission test is carried out.
 - 2.2.3. Regeneration shall not occur during the preparation of the vehicle. This may be ensured by one of the following methods:
 - (a) A "dummy" regenerating system or partial system may be fitted for the preconditioning cycles;
 - (b) Any other method agreed between the manufacturer and the responsible authority.

- 2.2.4. A cold start exhaust emissions test including a regeneration process shall be performed according to the applicable WLTC.
- 2.2.5. If the regeneration process requires more than one WLTC, each WLTC shall be completed. Use of a single particulate sample filter for multiple cycles required to complete regeneration is permissible.
- If more than one WLTC is required, subsequent WLTC(s) shall be driven immediately, without switching the engine off, until complete regeneration has been achieved. In the case that the number of gaseous emission bags required for the multiple cycles would exceed the number of bags available, the time necessary to set up a new test shall be as short as possible. The engine shall not be switched off during this period.
- 2.2.6. The emission values during regeneration M_{ri} for each compound i shall be calculated according to paragraph 3. of this appendix. The number of applicable test cycles d measured for complete regeneration shall be recorded.
3. Calculations
- 3.1. Calculation of the exhaust and CO₂ emissions, and fuel consumption of a single regenerative system

$$M_{si} = \frac{\sum_{j=1}^n M'_{sij}}{n} \text{ for } n \geq 1$$

$$M_{ri} = \frac{\sum_{j=1}^d M'_{rij}}{d} \text{ for } d \geq 1$$

$$M_{pi} = \frac{M_{si} \times D + M_{ri} \times d}{D + d}$$

where for each compound i considered:

M'_{sij} are the mass emissions of compound i over test cycle j without regeneration, g/km;

M'_{rij} are the mass emissions of compound i over test cycle j during regeneration, g/km (if $d > 1$, the first WLTC test shall be run cold and subsequent cycles hot);

M_{si} are the mean mass emissions of compound i without regeneration, g/km;

M_{ri} are the mean mass emissions of compound i during regeneration, g/km;

M_{pi} are the mean mass emissions of compound i , g/km;

n is the number of test cycles, between cycles where regenerative events occur, during which emissions measurements on Type 1 WLTCs are made, ≥ 1 ;

d is the number of complete applicable test cycles required for regeneration;

D is the number of complete applicable test cycles between two cycles where regeneration events occur.

The calculation of M_{pi} is shown graphically in Figure A6.App1/1.

Figure A6.App1/1

Parameters measured during emissions test during and between cycles where regeneration occurs (schematic example, the emissions during D may increase or decrease)

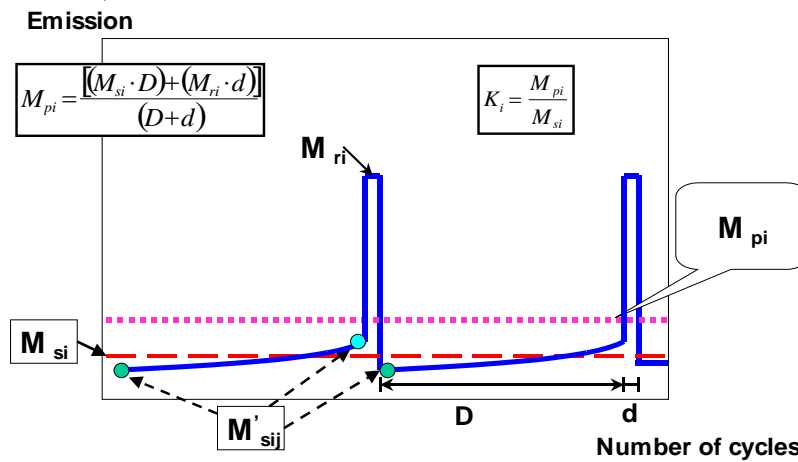

3.1.1. Calculation of the regeneration factor K_i for each compound i considered

The manufacturer may elect to determine for each compound independently either additive offsets or multiplicative factors.

K_i factor: $K_i = \frac{M_{pi}}{M_{si}}$

K_i offset: $K_i = M_{pi} - M_{si}$

M_{si} , M_{pi} and K_i results, and the manufacturer's choice of type of factor shall be recorded.

K_i may be determined following the completion of a single regeneration sequence comprising measurements before, during and after regeneration events as shown in Figure A6.App1/1.

3.2. Calculation of exhaust and CO₂ emissions, and fuel consumption of multiple periodically regenerating systems

The following shall be calculated for one Type 1 operation cycle for criteria emissions and for CO₂ emissions. The CO₂ emissions used for that calculation shall be from the result of step 3 described in Table A7/1 of Annex 7.

$$M_{sik} = \frac{\sum_{j=1}^{n_k} M'_{sikj}}{n_k} \text{ for } n_j \geq 1$$

$$M_{rik} = \frac{\sum_{j=1}^{d_k} M'_{rikj}}{d_k} \text{ for } d \geq 1$$

$$M_{si} = \frac{\sum_{k=1}^x M_{sik} \times D_k}{\sum_{k=1}^x D_k}$$

$$M_{ri} = \frac{\sum_{k=1}^x M_{rik} \times d_k}{\sum_{k=1}^x d_k}$$

$$M_{pi} = \frac{M_{si} \times \sum_{k=1}^x D_k + M_{ri} \times \sum_{k=1}^x d_k}{\sum_{k=1}^x (D_k + d_k)}$$

$$M_{pi} = \frac{\sum_{k=1}^x (M_{sik} \times D_k + M_{rik} \times d_k)}{\sum_{k=1}^x (D_k + d_k)}$$

$$K_i \text{ factor: } K_i = \frac{M_{pi}}{M_{si}}$$

$$K_i \text{ offset: } K_i = M_{pi} - M_{si}$$

where:

M_{si} are the mean mass emissions of all events k of compound i without regeneration, g/km;

M_{ri} are the mean mass emissions of all events k of compound i during regeneration, g/km;

M_{pi} are the mean mass emission of all events k of compound i , g/km;

M_{sik} are the mean mass emissions of event k of compound i without regeneration, g/km;

M_{rik} are the mean mass emissions of event k of compound i during regeneration, g/km;

$M'_{sik,j}$ are the mass emissions of event k of compound i in g/km without regeneration measured at point j where $1 \leq j \leq n_k$, g/km;

$M'_{rik,j}$ are the mass emissions of event k of compound i during regeneration (when $j > 1$, the first Type 1 test is run cold, and subsequent cycles are hot) measured at test cycle j where $1 \leq j \leq d_k$, g/km;

n_k are the number of complete test cycles of event k , between two cycles where regenerative phases occur, during which emissions measurements (Type 1 WLTCs or equivalent engine test bench cycles) are made, ≥ 2 ;

d_k is the number of complete applicable test cycles of event k required for complete regeneration;

D_k is the number of complete applicable test cycles of event k between two cycles where regenerative phases occur;

x is the number of complete regeneration events.

The calculation of M_{pi} is shown graphically in Figure A6.App1/2.

Figure A6.App1/2
Parameters measured during emissions test during and between cycles where regeneration occurs (schematic example)

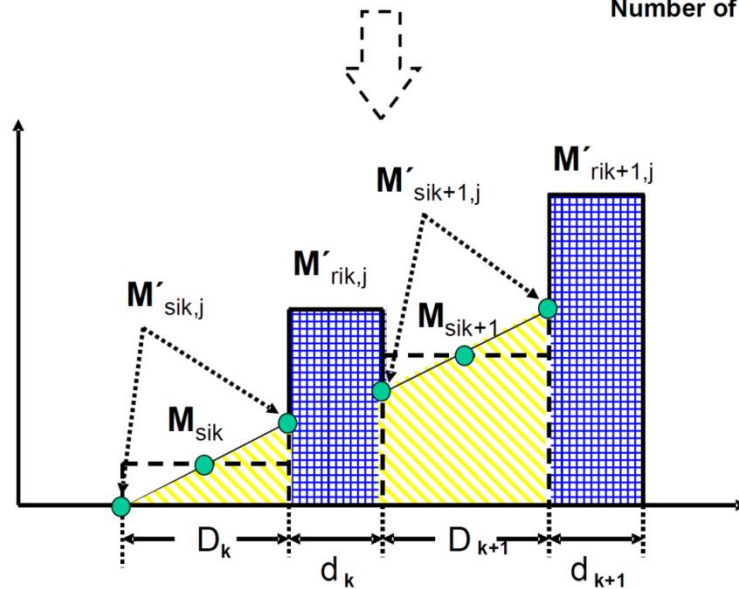
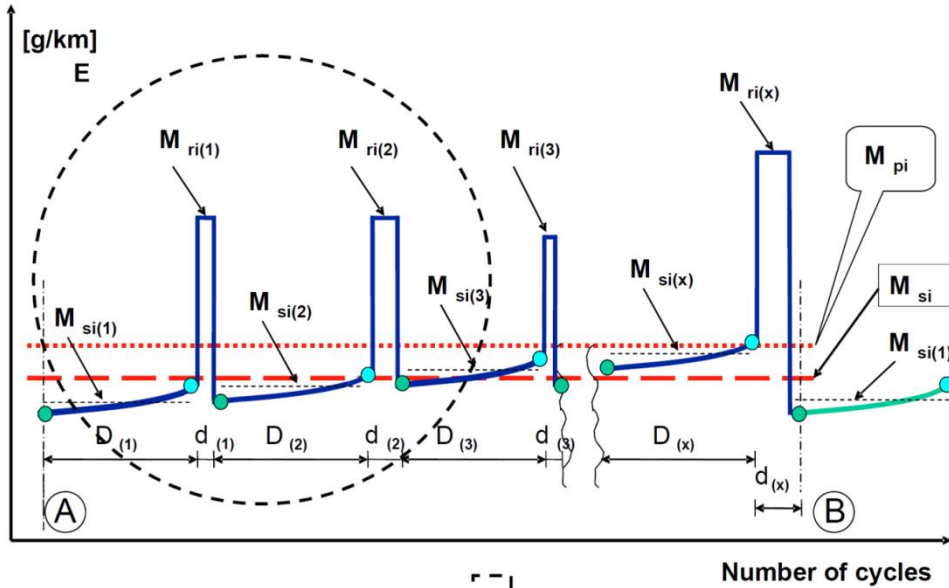

The calculation of K_i for multiple periodically regenerating systems is only possible after a certain number of regeneration events for each system.

After performing the complete procedure (A to B, see Figure A6.App1/2), the original starting condition A should be reached again.

- 3.3. K_i factors and K_i offsets shall be rounded to four places of decimal. For K_i offsets, the rounding shall be based on the physical unit of the emission standard value.

Annex 6 - Appendix 2

Test procedure for rechargeable electric energy storage system monitoring

1. General

In the case that NOVC-HEVs and OVC-HEVs are tested, Appendices 2 and 3 to Annex 8 shall apply.

This appendix defines the specific provisions regarding the correction of test results for CO₂ mass emission as a function of the energy balance ΔE_{REESS} for all REESSs.

The corrected values for CO₂ mass emission shall correspond to a zero energy balance ($\Delta E_{\text{REESS}} = 0$), and shall be calculated using a correction coefficient determined as defined below.

2. Measurement equipment and instrumentation

2.1. Current measurement

REESS depletion shall be defined as negative current.

2.1.1. The REESS current(s) shall be measured during the tests using a clamp-on or closed type current transducer. The current measurement system shall fulfil the requirements specified in Table A8/1. The current transducer(s) shall be capable of handling the peak currents at engine starts and temperature conditions at the point of measurement.

In order to have an accurate measurement, zero adjustment and degaussing shall be performed before the test according to the instrument manufacturer's instructions.

2.1.2. Current transducers shall be fitted to any of the REESS on one of the cables connected directly to the REESS and shall include the total REESS current.

In case of shielded wires, appropriate methods shall be applied in accordance with the responsible authority.

In order to easily measure REESS current using external measuring equipment, manufacturers should preferably integrate appropriate, safe and accessible connection points in the vehicle. If this is not feasible, the manufacturer shall support the responsible authority by providing the means to connect a current transducer to the REESS cables in the manner described above.

2.1.3. The measured current shall be integrated over time at a minimum frequency of 20 Hz, yielding the measured value of Q, expressed in ampere-hours Ah. The measured current shall be integrated over time, yielding the measured value of Q, expressed in ampere-hours Ah. The integration may be done in the current measurement system.

2.2. Vehicle on-board data

2.2.1. Alternatively, the REESS current shall be determined using vehicle-based data. In order to use this measurement method, the following information shall be accessible from the test vehicle:

- (a) Integrated charging balance value since last ignition run in Ah;
 - (b) Integrated on-board data charging balance value calculated at a minimum sample frequency of 5 Hz;
 - (c) The charging balance value via an OBD connector as described in SAE J1962.
- 2.2.2. The accuracy of the vehicle on-board REESS charging and discharging data shall be demonstrated by the manufacturer to the responsible authority.
- The manufacturer may create a REESS monitoring vehicle family to prove that the vehicle on-board REESS charging and discharging data are correct. The accuracy of the data shall be demonstrated on a representative vehicle.
- The following family criteria shall be valid:
- (a) Identical combustion processes (i.e. positive ignition, compression ignition, two-stroke, four-stroke);
 - (b) Identical charge and/or recuperation strategy (software REESS data module);
 - (c) On-board data availability;
 - (d) Identical charging balance measured by REESS data module;
 - (e) Identical on-board charging balance simulation.
- 2.2.3. All REESS having no influence on CO₂ mass emissions shall be excluded from monitoring.
3. REESS energy change-based correction procedure
- 3.1. Measurement of the REESS current shall start at the same time as the test starts and shall end immediately after the vehicle has driven the complete driving cycle.
- 3.2. The electricity balance Q measured in the electric power supply system shall be used as a measure of the difference in the REESS energy content at the end of the cycle compared to the beginning of the cycle. The electricity balance shall be determined for the total driven WLTC.
- 3.3. Separate values of Q_{phase} shall be logged over the driven cycle phases.
- 3.4. Correction of CO₂ mass emission over the whole cycle as a function of the correction criterion c
- 3.4.1. Calculation of the correction criterion c

The correction criterion c is the ratio between the absolute value of the electric energy change $\Delta E_{\text{REESS},j}$ and the fuel energy and shall be calculated using the following equations:

$$c = \left| \frac{\Delta E_{\text{REESS},j}}{E_{\text{fuel}}} \right|$$

where:

c is the correction criterion;

$\Delta E_{\text{REESS},j}$ is the electric energy change of all REESSs over period j determined according to paragraph 4.1. of this appendix, Wh;

j is, in this paragraph, the whole applicable WLTP test cycle;

E_{Fuel} is the fuel energy according to the following equation:

$$E_{fuel} = 10 \times HV \times FC_{nb} \times d$$

where:

E_{fuel} is the energy content of the consumed fuel over the applicable WLTP test cycle, Wh;

HV is the heating value according to Table A6.App2/1, kWh/l;

FC_{nb} is the non-balanced fuel consumption of the Type 1 test, not corrected for the energy balance, determined according to paragraph 6. of Annex 7, and using the results for criteria emissions and CO₂ calculated in step 2 in Table A7/1, l/100 km;

d is the distance driven over the corresponding applicable WLTP test cycle, km;

10 conversion factor to Wh.

3.4.2. The correction shall be applied if ΔE_{REESS} is negative (corresponding to REESS discharging) and the correction criterion, c, calculated according to paragraph 3.4.1. of this appendix is greater than the applicable threshold according to Table A6.App2/2.

3.4.3. The correction shall be omitted and uncorrected values shall be used if the correction criterion c calculated according to paragraph 3.4.1. of this appendix is less than the applicable threshold according to Table A6.App2/2.

3.4.4. The correction may be omitted and uncorrected values may be used if:

(a) ΔE_{REESS} is positive (corresponding to REESS charging) and the correction criterion c calculated according to paragraph 3.4.1. of this appendix is greater than the applicable threshold according to Table A6.App2/2;

(b) the manufacturer can prove to the responsible authority by measurement that there is no relation between ΔE_{REESS} and CO₂ mass emission and ΔE_{REESS} and fuel consumption respectively.

Table A6.App2/1
Energy content of fuel

| Fuel | Petrol | | | | | | | Diesel | | | | |
|-------------------------------------|--------|------|------|------|------|------|------|--------|------|------|------|------|
| Content Ethanol/Biodiesel, per cent | E0 | E5 | E10 | E15 | E22 | E85 | E100 | B0 | B5 | B7 | B20 | B100 |
| Heat value (kWh/l) | 8.92 | 8.78 | 8.64 | 8.50 | 8.30 | 6.41 | 5.95 | 9.85 | 9.80 | 9.79 | 9.67 | 8.90 |

Table A6.App2/2
RCB correction criteria thresholds

| Cycle | low + medium) | low + medium + high | low + medium + high + extra high |
|---------------------------------------|---------------|---------------------|----------------------------------|
| Thresholds for correction criterion c | 0.015 | 0.01 | 0.005 |

4. Applying the correction function
- 4.1. To apply the correction function, the electric energy change $\Delta E_{\text{REESS},j}$ of a period j of all REESSs shall be calculated from the measured current and the nominal voltage:

$$\Delta E_{\text{REESS},j} = \sum_{i=1}^n \Delta E_{\text{REESS},j,i}$$

where:

$\Delta E_{\text{REESS},j,i}$ is the electric energy change of REESS i during the considered period j , Wh;

and:

$$\Delta E_{\text{REESS},j,i} = \frac{1}{3600} \times U_{\text{REESS}} \times \int_{t_0}^{t_{\text{end}}} I(t)_{j,i} dt$$

where:

U_{REESS} is the nominal REESS voltage determined according to IEC 60050-482, V;

$I(t)_{j,i}$ is the electric current of REESS i during the considered period j , determined according to paragraph 2. of this appendix, A;

t_0 is the time at the beginning of the considered period j , s;

t_{end} is the time at the end of the considered period j , s.

i is the index number of the considered REESS;

n is the total amount of REESS;

j is the index number for the considered period, where a period shall be any applicable cycle phase, combination of cycle phases and the applicable total cycle;

$\frac{1}{3600}$ is the conversion factor from Ws to Wh.

- 4.2. For correction of CO₂ mass emission, g/km, combustion process-specific Willans factors from Table A6.App2/3 shall be used.
- 4.3. The correction shall be performed and applied for the total cycle and for each of its cycle phases separately, and shall be recorded.
- 4.4. For this specific calculation, a fixed electric power supply system alternator efficiency shall be used:

$$\eta_{\text{alternator}} = 0.67 \text{ for electric power supply system REESS alternators}$$

- 4.5. The resulting CO₂ mass emission difference for the considered period j due to load behaviour of the alternator for charging a REESS shall be calculated using the following equation:

$$\Delta M_{\text{CO}_2,j} = 0.0036 \times \Delta E_{\text{REESS},j} \times \frac{1}{\eta_{\text{alternator}}} \times \text{Willans}_{\text{factor}} \times \frac{1}{d_j}$$

where:

$\Delta M_{\text{CO}_2,j}$ is the resulting CO₂ mass emission difference of period j , g/km;

- $\Delta E_{REESS,j}$ is the REESS energy change of the considered period j calculated according to paragraph 4.1. of this appendix, Wh;
- d_j is the driven distance of the considered period j, km;
- j is the index number for the considered period, where a period shall be any applicable cycle phase, combination of cycle phases and the applicable total cycle;
- 0.0036 is the conversion factor from Wh to MJ;
- $\eta_{alternator}$ is the efficiency of the alternator according to paragraph 4.4. of this appendix;
- $Willans_{factor}$ is the combustion process-specific Willans factor as defined in Table A6.App2/3, gCO₂/MJ;

4.5.1. The CO₂ values of each phase and the total cycle shall be corrected as follows:

$$M_{CO_2,p,3} = (M_{CO_2,p,1} - \Delta M_{CO_2,j})$$

$$M_{CO_2,c,3} = (M_{CO_2,c,2} - \Delta M_{CO_2,j})$$

where:

$\Delta M_{CO_2,j}$ is the result from paragraph 4.5. of this appendix for a period j, g/km.

4.6. For the correction of CO₂ emission, g/km, the Willans factors in Table A6.App2/3 shall be used.

Table A6.App2/3
Willans factors

| | | | <i>Naturally aspirated</i> | <i>Pressure-charged</i> |
|----------------------|----------------------|----------------------|----------------------------|-------------------------|
| Positive ignition | Petrol (E0) | l/MJ | 0.0733 | 0.0778 |
| | | gCO ₂ /MJ | 175 | 186 |
| | Petrol (E5) | l/MJ | 0.0744 | 0.0789 |
| | | gCO ₂ /MJ | 174 | 185 |
| | Petrol (E10) | l/MJ | 0.0756 | 0.0803 |
| | | gCO ₂ /MJ | 174 | 184 |
| | CNG (G20) | m ³ /MJ | 0.0719 | 0.0764 |
| | | gCO ₂ /MJ | 129 | 137 |
| | LPG | l/MJ | 0.0950 | 0.101 |
| | | gCO ₂ /MJ | 155 | 164 |
| E85 | l/MJ | 0.102 | 0.108 | |
| | gCO ₂ /MJ | 169 | 179 | |
| Compression ignition | Diesel (B0) | l/MJ | 0.0611 | 0.0611 |
| | | gCO ₂ /MJ | 161 | 161 |
| | Diesel (B5) | l/MJ | 0.0611 | 0.0611 |
| | | gCO ₂ /MJ | 161 | 161 |
| | Diesel (B7) | l/MJ | 0.0611 | 0.0611 |
| | | gCO ₂ /MJ | 161 | 161 |

Annex 6 - Appendix 3

Calculation of gas energy ratio for gaseous fuels (LPG and NG/biomethane)

1. Measurement of the mass of gaseous fuel consumed during the Type 1 test cycle

Measurement of the mass of gas consumed during the cycle shall be done by a fuel weighing system capable of measuring the weight of the storage container during the test in accordance with the following:

(a) An accuracy of ± 2 per cent of the difference between the readings at the beginning and at the end of the test or better.

(b) Precautions shall be taken to avoid measurement errors.

Such precautions shall at least include the careful installation of the device according to the instrument manufacturer's recommendations and to good engineering practice.

(c) Other measurement methods are permitted if an equivalent accuracy can be demonstrated.

2. Calculation of the gas energy ratio

The fuel consumption value shall be calculated from the emissions of hydrocarbons, carbon monoxide, and carbon dioxide determined from the measurement results assuming that only the gaseous fuel is burned during the test.

The gas ratio of the energy consumed in the cycle shall be determined using the following equation:

$$G_{\text{gas}} = \left(\frac{M_{\text{gas}} \times \text{cf} \times 10^4}{\text{FC}_{\text{norm}} \times \text{dist} \times \rho} \right)$$

where:

G_{gas} is the gas energy ratio, per cent;

M_{gas} is the mass of the gaseous fuel consumed during the cycle, kg;

FC_{norm} is the fuel consumption (l/100km for LPG, m³/100 km for NG/biomethane) calculated in accordance with paragraphs 6.6. and 6.7. of Annex 7;

dist is the distance recorded during the cycle, km;

ρ is the gas density:

$\rho = 0.654 \text{ kg/m}^3$ for NG/Biomethane;

$\rho = 0.538 \text{ kg/litre}$ for LPG;

cf is the correction factor, assuming the following values:

cf = 1 in the case of LPG or G20 reference fuel;

cf = 0.78 in the case of G25 reference fuel.

Annex 7

Calculations

1. General requirements
 - 1.1. Unless explicitly stated otherwise in Annex 8, all requirements and procedures specified in this annex shall apply for NOVC-HEVs, OVC-HEVs, NOVC-FCHVs and PEVs.
 - 1.2. The calculation steps described in paragraph 1.4. of this annex shall be used for pure ICE vehicles only.
 - 1.3. Rounding of test results
 - 1.3.1. Intermediate steps in the calculations shall not be rounded unless intermediate rounding is required.
 - 1.3.2. The final criteria emission results shall be rounded according to paragraph 7. of this UN GTR in one step to the number of places to the right of the decimal point indicated by the applicable emission standard plus one additional significant figure.
 - 1.3.3. The NO_x correction factor KH shall be reported rounded according to paragraph 7. of this UN GTR to two places of decimal.
 - 1.3.4. The dilution factor DF shall be reported rounded according to paragraph 7. of this UN GTR to two places of decimal.
 - 1.3.5. For information not related to standards, good engineering judgement shall be used.
 - 1.4. Stepwise procedure for calculating the final test results for vehicles using combustion engines

The results shall be calculated in the order described in Table A7/1. All applicable results in the column "Output" shall be recorded. The column "Process" describes the paragraphs to be used for calculation or contains additional calculations.

For the purpose of this table, the following nomenclature within the equations and results is used:

 - c complete applicable cycle;
 - p every applicable cycle phase;
 - i every applicable criteria emission component, without CO₂;
 - CO₂ CO₂ emission.

Table A7/1
Procedure for calculating final test results

| Source | Input | Process | Output | Step No. |
|----------------------|--|---|--|----------|
| Annex 6 | Raw test results | Mass emissions Paragraphs 3. to 3.2.2. inclusive of this annex. | $M_{i,p,1}$, g/km; $M_{CO_2,p,1}$, g/km. | 1 |
| Output step 1 | $M_{i,p,1}$, g/km; $M_{CO_2,p,1}$, g/km. | Calculation of combined cycle values: $M_{i,c,2} = \frac{\sum_p M_{i,p,1} \times d_p}{\sum_p d_p}$ $M_{CO_2,c,2} = \frac{\sum_p M_{CO_2,p,1} \times d_p}{\sum_p d_p}$ where: $M_{i/CO_2,c,2}$ are the emission results over the total cycle; d_p are the driven distances of the cycle phases, p. | $M_{i,c,2}$, g/km; $M_{CO_2,c,2}$, g/km. | 2 |
| Output step 1 and 2 | $M_{CO_2,p,1}$, g/km; $M_{CO_2,c,2}$, g/km. | RCB correction Appendix 2 to Annex 6. | $M_{CO_2,p,3}$, g/km; $M_{CO_2,c,3}$, g/km. | 3 |
| Output step 2 and 3 | $M_{i,c,2}$, g/km; $M_{CO_2,c,3}$, g/km. | Emissions test procedure for all vehicles equipped with periodically regenerating systems, K_i . Annex 6, Appendix 1. $M_{i,c,4} = K_i \times M_{i,c,2}$ or $M_{i,c,4} = K_i + M_{i,c,2}$ and $M_{CO_2,c,4} = K_{CO_2} \times M_{CO_2,c,3}$ or $M_{CO_2,c,4} = K_{CO_2} + M_{CO_2,c,3}$ Additive offset or multiplicative factor to be used according to K_i determination. If K_i is not applicable: $M_{i,c,4} = M_{i,c,2}$ $M_{CO_2,c,4} = M_{CO_2,c,3}$ | $M_{i,c,4}$, g/km; $M_{CO_2,c,4}$, g/km. | 4a |
| Output step 3 and 4a | $M_{CO_2,p,3}$, g/km; $M_{CO_2,c,3}$, g/km; $M_{CO_2,c,4}$, g/km. | If K_i is applicable, align CO_2 phase values to the combined cycle value: $M_{CO_2,p,4} = M_{CO_2,p,3} \times AF_{K_i}$ for every cycle phase p; where: $AF_{K_i} = \frac{M_{CO_2,c,4}}{M_{CO_2,c,3}}$ If K_i is not applicable: $M_{CO_2,p,4} = M_{CO_2,p,3}$ | $M_{CO_2,p,4}$, g/km. | 4b |

| Source | Input | Process | Output | Step No. |
|----------------------|---|---|---|--|
| Output step 4 | $M_{i,c,4}$, g/km; $M_{CO_2,c,4}$, g/km; $M_{CO_2,p,4}$, g/km. | Placeholder for additional corrections, if applicable. Otherwise: $M_{i,c,5} = M_{i,c,4}$ $M_{CO_2,c,5} = M_{CO_2,c,4}$ $M_{CO_2,p,5} = M_{CO_2,p,4}$ | $M_{i,c,5}$, g/km; $M_{CO_2,c,5}$, g/km; $M_{CO_2,p,5}$, g/km. | 5 Result of a single test. |
| Output step 5 | For every test: $M_{i,c,5}$, g/km; $M_{CO_2,c,5}$, g/km; $M_{CO_2,p,5}$, g/km. | Averaging of tests and declared value. Paragraphs 1.2. to 1.2.3. inclusive of Annex 6. | $M_{i,c,6}$, g/km; $M_{CO_2,c,6}$, g/km; $M_{CO_2,p,6}$, g/km. $M_{CO_2,c,declared}$, g/km. | 6 |
| Output step 6 | $M_{CO_2,c,6}$, g/km; $M_{CO_2,p,6}$, g/km. $M_{CO_2,c,declared}$, g/km. | Alignment of phase values. Paragraph 1.2.4. of Annex 6. and: $M_{CO_2,c,7} = M_{CO_2,c,declared}$ | $M_{CO_2,c,7}$, g/km; $M_{CO_2,p,7}$, g/km. | 7 |
| Output steps 6 and 7 | $M_{i,c,6}$, g/km; $M_{CO_2,c,7}$, g/km; $M_{CO_2,p,7}$, g/km. | Calculation of fuel consumption. Paragraph 6 of this annex. The calculation of fuel consumption shall be performed for the applicable cycle and its phases separately. For that purpose: (a) the applicable phase or cycle CO ₂ values shall be used; (b) the criteria emission over the complete cycle shall be used. and: $M_{i,c,8} = M_{i,c,6}$ $M_{CO_2,c,8} = M_{CO_2,c,7}$ $M_{CO_2,p,8} = M_{CO_2,p,7}$ | $FC_{c,8}$, l/100 km; $FC_{p,8}$, l/100 km; $M_{i,c,8}$, g/km; $M_{CO_2,c,8}$, g/km; $M_{CO_2,p,8}$, g/km. | 8 Result of a Type 1 test for a test vehicle. |
| Step 8 | For each of the test vehicles H and L: $M_{i,c,8}$, g/km; $M_{CO_2,c,8}$, g/km; $M_{CO_2,p,8}$, g/km; $FC_{c,8}$, l/100 km; $FC_{p,8}$, l/100 km. | If a test vehicle L was tested in addition to a test vehicle H, the resulting criteria emission values of L and H shall be the arithmetic average and are referred to as $M_{i,c}$. At request of a contracting party, the averaging of the criteria emissions may be omitted and the values of H and L remain separated. Otherwise, if no vehicle L was tested, $M_{i,c} = M_{i,c,8}$ For CO ₂ and FC, the values derived in step 8 shall be used, and CO ₂ values shall be rounded according to paragraph 7. of this UN GTR to two places of decimal, and FC values shall be rounded according to paragraph 7. of this UN GTR to three places of decimal.. | $M_{i,c}$, g/km; $M_{CO_2,c,H}$, g/km; $M_{CO_2,p,H}$, g/km; $FC_{c,H}$, l/100 km; $FC_{p,H}$, l/100 km; and if a vehicle L was tested: $M_{CO_2,c,L}$, g/km; $M_{CO_2,p,L}$, g/km; $FC_{c,L}$, l/100 km; $FC_{p,L}$, l/100 km. | 9 Interpolation family result. Final criteria emission result. |

| Source | Input | Process | Output | Step No. |
|--------|--|---|--|--|
| Step 9 | $M_{CO_2,c,H}$, g/km; $M_{CO_2,p,H}$, g/km; $FC_{c,H}$, l/100 km; $FC_{p,H}$, l/100 km; and if a vehicle L was tested: $M_{CO_2,c,L}$, g/km; $M_{CO_2,p,L}$, g/km; $FC_{c,L}$, l/100 km; $FC_{p,L}$, l/100 km. | Fuel consumption and CO ₂ calculations for individual vehicles in an interpolation family. Paragraph 3.2.3. of this annex. Fuel consumption and CO ₂ calculations for individual vehicles in a road load matrix family Paragraph 3.2.4. of this annex. CO ₂ emissions shall be expressed in grams per kilometre (g/km) rounded to the nearest whole number; FC values shall be rounded according to paragraph 7. of this UN GTR to one place of decimal, expressed in (l/100 km). | $M_{CO_2,c,ind}$ g/km; $M_{CO_2,p,ind}$, g/km; $FC_{c,ind}$ l/100 km; $FC_{p,ind}$, l/100 km. | 10 Result of an individual vehicle. Final CO ₂ and FC result. |

2. Determination of diluted exhaust gas volume
- 2.1. Volume calculation for a variable dilution device capable of operating at a constant or variable flow rate
 The volumetric flow shall be measured continuously. The total volume shall be measured for the duration of the test.
- 2.2. Volume calculation for a variable dilution device using a positive displacement pump
- 2.2.1. The volume shall be calculated using the following equation:

$$V = V_0 \times N$$

where:

- V is the volume of the diluted gas, in litres per test (prior to correction);
- V_0 is the volume of gas delivered by the positive displacement pump in testing conditions, litres per pump revolution;
- N is the number of revolutions per test.

- 2.2.1.1. Correcting the volume to standard conditions

The diluted exhaust gas volume, V , shall be corrected to standard conditions according to the following equation:

$$V_{mix} = V \times K_1 \times \left(\frac{P_B - P_1}{T_p} \right)$$

where:

$$K_1 = \frac{273.15 (K)}{101.325 (kPa)} = 2.6961$$

- P_B is the test room barometric pressure, kPa;
- P_1 is the vacuum at the inlet of the positive displacement pump relative to the ambient barometric pressure, kPa;

T_p is the arithmetic average temperature of the diluted exhaust gas entering the positive displacement pump during the test, Kelvin (K).

3. Mass emissions

3.1. General requirements

3.1.1. Assuming no compressibility effects, all gases involved in the engine's intake, combustion and exhaust processes may be considered to be ideal according to Avogadro's hypothesis.

3.1.2. The mass M of gaseous compounds emitted by the vehicle during the test shall be determined by the product of the volumetric concentration of the gas in question and the volume of the diluted exhaust gas with due regard for the following densities under the reference conditions of 273.15 K (0 °C) and 101.325 kPa:

Carbon monoxide (CO) $\rho = 1.25$ g/l

Carbon dioxide (CO₂) $\rho = 1.964$ g/l

Hydrocarbons:

for petrol (E0) (C₁H_{1.85}) $\rho = 0.619$ g/l

for petrol (E5) (C₁H_{1.89}O_{0.016}) $\rho = 0.632$ g/l

for petrol (E10) (C₁H_{1.93}O_{0.033}) $\rho = 0.646$ g/l

for diesel (B0) (C₁H_{1.86}) $\rho = 0.620$ g/l

for diesel (B5) (C₁H_{1.86}O_{0.005}) $\rho = 0.623$ g/l

for diesel (B7) (C₁H_{1.86}O_{0.007}) $\rho = 0.625$ g/l

for LPG (C₁H_{2.525}) $\rho = 0.649$ g/l

for NG/biomethane (CH₄) $\rho = 0.716$ g/l

for ethanol (E85) (C₁H_{2.74}O_{0.385}) $\rho = 0.934$ g/l

Formaldehyde (if applicable) $\rho = 1.34$

Acetaldehyde (if applicable) $\rho = 1.96$

Ethanol (if applicable) $\rho = 2.05$

Nitrogen oxides (NO_x) $\rho = 2.05$ g/l

Nitrogen dioxide (NO₂) (if applicable) $\rho = 2.05$ g/l

Nitrous oxide (N₂O) (if applicable) $\rho = 1.964$ g/l

The density for NMHC mass calculations shall be equal to that of total hydrocarbons at 273.15 K (0 °C) and 101.325 kPa, and is fuel-dependent. The density for propane mass calculations (see paragraph 3.5. of Annex 5) is 1.967 g/l at standard conditions.

If a fuel type is not listed in this paragraph, the density of that fuel shall be calculated using the equation given in paragraph 3.1.3. of this annex.

- 3.1.3. The general equation for the calculation of total hydrocarbon density for each reference fuel with a mean composition of $C_xH_yO_z$ is as follows:

$$\rho_{\text{THC}} = \frac{MW_C + \frac{H}{C} \times MW_H + \frac{O}{C} \times MW_O}{V_M}$$

where:

ρ_{THC} is the density of total hydrocarbons and non-methane hydrocarbons, g/l;

MW_C is the molar mass of carbon (12.011 g/mol);

MW_H is the molar mass of hydrogen (1.008 g/mol);

MW_O is the molar mass of oxygen (15.999 g/mol);

V_M is the molar volume of an ideal gas at 273.15 K (0° C) and 101.325 kPa (22.413 l/mol);

H/C is the hydrogen to carbon ratio for a specific fuel $C_xH_yO_z$;

O/C is the oxygen to carbon ratio for a specific fuel $C_xH_yO_z$.

- 3.2. Mass emissions calculation

- 3.2.1. Mass emissions of gaseous compounds per cycle phase shall be calculated using the following equations:

$$M_{i,\text{phase}} = \frac{V_{\text{mix,phase}} \times \rho_i \times KH_{\text{phase}} \times C_{i,\text{phase}} \times 10^{-6}}{d_{\text{phase}}}$$

where:

M_i is the mass emission of compound i per test or phase, g/km;

V_{mix} is the volume of the diluted exhaust gas per test or phase expressed in litres per test/phase and corrected to standard conditions (273.15 K (0 °C) and 101.325 kPa);

ρ_i is the density of compound i in grams per litre at standard temperature and pressure (273.15 K (0 °C) and 101.325 kPa);

KH is a humidity correction factor applicable only to the mass emissions of oxides of nitrogen, NO_2 and NO_x , per test or phase;

C_i is the concentration of compound i per test or phase in the diluted exhaust gas expressed in ppm and corrected by the amount of compound i contained in the dilution air;

d is the distance driven over the applicable WLTC, km;

n is the number of phases of the applicable WLTC.

- 3.2.1.1. The concentration of a gaseous compound in the diluted exhaust gas shall be corrected by the amount of the gaseous compound in the dilution air using the following equation:

$$C_i = C_e - C_d \times \left(1 - \frac{1}{DF}\right)$$

where:

C_i is the concentration of gaseous compound i in the diluted exhaust gas corrected by the amount of gaseous compound i contained in the dilution air, ppm;

C_e is the measured concentration of gaseous compound i in the diluted exhaust gas, ppm;

C_d is the concentration of gaseous compound i in the dilution air, ppm;

DF is the dilution factor.

3.2.1.1.1. The dilution factor DF shall be calculated using the equation for the concerned fuel:

$$DF = \frac{13.4}{C_{CO_2} + (C_{HC} + C_{CO}) \times 10^{-4}} \quad \text{for petrol (E5, E10) and diesel (B0)}$$

$$DF = \frac{13.5}{C_{CO_2} + (C_{HC} + C_{CO}) \times 10^{-4}} \quad \text{for petrol (E0)}$$

$$DF = \frac{13.5}{C_{CO_2} + (C_{HC} + C_{CO}) \times 10^{-4}} \quad \text{for diesel (B5 and B7)}$$

$$DF = \frac{11.9}{C_{CO_2} + (C_{HC} + C_{CO}) \times 10^{-4}} \quad \text{for LPG}$$

$$DF = \frac{9.5}{C_{CO_2} + (C_{HC} + C_{CO}) \times 10^{-4}} \quad \text{for NG/biomethane}$$

$$DF = \frac{12.5}{C_{CO_2} + (C_{HC} + C_{CO}) \times 10^{-4}} \quad \text{for ethanol (E85)}$$

$$DF = \frac{35.03}{C_{H_2O} - C_{H_2O-DA} + C_{H_2} \times 10^{-4}} \quad \text{for hydrogen}$$

With respect to the equation for hydrogen:

C_{H_2O} is the concentration of H_2O in the diluted exhaust gas contained in the sample bag, per cent volume;

C_{H_2O-DA} is the concentration of H_2O in the dilution air, per cent volume;

C_{H_2} is the concentration of H_2 in the diluted exhaust gas contained in the sample bag, ppm.

If a fuel type is not listed in this paragraph, the DF for that fuel shall be calculated using the equations in paragraph 3.2.1.1.2. of this annex.

If the manufacturer uses a DF that covers several phases, it shall calculate a DF using the mean concentration of gaseous compounds for the phases concerned.

The mean concentration of a gaseous compound shall be calculated using the following equation:

$$\bar{C}_i = \frac{\sum_{\text{phase}=1}^n (C_{i,\text{phase}} \times V_{\text{mix,phase}})}{\sum_{\text{phase}=1}^n V_{\text{mix,phase}}}$$

where:

C_i is mean concentration of a gaseous compound;

$C_{i,\text{phase}}$ is the concentration of each phase;

$V_{\text{mix,phase}}$ is the V_{mix} of the corresponding phase;

n is the number of phases.

- 3.2.1.1.2. The general equation for calculating the dilution factor DF for each reference fuel with an arithmetic average composition of $C_xH_yO_z$ is as follows:

$$DF = \frac{X}{C_{CO_2} + (C_{HC} + C_{CO}) \times 10^{-4}}$$

where:

$$X = 100 \times \frac{x}{x + \frac{y}{2} + 3.76 \left(x + \frac{y}{4} - \frac{z}{2} \right)}$$

C_{CO_2} is the concentration of CO_2 in the diluted exhaust gas contained in the sample bag, per cent volume;

C_{HC} is the concentration of HC in the diluted exhaust gas contained in the sample bag, ppm carbon equivalent;

C_{CO} is the concentration of CO in the diluted exhaust gas contained in the sample bag, ppm.

- 3.2.1.1.3. Methane measurement

- 3.2.1.1.3.1. For methane measurement using a GC-FID, NMHC shall be calculated using the following equation:

$$C_{NMHC} = C_{THC} - (Rf_{CH_4} \times C_{CH_4})$$

where:

C_{NMHC} is the corrected concentration of NMHC in the diluted exhaust gas, ppm carbon equivalent;

C_{THC} is the concentration of THC in the diluted exhaust gas, ppm carbon equivalent and corrected by the amount of THC contained in the dilution air;

C_{CH_4} is the concentration of CH_4 in the diluted exhaust gas, ppm carbon equivalent and corrected by the amount of CH_4 contained in the dilution air;

Rf_{CH_4} is the FID response factor to methane determined and specified in paragraph 5.4.3.2. of Annex 5.

- 3.2.1.1.3.2. For methane measurement using an NMC-FID, the calculation of NMHC depends on the calibration gas/method used for the zero/calibration adjustment.

The FID used for the THC measurement (without NMC) shall be calibrated with propane/air in the normal manner.

For the calibration of the FID in series with an NMC, the following methods are permitted:

- (a) The calibration gas consisting of propane/air bypasses the NMC;
- (b) The calibration gas consisting of methane/air passes through the NMC.

It is highly recommended to calibrate the methane FID with methane/air through the NMC.

In case (a), the concentration of CH_4 and NMHC shall be calculated using the following equations:

$$C_{\text{CH}_4} = \frac{C_{\text{HC}(w/\text{NMC})} - C_{\text{HC}(w/o\text{NMC})} \times (1 - E_E)}{Rf_{\text{CH}_4} \times (E_E - E_M)}$$

$$C_{\text{NMHC}} = \frac{C_{\text{HC}(w/o\text{NMC})} \times (1 - E_M) - C_{\text{HC}(w/\text{NMC})}}{E_E - E_M}$$

If $Rf_{\text{CH}_4} < 1.05$, it may be omitted from the equation above for C_{CH_4} .

In case (b), the concentration of CH_4 and NMHC shall be calculated using the following equations:

$$C_{\text{CH}_4} = \frac{C_{\text{HC}(w/\text{NMC})} \times Rf_{\text{CH}_4} \times (1 - E_M) - C_{\text{HC}(w/o\text{NMC})} \times (1 - E_E)}{Rf_{\text{CH}_4} \times (E_E - E_M)}$$

$$C_{\text{NMHC}} = \frac{C_{\text{HC}(w/o\text{NMC})} \times (1 - E_M) - C_{\text{HC}(w/\text{NMC})} \times Rf_{\text{CH}_4} \times (1 - E_M)}{E_E - E_M}$$

where:

$C_{\text{HC}(w/\text{NMC})}$ is the HC concentration with sample gas flowing through the NMC, ppm C;

$C_{\text{HC}(w/o\text{NMC})}$ is the HC concentration with sample gas bypassing the NMC, ppm C;

Rf_{CH_4} is the methane response factor as determined per paragraph 5.4.3.2. of Annex 5;

E_M is the methane efficiency as determined per paragraph 3.2.1.1.3.3.1. of this annex;

E_E is the ethane efficiency as determined per paragraph 3.2.1.1.3.3.2. of this annex.

If $Rf_{\text{CH}_4} < 1.05$, it may be omitted in the equations for case (b) above for C_{CH_4} and C_{NMHC} .

3.2.1.1.3.3. Conversion efficiencies of the non-methane cutter, NMC

The NMC is used for the removal of the non-methane hydrocarbons from the sample gas by oxidizing all hydrocarbons except methane. Ideally, the conversion for methane is 0 per cent, and for the other hydrocarbons represented by ethane is 100 per cent. For the accurate measurement of NMHC, the two efficiencies shall be determined and used for the calculation of the NMHC emission.

3.2.1.1.3.3.1. Methane conversion efficiency, E_M

The methane/air calibration gas shall be flowed to the FID through the NMC and bypassing the NMC and the two concentrations recorded. The efficiency shall be determined using the following equation:

$$E_M = 1 - \frac{C_{\text{HC}(w/\text{NMC})}}{C_{\text{HC}(w/o\text{NMC})}}$$

where:

$C_{\text{HC}(w/\text{NMC})}$ is the HC concentration with CH_4 flowing through the NMC, ppm C;

$C_{\text{HC}(w/o\text{NMC})}$ is the HC concentration with CH_4 bypassing the NMC, ppm C.

3.2.1.1.3.3.2. Ethane conversion efficiency, E_E

The ethane/air calibration gas shall be flowed to the FID through the NMC and bypassing the NMC and the two concentrations recorded. The efficiency shall be determined using the following equation:

$$E_E = 1 - \frac{C_{\text{HC}(w/\text{NMC})}}{C_{\text{HC}(w/o\text{NMC})}}$$

where:

$C_{\text{HC}(w/\text{NMC})}$ is the HC concentration with C_2H_6 flowing through the NMC, ppm C;

$C_{\text{HC}(w/o\text{NMC})}$ is the HC concentration with C_2H_6 bypassing the NMC, ppm C.

If the ethane conversion efficiency of the NMC is 0.98 or above, E_E shall be set to 1 for any subsequent calculation.

3.2.1.1.3.4. If the methane FID is calibrated through the cutter, E_M shall be 0.

The equation to calculate C_{CH_4} in paragraph 3.2.1.1.3.2. (case (b)) in this annex becomes:

$$C_{\text{CH}_4} = C_{\text{HC}(w/\text{NMC})}$$

The equation to calculate CNMHC in paragraph 3.2.1.1.3.2. (case (b)) in this annex becomes:

$$C_{\text{NMHC}} = C_{\text{HC}(w/o\text{NMC})} - C_{\text{HC}(w/\text{NMC})} \times r_h$$

The density used for NMHC mass calculations shall be equal to that of total hydrocarbons at 273.15 K (0 °C) and 101.325 kPa and is fuel-dependent.

3.2.1.1.4. Flow-weighted arithmetic average concentration calculation

The following calculation method shall only be applied for CVS systems that are not equipped with a heat exchanger or for CVS systems with a heat exchanger that do not comply with paragraph 3.3.5.1. of Annex 5.

When the CVS flow rate, q_{VCVS} , over the test varies by more than ± 3 per cent of the arithmetic average flow rate, a flow-weighted arithmetic average shall be used for all continuous diluted measurements including PN:

$$C_e = \frac{\sum_{i=1}^n q_{\text{VCVS}}(i) \times \Delta t \times C(i)}{V}$$

where:

C_e is the flow-weighted arithmetic average concentration;

$q_{\text{VCVS}}(i)$ is the CVS flow rate at time $t = i \times \Delta t$, m^3/min ;

$C(i)$ is the concentration at time $t = i \times \Delta t$, ppm;

Δt sampling interval, s;

V total CVS volume, m^3 ;

n is the test time, s.

3.2.1.2. Calculation of the NO_x humidity correction factor

In order to correct the influence of humidity on the results of oxides of nitrogen, the following calculations apply:

$$KH = \frac{1}{1 - 0.0329 \times (H - 10.71)}$$

where:

$$H = \frac{6.211 \times R_a \times P_d}{P_B - P_d \times R_a \times 10^{-2}}$$

and:

H is the specific humidity, grams of water vapour per kilogram dry air;

R_a is the relative humidity of the ambient air, per cent;

P_d is the saturation vapour pressure at ambient temperature, kPa;

P_B is the atmospheric pressure in the room, kPa.

The KH factor shall be calculated for each phase of the test cycle.

The ambient temperature and relative humidity shall be defined as the arithmetic average of the continuously measured values during each phase.

3.2.1.3. Determination of NO₂ concentration from NO and NO_x (if applicable)

NO₂ shall be determined by the difference between NO_x concentration from the bag corrected for dilution air concentration and NO concentration from continuous measurement corrected for dilution air concentration

3.2.1.3.1. NO concentrations

3.2.1.3.1.1. NO concentrations shall be calculated from the integrated NO analyser reading, corrected for varying flow if necessary.

3.2.1.3.1.2. The arithmetic average NO concentration shall be calculated using the following equation:

$$C_e = \frac{\int_{t_1}^{t_2} C_{NO} dt}{t_2 - t_1}$$

where:

$\int_{t_1}^{t_2} C_{NO} dt$ is the integral of the recording of the continuous dilute NO analyser over the test (t₂-t₁);

C_e is the concentration of NO measured in the diluted exhaust, ppm;

3.2.1.3.1.3. Dilution air concentration of NO shall be determined from the dilution air bag. A correction shall be carried out according to paragraph 3.2.1.1. of this annex.

3.2.1.3.2. NO₂ concentrations (if applicable)

3.2.1.3.2.1. Determination NO₂ concentration from direct diluted measurement

3.2.1.3.2.2. NO₂ concentrations shall be calculated from the integrated NO₂ analyser reading, corrected for varying flow if necessary.

3.2.1.3.2.3. The arithmetic average NO₂ concentration shall be calculated using the following equation:

$$C_e = \frac{\int_{t_1}^{t_2} C_{NO_2} dt}{t_2 - t_1}$$

where:

$\int_{t_1}^{t_2} C_{\text{NO}_2} dt$ is the integral of the recording of the continuous dilute NO_2 analyser over the test (t_2-t_1);

C_e is the concentration of NO_2 measured in the diluted exhaust, ppm.

3.2.1.3.2.4. Dilution air concentration of NO_2 shall be determined from the dilution air bags. Correction is carried out according to paragraph 3.2.1.1. of this annex.

3.2.1.4. N_2O concentration (if applicable)

For measurements using a GC-ECD, the N_2O concentration shall be calculated using the following equations:

$$C_{\text{N}_2\text{O}} = \text{PeakArea}_{\text{sample}} \times \text{Rf}_{\text{N}_2\text{O}}$$

where:

$C_{\text{N}_2\text{O}}$ is the concentration of N_2O , ppm;

and:

$$\text{Rf}_{\text{N}_2\text{O}} = \frac{C_{\text{N}_2\text{O}_{\text{standard}}} (\text{ppm})}{\text{PeakArea}_{\text{standard}}}$$

3.2.1.5. NH_3 concentration (if applicable)

The mean concentration of NH_3 shall be calculated using the following equation:

$$C_{\text{NH}_3} = \frac{1}{n} \sum_{i=1}^{i=n} C_{\text{NH}_3}$$

where:

C_{NH_3} is the instantaneous NH_3 concentration, ppm;

n is the number of measurements.

3.2.1.6. Ethanol concentration (if applicable)

For ethanol measurements using gas chromatography from impingers and diluted gas from a CVS, the ethanol concentration shall be calculated using the following equations:

$$C_{\text{C}_2\text{H}_5\text{OH}} = \text{PeakArea}_{\text{sample}} \times \text{Rf}_{\text{C}_2\text{H}_5\text{OH}}$$

where:

$$\text{Rf}_{\text{C}_2\text{H}_5\text{OH}} = \text{Rf}_{\text{C}_2\text{H}_5\text{OH}} (\text{ppm}) / \text{PeakArea}_{\text{standard}}$$

3.2.1.7. Carbonyl mass (if applicable)

For carbonyl measurements using liquid chromatography, formaldehyde and acetaldehyde shall be calculated as follows.

For each target carbonyl, the carbonyl mass shall be calculated from its 2,4-dinitrophenylhydrazone derivative mass. The mass of each carbonyl compound is determined by the following calculation:

$$\text{Mass}_{\text{sample}} = \text{PeakArea}_{\text{sample}} \times \text{Rf} \times V_{\text{sample}} \times B$$

where:

B is the ratio of the molecular weight of the carbonyl compound to its 2,4-dinitrophenylhydrazone derivative;

V_{sample} is the volume of the sample, ml;

Rf is the response factor for each carbonyl calculated during the calibration using the following equation:

$$Rf = C_{\text{standard}} (\mu\text{g 2,4-DNPH species/ml}) / \text{PeakArea}_{\text{standard}}$$

- 3.2.1.8. Determining the mass of ethanol, acetaldehyde and formaldehyde (if applicable)

As an alternative to measuring the concentrations of ethanol, acetaldehyde and formaldehyde, the M_{EAF} for ethanol petrol blends with less than 25 per cent ethanol by volume may be calculated using the following equation:

$$M_{\text{EAF}} = (0.0302 + 0.0071 \times (\text{percentage of ethanol})) \times M_{\text{NMHC}}$$

where:

M_{EAF} is the mass emission of EAF per test, g/km;

M_{NMHC} is the mass emission of NMHC per test, g/km;

percentage of alcohol is the volume percentage of ethanol in the test fuel.

- 3.2.2. Determination of the HC mass emissions from compression-ignition engines

- 3.2.2.1. To calculate HC mass emission for compression-ignition engines, the arithmetic average HC concentration shall be calculated using the following equation:

$$C_e = \frac{\int_{t_1}^{t_2} C_{\text{HC}} dt}{t_2 - t_1}$$

where:

$\int_{t_1}^{t_2} C_{\text{HC}} dt$ is the integral of the recording of the heated FID over the test (t₁ to t₂);

C_e is the concentration of HC measured in the diluted exhaust in ppm of C_i and is substituted for C_{HC} in all relevant equations.

- 3.2.2.1.1. Dilution air concentration of HC shall be determined from the dilution air bags. Correction shall be carried out according to paragraph 3.2.1.1. of this annex.

- 3.2.3. Fuel consumption and CO₂ calculations for individual vehicles in an interpolation family

- 3.2.3.1. Fuel consumption and CO₂ emissions without using the interpolation method (i.e. using vehicle H only)

The CO₂ value, as calculated in paragraphs 3.2.1. to 3.2.1.1.2. inclusive of this annex, and fuel consumption, as calculated according to paragraph 6. of this annex, shall be attributed to all individual vehicles in the interpolation family and the interpolation method shall not be applicable.

- 3.2.3.2. Fuel consumption and CO₂ emissions using the interpolation method
- The CO₂ emissions and the fuel consumption for each individual vehicle in the interpolation family may be calculated according to paragraphs 3.2.3.2.1. to 3.2.3.2.5. inclusive of this annex.
- 3.2.3.2.1. Fuel consumption and CO₂ emissions of test vehicles L and H
- The mass of CO₂ emissions, M_{CO_2-L} , and M_{CO_2-H} and its phases p, $M_{CO_2-L,p}$ and $M_{CO_2-H,p}$, of test vehicles L and H, used for the following calculations, shall be taken from step 9 of Table A7/1.
- Fuel consumption values are also taken from step 9 of Table A7/1 and are referred to as $FC_{L,p}$ and $FC_{H,p}$.
- 3.2.3.2.2. Road load calculation for an individual vehicle
- In the case that the interpolation family is derived from one or more road load families, the calculation of the individual road load shall only be performed within the road load family applicable to that individual vehicle.
- 3.2.3.2.2.1. Mass of an individual vehicle
- The test masses of vehicles H and L shall be used as input for the interpolation method.
- TM_{ind} , in kg, shall be the individual test mass of the vehicle according to paragraph 3.2.25. of this UN GTR.
- If the same test mass is used for test vehicles L and H, the value of TM_{ind} shall be set to the mass of test vehicle H for the interpolation method.
- 3.2.3.2.2.2. Rolling resistance of an individual vehicle
- 3.2.3.2.2.2.1. The actual RRC values for the selected tyres on test vehicle L, RR_L , and test vehicle H, RR_H , shall be used as input for the interpolation method. See paragraph 4.2.2.1. of Annex 4.
- If the tyres on the front and rear axles of vehicle L or H have different RRC values, the weighted mean of the rolling resistances shall be calculated using the equation in paragraph 3.2.3.2.2.2.3. of this annex.
- 3.2.3.2.2.2.2. For the tyres fitted to an individual vehicle, the value of the rolling resistance coefficient RR_{ind} shall be set to the RRC value of the applicable tyre energy efficiency class according to Table A4/2 of Annex 4.
- If the tyres on the front and rear axles belong to different energy efficiency classes, the weighted mean shall be used and calculated using the equation in paragraph 3.2.3.2.2.2.3. of this annex.
- If the same tyres, or tyres with the same rolling resistance coefficient were fitted to test vehicles L and H, the value of RR_{ind} for the interpolation method shall be set to RR_H .
- 3.2.3.2.2.2.3. Calculating the weighted mean of the rolling resistances

$$RR_x = (RR_{x,FA} \times mp_{x,FA}) + (RR_{x,RA} \times (1 - mp_{x,FA}))$$

where:

x represents vehicle L, H or an individual vehicle.

$RR_{L,FA}$ and $RR_{H,FA}$ are the actual RRCs of the front axle tyres on vehicles L and H respectively, kg/tonne;

$RR_{ind,FA}$ is the RRC value of the applicable tyre energy efficiency class according to Table A4/2 of Annex 4 of the front axle tyres on the individual vehicle, kg/tonne;

$RR_{L,RA}$, and $RR_{H,RA}$ are the actual RRCs of the rear axle tyres on vehicles L and H respectively, kg/tonne;

$RR_{ind,RA}$ is the RRC value of the applicable tyre energy efficiency class according to Table A4/2 of Annex 4 of the rear axle tyres on the individual vehicle, kg/tonne;

$mp_{x,FA}$ is the proportion of the vehicle mass in running order on the front axle;

RR_x shall not be rounded or categorised to tyre energy efficiency classes.

3.2.3.2.2.3. Aerodynamic drag of an individual vehicle

3.2.3.2.2.3.1. Determination of aerodynamic influence of optional equipment

The aerodynamic drag shall be measured for each of the aerodynamic drag-influencing items of optional equipment and body shapes in a wind tunnel fulfilling the requirements of paragraph 3.2. of Annex 4 verified by the responsible authority.

For the purpose of the interpolation method, the aerodynamic drag of optional equipment within one road load family shall be measured at the same wind speed, either v_{low} or v_{high} , preferably v_{high} , as defined in paragraph 6.4.3. of Annex 4. In the case that v_{low} or v_{high} does not exist, (e.g. the road load of V_L and/or V_H are measured using the coastdown method), the aerodynamic force shall be measured at the same wind speed within the range ≥ 80 km/h and ≤ 150 km/h. For Class 1 vehicles, it shall be measured at the same wind speed ≤ 150 km/h.

3.2.3.2.2.3.2. Alternative method for determination of aerodynamic influence of optional equipment

At the request of the manufacturer and with approval of the responsible authority, an alternative method (e.g. simulation, wind tunnel not fulfilling the criteria in Annex 4) may be used to determine $\Delta(C_D \times A_f)$ if the following criteria are fulfilled:

- (a) The alternative method shall fulfil an accuracy for $\Delta(C_D \times A_f)$ of ± 0.015 m² and, additionally, in the case that simulation is used, the CFD method should be validated in detail such that the actual air flow patterns around the body, including magnitudes of flow velocities, forces, or pressures, are shown to match the validation test results;
- (b) The alternative method shall be used only for those aerodynamic-influencing parts (e.g. wheels, body shapes, cooling system) for which equivalency was demonstrated;
- (c) Evidence of equivalency shall be shown in advance to the responsible authority for each road load family in the case that a mathematical method is used, or every four years in the case that a measurement method is used, and in any case shall be based on wind tunnel measurements fulfilling the criteria of this UN GTR;

- (d) If the $\Delta(C_D \times A_f)$ of a particular item of optional equipment is more than double the value of the optional equipment for which the evidence was given, aerodynamic drag shall not be determined by the alternative method; and
- (e) In the case that a simulation model is changed, a revalidation shall be necessary.

3.2.3.2.2.3.3. Application of aerodynamic influence on the individual vehicle

$\Delta(C_D \times A_f)_{\text{ind}}$ is the difference in the product of the aerodynamic drag coefficient multiplied by frontal area between an individual vehicle and test vehicle L due to options and body shapes on the vehicle that differ from those of test vehicle L, m²;

These differences in aerodynamic drag, $\Delta(C_D \times A_f)$, shall be determined with an accuracy of ± 0.015 m².

$\Delta(C_D \times A_f)_{\text{ind}}$ may be calculated according to the following equation maintaining the accuracy of ± 0.015 m² also for the sum of items of optional equipment and body shapes:

$$\Delta(C_D \times A_f)_{\text{ind}} = \sum_{i=1}^n \Delta(C_D \times A_f)_i$$

where:

- C_D is the aerodynamic drag coefficient;
- A_f is the frontal area of the vehicle, m²;
- n is the number of items of optional equipment on the vehicle that are different between an individual vehicle and test vehicle L;
- $\Delta(C_D \times A_f)_i$ is the difference in the product of the aerodynamic drag coefficient multiplied by frontal area due to an individual feature, i , on the vehicle and is positive for an item of optional equipment that adds aerodynamic drag with respect to test vehicle L and vice versa, m².

The sum of all $\Delta(C_D \times A_f)_i$ differences between test vehicles L and H shall correspond to $\Delta(C_D \times A_f)_{\text{LH}}$.

3.2.3.2.2.3.4. Definition of complete aerodynamic delta between test vehicles H and L

The total difference of the aerodynamic drag coefficient multiplied by frontal area between test vehicles L and H shall be referred to as $\Delta(C_D \times A_f)_{\text{LH}}$ and shall be recorded, m².

3.2.3.2.2.3.5. Documentation of aerodynamic influences

The increase or decrease of the product of the aerodynamic drag coefficient multiplied by frontal area expressed as $\Delta(C_D \times A_f)$ for all items of optional equipment and body shapes in the interpolation family that:

- (a) have an influence on the aerodynamic drag of the vehicle; and
 - (b) are to be included in the interpolation,
- shall be recorded, m².

3.2.3.2.2.3.6. Additional provisions for aerodynamic influences

The aerodynamic drag of vehicle H shall be applied to the whole interpolation family and $\Delta(C_D \times A_f)_{LH}$ shall be set to zero, if:

- (a) the wind tunnel facility is not able to accurately determine $\Delta(C_D \times A_f)$;
or
- (b) there are no drag-influencing items of optional equipment between the test vehicles H and L that are to be included in the interpolation method.

3.2.3.2.2.4. Calculation of road load coefficients for individual vehicles

The road load coefficients f_0 , f_1 and f_2 (as defined in Annex 4) for test vehicles H and L are referred to as $f_{0,H}$, $f_{1,H}$ and $f_{2,H}$, and $f_{0,L}$, $f_{1,L}$ and $f_{2,L}$ respectively. An adjusted road load curve for the test vehicle L is defined as follows:

$$F_L(v) = f_{0,L}^* + f_{1,H} \times v + f_{2,L}^* \times v^2$$

Applying the least squares regression method in the range of the reference speed points, adjusted road load coefficients $f_{0,L}^*$ and $f_{2,L}^*$ shall be determined for $F_L(v)$ with the linear coefficient $f_{1,L}^*$ set to $f_{1,H}$. The road load coefficients $f_{0,ind}$, $f_{1,ind}$ and $f_{2,ind}$ for an individual vehicle in the interpolation family shall be calculated using the following equations:

$$f_{0,ind} = f_{0,H} - \Delta f_0 \times \frac{(TM_H \times RR_H - TM_{ind} \times RR_{ind})}{(TM_H \times RR_H - TM_L \times RR_L)}$$

or, if $(TM_H \times RR_H - TM_L \times RR_L) = 0$, the equation for $f_{0,ind}$ below shall apply:

$$f_{0,ind} = f_{0,H} - \Delta f_0$$

$$f_{1,ind} = f_{1,H}$$

$$f_{2,ind} = f_{2,H} - \Delta f_2 \frac{(\Delta[C_D \times A_f]_{LH} - \Delta[C_d \times A_f]_{ind})}{(\Delta[C_D \times A_f]_{LH})}$$

or, if $\Delta(C_D \times A_f)_{LH} = 0$, the equation for $F_{2,ind}$ below shall apply:

$$f_{2,ind} = f_{2,H} - \Delta f_2$$

where:

$$\Delta f_0 = f_{0,H} - f_{0,L}^*$$

$$\Delta f_2 = f_{2,H} - f_{2,L}^*$$

In the case of a road load matrix family, the road load coefficients f_0 , f_1 and f_2 for an individual vehicle shall be calculated according to the equations in paragraph 5.1.1. of Annex 4.

3.2.3.2.3. Calculation of cycle energy demand

The cycle energy demand of the applicable WLTC E_k and the energy demand for all applicable cycle phases $E_{k,p}$ shall be calculated according to the procedure in paragraph 5. of this annex for the following sets k of road load coefficients and masses:

k=1: $f_0 = f_{0,L}^*$, $f_1 = f_{1,H}$, $f_2 = f_{2,L}^*$, $m = TM_L$
(test vehicle L)

k=2: $f_0 = f_{0,H}$, $f_1 = f_{1,H}$, $f_2 = f_{2,H}$, $m = TM_H$

(test vehicle H)

$$k=3: \quad f_0 = f_{0,ind}, \quad f_1 = f_{1,H}, \quad f_2 = f_{2,ind}, \quad m = TM_{ind}$$

(an individual vehicle in the interpolation family)

These three sets of road loads may be derived from different road load families.

3.2.3.2.4. Calculation of the CO₂ value for an individual vehicle within an interpolation family using the interpolation method

For each cycle phase p of the applicable cycle the mass of CO₂ emissions g/km, for an individual vehicle shall be calculated using the following equation:

$$M_{CO_2-ind,p} = M_{CO_2-L,p} + \left(\frac{E_{3,p} - E_{1,p}}{E_{2,p} - E_{1,p}} \right) \times (M_{CO_2-H,p} - M_{CO_2-L,p})$$

The mass of CO₂ emissions, g/km, over the complete cycle for an individual vehicle shall be calculated using the following equation:

$$M_{CO_2-ind} = M_{CO_2-L} + \left(\frac{E_3 - E_1}{E_2 - E_1} \right) \times (M_{CO_2-H} - M_{CO_2-L})$$

The terms E_{1,p}, E_{2,p} and E_{3,p} and E₁, E₂ and E₃ respectively shall be calculated as specified in paragraph 3.2.3.2.3. of this annex.

3.2.3.2.5. Calculation of the fuel consumption FC value for an individual vehicle within an interpolation family using the interpolation method

For each cycle phase p of the applicable cycle, the fuel consumption, l/100 km, for an individual vehicle shall be calculated using the following equation:

$$FC_{ind,p} = FC_{L,p} + \left(\frac{E_{3,p} - E_{1,p}}{E_{2,p} - E_{1,p}} \right) \times (FC_{H,p} - FC_{L,p})$$

The fuel consumption, l/100 km, of the complete cycle for an individual vehicle shall be calculated using the following equation:

$$FC_{ind} = FC_L + \left(\frac{E_3 - E_1}{E_2 - E_1} \right) \times (FC_H - FC_L)$$

The terms E_{1,p}, E_{2,p} and E_{3,p}, and E₁, E₂ and E₃ respectively shall be calculated as specified in paragraph 3.2.3.2.3. of this annex.

3.2.3.2.6. The individual CO₂ value determined in paragraph 3.2.3.2.4. of this annex may be increased by the original equipment manufacturer (OEM). In such cases:

- (a) The CO₂ phase values shall be increased by the ratio of the increased CO₂ value divided by the calculated CO₂ value;
- (b) The fuel consumption values shall be increased by the ratio of the increased CO₂ value divided by the calculated CO₂ value.

This shall not compensate for technical elements that would effectively require a vehicle to be excluded from the interpolation family.

3.2.4. Fuel consumption and CO₂ calculations for individual vehicles in a road load matrix family

The CO₂ emissions and the fuel consumption for each individual vehicle in the road load matrix family shall be calculated according to the interpolation method described in paragraphs 3.2.3.2.3. to 3.2.3.2.5. inclusive of this annex.

Where applicable, references to vehicle L and/or H shall be replaced by references to vehicle L_M and/or H_M respectively.

3.2.4.1. Determination of fuel consumption and CO₂ emissions of vehicles L_M and H_M

The mass of CO₂ emissions M_{CO_2} of vehicles L_M and H_M shall be determined according to the calculations in paragraph 3.2.1. of this annex for the individual cycle phases p of the applicable WLTC and are referred to as $M_{CO_2-LM,p}$ and $M_{CO_2-HM,p}$ respectively. Fuel consumption for individual cycle phases of the applicable WLTC shall be determined according to paragraph 6. of this annex and are referred to as $FC_{LM,p}$ and $FC_{HM,p}$ respectively.

3.2.4.1.1. Road load calculation for an individual vehicle

The road load force shall be calculated according to the procedure described in paragraph 5.1. of Annex 4.

3.2.4.1.1.1. Mass of an individual vehicle

The test masses of vehicles H_M and L_M selected according to paragraph 4.2.1.4. of Annex 4 shall be used as input.

TM_{ind} , in kg, shall be the test mass of the individual vehicle according to the definition of test mass in paragraph 3.2.25. of this UN GTR.

If the same test mass is used for vehicles L_M and H_M , the value of TM_{ind} shall be set to the mass of vehicle H_M for the road load matrix family method.

3.2.4.1.1.2. Rolling resistance of an individual vehicle

3.2.4.1.1.2.1. The RRC values for vehicle L_M , RR_{LM} , and vehicle H_M , RR_{HM} , selected under paragraph 4.2.1.4. of Annex 4, shall be used as input.

If the tyres on the front and rear axles of vehicle L_M or H_M have different rolling resistance values, the weighted mean of the rolling resistances shall be calculated using the equation in paragraph 3.2.4.1.1.2.3. of this annex.

3.2.4.1.1.2.2. For the tyres fitted to an individual vehicle, the value of the rolling resistance coefficient RR_{ind} shall be set to the RRC value of the applicable tyre energy efficiency class according to Table A4/2 of Annex 4.

If the tyres on the front and the rear axles belong to different energy efficiency classes, the weighted mean shall be used and shall be calculated using the equation in paragraph 3.2.4.1.1.2.3. of this annex.

If the same rolling resistance is used for vehicles L_M and H_M , the value of RR_{ind} shall be set to RR_{HM} for the road load matrix family method.

3.2.4.1.1.2.3. Calculating the weighed mean of the rolling resistances

$$RR_x = (RR_{x,FA} \times mp_{x,FA}) + (RR_{x,RA} \times (1 - mp_{x,FA}))$$

where:

x represents vehicle L, H or an individual vehicle;

$RR_{LM,FA}$ and $RR_{HM,FA}$ are the actual RRCs of the front axle tyres on vehicles L and H respectively, kg/tonne;

$RR_{ind,FA}$ is the RRC value of the applicable tyre energy efficiency class according to Table A4/2 of Annex 4 of the front axle tyres on the individual vehicle, kg/tonne;

$RR_{LM,RA}$, and $RR_{HM,RA}$ are the actual rolling resistance coefficients of the rear axle tyres on vehicles L and H respectively, kg/tonne;

$RR_{ind,RA}$ is the RRC value of the applicable tyre energy efficiency class according to Table A4/2 of Annex 4 of the rear axle tyres on the individual vehicle, kg/tonne;

$mp_{x,FA}$ is the proportion of the vehicle mass in running order on the front axle.

RR_x shall not be rounded or categorised to tyre energy efficiency classes.

3.2.4.1.1.3. Frontal area of an individual vehicle

The frontal area for vehicle L_M , A_{fLM} , and vehicle H_M , A_{fHM} , selected under paragraph 4.2.1.4. of Annex 4 shall be used as input.

$A_{f,ind}$, in m^2 , shall be the frontal area of the individual vehicle.

If the same frontal area is used for vehicles L_M and H_M , the value of $A_{f,ind}$ shall be set to the frontal area of vehicle H_M for the road load matrix family method.

3.2.5. Alternative interpolation calculation method

Upon request of the manufacturer and with approval of the responsible authority, a manufacturer may apply an alternative interpolation calculation procedure in the case that the interpolation method creates unrealistic phase-specific CO_2 results or an unrealistic road load curve. Before such permission is granted, the manufacturer shall check and where possible correct:

(a) The reason for having small differences between the road load relevant characteristics between vehicle L and H in the case of unrealistic phase-specific CO_2 results;

(b) The reason for having an unexpected difference between the $f_{1,L}$ and $f_{1,H}$ coefficients in the case of an unrealistic road load curve.

The request of the manufacturer to the responsible authority shall include evidence that such a correction is not possible, and that the resultant error is significant.

3.2.5.1. Alternative calculation to correct unrealistic phase-specific CO_2 results

Alternatively to the procedures defined in paragraphs 3.2.3.2.4. and 3.2.3.2.5. of this annex, calculations of phase CO_2 and phase fuel consumption may be calculated according to the equations in paragraphs 3.2.5.1.1., 3.2.5.1.2. and 3.2.5.1.3. below.

3.2.5.1.1. Ratio determination for each phase of V_L and V_H

$$R_{p,L} = \frac{M_{CO_2,p,L}}{M_{CO_2,c,L}}$$

$$R_{p,H} = \frac{M_{CO_2,p,H}}{M_{CO_2,c,H}}$$

where:

$M_{CO_2,p,L}$, $M_{CO_2,c,L}$, $M_{CO_2,p,H}$ and $M_{CO_2,c,H}$ are from step 9 in Table A7/1 in this annex.

3.2.5.1.2. Ratio determination for each phase for vehicle V_{ind}

$$R_{p,ind} = R_{p,L} + \left(\frac{M_{CO_2,c,ind} - M_{CO_2,c,L}}{M_{CO_2,c,H} - M_{CO_2,c,L}} \right) \times (R_{p,H} - R_{p,L})$$

where:

$M_{CO_2,c,ind}$ is from step 10 in Table A7/1 in this annex and shall be rounded to the nearest whole number.

3.2.5.1.3. Phase per phase mass emission of vehicle V_{ind}

$$M_{CO_2,p,ind} = R_{p,ind} \times M_{CO_2,c,ind}$$

3.2.5.2. Alternative calculation to correct an unrealistic road load curve

Alternatively to the procedure defined in paragraph 3.2.3.2.2.4. of this annex, road load coefficients may be calculated as follows:

$$F_i(v) = f_{0,i}^* + f_{1,A} \times v + f_{2,i}^* \times v^2$$

Applying the least squares regression method in the range of the reference speed points, alternative adjusted road load coefficients $f_{0,i}^*$ and $f_{2,i}^*$ shall be determined for $F_i(v)$ with the linear coefficient $f_{1,i}^*$ set to $f_{1,A}$. $f_{1,A}$ is calculated as follow:

$$f_{1,A} = \frac{(E_i - E_{LR}) \times f_{1,HR} + (E_{HR} - E_i) \times f_{1,LR}}{(E_{HR} - E_{LR})}$$

where:

E is the cycle energy demand as defined in paragraph 5. of this annex, Ws;

i is the subscript denoting vehicles L, H or ind;

H_R is test vehicle H as described in paragraph 4.2.1.2.3.2. of Annex 4;

L_R is test vehicle L as described in paragraph 4.2.1.2.3.2. of Annex 4.

3.3. PM

3.3.1. Calculation

PM shall be calculated using the following two equations:

$$PM = \frac{(V_{mix} + V_{ep}) \times P_e}{V_{ep} \times d}$$

where exhaust gases are vented outside tunnel;

and:

$$PM = \frac{V_{mix} \times P_e}{V_{ep} \times d}$$

where exhaust gases are returned to the tunnel;

where:

V_{mix} is the volume of diluted exhaust gases (see paragraph 2. of this annex), under standard conditions;

V_{ep} is the volume of diluted exhaust gas flowing through the particulate sampling filter under standard conditions;

P_e is the mass of particulate matter collected by one or more sample filters, mg;

d is the distance driven corresponding to the test cycle, km.

- 3.3.1.1. Where correction for the background particulate mass from the dilution system has been used, this shall be determined in accordance with paragraph 2.1.3.1. of Annex 6. In this case, particulate mass (mg/km) shall be calculated using the following equations:

$$PM = \left\{ \frac{P_e}{V_{ep}} - \left[\frac{P_a}{V_{ap}} \times \left(1 - \frac{1}{DF} \right) \right] \right\} \times \frac{(V_{mix} + V_{ep})}{d}$$

in the case that the exhaust gases are vented outside the tunnel;

and:

$$PM = \left\{ \frac{P_e}{V_{ep}} - \left[\frac{P_a}{V_{ap}} \times \left(1 - \frac{1}{DF} \right) \right] \right\} \times \frac{V_{mix}}{d}$$

in the case that the exhaust gases are returned to the tunnel;

where:

V_{ap} is the volume of tunnel air flowing through the background particulate filter under standard conditions;

P_a is the particulate mass from the dilution air, or the dilution tunnel background air, as determined by the one of the methods described in paragraph 2.1.3.1. of Annex 6;

DF is the dilution factor determined in paragraph 3.2.1.1.1. of this annex.

Where application of a background correction results in a negative result, it shall be considered to be zero mg/km.

- 3.3.2. Calculation of PM using the double dilution method

$$V_{ep} = V_{set} - V_{ssd}$$

where:

V_{ep} is the volume of diluted exhaust gas flowing through the particulate sample filter under standard conditions;

V_{set} is the volume of the double diluted exhaust gas passing through the particulate sampling filters under standard conditions;

V_{ssd} is the volume of the secondary dilution air under standard conditions.

Where the secondary diluted sample gas for PM measurement is not returned to the tunnel, the CVS volume shall be calculated as in single dilution, i.e.:

$$V_{mix} = V_{mix\ indicated} + V_{ep}$$

where:

$V_{mix\ indicated}$ is the measured volume of diluted exhaust gas in the dilution system following extraction of the particulate sample under standard conditions.

4. Determination of PN (if applicable)

PN shall be calculated using the following equation:

$$PN = \frac{V \times k \times (\overline{C}_s \times \overline{f}_r - C_b \times \overline{f}_{rb}) \times 10^3}{d}$$

where:

- PN is the particle number emission, particles per kilometre;
- V is the volume of the diluted exhaust gas in litres per test (after primary dilution only in the case of double dilution) and corrected to standard conditions (273.15 K (0 °C) and 101.325 kPa);
- k is a calibration factor to correct the PNC measurements to the level of the reference instrument where this is not applied internally within the PNC. Where the calibration factor is applied internally within the PNC, the calibration factor shall be 1;
- \overline{C}_s is the corrected particle number concentration from the diluted exhaust gas expressed as the arithmetic average number of particles per cubic centimetre from the emissions test including the full duration of the drive cycle. If the volumetric mean concentration results \overline{C} from the PNC are not measured at standard conditions (273.15 K (0 °C) and 101.325 kPa), the concentrations shall be corrected to those conditions \overline{C}_s ;
- C_b is either the dilution air or the dilution tunnel background particle number concentration, as permitted by the responsible authority, in particles per cubic centimetre, corrected for coincidence and to standard conditions (273.15 K (0 °C) and 101.325 kPa);
- \overline{f}_r is the mean particle concentration reduction factor of the VPR at the dilution setting used for the test;
- \overline{f}_{rb} is the mean particle concentration reduction factor of the VPR at the dilution setting used for the background measurement;
- d is the distance driven corresponding to the applicable test cycle, km.

\overline{C} shall be calculated using the following equation:

$$\overline{C} = \frac{\sum_{i=1}^n C_i}{n}$$

where:

- C_i is a discrete measurement of particle number concentration in the diluted gas exhaust from the PNC; particles per cm³ and corrected for coincidence;
- n is the total number of discrete particle number concentration measurements made during the applicable test cycle and shall be calculated using the following equation:

$$n = t \times f$$

where:

- t is the time duration of the applicable test cycle, s;
- f is the data logging frequency of the particle counter, Hz.

5. Calculation of cycle energy demand

Unless otherwise specified, the calculation shall be based on the target speed trace given in discrete time sample points.

For the calculation, each time sample point shall be interpreted as a time period. Unless otherwise specified, the duration Δt of these periods shall be 1 second.

The total energy demand E for the whole cycle or a specific cycle phase shall be calculated by summing E_i over the corresponding cycle time between t_{start} and t_{end} according to the following equation:

$$E = \sum_{t_{\text{start}}}^{t_{\text{end}}} E_i$$

where:

$$E_i = F_i \times d_i \quad \text{if } F_i > 0$$

$$E_i = 0 \quad \text{if } F_i \leq 0$$

and:

t_{start} is the time at which the applicable test cycle or phase starts, s;

t_{end} is the time at which the applicable test cycle or phase ends, s;

E_i is the energy demand during time period (i-1) to (i), Ws;

F_i is the driving force during time period (i-1) to (i), N;

d_i is the distance travelled during time period (i-1) to (i), m.

$$F_i = f_0 + f_1 \times \left(\frac{v_i + v_{i-1}}{2} \right) + f_2 \times \frac{(v_i + v_{i-1})^2}{4} + (1.03 \times TM) \times a_i$$

where:

F_i is the driving force during time period (i-1) to (i), N;

v_i is the target velocity at time t_i , km/h;

TM is the test mass, kg;

a_i is the acceleration during time period (i-1) to (i), m/s²;

f_0, f_1, f_2 are the road load coefficients for the test vehicle under consideration (TM_L , TM_H or TM_{ind}) in N, N/km/h and in N/(km/h)² respectively.

$$d_i = \frac{(v_i + v_{i-1})}{2 \times 3.6} \times (t_i - t_{i-1})$$

where:

d_i is the distance travelled in time period (i-1) to (i), m;

v_i is the target velocity at time t_i , km/h;

t_i is time, s.

$$a_i = \frac{v_i - v_{i-1}}{3.6 \times (t_i - t_{i-1})}$$

where:

a_i is the acceleration during time period (i-1) to (i), m/s²;

v_i is the target velocity at time t_i , km/h;

t_i is time, s.

6. Calculation of fuel consumption

6.1. The fuel characteristics required for the calculation of fuel consumption values shall be taken from Annex 3 of this UN GTR.

6.2. The fuel consumption values shall be calculated from the emissions of hydrocarbons, carbon monoxide, and carbon dioxide using the results of step 6 for criteria emissions and step 7 for CO₂ of Table A7/1.

6.2.1. The general equation in paragraph 6.12. of this annex using H/C and O/C ratios shall be used for the calculation of fuel consumption.

6.2.2. For all equations in paragraph 6. of this annex:

FC is the fuel consumption of a specific fuel, l/100 km (or m³ per 100 km in the case of natural gas or kg/100 km in the case of hydrogen);

H/C is the hydrogen to carbon ratio of a specific fuel C_xH_yO_z;

O/C is the oxygen to carbon ratio of a specific fuel C_xH_yO_z;

MW_C is the molar mass of carbon (12.011 g/mol);

MW_H is the molar mass of hydrogen (1.008 g/mol);

MW_O is the molar mass of oxygen (15.999 g/mol);

ρ_{fuel} is the test fuel density, kg/l. For gaseous fuels, fuel density at 15 °C;

HC are the emissions of hydrocarbon, g/km;

CO are the emissions of carbon monoxide, g/km;

CO₂ are the emissions of carbon dioxide, g/km;

H₂O are the emissions of water, g/km;

H₂ are the emissions of hydrogen, g/km;

p_1 is the gas pressure in the fuel tank before the applicable test cycle, Pa;

p_2 is the gas pressure in the fuel tank after the applicable test cycle, Pa;

T_1 is the gas temperature in the fuel tank before the applicable test cycle, K;

T_2 is the gas temperature in the fuel tank after the applicable test cycle, K;

Z_1 is the compressibility factor of the gaseous fuel at p_1 and T_1 ;

Z_2 is the compressibility factor of the gaseous fuel at p_2 and T_2 ;

V is the interior volume of the gaseous fuel tank, m³;

d is the theoretical length of the applicable phase or cycle, km.

6.3. For a vehicle with a positive ignition engine fuelled with petrol (E0)

$$FC = \left(\frac{0.1155}{\rho_{\text{fuel}}} \right) \times [(0.866 \times \text{HC}) + (0.429 \times \text{CO}) + (0.273 \times \text{CO}_2)]$$

6.4. For a vehicle with a positive ignition engine fuelled with petrol (E5)

$$FC = \left(\frac{0.118}{\rho_{\text{fuel}}} \right) \times [(0.848 \times \text{HC}) + (0.429 \times \text{CO}) + (0.273 \times \text{CO}_2)]$$

- 6.5. For a vehicle with a positive ignition engine fuelled with petrol (E10)

$$FC = \left(\frac{0.1206}{\rho_{\text{fuel}}} \right) \times [(0.829 \times \text{HC}) + (0.429 \times \text{CO}) + (0.273 \times \text{CO}_2)]$$

- 6.6. For a vehicle with a positive ignition engine fuelled with LPG

$$FC_{\text{norm}} = \left(\frac{0.1212}{0.538} \right) \times [(0.825 \times \text{HC}) + (0.429 \times \text{CO}) + (0.273 \times \text{CO}_2)]$$

- 6.6.1. If the composition of the fuel used for the test differs from the composition that is assumed for the calculation of the normalised consumption, on the manufacturer's request a correction factor *cf* may be applied, using the following equation:

$$FC_{\text{norm}} = \left(\frac{0.1212}{0.538} \right) \times cf \times [(0.825 \times \text{HC}) + (0.429 \times \text{CO}) + (0.273 \times \text{CO}_2)]$$

The correction factor, *cf*, which may be applied, is determined using the following equation:

$$cf = 0.825 + 0.0693 \times n_{\text{actual}}$$

where:

n_{actual} is the actual H/C ratio of the fuel used.

- 6.7. For a vehicle with a positive ignition engine fuelled with NG/biomethane

$$FC_{\text{norm}} = \left(\frac{0.1336}{0.654} \right) \times [(0.749 \times \text{HC}) + (0.429 \times \text{CO}) + (0.273 \times \text{CO}_2)]$$

- 6.8. For a vehicle with a compression engine fuelled with diesel (B0)

$$FC = \left(\frac{0.1156}{\rho_{\text{fuel}}} \right) \times [(0.865 \times \text{HC}) + (0.429 \times \text{CO}) + (0.273 \times \text{CO}_2)]$$

- 6.9. For a vehicle with a compression engine fuelled with diesel (B5)

$$FC = \left(\frac{0.1163}{\rho_{\text{fuel}}} \right) \times [(0.860 \times \text{HC}) + (0.429 \times \text{CO}) + (0.273 \times \text{CO}_2)]$$

- 6.10. For a vehicle with a compression engine fuelled with diesel (B7)

$$FC = \left(\frac{0.1165}{\rho_{\text{fuel}}} \right) \times [(0.858 \times \text{HC}) + (0.429 \times \text{CO}) + (0.273 \times \text{CO}_2)]$$

- 6.11. For a vehicle with a positive ignition engine fuelled with ethanol (E85)

$$FC = \left(\frac{0.1743}{\rho_{\text{fuel}}} \right) \times [(0.574 \times \text{HC}) + (0.429 \times \text{CO}) + (0.273 \times \text{CO}_2)]$$

- 6.12. Fuel consumption for any test fuel may be calculated using the following equation:

$$FC = \frac{MW_C + \frac{H}{C} \times MW_H + \frac{O}{C} \times MW_O}{MW_C \times \rho_{\text{fuel}} \times 10} \times \left(\frac{MW_C}{MW_C + \frac{H}{C} \times MW_H + \frac{O}{C} \times MW_O} \times \text{HC} + \frac{MW_C}{MW_{\text{CO}}} \times \text{CO} + \frac{MW_C}{MW_{\text{CO}_2}} \times \text{CO}_2 \right)$$

- 6.13. Fuel consumption for a vehicle with a positive ignition engine fuelled by hydrogen:

$$FC = 0.024 \times \frac{V}{d} \times \left(\frac{1}{Z_1} \times \frac{p_1}{T_1} - \frac{1}{Z_2} \times \frac{p_2}{T_2} \right)$$

For vehicles fuelled either with gaseous or liquid hydrogen, and with approval of the responsible authority, the manufacturer may choose to calculate fuel

consumption using either the equation for FC below or a method using a standard protocol such as SAE J2572.

$$FC = 0.1 \times (0.1119 \times H_2O + H_2)$$

The compressibility factor, Z, shall be obtained from the following table:

Table A7/2

Compressibility factor Z

| | | p(bar) | | | | | | | | | |
|------|-------|--------|-------|-------|-------|-------|-------|-------|-------|-------|-------|
| | | 5 | 100 | 200 | 300 | 400 | 500 | 600 | 700 | 800 | 900 |
| T(K) | 33 | 0.859 | 1.051 | 1.885 | 2.648 | 3.365 | 4.051 | 4.712 | 5.352 | 5.973 | 6.576 |
| | 53 | 0.965 | 0.922 | 1.416 | 1.891 | 2.338 | 2.765 | 3.174 | 3.570 | 3.954 | 4.329 |
| | 73 | 0.989 | 0.991 | 1.278 | 1.604 | 1.923 | 2.229 | 2.525 | 2.810 | 3.088 | 3.358 |
| | 93 | 0.997 | 1.042 | 1.233 | 1.470 | 1.711 | 1.947 | 2.177 | 2.400 | 2.617 | 2.829 |
| | 113 | 1.000 | 1.066 | 1.213 | 1.395 | 1.586 | 1.776 | 1.963 | 2.146 | 2.324 | 2.498 |
| | 133 | 1.002 | 1.076 | 1.199 | 1.347 | 1.504 | 1.662 | 1.819 | 1.973 | 2.124 | 2.271 |
| | 153 | 1.003 | 1.079 | 1.187 | 1.312 | 1.445 | 1.580 | 1.715 | 1.848 | 1.979 | 2.107 |
| | 173 | 1.003 | 1.079 | 1.176 | 1.285 | 1.401 | 1.518 | 1.636 | 1.753 | 1.868 | 1.981 |
| | 193 | 1.003 | 1.077 | 1.165 | 1.263 | 1.365 | 1.469 | 1.574 | 1.678 | 1.781 | 1.882 |
| | 213 | 1.003 | 1.071 | 1.147 | 1.228 | 1.311 | 1.396 | 1.482 | 1.567 | 1.652 | 1.735 |
| | 233 | 1.004 | 1.071 | 1.148 | 1.228 | 1.312 | 1.397 | 1.482 | 1.568 | 1.652 | 1.736 |
| | 248 | 1.003 | 1.069 | 1.141 | 1.217 | 1.296 | 1.375 | 1.455 | 1.535 | 1.614 | 1.693 |
| | 263 | 1.003 | 1.066 | 1.136 | 1.207 | 1.281 | 1.356 | 1.431 | 1.506 | 1.581 | 1.655 |
| | 278 | 1.003 | 1.064 | 1.130 | 1.198 | 1.268 | 1.339 | 1.409 | 1.480 | 1.551 | 1.621 |
| | 293 | 1.003 | 1.062 | 1.125 | 1.190 | 1.256 | 1.323 | 1.390 | 1.457 | 1.524 | 1.590 |
| | 308 | 1.003 | 1.060 | 1.120 | 1.182 | 1.245 | 1.308 | 1.372 | 1.436 | 1.499 | 1.562 |
| | 323 | 1.003 | 1.057 | 1.116 | 1.175 | 1.235 | 1.295 | 1.356 | 1.417 | 1.477 | 1.537 |
| 338 | 1.003 | 1.055 | 1.111 | 1.168 | 1.225 | 1.283 | 1.341 | 1.399 | 1.457 | 1.514 | |
| 353 | 1.003 | 1.054 | 1.107 | 1.162 | 1.217 | 1.272 | 1.327 | 1.383 | 1.438 | 1.493 | |

In the case that the required input values for p and T are not indicated in the table, the compressibility factor shall be obtained by linear interpolation between the compressibility factors indicated in the table, choosing the ones that are the closest to the value sought.

7. Drive trace indices

7.1. General requirement

The prescribed speed between time points in Tables A1/1 to A1/12 shall be determined by linear interpolation at a frequency of 10 Hz.

In the case that the accelerator control is fully activated, the prescribed speed shall be used instead of the actual vehicle speed for drive trace index calculations during such periods of operation.

The on-board diagnostics (OBD) or engine control unit (ECU) monitoring (data collection) system may be used in order to detect the position of the accelerator control. The collection of OBD and/or ECU data shall not influence the vehicle's emissions or performance.

- 7.2. Calculation of drive trace indices
- The following indices shall be calculated according to SAE J2951(Revised JAN2014):
- (a) IWR : Inertial Work Rating, per cent;
 - (b) RMSSE : Root Mean Squared Speed Error, km/h.
- 7.3. Criteria for drive trace indices
- In the case of a type approval test, the following indices shall fulfil the following criteria:
- (a) IWR shall be in the range of $(- 2.0 < IWR < + 4.0)$ per cent;
 - (b) RMSSE, at the option of the Contracting Party, shall be less than 0.8 km/h or less than 1.3 km/h.
- 7.4. Vehicle-specific application of drive trace indices
- 7.4.1. Pure ICE vehicles, NOVC-HEVs, NOVC-FCHVs
- The drive trace indices IWR and RMSSE shall be calculated for the applicable test cycle and comply with the limits specified in paragraph 7.3. of this annex.
- 7.4.2. OVC-HEVs
- 7.4.2.1. Charge-sustaining Type 1 test (paragraph 3.2.5. of Annex 8)
- The drive trace indices IWR and RMSSE shall be calculated for the applicable test cycle and comply with the limits specified in paragraph 7.3. of this annex.
- 7.4.2.2. Charge-depleting Type 1 test (paragraph 3.2.4.3. of Annex 8)
- If the number of charge-depleting Type 1 test cycles is less than four, the drive trace indices IWR and RMSSE shall be calculated for each individual applicable test cycle of the charge-depleting Type 1 test and comply with the limits specified in paragraph 7.3. of this annex.
- If the number of charge-depleting Type 1 test cycles is greater than or equal to four, the drive trace indices IWR and RMSSE shall be calculated for each individual applicable test cycle of the charge-depleting Type 1 test. In this case, the average IWR and the average RMSSE for the combination of any two cycles within the charge-depleting test shall comply with the respective limits specified in paragraph 7.3. of this annex, and the calculated IWR of any individual cycle within the charge-depleting test shall not be less than -3.0 nor greater than +5.0 per cent.
- 7.4.2.3. City cycle test (paragraph 3.2.4.3. of Annex 8 replacing WLTC with WLTC_{city})
- For the application of the drive trace index calculation, two consecutively driven city test cycles (L and M) shall be considered as one cycle.
- For the city cycle during which the combustion engine starts to consume fuel, the drive indices IWR and RMSSE shall not be calculated individually. Instead, depending on the number of completed city cycles before the city cycle during which the combustion engine start, the incomplete city cycle shall be combined with the previous city cycles as follows and shall be considered as one cycle in the context of the drive trace index calculations.

If the number of completed city cycles is even, the incomplete city cycle shall be combined with the previous two completed city cycles. See the example in Figure A7/1 below.

Figure A7/1

Example with an even number of completed city test cycles before the city cycle where the combustion engine start

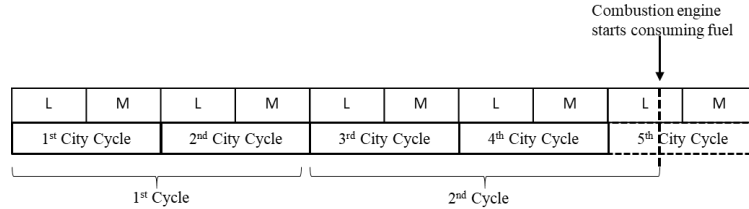

If the number of completed city cycles is odd, the incomplete city cycle shall be combined with the previous three completed city cycles. See the example in figure A7/2 below.

Figure A7/2

Example with an odd number of completed city test cycles before the city cycle where the combustion engine start

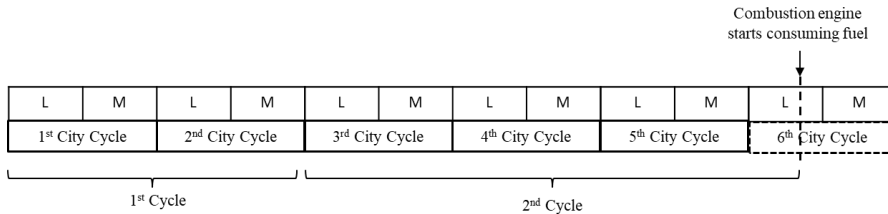

If the number of cycles derived according to Figure A7/1 or Figure A7/2 is less than four, the drive trace indices IWR and RMSSE shall be calculated for each individual cycle and comply with the limits specified in paragraph 7.3. of this annex.

If the number of cycles derived according to Figure A7/1 or Figure A7/2 is greater than or equal to four, the drive trace indices IWR and RMSSE shall be calculated for each individual cycle. In this case, the average IWR and the average RMSSE for the combination of any two cycles shall comply with the respective limits specified in paragraph 7.3. of this annex and the IWR of any individual cycle shall not be less than -3.0 or greater than +5.0 per cent.

7.4.3. PEV

7.4.3.1. Consecutive cycle test

The consecutive cycle test procedure shall be performed according to paragraph 3.4.4.1. of Annex 8. The drive trace indices IWR and RMSSE shall be calculated for each individual test cycle of the consecutive cycle test procedure and shall comply with the limits specified in paragraph 7.3. of this annex. The test cycle during which the break-off criterion is reached, as specified in paragraph 3.4.4.1.3. of Annex 8, shall be combined with the preceding test cycle. The drive trace indices IWR and RMSSE shall be calculated considering this as one cycle and shall comply with the limits specified in paragraph 7.3. of this annex.

7.4.3.2. Shortened Type 1 test

The drive trace indices IWR and RMSSE for the shortened Type 1 test

procedure, as performed according to paragraph 3.4.4.2. of Annex 8, shall be calculated separately for each dynamic segment 1 and 2, and shall comply with the limits specified in paragraph 7.3. of this annex. The calculation of drive trace indices during the constant speed segments shall be omitted.

7.4.3.3. City cycle test procedure (paragraph 3.4.4.1. of Annex 8 replacing WLTC with $WLTC_{city}$)

For the application of the drive trace index calculation, two consecutively driven city test cycles shall be considered as one cycle.

For the city cycle during which the break-off criterion is reached as specified in paragraph 3.4.4.1.3. of Annex 8, the drive trace indices IWR and RMSSE shall not be calculated individually. Instead, depending on the number of completed city cycles before the city cycle when the break-off criterion is reached, the incomplete city cycle shall be combined with previous city cycles and shall be considered as one cycle in the context of the drive trace index calculations.

If the number of completed city cycles is even, the incomplete city cycle shall be combined with the previous two completed city cycles. See the example in Figure A7/3 below.

Figure A7/3

Example with an even number of completed city test cycles before the city cycle with the break-off criterion

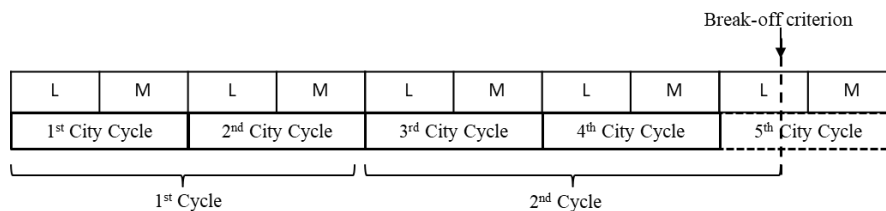

If the number of completed city cycles is odd, the incomplete city cycle shall be combined with the previous three completed city cycles. See the example in Figure A7/4 below.

Figure A7/4

Example with an odd number of completed city test cycles before the city cycle with the break-off criterion

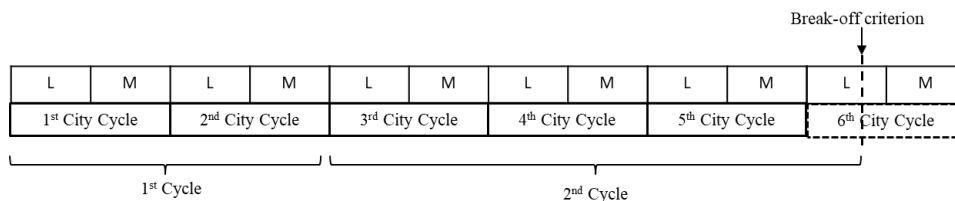

If the number of cycles derived according to Figure A7/3 or Figure A7/4 is less than four, the drive trace indices IWR and RMSSE shall be calculated for each of these cycles and comply with the limits specified in paragraph 7.3. of this annex.

If the number of cycles derived according to Figure A7/3 or Figure A7/4 is greater than or equal to four, the drive trace indices IWR and RMSSE shall be calculated for each of these cycles. In this case, the average IWR and the average RMSSE for the combination of any two cycles shall comply with the respective limits as specified in paragraph 7.3. of this annex and the IWR of

any individual cycle shall not be less than -3.0 or greater than +5.0 per cent.

8. Calculating n/v ratios

n/v ratios shall be calculated using the following equation:

$$\left(\frac{n}{v}\right)_i = (r_i \times r_{\text{axle}} \times 60000)/(U_{\text{dyn}} \times 3.6)$$

where:

n is engine speed, min⁻¹;

v is the vehicle speed, km/h;

r_i is the transmission ratio in gear i;

r_{axle} is the axle transmission ratio.

U_{dyn} is the dynamic rolling circumference of the tyres of the drive axle and is calculated using the following equation:

$$U_{\text{dyn}} = 3.05 \times \left(2 \left(\frac{H/W}{100} \right) \times W + (R \times 25.4) \right)$$

where:

H/W is the tyre's aspect ratio, e.g. "45" for a 225/45 R17 tyre;

W is the tyre width, mm; e.g. "225" for a 225/45 R17 tyre;

R is the wheel diameter, inch; e.g. "17" for a 225/45 R17 tyre.

U_{dyn} shall be rounded according to paragraph 7. of this UN GTR to whole millimetres.

If U_{dyn} is different for the front and the rear axles, the value of n/v for the mainly powered axle shall be applied. Upon request, the responsible authority shall be provided with the necessary information for that selection.

Annex 8

Pure electric, hybrid electric and compressed hydrogen fuel cell hybrid vehicles

1. General requirements

In the case of testing NOVC-HEVs, OVC-HEVs and NOVC-FCHVs, Appendix 2 and Appendix 3 to this annex shall replace Appendix 2 to Annex 6.

Unless stated otherwise, all requirements in this annex shall apply to vehicles with and without driver-selectable modes. Unless explicitly stated otherwise in this annex, all of the requirements and procedures specified in Annex 6 and Annex 7 shall continue to apply for NOVC-HEVs, OVC-HEVs, NOVC-FCHVs and PEVs.

1.1. Units, accuracy and resolution of electric parameters

Units, accuracy and resolution of measurements shall be as shown in Table A8/1.

Table A8/1

Parameters, units, accuracy and resolution of measurements

| <i>Parameter</i> | <i>Units</i> | <i>Accuracy</i> | <i>Resolution</i> |
|--------------------------------|--------------|---|------------------------|
| Electrical energy ^a | Wh | ±1 per cent | 0.001 kWh ^b |
| Electrical current | A | ±0.3 per cent FSD or ±1 per cent of reading ^(3,4) | 0.1 A |
| Electric voltage | V | ±0.3 per cent FSD or ±1 per cent of reading ^c | 0.1 V |

^a Equipment: static meter for active energy.

^b AC watt-hour meter, Class 1 according to IEC 62053-21 or equivalent.

^c Whichever is greater.

^d Current integration frequency 20 Hz or more.

Table A8/2 [RESERVED]

1.2. Emission and fuel consumption testing

Parameters, units and accuracy of measurements shall be the same as those required for pure ICE vehicles.

1.3. Rounding of test results

1.3.1. Unless intermediate rounding is required, intermediate steps in the calculations shall not be rounded.

1.3.2. In the case of OVC-HEVs and NOVC-HEVs, the final criteria emission results shall be rounded according to paragraph 1.3.2. of Annex 7, the NO_x correction factor KH shall be rounded according to paragraph 1.3.3. of Annex 7, and the dilution factor DF shall be rounded according to paragraph 1.3.4. of Annex 7,

1.3.3. For information not related to standards, good engineering judgement shall be used.

- 1.3.4. Rounding of range, CO₂, energy consumption and fuel consumption results is described in the calculation tables of this annex.
- 1.4. Vehicle classification
- All OVC-HEVs, NOVC-HEVs, PEVs and NOVC-FCHVs shall be classified as Class 3 vehicles. The applicable test cycle for the Type 1 test procedure shall be determined according to paragraph 1.4.2. of this annex based on the corresponding reference test cycle as described in paragraph 1.4.1. of this annex.
- 1.4.1. Reference test cycle
- 1.4.1.1. The Class 3 reference test cycles are specified in paragraph 3.3. of Annex 1.
- 1.4.1.2. For PEVs, the downscaling procedure, according to paragraphs 8.2.3. and 8.3. of Annex 1, may be applied on the test cycles according to paragraph 3.3. of Annex 1 by replacing the rated power with maximum net power according to Regulation No. 85. In such a case, the downscaled cycle is the reference test cycle.
- 1.4.2. Applicable test cycle
- 1.4.2.1. Applicable WLTP test cycle
- The reference test cycle according to paragraph 1.4.1. of this annex shall be the applicable WLTP test cycle (WLTC) for the Type 1 test procedure.
- In the case that paragraph 9. of Annex 1 is applied based on the reference test cycle as described in paragraph 1.4.1. of this annex, this modified test cycle shall be the applicable WLTP test cycle (WLTC) for the Type 1 test procedure.
- 1.4.2.2. Applicable WLTP city test cycle
- The Class 3 WLTP city test cycle (WLTC_{city}) is specified in paragraph 3.5. of Annex 1.
- 1.5. OVC-HEVs, NOVC-HEVs and PEVs with manual transmissions
- The vehicles shall be driven according to the technical gear shift indicator, if available, or according to instructions incorporated in the manufacturer's handbook.
2. Run-in of test vehicle
- The vehicle tested according to this annex shall be presented in good technical condition and shall be run-in in accordance with the manufacturer's recommendations. In the case that the REESSs are operated above the normal operating temperature range, the operator shall follow the procedure recommended by the vehicle manufacturer in order to keep the temperature of the REESS in its normal operating range. The manufacturer shall provide evidence that the thermal management system of the REESS is neither disabled nor reduced.
- 2.1. OVC-HEVs and NOVC-HEVs shall have been run-in according to the requirements of paragraph 2.3.3. of Annex 6.
- 2.2. NOVC-FCHVs shall have been run-in at least 300 km with their fuel cell and REESS installed.
- 2.3. PEVs shall have been run-in at least 300 km or one full charge distance, whichever is longer.

-
- 2.4. All REESS having no influence on CO₂ mass emissions or H₂ consumption shall be excluded from monitoring.
 - 3. Test procedure
 - 3.1. General requirements
 - 3.1.1. For all OVC-HEVs, NOVC-HEVs, PEVs and NOVC-FCHVs, the following shall apply where applicable:
 - 3.1.1.1. Vehicles shall be tested according to the applicable test cycles described in paragraph 1.4.2. of this annex.
 - 3.1.1.2. If the vehicle cannot follow the applicable test cycle within the speed trace tolerances according to paragraph 2.6.8.3. of Annex 6, the accelerator control shall, unless stated otherwise, be fully activated until the required speed trace is reached again.
 - 3.1.1.3. The powertrain start procedure shall be initiated by means of the devices provided for this purpose according to the manufacturer's instructions.
 - 3.1.1.4. For OVC-HEVs, NOVC-HEVs and PEVs, exhaust emissions sampling and measurement of electric energy consumption shall begin for each applicable test cycle before or at the initiation of the vehicle start procedure and end at the conclusion of each applicable test cycle.
 - 3.1.1.5. For OVC-HEVs and NOVC-HEVs, gaseous emission compounds, shall be analysed for each individual test phase. It is permitted to omit the phase analysis for phases where no combustion engine operates.
 - 3.1.1.6. If applicable, particle number shall be analysed for each individual phase and particulate matter emission shall be analysed for each applicable test cycle.
 - 3.1.2. Forced cooling as described in paragraph 2.7.2. of Annex 6 shall apply only for the charge-sustaining Type 1 test for OVC-HEVs according to paragraph 3.2. of this annex and for testing NOVC-HEVs according to paragraph 3.3. of this annex.
 - 3.2. OVC-HEVs
 - 3.2.1. Vehicles shall be tested under charge-depleting operating condition (CD condition), and charge-sustaining operating condition (CS condition)
 - 3.2.2. Vehicles may be tested according to four possible test sequences:
 - 3.2.2.1. Option 1: charge-depleting Type 1 test with no subsequent charge-sustaining Type 1 test.
 - 3.2.2.2. Option 2: charge-sustaining Type 1 test with no subsequent charge-depleting Type 1 test.
 - 3.2.2.3. Option 3: charge-depleting Type 1 test with a subsequent charge-sustaining Type 1 test.
 - 3.2.2.4. Option 4: charge-sustaining Type 1 test with a subsequent charge-depleting Type 1 test.

Figure A8/1
Possible test sequences in the case of OVC-HEV testing

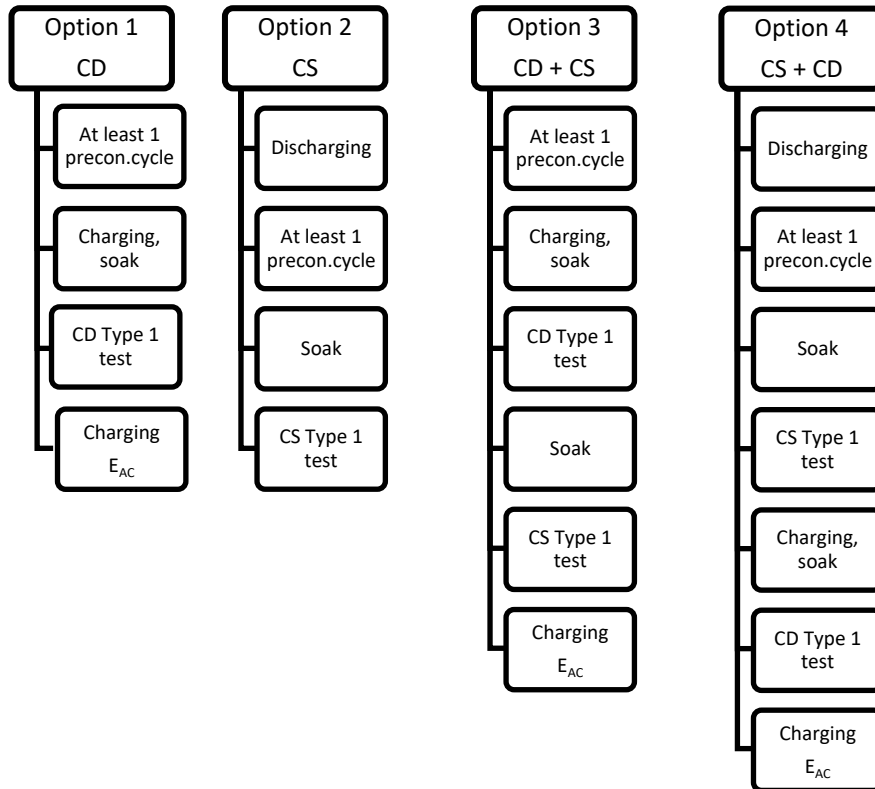

3.2.3. The driver-selectable mode shall be set as described in the following test sequences (Option 1 to Option 4).

3.2.4. Charge-depleting Type 1 test with no subsequent charge-sustaining Type 1 test (Option 1)

The test sequence according to Option 1, described in paragraphs 3.2.4.1. to 3.2.4.7. inclusive of this annex, as well as the corresponding REESS state of charge profile, are shown in Figure A8.App1/1 in Appendix 1 to this annex.

3.2.4.1. Preconditioning

The vehicle shall be prepared according to the procedures in paragraph 2.2. of Appendix 4 to this annex.

3.2.4.2. Test conditions

3.2.4.2.1. The test shall be carried out with a fully charged REESS according to the charging requirements as described in paragraph 2.2.3. of Appendix 4 to this annex and with the vehicle operated in charge-depleting operating condition as defined in paragraph 3.3.5. of this UN GTR.

3.2.4.2.2. Selection of a driver-selectable mode

For vehicles equipped with a driver-selectable mode, the mode for the charge-depleting Type 1 test shall be selected according to paragraph 2. of Appendix 6 to this annex.

- 3.2.4.3. Charge-depleting Type 1 test procedure
- 3.2.4.3.1. The charge-depleting Type 1 test procedure shall consist of a number of consecutive cycles, each followed by a soak period of no more than 30 minutes until charge-sustaining operating condition is achieved.
- 3.2.4.3.2. During soaking between individual applicable test cycles, the powertrain shall be deactivated and the REESS shall not be recharged from an external electric energy source. The instrumentation for measuring the electric current of all REESSs and for determining the electric voltage of all REESSs according to Appendix 3 of this annex shall not be turned off between test cycle phases. In the case of ampere-hour meter measurement, the integration shall remain active throughout the entire test until the test is concluded.
- Restarting after soak, the vehicle shall be operated in the driver-selectable mode according to paragraph 3.2.4.2.2. of this annex.
- 3.2.4.3.3. In deviation from paragraph 5.3.1. of Annex 5 and additional to paragraph 5.3.1.2. of Annex 5, analysers may be calibrated and zero- checked before and after the charge-depleting Type 1 test.
- 3.2.4.4. End of the charge-depleting Type 1 test
- The end of the charge-depleting Type 1 test is considered to have been reached when the break-off criterion according to paragraph 3.2.4.5. of this annex is reached for the first time. The number of applicable WLTP test cycles up to and including the one where the break-off criterion was reached for the first time is set to n+1.
- The applicable WLTP test cycle n is defined as the transition cycle.
- The applicable WLTP test cycle n+1 is defined to be the confirmation cycle.
- For vehicles without a charge-sustaining capability over the complete applicable WLTP test cycle, the end of the charge-depleting Type 1 test is reached by an indication on a standard on-board instrument panel to stop the vehicle, or when the vehicle deviates from the prescribed speed trace tolerance for 4 consecutive seconds or more. The accelerator control shall be deactivated and the vehicle shall be braked to standstill within 60 seconds.
- 3.2.4.5. Break-off criterion
- 3.2.4.5.1. Whether the break-off criterion has been reached for each driven applicable WLTP test cycle shall be evaluated.
- 3.2.4.5.2. The break-off criterion for the charge-depleting Type 1 test is reached when the relative electric energy change REEC_i, as calculated using the following equation, is less than 0.04.

$$REEC_i = \frac{|\Delta E_{REESS,i}|}{E_{cycle} \times \frac{1}{3600}}$$

where:

REEC_i is the relative electric energy change of the applicable test cycle considered i of the charge-depleting Type 1 test;

| | |
|-----------------------------|--|
| $\Delta E_{\text{REESS},i}$ | is the change of electric energy of all REESSs for the considered charge-depleting Type 1 test cycle i calculated according to paragraph 4.3. of this annex, Wh; |
| E_{cycle} | is the cycle energy demand of the considered applicable WLTP test cycle calculated according to paragraph 5. of Annex 7, Ws; |
| i | is the index number for the considered applicable WLTP test cycle; |
| $\frac{1}{3600}$ | is a conversion factor to Wh for the cycle energy demand. |

- 3.2.4.6. REESS charging and measuring the recharged electric energy
- 3.2.4.6.1. The vehicle shall be connected to the mains within 120 minutes after the applicable WLTP test cycle $n+1$ in which the break-off criterion for the charge-depleting Type 1 test is reached for the first time.
- The REESS is fully charged when the end-of-charge criterion, as defined in paragraph 2.2.3.2. of Appendix 4 to this annex, is reached.
- 3.2.4.6.2. The electric energy measurement equipment, placed between the vehicle charger and the mains, shall measure the recharged electric energy E_{AC} delivered from the mains, as well as its duration. Electric energy measurement may be stopped when the end-of-charge criterion, as defined in paragraph 2.2.3.2. of Appendix 4 to this annex, is reached.
- 3.2.4.7. Each individual applicable WLTP test cycle within the charge-depleting Type 1 test shall fulfil the applicable criteria emission limits according to paragraph 1.2. of Annex 6.
- 3.2.5. Charge-sustaining Type 1 test with no subsequent charge-depleting Type 1 test (Option 2)
- The test sequence according to Option 2, as described in paragraphs 3.2.5.1. to 3.2.5.3.3. inclusive of this annex, as well as the corresponding REESS state of charge profile, are shown in Figure A8.App1/2 in Appendix 1 to this annex.
- 3.2.5.1. Preconditioning and soaking
- The vehicle shall be prepared according to the procedures in paragraph 2.1. of Appendix 4 to this annex.
- 3.2.5.2. Test conditions
- 3.2.5.2.1. Tests shall be carried out with the vehicle operated in charge-sustaining operating condition as defined in paragraph 3.3.6. of this UN GTR.
- 3.2.5.2.2. Selection of a driver-selectable mode
- For vehicles equipped with a driver-selectable mode, the mode for the charge-sustaining Type 1 test shall be selected according to paragraph 3. of Appendix 6 to this annex.
- 3.2.5.3. Type 1 test procedure
- 3.2.5.3.1. Vehicles shall be tested according to the Type 1 test procedures described in Annex 6.
- 3.2.5.3.2. If required, CO₂ mass emission shall be corrected according to Appendix 2 to this annex.

- 3.2.5.3.3. The test according to paragraph 3.2.5.3.1. of this annex shall fulfil the applicable criteria emission limits according to paragraph 1.2. of Annex 6.
- 3.2.6. Charge-depleting Type 1 test with a subsequent charge-sustaining Type 1 test (Option 3)
- The test sequence according to Option 3, as described in paragraphs 3.2.6.1. to 3.2.6.3. inclusive of this annex, as well as the corresponding REESS state of charge profile, are shown in Figure A8.App1/3 in Appendix 1 to this annex.
- 3.2.6.1. For the charge-depleting Type 1 test, the procedure described in paragraphs 3.2.4.1. to 3.2.4.5. inclusive as well as paragraph 3.2.4.7. of this annex shall be followed.
- 3.2.6.2. Subsequently, the procedure for the charge-sustaining Type 1 test described in paragraphs 3.2.5.1. to 3.2.5.3. inclusive of this annex shall be followed. Paragraphs 2.1.1. and 2.1.2. of Appendix 4 to this annex shall not apply.
- 3.2.6.3. REESS charging and measuring the recharged electric energy
- 3.2.6.3.1. The vehicle shall be connected to the mains within 120 minutes after the conclusion of the charge-sustaining Type 1 test.
- The REESS is fully charged when the end-of-charge criterion as defined in paragraph 2.2.3.2. of Appendix 4 to this annex is reached.
- 3.2.6.3.2. The energy measurement equipment, placed between the vehicle charger and the mains, shall measure the recharged electric energy E_{AC} delivered from the mains, as well as its duration. Electric energy measurement may be stopped when the end-of-charge criterion as defined in paragraph 2.2.3.2. of Appendix 4 to this annex is reached.
- 3.2.7. Charge-sustaining Type 1 test with a subsequent charge-depleting Type 1 test (Option 4)
- The test sequence according to Option 4, described in paragraphs 3.2.7.1. and 3.2.7.2. of this annex, as well as the corresponding REESS state of charge profile, are shown in Figure A8.App1/4 of Appendix 1 to this annex.
- 3.2.7.1. For the charge-sustaining Type 1 test, the procedure described in paragraphs 3.2.5.1. to 3.2.5.3. inclusive of this annex, as well as paragraph 3.2.6.3.1. of this annex, shall be followed.
- 3.2.7.2. Subsequently, the procedure for the charge-depleting Type 1 test described in paragraphs 3.2.4.2. to 3.2.4.7. inclusive of this annex shall be followed.
- 3.3. NOVC-HEVs
- The test sequence described in paragraphs 3.3.1. to 3.3.3. inclusive of this annex, as well as the corresponding REESS state of charge profile, are shown in Figure A8.App1/5 of Appendix 1 to this annex.
- 3.3.1. Preconditioning and soaking
- 3.3.1.1. Vehicles shall be preconditioned according to paragraph 2.6. of Annex 6.
- In addition to the requirements of paragraph 2.6. of Annex 6, the level of the state of charge of the traction REESS for the charge-sustaining test may be set according to the manufacturer's recommendation before preconditioning in order to achieve a test under charge-sustaining operating condition.
- 3.3.1.2. Vehicles shall be soaked according to paragraph 2.7. of Annex 6.

- 3.3.2. Test conditions
 - 3.3.2.1. Vehicles shall be tested under charge-sustaining operating condition as defined in paragraph 3.3.6. of this UN GTR.
 - 3.3.2.2. Selection of a driver-selectable mode

For vehicles equipped with a driver-selectable mode, the mode for the charge-sustaining Type 1 test shall be selected according to paragraph 3. of Appendix 6 to this annex.
 - 3.3.3. Type 1 test procedure
 - 3.3.3.1. Vehicles shall be tested according to the Type 1 test procedure described in Annex 6.
 - 3.3.3.2. If required, the CO₂ mass emission shall be corrected according to Appendix 2 to this annex.
 - 3.3.3.3. The charge-sustaining Type 1 test shall fulfil the applicable criteria emission limits according to paragraph 1.2. of Annex 6.
- 3.4. PEVs
 - 3.4.1. General requirements

The test procedure to determine the pure electric range and electric energy consumption shall be selected according to the estimated pure electric range (PER) of the test vehicle from Table A8/3. In the case that the interpolation method is applied, the applicable test procedure shall be selected according to the PER of vehicle H within the specific interpolation family.

Table A8/3

Procedures to determine pure electric range and electric energy consumption

| <i>Applicable test cycle</i> | <i>The estimated PER is...</i> | <i>Applicable test procedure</i> |
|--|---|--|
| Test cycle according to paragraph 1.4.2.1. of this annex including the extra high phase. | ...less than the length of 3 applicable WLTP test cycles. | Consecutive cycle Type 1 test procedure (according to paragraph 3.4.4.1. of this annex). |
| | ... equal to or greater than the length of 3 applicable WLTP test cycles. | Shortened Type 1 test procedure (according to paragraph 3.4.4.2. of this annex). |
| Test cycle according to paragraph 1.4.2.1. of this annex excluding the extra high phase. | ...less than the length of 4 applicable WLTP test cycles. | Consecutive cycle Type 1 test procedure (according to paragraph 3.4.4.1. of this annex). |
| | ...equal to or greater than the length of 4 applicable WLTP test cycles. | Shortened Type 1 test procedure (according to paragraph 3.4.4.2. of this annex). |
| City cycle according to paragraph 1.4.2.2. of this annex. | ...not available over the applicable WLTP test cycle. | Consecutive cycle Type 1 test procedure (according to paragraph 3.4.4.1. of this annex). |

The manufacturer shall give evidence to the responsible authority concerning the estimated pure electric range (PER) prior to the test. In the case that the interpolation method is applied, the applicable test procedure shall be determined based on the estimated PER of vehicle H of the interpolation family. The PER determined by the applied test procedure shall confirm that the correct test procedure was applied.

The test sequence for the consecutive cycle Type 1 test procedure, as described in paragraphs 3.4.2., 3.4.3. and 3.4.4.1. of this annex, as well as the corresponding REESS state of charge profile, are shown in Figure A8.App1/6 of Appendix 1 to this annex.

The test sequence for the shortened Type 1 test procedure, as described in paragraphs 3.4.2., 3.4.3. and 3.4.4.2. of this annex as well as the corresponding REESS state of charge profile, are shown in Figure A8.App1/7 in Appendix 1 to this annex.

3.4.2. Preconditioning

The vehicle shall be prepared according to the procedures in paragraph 3. of Appendix 4 to this annex.

3.4.3. Selection of a driver-selectable mode

For vehicles equipped with a driver-selectable mode, the mode for the test shall be selected according to paragraph 4. of Appendix 6 to this annex.

3.4.4. PEV Type 1 test procedures

3.4.4.1. Consecutive cycle Type 1 test procedure

3.4.4.1.1. Speed trace and breaks

The test shall be performed by driving consecutive applicable test cycles until the break-off criterion according to paragraph 3.4.4.1.3. of this annex is reached.

Breaks for the driver and/or operator are permitted only between test cycles and with a maximum total break time of 10 minutes. During the break, the powertrain shall be switched off.

3.4.4.1.2. REESS current and voltage measurement

From the beginning of the test until the break-off criterion is reached, the electric current of all REESSs shall be measured according to Appendix 3 to this annex and the electric voltage shall be determined according to Appendix 3 to this annex.

3.4.4.1.3. Break-off criterion

The break-off criterion is reached when the vehicle exceeds the prescribed speed trace tolerance as specified in paragraph 2.6.8.3. of Annex 6 for 4 consecutive seconds or more. The accelerator control shall be deactivated. The vehicle shall be braked to standstill within 60 seconds.

3.4.4.2. Shortened Type 1 test procedure

3.4.4.2.1. Speed trace

The shortened Type 1 test procedure consists of two dynamic segments (DS_1 and DS_2) combined with two constant speed segments (CSS_M and CSS_E) as shown in Figure A8/2.

Figure A8/2

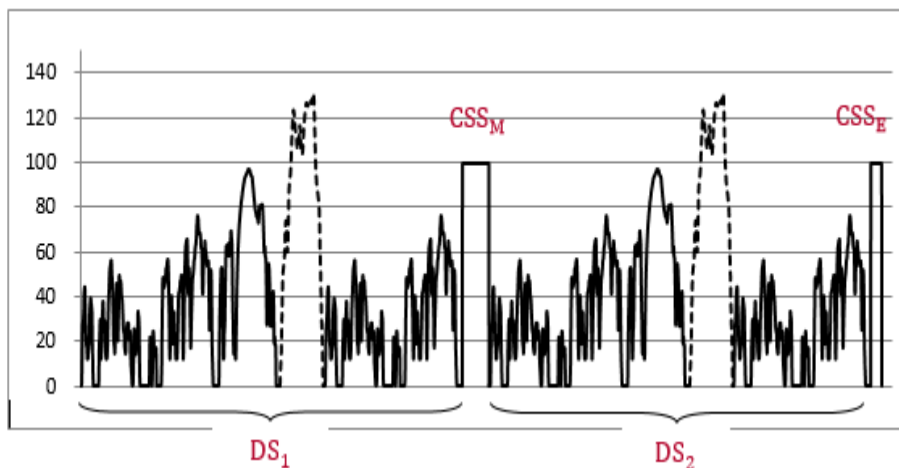
Shortened Type 1 test procedure speed trace

The dynamic segments DS_1 and DS_2 are used to calculate the energy consumption of the phase considered, the applicable WLTP city cycle and the applicable WLTP test cycle.

The constant speed segments CSS_M and CSS_E are intended to reduce test duration by depleting the REESS more rapidly than the consecutive cycle Type 1 test procedure.

3.4.4.2.1.1. Dynamic segments

Each dynamic segment DS_1 and DS_2 consists of an applicable WLTP test cycle according to paragraph 1.4.2.1. of this annex followed by an applicable WLTP city test cycle according to paragraph 1.4.2.2. of this annex.

3.4.4.2.1.2. Constant speed segment

The constant speeds during segments CSS_M and CSS_E shall be identical. If the interpolation method is applied, the same constant speed shall be applied within the interpolation family.

(a) Speed specification

The minimum speed of the constant speed segments shall be 100 km/h. If the extra high phase (Extra High₃) is excluded by a Contracting Party, the minimum speed of the constant speed segments shall be set to 80 km/h. At the request of manufacturer and with approval of the responsible authority, a higher constant speed in the constant speed segments may be selected.

The acceleration to the constant speed level shall be smooth and accomplished within 1 minute after completion of the dynamic segments and, in the case of a break according to Table A8/4, after initiating the powertrain start procedure.

If the maximum speed of the vehicle is lower than the required minimum speed for the constant speed segments according to the speed specification of this paragraph, the required speed in the constant speed segments shall be equal to the maximum speed of the vehicle.

(b) Distance determination of CSS_E and CSS_M

The length of the constant speed segment CSS_E shall be determined based on the percentage of the usable REESS energy UBE_{STP} according to paragraph 4.4.2.1. of this annex. The remaining energy in the traction REESS after dynamic speed segment DS_2 shall be equal to or less than 10 per cent of UBE_{STP} . The manufacturer shall provide evidence to the responsible authority after the test that this requirement is fulfilled.

The length d_{CSSM} of constant speed segment CSS_M may be calculated using the following equation:

$$d_{CSSM} = PER_{est} - d_{DS1} - d_{DS2} - d_{CSSE}$$

where:

d_{CSSM} is the length of constant speed segment CSS_M , km;

PER_{est} is the estimated pure electric range of the considered PEV, km;

d_{DS1} is the length of dynamic speed segment 1, km;

d_{DS2} is the length of dynamic speed segment 2, km;

d_{CSSE} is the length of constant speed segment CSS_E , km.

3.4.4.2.1.3. Breaks

Breaks for the driver and/or operator are permitted only in the constant speed segments as prescribed in Table A8/4.

Table A8/4

Breaks for the driver and/or test operator

| <i>Distance driven in constant speed segment CSS_M (km)</i> | <i>Maximum total break (min)</i> |
|--|---|
| Up to 100 | 10 |
| Up to 150 | 20 |
| Up to 200 | 30 |
| Up to 300 | 60 |
| More than 300 | Shall be based on the manufacturer's recommendation |

Note: During a break, the powertrain shall be switched off.

3.4.4.2.2. REESS current and voltage measurement

From the beginning of the test until the break-off criterion is reached, the electric current of all REESSs and the electric voltage of all REESSs shall be determined according to Appendix 3 to this annex.

3.4.4.2.3. Break-off criterion

The break-off criterion is reached when the vehicle exceeds the prescribed speed trace tolerance as specified in paragraph 2.6.8.3. of Annex 6 for 4 consecutive seconds or more in the second constant speed segment CSS_E . The accelerator control shall be deactivated. The vehicle shall be braked to a standstill within 60 seconds.

3.4.4.3. REESS charging and measuring the recharged electric energy

3.4.4.3.1. After coming to a standstill according to paragraph 3.4.4.1.3. of this annex for the consecutive cycle Type 1 test procedure and in paragraph 3.4.4.2.3. of this annex for the shortened Type 1 test procedure, the vehicle shall be connected to the mains within 120 minutes.

The REESS is fully charged when the end-of-charge criterion, as defined in paragraph 2.2.3.2. of Appendix 4 to this annex, is reached.

3.4.4.3.2. The energy measurement equipment, placed between the vehicle charger and the mains, shall measure the recharged electric energy E_{AC} delivered from the mains as well as its duration. Electric energy measurement may be stopped when the end-of-charge criterion, as defined in paragraph 2.2.3.2. of Appendix 4 to this annex, is reached.

3.5. NOVC-FCHVs

The test sequence, described in paragraphs 3.5.1. to 3.5.3. inclusive of this annex, as well as the corresponding REESS state of charge profile, is shown in Figure A8.App1/5 in Appendix 1 to this annex.

3.5.1. Preconditioning and soaking

Vehicles shall be conditioned and soaked according to paragraph 3.3.1. of this annex.

- 3.5.2. Test conditions
- 3.5.2.1. Vehicles shall be tested under charge-sustaining operating conditions as defined in paragraph 3.3.6. of this UN GTR.
- 3.5.2.2. Selection of a driver-selectable mode
For vehicles equipped with a driver-selectable mode, the mode for the charge-sustaining Type 1 test shall be selected according to paragraph 3. of Appendix 6 to this annex.
- 3.5.3. Type 1 test procedure
- 3.5.3.1. Vehicles shall be tested according to the Type 1 test procedure described in Annex 6 and fuel consumption calculated according to Appendix 7 to this annex.
- 3.5.3.2. If required, fuel consumption shall be corrected according to Appendix 2 to this annex.
4. Calculations for hybrid electric, pure electric and compressed hydrogen fuel cell vehicles
- 4.1. Calculations of gaseous emission compounds, particulate matter emission and particle number emission
- 4.1.1. Charge-sustaining mass emission of gaseous emission compounds, particulate matter emission and particle number emission for OVC-HEVs and NOVC-HEVs
The charge-sustaining particulate matter emission PM_{CS} shall be calculated according to paragraph 3.3. of Annex 7.
The charge-sustaining particle number emission PN_{CS} shall be calculated according to paragraph 4. of Annex 7.
- 4.1.1.1. Stepwise procedure for calculating the final test results of the charge-sustaining Type 1 test for NOVC-HEVs and OVC-HEVs
The results shall be calculated in the order described in Table A8/5. All applicable results in the column "Output" shall be recorded. The column "Process" describes the paragraphs to be used for calculation or contains additional calculations.
For the purpose of this table, the following nomenclature within the equations and results is used:
- c complete applicable test cycle;
p every applicable cycle phase;
i applicable criteria emission component (except CO₂);
CS charge-sustaining;
CO₂ CO₂ mass emission.

Table A8/5
Calculation of final charge-sustaining gaseous emission values

| Source | Input | Process | Output | Step No. |
|---|--|--|--|----------|
| Annex 6 | Raw test results | Charge-sustaining mass emissions Paragraphs 3. to 3.2.2. inclusive of Annex 7. | $M_{i,CS,p,1}$, g/km; $M_{CO_2,CS,p,1}$, g/km. | 1 |
| Output from step No. 1 of this table. | $M_{i,CS,p,1}$, g/km; $M_{CO_2,CS,p,1}$, g/km. | Calculation of combined charge-sustaining cycle values: $M_{i,CS,c,2} = \frac{\sum_p M_{i,CS,p,1} \times d_p}{\sum_p d_p}$ $M_{CO_2,CS,c,2} = \frac{\sum_p M_{CO_2,CS,p,1} \times d_p}{\sum_p d_p}$ where: $M_{i,CS,c,2}$ is the charge-sustaining mass emission result over the total cycle; $M_{CO_2,CS,c,2}$ is the charge-sustaining CO ₂ mass emission result over the total cycle; d_p are the driven distances of the cycle phases p. | $M_{i,CS,c,2}$, g/km; $M_{CO_2,CS,c,2}$, g/km. | 2 |
| Output from steps Nos. 1 and 2 of this table. | $M_{CO_2,CS,p,1}$, g/km; $M_{CO_2,CS,c,2}$, g/km. | REESS electric energy change correction Paragraphs 4.1.1.2. to 4.1.1.5. inclusive of this annex. | $M_{CO_2,CS,p,3}$, g/km; $M_{CO_2,CS,c,3}$, g/km. | 3 |
| Output from steps Nos. 2 and 3 of this table. | $M_{i,CS,c,2}$, g/km; $M_{CO_2,CS,c,3}$, g/km. | Charge-sustaining mass emission correction for all vehicles equipped with periodically regenerating systems K_i according to Annex 6, Appendix 1. $M_{i,CS,c,4} = K_i \times M_{i,CS,c,2}$ or $M_{i,CS,c,4} = K_i + M_{i,CS,c,2}$ and $M_{CO_2,CS,c,4} = K_{CO_2,K_i} \times M_{CO_2,CS,c,3}$ or $M_{CO_2,CS,c,4} = K_{CO_2,K_i} + M_{CO_2,CS,c,3}$ Additive offset or multiplicative factor to be used according to K_i determination. | $M_{i,CS,c,4}$, g/km; $M_{CO_2,CS,c,4}$, g/km. | 4a |

| Source | Input | Process | Output | Step No. |
|--|--|---|--|--|
| | | If K_i is not applicable: $M_{i,CS,c,4} = M_{i,CS,c,2}$ $M_{CO_2,CS,c,4} = M_{CO_2,CS,c,3}$ | | |
| Output from steps Nos. 3 and 4a of this table. | $M_{CO_2,CS,p,3}$, g/km; $M_{CO_2,CS,c,3}$, g/km; $M_{CO_2,CS,c,4}$, g/km. | If K_i is applicable, align CO ₂ phase values to combined cycle value: $M_{CO_2,CS,p,4} = M_{CO_2,CS,p,3} \times AF_{K_i}$ for every cycle phase p; where: $AF_{K_i} = \frac{M_{CO_2,CS,c,4}}{M_{CO_2,CS,c,3}}$ If K_i is not applicable: $M_{CO_2,CS,p,4} = M_{CO_2,CS,p,3}$ | $M_{CO_2,CS,p,4}$, g/km. | 4b |
| Output from step No. 4 of this table. | $M_{i,CS,c,4}$, g/km; $M_{CO_2,CS,p,4}$, g/km; $M_{CO_2,CS,c,4}$, g/km; | Placeholder for additional corrections, if applicable. Otherwise: $M_{i,CS,c,5} = M_{i,CS,c,4}$ $M_{CO_2,CS,c,5} = M_{CO_2,CS,c,4}$ $M_{CO_2,CS,p,5} = M_{CO_2,CS,p,4}$ | $M_{i,CS,c,5}$, g/km; $M_{CO_2,CS,c,5}$, g/km; $M_{CO_2,CS,p,5}$, g/km. | 5 Result of a single test. |
| Output from step No. 5 of this table. | For every test: $M_{i,CS,c,5}$, g/km; $M_{CO_2,CS,c,5}$, g/km; $M_{CO_2,CS,p,5}$, g/km. | Averaging of tests and declared value according to paragraphs 1.2. to 1.2.3. inclusive of Annex 6. | $M_{i,CS,c,6}$, g/km; $M_{CO_2,CS,c,6}$, g/km; $M_{CO_2,CS,p,6}$, g/km; $M_{CO_2,CS,c,declared}$, g/km. | 6 $M_{i,CS}$ results of a Type 1 test for a test vehicle. |
| Output from step No. 6 of this table. | $M_{CO_2,CS,c,6}$, g/km; $M_{CO_2,CS,p,6}$, g/km; $M_{CO_2,CS,c,declared}$, g/km. | Alignment of phase values. Paragraph 1.2.4. of Annex 6, and: $M_{CO_2,CS,c,7} = M_{CO_2,CS,c,declared}$ | $M_{CO_2,CS,c,7}$, g/km; $M_{CO_2,CS,p,7}$, g/km. | 7 $M_{CO_2,CS}$ results of a Type 1 test for a test vehicle. |
| Output from steps Nos. 6 and 7 of this table. | For each of the test vehicles H and L and, if applicable, vehicle M: $M_{i,CS,c,6}$, g/km; $M_{CO_2,CS,c,7}$, g/km; $M_{CO_2,CS,p,7}$, g/km. | If in addition to a test vehicle H a test vehicle L and, if applicable vehicle M was also tested, the resulting criteria emission value shall be the highest of the two or, if applicable, three values and referred to as $M_{i,CS,c}$. In the case of the combined THC+NO _x emissions, the highest value of the sum referring to either the vehicle H or vehicle L | $M_{i,CS,c}$, g/km; $M_{CO_2,CS,c}$, g/km; $M_{CO_2,CS,p}$, g/km; | 8 Interpolation family result. Final criteria emission result. |

| <i>Source</i> | <i>Input</i> | <i>Process</i> | <i>Output</i> | <i>Step No.</i> |
|---------------------------------------|--|---|--|---|
| | | <p>or, if applicable, vehicle M is to be declared.</p> <p>Otherwise, if no vehicle L or if applicable vehicle M was tested, $M_{i,CS,c} = M_{i,CS,c,6}$</p> <p>In the case that the interpolation method is applied, intermediate rounding shall be applied according to paragraph 7. of this UN GTR. CO₂ values derived in step 7 of this table shall be rounded to two places of decimal. Also, the output for CO₂ is available for vehicles H and vehicle L and, if applicable, for vehicle M.</p> <p>In the case that the interpolation method is not applied, final rounding shall be applied according to paragraph 7. of this UN GTR.</p> <p>CO₂ values derived in step 7 of this table shall be rounded to the nearest whole number.</p> | | If the interpolation method is not applied, step No. 9 is not required and the output of this step is the final CO ₂ result. |
| Output from step No. 8 of this table. | $M_{CO_2,CS,c}$, g/km; $M_{CO_2,CS,p}$, g/km; | <p>CO₂ mass emission calculation according to paragraph 4.5.4.1. of this annex for individual vehicles in an interpolation family.</p> <p>Final rounding of individual vehicle CO₂ values shall be performed according to paragraph 7. of this UN GTR.</p> <p>CO₂ values shall be rounded to the nearest whole number.</p> <p>Output is available for each individual vehicle.</p> | $M_{CO_2,CS,c,ind}$, g/km; $M_{CO_2,CS,p,ind}$, g/km. | 9 Result of an individual vehicle. Final CO ₂ result. |

4.1.1.2. In the case that the correction according to paragraph 1.1.4. of Appendix 2 to this annex was not applied, the following charge-sustaining CO₂ mass emission shall be used:

$$M_{CO_2,CS} = M_{CO_2,CS,nb}$$

where:

$M_{CO_2,CS}$ is the charge-sustaining CO₂ mass emission of the charge-sustaining Type 1 test according to Table A8/5, step No. 3, g/km;

$M_{CO_2,CS,nb}$ is the non-balanced charge-sustaining CO₂ mass emission of the charge-sustaining Type 1 test, not corrected for the energy balance, determined according to Table A8/5, step No. 2, g/km.

- 4.1.1.3. If the correction of the charge-sustaining CO₂ mass emission is required according to paragraph 1.1.3. of Appendix 2 to this annex or in the case that the correction according to paragraph 1.1.4. of Appendix 2 to this annex was applied, the CO₂ mass emission correction coefficient shall be determined according to paragraph 2. of Appendix 2 to this annex. The corrected charge-sustaining CO₂ mass emission shall be determined using the following equation:

$$M_{CO_2,CS} = M_{CO_2,CS,nb} - K_{CO_2} \times EC_{DC,CS}$$

where:

$M_{CO_2,CS}$ is the charge-sustaining CO₂ mass emission of the charge-sustaining Type 1 test according to Table A8/5, step No. 3, g/km;

$M_{CO_2,CS,nb}$ is the non-balanced CO₂ mass emission of the charge-sustaining Type 1 test, not corrected for the energy balance, determined according to Table A8/5, step No. 2, g/km;

$EC_{DC,CS}$ is the electric energy consumption of the charge-sustaining Type 1 test according to paragraph 4.3. of this annex, Wh/km;

K_{CO_2} is the CO₂ mass emission correction coefficient according to paragraph 2.3.2. of Appendix 2 to this annex, (g/km)/(Wh/km).

- 4.1.1.4. In the case that phase-specific CO₂ mass emission correction coefficients have not been determined, the phase-specific CO₂ mass emission shall be calculated using the following equation:

$$M_{CO_2,CS,p} = M_{CO_2,CS,nb,p} - K_{CO_2} \times EC_{DC,CS,p}$$

where:

$M_{CO_2,CS,p}$ is the charge-sustaining CO₂ mass emission of phase p of the charge-sustaining Type 1 test according to Table A8/5, step No. 3, g/km;

$M_{CO_2,CS,nb,p}$ is the non-balanced CO₂ mass emission of phase p of the charge-sustaining Type 1 test, not corrected for the energy balance, determined according to Table A8/5, step No. 1, g/km;

$EC_{DC,CS,p}$ is the electric energy consumption of phase p of the charge-sustaining Type 1 test according to paragraph 4.3. of this annex, Wh/km;

K_{CO_2} is the CO₂ mass emission correction coefficient according to paragraph 2.3.2. of Appendix 2 to this annex, (g/km)/(Wh/km).

- 4.1.1.5. In the case that phase-specific CO₂ mass emission correction coefficients have been determined, the phase-specific CO₂ mass emission shall be calculated using the following equation:

$$M_{CO_2,CS,p} = M_{CO_2,CS,nb,p} - K_{CO_2,p} \times EC_{DC,CS,p}$$

where:

- $M_{CO_2,CS,p}$ is the charge-sustaining CO₂ mass emission of phase p of the charge-sustaining Type 1 test according to Table A8/5, step No. 3, g/km;
- $M_{CO_2,CS,nb,p}$ is the non-balanced CO₂ mass emission of phase p of the charge-sustaining Type 1 test, not corrected for the energy balance, determined according to Table A8/5, step No. 1, g/km;
- $EC_{DC,CS,p}$ is the electric energy consumption of phase p of the charge-sustaining Type 1 test, determined according to paragraph 4.3. of this annex, Wh/km;
- $K_{CO_2,p}$ is the CO₂ mass emission correction coefficient according to paragraph 2.3.2.2. of Appendix 2 to this annex, (g/km)/(Wh/km);
- p is the index of the individual phase within the applicable WLTP test cycle.

4.1.2. Utility factor-weighted charge-depleting CO₂ mass emission for OVC-HEVs

The utility factor-weighted charge-depleting CO₂ mass emission $M_{CO_2,CD}$ shall be calculated using the following equation:

$$M_{CO_2,CD} = \frac{\sum_{j=1}^k (UF_j \times M_{CO_2,CD,j})}{\sum_{j=1}^k UF_j}$$

where:

- $M_{CO_2,CD}$ is the utility factor-weighted charge-depleting CO₂ mass emission, g/km;
- $M_{CO_2,CD,j}$ is the CO₂ mass emission determined according to paragraph 3.2.1. of Annex 7 of phase j of the charge-depleting Type 1 test, g/km;
- UF_j is the utility factor of phase j according to Appendix 5 to this annex;
- j is the index number of the considered phase;
- k is the number of phases driven up to the end of the transition cycle according to paragraph 3.2.4.4. of this annex.

In the case that the interpolation method is applied, k shall be the number of phases driven up to the end of the transition cycle of vehicle L, n_{veh_L} .

If the transition cycle number driven by vehicle H, n_{veh_H} , and, if applicable, by an individual vehicle within the vehicle interpolation family, n_{veh_ind} , is lower than the transition cycle number driven by vehicle L, n_{veh_L} , the confirmation cycle of vehicle H and, if applicable, an individual vehicle shall be included in the calculation. The CO₂ mass emission of each phase of the confirmation cycle shall be subsequently corrected to an electric energy consumption of zero ($EC_{DC,CD,j} = 0$) by using the CO₂ correction coefficient according to Appendix 2 to this annex.

4.1.3. Utility factor-weighted mass emissions of gaseous compounds, particulate matter emission and particle number emission for OVC-HEVs

- 4.1.3.1. The utility factor-weighted mass emission of gaseous compounds shall be calculated using the following equation:

$$M_{i,\text{weighted}} = \sum_{j=1}^k (UF_j \times M_{i,\text{CD},j}) + (1 - \sum_{j=1}^k UF_j) \times M_{i,\text{CS}}$$

where:

- $M_{i,\text{weighted}}$ is the utility factor-weighted mass emission compound i, g/km;
i is the index of the considered gaseous emission compound;
 UF_j is the utility factor of phase j according to Appendix 5 to this annex;
 $M_{i,\text{CD},j}$ is the mass emission of the gaseous emission compound i determined according to paragraph 3.2.1. of Annex 7 of phase j of the charge-depleting Type 1 test, g/km;
 $M_{i,\text{CS}}$ is the charge-sustaining mass emission of gaseous emission compound i for the charge-sustaining Type 1 test according to Table A8/5, step No. 7, g/km;
j is the index number of the considered phase;
k is the number of phases driven until the end of the transition cycle according to paragraph 3.2.4.4. of this annex.

In the case that the interpolation method is applied for $i = \text{CO}_2$, *k* shall be the number of phases driven up to the end of the transition cycle of vehicle L n_{veh_L} .

If the transition cycle number driven by vehicle H, n_{veh_H} , and, if applicable, by an individual vehicle within the vehicle interpolation family $n_{\text{veh}_{\text{ind}}}$ is lower than the transition cycle number driven by vehicle L, n_{veh_L} , the confirmation cycle of vehicle H and, if applicable, an individual vehicle shall be included in the calculation. The CO_2 mass emission of each phase of the confirmation cycle shall then be corrected to an electric energy consumption of zero ($EC_{\text{DC,CD},j} = 0$) by using the CO_2 correction coefficient according to Appendix 2 to this annex.

- 4.1.3.2. The utility factor-weighted particle number emission shall be calculated using the following equation:

$$PN_{\text{weighted}} = \sum_{j=1}^k (UF_j \times PN_{\text{CD},j}) + (1 - \sum_{j=1}^k UF_j) \times PN_{\text{CS}}$$

where:

- PN_{weighted} is the utility factor-weighted particle number emission, particles per kilometre;
 UF_j is the utility factor of phase j according to Appendix 5 to this annex;
 $PN_{\text{CD},j}$ is the particle number emission during phase j determined according to paragraph 4. of Annex 7 for the charge-depleting Type 1 test, particles per kilometre;

- PN_{CS} is the particle number emission determined according to paragraph 4.1.1. of this annex for the charge-sustaining Type 1 test, particles per kilometre;
- j is the index number of the considered phase;
- k is the number of phases driven until the end of transition cycle n according to paragraph 3.2.4.4. of this annex.

4.1.3.3. The utility factor-weighted particulate matter emission shall be calculated using the following equation:

$$PM_{\text{weighted}} = \sum_{c=1}^{n_c} (UF_c \times PM_{CD,c}) + (1 - \sum_{c=1}^{n_c} UF_c) \times PM_{CS}$$

where:

- PM_{weighted} is the utility factor-weighted particulate matter emission, mg/km;
- UF_c is the utility factor of cycle c according to Appendix 5 to this annex;
- PM_{CD,c} is the charge-depleting particulate matter emission during cycle c determined according to paragraph 3.3. of Annex 7 for the charge-depleting Type 1 test, mg/km;
- PM_{CS} is the particulate matter emission of the charge-sustaining Type 1 test according to paragraph 4.1.1. of this annex, mg/km;
- c is the index number of the cycle considered;
- n_c is the number of applicable WLTP test cycles driven until the end of the transition cycle n according to paragraph 3.2.4.4. of this annex.

4.2. Calculation of fuel consumption

4.2.1. Charge-sustaining fuel consumption for OVC-HEVs, NOVC-HEVs and NOVC-FCHVs

4.2.1.1. The charge-sustaining fuel consumption for OVC-HEVs and NOVC-HEVs shall be calculated stepwise according to Table A8/6.

Table A8/6

Calculation of final charge-sustaining fuel consumption for OVC-HEVs, NOVC-HEVs

| Source | Input | Process | Output | Step No. |
|--|---|---|--|--|
| Output from step Nos. 6 and 7 of Table A8/5 of this annex. | M _{i,CS,c,6} , g/km; M _{CO2,CS,c,7} , g/km; M _{CO2,CS,p,7} , g/km. | Calculation of fuel consumption according to paragraph 6. of Annex 7. The calculation of fuel consumption shall be performed separately for the applicable cycle and its phases. For that purpose: (a) the applicable phase or cycle CO ₂ values shall be used; | FC _{CS,c,1} , l/100 km; FC _{CS,p,1} , l/100 km. | 1 FC _{CS} results of a Type 1 test for a test vehicle. |

| <i>Source</i> | <i>Input</i> | <i>Process</i> | <i>Output</i> | <i>Step No.</i> |
|---------------------------|--|--|--|--|
| | | (b) the criteria emission over the complete cycle shall be used. | | |
| Step No. 1 of this table. | $FC_{CS,c,1}$, l/100 km; $FC_{CS,p,1}$, l/100 km. | For FC, the values derived in step No. 1 of this table shall be used. In the case that the interpolation method is applied, intermediate rounding shall be applied according to paragraph 7. of this UN GTR. FC values shall be rounded to three places of decimal. Output is available for vehicles H and vehicle L and, if applicable, for vehicle M. In the case that the interpolation method is not applied, final rounding shall be applied according to paragraph 7. of this UN GTR. FC values shall be rounded to first place of decimal. | $FC_{CS,c}$, l/100 km; $FC_{CS,p}$, l/100 km; | 2 Interpolation family result. If the interpolation method is not applied, step No. 3 is not required and the output of this step is the final result. |
| Step No. 2 of this table. | $FC_{CS,c}$, l/100 km; $FC_{CS,p}$, l/100 km; | Fuel consumption calculation according to paragraph 4.5.5.1. of this annex for individual vehicles in an interpolation family. Final rounding of individual vehicle values shall be performed according to paragraph 7. of this UN GTR. FC values shall be rounded to the first place of decimal. Output is available for each individual vehicle. | $FC_{CS,c,ind}$, l/100 km; $FC_{CS,p,ind}$, l/100 km. | 3 Result of an individual vehicle. Final FC result. |

4.2.1.2. Charge-sustaining fuel consumption for NOVC-FCHVs

4.2.1.2.1. Stepwise procedure for calculating the final test fuel consumption results of the charge-sustaining Type 1 test for NOVC-FCHVs

The results shall be calculated in the order described in the Tables A8/7. All applicable results in the column "Output" shall be recorded. The column "Process" describes the paragraphs to be used for calculation or contains additional calculations.

For the purpose of this table, the following nomenclature within the equations and results is used:

- c complete applicable test cycle;
 p every applicable cycle phase;
 CS charge-sustaining

Table A8/7

Calculation of final charge-sustaining fuel consumption for NOVC-FCHVs

| Source | Input | Process | Output | Step No. |
|---------------------------------------|---|--|--|---|
| Appendix 7 to this annex. | Non-balanced charge-sustaining fuel consumption $FC_{CS,nb}$, kg/100km | Charge-sustaining fuel consumption according to paragraph 2.2.6. of Appendix 7 to this annex (phase-specific values only, if required by the Contracting Party according to paragraph 2.2.7. of Appendix 7 to this annex). | $FC_{CS,p,1}$, kg/100 km; $FC_{CS,c,1}$, kg/100 km. | 1 |
| Output from step No. 1 of this table. | $FC_{CS,p,1}$, kg/100 km; $FC_{CS,c,1}$, kg/100 km. | REESS electric energy change correction. Paragraphs 4.2.1.2.2. to 4.2.1.2.5. inclusive of this annex. | $FC_{CS,p,2}$, kg/100 km; $FC_{CS,c,2}$, kg/100 km. | 2 |
| Output from step No. 2 of this table. | $FC_{CS,p,2}$, kg/100 km; $FC_{CS,c,2}$, kg/100 km. | Placeholder for additional corrections, if applicable. Otherwise: $FC_{CS,p,3} = FC_{CS,p,2}$ $FC_{CS,c,3} = FC_{CS,c,2}$ | $FC_{CS,p,3}$, kg/100 km; $FC_{CS,c,3}$, kg/100 km. | 3 Result of a single test. |
| Output from step No. 3 of this table. | For every test: $FC_{CS,p,3}$, kg/100 km; $FC_{CS,c,3}$, kg/100 km. | Averaging of tests and declared value according to paragraphs 1.2. to 1.2.3. inclusive of Annex 6. | $FC_{CS,p,4}$, kg/100 km; $FC_{CS,c,4}$, kg/100 km. | 4 |
| Output from step No. 4 of this table. | $FC_{CS,p,4}$, kg/100 km; $FC_{CS,c,4}$, kg/100 km; $FC_{CS,c,declared}$, kg/100 km. | Alignment of phase values. Paragraph 1.2.4. of Annex 6, and: $FC_{CS,c,5} = FC_{CS,c,declared}$ FC values shall be rounded according to paragraph 7. of this UN GTR to the second place of decimal. | $FC_{CS,p,5}$, kg/100 km; $FC_{CS,c,5}$, kg/100 km. | 5 FC_{CS} results of a Type 1 test for a test vehicle. |

4.2.1.2.2. In the case that the correction according to paragraph 1.1.4. of Appendix 2 to this annex was not applied, the following charge-sustaining fuel consumption shall be used:

$$FC_{CS} = FC_{CS,nb}$$

where:

FC_{CS} is the charge-sustaining fuel consumption of the charge-sustaining Type 1 test according to Table A8/7, step No. 2, kg/100 km;

$FC_{CS,nb}$ is the non-balanced charge-sustaining fuel consumption of the charge-sustaining Type 1 test, not corrected for the energy balance, according to Table A8/7, step No. 1, kg/100 km.

- 4.2.1.2.3. If the correction of the fuel consumption is required according to paragraph 1.1.3. of Appendix 2 to this annex or in the case that the correction according to paragraph 1.1.4. of Appendix 2 to this annex was applied, the fuel consumption correction coefficient shall be determined according to paragraph 2. of Appendix 2 to this annex. The corrected charge-sustaining fuel consumption shall be determined using the following equation:

$$FC_{CS} = FC_{CS,nb} - K_{fuel,FCHV} \times EC_{DC,CS}$$

where:

FC_{CS} is the charge-sustaining fuel consumption of the charge-sustaining Type 1 test according to Table A8/7, step No. 2, kg/100 km;

$FC_{CS,nb}$ is the non-balanced fuel consumption of the charge-sustaining Type 1 test, not corrected for the energy balance, according to Table A8/7, step No. 1, kg/100 km;

$EC_{DC,CS}$ is the electric energy consumption of the charge-sustaining Type 1 test according to paragraph 4.3. of this annex, Wh/km;

$K_{fuel,FCHV}$ is the fuel consumption correction coefficient according to paragraph 2.3.1. of Appendix 2 to this annex, (kg/100 km)/(Wh/km).

- 4.2.1.2.4. In the case that phase-specific fuel consumption correction coefficients have not been determined, the phase-specific fuel consumption shall be calculated using the following equation:

$$FC_{CS,p} = FC_{CS,nb,p} - K_{fuel,FCHV} \times EC_{DC,CS,p}$$

where:

$FC_{CS,p}$ is the charge-sustaining fuel consumption of phase p of the charge-sustaining Type 1 test according to Table A8/7, step No. 2, kg/100 km;

$FC_{CS,nb,p}$ is the non-balanced fuel consumption of phase p of the charge-sustaining Type 1 test, not corrected for the energy balance, according to Table A8/7, step No. 1, kg/100 km;

$EC_{DC,CS,p}$ is the electric energy consumption of phase p of the charge-sustaining Type 1 test, determined according to paragraph 4.3. of this annex, Wh/km;

$K_{fuel,FCHV}$ is the fuel consumption correction coefficient according to paragraph 2.3.1. of Appendix 2 to this annex, (kg/100 km)/(Wh/km);

p is the index of the individual phase within the applicable WLTP test cycle.

4.2.1.2.5. In the case that phase-specific fuel consumption correction coefficients have been determined, the phase-specific fuel consumption shall be calculated using the following equation:

$$FC_{CS,p} = FC_{CS,nb,p} - K_{fuel,FCHV,p} \times EC_{DC,CS,p}$$

where:

$FC_{CS,p}$ is the charge-sustaining fuel consumption of phase p of the charge-sustaining Type 1 test according to Table A8/7, step No. 2, kg/100 km;

$FC_{CS,nb,p}$ is the non-balanced fuel consumption of phase p of the charge-sustaining Type 1 test, not corrected for the energy balance, according to Table A8/7, step No. 1, kg/100 km;

$EC_{DC,CS,p}$ is the electric energy consumption of phase p of the charge-sustaining Type 1 test, determined according to paragraph 4.3. of this annex, Wh/km;

$K_{fuel,FCHV,p}$ is the fuel consumption correction coefficient for the correction of the phase p according to paragraph 2.3.1.2. of Appendix 2 to this annex, (kg/100 km)/(Wh/km);

p is the index of the individual phase within the applicable WLTP test cycle.

4.2.2. Utility factor-weighted charge-depleting fuel consumption for OVC-HEVs

The utility factor-weighted charge-depleting fuel consumption FC_{CD} shall be calculated using the following equation:

$$FC_{CD} = \frac{\sum_{j=1}^k (UF_j \times FC_{CD,j})}{\sum_{j=1}^k UF_j}$$

where:

FC_{CD} is the utility factor weighted charge-depleting fuel consumption, l/100 km;

$FC_{CD,j}$ is the fuel consumption for phase j of the charge-depleting Type 1 test, determined according to paragraph 6. of Annex 7, l/100 km;

UF_j is the utility factor of phase j according to Appendix 5 to this annex;

j is the index number for the considered phase;

k is the number of phases driven up to the end of the transition cycle according to paragraph 3.2.4.4. of this annex.

In the case that the interpolation method is applied, k shall be the number of phases driven up to the end of the transition cycle of vehicle L $n_{veh,L}$.

If the transition cycle number driven by vehicle H, $n_{veh,H}$, and, if applicable, by an individual vehicle within the vehicle

interpolation family, $n_{veh_{ind}}$, is lower than the transition cycle number driven by vehicle L n_{veh_L} the confirmation cycle of vehicle H and, if applicable, an individual vehicle shall be included in the calculation. The fuel consumption of each phase of the confirmation cycle shall be calculated according to paragraph 6. of Annex 7 with the criteria emission over the complete confirmation cycle and the applicable CO₂ phase value which shall be corrected to an electric energy consumption of zero, $EC_{DC,CD,j} = 0$, by using the CO₂ mass correction coefficient (K_{CO_2}) according to Appendix 2 to this annex.

4.2.3. Utility factor-weighted fuel consumption for OVC-HEVs

The utility factor-weighted fuel consumption from the charge-depleting and charge-sustaining Type 1 test shall be calculated using the following equation:

$$FC_{weighted} = \sum_{j=1}^k (UF_j \times FC_{CD,j}) + (1 - \sum_{j=1}^k UF_j) \times FC_{CS}$$

where:

$FC_{weighted}$ is the utility factor-weighted fuel consumption, l/100 km;

UF_j is the utility factor of phase j according to Appendix 5 to this annex;

$FC_{CD,j}$ is the fuel consumption of phase j of the charge-depleting Type 1 test, determined according to paragraph 6. of Annex 7, l/100 km;

FC_{CS} is the fuel consumption determined according to Table A8/6, step No. 1, l/100 km;

j is the index number for the considered phase;

k is the number of phases driven up to the end of the transition cycle according to paragraph 3.2.4.4. of this annex.

In the case that the interpolation method is applied, k shall be the number of phases driven up to the end of the transition cycle of vehicle L n_{veh_L} .

If the transition cycle number driven by vehicle H, n_{veh_H} , and, if applicable, by an individual vehicle within the vehicle interpolation family $n_{veh_{ind}}$ is lower than the transition cycle number driven by vehicle L, n_{veh_L} , the confirmation cycle of vehicle H and, if applicable, an individual vehicle shall be included in the calculation.

The fuel consumption of each phase of the confirmation cycle shall be calculated according to paragraph 6. of Annex 7 with the criteria emission over the complete confirmation cycle and the applicable CO₂ phase value which shall be corrected to an electric energy consumption of zero $EC_{DC,CD,j} = 0$ by using the CO₂ mass correction coefficient (K_{CO_2}) according to Appendix 2 to this annex.

4.3. Calculation of electric energy consumption

For the determination of the electric energy consumption based on the current and voltage determined according to Appendix 3 to this annex, the following equations shall be used:

$$EC_{DC,j} = \frac{\Delta E_{REESS,j}}{d_j}$$

where:

$EC_{DC,j}$ is the electric energy consumption over the considered period j based on the REESS depletion, Wh/km;

$\Delta E_{REESS,j}$ is the electric energy change of all REESSs during the considered period j, Wh;

d_j is the distance driven in the considered period j, km;

and

$$\Delta E_{REESS,j} = \sum_{i=1}^n \Delta E_{REESS,j,i}$$

where:

$\Delta E_{REESS,j,i}$ is the electric energy change of REESS i during the considered period j, Wh;

and

$$\Delta E_{REESS,j,i} = \frac{1}{3600} \times \int_{t_0}^{t_{end}} U(t)_{REESS,j,i} \times I(t)_{j,i} dt$$

where:

$U(t)_{REESS,j,i}$ is the voltage of REESS i during the considered period j determined according to Appendix 3 to this annex, V;

t_0 is the time at the beginning of the considered period j, s;

t_{end} is the time at the end of the considered period j, s;

$I(t)_{j,i}$ is the electric current of REESS i during the considered period j determined according to Appendix 3 to this annex, A;

i is the index number of the considered REESS;

n is the total number of REESS;

j is the index for the considered period, where a period can be any combination of phases or cycles;

$\frac{1}{3600}$ is the conversion factor from Ws to Wh.

4.3.1. Utility factor-weighted charge-depleting electric energy consumption based on the recharged electric energy from the mains for OVC-HEVs

The utility factor-weighted charge-depleting electric energy consumption based on the recharged electric energy from the mains shall be calculated using the following equation:

$$EC_{AC,CD} = \frac{\sum_{j=1}^k (UF_j \times EC_{AC,CD,j})}{\sum_{j=1}^k UF_j}$$

where:

$EC_{AC,CD}$ is the utility factor-weighted charge-depleting electric energy consumption based on the recharged electric energy from the mains, Wh/km;

UF_j is the utility factor of phase j according to Appendix 5 to this annex;

$EC_{AC,CD,j}$ is the electric energy consumption based on the recharged electric energy from the mains of phase j , Wh/km;

and

$$EC_{AC,CD,j} = EC_{DC,CD,j} \times \frac{E_{AC}}{\sum_{j=1}^k \Delta E_{REESS,j}}$$

where:

$EC_{DC,CD,j}$ is the electric energy consumption based on the REESS depletion of phase j of the charge-depleting Test 1 according to paragraph 4.3. of this annex, Wh/km;

E_{AC} is the recharged electric energy from the mains determined according to paragraph 3.2.4.6. of this annex, Wh;

$\Delta E_{REESS,j}$ is the electric energy change of all REESSs of phase j according to paragraph 4.3. of this annex, Wh;

j is the index number for the considered phase;

k is the number of phases driven up to the end of the transition cycle according to paragraph 3.2.4.4. of this annex.

In the case that the interpolation method is applied, k is the number of phases driven up to the end of the transition cycle of $L, n_{veh,L}$.

4.3.2. Utility factor-weighted electric energy consumption based on the recharged electric energy from the mains for OVC-HEVs

The utility factor-weighted electric energy consumption based on the recharged electric energy from the mains shall be calculated using the following equation:

$$EC_{AC,weighted} = \sum_{j=1}^k (UF_j \times EC_{AC,CD,j})$$

where:

$EC_{AC,weighted}$ is the utility factor-weighted electric energy consumption based on the recharged electric energy from the mains, Wh/km;

UF_j is the utility factor of phase j according to Appendix 5 to this annex;

$EC_{AC,CD,j}$ is the electric energy consumption based on the recharged electric energy from the mains of phase j according to paragraph 4.3.1. of this annex, Wh/km;

j is the index number for the considered phase;

k is the number of phases driven up to the end of the transition cycle according to paragraph 3.2.4.4. of this annex.

In the case that the interpolation method is applied, k is the number of phases driven up to the end of the transition cycle of vehicle L , n_{veh_L} .

4.3.3. Electric energy consumption for OVC-HEVs

4.3.3.1. Determination of cycle-specific electric energy consumption

The electric energy consumption based on the recharged electric energy from the mains and the equivalent all-electric range shall be calculated using the following equation:

$$EC = \frac{E_{AC}}{EAER}$$

where:

EC is the electric energy consumption of the applicable WLTP test cycle based on the recharged electric energy from the mains and the equivalent all-electric range, Wh/km;

E_{AC} is the recharged electric energy from the mains according to paragraph 3.2.4.6. of this annex, Wh;

$EAER$ is the equivalent all-electric range according to paragraph 4.4.4.1. of this annex, km.

4.3.3.2. Determination of phase-specific electric energy consumption

The phase-specific electric energy consumption based on the recharged electric energy from the mains and the phase-specific equivalent all-electric range shall be calculated using the following equation:

$$EC_p = \frac{E_{AC}}{EAER_p}$$

where:

EC_p is the phase-specific electric energy consumption based on the recharged electric energy from the mains and the equivalent all-electric range, Wh/km;

E_{AC} is the recharged electric energy from the mains according to paragraph 3.2.4.6. of this annex, Wh;

$EAER_p$ is the phase-specific equivalent all-electric range according to paragraph 4.4.4.2. of this annex, km.

4.3.4. Electric energy consumption of PEVs

At the option of the Contracting Party, the determination of EC_{city} according to paragraph 4.3.4.2. of this annex may be excluded.

4.3.4.1. The electric energy consumption determined in this paragraph shall be calculated only if the vehicle was able to follow the applicable test cycle within the speed trace tolerances according to paragraph 2.6.8.3. of Annex 6 during the entire considered period.

4.3.4.2. Electric energy consumption determination of the applicable WLTP test cycle

The electric energy consumption of the applicable WLTP test cycle based on the recharged electric energy from the mains and the pure electric range shall be calculated using the following equation:

$$EC_{WLTC} = \frac{E_{AC}}{PER_{WLTC}}$$

where:

EC_{WLTC} is the electric energy consumption of the applicable WLTP test cycle based on the recharged electric energy from the mains and the pure electric range for the applicable WLTP test cycle, Wh/km;

E_{AC} is the recharged electric energy from the mains according to paragraph 3.4.4.3. of this annex, Wh;

PER_{WLTC} is the pure electric range for the applicable WLTP test cycle as calculated according to paragraph 4.4.2.1.1. or paragraph 4.4.2.2.1. of this annex, depending on the PEV test procedure used, km.

4.3.4.3. Electric energy consumption determination of the applicable WLTP city test cycle

The electric energy consumption of the applicable WLTP city test cycle based on the recharged electric energy from the mains and the pure electric range for the applicable WLTP city test cycle shall be calculated using the following equation:

$$EC_{city} = \frac{E_{AC}}{PER_{city}}$$

where:

EC_{city} is the electric energy consumption of the applicable WLTP city test cycle based on the recharged electric energy from the mains and the pure electric range for the applicable WLTP city test cycle, Wh/km;

E_{AC} is the recharged electric energy from the mains according to paragraph 3.4.4.3. of this annex, Wh;

PER_{city} is the pure electric range for the applicable WLTP city test cycle as calculated according to paragraph 4.4.2.1.2. or paragraph 4.4.2.2.2. of this annex, depending on the PEV test procedure used, km.

4.3.4.4. Electric energy consumption determination of the phase-specific values

The electric energy consumption of each individual phase based on the recharged electric energy from the mains and the phase-specific pure electric range shall be calculated using the following equation:

$$EC_p = \frac{E_{AC}}{PER_p}$$

where:

EC_p is the electric energy consumption of each individual phase p based on the recharged electric energy from the mains and the phase-specific pure electric range, Wh/km

E_{AC} is the recharged electric energy from the mains according to paragraph 3.4.4.3. of this annex, Wh;

PER_p is the phase-specific pure electric range as calculated according to paragraph 4.4.2.1.3. or paragraph 4.4.2.2.3. of this annex, depending on the PEV test procedure used, km.

4.4. Calculation of electric ranges

At the option of the Contracting Party, the determination of AER_{city} , PER_{city} and the calculation of $EAER_{city}$ may be excluded.

4.4.1. All-electric ranges AER and AER_{city} for OVC-HEVs

4.4.1.1. All-electric range AER

The all-electric range AER for OVC-HEVs shall be determined from the charge-depleting Type 1 test described in paragraph 3.2.4.3. of this annex as part of the Option 1 test sequence and is referenced in paragraph 3.2.6.1. of this annex as part of the Option 3 test sequence by driving the applicable WLTP test cycle according to paragraph 1.4.2.1. of this annex. The AER is defined as the distance driven from the beginning of the charge-depleting Type 1 test to the point in time where the combustion engine starts consuming fuel.

4.4.1.2. All-electric range city AER_{city}

4.4.1.2.1. The all-electric range city AER_{city} for OVC-HEVs shall be determined from the charge-depleting Type 1 test described in paragraph 3.2.4.3. of this annex as part of the Option 1 test sequence and is referenced in paragraph 3.2.6.1. of this annex as part of the Option 3 test sequence by driving the applicable WLTP city test cycle according to paragraph 1.4.2.2. of this annex. The AER_{city} is defined as the distance driven from the beginning of the charge-depleting Type 1 test to the point in time where the combustion engine starts consuming fuel.

4.4.1.2.2. As an alternative to paragraph 4.4.1.2.1. of this annex, the all-electric range city AER_{city} may be determined from the charge-depleting Type 1 test described in paragraph 3.2.4.3. of this annex by driving the applicable WLTP test cycles according to paragraph 1.4.2.1. of this annex. In that case, the charge-depleting Type 1 test by driving the applicable WLTP city test cycle shall be omitted and the all-electric range city AER_{city} shall be calculated using the following equation:

$$AER_{city} = \frac{UBE_{city}}{EC_{DC,city}}$$

where:

AER_{city} is the all-electric range city, km;

UBE_{city} is the usable REESS energy determined from the beginning of the charge-depleting Type 1 test described in paragraph 3.2.4.3. of this annex by driving applicable WLTP test cycles until the

point in time when the combustion engine starts consuming fuel, Wh;

$EC_{DC,city}$ is the weighted electric energy consumption of the pure electrically driven applicable WLTP city test cycles of the charge-depleting Type 1 test described in paragraph 3.2.4.3. of this annex by driving applicable WLTP test cycle(s), Wh/km;

and

$$UBE_{city} = \sum_{j=1}^{k+1} \Delta E_{REESS,j}$$

where:

$\Delta E_{REESS,j}$ is the electric energy change of all REESSs during phase j, Wh;

j is the index number of the considered phase;

k+1 is the number of the phases driven from the beginning of the test until the point in time when the combustion engine starts consuming fuel;

and

$$EC_{DC,city} = \sum_{j=1}^{n_{city,pe}} EC_{DC,city,j} \times K_{city,j}$$

where:

$EC_{DC,city,j}$ is the electric energy consumption for the jth pure electrically driven WLTP city test cycle of the charge-depleting Type 1 test according to paragraph 3.2.4.3. of this annex by driving applicable WLTP test cycles, Wh/km;

$K_{city,j}$ is the weighting factor for the jth pure electrically driven applicable WLTP city test cycle of the charge-depleting Type 1 test according to paragraph 3.2.4.3. of this annex by driving applicable WLTP test cycles;

j is the index number of the pure electrically driven applicable WLTP city test cycle considered;

$n_{city,pe}$ is the number of pure electrically driven applicable WLTP city test cycles;

and

$$K_{city,1} = \frac{\Delta E_{REESS,city,1}}{UBE_{city}}$$

where:

$\Delta E_{REESS,city,1}$ is the electric energy change of all REESSs during the first applicable WLTP city test cycle of the charge-depleting Type 1 test, Wh;

and

$$K_{city,j} = \frac{1-K_{city,1}}{n_{city,pe}-1} \text{ for } j = 2 \text{ to } n_{city,pe}.$$

4.4.2. Pure electric range for PEVs

The ranges determined in this paragraph shall only be calculated if the vehicle was able to follow the applicable WLTP test cycle within the speed trace tolerances according to paragraph 2.6.8.3. of Annex 6 during the entire considered period.

4.4.2.1. Determination of the pure electric ranges when the shortened Type 1 test procedure is applied

4.4.2.1.1. The pure electric range for the applicable WLTP test cycle PER_{WLTC} for PEVs shall be calculated from the shortened Type 1 test as described in paragraph 3.4.4.2. of this annex using the following equations:

$$PER_{WLTC} = \frac{UBE_{STP}}{EC_{DC,WLTC}}$$

where:

PER_{WLTC} is the pure electric range for the applicable WLTC test cycle for PEVs, km;

UBE_{STP} is the usable REESS energy determined from the beginning of the shortened Type 1 test procedure until the break-off criterion as defined in paragraph 3.4.4.2.3. of this annex is reached, Wh;

$EC_{DC,WLTC}$ is the weighted electric energy consumption for the applicable WLTP test cycle of DS_1 and DS_2 of the shortened Type 1 test procedure Type 1 test, Wh/km;

and

$$UBE_{STP} = \Delta E_{REESS,DS_1} + \Delta E_{REESS,DS_2} + \Delta E_{REESS,CSS_M} + \Delta E_{REESS,CSS_E}$$

where:

$\Delta E_{REESS,DS_1}$ is the electric energy change of all REESSs during DS_1 of the shortened Type 1 test procedure, Wh;

$\Delta E_{REESS,DS_2}$ is the electric energy change of all REESSs during DS_2 of the shortened Type 1 test procedure, Wh;

$\Delta E_{REESS,CSS_M}$ is the electric energy change of all REESSs during CSS_M of the shortened Type 1 test procedure, Wh;

$\Delta E_{REESS,CSS_E}$ is the electric energy change of all REESSs during CSS_E of the shortened Type 1 test procedure, Wh;

and

$$EC_{DC,WLTC} = \sum_{j=1}^2 EC_{DC,WLTC,j} \times K_{WLTC,j}$$

where:

$EC_{DC,WLTC,j}$ is the electric energy consumption for the applicable WLTP test cycle of DS_j of the shortened Type 1 test procedure according to paragraph 4.3. of this annex, Wh/km;

$K_{WLTC,j}$ is the weighting factor for the applicable WLTP test cycle of DS_j of the shortened Type 1 test procedure;

and:

$$K_{WLTC,1} = \frac{\Delta E_{REESS,WLTC,1}}{UBE_{STP}} \text{ and } K_{WLTC,2} = 1 - K_{WLTC,1}$$

where:

$K_{WLTC,j}$ is the weighting factor for the applicable WLTP test cycle of DS_j of the shortened Type 1 test procedure;

$\Delta E_{REESS,WLTC,1}$ is the electric energy change of all REESSs during the applicable WLTP test cycle from DS_1 of the shortened Type 1 test procedure, Wh.

4.4.2.1.2. The pure electric range for the applicable WLTP city test cycle PER_{city} for PEVs shall be calculated from the shortened Type 1 test procedure as described in paragraph 3.4.4.2. of this annex using the following equations:

$$PER_{city} = \frac{UBE_{STP}}{EC_{DC,city}}$$

where:

PER_{city} is the pure electric range for the applicable WLTP city test cycle for PEVs, km;

UBE_{STP} is the usable REESS energy according to paragraph 4.4.2.1.1. of this annex, Wh;

$EC_{DC,city}$ is the weighted electric energy consumption for the applicable WLTP city test cycle of DS_1 and DS_2 of the shortened Type 1 test procedure, Wh/km;

and

$$EC_{DC,city} = \sum_{j=1}^4 EC_{DC,city,j} \times K_{city,j}$$

where:

$EC_{DC,city,j}$ is the electric energy consumption for the applicable WLTP city test cycle where the first applicable WLTP city test cycle of DS_1 is indicated as $j = 1$, the second applicable WLTP city test cycle of DS_1 is indicated as $j = 2$, the first applicable WLTP city test cycle of DS_2 is indicated as $j = 3$ and the second applicable WLTP city test cycle of DS_2 is indicated as $j = 4$ of the shortened Type 1 test procedure according to paragraph 4.3. of this annex, Wh/km;

$K_{city,j}$ is the weighting factor for the applicable WLTP city test cycle where the first applicable WLTP city test cycle of DS_1 is indicated as $j = 1$, the second applicable WLTP city test cycle of DS_1 is indicated as $j = 2$, the first applicable WLTP city test cycle of DS_2 is indicated as $j = 3$ and the second applicable WLTP city test cycle of DS_2 is indicated as $j = 4$,

and

$$K_{city,1} = \frac{\Delta E_{REESS,city,1}}{UBE_{STP}} \text{ and } K_{city,j} = \frac{1 - K_{city,1}}{3} \text{ for } j = 2 \dots 4$$

where:

$\Delta E_{REESS,city,1}$ is the energy change of all REESSs during the first applicable WLTP city test cycle of DS₁ of the shortened Type 1 test procedure, Wh.

- 4.4.2.1.3. The phase-specific pure electric range PER_p for PEVs shall be calculated from the Type 1 test as described in paragraph 3.4.4.2. of this annex by using the following equations:

$$PER_p = \frac{UBE_{STP}}{EC_{DC,p}}$$

where:

PER_p is the phase-specific pure electric range for PEVs, km;

UBE_{STP} is the usable REESS energy according to paragraph 4.4.2.1.1. of this annex, Wh;

EC_{DC,p} is the weighted electric energy consumption for each individual phase of DS₁ and DS₂ of the shortened Type 1 test procedure, Wh/km;

In the case that phase p = low and phase p = medium, the following equations shall be used:

$$EC_{DC,p} = \sum_{j=1}^4 EC_{DC,p,j} \times K_{p,j}$$

where:

EC_{DC,p,j} is the electric energy consumption for phase p where the first phase p of DS₁ is indicated as j = 1, the second phase p of DS₁ is indicated as j = 2, the first phase p of DS₂ is indicated as j = 3 and the second phase p of DS₂ is indicated as j = 4 of the shortened Type 1 test procedure according to paragraph 4.3. of this annex, Wh/km;

K_{p,j} is the weighting factor for phase p where the first phase p of DS₁ is indicated as j = 1, the second phase p of DS₁ is indicated as j = 2, the first phase p of DS₂ is indicated as j = 3, and the second phase p of DS₂ is indicated as j = 4 of the shortened Type 1 test procedure;

and

$$K_{p,1} = \frac{\Delta E_{REESS,p,1}}{UBE_{STP}} \text{ and } K_{p,j} = \frac{1 - K_{p,1}}{3} \text{ for } j = 2 \dots 4$$

where:

$\Delta E_{REESS,p,1}$ is the energy change of all REESSs during the first phase p of DS₁ of the shortened Type 1 test procedure, Wh.

In the case that phase p = high and phase p = extra high, the following equations shall be used:

$$EC_{DC,p} = \sum_{j=1}^2 EC_{DC,p,j} \times K_{p,j}$$

where:

$EC_{DC,p,j}$ is the electric energy consumption for phase p of DS_j of the shortened Type 1 test procedure according to paragraph 4.3. of this annex, Wh/km;

$K_{p,j}$ is the weighting factor for phase p of DS_j of the shortened Type 1 test procedure

and

$$K_{p,1} = \frac{\Delta E_{REESS,p,1}}{UBE_{STP}} \text{ and } K_{p,2} = 1 - K_{p,1}$$

where:

$\Delta E_{REESS,p,1}$ is the electric energy change of all REESSs during the first phase p of DS_1 of the shortened Type 1 test procedure, Wh.

4.4.2.2. Determination of the pure electric ranges when the consecutive cycle Type 1 test procedure is applied

4.4.2.2.1. The pure electric range for the applicable WLTP test cycle PER_{WLTP} for PEVs shall be calculated from the Type 1 test as described in paragraph 3.4.4.1. of this annex using the following equations:

$$PER_{WLTC} = \frac{UBE_{CCP}}{EC_{DC,WLTC}}$$

where:

UBE_{CCP} is the usable REESS energy determined from the beginning of the consecutive cycle Type 1 test procedure until the break-off criterion according to paragraph 3.4.4.1.3. of this annex is reached, Wh;

$EC_{DC,WLTC}$ is the electric energy consumption for the applicable WLTP test cycle determined from completely driven applicable WLTP test cycles of the consecutive cycle Type 1 test procedure, Wh/km;

and

$$UBE_{CCP} = \sum_{j=1}^k \Delta E_{REESS,j}$$

where:

$\Delta E_{REESS,j}$ is the electric energy change of all REESSs during phase j of the consecutive cycle Type 1 test procedure, Wh;

j is the index number of the phase;

k is the number of phases driven from the beginning up to and including the phase where the break-off criterion is reached;

and:

$$EC_{DC,WLTC} = \sum_{j=1}^{n_{WLTC}} EC_{DC,WLTC,j} \times K_{WLTC,j}$$

where:

$EC_{DC,WLTC,j}$ is the electric energy consumption for the applicable WLTP test cycle j of the consecutive cycle Type 1 test procedure according to paragraph 4.3. of this annex, Wh/km;

$K_{WLTC,j}$ is the weighting factor for the applicable WLTP test cycle j of the consecutive cycle Type 1 test procedure;

j is the index number of the applicable WLTP test cycle;

n_{WLTC} is the whole number of complete applicable WLTP test cycles driven;

and

$$K_{WLTC,1} = \frac{\Delta E_{REESS,WLTC,1}}{UBE_{CCP}} \text{ and } K_{WLTC,j} = \frac{1 - K_{WLTC,1}}{n_{WLTC} - 1} \text{ for } j = 2 \dots n_{WLTC}$$

where:

$\Delta E_{REESS,WLTC,1}$ is the electric energy change of all REESSs during the first applicable WLTP test cycle of the consecutive Type 1 test cycle procedure, Wh.

4.4.2.2.2. The pure electric range for the WLTP city test cycle PER_{city} for PEVs shall be calculated from the Type 1 test as described in paragraph 3.4.4.1. of this annex using the following equations:

$$PER_{city} = \frac{UBE_{CCP}}{EC_{DC,city}}$$

where:

PER_{city} is the pure electric range for the WLTP city test cycle for PEVs, km;

UBE_{CCP} is the usable REESS energy according to paragraph 4.4.2.2.1. of this annex, Wh;

$EC_{DC,city}$ is the electric energy consumption for the applicable WLTP city test cycle determined from completely driven applicable WLTP city test cycles of the consecutive cycle Type 1 test procedure, Wh/km;

and

$$EC_{DC,city} = \sum_{j=1}^{n_{city}} EC_{DC,city,j} \times K_{city,j}$$

where:

$EC_{DC,city,j}$ is the electric energy consumption for the applicable WLTP city test cycle j of the consecutive cycle Type 1 test procedure according to paragraph 4.3. of this annex, Wh/km;

$K_{city,j}$ is the weighting factor for the applicable WLTP city test cycle j of the consecutive cycle Type 1 test procedure;

j is the index number of the applicable WLTP city test cycle;

n_{city} is the whole number of complete applicable WLTP city test cycles driven;

and

$$K_{\text{city},1} = \frac{\Delta E_{\text{REESS,city},1}}{\text{UBE}_{\text{CCP}}} \text{ and } K_{\text{city},j} = \frac{1 - K_{\text{city},1}}{n_{\text{city}} - 1} \text{ for } j = 2 \dots n_{\text{city}}$$

where:

$\Delta E_{\text{REESS,city},1}$ is the electric energy change of all REESSs during the first applicable WLTP city test cycle of the consecutive cycle Type 1 test procedure, Wh.

- 4.4.2.2.3. The phase-specific pure electric range PER_p for PEVs shall be calculated from the Type 1 test as described in paragraph 3.4.4.1. of this annex using the following equations:

$$\text{PER}_p = \frac{\text{UBE}_{\text{CCP}}}{\text{EC}_{\text{DC},p}}$$

where:

PER_p is the phase-specific pure electric range for PEVs, km;

UBE_{CCP} is the usable REESS energy according to paragraph 4.4.2.2.1. of this annex, Wh;

$\text{EC}_{\text{DC},p}$ is the electric energy consumption for the considered phase p determined from completely driven phases p of the consecutive cycle Type 1 test procedure, Wh/km;

and

$$\text{EC}_{\text{DC},p} = \sum_{j=1}^{n_p} \text{EC}_{\text{DC},p,j} \times K_{p,j}$$

where:

$\text{EC}_{\text{DC},p,j}$ is the j^{th} electric energy consumption for the considered phase p of the consecutive cycle Type 1 test procedure according to paragraph 4.3. of this annex, Wh/km;

$K_{p,j}$ is the j^{th} weighting factor for the considered phase p of the consecutive cycle Type 1 test procedure;

j is the index number of the considered phase p ;

n_p is the whole number of complete WLTC phases p driven;

and

$$K_{p,1} = \frac{\Delta E_{\text{REESS},p,1}}{\text{UBE}_{\text{CCP}}} \text{ and } K_{p,j} = \frac{1 - K_{p,1}}{n_p - 1} \text{ for } j = 2 \dots n_p$$

where:

$\Delta E_{\text{REESS},p,1}$ is the electric energy change of all REESSs during the first driven phase p during the consecutive cycle Type 1 test procedure, Wh.

- 4.4.3. Charge-depleting cycle range for OVC-HEVs

The charge-depleting cycle range R_{CDC} shall be determined from the charge-depleting Type 1 test described in paragraph 3.2.4.3. of this annex as part of the Option 1 test sequence and is referenced in paragraph 3.2.6.1. of this annex as part of the Option 3 test sequence. The R_{CDC} is the distance driven from the

beginning of the charge-depleting Type 1 test to the end of the transition cycle according to paragraph 3.2.4.4. of this annex.

4.4.4. Equivalent all-electric range for OVC-HEVs

4.4.4.1. Determination of cycle-specific equivalent all-electric range

The cycle-specific equivalent all-electric range shall be calculated using the following equation:

$$EAER = \left(\frac{M_{CO_2,CS} - M_{CO_2,CD,avg}}{M_{CO_2,CS}} \right) \times R_{CDC}$$

where:

- EAER is the cycle-specific equivalent all-electric range, km;
- $M_{CO_2,CS}$ is the charge-sustaining CO₂ mass emission according to Table A8/5, step No. 7, g/km;
- $M_{CO_2,CD,avg}$ is the arithmetic average charge-depleting CO₂ mass emission according to the equation below, g/km;
- R_{CDC} is the charge-depleting cycle range according to paragraph 4.4.2. of this annex, km;

and

$$M_{CO_2,CD,avg} = \frac{\sum_{j=1}^k (M_{CO_2,CD,j} \times d_j)}{\sum_{j=1}^k d_j}$$

where:

- $M_{CO_2,CD,avg}$ is the arithmetic average charge-depleting CO₂ mass emission, g/km;
- $M_{CO_2,CD,j}$ is the CO₂ mass emission determined according to paragraph 3.2.1. of Annex 7 of phase j of the charge-depleting Type 1 test, g/km;
- d_j is the distance driven in phase j of the charge-depleting Type 1 test, km;
- j is the index number of the considered phase;
- k is the number of phases driven up to the end of the transition cycle n according to paragraph 3.2.4.4. of this annex.

4.4.4.2. Determination of the phase-specific equivalent all-electric range

The phase-specific equivalent all-electric range shall be calculated using the following equation:

$$EAER_p = \left(\frac{M_{CO_2,CS,p} - M_{CO_2,CD,avg,p}}{M_{CO_2,CS,p}} \right) \times \frac{\sum_{j=1}^k \Delta E_{REESS,j}}{EC_{DC,CD,p}}$$

where:

- EAER_p is the phase-specific equivalent all-electric range for the considered phase p, km;
- $M_{CO_2,CS,p}$ is the phase-specific CO₂ mass emission from the charge-sustaining Type 1 test for the considered phase p according to Table A8/5, step No. 7, g/km;

- $\Delta E_{\text{REESS},j}$ are the electric energy changes of all REESSs during the considered phase j , Wh;
- $EC_{\text{DC,CD},p}$ is the electric energy consumption over the considered phase p based on the REESS depletion, Wh/km;
- j is the index number of the considered phase;
- k is the number of phases driven up to the end of the transition cycle n according to paragraph 3.2.4.4 of this annex;

and

$$M_{\text{CO}_2,\text{CD,avg},p} = \frac{\sum_{c=1}^{n_c} (M_{\text{CO}_2,\text{CD},p,c} \times d_{p,c})}{\sum_{c=1}^{n_c} d_{p,c}}$$

where:

- $M_{\text{CO}_2,\text{CD,avg},p}$ is the arithmetic average charge-depleting CO_2 mass emission for the considered phase p , g/km;
- $M_{\text{CO}_2,\text{CD},p,c}$ is the CO_2 mass emission determined according to paragraph 3.2.1. of Annex 7 of phase p in cycle c of the charge-depleting Type 1 test, g/km;
- $d_{p,c}$ is the distance driven in the considered phase p of cycle c of the charge-depleting Type 1 test, km;
- c is the index number of the considered applicable WLTP test cycle;
- p is the index of the individual phase within the applicable WLTP test cycle;
- n_c is the number of applicable WLTP test cycles driven up to the end of the transition cycle n according to paragraph 3.2.4.4. of this annex;

and:

$$EC_{\text{DC,CD},p} = \frac{\sum_{c=1}^{n_c} EC_{\text{DC,CD},p,c} \times d_{p,c}}{\sum_{c=1}^{n_c} d_{p,c}}$$

where:

- $EC_{\text{DC,CD},p}$ is the electric energy consumption of the considered phase p based on the REESS depletion of the charge-depleting Type 1 test, Wh/km;
- $EC_{\text{DC,CD},p,c}$ is the electric energy consumption of the considered phase p of cycle c based on the REESS depletion of the charge-depleting Type 1 test according to paragraph 4.3. of this annex, Wh/km;
- $d_{p,c}$ is the distance driven in the considered phase p of cycle c of the charge-depleting Type 1 test, km;
- c is the index number of the considered applicable WLTP test cycle;
- p is the index of the individual phase within the applicable WLTP test cycle;

n_c is the number of applicable WLTP test cycles driven up to the end of the transition cycle n according to paragraph 3.2.4.4. of this annex.

The considered phase values shall be the low phase, medium phase, high phase, extra high phase, and the city driving cycle. In the case that the Contracting Party requests to exclude the extra high phase, this phase value shall be omitted.

4.4.5. Actual charge-depleting range for OVC-HEVs

The actual charge-depleting range shall be calculated using the following equation:

$$R_{CDA} = \sum_{c=1}^{n-1} d_c + \left(\frac{M_{CO_2,CS} - M_{CO_2,n,cycle}}{M_{CO_2,CS} - M_{CO_2,CD,avg,n-1}} \right) \times d_n$$

where:

- R_{CDA} is the actual charge-depleting range, km;
- $M_{CO_2,CS}$ is the charge-sustaining CO₂ mass emission according to Table A8/5, step No. 7, g/km;
- $M_{CO_2,n,cycle}$ is the CO₂ mass emission of the applicable WLTP test cycle n of the charge-depleting Type 1 test, g/km;
- $M_{CO_2,CD,avg,n-1}$ is the arithmetic average CO₂ mass emission of the charge-depleting Type 1 test from the beginning up to and including the applicable WLTP test cycle $(n-1)$, g/km;
- d_c is the distance driven in the applicable WLTP test cycle c of the charge-depleting Type 1 test, km;
- d_n is the distance driven in the applicable WLTP test cycle n of the charge-depleting Type 1 test, km;
- c is the index number of the considered applicable WLTP test cycle;
- n is the number of applicable WLTP test cycles driven including the transition cycle according to paragraph 3.2.4.4. of this annex;

and:

$$M_{CO_2,CD,avg,n-1} = \frac{\sum_{c=1}^{n-1} (M_{CO_2,CD,c} \times d_c)}{\sum_{c=1}^{n-1} d_c}$$

where:

- $M_{CO_2,CD,avg,n-1}$ is the arithmetic average CO₂ mass emission of the charge-depleting Type 1 test from the beginning up to and including the applicable WLTP test cycle $(n-1)$, g/km;
- $M_{CO_2,CD,c}$ is the CO₂ mass emission determined according to paragraph 3.2.1. of Annex 7 of the applicable WLTP test cycle c of the charge-depleting Type 1 test, g/km;
- d_c is the distance driven in the applicable WLTP test cycle c of the charge-depleting Type 1 test, km;

- c is the index number of the considered applicable WLTP test cycle;
- n is the number of applicable WLTP test cycles driven including the transition cycle according to paragraph 3.2.4.4. of this annex.
- 4.5. Interpolation of individual vehicle values
- 4.5.1. Interpolation range for NOVC- HEVs and OVC-HEVs
- 4.5.1.1. The interpolation method shall only be used if the difference in charge-sustaining CO₂ over the applicable cycle resulting from step 8 of Table A8/5 in Annex 8 between test vehicles L and H is between a minimum of 5 g/km and a maximum defined in paragraph 4.5.1.2. of this annex.
- 4.5.1.2. The maximum difference in charge-sustaining CO₂ allowed over the applicable cycle resulting from the calculation of the charge-sustaining CO₂ mass emission $M_{CO_2,CS}$ from step 8 in Table A8/5 of Annex 8 between test vehicles L and H shall be 20 per cent of the charge-sustaining CO₂ emissions from vehicle H plus 5 g/km, but shall be at least 15 g/km and not exceed 20 g/km. See Figure A8/3. This restriction does not apply for the application of a road load matrix family or when the calculation of the road load of vehicles L and H is based on the default road load.

Figure A8/3

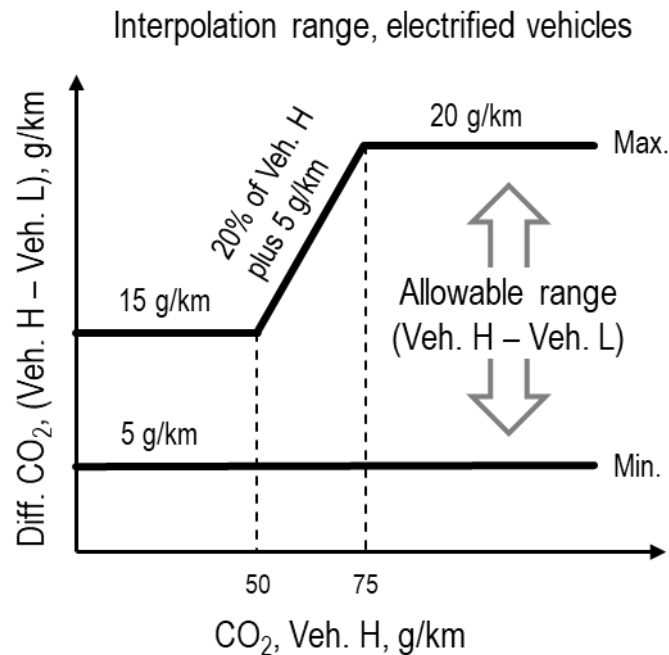
Interpolation range between vehicle H and vehicle L applied to EVs

- 4.5.1.3. The allowed interpolation range defined in paragraph 4.5.1.2. of this annex may be increased by 10 g/km charge-sustaining CO₂ if a vehicle M is tested within that family and the conditions according to paragraph 4.5.1.5. of this annex are fulfilled. This increase is allowed only once within an interpolation family. See Figure A8/4.

Figure A8/4
Interpolation range for EVs with vehicle M

Interpolation range, electrified vehicles with Veh. M

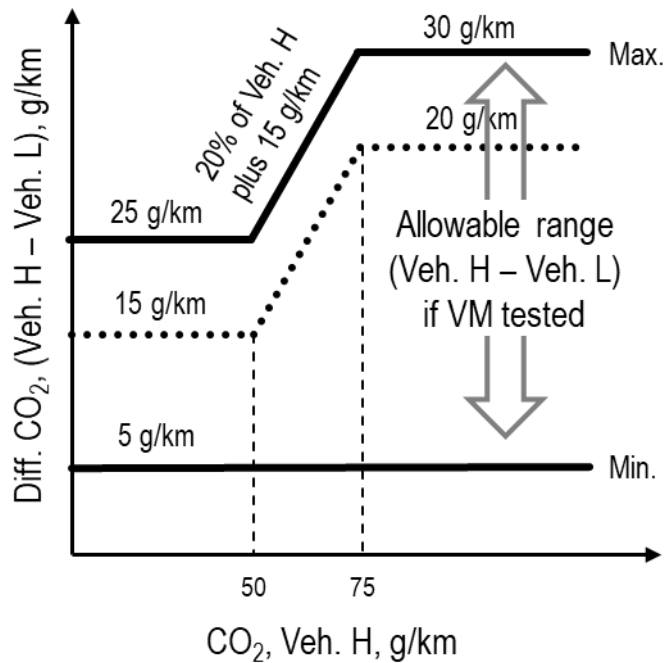

4.5.1.4. At the request of the manufacturer and with approval of the responsible authority, the application of the interpolation method on individual vehicle values within a family may be extended if the maximum extrapolation is not more than 3 g/km above the charge-sustaining CO₂ mass emission of vehicle H and/or is not more than 3 g/km below the charge-sustaining CO₂ mass emission of vehicle L. This extrapolation is valid only within the absolute boundaries of the interpolation range specified in this paragraph.

For the application of a road load matrix family, extrapolation is not permitted.

4.5.1.5. Vehicle M

Vehicle M is a vehicle within the interpolation family between vehicles L and H with a cycle energy demand which is preferably closest to the average of vehicles L and H.

The limits of the selection of vehicle M (see Figure A8/5) are such that neither the difference in CO₂ mass emission between vehicles H and M nor the difference in charge-sustaining CO₂ mass emission between vehicles M and L is higher than the allowed charge-sustaining CO₂ range according to paragraph 4.5.1.2. of this annex. The defined road load coefficients and the defined test mass shall be recorded.

Figure A8/5
Limits for the selection of vehicle M

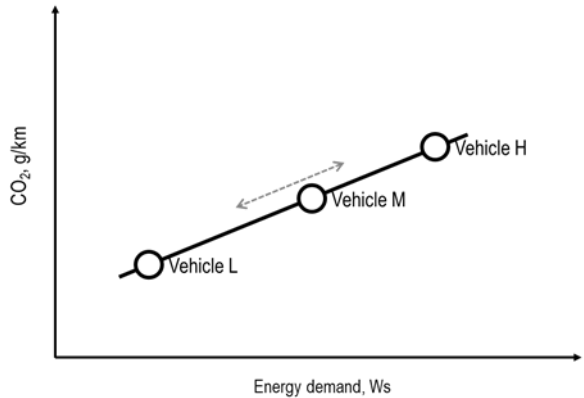

The linearity of charge-sustaining CO₂ mass emission for vehicle M shall be verified against the linearly interpolated charge-sustaining CO₂ mass emission between vehicle L and H over the applicable cycle by using the corrected measured values referring to step 6 M_{CO₂,CS,c.6} of Table A8/5 of this annex.

The linearity criterion for vehicle M shall be considered fulfilled if the charge-sustaining CO₂ mass emission of vehicle M over the applicable WLTC minus the charge-sustaining CO₂ mass emission derived by interpolation is less than 2 g/km or 3 per cent of the interpolated value, whichever value is less, but at least 1 g/km. See Figure A8/6.

Figure A8/6
Linearity criterion for vehicle M

Tolerance, Vehicle M measured vs. calculated

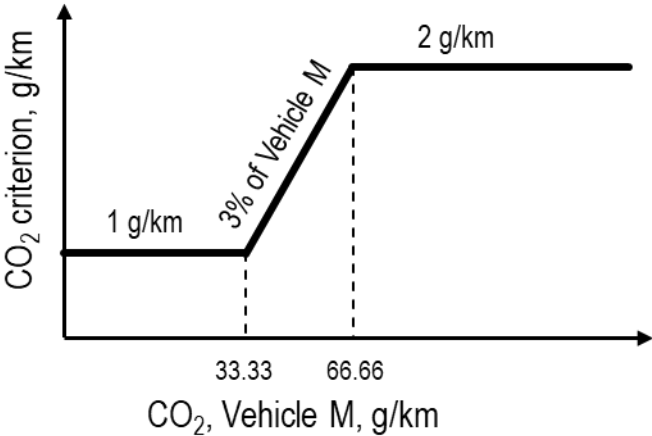

If the linearity criterion is fulfilled, the interpolation method shall be applicable for all individual vehicle values between vehicles L and H within the interpolation family.

If the linearity criterion is not fulfilled, the interpolation family shall be split into two sub-families for vehicles with a cycle energy demand between vehicles L and M, and vehicles with a cycle energy demand between vehicles M and H. In such a case, the final values of e.g. the charge-sustaining CO₂

mass emissions of vehicle M shall be determined according to the same process as for vehicles L or H. See Table A8/5, Table A8/6, Table A8/8 and Table A8/9 of Annex 8.

For vehicles with a cycle energy demand between that of vehicles L and M, each parameter of vehicle H necessary for the application of the interpolation method on individual OVC-HEV and NOVC-HEV values, shall be substituted by the corresponding parameter of vehicle M.

For vehicles with a cycle energy demand between that of vehicles M and H, each parameter of vehicle L that is necessary for the application of the interpolation method on individual OVC-HEV and NOVC-HEV values shall be substituted by the corresponding parameter of vehicle M.

4.5.2. Calculation of energy demand per period

The energy demand $E_{k,p}$ and distance driven $d_{c,p}$ per period p applicable for individual vehicles in the interpolation family shall be calculated according to the procedure in paragraph 5. of Annex 7, for the sets k of road load coefficients and masses according to paragraph 3.2.3.2.3. of Annex 7.

4.5.3. Calculation of the interpolation coefficient for individual vehicles $K_{ind,p}$

The interpolation coefficient $K_{ind,p}$ per period shall be calculated for each considered period p using the following equation:

$$K_{ind,p} = \frac{E_{3,p} - E_{1,p}}{E_{2,p} - E_{1,p}}$$

where:

$K_{ind,p}$ is the interpolation coefficient for the considered individual vehicle for period p ;

$E_{1,p}$ is the energy demand for the considered period for vehicle L according to paragraph 5. of Annex 7, Ws;

$E_{2,p}$ is the energy demand for the considered period for vehicle H according to paragraph 5. of Annex 7, Ws;

$E_{3,p}$ is the energy demand for the considered period for the individual vehicle according to paragraph 5. of Annex 7, Ws;

p is the index of the individual period within the applicable test cycle.

In the case that the considered period p is the applicable WLTP test cycle, $K_{ind,p}$ is named K_{ind} .

4.5.4. Interpolation of the CO₂ mass emission for individual vehicles

4.5.4.1. Individual charge-sustaining CO₂ mass emission for OVC-HEVs and NOVC-HEVs

The charge-sustaining CO₂ mass emission for an individual vehicle shall be calculated using the following equation:

$$M_{CO_2-ind,CS,p} = M_{CO_2-L,CS,p} + K_{ind,p} \times (M_{CO_2-H,CS,p} - M_{CO_2-L,CS,p})$$

where:

- $M_{CO_2-ind,CS,p}$ is the charge-sustaining CO₂ mass emission for an individual vehicle of the considered period p according to Table A8/5, step No. 9, g/km;
- $M_{CO_2-L,CS,p}$ is the charge-sustaining CO₂ mass emission for vehicle L of the considered period p according to Table A8/5, step No. 8, g/km;
- $M_{CO_2-H,CS,p}$ is the charge-sustaining CO₂ mass emission for vehicle H of the considered period p according to Table A8/5, step No. 8, g/km;
- $K_{ind,p}$ is the interpolation coefficient for the considered individual vehicle for period p;
- p is the index of the individual period within the applicable WLTP test cycle.

The considered periods shall be the low phase, medium phase, high phase, extra high phase and the applicable WLTP test cycle. In the case that the Contracting Party requests to exclude the extra high phase, this phase value shall be omitted.

4.5.4.2. Individual utility factor-weighted charge-depleting CO₂ mass emission for OVC-HEVs

The utility factor-weighted charge-depleting CO₂ mass emission for an individual vehicle shall be calculated using the following equation:

$$M_{CO_2-ind,CD} = M_{CO_2-L,CD} + K_{ind} \times (M_{CO_2-H,CD} - M_{CO_2-L,CD})$$

where:

- $M_{CO_2-ind,CD}$ is the utility factor-weighted charge-depleting CO₂ mass emission for an individual vehicle, g/km;
- $M_{CO_2-L,CD}$ is the utility factor-weighted charge-depleting CO₂ mass emission for vehicle L, g/km;
- $M_{CO_2-H,CD}$ is the utility factor-weighted charge-depleting CO₂ mass emission for vehicle H, g/km;
- K_{ind} is the interpolation coefficient for the considered individual vehicle for the applicable WLTP test cycle.

4.5.4.3. Individual utility factor-weighted CO₂ mass emission for OVC-HEVs

The utility factor-weighted CO₂ mass emission for an individual vehicle shall be calculated using the following equation:

$$M_{CO_2-ind,weighted} = M_{CO_2-L,weighted} + K_{ind} \times (M_{CO_2-H,weighted} - M_{CO_2-L,weighted})$$

where:

- $M_{CO_2-ind,weighted}$ is the utility factor-weighted CO₂ mass emission for an individual vehicle, g/km;
- $M_{CO_2-L,weighted}$ is the utility factor-weighted CO₂ mass emission for vehicle L, g/km;
- $M_{CO_2-H,weighted}$ is the utility factor-weighted CO₂ mass emission for vehicle H, g/km;
- K_{ind} is the interpolation coefficient for the considered individual vehicle for the applicable WLTP test cycle.

4.5.5. Interpolation of the fuel consumption for individual vehicles

4.5.5.1. Individual charge-sustaining fuel consumption for OVC-HEVs and NOVC-HEVs

The charge-sustaining fuel consumption for an individual vehicle shall be calculated using the following equation:

$$FC_{ind,CS,p} = FC_{L,CS,p} + K_{ind,p} \times (FC_{H,CS,p} - FC_{L,CS,p})$$

where:

$FC_{ind,CS,p}$ is the charge-sustaining fuel consumption for an individual vehicle of the considered period p according to Table A8/6, step No. 3, l/100 km;

$FC_{L,CS,p}$ is the charge-sustaining fuel consumption for vehicle L of the considered period p according to Table A8/6, step No. 2, l/100 km;

$FC_{H,CS,p}$ is the charge-sustaining fuel consumption for vehicle H of the considered period p according to Table A8/6, step No. 2, l/100 km;

$K_{ind,p}$ is the interpolation coefficient for the considered individual vehicle for period p ;

p is the index of the individual period within the applicable WLTP test cycle.

The considered periods shall be the low phase, medium phase, high phase, extra high phase, and the applicable WLTP test cycle. In the case that the Contracting Party requests to exclude the extra high phase, this phase value shall be omitted.

4.5.5.2. Individual utility factor-weighted charge depleting fuel consumption for OVC-HEVs

The utility factor-weighted charge-depleting fuel consumption for an individual vehicle shall be calculated using the following equation:

$$FC_{ind,CD} = FC_{L,CD} + K_{ind} \times (FC_{H,CD} - FC_{L,CD})$$

where:

$FC_{ind,CD}$ is the utility factor-weighted charge-depleting fuel consumption for an individual vehicle, l/100 km;

$FC_{L,CD}$ is the utility factor-weighted charge-depleting fuel consumption for vehicle L , l/100 km;

$FC_{H,CD}$ is the utility factor-weighted charge-depleting fuel consumption for vehicle H , l/100 km;

K_{ind} is the interpolation coefficient for the considered individual vehicle for the applicable WLTP test cycle.

4.5.5.3. Individual utility factor-weighted fuel consumption for OVC-HEVs

The utility factor-weighted fuel consumption for an individual vehicle shall be calculated using the following equation:

$$FC_{ind,weighted} = FC_{L,weighted} + K_{ind} \times (FC_{H,weighted} - FC_{L,weighted})$$

where:

$FC_{ind,weighted}$ is the utility factor-weighted fuel consumption for an individual vehicle, l/100 km;

$FC_{L,weighted}$ is the utility factor-weighted fuel consumption for vehicle L, l/100 km;

$FC_{H,weighted}$ is the utility factor-weighted fuel consumption for vehicle H, l/100 km;

K_{ind} is the interpolation coefficient for the considered individual vehicle for the applicable WLTP test cycle.

4.5.6. Interpolation of electric energy consumption for individual vehicles

4.5.6.1. Individual utility factor-weighted charge-depleting electric energy consumption based on the recharged electric energy from the mains for OVC-HEVs

The utility factor-weighted charge-depleting electric energy consumption based on the recharged electric energy from for an individual vehicle shall be calculated using the following equation:

$$EC_{AC-ind,CD} = EC_{AC-L,CD} + K_{ind} \times (EC_{AC-H,CD} - EC_{AC-L,CD})$$

where:

$EC_{AC-ind,CD}$ is the utility factor-weighted charge-depleting electric energy consumption based on the recharged electric energy from the mains for an individual vehicle, Wh/km;

$EC_{AC-L,CD}$ is the utility factor-weighted charge-depleting electric energy consumption based on the recharged electric energy from the mains for vehicle L, Wh/km;

$EC_{AC-H,CD}$ is the utility factor-weighted charge-depleting electric energy consumption based on the recharged electric energy from the mains for vehicle H, Wh/km;

K_{ind} is the interpolation coefficient for the considered individual vehicle for the applicable WLTP test cycle.

4.5.6.2. Individual utility factor-weighted electric energy consumption based on the recharged electric energy from the mains for OVC-HEVs

The utility factor-weighted electric energy consumption based on the recharged electric energy from the mains for an individual vehicle shall be calculated using the following equation:

$$EC_{AC-ind,weighted} = EC_{AC-L,weighted} + K_{ind} \times (EC_{AC-H,weighted} - EC_{AC-L,weighted})$$

where:

$EC_{AC-ind,weighted}$ is the utility factor weighted electric energy consumption based on the recharged electric energy from the mains for an individual vehicle, Wh/km;

$EC_{AC-L,weighted}$ is the utility factor weighted electric energy consumption based on the recharged electric energy from the mains for vehicle L, Wh/km;

$EC_{AC-H,weighted}$ is the utility factor weighted electric energy consumption based on the recharged electric energy from the mains for vehicle H, Wh/km;

K_{ind} is the interpolation coefficient for the considered individual vehicle for the applicable WLTP test cycle.

4.5.6.3. Individual electric energy consumption for OVC-HEVs and PEVs

The electric energy consumption for an individual vehicle according to paragraph 4.3.3. of this annex in the case of OVC-HEVs and according to paragraph 4.3.4. of this annex in the case of PEVs shall be calculated using the following equation:

$$EC_{ind,p} = EC_{L,p} + K_{ind,p} \times (EC_{H,p} - EC_{L,p})$$

where:

$EC_{ind,p}$ is the electric energy consumption for an individual vehicle for the considered period p, Wh/km;

$EC_{L,p}$ is the electric energy consumption for vehicle L for the considered period p, Wh/km;

$EC_{H,p}$ is the electric energy consumption for vehicle H for the considered period p, Wh/km;

$K_{ind,p}$ is the interpolation coefficient for the considered individual vehicle for period p;

p is the index of the individual period within the applicable test cycle.

The considered periods shall be the low phase, medium phase, high phase, extra high phase, the applicable WLTP city test cycle and the applicable WLTP test cycle. In the case that the Contracting Party requests to exclude the extra high phase, this phase value shall be omitted.

4.5.7. Interpolation of electric ranges for individual vehicles

4.5.7.1. Individual all-electric range for OVC-HEVs

If the following criterion

$$\left| \frac{AER_L}{R_{CDA,L}} - \frac{AER_H}{R_{CDA,H}} \right| \leq 0.1$$

where:

AER_L is the all-electric range of vehicle L for the applicable WLTP test cycle, km;

AER_H is the all-electric range of vehicle H for the applicable WLTP test cycle, km;

$R_{CDA,L}$ is the actual charge-depleting range of vehicle L, km;

$R_{CDA,H}$ is the actual charge-depleting range of vehicle H, km;

is fulfilled, the all-electric range for an individual vehicle shall be calculated using the following equation:

$$AER_{ind,p} = AER_{L,p} + K_{ind,p} \times (AER_{H,p} - AER_{L,p})$$

where:

- $AER_{ind,p}$ is the all-electric range for an individual vehicle for the considered period p, km;
- $AER_{L,p}$ is the all-electric range for vehicle L for the considered period p, km;
- $AER_{H,p}$ is the all-electric range for vehicle H for the considered period p, km;
- $K_{ind,p}$ is the interpolation coefficient for the considered individual vehicle for period p;
- p is the index of the individual period within the applicable test cycle.

The considered periods shall be the applicable WLTP city test cycle and the applicable WLTP test cycle. In the case that the Contracting Party requests to exclude the extra high phase, this phase value shall be omitted.

If the criterion defined in this paragraph is not fulfilled, the AER determined for vehicle H is applicable to all vehicles within the interpolation family.

4.5.7.2. Individual pure electric range for PEVs

The pure electric range for an individual vehicle shall be calculated using the following equation:

$$PER_{ind,p} = PER_{L,p} + K_{ind,p} \times (PER_{H,p} - PER_{L,p})$$

where:

- $PER_{ind,p}$ is the pure electric range for an individual vehicle for the considered period p, km;
- $PER_{L,p}$ is the pure electric range for vehicle L for the considered period p, km;
- $PER_{H,p}$ is the pure electric range for vehicle H for the considered period p, km;
- $K_{ind,p}$ is the interpolation coefficient for the considered individual vehicle for period p;
- p is the index of the individual period within the applicable test cycle.

The considered periods shall be the low phase, medium phase, high phase, extra high phase, the applicable WLTP city test cycle and the applicable WLTP test cycle. In the case that the Contracting Party requests to exclude the extra high phase, this phase value shall be omitted.

4.5.7.3. Individual equivalent all-electric range for OVC-HEVs

The equivalent all-electric range for an individual vehicle shall be calculated using the following equation:

$$EAER_{ind,p} = EAER_{L,p} + K_{ind,p} \times (EAER_{H,p} - EAER_{L,p})$$

where:

| | |
|----------------|---|
| $EAER_{ind,p}$ | is the equivalent all-electric range for an individual vehicle for the considered period p, km; |
| $EAER_{L,p}$ | is the equivalent all-electric range for vehicle L for the considered period p, km; |
| $EAER_{H,p}$ | is the equivalent all-electric range for vehicle H for the considered period p, km; |
| $K_{ind,p}$ | is the interpolation coefficient for the considered individual vehicle for period p; |
| p | is the index of the individual period within the applicable test cycle. |

The considered periods shall be the low phase, medium phase, high phase, extra high phase, the applicable WLTP city test cycle and the applicable WLTP test cycle. In the case that the Contracting Party requests to exclude the extra high phase, this phase value shall be omitted.

4.6. Stepwise procedure for calculating the final test results of OVC-HEVs

In addition to the stepwise procedure for calculating the final charge-sustaining test results for gaseous emission compounds according to paragraph 4.1.1.1. of this annex and for fuel consumption according to paragraph 4.2.1.1. of this annex, paragraphs 4.6.1. and 4.6.2. of this annex describe the stepwise calculation of the final charge-depleting as well as the final charge-sustaining and charge-depleting weighted test results.

4.6.1. Stepwise procedure for calculating the final test results of the charge-depleting Type 1 test for OVC-HEVs

The results shall be calculated in the order described in Table A8/8. All applicable results in the column "Output" shall be recorded. The column "Process" describes the paragraphs to be used for calculation or contains additional calculations.

For the purpose of Table A8/8, the following nomenclature within the equations and results is used:

| | |
|-----------------|---|
| c | complete applicable test cycle; |
| p | every applicable cycle phase; |
| i | applicable criteria emission component; |
| CS | charge-sustaining; |
| CO ₂ | CO ₂ mass emission. |

Table A8/8

Calculation of final charge-depleting values

| <i>Source</i> | <i>Input</i> | <i>Process</i> | <i>Output</i> | <i>Step no.</i> |
|---------------|-------------------------------|--|---|-----------------|
| Annex 8 | Charge-depleting test results | <p>Results measured according to Appendix 3 to this annex, pre-calculated according to paragraph 4.3. of this annex.</p> <p>Usable battery energy according to paragraph 4.4.1.2.2. of this annex.</p> <p>Recharged electric energy according to paragraph 3.2.4.6. of this annex.</p> <p>Cycle energy according to paragraph 5. of Annex 7.</p> <p>CO₂ mass emission according to paragraph 3.2.1. of Annex 7.</p> <p>Mass of gaseous emission compound i according to paragraph 3.2.1. of Annex 7.</p> <p>Particle number emissions (if applicable) according to paragraph 4. of Annex 7.</p> <p>Particulate matter emissions according to paragraph 3.3. of Annex 7.</p> <p>All-electric range determined according to paragraph 4.4.1.1. of this annex.</p> <p>In the case that the applicable WLTC city test cycle was driven: all- electric range city according to paragraph 4.4.1.2.1. of this annex.</p> <p>CO₂ mass emission K_{CO2} correction coefficient might be necessary according to Appendix 2 to this annex.</p> <p>Output is available for each test.</p> <p>In the case that the interpolation method is applied, the output (except of K_{CO2}) is available for vehicle H, L and, if applicable, M.</p> | <p>$\Delta E_{REESS,j}$, Wh; d_j, km;</p> <p>UBE_{city}, Wh;</p> <p>E_{AC}, Wh;</p> <p>E_{cycle}, Ws;</p> <p>M_{CO2,CD,j}, g/km;</p> <p>M_{i,CD,j}, g/km;</p> <p>PN_{CD,j}, particles per kilometer;</p> <p>PM_{CD,c}, mg/km;</p> <p>AER, km;</p> <p>AER_{city}, km.</p> <p>K_{CO2}, (g/km)/(Wh/km).</p> | 1 |

| <i>Source</i> | <i>Input</i> | <i>Process</i> | <i>Output</i> | <i>Step no.</i> |
|---------------|--|--|--|-----------------|
| Output step 1 | $\Delta E_{REESS,j}$, Wh; E_{cycle} , Ws. | Calculation of relative electric energy change for each cycle according to paragraph 3.2.4.5.2. of this annex. Output is available for each test and each applicable WLTP test cycle. In the case that the interpolation method is applied, the output is available for vehicle H, L and, if applicable, M. | REEC _i . | 2 |
| Output step 2 | REEC _i . | Determination of the transition and confirmation cycle according to paragraph 3.2.4.4. of this annex. In the case that more than one charge-depleting test is available for one vehicle, for the purpose of averaging, each test shall have the same transition cycle number n_{veh} . Determination of the charge-depleting cycle range according to paragraph 4.4.3. of this annex. Output is available for each test. In the case that the interpolation method is applied, the output is available for vehicle H, L and, if applicable, M. | n_{veh} ; R _{CDC} ; km. | 3 |
| Output step 3 | n_{veh} ; | In the case that the interpolation method is used, the transition cycle shall be determined for vehicle H, L and, if applicable, M. Check whether the interpolation criterion according to paragraph 5.6.2. (d) of this UN GTR is fulfilled. | $n_{veh,L}$; $n_{veh,H}$; if applicable $n_{veh,M}$. | 4 |
| Output step 1 | $M_{i,CD,j}$, g/km; $PM_{CD,e}$, mg/km; $PN_{CD,j}$, particles per kilometer. | Calculation of combined values for emissions for n_{veh} cycles; in the case of interpolation for $n_{veh,L}$ cycles for each vehicle. Output is available for each test. In the case that the interpolation method is applied, the output is available for vehicle H, L and, if applicable, M. | $M_{i,CD,e}$, g/km; $PM_{CD,e}$, mg/km; $PN_{CD,e}$, particles per kilometer. | 5 |

| <i>Source</i> | <i>Input</i> | <i>Process</i> | <i>Output</i> | <i>Step no.</i> |
|--|---|--|--|-----------------|
| Output step 5 | $M_{i,CD,c}$, g/km; $PM_{CD,c}$, mg/km; $PN_{CD,c}$, particles per kilometer. | Emission averaging of tests for each applicable WLTP test cycle within the charge-depleting Type 1 test and check with the limits according to Table A6/2 of Annex 6. | $M_{i,CD,c,ave}$, g/km; $PM_{CD,c,ave}$, mg/km; $PN_{CD,c,ave}$, particles per kilometer. | 6 |
| Output step 1 | $\Delta E_{REESS,j}$, Wh; d_j , km; UBE_{city} , Wh. | In the case that AER_{city} is derived from the Type 1 test by driving the applicable WLTP test cycles, the value shall be calculated according to paragraph 4.4.1.2.2. of this annex. In the case of more than one test, $n_{city,pe}$ shall be equal for each test. Output available for each test. Averaging of AER_{city} . In the case that the interpolation method is applied, the output is available for vehicle H, L and, if applicable, M. | AER_{city} , km; $AER_{city,ave}$, km. | 7 |
| Output step 1 Output step 3 Output step 4 | d_j , km; n_{veh} ; $n_{veh,L}$; | Phase-specific and cycle-specific UF calculation. Output is available for each test. In the case that the interpolation method is applied, the output is available for vehicle H, L and, if applicable, M. | $UF_{phase,j}$; $UF_{cycle,c}$. | 8 |
| Output step 1 Output step 3 Output step 4 Output step 8 | $\Delta E_{REESS,j}$, Wh; d_j , km; E_{AC} , Wh; n_{veh} ; $n_{veh,L}$; $UF_{phase,j}$; | Calculation of the electric energy consumption based on the recharged energy according to paragraphs 4.3.1. and 4.3.2. of this annex. In the case of interpolation, $n_{veh,L}$ cycles shall be used. Therefore, due to the required correction of the CO ₂ mass emission, the electric energy consumption of the confirmation cycle and its phases shall be set to zero. Output is available for each test. In the case that the interpolation method is applied, the output is available for vehicle H, L and, if applicable, M. | $EC_{AC,weighted}$, Wh/km; $EC_{AC,CD}$, Wh/km; | 9 |

| <i>Source</i> | <i>Input</i> | <i>Process</i> | <i>Output</i> | <i>Step no.</i> |
|--|---|---|--|-----------------|
| Output step 1 Output step 3 Output step 4 Output step 8 | $M_{CO_2,CD,j}$, g/km; K_{CO_2} , (g/km)/(Wh/km); $\Delta E_{REESS,j}$, Wh; d_j , km; n_{veh} ; $n_{veh,L}$; $UF_{phase,j}$. | Calculation of the charge-depleting CO ₂ mass emission according to paragraph 4.1.2. of this annex. In the case that the interpolation method is applied, $n_{veh,L}$ cycles shall be used. With reference to paragraph 4.1.2. of this annex, the confirmation cycle shall be corrected according to Appendix 2 to this annex. Output is available for each test. In the case that the interpolation method is applied, the output is available for vehicle H, L and, if applicable, M. | $M_{CO_2,CD}$, g/km; | 10 |
| Output step 1 Output step 3 Output step 4 Output step 8 | $M_{CO_2,CD,j}$, g/km; $M_{i,CD,j}$, g/km; K_{CO_2} , (g/km)/(Wh/km). n_{veh} ; $n_{veh,L}$; $UF_{phase,j}$; | Calculation of the charge-depleting fuel consumption according to paragraph 4.2.2. of this annex. In the case that the interpolation method is applied, $n_{veh,L}$ cycles shall be used. With reference to paragraph 4.1.2. of this annex, $M_{CO_2,CD,j}$ of the confirmation cycle shall be corrected according to Appendix 2 to this annex. The phase-specific fuel consumption $FC_{CD,j}$ shall be calculated using the corrected CO ₂ mass emission according to paragraph 6. of Annex 7. Output is available for each test. In the case that the interpolation method is applied, the output is available for vehicle H, L and, if applicable, M. | $FC_{CD,j}$, l/100 km; FC_{CD} , l/100 km. | 11 |
| Output step 1 | $\Delta E_{REESS,j}$, Wh; d_j , km; | Regional option: Calculation of the electric energy consumption from the first applicable WLTP test cycle. Output is available for each test. In the case that the interpolation method is applied, the output is available for vehicle H, L and, if applicable, M. | $EC_{DC,CD,first}$, Wh/km | 12 |

| <i>Source</i> | <i>Input</i> | <i>Process</i> | <i>Output</i> | <i>Step no.</i> |
|---|---|---|--|-----------------|
| Output step 9 Output step 10 Output step 11 Output step 12 | EC _{AC,weighted} , Wh/km; EC _{AC,CD} , Wh/km; M _{CO2,CD} , g/km; FC _{CD} , l/100 km; EC _{DC,CD,first} , Wh/km. | Averaging of tests for each vehicle. In the case that the interpolation method is applied, the output is available for each vehicle H, L and, if applicable, M. | EC _{AC,weighted,ave} , Wh/km; EC _{AC,CD,ave} , Wh/km; M _{CO2,CD,ave} , g/km; FC _{CD,ave} , l/100 km; EC _{DC,CD,first,ave} , Wh/km | 13 |
| Output step 13 | EC _{AC,CD,ave} , Wh/km; M _{CO2,CD,ave} , g/km. | Declaration of charge-depleting electric energy consumption and CO ₂ mass emission for each vehicle. In the case that the interpolation method is applied, the output is available for each vehicle H, L and, if applicable, M. | EC _{AC,CD,dec} , Wh/km; M _{CO2,CD,dec} , g/km. | 14 |
| Output step 12 Output step 13 Output step 14 | EC _{DC,CD,first} , Wh/km; EC _{AC,CD,ave} , Wh/km; EC _{AC,CD,dec} , Wh/km; | Regional option: Adjustment of electric energy consumption for the purpose of COP. In the case that the interpolation method is applied, the output is available for each vehicle H, L and, if applicable, M. | EC _{DC,CD,COP} , Wh/km; | 15 |

| <i>Source</i> | <i>Input</i> | <i>Process</i> | <i>Output</i> | <i>Step no.</i> |
|--|--|--|---|--|
| Output step 15 Output step 14 Output step 13 | EC _{DC,CD,COP} , Wh/km; EC _{AC,CD,dec} , Wh/km; M _{CO2,CD,dec} , g/km; EC _{AC,weighted,ave} , Wh/km; FC _{CD,ave} , l/100 km; | <p>In the case that the interpolation method is applied, intermediate rounding shall be performed according to paragraph 7. of this UN GTR.</p> <p>M_{CO2,CD} shall be rounded to the second place of decimal.</p> <p>EC_{AC,CD} and EC_{AC,weighted} shall be rounded to the first place of decimal.</p> <p>Regional option: EC_{DC,CD,COP} shall be rounded to the first place of decimal. FC_{CD} shall be rounded to the third place of decimal.</p> <p>Output is available for vehicles H and for vehicle L and, if applicable, for vehicle M.</p> <p>In case that the interpolation method is not applied, final rounding shall be applied according to paragraph 7. of this UN GTR.</p> <p>EC_{AC,CD}, EC_{AC,weighted} and M_{CO2,CD} shall be rounded to the nearest whole number.</p> <p>Regional option: EC_{DC,CD,COP} shall be rounded to the nearest whole number. FC_{CD} shall be rounded to the first place of decimal.</p> | EC _{DC,CD,COP,final} , Wh/km; EC _{AC,CD,final} , Wh/km; M _{CO2,CD,final} , g/km; EC _{AC,weighted,final} , Wh/km; FC _{CD,final} , l/100 km; | 16 Interpolation family result. If the interpolation method is not applied, step No. 17 is not required and the output of this step is the final result. |

| <i>Source</i> | <i>Input</i> | <i>Process</i> | <i>Output</i> | <i>Step no.</i> |
|----------------|---|---|---|--|
| Output step 16 | $EC_{DC,CD,COP,final}$, Wh/km; $EC_{AC,CD,final}$, Wh/km; $M_{CO_2,CD,final}$, g/km; $EC_{AC,weighted,final}$, Wh/km; $FC_{CD,final}$, l/100 km; | <p>Interpolation of individual values based on input from vehicles H and L and, if applicable, vehicle M.</p> <p>Final rounding of individual vehicle values shall be performed according to paragraph 7. of this UN GTR.</p> <p>$EC_{AC,CD}$, $EC_{AC,weighted}$ and $M_{CO_2,CD}$ shall be rounded to the nearest whole number.</p> <p>Regional option: $EC_{DC,CD,COP}$ shall be rounded to the nearest whole number. FC_{CD} shall be rounded to the first place of decimal.</p> <p>Output is available for each individual vehicle.</p> | $EC_{DC,CD,COP,ind}$, Wh/km; $EC_{AC,CD,ind}$, Wh/km; $M_{CO_2,CD,ind}$, g/km; $EC_{AC,weighted,ind}$, Wh/km; $FC_{CD,ind}$, l/100 km; | 17 Result of an individual vehicle. Final test result. |

4.6.2. Stepwise procedure for calculating the final charge-sustaining and charge-depleting weighted test results of the Type 1 test

The results shall be calculated in the order described in Table A8/9. All applicable results in the column "Output" shall be recorded. The column "Process" describes the paragraphs to be used for calculation or contains additional calculations.

For the purpose of this table, the following nomenclature within the equations and results is used:

- c considered period is the complete applicable test cycle;
- p considered period is the applicable cycle phase;
- i applicable criteria emission component (except for CO₂);
- j index for the considered period;
- CS charge-sustaining;
- CD charge-depleting;
- CO₂ CO₂ mass emission;
- REESS Rechargeable Electric Energy Storage System.

Table A8/9

Calculation of final charge-depleting and charge-sustaining weighted values

| <i>Source</i> | <i>Input</i> | <i>Process</i> | <i>Output</i> | <i>Step no.</i> |
|------------------------------|---|--|---|-----------------|
| Output step 1, Table A8/8 | $M_{i,CD,j}$, g/km; $PN_{CD,j}$, particles per kilometer; $PM_{CD,c}$, mg/km; $M_{CO_2,CD,j}$, g/km; $\Delta E_{REESS,j}$, Wh; d_j , km; AER, km; E_{AC} , Wh; | Input from CD and CS postprocessing. | $M_{i,CD,j}$, g/km; $PN_{CD,j}$, particles per kilometer; $PM_{CD,c}$, mg/km; $M_{CO_2,CD,j}$, g/km; $\Delta E_{REESS,j}$, Wh; d_j , km; AER, km; E_{AC} , Wh; $AER_{city,ave}$, km; | 1 |
| Output step 7, Table A8/8 | $AER_{city,ave}$, km; | | n_{veh} ; R_{CDC} , km; | |
| Output step 3, Table A8/8 | n_{veh} ; R_{CDC} , km; | | $n_{veh,L}$; $n_{veh,H}$; $UF_{phase,j}$; $UF_{cycle,c}$; | |
| Output step 4, Table A8/8 | $n_{veh,L}$; $n_{veh,H}$; | | $M_{i,CS,c,6}$, g/km; $M_{CO_2,CS}$, g/km; | |
| Output step 8, Table A8/8 | $UF_{phase,j}$; $UF_{cycle,c}$; | | | |
| Output step 6, Table A8/5 | $M_{i,CS,c,6}$, g/km; | | | |
| Output step 7, Table A8/5 | $M_{CO_2,CS}$, g/km; | | | |
| | | Output in the case of CD is available for each CD test. Output in the case of CS is available once due to CS test averaged values. | | |
| | | In the case that the interpolation method is applied, the output (except of K_{CO_2}) is available for vehicle H, L and, if applicable, M. | | |
| | K_{CO_2} , (g/km)/(Wh/km). | CO_2 mass emission correction coefficient K_{CO_2} might be necessary according to Appendix 2 to this annex. | K_{CO_2} , (g/km)/(Wh/km). | |

| <i>Source</i> | <i>Input</i> | <i>Process</i> | <i>Output</i> | <i>Step no.</i> |
|--------------------------------|--|---|--|-----------------|
| Output step 1, | $M_{i,CD,j}$, g/km; $PN_{CD,j}$, particles per kilometer; $PM_{CD,c}$, mg/km; n_{veh} ; $n_{veh,L}$; $UF_{phase,j}$; $UF_{cycle,c}$; $M_{i,CS,c,6}$, g/km; | <p>Calculation of weighted emission (except $M_{CO_2,weighted}$) compounds according to paragraphs 4.1.3.1. to 4.1.3.3. inclusive of this annex.</p> <p>Remark: $M_{i,CS,c,6}$ includes $PN_{CS,c}$ and $PM_{CS,c}$.</p> <p>Output is available for each CD test.</p> <p>In the case that the interpolation method is applied, the output is available for each vehicle L, H and, if applicable, M.</p> | $M_{i,weighted}$, g/km; $PN_{weighted}$, particles per kilometer; $PM_{weighted}$, mg/km; | 2 |
| Output step 1, | $M_{CO_2,CD,j}$, g/km; $\Delta E_{REESS,j}$, Wh; d_j , km; n_{veh} ; R_{CDC} , km $M_{CO_2,CS}$, g/km; | <p>Calculation of equivalent all-electric range according to paragraphs 4.4.4.1. and 4.4.4.2. of this annex, and actual charge-depleting range according to paragraph 4.4.5. of this annex.</p> <p>Output is available for each CD test.</p> <p>R_{CDA} shall be rounded according to paragraph 7. of this UN GTR to the nearest whole number.</p> <p>In the case that the interpolation method is applied, the output is available for each vehicle L, H and, if applicable, M.</p> | EAER, km; EAER _p , km; R _{CDA} , km. | 3 |
| Output step 1 Output step 3 | AER, km; R _{CDA} , km. | <p>Output is available for each CD test.</p> <p>In the case that the interpolation method is applied, check the availability of AER interpolation between vehicle H, L and, if applicable, M according to paragraph 4.5.7.1. of this annex.</p> <p>If the interpolation method is used, each test shall fulfil the requirement.</p> | AER-interpolation availability. | 4 |

| <i>Source</i> | <i>Input</i> | <i>Process</i> | <i>Output</i> | <i>Step no.</i> |
|---------------|---|---|--|---|
| Output step 1 | AER, km. | <p>Averaging AER and AER declaration.</p> <p>The declared AER shall be rounded according to paragraph 7. of this UN GTR to the number of decimal places specified in Table A6/1 of Annex 6.</p> <p>In the case that the interpolation method is applied and the AER interpolation availability criterion is fulfilled, AER shall be rounded according to paragraph 7. of this UN GTR to the first place of decimal.</p> <p>The output is available for each vehicles H and L and, if applicable, for vehicle M.</p> <p>If the case that the interpolation method is applied but the criterion is not fulfilled, AER of vehicle H shall be applied for the whole interpolation family and shall be rounded according to paragraph 7. of this UN GTR to the nearest whole number.</p> <p>In the case that the interpolation method is not applied, AER shall be rounded according to paragraph 7. of this UN GTR to the nearest whole number.</p> | AER _{ave} , km; AER _{dec} , km. | <p>5</p> <p>Interpolation family result.</p> <p>If the interpolation method is not applied, step No. 9 is not required and the output of this step is the final result.</p> |
| Output step 1 | M _{i,CD,j} , g/km; M _{CO₂,CD,j} , g/km; n _{veh} ; n _{veh,L} ; UF _{phase,j} ; M _{i,CS,c,6} , g/km; M _{CO₂,CS} , g/km. | <p>Calculation of weighted CO₂ mass emission and fuel consumption according to paragraphs 4.1.3.1. and 4.2.3. of this annex.</p> <p>Output is available for each CD test.</p> <p>In the case that the interpolation method is applied, n_{veh,L} cycles shall be used. With reference to paragraph 4.1.2. of this annex, M_{CO₂,CD,j} of the confirmation cycle shall be corrected according to Appendix 2 to this annex.</p> <p>In the case that the interpolation method is applied, the output is available for each vehicle H, vehicle LH and, if applicable, vehicle M.</p> | M _{CO₂,weighted} , g/km; FC _{weighted} , l/100 km; | 6 |

| <i>Source</i> | <i>Input</i> | <i>Process</i> | <i>Output</i> | <i>Step no.</i> |
|--------------------------------|---|--|--|-----------------|
| Output step 1 Output step 3 | E _{AC} , Wh; EAER, km; EAER _p , km; | Calculation of the electric energy consumption based in EAER according to paragraphs 4.3.3.1. and 4.3.3.2. of this annex. Output is available for each CD test. In the case that the interpolation method is applied, the output is available for each vehicle H, vehicle L and, if applicable, vehicle M. | EC, Wh/km; EC _p , Wh/km; | 7 |

| <i>Source</i> | <i>Input</i> | <i>Process</i> | <i>Output</i> | <i>Step no.</i> |
|--|---|--|--|--|
| Output step 1 Output step 6 Output step 7 Output step 3 | AER _{city, ave} , km; M _{CO₂, weighted} , g/km; FC _{weighted} , l/100 km; EC, Wh/km; EC _p , Wh/km; EAER, km; EAER _p , km. | <p>Averaging and intermediate rounding according to paragraph 7. of this UN GTR.</p> <p>In the case that the interpolation method is applied, intermediate rounding shall be performed according to paragraph 7. of this UN GTR.</p> <p>AER_{city, ave}, EAER and EAER_p shall be rounded to the first place of decimal.</p> <p>M_{CO₂, weighted} shall be rounded to the second place of decimal.</p> <p>FC_{weighted} shall be rounded to the third place of decimal.</p> <p>EC and EC_p shall be rounded to the first place of decimal.</p> <p>The output is available for each vehicle H, vehicle L and, if applicable, vehicle M.</p> <p>In case that the interpolation method is not applied, final rounding of the test results shall be applied according to paragraph 7. of this UN GTR.</p> <p>AER_{city, ave}, EAER and EAER_p shall be rounded to the nearest whole number.</p> <p>M_{CO₂, weighted} shall be rounded to the nearest whole number.</p> <p>FC_{weighted} shall be rounded to the first place of decimal.</p> <p>EC and EC_p shall be rounded to the nearest whole number.</p> | <p>AER_{city, final}, km; M_{CO₂, weighted, final}, g/km; FC_{weighted, final}, l/100 km; EC_{final}, Wh/km; EC_{p, final}, Wh/km; EAER_{final}, km; EAER_{p, final}, km.</p> | <p>8</p> <p>Interpolation family result. If the interpolation method is not applied, step No. 9 is not required and the output of this step is the final result.</p> |

| <i>Source</i> | <i>Input</i> | <i>Process</i> | <i>Output</i> | <i>Step no.</i> |
|---|--|---|--|---|
| Output step 5 Output step 8 Output step 4 | AER _{dec} , km; AER _{city,final} , km; M _{CO2,weighted,final} , g/km; FC _{weighted,final} , l/100 km; EC _{final} , Wh/km; EC _{p,final} , Wh/km; EAER _{final} , km; EAER _{p,final} , km; AER-interpolation availability. | Interpolation of individual values based on input from vehicle low, medium and high according to paragraph 4.5. of this annex, and final rounding according to paragraph 7. of this UN GTR. AER _{ind} , AER _{city,ind} , EAER _{ind} and EAER _{p,ind} shall be rounded to the nearest whole number. M _{CO2,weighted,ind} shall be rounded to the nearest whole number. EC _{weighted,ind} shall be rounded to the first place of decimal. FC _{weighted,ind} shall be rounded to the first place of decimal. EC _{ind} and EC _{p,ind} shall be rounded to the nearest whole number. Output available for each individual vehicles. | AER _{ind} , km; AER _{city,ind} , km; M _{CO2,weighted,ind} , g/km; FC _{weighted,ind} , l/100 km; EC _{ind} , Wh/km; EC _{p,ind} , Wh/km; EAER _{ind} , km; EAER _{p,ind} , km. | 9 Result of an individual vehicle. Final test result. |
| Output step 1 | R _{CDC} | R _{CDC} shall be rounded according to paragraph 7. of this UN GTR to the nearest whole number. | R _{CDC,final} | |

4.7. Stepwise procedure for calculating the final test results of PEVs

The results shall be calculated in the order described in Table A8/10 of the consecutive cycle procedure and in the order described in Table A8/11 in case of the shortened test procedure. All applicable results in the column "Output" shall be recorded. The column "Process" describes the paragraphs to be used for calculation or contains additional calculations.

4.7.1. Stepwise procedure for calculating the final test results of PEVs in case of the consecutive cycles procedure

For the purpose of this table, the following nomenclature within the questions and results is used:

j index for the considered period.

Table A8/10

Calculation of final PEV values determined by application of the consecutive cycle Type 1 procedure

| <i>Source</i> | <i>Input</i> | <i>Process</i> | <i>Output</i> | <i>Step no.</i> |
|---------------|---|---|---|-----------------|
| Annex 8 | Test results | <p>Results measured according to Appendix 3 to this annex and pre-calculated according to paragraph 4.3. of this annex.</p> <p>Usable battery energy according to paragraph 4.4.2.2.1. of this annex.</p> <p>Recharged electric energy according to paragraph 3.4.4.3. of this annex.</p> <p>Output available for each test.</p> <p>E_{AC} shall be rounded according to paragraph 7. of this UN GTR to the first place of decimal. In the case that the interpolation method is applied, the output is available for vehicle H and vehicle L.</p> | <p>$\Delta E_{REESS,j}$, Wh; d_j, km;</p> <p>UBE_{CCP}, Wh;</p> <p>E_{AC}, Wh.</p> | 1 |
| Output step 1 | $\Delta E_{REESS,j}$, Wh; UBE_{CCP} , Wh. | <p>Determination of the number of completely driven applicable WLTC phases and cycles according to paragraph 4.4.2.2. of this annex.</p> <p>Output available for each test.</p> <p>In the case that the interpolation method is applied, the output is available for vehicle H and vehicle L.</p> | <p>n_{WLTC};</p> <p>n_{city};</p> <p>n_{low};</p> <p>n_{med};</p> <p>n_{high};</p> <p>n_{exHigh}.</p> | 2 |

| Source | Input | Process | Output | Step no. |
|---|--|---|--|----------|
| Output step 1 Output step 2 | $\Delta E_{REESS,j}$, Wh; UBE _{ECCP} , Wh. n _{WLTC} ; n _{city} ; n _{low} ; n _{med} ; n _{high} ; n _{exHigh} . | Calculation of weighting factors according to paragraph 4.4.2.2. of this annex. Note: The number of weighting factors depends on the applicable cycle that was used (3- or 4-phase WLTC). In the case of 4-phase WLTCs, the output in brackets might be needed in addition. Output available for each test. In the case that the interpolation method is applied, the output is available for vehicle H and vehicle L. | K _{WLTC,1} K _{WLTC,2} K _{WLTC,3} (K _{WLTC,4}) K _{city,1} K _{city,2} K _{city,3} (K _{city,4}) K _{low,1} K _{low,2} K _{low,3} (K _{low,4}) K _{med,1} K _{med,2} K _{med,3} (K _{med,4}) K _{high,1} K _{high,2} K _{high,3} (K _{high,4}) K _{exHigh,1} K _{exHigh,2} K _{exHigh,3} (K _{exHigh,4}) | 3 |
| Output step 1 Output step 2 Output step 3 | $\Delta E_{REESS,j}$, Wh; d _j , km; UBE _{ECCP} , Wh. n _{WLTC} ; n _{city} ; n _{low} ; n _{med} ; n _{high} ; n _{exHigh} . All weighting | Calculation of electric energy consumption at the REESSs according to paragraph 4.4.2.2. of this annex. Regional option: EC _{DC,COP,1} Output available for each test. In the case that the interpolation method is applied, the output is available for vehicle H and vehicle L. | EC _{DC,WLTC} , Wh/km; EC _{DC,city} , Wh/km; EC _{DC,low} , Wh/km; EC _{DC,med} , Wh/km; EC _{DC,high} , Wh/km; EC _{DC,exHigh} , Wh/km; EC _{DC,COP,1} , Wh/km. | 4 |
| Output step 1 Output step 4 | UBE _{ECCP} , Wh; EC _{DC,WLTC} , Wh/km; EC _{DC,city} , Wh/km; EC _{DC,low} , Wh/km; EC _{DC,med} , Wh/km; EC _{DC,high} , Wh/km; EC _{DC,exHigh} , Wh/km. | Calculation of pure electric range according to paragraph 4.4.2.2. of this annex. Output available for each test. In the case that the interpolation method is applied, the output is available for vehicle H and vehicle L. | PER _{WLTC} , km; PER _{city} , km; PER _{low} , km; PER _{med} , km; PER _{high} , km; PER _{exHigh} , km. | 5 |

| Source | Input | Process | Output | Step no. |
|---|---|---|---|--|
| Output step 1 Output step 5 | E _{AC} , Wh; PER _{WLTC} , km; PER _{city} , km; PER _{low} , km; PER _{med} , km; PER _{high} , km; PER _{exHigh} , km. | Calculation of electric energy consumption at the mains according to paragraph 4.3.4. of this annex. Output available for each test. In the case that the interpolation method is applied, the output is available for vehicle H and vehicle L. | EC _{WLTC} , Wh/km; EC _{city} , Wh/km; EC _{low} , Wh/km; EC _{med} , Wh/km; EC _{high} , Wh/km; EC _{exHigh} , Wh/km. | 6 |
| Output step 5 Output step 6 Output step 4 | PER _{WLTC} , km; PER _{city} , km; PER _{low} , km; PER _{med} , km; PER _{high} , km; PER _{exHigh} , km; EC _{WLTC} , Wh/km; EC _{city} , Wh/km; EC _{low} , Wh/km; EC _{med} , Wh/km; EC _{high} , Wh/km; EC _{exHigh} , Wh/km. EC _{DC,COP,1} , Wh/km. | Averaging of tests for all input values. Regional option: EC _{DC,COP,ave} Declaration of PER _{WLTC,dec} and EC _{WLTC,dec} based on PER _{WLTC,ave} and EC _{WLTC,ave} . In the case that the interpolation method is applied, the output is available for vehicles H and vehicle L. PER _{WLTC,dec} as well as EC _{WLTC,dec} shall be rounded according to paragraph 7. of this UN GTR to the number of places of decimal as specified in Table A6/1 of Annex 6. In the case that the interpolation method is not applied, PER _{WLTC,dec} and EC _{WLTC,dec} shall be rounded according to paragraph 7. of this UN GTR to the nearest whole number. | PER _{WLTC,dec} , km; PER _{WLTC,ave} , km; PER _{city,ave} , km; PER _{low,ave} , km; PER _{med,ave} , km; PER _{high,ave} , km; PER _{exHigh,ave} , km; EC _{WLTC,dec} , Wh/km; EC _{WLTC,ave} , Wh/km; EC _{city,ave} , Wh/km; EC _{low,ave} , Wh/km; EC _{med,ave} , Wh/km; EC _{high,ave} , Wh/km; EC _{exHigh,ave} , Wh/km; EC _{DC,COP,ave} , Wh/km. | 7 If the interpolation method is not applied, step No. 10 is not required and the output of this step for PER _{WLTC,dec} and EC _{WLTC,dec} is the final result. |
| Output step 7 | EC _{WLTC,dec} , Wh/km; EC _{WLTC,ave} , Wh/km; EC _{DC,COP,ave} , Wh/km. | Regional option: Determination of the adjustment factor and application to EC _{DC,COP,ave} . For example: $AF = \frac{EC_{WLTC,dec}}{EC_{WLTC,ave}}$ $EC_{DC,COP} = EC_{DC,COP,ave} \times AF$ In the case that the interpolation method is applied, the output is available for vehicle H and vehicle L. | EC _{DC,COP} , Wh/km. | 8 |

| <i>Source</i> | <i>Input</i> | <i>Process</i> | <i>Output</i> | <i>Step no.</i> |
|---------------|--|--|--|--|
| Output step 7 | <p>PER_{city,ave}, km; PER_{low,ave}, km; PER_{med,ave}, km; PER_{high,ave}, km; PER_{exHigh,ave}, km;</p> <p>EC_{city,ave}, Wh/km; EC_{low,ave}, Wh/km; EC_{med,ave}, Wh/km; EC_{high,ave}, Wh/km; EC_{exHigh,ave}, Wh/km;</p> <p>EC_{DC,COP}, Wh/km.</p> | <p>Intermediate rounding according to paragraph 7. of this UN GTR.</p> <p>In the case that the interpolation method is applied, intermediate rounding shall be performed according to paragraph 7. of this UN GTR.</p> <p>PER_{city} and PER_p shall be rounded to the first place of decimal.</p> <p>EC_{city} and EC_p shall be rounded to the first place of decimal.</p> <p>Regional option: EC_{DC,COP} shall be rounded to the first place of decimal.</p> <p>The output is available for vehicle H and vehicle L.</p> <p>In case that the interpolation method is not applied, final rounding of the test results according to paragraph 7. of this UN GTR.</p> <p>PER_{city} and PER_p shall be rounded to the nearest whole number.</p> <p>EC_{city} and EC_p shall be rounded to the nearest whole number.</p> <p>Regional option: EC_{DC,COP} shall be rounded to the nearest whole number.</p> | <p>PER_{city,final}, km; PER_{low,final}, km; PER_{med,final}, km; PER_{high,final}, km; PER_{exHigh,final}, km;</p> <p>EC_{city,final}, Wh/km; EC_{low,final}, Wh/km; EC_{med,final}, Wh/km; EC_{high,final}, Wh/km; EC_{exHigh,final}, Wh/km;</p> <p>EC_{DC,COP,final}, Wh/km.</p> | <p>9</p> <p>If the interpolation method is not applied, step No. 10 is not required and the output of this step is the final result.</p> |
| Output step 8 | | | | |

| <i>Source</i> | <i>Input</i> | <i>Process</i> | <i>Output</i> | <i>Step no.</i> |
|------------------------------------|--|---|--|--|
| Output step 7 Output step 9 | <p>PER_{WLTC,dec}, km; EC_{WLTC,dec}, Wh/km</p> <p>PER_{city,final}, km; PER_{low,final}, km; PER_{med,final}, km; PER_{high,final}, km; PER_{exHigh,final}, km;</p> <p>EC_{city,final}, Wh/km; EC_{low,final}, Wh/km; EC_{med,final}, Wh/km; EC_{high,final}, Wh/km; EC_{exHigh,final}, Wh/km;</p> <p>EC_{DC,COP,final}, Wh/km.</p> | <p>Interpolation of individual values based on input from vehicle H and vehicle L according to paragraph 4.5. of this annex, and final rounding according to paragraph 7. of this UN GTR.</p> <p>PER_{ind}, PER_{city,ind}, and PER_{p,ind} shall be rounded to the nearest whole number.</p> <p>EC_{ind}, EC_{city} and EC_{p,ind} shall be rounded to the nearest whole number.</p> <p>Regional option: EC_{DC,COP,ind} shall be rounded to the nearest whole number.</p> <p>The output is available for each individual vehicle.</p> | <p>PER_{WLTC,ind}, km; PER_{city,ind}, km; PER_{low,ind}, km; PER_{med,ind}, km; PER_{high,ind}, km; PER_{exHigh,ind}, km;</p> <p>EC_{WLTC,ind}, Wh/km; EC_{city,ind}, Wh/km; EC_{low,ind}, Wh/km; EC_{med,ind}, Wh/km; EC_{high,ind}, Wh/km; EC_{exHigh,ind}, Wh/km;</p> <p>EC_{DC,COP,ind}, Wh/km.</p> | <p>10</p> <p>Result of an individual vehicle. Final test result.</p> |

4.7.2. Stepwise procedure for calculating the final test results of PEVs in case of the shortened test procedure

For the purpose of this table, the following nomenclature within the questions and results is used:

j index for the considered period.

Table A8/11

Calculation of final PEV values determined by application the shortened Type 1 test procedure

| <i>Source</i> | <i>Input</i> | <i>Process</i> | <i>Output</i> | <i>Step no.</i> |
|---------------|---|--|--|-----------------|
| Annex 8 | Test results | <p>Results measured according to Appendix 3 to this annex, and pre-calculated according to paragraph 4.3. of this annex.</p> <p>Usable battery energy according to paragraph 4.4.2.1.1. of this annex.</p> <p>Recharged electric energy according to paragraph 3.4.4.3. of this annex.</p> <p>Output is available for each test.</p> <p>E_{AC} shall be rounded according to paragraph 7. of this UN GTR to the first place of decimal.</p> <p>In the case that the interpolation method is applied, the output is available for vehicle L and vehicle H.</p> | <p>$\Delta E_{REESS,j}$, Wh; d_j, km;</p> <p>UBE_{STP}, Wh;</p> <p>E_{AC}, Wh.</p> | 1 |
| Output step 1 | $\Delta E_{REESS,j}$, Wh; UBE_{STP} , Wh. | <p>Calculation of weighting factors according to paragraph 4.4.2.1. of this annex.</p> <p>Output is available for each test.</p> <p>In the case that the interpolation method is applied, the output is available for vehicle H and vehicle L.</p> | <p>$K_{WLTC,1}$ $K_{WLTC,2}$ $K_{city,1}$ $K_{city,2}$ $K_{city,3}$ $K_{city,4}$ $K_{low,1}$ $K_{low,2}$ $K_{low,3}$ $K_{low,4}$ $K_{med,1}$ $K_{med,2}$ $K_{med,3}$ $K_{med,4}$ $K_{high,1}$ $K_{high,2}$ $K_{exHigh,1}$ $K_{exHigh,2}$</p> | 2 |

| <i>Source</i> | <i>Input</i> | <i>Process</i> | <i>Output</i> | <i>Step no.</i> |
|------------------------------------|---|--|--|-----------------|
| Output step 1 Output step 2 | $\Delta E_{REESS,j}$, Wh; d_j , km; UB_{ESTP} , Wh. All weighting | Calculation of electric energy consumption at the REESSs according to paragraph 4.4.2.1. of this annex. Regional option: $EC_{DC,COP,1}$ Output is available for each test. In the case that the interpolation method is applied, the output is available for vehicle H and vehicle L. | $EC_{DC,WLTC}$, Wh/km; $EC_{DC,city}$, Wh/km; $EC_{DC,low}$, Wh/km; $EC_{DC,med}$, Wh/km; $EC_{DC,high}$, Wh/km; $EC_{DC,exHigh}$, Wh/km; $EC_{DC,COP,1}$, Wh/km. | 3 |
| Output step 1 Output step 3 | UB_{ESTP} , Wh; $EC_{DC,WLTC}$, Wh/km; $EC_{DC,city}$, Wh/km; $EC_{DC,low}$, Wh/km; $EC_{DC,med}$, Wh/km; $EC_{DC,high}$, Wh/km; $EC_{DC,exHigh}$, Wh/km. | Calculation of pure electric range according to paragraph 4.4.2.1. of this annex. Output is available for each test. In the case that the interpolation method is applied, the output is available for vehicle H and vehicle L. | PER_{WLTC} , km; PER_{city} , km; PER_{low} , km; PER_{med} , km; PER_{high} , km; PER_{exHigh} , km. | 4 |
| Output step 1 Output step 4 | E_{AC} , Wh; PER_{WLTC} , km; PER_{city} , km; PER_{low} , km; PER_{med} , km; PER_{high} , km; PER_{exHigh} , km. | Calculation of electric energy consumption at the mains according to paragraph 4.3.4. of this annex. Output is available for each test. In the case that the interpolation method is applied, the output is available for vehicle L and vehicle H. | EC_{WLTC} , Wh/km; EC_{city} , Wh/km; EC_{low} , Wh/km; EC_{med} , Wh/km; EC_{high} , Wh/km; EC_{exHigh} , Wh/km. | 5 |

| <i>Source</i> | <i>Input</i> | <i>Process</i> | <i>Output</i> | <i>Step no.</i> |
|---------------|--|--|--|---|
| Output step 6 | <p>PER_{city,ave}, km; PER_{low,ave}, km; PER_{med,ave}, km; PER_{high,ave}, km; PER_{exHigh,ave}, km;</p> <p>EC_{city,ave}, Wh/km; EC_{low,ave}, Wh/km; EC_{med,ave}, Wh/km; EC_{high,ave}, Wh/km; EC_{exHigh,ave}, Wh/km;</p> <p>EC_{DC,COP}, Wh/km.</p> | <p>Intermediate rounding according to paragraph 7. of this UN GTR.</p> <p>In the case that the interpolation method is applied, intermediate rounding shall be performed according to paragraph 7. of this UN GTR.</p> <p>PER_{city} and PER_p shall be rounded to the first place of decimal.</p> <p>EC_{city} and EC_p shall be rounded to the first place of decimal.</p> <p>Regional option: EC_{DC,COP} shall be rounded to the first place of decimal.</p> <p>The output is available for vehicle H and vehicle L.</p> <p>In case that the interpolation method is not applied, final rounding of the test results according to paragraph 7. of this UN GTR shall apply.</p> <p>PER_{city} and PER_p shall be rounded to the nearest whole number.</p> <p>EC_{city} and EC_p shall be rounded to the nearest whole number.</p> <p>Regional option: EC_{DC,COP} shall be rounded to the nearest whole number.</p> | <p>PER_{city,final}, km; PER_{low,final}, km; PER_{med,final}, km; PER_{high,final}, km; PER_{exHigh,final}, km;</p> <p>EC_{city,final}, Wh/km; EC_{low,final}, Wh/km; EC_{med,final}, Wh/km; EC_{high,final}, Wh/km; EC_{exHigh,final}, Wh/km;</p> <p>EC_{DC,COP,final}, Wh/km.</p> | <p>8</p> <p>Interpolation family result. If the interpolation method is not applied, step No. 9 is not required and the output of this step is the final result.</p> |
| Output step 7 | | | | |

Annex 8 - Appendix 1

REESS state of charge profile

1. Test sequences and REESS profiles: OVC-HEVs, charge-depleting and charge-sustaining test
 - 1.1. Test sequence OVC-HEVs according to option 1

Charge-depleting type 1 test with no subsequent charge-sustaining Type 1 test (Figure A8.App1/1)

Figure A8.App1/1
OVC-HEVs, charge-depleting Type 1 test

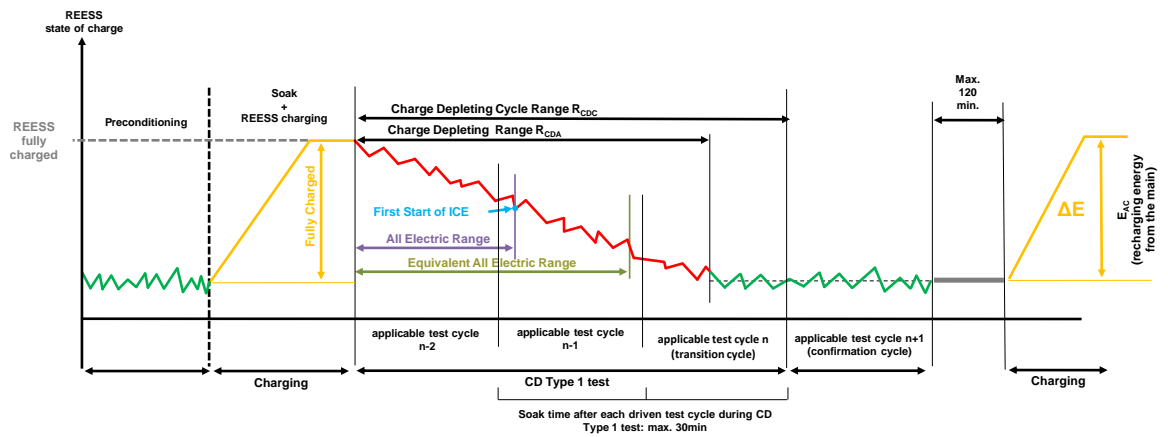

- 1.2. Test sequence OVC-HEVs according to option 2

Charge-sustaining Type 1 test with no subsequent charge-depleting Type 1 test (Figure A8.App1/2).

Figure A8.App1/2
OVC-HEVs, charge-sustaining Type 1 test

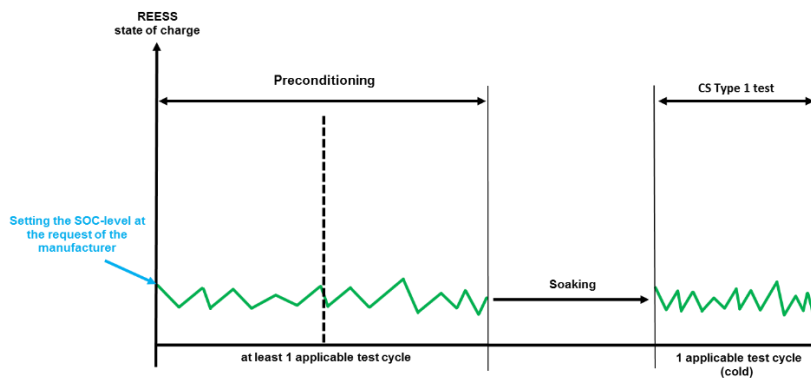

- 1.3. Test sequence OVC-HEVs according to option 3
 Charge-depleting Type 1 test with subsequent charge-sustaining Type 1 test
 (Figure A8.App1/3).

Figure A8.App1/3
 OVC-HEVs, charge-depleting type 1 test with subsequent charge-sustaining Type 1 test

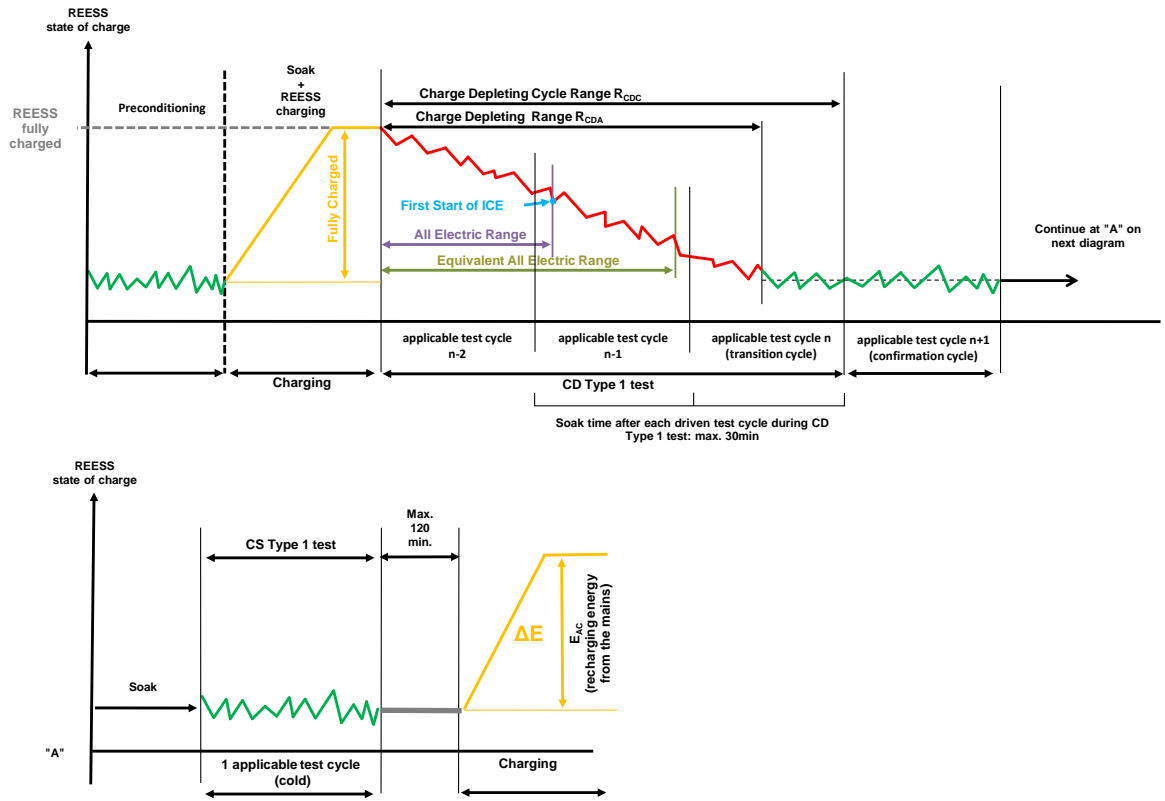

1.4. Test sequence OVC-HEVs according to option 4

Charge-sustaining Type 1 test with subsequent charge-depleting Type 1 test
(Figure A8.App1/4)

Figure A8.App1/4

OVC-HEVs, charge-sustaining Type 1 test with subsequent charge-depleting Type 1 test

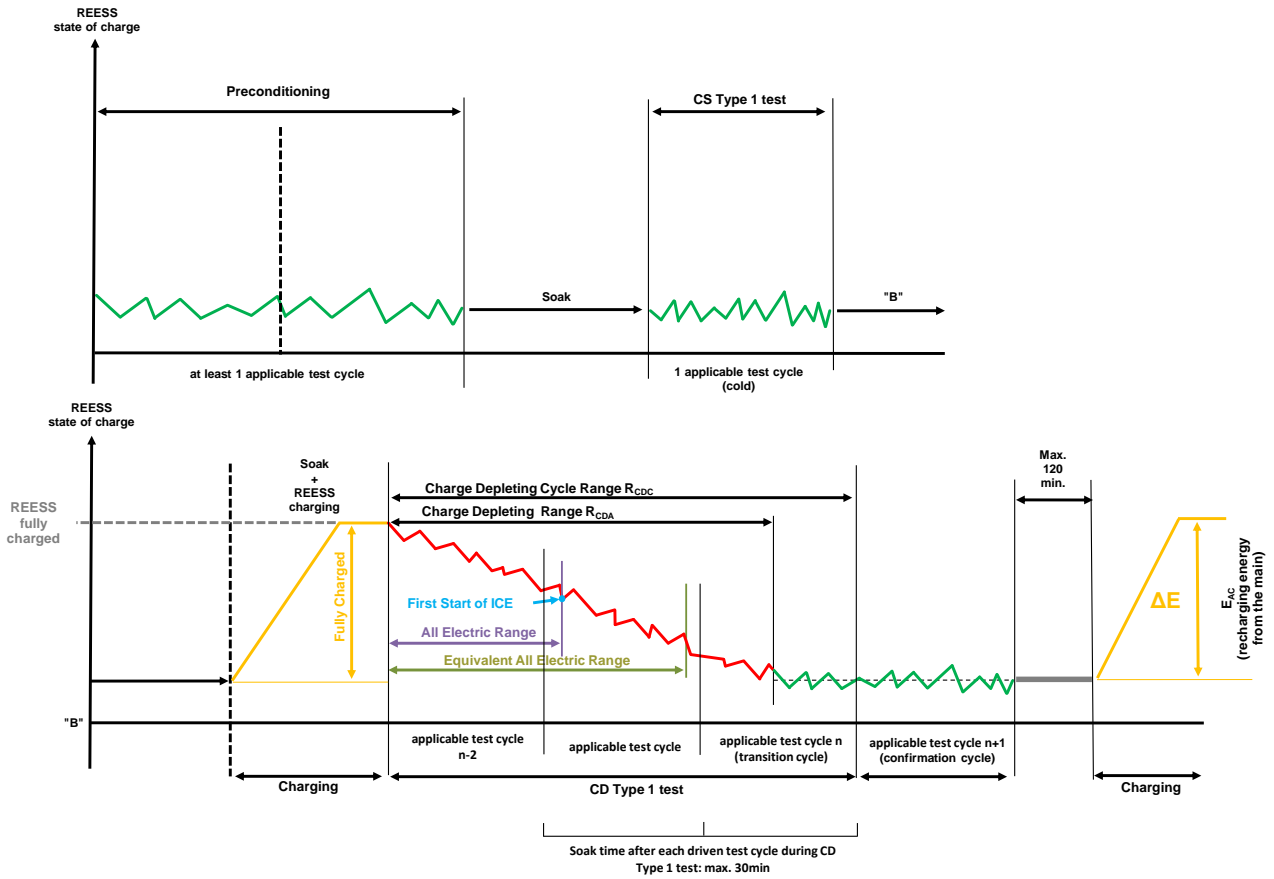

- 2. Test sequence NOVC-HEVs and NOVC-FCHVs
Charge-sustaining Type 1 test (Figure A8.App1/5)

Figure A8.App1/5
NOVC-HEVs and NOVC-FCHVs, charge-sustaining Type 1 test

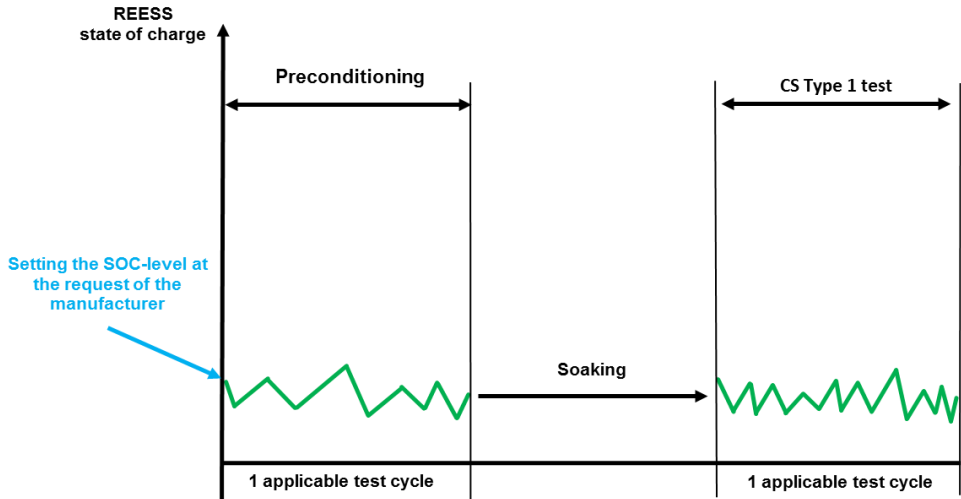

- 3. Test sequences PEV
- 3.1. Consecutive cycles procedure (Figure A8.App1/6)

Figure A8.App1/6
Consecutive cycles test sequence PEV

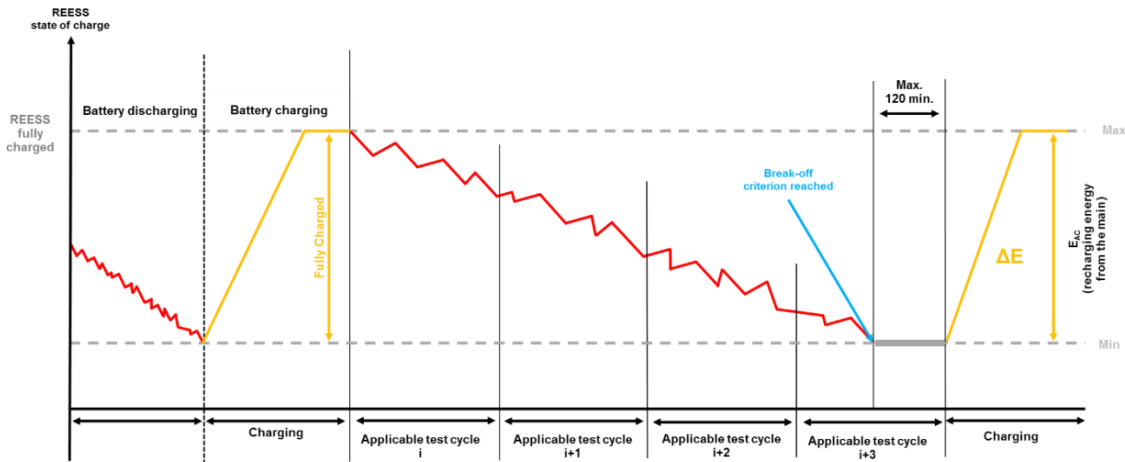

3.2. Shortened test procedure (Figure A8.App1/7)

Figure A8.App1/7
Shortened test procedure test sequence for PEVs

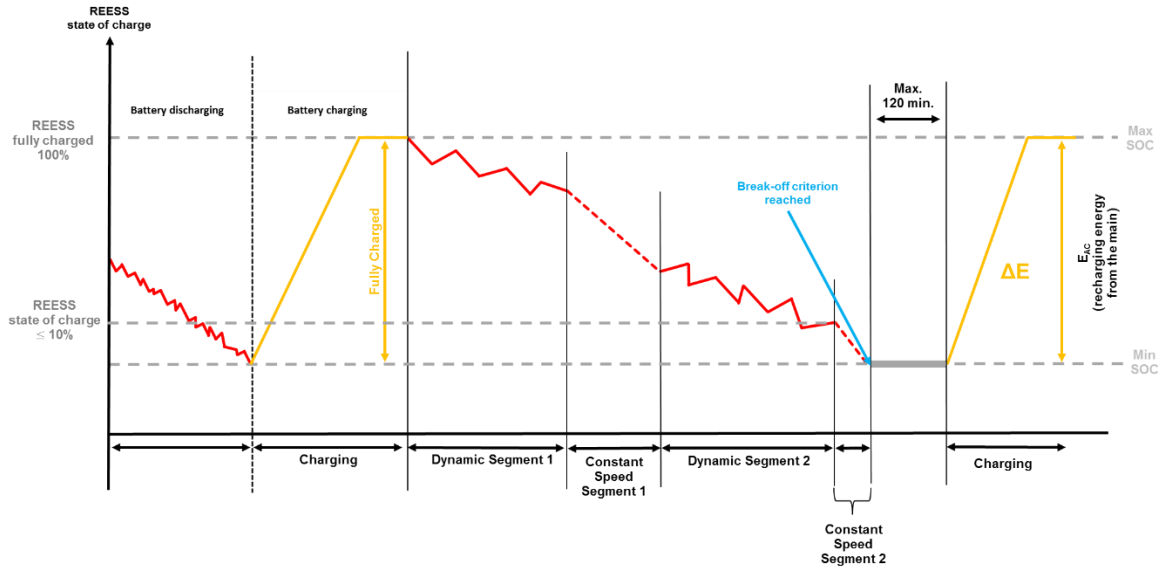

Annex 8 - Appendix 2

REESS energy change-based correction procedure

This Appendix describes the procedure to correct the charge-sustaining Type 1 test CO₂ mass emission for NOVC-HEVs and OVC-HEVs, and the fuel consumption for NOVC-FCHVs as a function of the electric energy change of all REESSs.

1. General requirements
 - 1.1. Applicability of this appendix
 - 1.1.1. The phase-specific fuel consumption for NOVC-FCHVs, and the CO₂ mass emission for NOVC-HEVs and OVC-HEVs shall be corrected.
 - 1.1.2. In the case that a correction of fuel consumption for NOVC-FCHVs or a correction of CO₂ mass emission for NOVC-HEVs and OVC-HEVs measured over the whole cycle according to paragraph 1.1.3. or paragraph 1.1.4. of this appendix is applied, paragraph 4.3. of this annex shall be used to calculate the charge-sustaining REESS energy change $\Delta E_{\text{REESS,CS}}$ of the charge-sustaining Type 1 test. The considered period j used in paragraph 4.3. of this annex is defined by the charge-sustaining Type 1 test.
 - 1.1.3. The correction shall be applied if $\Delta E_{\text{REESS,CS}}$ is negative which corresponds to REESS discharging and the correction criterion c calculated in paragraph 1.2. of this appendix is greater than the applicable threshold according to Table A8.App2/1.
 - 1.1.4. The correction may be omitted and uncorrected values may be used if:
 - (a) $\Delta E_{\text{REESS,CS}}$ is positive which corresponds to REESS charging and the correction criterion c calculated in paragraph 1.2. of this appendix is greater than the applicable threshold according to Table A8.App2/1;
 - (b) The correction criterion c calculated in paragraph 1.2. of this appendix is smaller than the applicable threshold according to Table A8.App2/1;
 - (c) The manufacturer can prove to the responsible authority by measurement that there is no relation between $\Delta E_{\text{REESS,CS}}$ and charge-sustaining CO₂ mass emission and $\Delta E_{\text{REESS,CS}}$ and fuel consumption respectively.
 - 1.2. The correction criterion c is the ratio between the absolute value of the REESS electric energy change $\Delta E_{\text{REESS,CS}}$ and the fuel energy and shall be calculated as follows:

$$c = \frac{|\Delta E_{\text{REESS,CS}}|}{E_{\text{fuel,CS}}}$$

where:

$\Delta E_{\text{REESS,CS}}$ is the charge-sustaining REESS energy change according to paragraph 1.1.2. of this appendix, Wh;

$E_{\text{fuel,CS}}$ is the charge-sustaining energy content of the consumed fuel according to paragraph 1.2.1. of this appendix in the case of

NOVC-HEVs and OVC-HEVs, and according to paragraph 1.2.2. of this appendix in the case of NOVC-FCHVs, Wh.

1.2.1. Charge-sustaining fuel energy for NOVC-HEVs and OVC-HEVs

The charge-sustaining energy content of the consumed fuel for NOVC-HEVs and OVC-HEVs shall be calculated using the following equation:

$$E_{\text{fuel,CS}} = 10 \times HV \times FC_{\text{CS,nb}} \times d_{\text{CS}}$$

where:

$E_{\text{fuel,CS}}$ is the charge-sustaining energy content of the consumed fuel of the applicable WLTP test cycle of the charge-sustaining Type 1 test, Wh;

HV is the heating value according to Table A6.App2/1, kWh/l;

$FC_{\text{CS,nb}}$ is the non-balanced charge-sustaining fuel consumption of the charge-sustaining Type 1 test, not corrected for the energy balance, determined according to paragraph 6. of Annex 7, using the gaseous emission compound values according to Table A8/5, step No. 2, l/100 km;

d_{CS} is the distance driven over the corresponding applicable WLTP test cycle, km;

10 conversion factor to Wh.

1.2.2. Charge-sustaining fuel energy for NOVC-FCHVs

The charge-sustaining energy content of the consumed fuel for NOVC-FCHVs shall be calculated using the following equation:

$$E_{\text{fuel,CS}} = \frac{1}{0.36} \times 121 \times FC_{\text{CS,nb}} \times d_{\text{CS}}$$

where:

$E_{\text{fuel,CS}}$ is the charge-sustaining energy content of the consumed fuel of the applicable WLTP test cycle of the charge-sustaining Type 1 test, Wh;

121 is the lower heating value of hydrogen, MJ/kg;

$FC_{\text{CS,nb}}$ is the non-balanced charge-sustaining fuel consumption of the charge-sustaining Type 1 test, not corrected for the energy balance, determined according to Table A8/7, step No.1, kg/100 km;

d_{CS} is the distance driven over the corresponding applicable WLTP test cycle, km;

$\frac{1}{0.36}$ conversion factor to Wh.

Table A8.App2/1
RCB correction criteria thresholds

| Applicable Type 1 test cycle | Low + Medium + | | Low + Medium + |
|---|----------------|------|-------------------|
| | Low + Medium | High | High + Extra High |
| Thresholds for correction criterion c | 0.015 | 0.01 | 0.005 |

2. Calculation of correction coefficients

2.1. The CO₂ mass emission correction coefficient K_{CO_2} , the fuel consumption correction coefficients $K_{fuel,FCHV}$, as well as, if required by the manufacturer, the phase-specific correction coefficients $K_{CO_2,p}$ and $K_{fuel,FCHV,p}$ shall be developed based on the applicable charge-sustaining Type 1 test cycles.

In the case that vehicle H was tested for the development of the correction coefficient for CO₂ mass emission for NOVC-HEVs and OVC-HEVs, the coefficient may be applied within the interpolation family.

2.2. The correction coefficients shall be determined from a set of charge-sustaining Type 1 tests according to paragraph 3. of this appendix. The number of tests performed by the manufacturer shall be equal to or greater than five.

The manufacturer may request to set the state of charge of the REESS prior to the test according to the manufacturer's recommendation and as described in paragraph 3. of this appendix. This practice shall only be used for the purpose of achieving a charge-sustaining Type 1 test with opposite sign of the $\Delta E_{REESS,CS}$ and with approval of the responsible authority.

The set of measurements shall fulfil the following criteria:

- (a) The set shall contain at least one test with $\Delta E_{REESS,CS,n} \leq 0$ and at least one test with $\Delta E_{REESS,CS,n} > 0$. $\Delta E_{REESS,CS,n}$ is the sum of electric energy changes of all REESSs of test n calculated according to paragraph 4.3. of this annex.
- (b) The difference in $M_{CO_2,CS}$ between the test with the highest negative electric energy change and the test with the highest positive electric energy change shall be greater than or equal to 5 g/km. This criterion shall not be applied for the determination of $K_{fuel,FCHV}$.

In the case of the determination of K_{CO_2} , the required number of tests may be reduced to three tests if all of the following criteria are fulfilled in addition to (a) and (b):

- (c) The difference in $M_{CO_2,CS}$ between any two adjacent measurements, related to the electric energy change during the test, shall be less than or equal to 10 g/km.
- (d) In addition to (b), the test with the highest negative electric energy change and the test with the highest positive electric energy change shall not be within the region that is defined by:

$$-0.01 \leq \frac{\Delta E_{REESS}}{E_{fuel}} \leq +0.01,$$

where:

E_{fuel} is the energy content of the consumed fuel calculated according to paragraph 1.2. of this appendix, Wh.

- (e) The difference in $M_{\text{CO}_2,\text{CS}}$ between the test with the highest negative electric energy change and the mid-point, and the difference in $M_{\text{CO}_2,\text{CS}}$ between the mid-point and the test with the highest positive electric energy change shall be similar and preferably be within the range defined by (d). If this requirement is not feasible, the responsible authority shall decide if a retest is necessary.

The correction coefficients determined by the manufacturer shall be reviewed and approved by the responsible authority prior to its application.

If the set of at least five tests does not fulfil criterion (a) or criterion (b) or both, the manufacturer shall provide evidence to the responsible authority as to why the vehicle is not capable of meeting either or both criteria. If the responsible authority is not satisfied with the evidence, it may require additional tests to be performed. If the criteria after additional tests are still not fulfilled, the responsible authority shall determine a conservative correction coefficient, based on the measurements.

2.3. Calculation of correction coefficients $K_{\text{fuel,FCHV}}$ and K_{CO_2}

2.3.1. Determination of the fuel consumption correction coefficient $K_{\text{fuel,FCHV}}$

For NOVC-FCHVs, the fuel consumption correction coefficient $K_{\text{fuel,FCHV}}$, determined by driving a set of charge-sustaining Type 1 tests, is defined using the following equation:

$$K_{\text{fuel,FCHV}} = \frac{\sum_{n=1}^{n_{\text{CS}}} \left((EC_{\text{DC,CS},n} - EC_{\text{DC,CS,avg}}) \times (FC_{\text{CS,nb},n} - FC_{\text{CS,nb,avg}}) \right)}{\sum_{n=1}^{n_{\text{CS}}} (EC_{\text{DC,CS},n} - EC_{\text{DC,CS,avg}})^2}$$

where:

$K_{\text{fuel,FCHV}}$ is the fuel consumption correction coefficient, (kg/100 km)/(Wh/km);

$EC_{\text{DC,CS},n}$ is the charge-sustaining electric energy consumption of test n based on the REESS depletion according to the equation below, Wh/km

$EC_{\text{DC,CS,avg}}$ is the mean charge-sustaining electric energy consumption of n_{CS} tests based on the REESS depletion according to the equation below, Wh/km;

$FC_{\text{CS,nb},n}$ is the charge-sustaining fuel consumption of test n, not corrected for the energy balance, according to Table A8/7, step No. 1, kg/100 km;

$FC_{\text{CS,nb,avg}}$ is the arithmetic average of the charge-sustaining fuel consumption of n_{CS} tests based on the fuel consumption, not corrected for the energy balance, according to the equation below, kg/100 km;

n is the index number of the considered test;

n_{CS} is the total number of tests;

and:

$$EC_{\text{DC,CS,avg}} = \frac{1}{n_{\text{CS}}} \times \sum_{n=1}^{n_{\text{CS}}} EC_{\text{DC,CS},n}$$

and:

$$FC_{CS,nb,avg} = \frac{1}{n_{CS}} \times \sum_{n=1}^{n_{CS}} FC_{CS,nb,n}$$

and:

$$EC_{DC,CS,n} = \frac{\Delta E_{REESS,CS,n}}{d_{CS,n}}$$

where:

$\Delta E_{REESS,CS,n}$ is the charge-sustaining REESS electric energy change of test n according to paragraph 1.1.2. of this appendix, Wh;

$d_{CS,n}$ is the distance driven over the corresponding charge-sustaining Type 1 test n, km.

The fuel consumption correction coefficient shall be rounded according to paragraph 7. of this UN GTR to four significant figures. The statistical significance of the fuel consumption correction coefficient shall be evaluated by the responsible authority.

2.3.1.1. It is permitted to apply the fuel consumption correction coefficient that was developed from tests over the whole applicable WLTP test cycle for the correction of each individual phase.

2.3.1.2. Additional to the requirements of paragraph 2.2. of this appendix, at the manufacturer's request and upon approval of the responsible authority, separate fuel consumption correction coefficients $K_{fuel,FCHV,p}$ for each individual phase may be developed. In this case, the same criteria as described in paragraph 2.2. of this appendix shall be fulfilled in each individual phase and the procedure described in paragraph 2.3.1. of this appendix shall be applied for each individual phase to determine each phase specific correction coefficient.

2.3.2. Determination of CO₂ mass emission correction coefficient K_{CO_2}

For OVC-HEVs and NOVC-HEVs, the CO₂ mass emission correction coefficient K_{CO_2} , determined by driving a set of charge-sustaining Type 1 tests, is defined by the following equation:

$$K_{CO_2} = \frac{\sum_{n=1}^{n_{CS}} \left((EC_{DC,CS,n} - EC_{DC,CS,avg}) \times (M_{CO_2,CS,nb,n} - M_{CO_2,CS,nb,avg}) \right)}{\sum_{n=1}^{n_{CS}} (EC_{DC,CS,n} - EC_{DC,CS,avg})^2}$$

where:

K_{CO_2} is the CO₂ mass emission correction coefficient, (g/km)/(Wh/km);

$EC_{DC,CS,n}$ is the charge-sustaining electric energy consumption of test n based on the REESS depletion according to paragraph 2.3.1. of this appendix, Wh/km;

$EC_{DC,CS,avg}$ is the arithmetic average of the charge-sustaining electric energy consumption of n_{CS} tests based on the REESS depletion according to paragraph 2.3.1. of this appendix, Wh/km;

| | |
|----------------------|---|
| $M_{CO_2,CS,nb,n}$ | is the charge-sustaining CO ₂ mass emission of test n, not corrected for the energy balance, calculated according Table A8/5, step No. 2, g/km; |
| $M_{CO_2,CS,nb,avg}$ | is the arithmetic average of the charge-sustaining CO ₂ mass emission of n_{CS} tests based on the CO ₂ mass emission, not corrected for the energy balance, according to the equation below, g/km; |
| n | is the index number of the considered test; |
| n_{CS} | is the total number of tests; |
| and: | |

$$M_{CO_2,CS,nb,avg} = \frac{1}{n_{CS}} \times \sum_{n=1}^{n_{CS}} M_{CO_2,CS,nb,n}$$

The CO₂ mass emission correction coefficient shall be rounded according to paragraph 7. of this UN GTR to four significant figures. The statistical significance of the CO₂ mass emission correction coefficient shall be evaluated by the responsible authority.

- 2.3.2.1. It is permitted to apply the CO₂ mass emission correction coefficient developed from tests over the whole applicable WLTP test cycle for the correction of each individual phase.
- 2.3.2.2. Additional to the requirements of paragraph 2.2. of this appendix, at the request of the manufacturer and upon approval of the responsible authority, separate CO₂ mass emission correction coefficients $K_{CO_2,p}$ for each individual phase may be developed. In this case, the same criteria as described in paragraph 2.2. of this appendix shall be fulfilled in each individual phase and the procedure described in paragraph 2.3.2. of this appendix shall be applied for each individual phase to determine phase-specific correction coefficients.
3. Test procedure for the determination of the correction coefficients
- 3.1. OVC-HEVs
- For OVC-HEVs, one of the following test sequences according to Figure A8.App2/1 shall be used to measure all values that are necessary for the determination of the correction coefficients according to paragraph 2. of this appendix.

Figure A8.App2/1
OVC-HEV test sequences

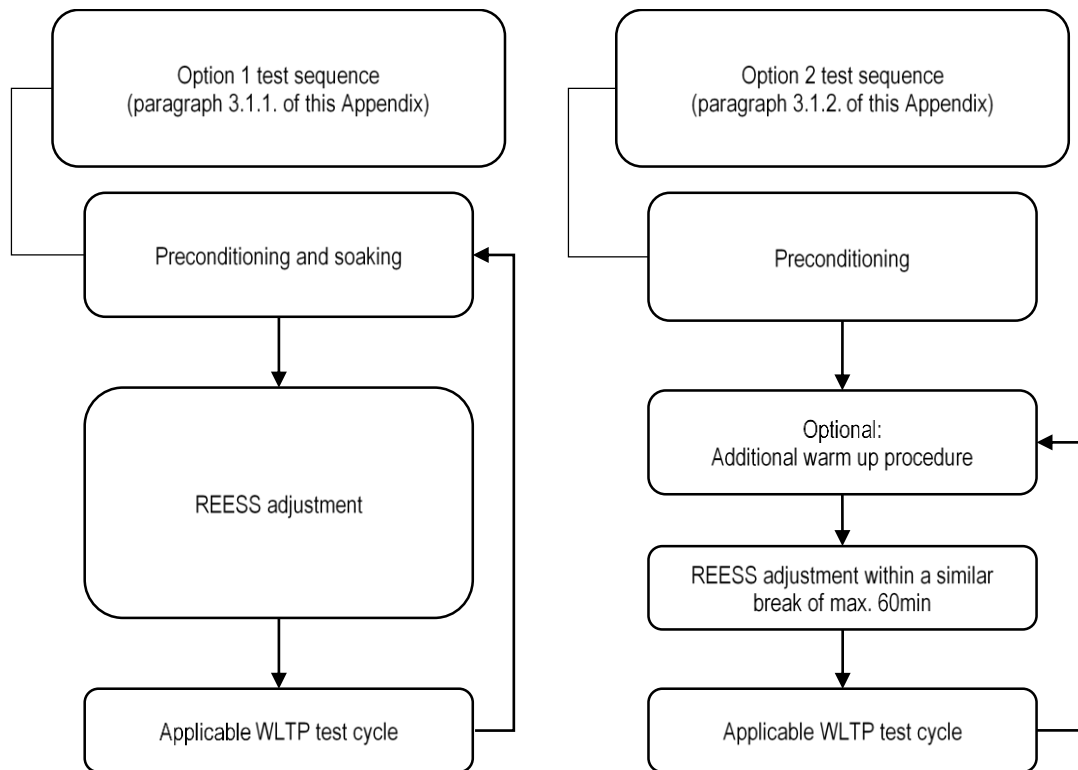

3.1.1. Option 1 test sequence

3.1.1.1. Preconditioning and soaking

Preconditioning and soaking shall be conducted according to paragraph 2.1. of Appendix 4 to this annex.

3.1.1.2. REESS adjustment

Prior to the test procedure according to paragraph 3.1.1.3. of this appendix, the manufacturer may adjust the REESS. The manufacturer shall provide evidence that the requirements for the beginning of the test according to paragraph 3.1.1.3. of this appendix are fulfilled.

3.1.1.3. Test procedure

3.1.1.3.1. The driver-selectable mode for the applicable WLTP test cycle shall be selected according to paragraph 3. of Appendix 6 to this annex.

3.1.1.3.2. For testing, the applicable WLTP test cycle according to paragraph 1.4.2. of this annex shall be driven.

3.1.1.3.3. Unless stated otherwise in this appendix, the vehicle shall be tested according to the Type 1 test procedure described in Annex 6.

3.1.1.3.4. To obtain a set of applicable WLTP test cycles required for the determination of the correction coefficients, the test may be followed by a number of consecutive sequences required according to paragraph 2.2. of this appendix consisting of paragraph 3.1.1.1. to paragraph 3.1.1.3. inclusive of this appendix.

- 3.1.2. Option 2 test sequence
 - 3.1.2.1. Preconditioning

The test vehicle shall be preconditioned according to paragraph 2.1.1. or paragraph 2.1.2. of Appendix 4 to this annex.
 - 3.1.2.2. REESS adjustment

After preconditioning, soaking according to paragraph 2.1.3. of Appendix 4 to this annex shall be omitted and a break, during which the REESS is permitted to be adjusted, shall be set to a maximum duration of 60 minutes. A similar break shall be applied in advance of each test. Immediately after the end of this break, the requirements of paragraph 3.1.2.3. of this appendix shall be applied.

Upon request of the manufacturer, an additional warm-up procedure may be conducted in advance of the REESS adjustment to ensure similar starting conditions for the correction coefficient determination. If the manufacturer requests this additional warm-up procedure, the identical warm-up procedure shall be applied repeatedly within the test sequence.
 - 3.1.2.3. Test procedure
 - 3.1.2.3.1. The driver-selectable mode for the applicable WLTP test cycle shall be selected according to paragraph 3. of Appendix 6 to this annex.
 - 3.1.2.3.2. For testing, the applicable WLTP test cycle according to paragraph 1.4.2. of this annex shall be driven.
 - 3.1.2.3.3. Unless stated otherwise in this appendix, the vehicle shall be tested according to the Type 1 test procedure described in Annex 6.
 - 3.1.2.3.4. To obtain a set of applicable WLTP test cycles that are required for the determination of the correction coefficients, the test may be followed by a number of consecutive sequences required according to paragraph 2.2. of this appendix consisting of paragraphs 3.1.2.2. and 3.1.2.3. of this appendix.
- 3.2. NOVC-HEVs and NOVC-FCHVs

For NOVC-HEVs and NOVC-FCHVs, one of the following test sequences according to Figure A8.App2/2 shall be used to measure all values that are necessary for the determination of the correction coefficients according to paragraph 2. of this appendix.

Figure A8.App2/2
NOVC-HEV and NOVC-FCHV test sequences

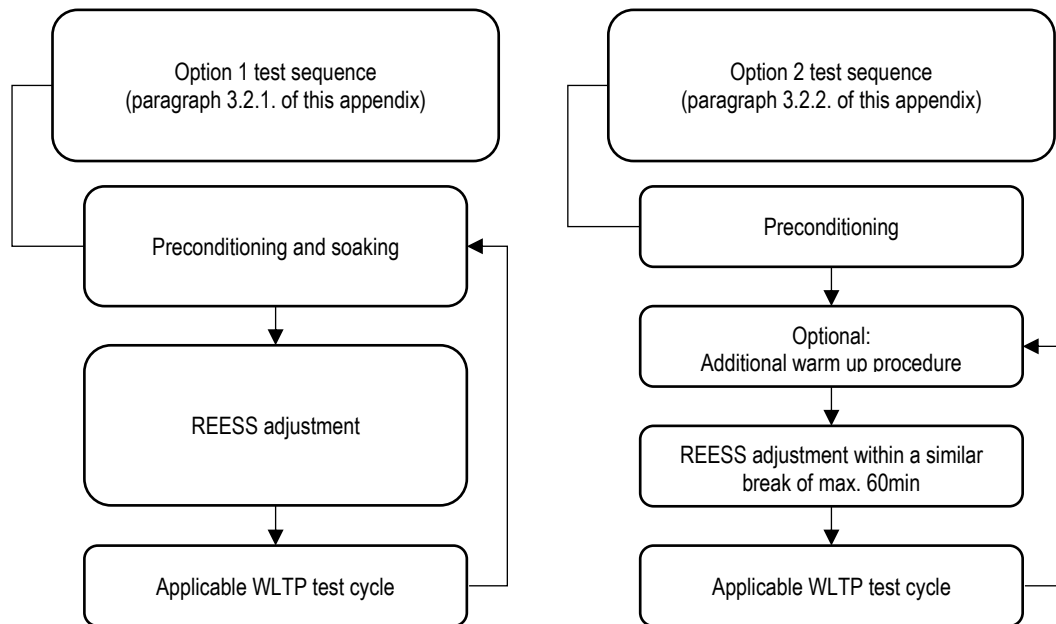

3.2.1. Option 1 test sequence

3.2.1.1. Preconditioning and soaking

The test vehicle shall be preconditioned and soaked according to paragraph 3.3.1. of this annex.

3.2.1.2. REESS adjustment

Prior to the test procedure, according to paragraph 3.2.1.3. of this appendix, the manufacturer may adjust the REESS. The manufacturer shall provide evidence that the requirements for the beginning of the test according to paragraph 3.2.1.3. of this appendix are fulfilled.

3.2.1.3. Test procedure

3.2.1.3.1. The driver-selectable mode shall be selected according to paragraph 3. of Appendix 6 to this annex.

3.2.1.3.2. For testing, the applicable WLTP test cycle according to paragraph 1.4.2. of this annex shall be driven.

3.2.1.3.3. Unless stated otherwise in this appendix, the vehicle shall be tested according to the charge-sustaining Type 1 test procedure described in Annex 6.

3.2.1.3.4. To obtain a set of applicable WLTP test cycles that are required for the determination of the correction coefficients, the test can be followed by a number of consecutive sequences required according to paragraph 2.2. of this appendix consisting of paragraph 3.2.1.1. to paragraph 3.2.1.3. inclusive of this appendix.

3.2.2. Option 2 test sequence

3.2.2.1. Preconditioning

The test vehicle shall be preconditioned according to paragraph 3.3.1.1. of this annex.

3.2.2.2. REESS adjustment

After preconditioning, the soaking according to paragraph 3.3.1.2. of this annex shall be omitted and a break, during which the REESS is permitted to be adjusted, shall be set to a maximum duration of 60 minutes. A similar break shall be applied in advance of each test. Immediately after the end of this break, the requirements of paragraph 3.2.2.3. of this appendix shall be applied.

Upon request of the manufacturer, an additional warm-up procedure may be conducted in advance of the REESS adjustment to ensure similar starting conditions for the correction coefficient determination. If the manufacturer requests this additional warm-up procedure, the identical warm-up procedure shall be applied repeatedly within the test sequence.

3.2.2.3. Test procedure

3.2.2.3.1. The driver-selectable mode for the applicable WLTP test cycle shall be selected according to paragraph 3. of Appendix 6 to this annex.

3.2.2.3.2. For testing, the applicable WLTP test cycle according to paragraph 1.4.2. of this annex shall be driven.

3.2.2.3.3. Unless stated otherwise in this appendix, the vehicle shall be tested according to the Type 1 test procedure described in Annex 6.

3.2.2.3.4. To get a set of applicable WLTP test cycles that are required for the determination of the correction coefficients, the test can be followed by a number of consecutive sequences required according to paragraph 2.2. of this appendix consisting of paragraphs 3.2.2.2. and 3.2.2.3. of this appendix.

Annex 8 - Appendix 3

Determination of REESS current and REESS voltage for NOVC-HEVs, OVC-HEVs, PEVs and NOVC-FCHVs

1. Introduction
 - 1.1. This appendix defines the method and required instrumentation to determine the REESS current and the REESS voltage of NOVC-HEVs, OVC-HEVs, PEVs and NOVC-FCHVs.
 - 1.2. Measurement of REESS current and REESS voltage shall start at the same time as the test starts and shall end immediately after the vehicle has finished the test.
 - 1.3. The REESS current and the REESS voltage of each phase shall be determined.
 - 1.4. A list of the instrumentation used by the manufacturer to measure REESS voltage and current (including instrument manufacturer, model number, serial number, last calibration dates (where applicable)) during:
 - (a) The Type 1 test according to paragraph 3 of this annex;
 - (b) The procedure to determine the correction coefficients according to Appendix 2 of this annex (where applicable);
 - (c) Any procedure which may be required by a Contracting Party shall be provided to the responsible authority.
2. REESS current

REESS depletion is considered as a negative current.

 - 2.1. External REESS current measurement
 - 2.1.1. The REESS current(s) shall be measured during the tests using a clamp-on or closed type current transducer. The current measurement system shall fulfil the requirements specified in Table A8/1 of this annex. The current transducer(s) shall be capable of handling the peak currents at engine starts and temperature conditions at the point of measurement.

In order to have an accurate measurement, zero adjustment and degaussing shall be performed before the test according to the instrument manufacturer's instructions.
 - 2.1.2. Current transducers shall be fitted to any of the REESS on one of the cables connected directly to the REESS and shall include the total REESS current.

In case of shielded wires, appropriate methods shall be applied in accordance with the responsible authority.

In order to easily measure the REESS current using external measuring equipment, the manufacturer should provide appropriate, safe and accessible connection points in the vehicle. If that is not feasible, the manufacturer is obliged to support the responsible authority in connecting a current transducer to one of the cables directly connected to the REESS in the manner described above in this paragraph.

- 2.1.3. The current transducer output shall be sampled with a minimum frequency of 20 Hz. The measured current shall be integrated over time, yielding the measured value of Q, expressed in ampere-hours Ah. The integration may be done in the current measurement system.
- 2.2. Vehicle on-board REESS current data
As an alternative to paragraph 2.1. of this appendix, the manufacturer may use on-board REESS current measurement data. The accuracy of these data shall be demonstrated to the responsible authority.
3. REESS voltage
- 3.1. External REESS voltage measurement
During the tests described in paragraph 3. of this annex, the REESS voltage shall be measured with the equipment and accuracy requirements specified in paragraph 1.1. of this annex. To measure the REESS voltage using external measuring equipment, the manufacturers shall support the responsible authority by providing REESS voltage measurement points and safety instructions.
- 3.2. Nominal REESS voltage
For NOVC-HEVs, NOVC-FCHVs and OVC-HEVs, instead of using the measured REESS voltage according to paragraph 3.1. of this appendix, the nominal voltage of the REESS determined according to IEC 60050-482 may be used.
- 3.3. Vehicle on-board REESS voltage data
As an alternative to paragraphs 3.1. and 3.2. of this appendix, the manufacturer may use the on-board voltage measurement data. The accuracy of these data shall be demonstrated to the responsible authority.
- 3.4. Restrictions in the application of instantaneous voltage
In the following situations, the application of the instantaneous voltage according to paragraphs 3.1. and 3.3. of this appendix is prohibited and the nominal REESS voltage determined according to the standard referenced in paragraph 3.2. of this appendix shall be used:
- (a) During the development of the REESS energy change-based correction factor defined in Appendix 2 to this annex;
 - (b) For the calculation of charge-sustaining CO₂ mass emission for OVC-HEVs and NOVC-HEVs as described in paragraphs 4.1.1.3. to 4.1.1.5. inclusive of this annex;
 - (c) For the calculation of charge-sustaining fuel consumption for NOVC-FCHVs as described in paragraphs 4.2.1.2.3. to 4.2.1.2.5. inclusive of this annex.

Annex 8 - Appendix 4

Preconditioning, soaking and REESS charging conditions of PEVs and OVC-HEVs

1. This appendix describes the test procedure for REESS and combustion engine preconditioning in preparation for:
 - (a) Electric range, charge-depleting and charge-sustaining measurements when testing OVC-HEVs; and
 - (b) Electric range measurements as well as electric energy consumption measurements when testing PEVs.
2. OVC-HEV preconditioning and soaking
 - 2.1. Preconditioning and soaking when the test procedure starts with a charge-sustaining test
 - 2.1.1. For preconditioning the combustion engine, the vehicle shall be driven over at least one applicable WLTP test cycle. During each driven preconditioning cycle, the charging balance of the REESS shall be determined. The preconditioning shall be stopped at the end of the applicable WLTP test cycle during which the break-off criterion is fulfilled according to paragraph 3.2.4.5. of this annex.
 - 2.1.2. As an alternative to paragraph 2.1.1. of this appendix, at the request of the manufacturer and upon approval of the responsible authority, the state of charge of the REESS for the charge-sustaining Type 1 test may be set according to the manufacturer's recommendation in order to achieve a test under charge-sustaining operating condition.

In such a case, a preconditioning procedure, such as that applicable to pure ICE vehicles as described in paragraph 2.6. of Annex 6, shall be applied.
 - 2.1.3. Soaking of the vehicle shall be performed according to paragraph 2.7. of Annex 6.
 - 2.2. Preconditioning and soaking when the test procedure starts with a charge-depleting test
 - 2.2.1. OVC-HEVs shall be driven over at least one applicable WLTP test cycle. During each driven preconditioning cycle, the charging balance of the REESS shall be determined. The preconditioning shall be stopped at the end of the applicable WLTP test cycle during which the break-off criterion is fulfilled according to paragraph 3.2.4.5. of this annex.
 - 2.2.2. Soaking of the vehicle shall be performed according to paragraph 2.7. of Annex 6. Forced cooling down shall not be applied to vehicles preconditioned for the Type 1 test. During soak, the REESS shall be charged using the normal charging procedure as defined in paragraph 2.2.3. of this appendix.

- 2.2.3. Application of a normal charge
- Normal charging is the transfer of electricity to an electrified vehicle with a power of less than or equal to 22 kW.
- Where there are several possible methods to perform a normal AC charge (e.g. cable, induction, etc.), the charging procedure via cable shall be used.
- Where there are several AC charging power levels available, the highest normal charging power shall be used. An AC charging power lower than the highest normal AC charging power may be selected if recommended by the manufacturer.
- 2.2.3.1. The REESS shall be charged at an ambient temperature as specified in paragraph 2.2.2.2. of Annex 6 either with the on-board charger if fitted.
- In the following cases, a charger recommended by the manufacturer and using the charging pattern prescribed for normal charging shall be used if:
- (a) No on-board charger is fitted, or
 - (b) The charging time exceeds the soaking time defined in paragraph 2.7. of Annex 6.
- The procedures in this paragraph exclude all types of special charges that could be automatically or manually initiated, e.g. equalization charges or servicing charges. The manufacturer shall declare that, during the test, a special charge procedure has not occurred.
- 2.2.3.2. End-of-charge criterion
- The end-of-charge criterion is reached when the on-board or external instruments indicate that the REESS is fully charged.
3. PEV preconditioning
- 3.1. Initial charging of the REESS
- Initial charging of the REESS consists of discharging the REESS and applying a normal charge.
- 3.1.1. Discharging the REESS
- The discharge procedure shall be performed according to the manufacturer's recommendation. The manufacturer shall guarantee that the REESS is as fully depleted as is possible by the discharge procedure.
- 3.1.2. Application of a normal charge
- The REESS shall be charged according to paragraph 2.2.3.1. of this appendix.

Annex 8 - Appendix 5

Utility factors (UF) for OVC-HEVs

1. Each Contracting Party may develop its own UFs.
2. The methodology recommended for the determination of a UF curve based on driving statistics is described in SAE J2841 (Sept. 2010, Issued 2009-03, Revised 2010-09).
3. For the calculation of a fractional utility factor UF_j for the weighting of period j , the following equation shall be applied by using the coefficients from Table A8.App5/1.

$$UF_j(d_j) = 1 - \exp\left\{-\left(\sum_{i=1}^k C_i \times \left(\frac{d_j}{d_n}\right)^i\right)\right\} - \sum_{l=1}^{j-1} UF_l$$

where:

- UF_j utility factor for period j ;
- d_j measured distance driven at the end of period j , km;
- C_i i^{th} coefficient (see Table A8.App5/1);
- d_n normalized distance (see Table A8.App5/1), km;
- k number of terms and coefficients in the exponent;
- j number of period considered;
- i number of considered term/coefficient;
- $\sum_{l=1}^{j-1} UF_l$ sum of calculated utility factors up to period $(j-1)$.

Table A8.App5/1

Parameters for the regional determination of fractional UFs

| <i>Parameter</i> | <i>Europe</i> | <i>Japan</i> | <i>USA (fleet)</i> | <i>USA (individual)</i> |
|------------------|---------------|--------------|--------------------|-------------------------|
| d_n | 800 km | 400 km | 399.9 miles | 400 miles |
| C1 | 26.25 | 11.8 | 10.52 | 13.1 |
| C2 | -38.94 | -32.5 | -7.282 | -18.7 |
| C3 | -631.05 | 89.5 | -26.37 | 5.22 |
| C4 | 5964.83 | -134 | 79.08 | 8.15 |
| C5 | -25095 | 98.9 | -77.36 | 3.53 |
| C6 | 60380.2 | -29.1 | 26.07 | -1.34 |
| C7 | -87517 | NA | NA | -4.01 |
| C8 | 75513.8 | NA | NA | -3.9 |
| C9 | -35749 | NA | NA | -1.15 |
| C10 | 7154.94 | NA | NA | 3.88 |

Annex 8 - Appendix 6

Selection of driver-selectable modes

1. General requirement
 - 1.1. The manufacturer shall select the driver-selectable mode for the Type 1 test procedure according to paragraphs 2. to 4. inclusive of this appendix which enables the vehicle to follow the considered test cycle within the speed trace tolerances according to paragraph 2.6.8.3. of Annex 6. This shall apply to all vehicle systems with driver-selectable modes including those not solely specific to the transmission.
 - 1.2. The manufacturer shall provide evidence to the responsible authority concerning:
 - (a) The availability of a predominant mode under the considered conditions;
 - (b) The maximum speed of the considered vehicle;
and if required:
 - (c) The best and worst case mode identified by the evidence on the fuel consumption and, if applicable, on the CO₂ mass emission in all modes. See paragraph 2.6.6.3. in Annex 6;
 - (d) The highest electric energy consuming mode;
 - (e) The cycle energy demand (according to paragraph 5 of Annex 7 where the target speed is replaced by the actual speed).
 - 1.3. Dedicated driver-selectable modes, such as "mountain mode" or "maintenance mode" which are not intended for normal daily operation but only for special limited purposes, shall not be considered.
2. OVC-HEV equipped with a driver-selectable mode under charge-depleting operating condition

For vehicles equipped with a driver-selectable mode, the mode for the charge-depleting Type 1 test shall be selected according to the following conditions.

The flow chart in Figure A8.App6/1 illustrates the mode selection according to this paragraph.

 - 2.1. If there is a predominant mode that enables the vehicle to follow the reference test cycle under charge-depleting operating condition, this mode shall be selected.
 - 2.2. If there is no predominant mode or if there is a predominant mode but this mode does not enable the vehicle to follow the reference test cycle under charge-depleting operating condition, the mode for the test shall be selected according to the following conditions:
 - (a) If there is only one mode which allows the vehicle to follow the reference test cycle under charge-depleting operating conditions, this mode shall be selected;

- (b) If several modes are capable of following the reference test cycle under charge-depleting operating conditions, the most electric energy consuming mode of those shall be selected.
- 2.3. If there is no mode according to paragraph 2.1. and paragraph 2.2. of this appendix that enables the vehicle to follow the reference test cycle, the reference test cycle shall be modified according to paragraph 9 of Annex 1:
- (a) If there is a predominant mode which allows the vehicle to follow the modified reference test cycle under charge-depleting operating conditions, this mode shall be selected.
 - (b) If there is no predominant mode but other modes which allow the vehicle to follow the modified reference test cycle under charge-depleting operating condition, the mode with the highest electric energy consumption shall be selected.
 - (c) If there is no mode which allows the vehicle to follow the modified reference test cycle under charge-depleting operating condition, the mode or modes with the highest cycle energy demand shall be identified and the mode with the highest electric energy consumption shall be selected.
 - (d) At the option of the Contracting Party, the reference test cycle can be replaced by the applicable WLTP city test cycle and the mode with the highest electric energy consumption shall be selected.

Figure A8.App6/1

Selection of driver-selectable mode for OVC-HEVs under charge-depleting operating condition

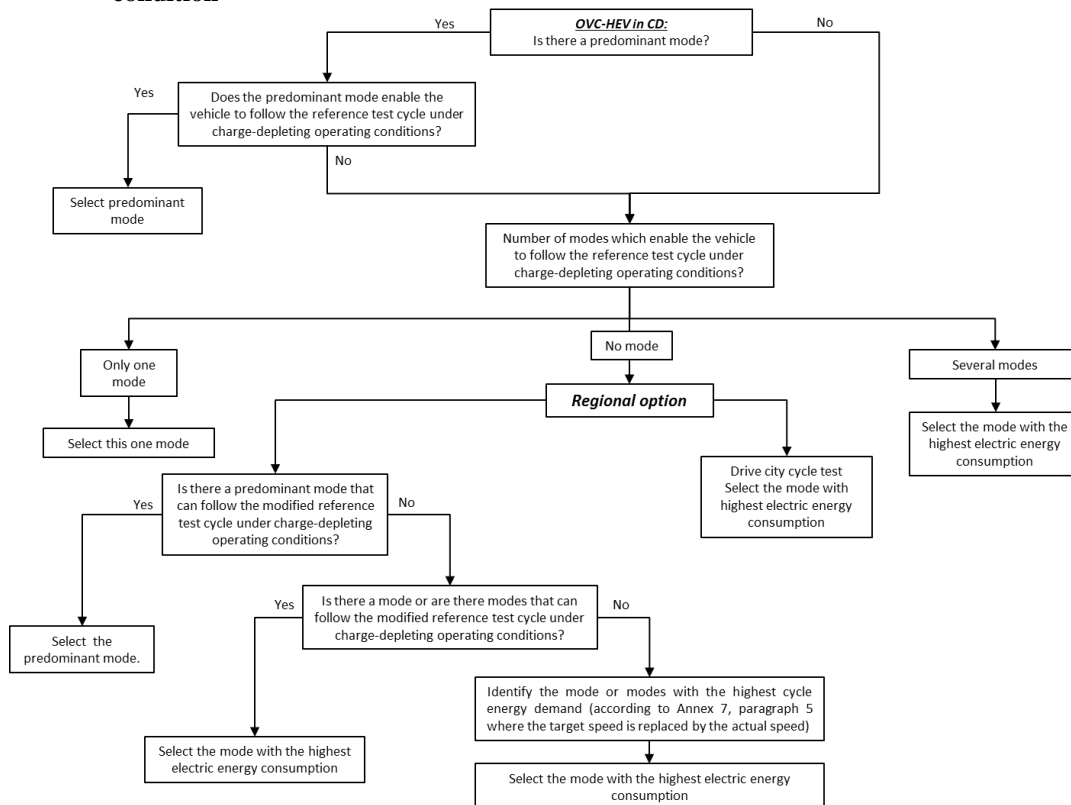

3. OVC-HEVs, NOVC-HEVs and NOVC-FCHVs equipped with a driver-selectable mode under charge-sustaining operating condition

For vehicles equipped with a driver-selectable mode, the mode for the charge-sustaining Type 1 test shall be selected according to the following conditions.

The flow chart in Figure A8.App6/2 illustrates the mode selection according to this paragraph.
- 3.1. If there is a predominant mode that enables the vehicle to follow the reference test cycle under charge-sustaining operating condition, this mode shall be selected.
- 3.2. If there is no predominant mode or if there is a predominant mode but this mode does not enable the vehicle to follow the reference test cycle under charge-sustaining operating condition, the mode for the test shall be selected according to the following conditions:
 - (a) If there is only one mode which allows the vehicle to follow the reference test cycle under charge-sustaining operating conditions, this mode shall be selected;
 - (b) If several modes are capable of following the reference test cycle under charge-sustaining operating conditions, it shall be at the option of the manufacturer either to select the worst case mode or to select both best case mode and worst case mode and average the test results arithmetically.
- 3.3. If there is no mode according to paragraph 3.1. and paragraph 3.2. of this appendix that enables the vehicle to follow the reference test cycle, the reference test cycle shall be modified according to paragraph 9. of Annex 1:
 - (a) If there is a predominant mode which allows the vehicle to follow the modified reference test cycle under charge-sustaining operating condition, this mode shall be selected.
 - (b) If there is no predominant mode but other modes which allow the vehicle to follow the modified reference test cycle under charge-sustaining operating condition, the worst case mode of these modes shall be selected.
 - (c) If there is no mode which allows the vehicle to follow the modified reference test cycle under charge-sustaining operating condition, the mode or modes with the highest cycle energy demand shall be identified and the worst case mode shall be selected.
 - (d) At the option of the Contracting Party, the reference test cycle can be replaced by the applicable WLTP city test cycle and the worst case mode shall be selected.

Figure A8.App6/2

Selection of a driver-selectable mode for OVC-HEVs, NOVC-HEVs and NOVC-FCHVs under charge-sustaining operating condition

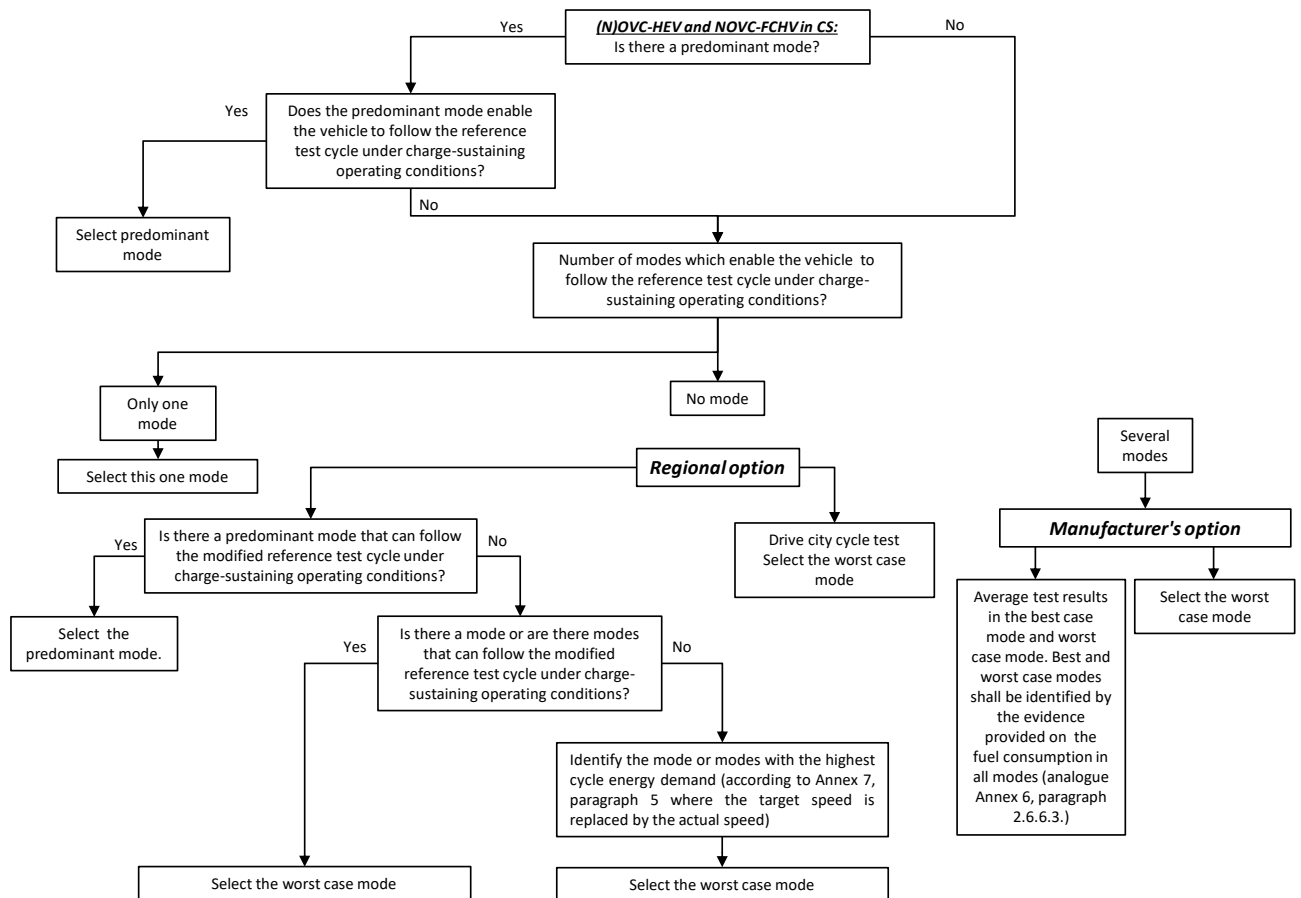

4. PEVs equipped with a driver-selectable mode

For vehicles equipped with a driver-selectable mode, the mode for the test shall be selected according to the following conditions.

The flow chart in Figure A8.App6/3 illustrates the mode selection according to this paragraph.

- 4.1. If there is a predominant mode that enables the vehicle to follow the reference test cycle, this mode shall be selected.
- 4.2. If there is no predominant mode or if there is a predominant mode but this mode does not enable the vehicle to follow the reference test cycle, the mode for the test shall be selected according to the following conditions:
 - (a) If there is only one mode which allows the vehicle to follow the reference test cycle, this mode shall be selected;
 - (b) If several modes are capable of following the reference test cycle, the most electric energy consuming mode of those shall be selected.
- 4.3. If there is no mode according to paragraph 4.1. and paragraph 4.2. of this appendix that enables the vehicle to follow the reference test cycle, the

reference test cycle shall be modified according to paragraph 9. of Annex 1. The resulting test cycle shall be named as the applicable WLTP test cycle:

- (a) If there is a predominant mode which allows the vehicle to follow the modified reference test cycle, this mode shall be selected;
- (b) If there is no predominant mode but other modes which allow the vehicle to follow the modified reference test cycle, the mode with the highest electric energy consumption shall be selected;
- (c) If there is no mode which allows the vehicle to follow the modified reference test cycle, the mode or modes with the highest cycle energy demand shall be identified and the mode with the highest electric energy consumption shall be selected;
- (d) At the option of the Contracting Party, the reference test cycle may be replaced by the applicable WLTP city test cycle and the mode with the highest electric energy consumption shall be selected.

Figure A8.App6/3
Selection of the driver-selectable mode for PEVs

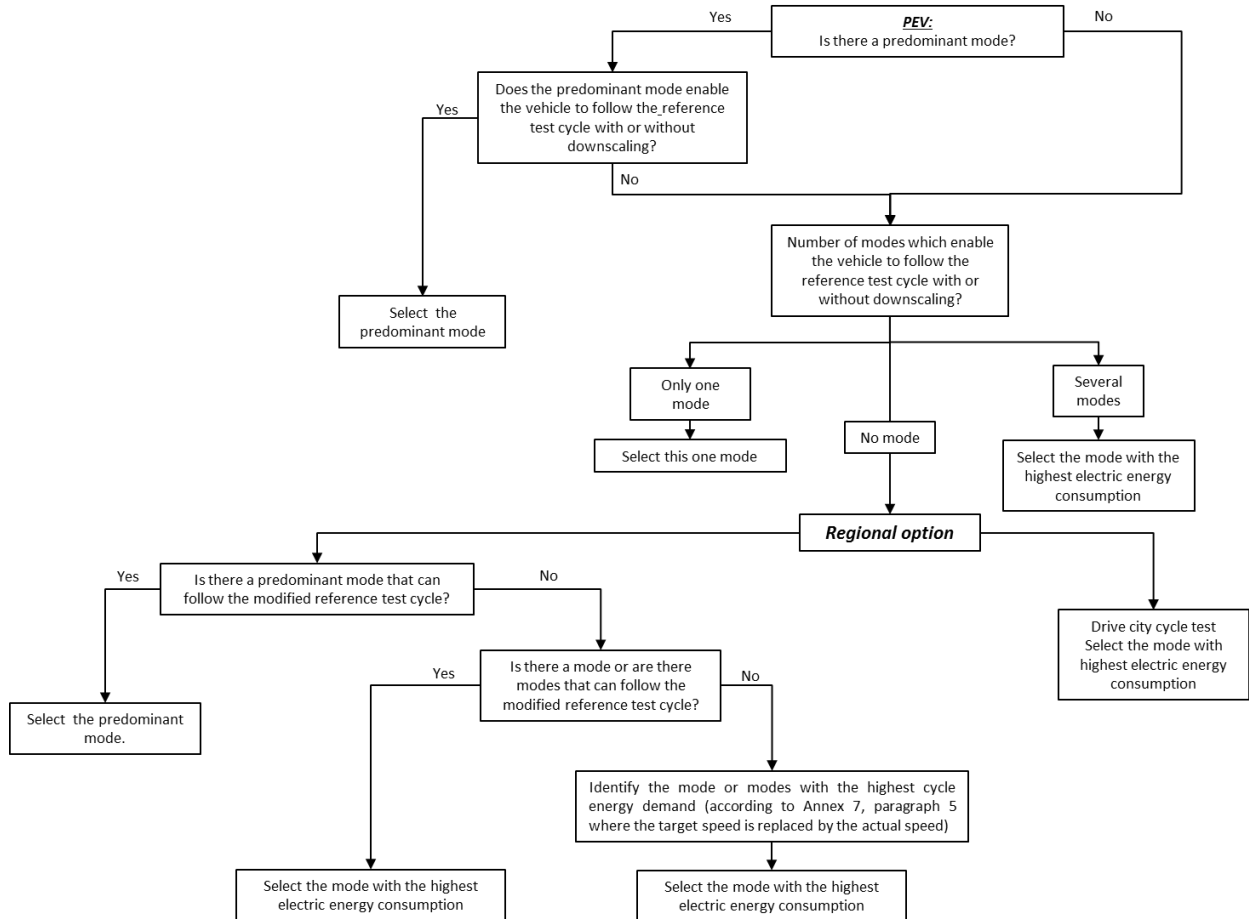

Annex 8 - Appendix 7

Fuel consumption measurement of compressed hydrogen fuel cell hybrid vehicles

1. General requirements

Fuel consumption shall be measured using the gravimetric method in accordance with paragraph 2. of this appendix.

At the request of the manufacturer and with approval of the responsible authority, fuel consumption may be measured using either the pressure method or the flow method. In this case, the manufacturer shall provide technical evidence that the method yields equivalent results. The pressure and flow methods are described in ISO 23828.
2. Gravimetric method

Fuel consumption shall be calculated by measuring the mass of the fuel tank before and after the test.

 - 2.1. Equipment and setting
 - 2.1.1. An example of the instrumentation is shown in Figure A8.App7/1. One or more off-vehicle tanks shall be used to measure the fuel consumption. The off-vehicle tank(s) shall be connected to the vehicle fuel line between the original fuel tank and the fuel cell system.
 - 2.1.2. For preconditioning, the originally installed tank or an external source of hydrogen may be used.
 - 2.1.3. The refuelling pressure shall be adjusted to the manufacturer's recommended value.
 - 2.1.4. Difference of the gas supply pressures in lines shall be minimized when the lines are switched.

In the case that influence of pressure difference is expected, the manufacturer and the responsible authority shall agree whether correction is necessary or not.
 - 2.1.5. Balance
 - 2.1.5.1. The balance used for fuel consumption measurement shall meet the specification of Table A8.App7/1.

Table A8.App7/1
Analytical balance verification criteria

| <i>Measurement system</i> | <i>Resolution</i> | <i>Precision</i> |
|---------------------------|-------------------|---------------------------------|
| Balance | 0.1 g maximum | ± 0.02 maximum ^a |

^a Fuel consumption (REESS charge balance = 0) during the test, in mass, standard deviation

- 2.1.5.2. The balance shall be calibrated in accordance with the specifications provided by the balance manufacturer or at least as often as specified in Table A8.App7/2.

Table A8.App7/2
Instrument calibration intervals

| <i>Instrument checks</i> | <i>Interval</i> |
|--------------------------|---------------------------------|
| Precision | Yearly and at major maintenance |

2.1.5.3. Appropriate means for reducing the effects of vibration and convection, such as a damping table or a wind barrier, shall be provided.

Figure A8.App7/1
Example of instrumentation

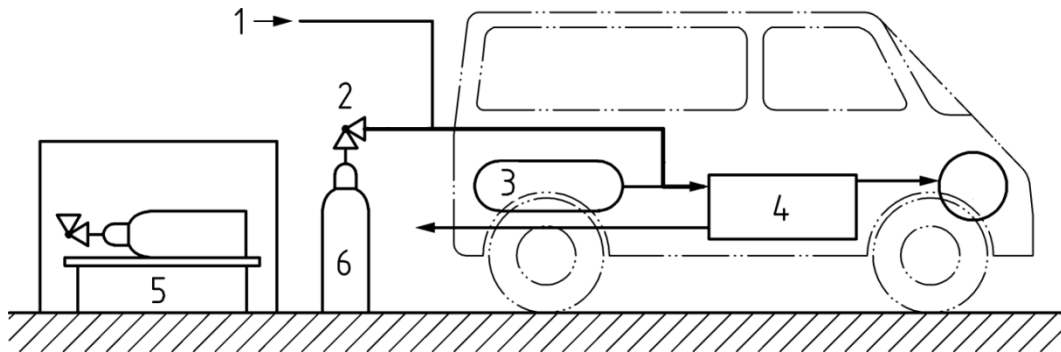

where:

- 1 is the external fuel supply for preconditioning
- 2 is the pressure regulator
- 3 is the original tank
- 4 is the fuel cell system
- 5 is the balance
- 6 is/are off-vehicle tank(s) for fuel consumption measurement

2.2. Test procedure

- 2.2.1. The mass of the off-vehicle tank shall be measured before the test.
- 2.2.2. The off-vehicle tank shall be connected to the vehicle fuel line as shown in Figure A8.App7/1.
- 2.2.3. The test shall be conducted by fuelling from the off-vehicle tank.
- 2.2.4. The off-vehicle tank shall be removed from the line.
- 2.2.5. The mass of the tank and fuel consumed after the test shall be measured.
 - 2.2.5.1. At the request of the manufacturer and with approval of the responsible authority, the change in weight of the hydrogen in the auxiliary line between points 2 and 4 in Figure A8.App7/1 due to changes in temperature and pressure may be taken into consideration.
- 2.2.6. The non-balanced charge-sustaining fuel consumption $FC_{CS,nb}$ from the measured mass before and after the test shall be calculated using the following equation:

$$FC_{CS,nb} = \frac{g_1 - g_2}{d} \times 100$$

where:

- $FC_{CS,nb}$ is the non-balanced charge-sustaining fuel consumption measured during the test, kg/100 km;
- g_1 is the mass of the tank at the start of the test, kg;
- g_2 is the mass of the tank at the end of the test, kg;
- d is the distance driven during the test, km.

- 2.2.7. If required by a Contracting Party, separate fuel consumption $FC_{CS,nb,p}$ as defined in paragraphs 4.2.1.2.4. and 4.2.1.2.5. of this annex shall be calculated for each individual phase in accordance with paragraph 2.2. of this appendix. The test procedure shall be conducted with off-vehicle tanks and connections to the vehicle fuel line which are individually prepared for each phase.

Annex 9

Determination of method equivalency

1. General requirement

Upon request of the manufacturer, other measurement methods may be approved by the responsible authority if they yield equivalent results in accordance with paragraph 1.1. of this annex. The equivalence of the candidate method shall be demonstrated to the responsible authority.
 - 1.1. Decision on equivalency

A candidate method shall be considered equivalent if the accuracy and precision is equal to or better than the reference method.
 - 1.2. Determination of equivalency

The determination of method equivalency shall be based on a correlation study between the candidate and the reference methods. The methods to be used for correlation testing shall be subject to approval by the responsible authority.

The basic principle for the determination of accuracy and precision of candidate and reference methods shall follow the guidelines in ISO 5725 Part 6 Annex 8 "Comparison of alternative Measurement Methods".
 - 1.3. Implementation requirements (RESERVED)
-