

30 December 2022

Agreement

Concerning the Adoption of Harmonized Technical United Nations Regulations for Wheeled Vehicles, Equipment and Parts which can be Fitted and/or be Used on Wheeled Vehicles and the Conditions for Reciprocal Recognition of Approvals Granted on the Basis of these United Nations Regulations *

(Revision 3, including the amendments which entered into force on 14 September 2017)

Addendum 97: UN Regulation No. 98

Revision 4

Incorporating all valid text up to:

Supplement 2 to the 01 series of amendments - Date of entry into force: 26 July 2012

Corrigendum 1 to Revision 3 of the Regulation – Date of entry into force: 14 November 2012

Supplement 3 to the 01 series of amendments - Date of entry into force: 18 November 2012

Supplement 4 to the 01 series of amendments – Date of entry into force: 15 July 2013

Supplement 5 to the 01 series of amendments – Date of entry into force: 15 June 2015

Supplement 6 to the 01 series of amendments – Date of entry into force: 8 October 2015

Supplement 7 to the 01 series of amendments – Date of entry into force: 18 June 2016

Supplement 8 to the 01 series of amendments – Date of entry into force: 10 October 2017

Supplement 9 to the 01 series of amendments – Date of entry into force: 10 February 2018

02 series of amendments – Date of entry into force: 15 October 2019

Supplement 1 to the 02 series of amendments – Date of entry into force: 29 May 2020

Uniform provisions concerning the approval of motor vehicle headlamps equipped with gas-discharge light sources

* Former titles of the Agreement:

Agreement concerning the Adoption of Uniform Conditions of Approval and Reciprocal Recognition of Approval for Motor Vehicle Equipment and Parts, done at Geneva on 20 March 1958 (original version); Agreement concerning the Adoption of Uniform Technical Prescriptions for Wheeled Vehicles, Equipment and Parts which can be Fitted and/or be Used on Wheeled Vehicles and the Conditions for Reciprocal Recognition of Approvals Granted on the Basis of these Prescriptions, done at Geneva on 5 October 1995 (Revision 2).

This document is meant purely as documentation tool. The authentic and legal binding texts are:



ECE/TRANS/WP.29/2011/100, ECE/TRANS/WP.29/2012/15, ECE/TRANS/WP.29/2012/61,
ECE/TRANS/WP.29/2012/80, ECE/TRANS/WP.29/2013/90/Rev.1, ECE/TRANS/WP.29/2015/27,
ECE/TRANS/WP.29/2015/80, ECE/TRANS/WP.29/2017/35, ECE/TRANS/WP.29/2017/85,
ECE/TRANS/WP.29/2018/114/Rev.1, ECE/TRANS/WP.29/2019/89. _____

UNITED NATIONS

UN Regulation No. 98

Uniform provisions concerning the approval of motor vehicle headlamps equipped with gas-discharge light sources

Contents

Page

Regulation

A.	Administrative provisions	5
	Scope	5
1.	Definitions.....	5
2.	Application for approval of a headlamp.....	6
3.	Markings	7
4.	Approval.....	8
B.	Technical requirements for headlamps.....	11
5.	General specifications	11
6.	Illumination	13
7.	Gauging of discomfort and/or disability.....	19
C.	Further administrative provisions.....	19
8.	Modification of the headlamp type and extension of approval	19
9.	Conformity of production.....	20
10.	Penalties for non-conformity of production	21
11.	Production definitively discontinued.....	21
12.	Names and addresses of Technical Services responsible for conducting approval tests, and of Type Approval Authorities.....	21
13.	Transitional provisions.....	21

Annexes

1	Communication concerning the approval or extension or refusal or withdrawal of approval or production definitively discontinued of a type of headlamp pursuant to UN Regulation No. 98.....	23
2	Examples of arrangements of approval marks	25
3	Spherical coordinate measuring system and test point locations.....	34
4	Tests for stability of photometric performance of headlamps in operation	37
	Appendix: Overview of operational periods concerning test for stability of photometric performance	42

5	Requirements for lamps incorporating lenses of plastic material – Testing of lens or material samples and of complete lamps	43
	Appendix 1: Chronological order of approval tests.....	48
	Appendix 2: Method of measurement of the diffusion and transmission of light	50
	Appendix 3: Spray testing method	52
	Appendix 4: Adhesive tape adherence test.....	53
6	Centre of reference	54
7	Voltage markings	55
8	Minimum requirements for conformity of production control procedures.....	56
9	Minimum requirements for sampling by an inspector.....	59
10	Instrumental verification of the "cut-off" for passing beam headlamps	62
11	Requirements for LED modules and headlamps including LED modules	66

A. Administrative provisions

Scope¹

This Regulation applies to headlamps utilizing gas-discharge light sources, for vehicles of categories, M and N and L3.

1. Definitions

For the purpose of this Regulation,

- 1.1. The definitions given in UN Regulation No. 48 and its series of amendments in force at the time of application for type approval shall apply to this Regulation.
- 1.2. "*Lens*" means the outermost component of the headlamp (unit) which transmits light through the illuminating surface;
- 1.3. "*Coating*" means any product or products applied in one or more layers to the outer face of a lens;
- 1.4. "*Matched pair*" means the set of lamps of the same function on the left- and right-hand side of the vehicle;
- 1.5. Headlamps of different "types" are headlamps which differ in such essential respects as:
 - 1.5.1. The trade name or mark:
 - (a) Lamps bearing the same trade name or mark but produced by different manufacturers shall be considered as being of different types;
 - (b) Lamps produced by the same manufacturer differing only by the trade name or mark shall be considered as being of the same type.
 - 1.5.2. The characteristics of the optical system;
 - 1.5.3. The inclusion or elimination of components capable of altering the optical effects by reflection, refraction, absorption and/or deformation during operation
 - 1.5.4. Suitability for right-hand or left-hand or for both traffic systems;
 - 1.5.5. The kind of beam produced (passing-beam or driving-beam or both);
 - 1.5.6. However, a device intended for the installation on the left side of the vehicle and the corresponding device intended for the installation on the right side of the vehicle shall be considered to be of the same type.
- 1.7. References made in this Regulation to standard (étalon) filament light source(s) and gas-discharge light source(s) shall refer to Regulations Nos. 37 and 99 respectively, and to their series of amendments in force at the time of application for type approval.

¹ Nothing in this Regulation shall prevent a Contracting Party to the Agreement applying this Regulation from prohibiting the combination of a headlamp approved "PL" (Plastic Lens) under this Regulation with a mechanical headlamp-cleaning device (i.e. with wipers) on vehicles which it registers.

2. Application for approval of a headlamp²

- 2.1. The application for approval shall be submitted by the owner of the trade name or mark of the headlamp or by his duly accredited representative. It shall specify:
 - 2.1.1. Whether the headlamp is intended to provide a passing beam, a driving beam or both;
 - 2.1.2. Whether, if the headlamp is intended to provide a passing beam, it is designed for both left-hand and right-hand traffic or for either left-hand or right-hand traffic only;
 - 2.1.3. If the headlamp is equipped with an adjustable reflector, the mounting position(s) of the headlamp in relation to the ground and the longitudinal median plane of the vehicle;
 - 2.1.4. The maximum vertical angles above and below the nominal position(s) which the aiming device can achieve;
 - 2.1.5. Which light sources are energized when the various beam combinations are used and, in case of a light source category with more than one objective luminous flux value, which objective luminous flux value is used;
 - 2.1.6. The category of light source as listed in Regulations Nos. 37 or 99 and their series of amendments in force at the time of application for type approval and, in case of a light source category with more than one objective luminous flux value, which objective luminous flux value is used for passing beam and for driving beam;
- 2.2. Every application shall be accompanied by:
 - 2.2.1. Drawings in triplicate in sufficient detail to permit identification of the type (see paragraphs 3.2. and 4.2. below). The drawings must show the position intended for the approval number and the additional symbols in relation to the circle of the approval mark, in case of LED module(s) also the space reserved for the specific identification code(s) of the module(s), and must show the headlamp in vertical (axial) section and in front elevation, with main details of the optical design including the flutings, if applicable.
 - 2.2.2. A brief technical specification including, where it applies, the make and type of the ballast(s) and, in the case where the headlamp is used to produce bend lighting, the extreme positions according to paragraph 6.2.7. below. In the case of LED module(s) this shall include:
 - (a) A brief technical specification of the LED module(s);
 - (b) A drawing with dimensions and the basic electrical and photometric values and the objective luminous flux.
 - 2.2.3. Samples, as follows:
 - 2.2.3.1. For approval of a headlamp, two samples of each type of headlamp, one sample intended for the installation on the left side of the vehicle and one sample intended for the installation on the right side of the vehicle, with standard gas-discharge light source and one ballast of each type to be used, where applicable.
 - 2.2.4. For the test of plastic material of which the lenses are made:
 - 2.2.4.1. Fourteen lenses;
 - 2.2.4.1.1. Ten of these lenses may be replaced by 10 samples of material, at least 60 x 80 mm in size, having a flat or convex outer surface and a

² For gas-discharge light sources see UN Regulation No. 99.

- substantially flat area (radius of curvature not less than 300 mm) in the middle measuring at least 15 x 15 mm.
- 2.2.4.1.2. Every such lens or sample of material shall be produced by the method to be used in mass production;
- 2.2.4.2. A reflector to which the lenses can be fitted in accordance with the manufacturer's instructions.
- 2.2.5. For testing the UV-resistance of light transmitting components made of plastic material against UV radiation of gas-discharge light sources inside the headlamp:
- 2.2.5.1. One sample each of the relevant material as being used in the headlamp or one headlamp sample containing these. Each material sample shall have the same appearance and surface treatment – if any – as intended for use in the headlamp to be approved.
- 2.2.5.2. The UV-resistance testing of internal materials to light source radiation is not necessary:
- 2.2.5.2.1. If low-UV-type gas-discharge light sources are being applied as specified in UN Regulation No. 99, or;
- 2.2.5.2.2. If provisions are taken to shield the relevant headlamp components from UV radiation, e.g. by glass filters, or;
- 2.2.5.2.3. If low-UV-type LED modules are being applied as specified in Annex 11 of this Regulation.
- 2.3. The materials making up the lens shall be accompanied by the test report of the characteristics of these materials and coatings if they have already been tested.
- 2.4. In the case of a type of lamp differing only by the trade name or mark from a type that has already been approved it shall be sufficient to submit:
- 2.4.1. A declaration by the lamp manufacturer that the type submitted is identical (except in the trade name or mark) with and has been produced by the same manufacturer as, the type already approved, the latter being identified by its approval code;
- 2.4.2. Two samples bearing the new trade name or mark or equivalent documentation.

3. Markings

- 3.1. Headlamps submitted for approval shall bear legibly and indelibly the trade name or mark of the applicant.
- 3.2. They shall comprise, on the lens and on the main body³, spaces of sufficient size for the approval mark and the additional symbols referred to in paragraph 4.; these spaces shall be indicated on the drawings referred to in paragraph 2.2.1. above.
- 3.3. Headlamps designed to satisfy the requirements of both right-hand and left-hand traffic shall bear markings indicating the two settings of the optical unit on the vehicle or of the gas-discharge light source on the reflector; these markings shall consist of the letters "R/D" for the position for right-hand traffic and the letters "L/G" for the position for left-hand traffic.
- 3.4. All beams may bear on their light-emitting surface a centre of reference as shown in Annex 6.

³ If the lens cannot be detached from the main body of the headlamp, a unique marking as per paragraph 4.2.5. shall be sufficient.

- 3.5. In the case of lamps with LED module(s), the lamp shall bear the marking of the rated voltage and rated wattage and the light source module specific identification code.
- 3.6. LED module(s) submitted along with the approval of lamp:
- 3.6.1. Shall bear the trade name or mark of the applicant. This marking shall be clearly legible and indelible;
- 3.6.2. Shall bear the specific identification code of the module. This marking shall be clearly legible and indelible.
- This specific identification code shall comprise the starting letters "MD" for "MODULE" followed by the approval marking without the circle as prescribed in paragraph 4.2.1. below and in the case several non identical light source modules are used, followed by additional symbols or characters. This specific identification code shall be shown in the drawings mentioned in paragraph 2.2.1. above. The approval marking does not have to be the same as the one on the lamp in which the module is used, but both markings shall be from the same applicant.
- 3.7. If an electronic light source control gear which is not part of a LED module is used to operate a LED module(s), it shall be marked with its specific identification code(s), the rated input voltage and wattage.

4. Approval

- 4.1. General
- 4.1.1. If all the samples of a type of headlamp submitted pursuant to paragraph 2. above satisfy the provisions of this Regulation, approval shall be granted.
- 4.1.2. Headlamps conforming to this Regulation may be grouped, combined or reciprocally incorporated with any other lighting or light-signalling function(s) provided that their respective lighting functions are not impaired.
- 4.1.3. Where grouped, combined or reciprocally incorporated lamps satisfy the requirements of more than one Regulation, a single international approval mark may be affixed provided that each of the grouped, combined or reciprocally incorporated lamps satisfies the provisions applicable to it.
- 4.1.4. An approval number shall be assigned to each type approved. Its first two digits shall indicate the series of amendments incorporating the most recent major technical amendments made to the Regulation at the time of issue of the approval (at present 01).⁴ The same Contracting Party may not assign the same number to another type of headlamp covered by this Regulation. However, the matched pair is considered to be one type.
- 4.1.5. Notice of approval or of extension or refusal or withdrawal of approval or production definitively discontinued of a type of headlamp pursuant to this Regulation shall be communicated to the Parties to the 1958 Agreement applying this Regulation, by means of a communication form conforming to the model in Annex 1 to this Regulation.
- 4.1.6. In addition to the mark prescribed in paragraph 3.1., an approval mark as described in paragraphs 4.2. and 4.3. below shall be affixed in the spaces referred to in paragraph 3.2. above to every headlamp conforming to a type approved under this Regulation.
- 4.2. Composition of the approval mark
- The approval mark shall consist of:

⁴ The 02 series of amendments does not require changes in the approval number (TRANS/WP.29/815, para. 82).

-
- 4.2.1. An international approval marking, comprising:
- 4.2.1.1. A circle surrounding the letter "E" followed by the distinguishing number of the country which has granted approval⁵;
- 4.2.1.2. The approval number prescribed in paragraph 4.1.4. above;
- 4.2.2. The following additional symbol or symbols:
- 4.2.2.1. On headlamps meeting left-hand traffic requirements only, a horizontal arrow pointing to the right of an observer facing the headlamp, i.e. to the side of the road on which the traffic moves;
- 4.2.2.2. On headlamps designed to meet the requirements of both traffic systems by means of an appropriate adjustment of the setting of the optical unit or the light source, a horizontal arrow with a head at each end, the heads pointing respectively to the left and to the right;
- 4.2.2.3. On headlamps meeting the requirements of this Regulation in respect of the passing beam only, the letter "DC";
- 4.2.2.4. On headlamps meeting the requirements of this Regulation in respect of the driving beam only, the letter "DR";
- 4.2.2.5. On headlamps meeting the requirements of this Regulation in respect of both the passing beam and the driving beam, the letters "DCR";
- 4.2.2.6. On headlamps incorporating a lens of plastic material, the letters "PL" to be affixed near the symbols prescribed in paragraphs 4.2.2.3. to 4.2.2.5. above;
- 4.2.2.7. On headlamps meeting the requirements of this Regulation in respect of the driving beam, an indication of the maximum luminous intensity expressed by a reference mark as defined in paragraph 6.3.2.2. below, placed near the circle surrounding the letter "E";
- In the case of reciprocally incorporated headlamps, indication of the maximum luminous intensity of the driving beam as a whole shall be expressed as above.
- 4.2.3. In every case the relevant operating mode used during the test procedure according to paragraph 1.1.1.1. of Annex 4 and the allowed voltage(s) according to paragraph 1.1.1.2. of Annex 4 shall be stipulated on the approval forms and on the communication forms transmitted to the countries which are Contracting Parties to the Agreement and which apply this Regulation.
- In the corresponding cases the device shall be marked as follows:
- 4.2.3.1. On headlamps meeting the requirements of this Regulation which are so designed that the passing beam shall not be lit simultaneously with that of any other lighting function with which it may be reciprocally incorporated: an oblique stroke (/) shall be placed behind symbol indicating the headlamp producing the passing beam in the approval mark.
- 4.2.3.2. The requirement in paragraph 4.2.3.1. above shall not apply to headlamps meeting the requirements of this Regulation which are so designed that the passing beam and the driving beam are provided by the same gas-discharge light source.
- 4.2.4. The two digits of the approval number which indicate the series of amendments incorporating the most recent major technical amendments made to the Regulation at the time of issue of the approval and, if necessary, the required arrow may be marked close to the above additional symbols.
- 4.2.5. The marks and symbols referred to in paragraphs 4.2.1. to 4.2.3. above shall be clearly legible and be indelible. They may be placed on an inner or outer

⁵ The distinguish numbers of the Contracting Parties to the 1958 Agreement are reproduced in Annex 3 to Consolidated Resolution on the Construction of Vehicles (R.E.3) (ECE/TRANS/WP.29/78/Rev.6).

- part (transparent or not) of the headlamp, which cannot be separated from the transparent part of the headlamp emitting the light.
- 4.3. Arrangement of the approval mark
- 4.3.1. Independent lamps
- Figures 1 to 9, Annex 2, to this Regulation give examples of arrangements of the approval marks with the above-mentioned additional symbols.
- 4.3.2. Grouped, combined or reciprocally incorporated lamps
- 4.3.2.1. Where grouped, combined or reciprocally incorporated lamps have been found to comply with the requirements of several Regulations, a single international approval mark may be affixed, consisting of a circle surrounding the letter "E" followed by the distinguishing number of the country which has granted the approval, and an approval number. This approval mark may be located anywhere on the grouped, combined or reciprocally incorporated lamps, provided that:
- 4.3.2.1.1. It is visible as per paragraph 4.2.5.
- 4.3.2.1.2. No part of the grouped, combined or reciprocally incorporated lamps that transmits light can be removed without at the same time removing the approval mark.
- 4.3.2.2. The identification symbol for each lamp appropriate to each Regulation under which approval has been granted, together with the corresponding series of amendments incorporating the most recent major technical amendments to the Regulations at the time of issue of the approval and, if necessary, the required arrow shall be marked:
- 4.3.2.2.1. Either on the appropriate light-emitting surface;
- 4.3.2.2.2. Or in a group, in such a way that each of the grouped, combined or reciprocally incorporated lamps may be clearly identified (see possible examples in Annex 2, figures 10, 11, 12).
- 4.3.2.3. The size of the components of a single approval mark shall not be less than the minimum size required by the Regulation under which approval has been granted for the smallest of the individual marks.
- 4.3.2.4. An approval number shall be assigned to each type approved. The same Contracting Party may not assign the same number to another type of grouped, combined or reciprocally incorporated lamps covered by this Regulation.
- 4.3.2.5. Annex 2, figures 10, 11, 12 of this Regulation give examples of arrangements of approval marks for grouped, combined or reciprocally incorporated lamps with all the above-mentioned additional symbols.
- 4.3.3. Lamps, the lens of which are used for different types of headlamps and which may be reciprocally incorporated or grouped with other lamps
- The provisions laid down in paragraph 4.3.2. above are applicable.
- 4.3.3.1. In addition, where the same lens is used, the latter may bear the different approval marks relating to the different types of headlamps or units of lamps, provided that the main body of the headlamp, even if they cannot be separated from the lens, also comprises the space described in paragraph 3.2. above, and bears the approval mark of the actual functions.
- 4.3.3.2. Annex 2, Figure 10 of this Regulation gives examples of arrangements of approval marks relating to the above case.

B. Technical requirements for headlamps⁶

5. General specifications

The requirements contained in sections 5. "General specifications" and 6. "Individual specifications" and in the Annexes referenced in the said sections of UN Regulations Nos. 48, 53 or 86, and their series of amendments in force at the time of application for the lamp type approval shall apply to this Regulation.

The requirements pertinent to each lamp and to the category/ies of vehicle on which the lamp is intended to be installed shall be applied, where its verification at the moment of lamp type approval is feasible.

5.1. Each sample shall comply with the specifications set forth in paragraphs 6. to 8. below.

5.2. Headlamps shall be so made as to retain their prescribed photometric characteristics and to remain in good working order when in normal use, in spite of the vibrations to which they may be subjected.

5.2.1. Headlamps shall be fitted with a device enabling them to be so adjusted on the vehicle as to comply with the rules applicable to them. Such a device need not be fitted on units in which the reflector and the diffusing lens cannot be separated, provided the use of such units is confined to vehicles on which the headlamps setting can be adjusted by other means.

Where a headlamp providing a principal passing beam and a headlamp providing a driving beam, each equipped with its own light source(s), are assembled to form a composite unit, the adjusting device shall enable each optical system individually to be duly adjusted. The same provision applies to headlamps providing a front fog lamp beam and a driving beam, and to headlamps providing a principal passing beam and a front fog lamp beam, and to headlamps providing these three beams.

5.2.2. However, these provisions shall not apply to headlamp assemblies whose reflectors are indivisible. For this type of assembly, the requirements of paragraph 6.3. of this Regulation shall apply.

5.3. Headlamps designed to satisfy the requirements of both right-hand and of left-hand traffic may be adapted for traffic on a given side of the road either by an appropriate initial setting when fitted on the vehicle or by selective setting by the user. Such initial or selective setting may consist, for example, of fixing either the optical unit at a given angle on the vehicle or the light source(s) at a given angle in relation to the optical unit. In all cases, only two different and clearly distinct settings, one for right-hand and one for left-hand traffic, shall be possible, and the design shall preclude inadvertent shifting from one setting to the other or setting in an intermediate position. Where two different setting positions are provided for the light source, the components for attaching the light source to the reflector must be so designed and made that, in each of its two settings, the light source will be held in position with the precision required for headlamps designed for traffic on only one side of the road. Conformity with the requirements of this paragraph shall be verified by visual inspection and, where necessary, by a test fitting.

5.4. Illumination configuration for different traffic conditions

5.4.1. In the case of headlamps designed to meet the requirements of traffic moving on one side of the road (either right or left) only, appropriate measures shall be taken to prevent discomfort to road-users in a country where traffic moves

⁶ Technical requirements for gas-discharge light sources: see UN Regulation No. 99.

- on the side of the road opposite to that of the country for which the headlamp was designed⁷. Such measures may be:
- (a) Occulting a part of the outer headlamp lens area;
 - (b) Downward movement of the beam. Horizontal movement is allowed;
 - (c) Any other measure to remove or reduce the asymmetrical part of the beam.
- 5.4.2. Following the application of this (these) measure(s) the following requirements regarding the luminous intensity of the headlamp shall be met with the adjustment left unchanged compared to that for the original traffic direction:
- 5.4.2.1. Passing beam designed for right-hand traffic and adapted to left-hand traffic:
- At 0.86D-1.72L at least 2,500 cd;
 - At 0.57U-3.43R not more than 880 cd.
- 5.4.2.2. Passing beam designed for left-hand traffic and adapted to right-hand traffic:
- At 0.86D-1.72R at least 2,500 cd;
 - At 0.57U-3.43L not more than 880 cd.
- 5.5. On headlamps designed to provide alternately a driving beam and a passing beam or a passing beam and/or a driving beam designed to become a bend lighting, any mechanical, electro-mechanical or other device incorporated in the headlamp for these purposes⁸ must be so constructed that:
- 5.5.1. The device is robust enough to withstand 50,000 operations under normal conditions of use. In order to verify compliance with this requirement, the Technical Service responsible for approval tests may:
- (a) Require the applicant to supply the equipment necessary to perform the test;
 - (b) Forego the test if the headlamp presented by the applicant is accompanied by a test report, issued by a Technical Service responsible for approval tests for headlamps of the same construction (assembly), confirming compliance with this requirement.
- 5.5.2. In the case of failure the luminous intensity of the headlamp above the line H-H shall not exceed the values of a passing beam according to paragraph 6.2.6.; in addition, on headlamps designed to provide a passing and/or a driving beam to become a bend lighting, a luminous intensity of at least 2,500 cd shall be fulfilled in test point 25 V (VV line, 1.72 D).
- 5.5.3. Either the principal passing beam or the driving beam can always be obtained without any possibility of the mechanism stopping in between the two positions;
- 5.5.4. The user cannot, with ordinary tools, change the shape or position of the moving parts.
- 5.6. Complementary tests shall be done according to the requirements of Annex 4 to ensure that in use there is no excessive change in photometric performance.
- 5.7. Light transmitting components made of plastic material shall be tested according to the requirements of Annex 5.
- 5.8. Light sources

⁷ Instructions on the installation of lamps fitted with these measures are given in UN Regulation No. 48.

⁸ These provisions shall not apply to the control switch.

-
- 5.8.1. Gas-discharge headlamps shall only be equipped with replaceable gas-discharge light source(s) approved according to UN Regulation No. 99 and its series of amendments in force at the time of application for type approval.
- 5.8.2. In the case that one or more (additional) filament light sources are used in the gas-discharge headlamp, the gas-discharge headlamp shall only be equipped with these filament light sources that shall be replaceable and approved according to UN Regulation No. 37 and its series of amendments in force at the time of application for type approval, provided that no restriction on the use is made in UN Regulation No. 37 and its series of amendments in force at the time of application for type approval.
- 5.8.3. The design of the device shall be such that the light source(s) can be fixed in no other position but the correct one.
- 5.8.4. The lamp holder shall conform to the dimensional characteristics as given on the data sheet of IEC Publication 60061, relevant to the category of light source(s) used. The light source(s) shall fit easily into the headlamp.
- 5.9. The headlamp and ballast system shall not generate radiated or power line disturbances to cause a malfunction of other electric/electronic systems of the vehicle⁹.
- 5.10. If it is necessary for the test procedure, the test house may require from the manufacturer additional test samples, test benches (holders) or special power supplies.
- 5.11. The test procedure shall be carried out under the mounting specifications of the manufacturer.
- 5.12. The headlamp (if equipped with LED modules) and the LED module(s) themselves shall comply with the relevant requirements specified in Annex 11 of this Regulation. The compliance with the requirements shall be tested.
- 5.13. Instead of requirements of this Regulation, headlamps may conform with requirements of the latest version of UN Regulation No. 149 as it relates to headlamps equipped with gas-discharge light sources.

6. Illumination

- 6.1. General provisions
- 6.1.1. Headlamps shall be so made that with suitable gas-discharge light source they give adequate illuminance without dazzle when emitting the passing-beam and good illumination when emitting the driving-beam.
- 6.1.2. The luminous intensity produced by the headlamp shall be measured at 25 m distance by means of a photoelectric cell having a useful area comprised within a square of 65 mm side. The point HV is the centre-point of the coordinate system with a vertical polar axis. Line h is the horizontal through HV (see Annex 3 to this Regulation).
- 6.1.3. The headlamp shall be deemed satisfactory if the photometric requirements set in the present paragraph 6. are met with one light source, which has been aged during at least 15 cycles, in accordance with Annex 4, paragraph 4. of UN Regulation No. 99.

It shall be a standard (étalon) light-source approved according to UN Regulation No. 99 and its luminous flux may differ from the objective luminous flux specified in UN Regulation No. 99. In this case, the luminous intensities shall be corrected accordingly.

⁹ Compliance with the requirements for electromagnetic compatibility is relevant to the individual vehicle type.

- If a gas-discharge light source category is used with more than one objective luminous flux value, the applicant shall choose one of the objective luminous flux values as indicated in the relevant data sheet of UN Regulation No. 99 and a reference stating which objective flux was chosen for type approval shall be made in items 9.4.1. and 9.4.2. of the communication form of Annex 1.
- 6.1.4. The dimensions determining the position of the arc inside the standard gas-discharge light source are shown in the relevant data sheet of UN Regulation No. 99.
- 6.1.5. Photometric compliance must be checked in accordance with paragraph 6.2.6. or 6.3. of this Regulation. This is also valid for the cut-off zone between 3°R and 3°L (measurement method for the cut-off colour being under consideration).
- 6.1.6. The colour of the light of the beams emitted by headlamps using gas-discharge light sources shall be white.
- 6.1.7. Four seconds after ignition of a headlamp, equipped with a gas discharge light source with the ballast not integrated with the light source, and that has not been operated for 30 minutes or more:
- 6.1.7.1. At least 37,500 cd shall be attained at point HV, for a headlamp producing driving beam only.
- 6.1.7.2. At least 6,250 cd shall be attained at point 50V for headlamps producing passing beam only or alternately passing and driving beam functions as described in paragraph 5.4. of this Regulation.
- 6.1.7.3. In either case the power supply shall be sufficient to secure the required rise of the high current pulse.
- 6.2. Provisions concerning passing beams
- 6.2.1. The luminous intensity distribution of the passing beam headlamp shall incorporate a "cut-off" (see Figure 1 below), which enables the headlamp to be adjusted correctly for the photometric measurements and for the aiming on the vehicle.
- The "cut-off" shall provide:
- (a) For right hand traffic beams:
- (i) A straight "horizontal part" towards the left;
- (ii) A raised "elbow - shoulder" part towards the right.
- (b) For left hand traffic beams:
- (i) A straight "horizontal part" towards the right;
- (ii) A raised "elbow – shoulder" part towards the left.
- In each case the "elbow – shoulder" part shall have a sharp edge.
- 6.2.2. The headlamp shall be visually aimed by means of the "cut-off" (see Figure 1) as follows. The aiming shall be carried out using a flat vertical screen set up at a distance of 10 m or 25 m (as indicated in section 9 of Annex 1) forward of the headlamp and at right angles to the H-V axis as shown in Annex 3 to this Regulation. The screen shall be sufficiently wide to allow examination and adjustment of the "cut-off" of the passing beam over at least 5° on either side of the V-V line.
- 6.2.2.1. For vertical adjustment: the horizontal part of the "cut-off" is moved upward from below line B and adjusted to its nominal position one per cent (0.57 degrees) below the H-H line;

Figure 1

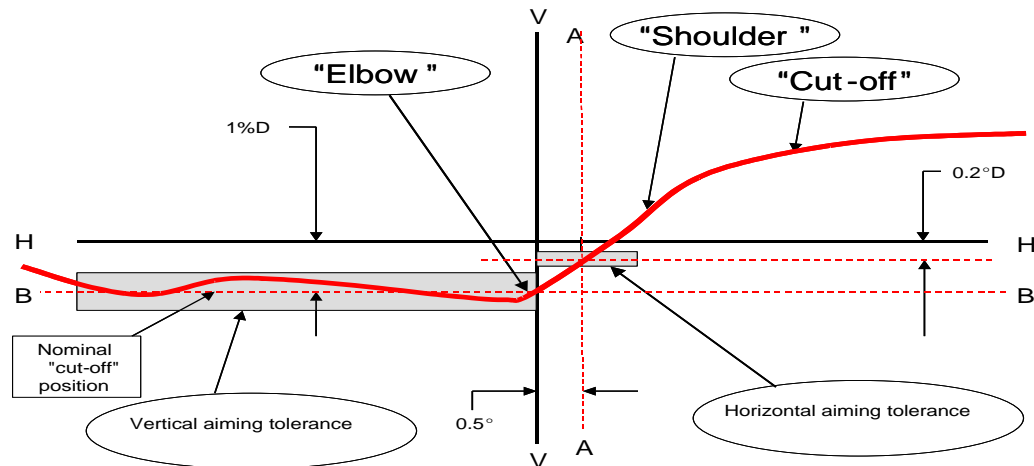

Note: The scales are different for vertical and horizontal lines.

6.2.2.2. For horizontal adjustment: the "elbow-shoulder" part of the "cut-off" shall be moved:

For right hand traffic from right to left and shall be horizontally positioned after its movement so that:

- (a) Above the line $0.2^\circ D$ its "shoulder" shall not exceed the line A to the left and
- (b) On the line $0.2^\circ D$ or below its "shoulder" should cross the line A and
- (c) The kink of the "elbow" is basically located within ± 0.5 degrees to the left or right of the V-V line;

Or

For left hand traffic from left to right and shall be horizontally positioned after its movement so that:

- (a) Above the line $0.2^\circ D$ its "shoulder" shall not exceed the line A to the right and
- (b) On the line $0.2^\circ D$ or below its "shoulder" should cross the line A and
- (c) The kink of "elbow" should be primarily on the V-V line.

6.2.2.3. Where a headlamp so aimed does not meet the requirements set out in paragraphs 6.2.5., 6.2.6. and 6.3., its alignment may be changed, provided that the axis of the beam is not displaced:

Horizontally from line A by more than:

- (a) 0.5° to the left or 0.75° to the right, for right hand traffic or
- (b) 0.5° to the right or 0.75° to the left, for left hand traffic and

Vertically not more than 0.25° up or down from line B.

6.2.2.4. If, however, vertical adjustment cannot be performed repeatedly to the required position within the tolerances described in paragraph 6.2.2.3. above, the instrumental method of Annex 10, paragraphs 2. and 3. shall be applied to test compliance with the required minimum quality of the "cut-off" and to perform the vertical and horizontal adjustment of the beam.

6.2.3. When so aimed, the headlamp needs, if its approval is sought solely for a passing beam, to comply only with the requirements referred to in paragraphs 6.2.4. and 6.2.5. below; if it is intended to provide both a passing beam and a driving beam, it shall comply with the requirements set out in paragraphs 6.2.4. to 6.2.6.

- 6.2.4. Only one gas-discharge light source is permitted for each passing beam headlamp. A maximum of two additional light sources are permitted as follows:
- 6.2.4.1. One additional light source according to UN Regulation No. 37 or one or more additional LED module(s) may be used inside the passing beam headlamp to contribute to bend lighting.
- 6.2.4.2. One additional light source according to UN Regulation No. 37, and/or one or more LED module(s) inside the passing beam headlamp, may be used for the purposes of generating infrared radiation. It/they shall only be activated at the same time as the gas discharge light source. In the event that the gas-discharge light source fails, this additional light source and/or LED module(s) shall be automatically switched off.
- 6.2.4.3. In the event of failure of an additional light source or LED module, the headlamp shall continue to fulfil the requirements of the passing beam.
- 6.2.4.4. Measurement conditions with respect to light sources
- 6.2.4.4.1. In the case of a gas-discharge light source:
The voltage applied to the terminals of the ballast(s) is either 13.2 V +/- 0.1 for 12 V systems or otherwise specified (See Annex 7).
- 6.2.4.4.2. In the case of a filament light source according to UN Regulation No. 37:
The lamp shall be measured by means of an uncoloured standard (étalon) filament light source designed for a rated voltage of 12 V. During the checking, the voltage at the terminals of the filament light source shall be regulated so as to obtain the reference luminous flux at 13.2 V as indicated at the relevant data sheet of UN Regulation No. 37.
- 6.2.4.4.3. In the case of LED module(s):
The lamp shall be measured at 6.3 V, 13.2 V or 28.0V respectively, if not otherwise specified within this Regulation. LED module(s) operated by an electronic light source control gear, shall be measured as specified by the applicant.
- 6.2.5. After more than 10 minutes after ignition the luminous intensities at the test points referred to in the table below and in Annex 3, Figure B (or mirrored about the VV line for left-hand traffic) shall meet the following requirements:

<i>Points or segments</i>								<i>Designation**</i>		<i>Luminous intensity (cd)</i>		<i>Horizontal angle (degrees)</i>	<i>Vertical angle (degrees)</i>
										<i>Max</i>	<i>Min</i>		
Any point in zone A (bounded by the following coordinates in degrees)													
8L	8L	8R	8R	6R	1,5R	V-V	4L						
1U	4U	4U	2U	1,5U	1,5U	H-H	H-H	625					
1 HV								625		0	0		
2 B 50 L								350		3.43 L	0.57 U		
3 75 R									12,500	1.15 R	0.57 D		
4 50 L								18,480		3.43 L	0.86 D		
5 25 L1								18,800		3.43 L	1.72 D		
6 50 V									7,500	0	0.86 D		
7 50 R									12,500	1.72 R	0.86 D		
8 25 L2									2,500	9 L	1.72 D		
9 25 R1									2,500	9 R	1.72 D		
10 25 L3									1,250	15 L	1.72 D		
11 25 R2									1,250	15 R	1.72 D		

Points or segments	Designation**	Luminous intensity (cd)		Horizontal angle (degrees)	Vertical angle (degrees)
		Max	Min		
12	15 L		625	20 L	2.86 D
13	15 R		625	20 R	2.86 D
14			*	8 L	4 U
15			*	0	4 U
16			*	8 R	4 U
17			*	4 L	2 U
18			*	0	2 U
19			*	4 R	2 U
20			65	8 R	0
21			125	4 L	0
A to B	Segment I		3,750	5.15 L to 5.15 R	0.86 D
C – D		1,750		2.5 R	1 U
E to F	Segment III and under	12,500		9.37 L to 8.53 R	4.29 D
	E max R	43,800		Right of VV line	Above 1.72 D
	E max L	31,300		Left of VV line	

Note: In the table:

Letter L means that the point or segment is located on the left of VV line.

Letter R means that the point or segment is located on the right of VV line.

Letter U means the point or segment is located above HH line.

Letter D means the point or segment is located below HH line

* The luminous intensities at points 14 through 19 shall be such that:

$$14 + 15 + 16 \geq 190 \text{ cd and}$$

$$17 + 18 + 19 \geq 375 \text{ cd.}$$

** For left-hand traffic, the letter R shall be replaced by letter L and vice versa.

- 6.2.6. The requirements in paragraph 6.2.5. above shall also apply to headlamps designed to provide bend lighting and/or that include the additional light source or LED module(s) referred to in paragraph 6.2.4.2. In the case of a headlamp designed to provide bend lighting its alignment may be changed, provided that the axis of the beam is not displaced vertically by more than 0.2°.
- 6.2.6.1. If bend lighting is obtained by:
- 6.2.6.1.1. Swivelling the passing beam or moving horizontally the kink of the elbow of the cut-off, the measurements shall be carried out after the complete headlamp assembly has been reaimed horizontally, e. g. by means of a goniometer;
- 6.2.6.1.2. Moving one or more optical parts of the headlamp without moving horizontally the kink of the elbow of the cut-off, measurements shall be carried out with these parts being in their extreme operating position;
- 6.2.6.1.3. Means of one additional light source or one or more LED module(s) without moving horizontally the kink of the elbow of the cut-off, measurements shall be carried out with this light source or LED module(s) activated.
- 6.3. Provisions concerning driving beams
- 6.3.1. In the case of a headlamp designed to provide a driving beam and a passing beam, measurements of the luminous intensity of the driving beam shall be taken with the same headlamp alignment as for measurements under paragraph 6.2.5. above; in the case of a headlamp providing a driving beam only, it shall be so adjusted that the area of maximum luminous intensity is centred on the point of intersection of lines H-H and V-V; such a headlamp needs meet only the requirements referred to in paragraph 6.3. Test voltages are the same as in paragraph 6.2.4.4.
- 6.3.2. It is possible to use several light sources for the driving beam, these light sources being listed in UN Regulation No. 37 (in this case the filament light sources shall be operated at their reference luminous flux), in Regulation No. 99 and/or they can be LED module(s). Where more than one light source is used to provide the driving beam, these light sources shall be operated simultaneously whilst determining the maximum value of luminous intensity (I_M).
- It is also possible that a part of the driving beam produced by one of these light sources will be used exclusively for short time signals (flash to pass) as declared by the applicant. This shall be indicated in the relevant drawing and a remark shall be made in the communication form.
- 6.3.3. Referring to Annex 3, Figure C, and the table below, the luminous intensity distribution of the driving beam shall meet the following requirements.

<i>Test point</i>	<i>Angular coordinates Degrees</i>	<i>Required luminous intensity cd</i>
		Min
H-5L	0.0 , 5.0 L	6,250
H-2.5L	0.0 , 2.5 L	25,000
H-2.5R	0.0 , 2.5 R	25,000
H-5R	0.0 , 5.0 R	6,250

- 6.3.3.1. The point of intersection (HV) of lines HH and VV shall be situated within the isolux representing 80 per cent of maximum luminous intensity. This maximum value (I_M) shall not be less than 43,800 cd.
- 6.3.3.2. The maximum value (I_M) shall in no circumstances exceed 215,000 cd.

- 6.3.4. The reference mark (I_M) of the maximum luminous intensity, referred to in paragraph 6.3.3.2. above, shall be obtained by the ratio:
- $$I'_M = I_M/4,300.$$
- This value shall be rounded off to the value 7.5 – 10 – 12.5 – 17.5 – 20 – 25 – 27.5 – 30 – 37.5 – 40 – 45 – 50.
- 6.4 Provisions concerning movable reflectors
- 6.4.1 With the lamp fixed according to all the positions described in paragraph 2.1.4., the headlamp must meet the photometric requirements of paragraph 6.2. or 6.3., or both.
- 6.4.2. Additional tests are made after the reflector has been tilted vertically upwards by the angle quoted in paragraph 2.1.4. or 2 degrees, whichever is smaller, by means of the headlamp aiming devices. The headlamp is then re-aimed downwards (by means of the goniometer), and the photometric specifications shall be met at the following points:
- Principal passing beam: B50L and 75 R (B 50 R and 75 L, respectively);
Driving beam: I_M and point HV (percentage of I_M).
- If the aiming devices do not allow a continuous movement, the position nearest to 2 degrees is chosen.
- 6.4.3. The reflector is brought back to its nominal angular position as defined in paragraph 6.2.2., and the goniometer is set back to its position of origin. The reflector is tilted vertically downwards by the angle quoted in paragraph 2.1.4., or 2 degrees, whichever is smaller, by means of the headlamp aiming device. The headlamp is then re-aimed upwards (by means of the goniometer for example) and points as in paragraph 6.5.2. are checked.

7. Gauging of discomfort and/or disability

The discomfort and/or disability caused by the passing beam of headlamps shall be gauged¹⁰.

C. Further administrative provisions

8. Modification of the headlamp type and extension of approval

- 8.1. Every modification of the headlamp type including the ballast shall be notified to the Type Approval Authority which approved the headlamp type. The said department may then either:
- 8.1.1. Consider that the modifications made are unlikely to have appreciable adverse effects and that in any event the headlamp still complies with the requirements; or
- 8.1.2. Require a further test report from the technical service responsible for conducting the tests.
- 8.2. Confirmation or refusal or approval, specifying the alterations, shall be communicated by the procedure specified in paragraph 4.1.5. above to the Contracting Parties to the Agreement which apply this Regulation.

¹⁰ This requirement will be the subject of a recommendation for the benefit of the administrations.

- 8.3. The competent authority issuing the extension of approval shall assign a series number to each communication form drawn up for such an extension and inform thereof the other Contracting Parties to the 1958 Agreement applying this Regulation by means of a communication form conforming to the model in Annex 1 to this Regulation.

9. Conformity of production

The Conformity of Production (CoP) procedures shall comply with those set out in the Agreement, Appendix 2 (E/ECE/324 - E/ECE/TRANS/505/Rev.2), with the following requirements:

- 9.1. Headlamps approved under this Regulation shall be so manufactured as to conform to the type approved by meeting the requirements set forth in paragraph 6.
- 9.1.2. In order to verify that the requirements of paragraph 9.1. are met, suitable controls of the production shall be carried out.
- 9.1.3. The holder of the approval shall in particular:
- 9.1.3.1. Ensure the existence of procedures for the effective control of the quality of products;
- 9.1.3.2. Have access to the control equipment necessary for checking the conformity to each approved type;
- 9.1.3.3. Ensure that data of test results are recorded and that related documents shall remain available for a period to be determined in accordance with the administrative service;
- 9.1.3.4. Analyse the results of each type of test in order to verify and ensure the stability of the product characteristics making allowance for variation of an industrial production;
- 9.1.3.5. Ensure that for each type of product at least the tests prescribed in Annex 8 to this Regulation are carried out;
- 9.1.3.6. Ensure that any collecting of samples giving evidence of non-conformity with the type of test considered shall give rise to another sampling and another test. All the necessary steps shall be taken to re-establish the conformity of the corresponding production.
- 9.1.4. The competent authority which has granted type approval may at any time verify the conformity control methods applicable to each production unit.
- 9.1.4.1. In every inspection, the test books and production survey records shall be presented to the visiting inspector.
- 9.1.4.2. The inspector may take samples at random to be tested in the manufacturer's laboratory. The minimum number of samples may be determined in the light of results of the manufacturer's own checks.
- 9.1.4.3. When the quality level appears unsatisfactory or when it seems necessary to verify the validity of the tests carried out in the application of paragraph above, the inspector shall select samples, to be sent to the technical service which has conducted the type approval tests, using the criteria of Annex 9.
- 9.1.4.4. The competent authority may carry out any test prescribed in this Regulation. These tests will be on samples selected at random without causing distortion of the manufacturer's delivery commitments and in accordance with the criteria of Annex 9.
- 9.1.4.5. The competent authority shall strive to obtain a frequency of inspection of once every two years. However, this is at the discretion of the competent authority and their confidence in the arrangements for ensuring effective control of the conformity of production. In the case where negative results are

recorded, the competent authority shall ensure that all necessary steps are taken to re-establish the conformity of production as rapidly as possible.

- 9.2. Headlamps with apparent defects are disregarded.
- 9.3. The reference mark is disregarded.
- 9.4. The measuring points 14 to 21 from paragraph 6.2.6. of this Regulation are disregarded.

10. Penalties for non-conformity of production

- 10.1. The approval granted in respect of a type of headlamp pursuant to this Regulation may be withdrawn if the requirements are not complied with or if a headlamp bearing the approval mark does not conform to the type approved.
- 10.2. If a Contracting Party to the Agreement applying this Regulation withdraws an approval it has previously granted, it shall forthwith so notify the other Contracting Parties applying this Regulation by means of a communication form conforming to the model in Annex 1 to this Regulation.

11. Production definitively discontinued

If the holder of the approval completely ceases to manufacture a type of headlamp approved in accordance with this Regulation, he shall so inform the authority which granted the approval. Upon receiving the relevant communication, that authority shall inform thereof the other Contracting Parties to the 1958 Agreement applying this Regulation by means of a communication form conforming to the model in Annex 1 to this Regulation.

12. Names and addresses of Technical Services responsible for conducting approval tests, and of Type Approval Authorities

The Contracting Parties to the 1958 Agreement applying this Regulation shall communicate to the United Nations Secretariat the names and addresses of the Technical Services responsible for conducting approval tests and of the Type Approval Authorities which grant approval and to which forms certifying approval or extension or refusal or withdrawal of approval, or production definitively discontinued, issued in other countries, are to be sent.

13. Transitional provisions¹¹

- 13.1. As from 24 months after the official date of entry into force of UN Regulation No. 149, Contracting Parties applying this Regulation shall cease to grant approvals to this Regulation.
- 13.2. Contracting Parties applying this Regulation shall not refuse to grant extensions of approval to this and any previous series of amendments of this Regulation.
- 13.3. Contracting Parties applying this Regulation shall continue to grant approvals for devices on basis of this and any previous series of amendments to this

¹¹ The 02 series of amendments does not require changes in the approval number (TRANS/WP.29/815, para. 82).

Regulation, provided that the devices are intended as replacements for fitting to vehicles in use.

- 13.4. Contracting Parties applying this Regulation shall continue to allow fitting or use on a vehicle in use of a device approved to this Regulation as amended by any previous series of amendments, provided that the device is intended for replacement.

Annex 1

Communication concerning the approval or extension or refusal or withdrawal of approval or production definitively discontinued of a type of headlamp pursuant to UN Regulation No. 98

(Maximum format: A4 (210 x 297 mm))

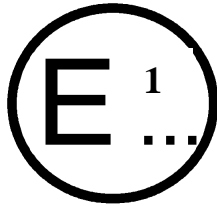

Issued by:

Name of administration:

.....
.....
.....

concerning²: Approval granted
 Approval extended
 Approval refused
 Approval withdrawn
 Production definitively discontinued

of a type of headlamp pursuant to UN Regulation No. 98.

Approval No.:.....

Extension No.:.....

1. Trade name or mark of the headlamp:
2. Manufacturer's name for the type of device:
3. Manufacturer's name and address:.....

4. If applicable, name and address of the manufacturer's representative:.....

5. Submitted for approval on:
6. Technical Service responsible for conducting approval tests:.....

7. Date of test report:.....
8. Number of test report:

¹ Distinguishing number of the country which has granted/extended/refused/withdrawn approval (see approval provisions in the Regulation).

² Strike out what does not apply.

9. Brief description:
- 9.1. Headlamp submitted for approval as type:
- 9.2. The passing beam light source may/may not² be lit simultaneously with the driving beam light source and/or another reciprocally incorporated headlamp.
- 9.3. The rated voltage of the device is:.....
- 9.4. Category (or categories) of light source(s):
- 9.4.1. If more than one objective luminous flux value is specified: Objective luminous flux value used for the principal passing beam [lm]
- 9.4.2. If more than one objective luminous flux value is specified: Objective luminous flux value used for the driving beam..... [lm]
- 9.5. Trade name and identification number of separate ballast(s) or part(s) of ballast(s):
- 9.6. The adjustment of the "cut-off" has been determined at 10 m/25 m².
The determination of the minimum sharpness of the "cut-off" has been carried out at 10 m/25 m².
- 9.7. Number and specific identification code(s) of LED module(s):.....
- 9.8. Remarks (if any):.....
- 9.9. Measures according to paragraph 5.4. of this Regulation:
10. Approval mark position:.....
11. Reason(s) for extension of approval:.....
12. Approval granted/extended/refused/withdrawn²:
13. Place:
14. Date:
15. Signature:
16. The list of documents deposited with the Administration Service which has granted approval is annexed to this communication and may be obtained on request.

Annex 2

Examples of arrangements of approval marks

Figure 1

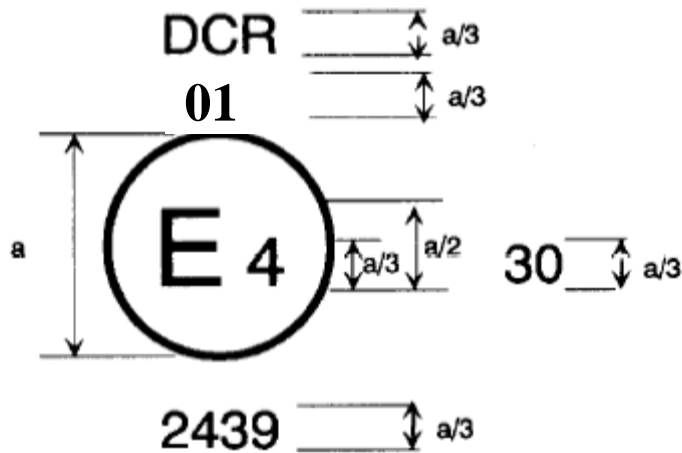

$a \geq 8$ mm (on glass)

$a \geq 5$ mm (on plastic material)

The headlamp bearing the approval mark shown above is a headlamp approved in the Netherlands (E4), under approval number 2439, meeting the requirements of this Regulation, as amended by the 01 series of amendments.¹⁴ The passing beam is designed for right-hand traffic only.

Figure 30 indicates that the maximum luminous intensity of the driving beam is between 123,625 and 145,125 candelas.

Note: The approval number and additional symbols shall be placed close to the circle and either above or below the letter "E", or to the right or left of that letter. The digits of the approval number shall be on the same side of the letter "E" and face in the same direction.

The use of Roman numerals as approval numbers should be avoided so as to prevent any confusion with other symbols.

¹⁴ The 02 series of amendments does not require changes in the approval number (TRANS/WP.29/815, para. 82).

Figure 2

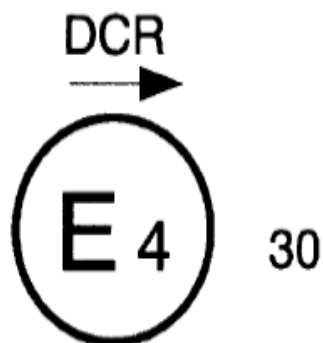

012439

Figure 3a

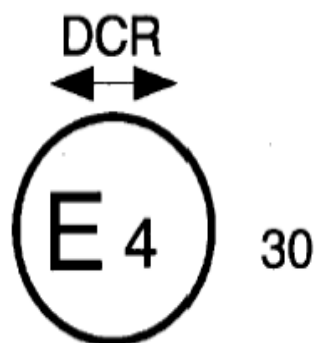

012439

The headlamp bearing the approval marking shown above is a headlamp meeting the requirements of this Regulation, as amended by the 01 series of amendments,¹⁶ with respect to both the passing beam and the driving beam and designed:

For left-hand traffic only

For both traffic systems, by means of an adjustment as desired of the setting of the optical unit or the light source on the vehicle

Figure 3b



Figure 4



Figure 5



The headlamp bearing the approval marking shown above is a headlamp meeting the requirements of this Regulation, as amended by the 01 series of amendments,¹⁶ with a gas discharge light source for the passing beam only and is equipped with a lens of plastic material, and designed:

For both traffic systems

|

For right-hand traffic only

Figure 6

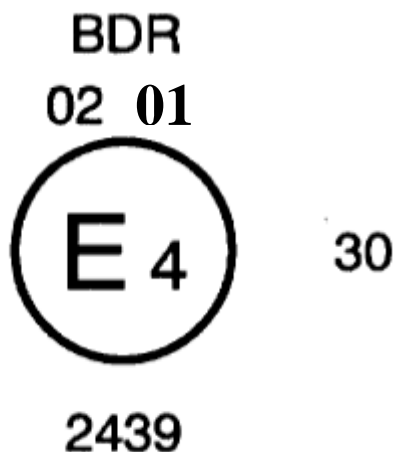

The headlamp bearing the approval marking shown above is a headlamp meeting the requirements of this Regulation, as amended by the 01 series of amendments,¹⁶ with gas discharge light sources for the driving beam, and is combined or grouped or reciprocally incorporated with a front fog lamp.

Figure 7a



Figure 7b

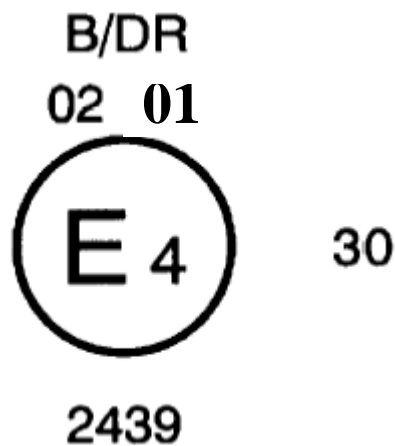

The headlamp bearing the above approval marking shown above is a headlamp meeting the requirements of this Regulation, as amended by the 01 series of amendments:¹⁶

With a gas discharge light source in respect of the passing beam only and is designed for left-hand traffic only.	Same arrangement as Figure 6, but the front fog lamp cannot be lit simultaneously with the driving beam.
---	--

Figure 8

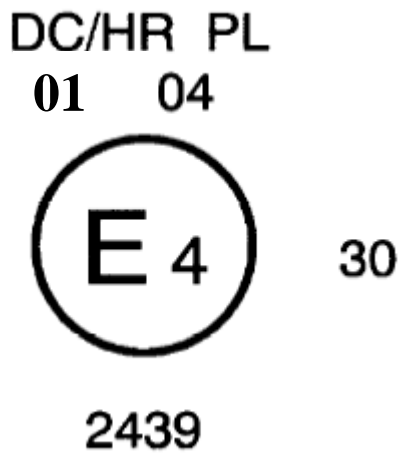

Figure 9



Identification of a passing beam headlamp meeting the requirements of this Regulation, as amended by the 01 series of amendments,¹⁶ and incorporating a lens of plastic material,

and combined or grouped or reciprocally incorporated with R 8 halogen driving beam.

The passing beam shall not be lit simultaneously with the halogen driving beam. The passing beam is designed for right-hand traffic only.

designed for both traffic systems.

The passing beam shall not be lit simultaneously with another reciprocally incorporated headlamp.

Examples of possible simplified marking for grouped, combined or reciprocally incorporated lamps fitted to the front of the vehicle

Figure 10

(The vertical and horizontal lines schematize the shape and overall arrangement of the light-signalling device. They are not part of the approval mark.)

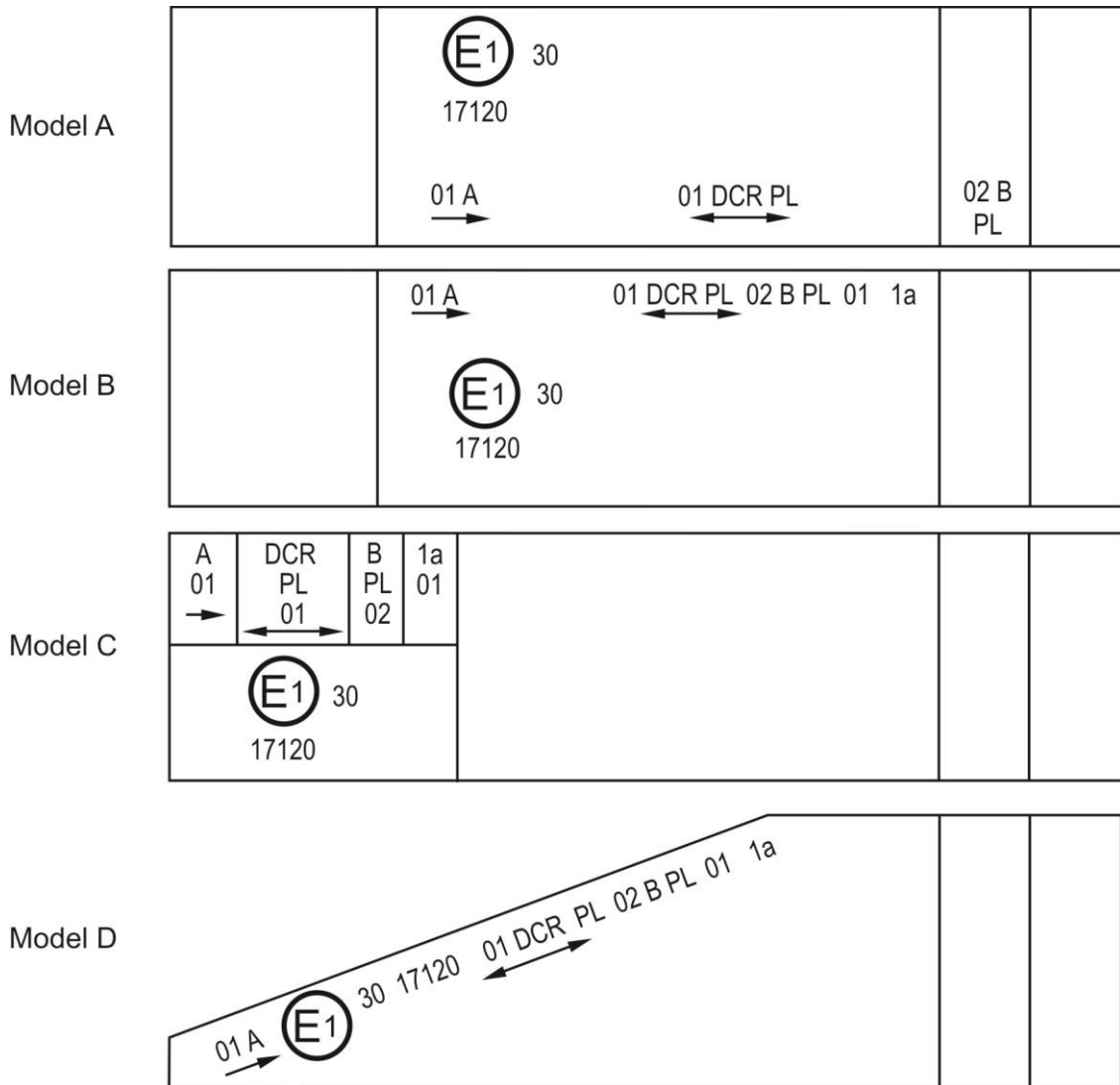

Note: The four examples shown above correspond to a lighting device bearing an approval mark relating to:

A front position lamp approved in accordance with the 01 series of amendments to UN Regulation No. 7, for left-hand installation;

A headlamp with a gas discharge passing beam designed for right-hand and left-hand traffic and a gas discharge driving beam with a maximum intensity comprised between 123,625 and 145,125 (as indicated by the number 30), approved in accordance with this Regulation in its original form and incorporating a lens of plastic material;

A front fog lamp approved in accordance with the 02 series of amendments to UN Regulation No. 19 and incorporating a lens of plastic material;

A front direction indicator lamp of category 1a approved in accordance with the 01 series of amendments to UN Regulation No. 6.

Figure 11
Lamp reciprocally incorporated or grouped with a headlamp

Example 1

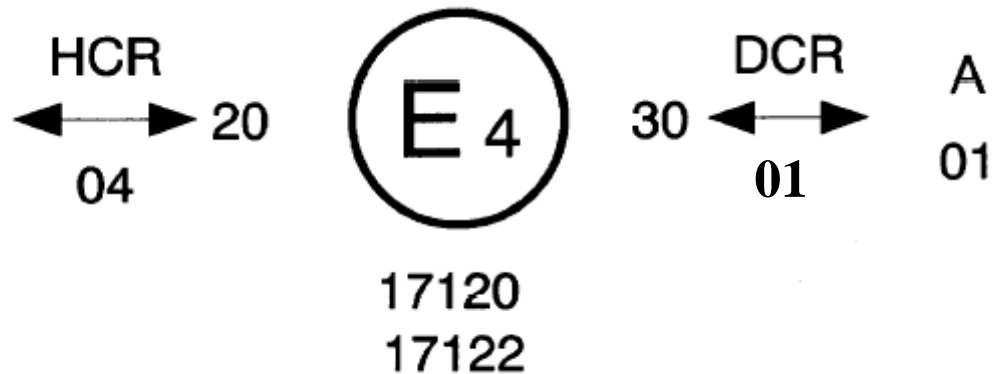

The above example corresponds to the marking of a lens intended to be used in different types of headlamps namely:

Either:

A headlamp with a passing beam designed for both traffic systems and a driving beam with a maximum luminous intensity comprised between 80,625 and 96,750 candelas (as indicated by the number 20) approved in the Netherlands (E 4) in accordance with the requirements of UN Regulation No. 8 as amended by the 04 series of amendments, and

A front position lamp approved in accordance with the 01 series of amendments to UN Regulation No. 7,

Or

A headlamp with a gas discharge passing beam and a driving beam with a maximum luminous intensity comprised between 123,625 and 145,125 candelas (as indicated by the number 30), designed for both traffic systems and approved in the Netherlands in accordance with the requirements of this Regulation, as amended by the 01 series of amendments,¹⁶ which is reciprocally incorporated with the same front position lamp as above,

Or

Even either of the above-mentioned headlamps approved as a single lamp.

The main body of the headlamp shall bear the only valid approval number, for instance:

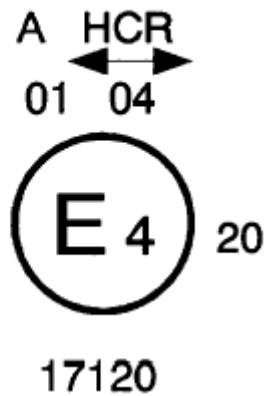

or

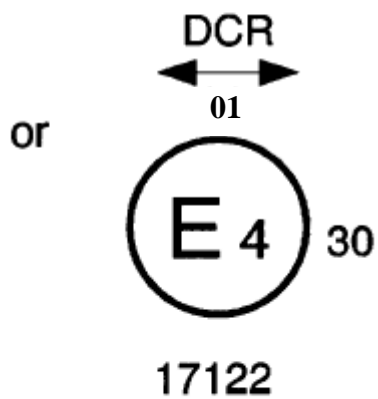
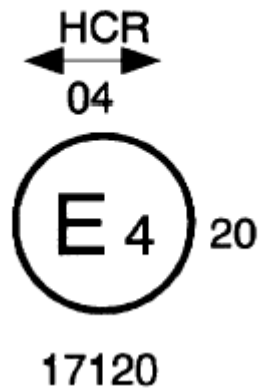

or

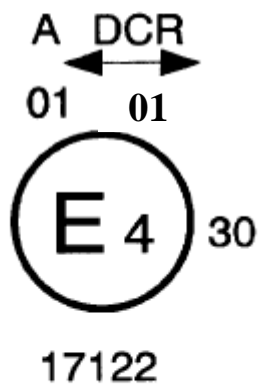
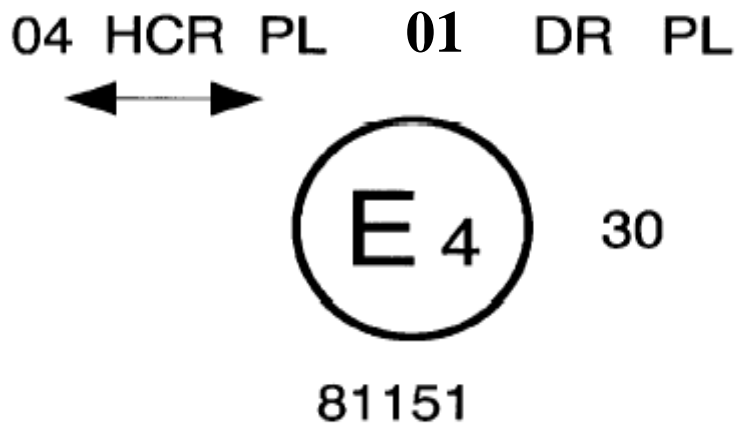

Figure 11 (Continued)

Example 2



The above example corresponds to the marking of a lens of plastic material and used in an assembly of two headlamps approved in the Netherlands (E4) under approval number 81151, consisting of:

A headlamp emitting a halogen passing beam designed for both traffic systems and a halogen driving beam with a maximum luminous intensity between x and y candelas, meeting the requirements of UN Regulation No. 8 and,

A headlamp emitting a gas discharge driving beam with a maximum luminous intensity comprised between w and z candelas, meeting the requirements of this Regulation, as amended by the 01 series of amendments,¹⁶ the maximum luminous intensities of the driving beam contributors as a whole being comprised between 123,625 and 145,125 candelas as shown by the number 30.

Figure 12

LED modules
MD E3 17325

The LED module bearing the light source module identification code shown above has been approved together with a lamp approved in Italy (E3) under approval number 17325.

Annex 3

Spherical coordinate measuring system and test point locations

Figure A
 Spherical coordinate measuring system

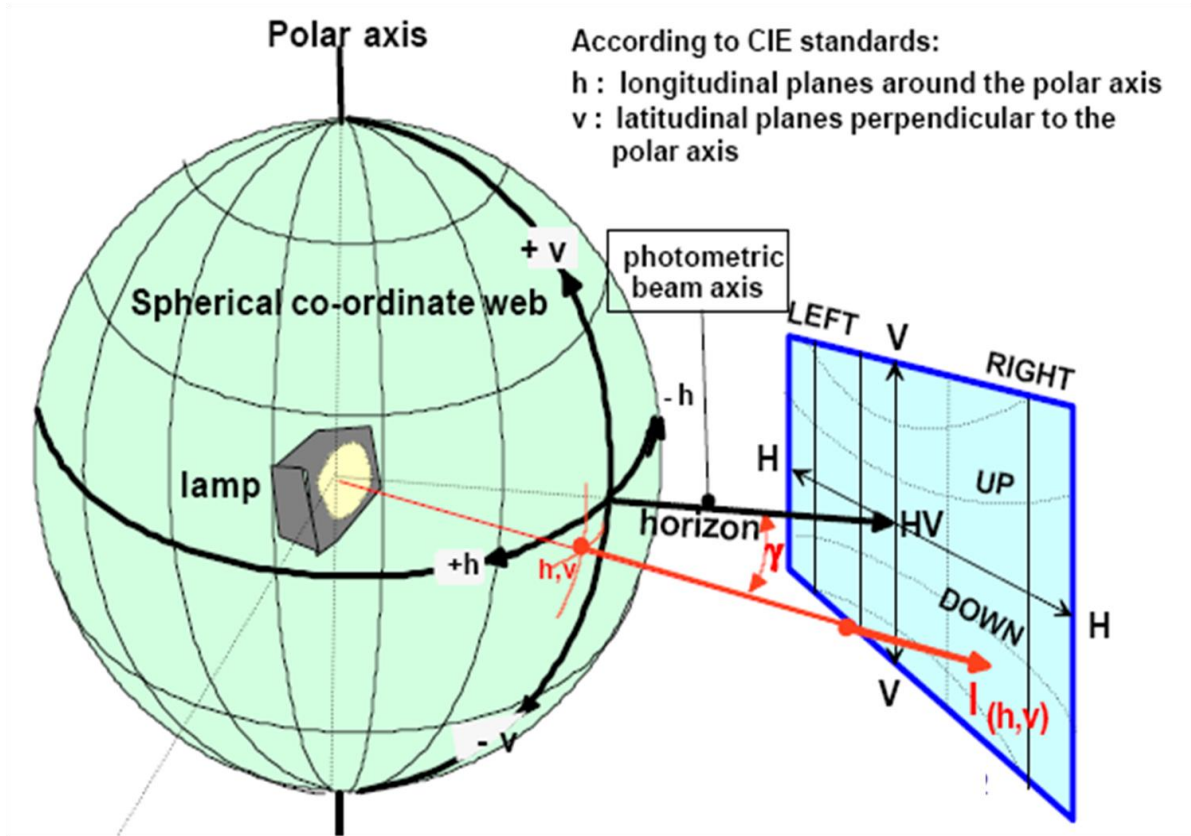

$$E_{25m} = I_{(h,v)} \times \cos \gamma / r^2$$

Figure B
 Passing beam for right-hand traffic

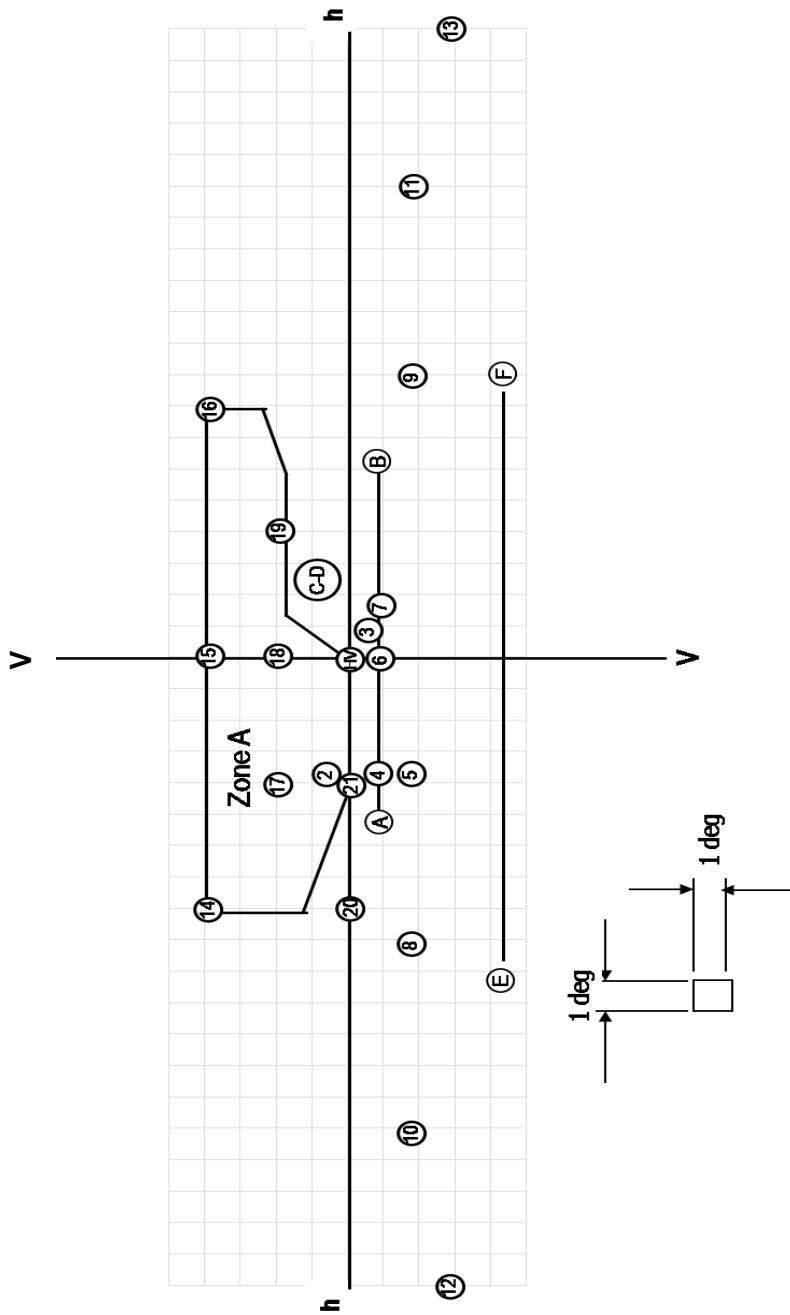

h-h = horizontal plane, v-v = vertical plane passing through the optical axis of the headlamp

The test point locations for left-hand traffic are mirrored about the VV line

Figure C
Driving beam test points

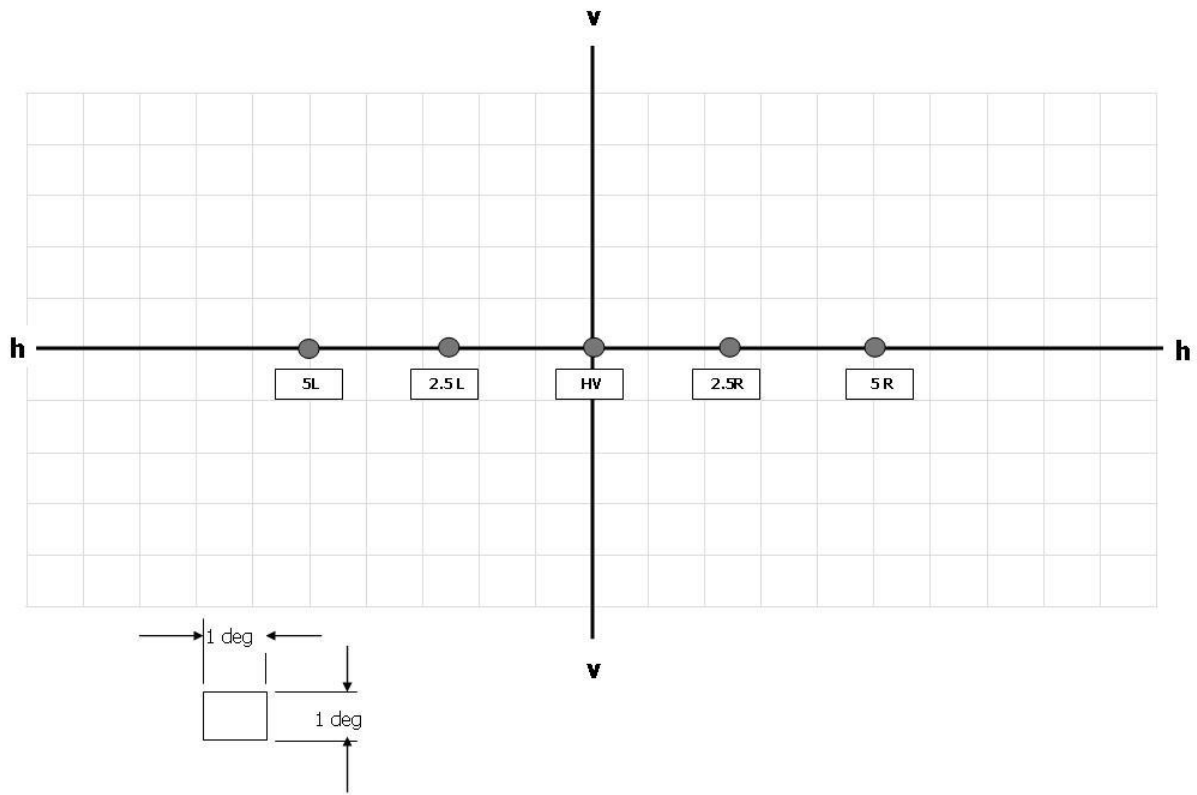

h-h = horizontal plane, v-v = vertical plane passing through the optical axis of the headlamp.

Annex 4

Tests for stability of photometric performance of headlamps in operation

Test on complete headlamps

Test on complete headlamps

Once the photometric values have been measured according to the prescriptions of this Regulation, in the point for I_{max} for driving beam and in points 25 L, 50 R and B 50 L for passing beam (or 25 R, 50 L, B 50 R for headlamps designed for left-hand traffic) a complete headlamp sample shall be tested for stability of photometric performance in operation. "Complete headlamp" shall be understood to mean the complete lamp itself including ballast(s) and those surrounding body parts and lamps which could influence its thermal dissipation.

The tests shall be carried out:

- (a) In a dry and still atmosphere at an ambient temperature of $23\text{ °C} \pm 5\text{ °C}$, the test sample being mounted on a base representing the correct installation on the vehicle;
- (b) In case of light sources: using mass production filament light sources, which have been aged for at least one hour, or mass production gas-discharge light sources, which have been aged for at least 15 hours or mass production LED modules which have been aged for at least 48 hours and cooled down to ambient temperature before starting the tests as specified in this Regulation. The LED modules supplied by the applicant shall be used.

The measuring equipment shall be equivalent to that used during headlamp type-approval tests.

The test sample shall be operated without being dismantled from or readjusted in relation to its test fixture. The light source used shall be a light source of the category specified for that headlamp.

1. Test for stability of photometric performance

The tests shall be carried out in a dry and still atmosphere at an ambient temperature of $23 \pm 5\text{ °C}$, the complete headlamp being mounted on a base representing the correct installation on the vehicle.

1.1. Clean headlamp

The headlamp shall be operated for 12 hours as described in subparagraph 1.1.1. and checked as prescribed in subparagraph 1.1.2.

1.1.1. Test procedure

The headlamp shall be operated for a period according to the specified time, so that:

- 1.1.1.1. (a) In the case where only one lighting function (driving or passing beam) is to be approved, the corresponding light source is lit for the prescribed time¹;

¹ When the tested headlamp is grouped and/or reciprocally incorporated with signalling lamps, the

- (b) In the case of a reciprocally incorporated passing beam lamp and driving beam lamp or in the case of a reciprocally incorporated front fog lamp and driving beam headlamp:

If the applicant declares that the headlamp is to be used with a single light source lit² at a time, the test shall be carried out in accordance with this condition, activating¹ each specified function successively for half the time specified in paragraph 1.1.,

In all other cases^{1,2}, the headlamp shall be subjected to the following cycle until the time specified is reached:

15 minutes, passing beam lit;
5 minutes, all functions lit;

In the case of a passing beam and a driving beam provided by the same gas-discharge light source, the cycle will be:

15 minutes, passing beam lit;
5 minutes, all driving beam contributors lit.

- (c) In the case of grouped lighting functions, all the individual functions shall be lit simultaneously for the time specified for individual lighting functions (a), also taking into account the use of reciprocally incorporated lighting functions (b), according to the manufacturer's specifications.
- (d) In the case of a passing beam designed to provide bend lighting with the addition of a light source, this light source shall be switched on for 1 minute, and switched off for 9 minutes during the activation of the passing beam only (see Annex 4 – Appendix 1).
- (e) In the case that the driving beam uses several light sources in accordance with paragraph 6.3.2. and if the applicant declares that a part of the driving beam (one of these additional light sources) will be used exclusively for short time signals (flash to pass), the test shall be carried out without this part of the driving beam.

1.1.1.2. Test voltage

The voltage shall be applied to the terminals of the test sample as follows:

- (a) In case of filament light source(s) operated directly under vehicle voltage system conditions: the test shall be performed at 6.3 V, 13.2 V or 28.0 V as applicable except if the applicant specifies that the test sample may be used at a different voltage. In this case, the test shall be carried out with the filament light source operated at the highest voltage that can be used;
- (b) In case of gas discharge light source(s): The test voltage for the electronic light source control-gear is 13.2 ± 0.1 volts for 12 V vehicle voltage system, or otherwise specified in the application for approval;
- (c) In the case of light sources being operated independently from vehicle supply voltage and fully controlled by the system, or, in the case of light sources supplied by a supply and operating device, the test voltages as specified above shall be applied to the input terminals of that device. The test laboratory may require from the manufacturer the

latter shall be lit for the duration of the test. In the case of a direction indicator lamp, it shall be lit in flashing operation mode with an on/off time ratio of approximately one to one.

² Should two or more light sources be simultaneously lit when headlamp flashing is used, this shall not be considered as being normal use of the light sources simultaneously.

supply and operating device or a special power supply needed to supply the light source(s).

- (d) LED module(s) shall be measured at 6.75 V, 13.2 V or 28.0 V respectively, if not otherwise specified within this Regulation. LED module(s) operated by an electronic light source control gear shall be measured as specified by the applicant.
- (e) Where signalling lamps are grouped, combined or reciprocally incorporated into the test sample and operating at voltages other than the nominal rated voltages of 6 V, 12 V or 24 V respectively, the voltage shall be adjusted as declared by the manufacturer for the correct photometric functioning of that lamp.

1.1.2. Test results

1.1.2.1. Visual inspection:

Once the headlamp has been stabilized to the ambient temperature, the headlamp lens and the external lens, if any, shall be cleaned with a clean, damp cotton cloth. It shall then be inspected visually; no distortion, deformation, cracking or change in colour of either the headlamp lens or the external lens, if any, shall be noticeable.

1.1.2.2. Photometric test:

To comply with the requirements of this Regulation, the photometric values shall be verified in the following points:

Passing-beam:

50 R - B 50 L – 25 L for headlamps designed for right-hand traffic

50 L - B 50 R – 25 R for headlamps designed for left-hand traffic

Driving-beam: Point I_{max}

Another aiming may be carried out to allow for any deformation of the headlamp base due to heat (the change of the position of the cut-off line is covered in paragraph 2. of this annex).

Except for point B 50 L, a 10 per cent discrepancy between the photometric characteristics and the values measured prior to the test is permissible including the tolerances of the photometric procedure. The value measured at point B 50 L shall not exceed the photometric value measured prior to the test by more than 170 cd.

1.2. Dirty headlamp

After being tested as specified in subparagraph 1.1. above, the headlamp shall be operated for one hour as described in subparagraph 1.1.1., after being prepared as prescribed in subparagraph 1.2.1., and checked as prescribed in subparagraph 1.1.2.

1.2.1. Preparation of the headlamp

1.2.1.1. Test mixture

1.2.1.1.1. For headlamp with the outside lens in glass:

The mixture of water and a polluting agent to be applied to the headlamp shall be composed of:

9 parts by weight of silica sand with a particle size of 0-100 µm,

1 part by weight of vegetal carbon dust produced from beech wood with a particle size of 0-100 µm,

0.2 parts by weight of NaCMC³, and

5 parts by weight of sodium chloride (pure at 99 per cent),

an appropriate quantity of distilled water, with a conductivity of ≤ 1 µS/m.

The mixture must not be more than 14 days old.

1.2.1.1.2. For headlamp with outside lens in plastic material:

The mixture of water and polluting agent to be applied to the headlamp shall be composed of:

- (a) 9 parts by weight of silica sand with a particle size of 0-100 µm;
- (b) 1 part by weight of vegetal carbon dust produced from beech wood with a particle size of 0-100 µm;
- (c) 0.2 part by weight of NaCMC³;
- (d) 5 parts by weight of sodium chloride (pure at 99 per cent);
- (e) 13 parts by weight of distilled water with a conductivity of ≤ 1 mS/m;
- (f) 2 ± 1 drops of surfactant.⁴

The mixture shall not be more than 14 days old.

1.2.1.2. Application of the test mixture to the headlamp:

The test mixture shall be uniformly applied to the entire light-emitting surface of the headlamp and then left to dry. This procedure shall be repeated until the illuminating value has dropped to 15-20 per cent of the values measured for each following point under the conditions described in this annex:

Point of E_{max} in passing beam/driving beam and in driving beam only,

50 R and 50 V⁵ for a headlamp producing only a passing beam, designed for right-hand traffic,

50 L and 50 V⁵ for a headlamp producing only a passing beam, designed for left-hand traffic.

2. Test for change in vertical position of the cut-off line under the influence of heat

This test consists of verifying that the vertical drift of the cut-off line under the influence of heat does not exceed a specified value for an operating headlamp producing a passing beam.

The headlamp tested in accordance with paragraph 1. shall be subjected to the test described in paragraph 2.1., without being removed from or readjusted in relation to its test fixture.

If the headlamp has a moving reflector, only the position closest to the average vertical angular stroke is chosen for this test.

³ NaCMC represents the sodium salt of carboxymethylcellulose, customarily referred to as CMC. The NaCMC used in the dirt mixture shall have a degree of substitution (DS) of 0.6-0.7 and a viscosity of 200-300 cP for a 2 per cent solution at 20 °C.

⁴ The tolerance on quantity is due to the necessity of obtaining a dirt that correctly spreads out on all the plastic lens.

⁵ 50 V is situated 375 mm below HV on the vertical line VV on the screen at 25 m distance.

- 2.1. Test for passing beam headlamps
- The test shall be carried out in a dry and still atmosphere at an ambient temperature of 23 ± 5 °C.
- Using a mass production gas-discharge light source which has been aged for at least 15 hours, the headlamp shall be operated on passing beam function without being dismantled from or readjusted in relation to its test fixture. (For the purpose of this test, the voltage shall be adjusted as specified in paragraph 1.1.1.2.). The position of the cut-off line in its horizontal part (between VV and the vertical line passing through point B 50 L for right-hand traffic or B 50 R for left-hand traffic) shall be verified 3 minutes (r3) and 60 minutes (r60) respectively after operation.
- The measurement of the variation in the cut-off line position as described above shall be carried out by any method giving acceptable accuracy and reproducible results.
- 2.2. Test results
- 2.2.1. The result expressed in milliradians (mrad) shall be considered as acceptable for a passing beam headlamp when the absolute value $\Delta r_1 = |r_3 - r_{60}|$ recorded on the headlamp is not more than 1.0 mrad ($\Delta r_1 \leq 1.0$ mrad) upward and not more than 2.0 mrad ($\Delta r_1 \leq 2.0$ mrad) downwards.
- 2.2.2. However, if this value is:

Movement

Upward	more than 1.0 mrad but not more than 1.5 mrad ($1.0 \text{ mrad} < \Delta r_1 \leq 1.5 \text{ mrad}$)
Downward	more than 2.0 mrad but not more than 3.0 mrad ($2.0 \text{ mrad} < \Delta r_1 \leq 3.0 \text{ mrad}$)

A further sample of a headlamp mounted on a test fixture representative of the correct installation on the vehicle shall be tested as described in paragraph 2.1. above after being subjected three consecutive times to the cycle as described below, in order to stabilize the position of mechanical parts of the headlamp:

- (a) Operation of the passing beam for one hour (the voltage shall be adjusted as specified in paragraph 1.1.1.2.);
- (b) One hour period with the lamp switched off.

After these three cycles, the headlamp type shall be considered as acceptable if the absolute values Δr measured according to paragraph 2.1. above on this further sample meet the requirements in paragraph 2.2.1. above.

Annex 4 – Appendix

Overview of operational periods concerning test for stability of photometric performance

- Abbreviations:
- P: Passing beam lamp
 - D: Driving beam lamp (D₁ + D₂ means two driving beams)
 - F: Front fog lamp
-
- Means a cycle of 15 minutes off and 5 minutes lit
 - Means a cycle of 9 minutes off and 1 minutes lit
 - Means a cycle of 15 minutes lit and 5 minutes off

All the following grouped headlamps and front fog lamps together with the added marking symbols are given as examples and are not exhaustive.

1. P or D or F (DC or DR or B)

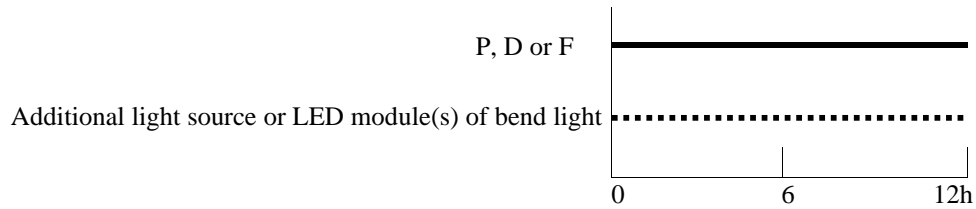

2. P+F (DC B) or P+D (DCR)

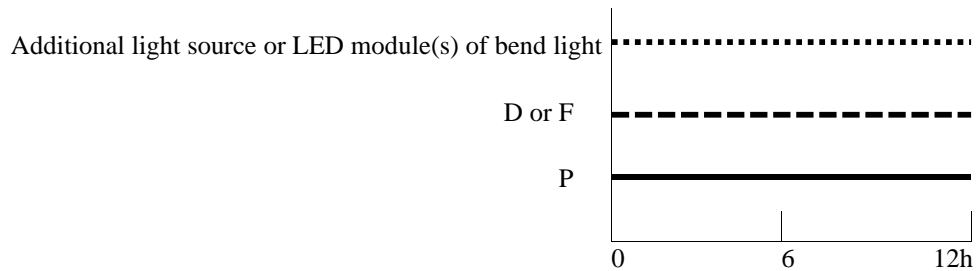

3. P+F (DC B/) or DC/B or P+D (DC/R)

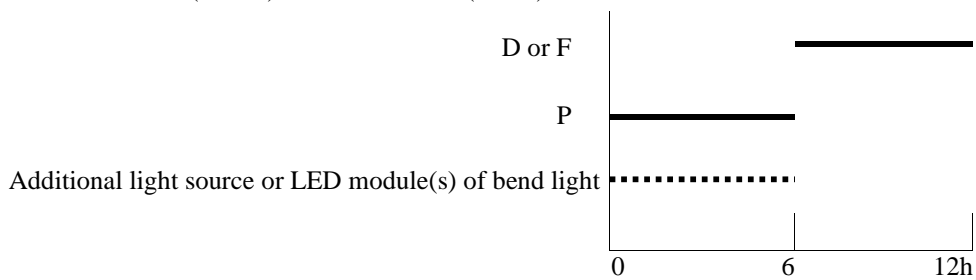

4. P+D (DCR) with the same light source

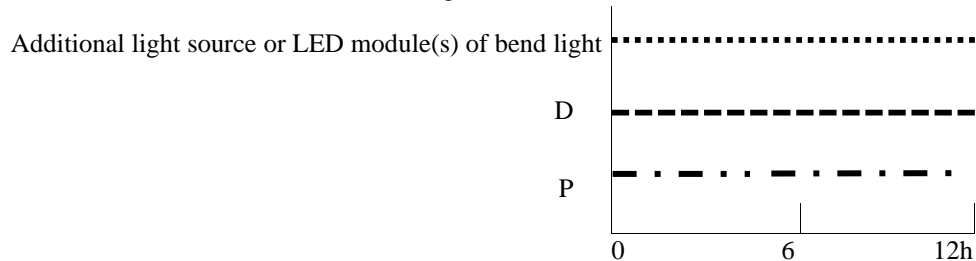

Annex 5

Requirements for lamps incorporating lenses of plastic material – Testing of lens or material samples and of complete lamps

1. General specifications
 - 1.1. The samples supplied pursuant to paragraphs 2.2.5. and 2.3. of this Regulation shall satisfy the specifications indicated in paragraphs 2.1. to 2.5. below.
 - 1.2. The two samples of complete lamps supplied pursuant to paragraph 2.2.4. of this Regulation and incorporating lenses of plastic material shall, with regard to the lens material, satisfy the specifications below.
 - 1.3. The samples of lenses of plastic material or samples of material shall be subjected, with the reflector to which they are intended to be fitted (where applicable), to approval tests in the chronological order indicated in table A reproduced in Appendix 1 to this annex.
 - 1.4. However, if the lamp manufacturer can prove that the product has already passed the tests prescribed in paragraphs 2.1. to 2.5. below, or the equivalent tests pursuant to another Regulation, those tests need not be repeated; only the tests prescribed in Appendix 1, table B, shall be mandatory.
 - 1.5. If the headlamps are designed for right-hand installation only, or for left-hand installation only, tests pursuant to this annex may be done on one sample only, at the choice of the applicant.

2. Tests

2.1. Resistance to temperature changes

2.1.1. Tests

Three new samples (lenses) shall be subjected to five cycles of temperature and humidity (RH = relative humidity) change in accordance with the following programme:

- (a) 3 hours at 40 ± 2 °C and 85-95 per cent RH;
- (b) 1 hour at 23 ± 5 °C and 60-75 per cent RH;
- (c) 15 hours at -30 ± 2 °C;
- (d) 1 hour at 23 ± 5 °C and 60-75 per cent RH;
- (e) 3 hours at 80 ± 2 °C;
- (f) 1 hour at 23 ± 5 °C and 60-75 per cent RH.

Before this test, the samples shall be kept at 23 ± 5 °C and 60-75 per cent RH for at least four hours.

Note: The periods of one hour at 23 ± 5 °C shall include the periods of transition from one temperature to another which are needed in order to avoid thermal shock effects.

2.1.2. Photometric measurements

2.1.2.1. Method

Photometric measurements shall be carried out on the samples before and after the test.

These measurements shall be made using a standard lamp, at the following points:

B 50 L and 50 R for the passing beam of a passing lamp or a passing/driving lamp (B 50 R and 50 L in the case of headlamps intended for left-hand traffic);

I_{\max} for the driving beam.

2.1.2.2. Results

The variation between the photometric values measured on each sample before and after the test shall not exceed 10 per cent including the tolerances of the photometric procedure.

2.2. Resistance to atmospheric and chemical agents

2.2.1. Resistance to atmospheric agents

Three new samples (lenses or samples of material) shall be exposed to radiation from a source having a spectral energy distribution similar to that of a black body at a temperature between 5,500K and 6,000K. Appropriate filters shall be placed between the source and the samples so as to reduce as far as possible radiations with wave lengths smaller than 295 nm and greater than 2,500 nm. The samples shall be exposed to an energetic illumination of $1,200 \text{ W/m}^2 \pm 200 \text{ W/m}^2$ for a period such that the luminous energy that they receive is equal to $4,500 \text{ MJ/m}^2 \pm 200 \text{ MJ/m}^2$. Within the enclosure, the temperature measured on the black panel placed on a level with the samples shall be $50 \pm 5 \text{ }^\circ\text{C}$. In order to ensure a regular exposure, the samples shall revolve around the source of radiation at a speed between 1 and 5 min^{-1} .

The samples shall be sprayed with distilled water of conductivity lower than 1 mS/m at a temperature of $23 \pm 5 \text{ }^\circ\text{C}$, in accordance with the following cycle:

Spraying: 5 minutes;

Drying: 25 minutes.

2.2.2. Resistance to chemical agents

After the test described in paragraph 2.2.1. above and the measurement described in paragraph 2.2.3.1. below have been carried out, the outer face of the said three samples shall be treated as described in paragraph 2.2.2.2. with the mixture defined in paragraph 2.2.2.1. below.

2.2.2.1. Test mixture

The test mixture shall be composed of 61.5 per cent n-heptane, 12.5 per cent toluene, 7.5 per cent ethyl tetrachloride, 12.5 per cent trichloroethylene and 6 per cent xylene (volume per cent).

2.2.2.2. Application of the test mixture

Soak a piece of cotton cloth (as per ISO 105) until saturation with the mixture defined in paragraph 2.2.2.1. above and, within 10 seconds, apply it for 10 minutes to the outer face of the sample at a pressure of 50 N/cm^2 , corresponding to an effort of 100 N applied on a test surface of $14 \times 14 \text{ mm}$.

During this 10-minute period, the cloth pad shall be soaked again with the mixture so that the composition of the liquid applied is continuously identical with that of the test mixture prescribed.

During the period of application, it is permissible to compensate the pressure applied to the sample in order to prevent it from causing cracks.

2.2.2.3. Cleaning

At the end of the application of the test mixture, the samples shall be dried in the open air and then washed with the solution described in paragraph 2.3. (Resistance to detergents) at $23 \pm 5 \text{ }^\circ\text{C}$.

Afterwards the samples shall be carefully rinsed with distilled water containing not more than 0.2 per cent impurities at 23 ± 5 °C and then wiped off with a soft cloth.

2.2.3. Results

2.2.3.1. After the test of resistance to atmospheric agents, the outer face of the samples shall be free from cracks, scratches, chipping and deformation, and the mean variation in transmission $\Delta_t = \frac{T_2 - T_3}{T_2}$, measured on the three samples according to the procedure described in Appendix 2 to this annex shall not exceed 0.020 ($\Delta_{tm} < 0.020$).

2.2.3.2. After the test of resistance to chemical agents, the samples shall not bear any traces of chemical staining likely to cause a variation of flux diffusion, whose mean variation $\Delta_d = \frac{T_5 - T_4}{T_2}$, measured on the three samples according to the procedure described in Appendix 2 to this annex shall not exceed 0.020 ($\Delta_{dm} < 0.020$).

2.2.4. Resistance to light source radiations

The following test shall be done:

Flat samples of each light transmitting plastic component of the headlamp are exposed to the light of the gas-discharge light source. The parameters such as angles and distances of these samples shall be the same as in the headlamp. These samples shall have the same colour and surface treatment, if any, as the parts of the headlamp.

After 1,500 hours of continuous exposure, the colorimetric specifications of the transmitted light must be met with a new standard gas-discharge light source, and the surfaces of the samples shall be free of cracks, scratches, scalings or deformation.

2.3. Resistance to detergents and hydrocarbons

2.3.1. Resistance to detergents

The outer face of three samples (lenses or samples of material) shall be heated to 50 ± 5 °C and then immersed for five minutes in a mixture maintained at 23 ± 5 °C and composed of 99 parts distilled water containing not more than 0.02 per cent impurities and one part alkylaryl sulphonate.

At the end of the test, the samples shall be dried at 50 ± 5 °C. The surface of the samples shall be cleaned with a moist cloth.

2.3.2. Resistance to hydrocarbons

The outer face of these three samples shall then be lightly rubbed for one minute with a cotton cloth soaked in a mixture composed of 70 per cent n-heptane and 30 per cent toluene (volume per cent), and shall then be dried in the open air.

2.3.3. Results

After the above two tests have been performed successively, the mean value of the variation in transmission $\Delta_t = \frac{T_2 - T_3}{T_2}$, measured on the three samples according to the procedure described in Appendix 2 to this annex shall not exceed 0.010 ($\Delta_{tm} < 0.010$).

2.4. Resistance to mechanical deterioration

2.4.1. Mechanical deterioration method

The outer face of the three new samples (lenses) shall be subjected to the uniform mechanical deterioration test by the method described in Appendix 3 to this annex.

2.4.2. Results

After this test, the variations:

In transmission:
$$\Delta t = \frac{T2 - T3}{T2}$$

And in diffusion:
$$\Delta d = \frac{T5 - T4}{T2}$$

Shall be measured according to the procedure described in Appendix 2 in the area specified in paragraph 2.2.4 above. The mean value of the three samples shall be such that:

$$\Delta t_m \leq 0.100;$$

$$\Delta d_m \leq 0.050.$$

2.5. Test of adherence of coatings, if any

2.5.1. Preparation of the sample

A surface of 20 mm x 20 mm in area of the coating of a lens shall be cut with a razor blade or a needle into a grid of squares approximately 2 mm x 2 mm. The pressure on the blade or needle shall be sufficient to cut at least the coating.

2.5.2. Description of the test

Use an adhesive tape with a force of adhesion of 2 N/(cm of width) \pm 20 per cent measured under the standardized conditions specified in Appendix 4 to this annex. This adhesive tape, which shall be at least 25 mm wide, shall be pressed for at least five minutes to the surface prepared as prescribed in paragraph 2.5.1.

Then the end of the adhesive tape shall be loaded in such a way that the force of adhesion to the surface considered is balanced by a force perpendicular to that surface. At this stage, the tape shall be torn off at a constant speed of 1.5 m/s \pm 0.2 m/s.

2.5.3. Results

There shall be no appreciable impairment of the gridded area. Impairments at the intersections between squares or at the edges of the cuts shall be permitted, provided that the impaired area does not exceed 15 per cent of the gridded surface.

2.6. Tests of the complete headlamp incorporating a lens of plastic material

2.6.1. Resistance to mechanical deterioration of the lens surface

2.6.1.1. Tests

The lens of lamp sample No. 1 shall be subjected to the test described in paragraph 2.4.1. above.

2.6.1.2. Results

After the test, the results of photometric measurements carried out on the headlamp in accordance with this Regulation shall not exceed:

- (a) By more than 30 per cent the maximum values prescribed at points B 50 L and by more than 10 per cent below the minimum values prescribed at point 75 R (in the case of headlamps intended for left-hand traffic, the points to be considered are B 50 R and 75 L);

Or

- (b) By more than 10 per cent below the minimum values prescribed for HV in the case of a headlamp producing driving-beam only.

2.6.2. Test of adherence of coatings, if any

The lens of lamp sample No. 2 shall be subjected to the test described in paragraph 2.5. above.

Annex 5 – Appendix 1

Chronological order of approval tests

A. Tests on plastic materials (lenses or samples of material supplied pursuant to paragraph 2.2.4. of this Regulation)

<i>Tests</i>	<i>Samples</i>	<i>Lenses or samples of material</i>									<i>Lenses</i>				
		<i>1</i>	<i>2</i>	<i>3</i>	<i>4</i>	<i>5</i>	<i>6</i>	<i>7</i>	<i>8</i>	<i>9</i>	<i>10</i>	<i>11</i>	<i>12</i>	<i>13</i>	<i>14</i>
1.1. Limited photometry (para. 2.1.2.)												x	x	x	
1.1.1. Temperature change (para. 2.1.1.)												x	x	x	
1.2. Limited photometry (para. 2.1.2.)												x	x	x	
1.2.1. Transmission measurement	x	x	x	x	x	x	x	x	x	x					
1.2.2. Diffusion measurement	x	x	x				x	x	x						
1.3. Atmospheric agents (para. 2.2.1.)	x	x	x												
1.3.1. Transmission measurement	x	x	x												
1.4. Chemical agents (para. 2.2.2.)	x	x	x												
1.4.1. Diffusion measurements	x	x	x												
1.5. Detergents (para. 2.3.1.)				x	x	x									
1.6. Hydrocarbons (para. 2.3.2.)				x	x	x									
1.6.1. Transmission measurement				x	x	x									
1.7. Deterioration (para. 2.4.1.)							x	x	x						
1.7.1. Transmission measurement							x	x	x						
1.7.2. Diffusion measurement							x	x	x						
1.8. Adherence (para. 2.5.)															x
1.9. Resistance to light source radiations (para. 2.2.4.)											x				

B. Tests on complete headlamps (supplied pursuant to paragraph 2.2.3. of this Regulation)

<i>Tests</i>	<i>Complete headlamp</i>	
	<i>Sample No.</i>	
	<i>1</i>	<i>2</i>
2.1. Deterioration (para. 2.6.1.1.1)	x	
2.2. Photometry (para. 2.6.1.2.)	x	
2.3. Adherence (para. 2.6.2.)		x

Annex 5 – Appendix 2

Method of measurement of the diffusion and transmission of light

1. Equipment (see figure)

The beam of a collimator K with a half divergence $\beta/2 = 17.4 \times 10^{-4}$ rd is limited by a diaphragm D_T with an opening of 6 mm against which the sample stand is placed.

A convergent achromatic lens L_2 , corrected for spherical aberrations, links the diaphragm D_T with the receiver R; the diameter of the lens L_2 shall be such that it does not diaphragm the light diffused by the sample in a cone with a half top angle of $\beta/2 = 14^\circ$.

An annular diaphragm D_D with angles $\alpha/2 = 1^\circ$ and $\alpha_{\max}/2 = 12^\circ$ is placed in an image focal plane of the lens L_2 .

The non-transparent central part of the diaphragm is necessary in order to eliminate the light arriving directly from the light source. It shall be possible to remove the central part of the diaphragm from the light beam in such a manner that it returns exactly to its original position.

The distance $L_2 D_T$ and the focal length F_2^1 of the lens L_2 shall be so chosen that the image of D_T completely covers the receiver R.

When the initial incident flux is referred to 1,000 units, the absolute precision of each reading shall be better than 1 unit.

¹ For L_2 it is recommended to use a focal distance of about 80 mm.

2. Measurements

The following readings shall be taken:

Reading	With sample	With central part of D_D	Quantity represented
T ₁	no	no	Incident flux in initial reading
T ₂	yes (before test)	no	Flux transmitted by the new material in a field of 24°
T ₃	yes (after test)	no	Flux transmitted by the tested material in a field of 24°
T ₄	yes (before test)	yes	Flux diffused by the new material
T ₅	yes (after test)	yes	Flux diffused by the tested material

Figure 1
 Optical setup for measurement of variations in diffusion and transmission

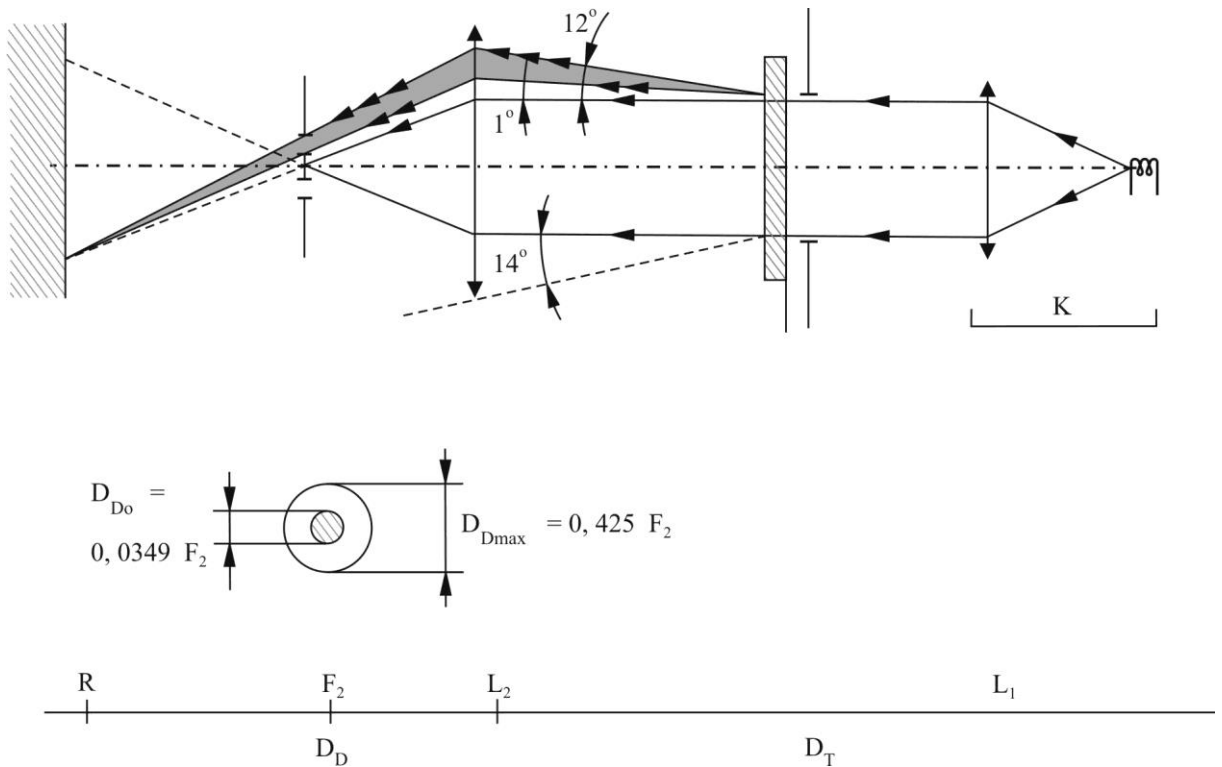

Annex 5 – Appendix 3

Spray testing method

1. Test equipment

1.1. Spray gun

The spray gun used shall be equipped with a nozzle 1.3 mm in diameter allowing a liquid flow rate of 0.24 ± 0.02 l/minute at an operating pressure of 6.0 bars $-0, +0.5$ bar.

Under these operation conditions the fan pattern obtained shall be $170 \text{ mm} \pm 50 \text{ mm}$ in diameter on the surface exposed to deterioration, at a distance of $380 \text{ mm} \pm 10 \text{ mm}$ from the nozzle.

1.2. Test mixture

The test mixture shall be composed of:

- (a) Silica sand of hardness 7 on the Mohr scale, with a grain size between 0 and 0.2 mm and an almost normal distribution, with an angular factor of 1.8 to 2;
- (b) Water of hardness not exceeding 205 g/m^3 for a mixture comprising 25 g of sand per litre of water.

2. Test

The outer surface of the lamp lenses shall be subjected once or more than once to the action of the sand jet produced as described above. The jet shall be sprayed almost perpendicular to the surface to be tested.

The deterioration shall be checked by means of one or more samples of glass placed as a reference near the lenses to be tested. The mixture shall be sprayed until the variation in the diffusion of light on the sample or samples measured by the method described in Appendix 2, is such that:

$$\Delta d = \frac{T_5 - T_4}{T_2} = 0.0250 \pm 0.0025$$

Several reference samples may be used to check that the whole surface to be tested has deteriorated homogeneously.

Annex 5 – Appendix 4

Adhesive tape adherence test

1. Purpose
This method allows to determine under standard conditions the linear force of adhesion of an adhesive tape to a glass plate.
2. Principle
Measurement of the force necessary to unstick an adhesive tape from a glass plate at an angle of 90°.
3. Specified atmospheric conditions
The ambient conditions shall be at 23 ± 5 °C and 65 ± 15 per cent relative humidity (RH).
4. Test pieces
Before the test, the sample roll of adhesive tape shall be conditioned for 24 hours in the specified atmosphere (see para. 3. above).
Five test pieces each 400 mm long shall be tested from each roll. These test pieces shall be taken from the roll after the first three turns were discarded.
5. Procedure
The test shall be under the ambient conditions specified in paragraph 3.
Take the five test pieces while unrolling the tape radially at a speed of approximately 300 mm/s, then apply them within 15 seconds in the following manner:
Apply the tape to the glass plate progressively with a slight lengthwise rubbing movement of the finger, without excessive pressure, in such a manner as to leave no air bubble between the tape and the glass plate.
Leave the assembly in the specified atmospheric conditions for 10 minutes.
Unstick about 25 mm of the test piece from the plate in a plane perpendicular to the axis of the test piece.
Fix the plate and fold back the free end of the tape at 90°. Apply force in such a manner that the separation line between the tape and the plate is perpendicular to this force and perpendicular to the plate.
Pull to unstick at a speed of $300 \text{ mm/s} \pm 30 \text{ mm/s}$ and record the force required.
6. Results
The five values obtained shall be arranged in order and the median value taken as the result of the measurement. This value shall be expressed in Newtons per centimetre of width of the tape.

Annex 6

Centre of reference

Diameter = a

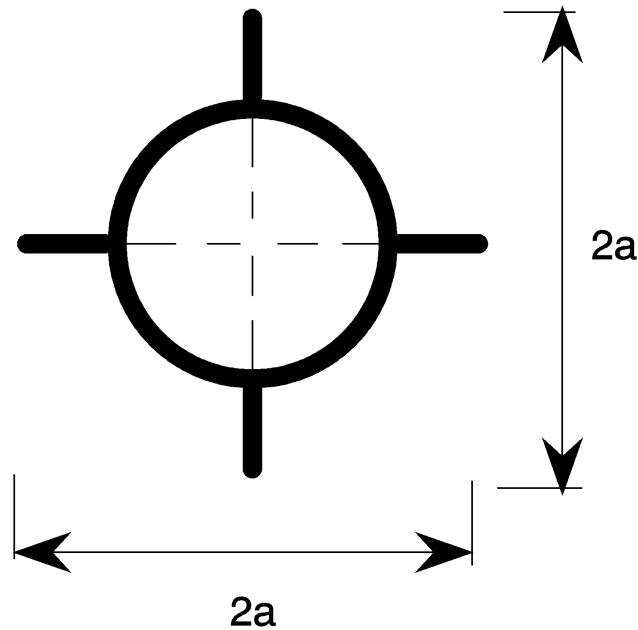

$a = 2 \text{ mm min.}$

This optional mark of the centre of reference shall be positioned on the lens at its intersection with the reference axis of the passing beam, and also on the lenses of the driving beams when they are neither grouped nor combined nor reciprocally incorporated with a passing beam.

The above drawing represents the mark of the centre of reference as projected on a plane substantially tangent to the lens about the centre of the circle. The lines constituting this mark may either be solid or dotted.

Annex 7

Voltage markings



This marking must be placed on the main body of each headlamp containing only gas discharge light sources and ballast, and on each external part of the ballast.

The ballast(s) is(are) designed for a ** volts network system.

This marking must be placed on the main body of each headlamp containing at least one gas discharge light source and ballast.

The ballast(s) is(are) designed for a ** volts network system.

None of the filament light sources and/or LED module(s) which the headlamp contains is designed for a 24 volts network system.

Annex 8

Minimum requirements for conformity of production control procedures

1. General
 - 1.1. The conformity requirements shall be considered satisfied from a mechanical and geometric standpoint, if the differences do not exceed inevitable manufacturing deviations within the requirements of this Regulation.
 - 1.2. With respect to photometric performance, the conformity of mass-produced headlamps shall not be contested if, when testing photometric performance of any headlamp chosen at random and measured at 13.2 ± 0.1 volts or as otherwise specified and:

Either

Equipped with a standard gas-discharge light source according to paragraph 6.1.3. The luminous flux of this gas-discharge light source may differ from the reference luminous flux specified in UN Regulation No. 99. In this case, the luminous intensities shall be corrected accordingly.

Or

Equipped with the serial production gas-discharge light source and the serial ballast. The luminous flux of this light source may deviate from the nominal luminous flux due to light source and ballast tolerances as specified in UN Regulation No. 99; accordingly the measured luminous intensities may be corrected by 20 per cent in the favourable direction.
 - 1.2.1. No luminous intensity value, if measured and corrected according to paragraph 1.2. above, deviates unfavourably by more than 20 per cent from the values prescribed in this Regulation. For values B 50 L (or R) and in Zone A, the maximum unfavourable deviation may be respectively:

B 50 L (or R): ¹	170 cd equivalent	20 per cent
	255 cd equivalent	30 per cent
Zone A	255 cd equivalent	20 per cent
	380 cd equivalent	30 per cent.
 - 1.2.2. Or if:
 - 1.2.2.1. For the passing beam, the values prescribed in this Regulation are met at one point within a circle of 0.35 degrees around points B 50 L (or R)¹ (with a tolerance of 85 cd), 75 R (or L), 50 V, 25 R1, 25 L2, and on segment I;
 - 1.2.2.2. And if, for the driving beam, HV being situated within the isocandela line $0.75 I_{\max}$, a tolerance of +20 per cent for maximum values and -20 per cent for minimum values is observed for the photometric values at any measuring point specified in paragraph 6.3. of this Regulation.
 - 1.2.3. If the results of the tests described above do not meet the requirements, the alignment of the headlamp may be changed, provided that the axis of the

¹ Letters in brackets refer to headlamps intended for left-hand traffic.

- beam is not displaced laterally by more than 0.5° to the right or left and not by more than 0.2° up or down.
- 1.2.4. If the results of the tests described above do not meet the requirements, tests on the headlamp shall be repeated using another standard gas-discharge light source or gas-discharge light source and ballast, whatever is applicable according to paragraph 1.2. above.
- 1.3. With respect to the verification of the change in vertical position of the cut-off line under the influence of heat, the following procedure shall be applied:
- One of the sampled headlamps shall be tested according to the procedure described in paragraph 2.1. of Annex 4 after being subjected three consecutive times to the cycle described in paragraph 2.2.2. of Annex 4.
- The headlamp shall be considered as acceptable if Δr (as defined in paragraphs 2.1. and 2.2. of Annex 4 to this Regulation) does not exceed 1.5 mrad.
- If this value exceeds 1.5 mrad but is not more than 2.0 mrad, a second headlamp shall be subjected to the test after which the mean of the absolute values recorded on both samples shall not exceed 1.5 mrad.
- 1.4. The chromaticity coordinates shall be complied with.
- 1.5. If, however, vertical adjustment cannot be performed repeatedly to the required position within the tolerances described in paragraph 6.2.2.3. of this Regulation, one sample shall be tested according to the procedure described in paragraphs 2. and 3. of Annex 10.
2. Minimum requirements for verification of conformity by the manufacturer
- For each type of headlamp the holder of the approval mark shall carry out at least the following tests, at appropriate intervals. The tests shall be carried out in accordance with the provisions of this Regulation.
- If any sampling shows non-conformity with respect to the type of test concerned, further samples shall be taken and tested. The manufacturer shall take steps to ensure the conformity of the production concerned.
- 2.1. Nature of tests
- Tests of conformity in this Regulation shall cover the photometric characteristics and the verification of the change in vertical position of the cut-off line under the influence of heat.
- 2.2. Methods used in tests
- 2.2.1. Tests shall generally be carried out in accordance with the methods set out in this Regulation.
- 2.2.2. In any test of conformity carried out by the manufacturer, equivalent methods may be used with the consent of the competent authority responsible for approval tests. The manufacturer is responsible for proving that the applied methods are equivalent to those laid down in this Regulation.
- 2.2.3. The application of paragraphs 2.2.1. and 2.2.2. requires regular calibrations of test apparatus and its correlation with measurements made by a competent authority.
- 2.2.4. In all cases the reference methods shall be those of this Regulation, particularly for the purpose of administrative verification and sampling.
- 2.3. Nature of sampling
- Samples of headlamps shall be selected at random from the production of a uniform batch. A uniform batch means a set of headlamps of the same type, defined according to the production methods of the manufacturer.

The assessment shall in general cover series production from individual factories. However, a manufacturer may group together records concerning the same type from several factories, provided these operate under the same quality system and quality management.

2.4. Measured and recorded photometric characteristics

The sampled headlamps shall be subjected to photometric measurements at the points provided for in the Regulation, the reading being limited to points I_{max} , HV², HL, HR³ in the case of the driving beam, and to points B 50 L (or R)¹, 50L (or R), 50 V, 75 R (or L) and 25 L2 (or R2) in the case of the passing beam (see figure in Annex 3).

2.5. Criteria governing acceptability

The manufacturer is responsible for carrying out a statistical study of the test results and for defining, in agreement with the competent authority, criteria governing the acceptability of his products in order to meet the specifications laid down for verification of conformity of products in paragraph 9.1. of this Regulation.

The criteria governing the acceptability shall be such that, with a confidence level of 95 per cent, the minimum probability of passing a spot check in accordance with Annex 9 (first sampling) would be 0.95.

² When the driving beam is reciprocally incorporated with the passing beam, HV in the case of the driving beam shall be the same measuring point as in the case of the passing beam.

³ HL and HR: points on "hh" located at 2.5 degrees to the left and to the right of point HV respectively.

Annex 9

Minimum requirements for sampling by an inspector

1. General
 - 1.1. The conformity requirements shall be considered satisfied from a mechanical and a geometric standpoint, in accordance with the requirements of this Regulation, if any, if the differences do not exceed inevitable manufacturing deviations.
 - 1.2. With respect to photometric performance, the conformity of mass-produced headlamps shall not be contested if, when testing photometric performance of any headlamp chosen at random and measured at $13.2 \text{ V} \pm 0.1 \text{ V}$ or as otherwise specified and:

Either

Equipped with a standard gas-discharge light source according to paragraph 6.1.3. The luminous flux of this gas-discharge light source may differ from the reference luminous flux specified in UN Regulation No. 99. In this case, the illuminances shall be corrected accordingly.

Or

Equipped with the serial production gas-discharge light source and the serial ballast. The luminous flux of this light source may deviate from the nominal luminous flux due to light source and ballast tolerances as specified in UN Regulation No. 99, accordingly the measured illuminances may be corrected by 20 per cent in the favourable direction.
 - 1.2.1. No measured value deviates unfavourably by more than 20 per cent from the values prescribed in this Regulation.

In the glare zone the maximum deviation may be respectively:

B 50 L (or R) ¹ :	170 cd equivalent 20 per cent
	255 cd equivalent 30 per cent
Zone A	255 cd equivalent 20 per cent
	380 cd equivalent 30 per cent.
 - 1.2.2. Or if
 - 1.2.2.1. For the passing beam, the values prescribed in this Regulation are met at one point within a circle of 0.35 degrees around points B 50 L (or R)¹ (with a tolerance of 85 cd), 75 R (or L), 50 V, 25 R1, 25 L2, and on segment I;
 - 1.2.2.2. And if, for the driving beam, HV being situated within the isolux line $0.75 I_{\max}$, a tolerance of +20 per cent for maximum values and -20 per cent for minimum values is observed for the photometric values at any measuring point specified in paragraph 6.3. of this Regulation. The reference mark is disregarded.
 - 1.2.3. If the results of the tests described above do not meet the requirements, the alignment of the headlamp may be changed, provided that the axis of the beam is not displaced laterally by more than 0.5° to the right or left and not by more than 0.2° up or down.

¹ Letters in brackets refer to headlamps intended for left-hand traffic.

- 1.2.4. If the results of the tests described above do not meet the requirements, tests on the headlamp shall be repeated using another standard gas-discharge light source or gas-discharge light source and ballast, whatever is applicable according to paragraph 1.2. above.
- 1.3. With respect to the verification of the change in vertical position of the cut-off line under the influence of heat, the following procedure shall be applied:
One of the sampled headlamps shall be tested according to the procedure described in paragraph 2.1. of Annex 4 after being subjected three consecutive times to the cycle described in paragraph 2.2.2. of Annex 4.
The headlamp shall be considered acceptable if Δr (as defined in paragraphs 2.1. and 2.2. of Annex 4 to this Regulation) does not exceed 1.5 mrad.
If this value exceeds 1.5 mrad but is not more than 2.0 mrad, a second headlamp shall be subjected to the test after which the mean of the absolute values recorded on both samples shall not exceed 1.5 mrad.
- 1.4. The chromaticity coordinates shall be complied with.
- 1.5. If, however, vertical adjustment cannot be performed repeatedly to the required position within the tolerances described in paragraph 6.2.2.3. of this Regulation, one sample shall be tested according to the procedure described in paragraphs 2. and 3. of Annex 10.
2. First sampling
In the first sampling four headlamps are selected at random. The first sample of two is marked A, the second sample of two is marked B.
- 2.1. The conformity of mass-produced headlamps shall not be contested if the deviation of any specimen of samples A and B (all four lamps) is not more than 20 per cent.
In the case, that the deviation of both lamps of sample A is not more than 0 per cent the measurement can be closed.
- 2.2. The conformity of mass-produced headlamps shall be contested if the deviation of at least, one specimen of samples A or B is more than 20 per cent.
The manufacturer shall be requested to bring his production in line with the requirements (alignment) and a repeated sampling according to paragraph 3. below shall be carried out within two months' time after the notification. The samples A and B shall be retained by the Technical Service until the entire CoP process is finished.
3. First repeated sampling
A sample of four lamps is selected at random from stock manufactured after alignment.
The first sample of two is marked C, the second sample of two is marked D.
- 3.1. The conformity of mass-produced headlamps shall not be contested if the deviation of any specimen of samples C and D (all four lamps) is not more than 20 per cent.
In the case, that the deviation of both lamps of sample C is not more than 0 per cent, the measurement can be closed.
- 3.2. The conformity of mass-produced headlamps shall be contested if the deviation of at least:
- 3.2.1. One specimen of samples C or D is more than 20 per cent but the deviation of all specimen of these samples is not more than 30 per cent.

- The manufacturer shall be requested again to bring his production in line with the requirements (alignment).
- A second repeated sampling according to paragraph 4. below shall be carried out within two months' time after the notification. The samples C and D shall be retained by the Technical Service until the entire CoP process is finished.
- 3.2.2. One specimen of samples C or D is more than 30 per cent.
- In this case the approval shall be withdrawn and paragraph 5. below shall be applied.
4. Second repeated sampling
- A sample of four lamps is selected at random from stock manufactured after alignment.
- The first sample of two is marked E, the second sample of two is marked F.
- 4.1. The conformity of mass-produced headlamps shall not be contested if the deviation of any specimen of samples E and F (all four lamps) is not more than 20 per cent.
- In the case, that the deviation of both lamps of sample E is not more than 0 per cent the measurement can be closed.
- 4.2. The conformity of mass-produced headlamps shall be contested if the deviation of at least one specimen of samples E or F is more than 20 per cent.
- In this case the approval shall be withdrawn and paragraph 5. below shall be applied.
5. Approval withdrawn
- Approval shall be withdrawn according to paragraph 10. of this Regulation.
6. Change of the vertical position of the cut-off line
- With respect to the verification of the change in vertical positions of the cut-off line under the influence of heat, the following procedure shall be applied:
- One of the headlamps of sample A shall be tested according to the procedure described in paragraph 2.1. of Annex 4 after being subjected three consecutive times to the cycle described in paragraph 2.2.2. of Annex 4.
- The headlamp shall be considered as acceptable if Δr does not exceed 1.5 mrad upwards and does not exceed 2.5 mrad downwards.
- If this value exceeds 1.5 mrad but is not more than 2.0 mrad upwards or exceeds 2.5 mrad but is not more than 3.0 mrad downwards, the second headlamp of sample A shall be subjected to the test after which the mean of the absolute values recorded in both samples shall not exceed 1.5 mrad upwards and shall not exceed 2.5 mrad downwards.
- However, if this value of 1.5 mrad upwards and 2.5 mrad downwards on sample A is not complied with, the two headlamps of sample B shall be subjected to the same procedure and the value of Δr for each of them shall not exceed 1.5 mrad upwards and shall not exceed 2.5 mrad downwards.

Annex 10

Instrumental verification of the "cut-off" for passing beam headlamps

1. General

In the case where paragraph 6.2.2.4. of this Regulation applies, the quality of the "cut-off" shall be tested according to the requirements set out in paragraph 2. below and the instrumental vertical and horizontal adjustment of the beam shall be performed according to the requirements set out in paragraph 3. below.

Before carrying out the measurement of the quality of "cut-off" and the instrumental aiming procedure, a visual pre-aim in accordance with paragraphs 6.2.2.1. and 6.2.2.2. of this Regulation is required.

2. Measurement of the quality of the "cut-off"

To determine the minimum sharpness, measurements shall be performed by vertically scanning through the horizontal part of the "cut-off" in angular steps of 0.05° at either a measurement distance of:

- (a) 10 m with a detector having a diameter of approximately 10 mm or
- (b) 25 m with a detector having a diameter of approximately 30 mm.

The measuring distance at which the test was carried out shall be recorded in item 9. of the communication form (see Annex 1 of this Regulation).

To determine the maximum sharpness, measurements shall be performed by vertically scanning through the horizontal part of the "cut-off" in angular steps of 0.05° exclusively at a measurement distance of 25 m and with a detector having a diameter of approximately 30 mm.

The "cut-off" quality shall be considered acceptable if the requirements of paragraph 2.1. to 2.3. below comply with at least one set of measurements.

2.1. Not more than one "cut-off" shall be visible¹

2.2. Sharpness of "cut-off"

The sharpness factor G is determined by scanning vertically through the horizontal part of the "cut-off" at 2.5° from the V-V where:

$G = (\log E\beta - \log E(\beta + 0.1^\circ))$ where β = the vertical position in degrees.

The value of G shall not be less than 0.13 (minimum sharpness) and not greater than 0.40 (maximum sharpness).

¹ This paragraph should be amended when an objective test method is available.

2.3. Linearity

The part of the horizontal "cut-off" that serves for vertical adjustment shall be horizontal between 1.5° and 3.5° from the V-V line (see figure 1 below).

- (a) The inflection points of the "cut-off" gradient at the vertical lines at 1.5°, 2.5° and 3.5° shall be determined by the equation:

$$(d^2 (\log E) / d\beta^2 = 0).$$

- (b) The maximum vertical distance between the inflection points determined shall not exceed 0.2 °.

3. Vertical and horizontal adjustment

If the "cut-off" complies with the quality requirements of paragraph 2. of this annex, the beam adjustment may be performed instrumentally.

Figure 1
Measurement of "cut-off" quality

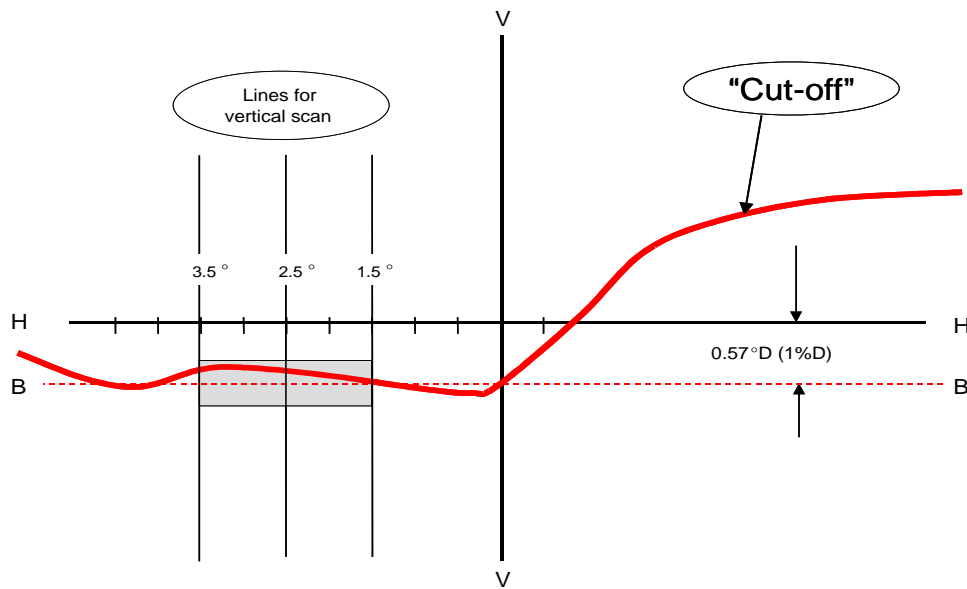

Note: The scales are different for vertical and horizontal lines.

3.1. Vertical adjustment

Moving upward from below the line B (see figure 2 below), a vertical scan is carried out through the horizontal part of the "cut-off" at 2.5° from V-V. The inflection point (where $d^2 (\log E) / dv^2 = 0$) is determined and positioned on the line B situated one per cent below H-H.

3.2. Horizontal adjustment

The applicant shall specify one of the following horizontal aim methods:

- a) The "0.2 D line" method (see figure 2 below).

A single horizontal line at 0.2° D shall be scanned from 5° left to 5° right after the lamp has been aimed vertically. The maximum gradient "G" determined using the formula $G = (\log E\beta - \log E(\beta + 0.1^\circ))$ where β is the horizontal position in degrees, shall not be less than 0.08.

The inflection point found on the 0.2 D line shall be positioned on the line A.

Figure 2
Instrumental vertical and horizontal adjustment – Horizontal line scan method

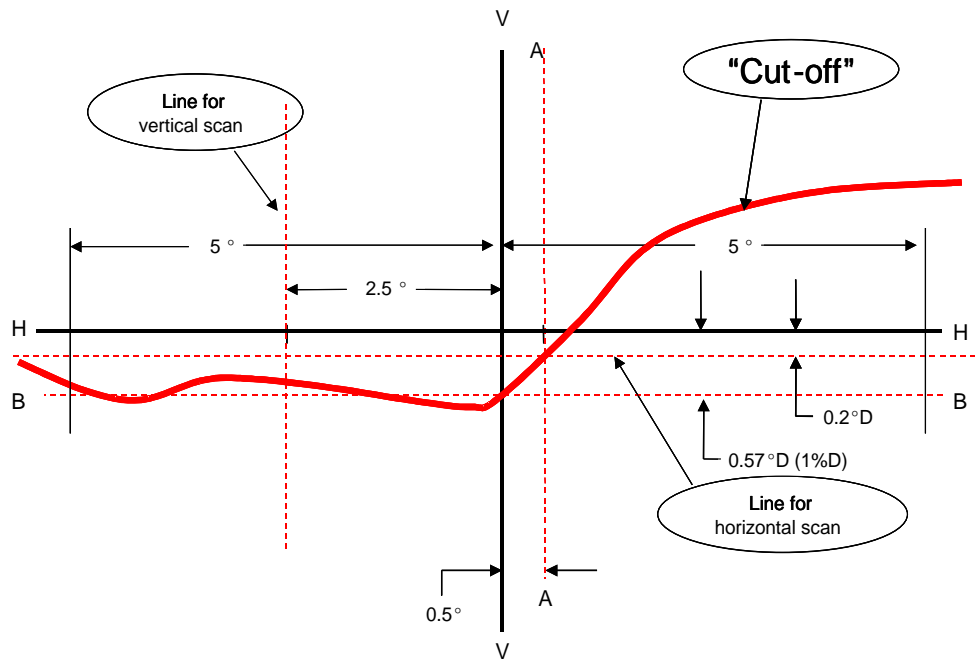

Note: The scales are different for vertical and horizontal lines.

(b) The "3 line" method (see figure 3 below)

Three vertical lines shall be scanned from 2° D to 2° U at 1°R, 2°R, and 3°R after the lamp has been aimed vertically. The respective maximum gradients "G" determined using the formula:

$$G = (\log E_{\beta} - \log E_{(\beta + 0.1^{\circ})})$$

Where β is the vertical position in degrees, shall not be less than 0.08. The inflection points found on the three lines shall be used to derive a straight line. The intersection of this line and the line B found while performing vertical aim shall be placed on the V line.

Figure 3
Instrumental vertical and horizontal adjustment – Three line scan method

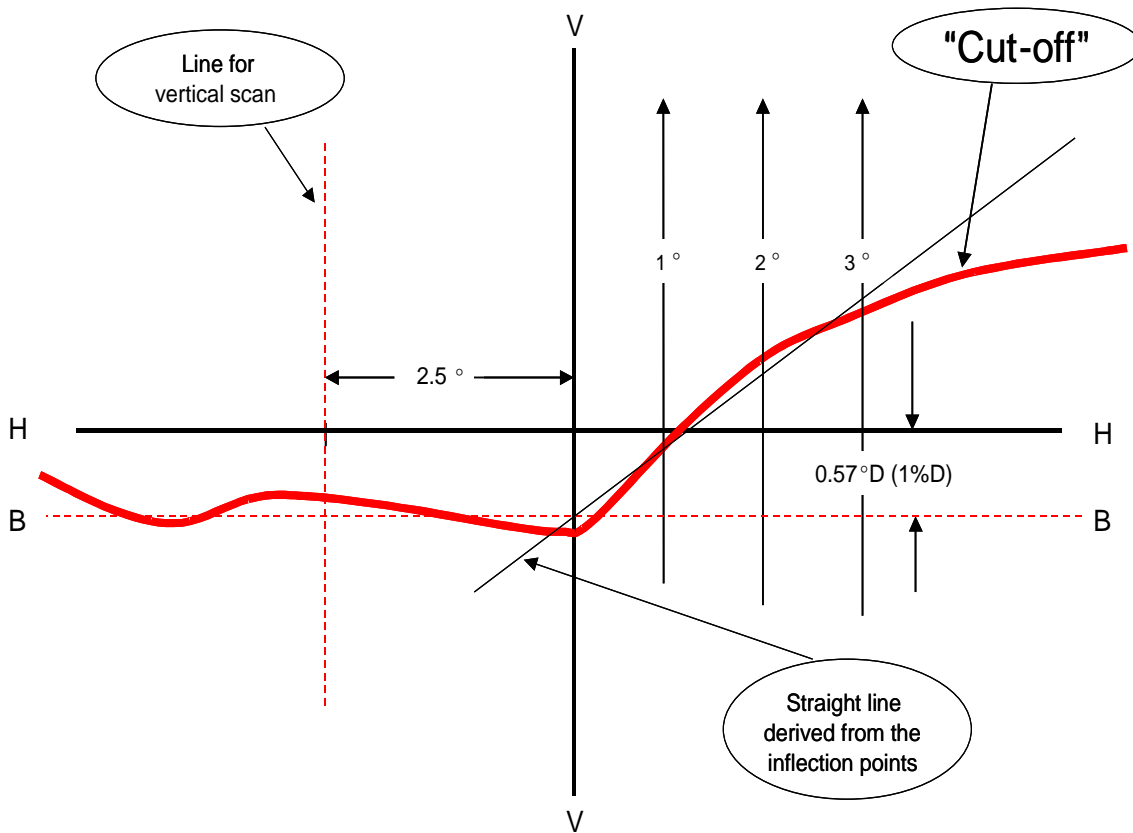

Note: The scales are different for vertical and horizontal lines.

Annex 11

Requirements for LED modules and headlamps including LED modules

1. General specifications
 - 1.1. Each LED module sample submitted shall conform to the relevant specifications of this Regulation when tested with the supplied electronic light source control-gear(s), if any.
 - 1.2. LED module(s) shall be so designed as to be and to remain in good working order when in normal use. They shall moreover exhibit no fault in design or manufacture.
 - 1.3. LED module(s) shall be tamperproof.
 - 1.4. The design of removable LED module(s) shall be such that:
 - 1.4.1. When the LED module is removed and replaced with another module provided by the applicant and bearing the same light source module identification code, the photometric specifications of the headlamp shall be met;
 - 1.4.2. LED modules with different light source module identification codes within the same lamp housing, shall not be interchangeable.
 - 1.5. Electronic light source control gear(s) may be part of the LED module(s).
2. Manufacture
 - 2.1. The LED(s) on the LED module shall be equipped with suitable fixation elements.
 - 2.2. The fixation elements shall be strong and firmly secured to the LED(s) and the LED module.
3. Test conditions
 - 3.1. Application
 - 3.1.1. All samples shall be tested as specified in paragraph 4. below;
 - 3.1.2. The kind of light sources on a LED MODULE shall be light emitting diodes (LED) as defined in UN Regulation No. 48 paragraph 2.7.1. in particular with regard to the element of visible radiation. Other kinds of light sources are not permitted.
 - 3.2. Operating conditions
 - 3.2.1. LED module operating conditions

All samples shall be tested under the conditions as specified in paragraphs 6.2.4.4. of this Regulation. If not specified differently in this annex LED modules shall be tested inside the headlamp as submitted by the manufacturer.
 - 3.2.2. Ambient temperature

For the measurement of electrical and photometric characteristics, the headlamp shall be operated in dry and still atmosphere at an ambient temperature of $23\text{ °C} \pm 5\text{ °C}$.
 - 3.3. Ageing

Upon the request of the applicant the LED module shall be operated for 15 h and cooled down to ambient temperature before starting the tests as specified in this Regulation.

4. Specific requirements and tests

4.1. UV-radiation

The UV-radiation of a LED module shall be such that:

$$k_{UV} = \frac{\int_{\lambda=250 \text{ nm}}^{400 \text{ nm}} E_e(\lambda) S(\lambda) d\lambda}{k_m \int_{\lambda=380 \text{ nm}} E_e(\lambda) V(\lambda) d\lambda} \leq 10^{-5} \text{ W / lm}$$

Where:

$S(\lambda)$ (unit: 1) is the spectral weighting function;

$k_m = 683 \text{ lm/W}$ is the maximum value of the luminous efficacy of radiation.

(For definitions of the other symbols see paragraph 4.1.1. of Annex 9 to UN Regulation No. 112).

This value shall be calculated using intervals of one nanometre. The UV-radiation shall be weighted according to the values as indicated in the Table UV below:

Table UV

Values according to "IRPA/INIRC Guidelines on limits of exposure to ultraviolet radiation".
Wavelengths (in nanometres) chosen are representative; other values should be interpolated.

λ	$S(\lambda)$	λ	$S(\lambda)$	λ	$S(\lambda)$
250	0.430	305	0.060	355	0.000 16
255	0.520	310	0.015	360	0.000 13
260	0.650	315	0.003	365	0.000 11
265	0.810	320	0.001	370	0.000 09
270	1.000	325	0.000 50	375	0.000 077
275	0.960	330	0.000 41	380	0.000 064
280	0.880	335	0.000 34	385	0.000 053
285	0.770	340	0.000 28	390	0.000 044
290	0.640	345	0.000 24	395	0.000 036
295	0.540	350	0.000 20	400	0.000 030
300	0.300				