

**Economic and Social Council**Distr.: General  
7 March 2012

Original: English

---

**Economic Commission for Europe****Inland Transport Committee****World Forum for Harmonization of Vehicle Regulations****Working Party on Passive Safety****Fifty-first session**

Geneva, 21–25 April 2012

Item 8 of the provisional agenda

**Hydrogen and fuel cell vehicles****Draft global technical regulation (gtr) on hydrogen fuelled vehicle****Submitted by the expert of the United States of America\***

The text reproduced below was prepared by the expert from the United States of America following the discussion on the proposal of a UN Global Technical Regulation (UN GTR) on safety of hydrogen fuel cell vehicle. It is based on a document without symbol (GRSP-50-19-Rev.1) amending ECE/TRANS/WP.29/GRSP/2011/33, distributed during the fiftieth session of the Working Party on Passive Safety (GRSP) (see ECE/TRANS/WP.29/GRSP/50, para. 14). The modifications to the current text of the draft UN GTR (ECE/TRANS/WP.29/GRSP/2011/33) are marked in bold for new or strikethrough for deleted characters.

---

\* In accordance with the programme of work of the Inland Transport Committee for 2010–2014 (ECE/TRANS/208, para. 106 and ECE/TRANS/2010/8, programme activity 02.4), the World Forum will develop, harmonize and update Regulations in order to enhance the performance of vehicles. The present document is submitted in conformity with that mandate.

## Contents

	<i>Page</i>
I. Statement of technical rationale and justification .....	4
A. Introduction .....	4
B. gtr action plan .....	4
C. Description of typical hydrogen-fuelled fuel cell vehicles (HFCVS).....	6
1. Vehicle description.....	6
2. Hydrogen fuelling system .....	7
3. Hydrogen storage system .....	8
4. Hydrogen fuel delivery system.....	10
5. Fuel cell system .....	10
6. Electric propulsion and power management system .....	11
D. Rationale for scope, definitions and applicability.....	11
1. Rationale for paragraph 2 (Scope).....	11
2. Rationale for paragraphs 3.16. and 3.17. (Definitions of service life and date of removal from service) .....	12
3. Rationale for paragraph 4 (Applicability of requirements) .....	12
E. Rationale for paragraph 5 (Performance requirements and scope).....	12
1. Compressed hydrogen storage system requirements and safety needs.....	12
2. Vehicle fuel system requirements and safety needs .....	29
3. Electrical safety requirements and safety needs .....	33
F. Rationale for storage and fuel system test procedures .....	36
1. Rationale for storage and fuel system integrity tests .....	36
2. Rationale for paragraph 6.2. (Test procedures for compressed hydrogen storage) .....	38
G. Optional Requirements: vehicles with liquefied hydrogen storage systems: rationale.....	38
1. Background Information for liquefied hydrogen storage systems.....	39
2. Rationale for liquefied hydrogen storage system design qualification requirements .....	40
3. Rationale for vehicle fuel system design qualification requirements (LH2) .....	43
4. Rationale for test procedures for LHSSs .....	43
5. Rationale for paragraph 7.5. (Test procedure for post-crash concentration measurement for vehicles with liquefied hydrogen storage systems (LHSSs)).....	43
H. National provisions for material compatibility (including hydrogen embrittlement) and conformity of Production.....	47
1. Material compatibility and hydrogen embrittlement .....	47
2. National requirements complimentary to gtr requirements .....	47
I. Topics for the next phase in the developing of the gtr for hydrogen-fuelled vehicles.....	47

---

J.	Existing Regulations, Directives, and International Standards .....	49
1.	Vehicle fuel system integrity .....	49
2.	Storage system.....	49
3.	Electric safety .....	50
K.	Benefits and Costs .....	51
B.	Text of the Regulation.....	53
1.	Purpose .....	53
2.	Scope .....	53
3.	Definition.....	53
4.	Applicability of requirements .....	57
5.	Performance requirements .....	57
5.1.	Compressed hydrogen storage system.....	57
5.2.	Vehicle fuel system .....	63
5.3.	Electrical safety .....	66
6.	Test Conditions and procedures .....	71
6.1.	Compliance tests for fuel system integrity .....	71
6.2.	Test Procedures for compressed hydrogen storage .....	76
6.3.	Test procedures for electrical safety .....	93
7.	Vehicles with liquid hydrogen storage systems (LHSSs) .....	105
7.1.	LHSS optional requirements .....	105
7.2.	LHSS design qualification requirements.....	105
7.3.	LHSS fuel system integrity .....	108
7.4.	Test procedures for LHSS design qualification .....	109
7.5.	Test procedures for LHSS fuel system .....	115

## **I. Statement of technical rationale and justification**

### **A. Introduction**

1. In the ongoing debate over the need to identify new sources of energy and to reduce greenhouse gas emissions, companies around the world have explored the use of various alternative fuels, including compressed natural gas, liquefied propane gas and hydrogen. Hydrogen has emerged as one of the most promising alternatives due to its vehicle emissions being virtually zero. In the late 1990s, the European Community allocated resources to study the issue under its European Integrated Hydrogen Project (EIHP) and forwarded the results, two proposals for compressed gaseous and liquefied hydrogen, to the UNECE secretariat. The follow-up project, EIHP2, initiated discussions about the possibility of a global technical regulation for hydrogen fuelled vehicles. A few years later, the United States of America outlined a vision for a global initiative, the International Partnership for the Hydrogen Economy, and invited China, Japan, the Russian Federation, the European Union and many other countries to participate in this effort.

2. For decades scientists, researchers and economists have pointed to hydrogen, in both compressed gaseous and liquid forms, as a possible alternative to gasoline and diesel as a vehicle fuel. Ensuring the safe use of hydrogen as a fuel is a critical element in successful transitioning to a global hydrogen economy. By their nature, all fuels present an inherent degree of danger due to their energy content. The safe use of hydrogen, particularly in the compressed gaseous form, lies in preventing catastrophic failures involving a combination of fuel, air and ignition sources as well as pressure and electrical hazards.

3. Governments have identified the development of regulations and standards as one of the key requirements for commercialization of hydrogen-fuelled vehicles. Regulations and standards will help overcome technological barriers to commercialization, facilitate manufacturers' investment in building hydrogen-fuelled vehicles and facilitate public acceptance by providing a systematic and accurate means of assessing and communicating the risk associated with the use of hydrogen vehicles, be it to the general public, consumer, emergency response personnel or the insurance industry.

4. The development of this United Nations global technical regulation (gtr) for Hydrogen and Fuel Cell Vehicles occurred within the World Forum for Harmonization of Vehicle Regulations (WP.29) of the Inland Transport Committee (ITC) of UNECE. The goals of this global technical regulation (gtr) are to develop and establish a gtr for hydrogen-fuelled vehicles that: (i) attains or exceeds the equivalent levels of safety of those for conventional gasoline fuelled vehicles; and (ii) is performance-based and does not restrict future technologies.

### **B. gtr action plan**

5. Given that hydrogen-fuelled vehicle technology is still emerging, the Executive Committee of the 1998 Agreement (WP.29/AC.3) of WP.29 agreed that input from researchers is a vital component of this effort. Using existing regulations and standards of hydrogen and fuel cell vehicles (HFCVs) and conventional vehicles as a guide, it is important to investigate and consider: (1) the main differences between conventional vehicles and hydrogen-fuelled vehicles in safety and environmental issues; and, (2) the technical justification for requirements that would be applied to hydrogen-fuelled vehicles.

6. In June 2005, WP.29/AC.3 agreed to a proposal from Germany, Japan and United States of America regarding how best to manage the development process for a gtr on

hydrogen-fuelled vehicles (ECE/TRANS/WP.29/AC.3/17). Under the agreed-upon process, AC.3 approved an action plan for developing a gtr submitted by the co-sponsors. Two subgroups were formed to address the safety and the environment aspects of the gtr. The informal working subgroup on safety for hydrogen and fuel cell vehicles (HFCV-SGS) reported to the WP.29 subsidiary Working Party on Passive Safety (GRSP). HFCV-SGS was chaired by Japan and the United States of America. The Chair for the group was designated in the summer of 2007. The environmental subgroup (HFCV-SGE) was chaired by the European Commission and reported to the WP.29 subsidiary Working Party on Pollution and Energy (GRPE). In order to ensure communication between the subgroups and continuous engagement with WP.29 and AC.3, the project manager (Germany) coordinated and managed the various aspects of the work to ensure that the agreed action plan was implemented properly and that milestones and timelines were set and met throughout the development of the gtr. The initial stage of the gtr covered fuel cell (FC) and internal combustion engine (ICE), compressed gaseous hydrogen (CGH<sub>2</sub>) and liquid hydrogen (LH<sub>2</sub>) gtr. At a subsequent session of WP.29, the gtr action plan was submitted and approved by AC.3 (ECE/TRANS/WP.29/2007/41).

7. In order to develop the gtr in the context of evolving hydrogen technologies, the trilateral group of co-sponsors proposes to develop the gtr in two phases:

(a) Phase 1 (gtr for hydrogen-fuelled vehicles):

Establish a gtr by 2010 for hydrogen-fuelled vehicles based on a combination of component-, subsystem-, and vehicle-level requirements. The gtr specifies that each Contracting Party will use its existing national crash tests where vehicle crash tests are required, but and will use the agreed upon maximum allowable level of hydrogen leakage as the crash test leakage requirement. The new Japanese national regulation, any available research and test data will be used as a basis for developing this first phase of the gtr.

(b) Phase 2 (Assess future technologies and harmonize crash tests):

Amend the gtr to maintain its relevance with new findings based on new research and the state of the technology beyond phase 1. Discuss how to harmonize crash test requirements for HFCV regarding whole vehicle crash testing for fuel system integrity.

8. The gtr will consist of the following key elements:

(a) Component and subsystem level requirements (non-crash test based):

Evaluate the non-crash requirements by reviewing analyses and evaluations conducted to justify the requirements. Add and subtract requirements or amend test procedures as necessary, based on existing evaluations or on quick evaluations that could be conducted by Contracting Parties and participants. Avoid design specific requirements to the extent possible and do not include provisions that are not technically justified. The main areas of focus are:

- (i) Performance requirements for hydrogen storage systems, high-pressure closures, pressure relief devices, and fuel lines;
- (ii) Electrical isolation, safety and protection against electric shock (in use);
- (iii) Performance and other requirements for subsystem integration in the vehicle.

(b) Vehicle-level requirements:

Examine the risks posed by the different types of fuel systems in different crash modes. Review and evaluate analyses and crash tests conducted to examine the risks and identify appropriate mitigating measures for hydrogen-fuelled vehicles. The main areas of focus are as follows:

- (i) In-use and post-crash limits on hydrogen releases. Post-crash leakage limits apply following execution of crash tests (front, side and rear) that are specified in national requirements for crash safety testing in each jurisdiction;
- (ii) In-use and post-crash requirements for electrical isolation and protection against electric shock. Post-crash electrical safety criteria apply following execution of crash tests (front, side and rear) that are specified in national requirements for crash safety testing in each jurisdiction.

## **C. Description of typical hydrogen-fuelled fuel cell vehicles (HFCVS)**

### **1. Vehicle description**

9. Hydrogen fuelled vehicles can use either internal combustion engine (ICEs) or fuel cells to provide power; however, hydrogen-fuelled vehicles are typically powered by fuel cell power systems. Hydrogen-fuelled fuel cell vehicles (HFCVs) have an electric drive-train powered by a fuel cell that generates electric power electrochemically using hydrogen. In general, HFCVs are equipped with other advanced technologies that increase efficiency, such as regenerative braking systems that capture the kinetic energy lost during braking and store it in a battery or ultra-capacitors. While the various HFCVs are likely to differ in the details of the systems and hardware/software implementations, the following major systems are common to most HFCVs:

- (a) Hydrogen fuelling system;
- (b) Hydrogen storage system;
- (c) Hydrogen fuel delivery system;
- (d) Fuel cell system;
- (e) Electric propulsion and power management system.

10. A high-level schematic depicting the functional interactions of the major systems in a hydrogen-fuelled fuel cell vehicle (HFCV) is shown in Figure 1. During fuelling, hydrogen is supplied to the vehicle through the fuelling receptacle and flows to the hydrogen storage system. The hydrogen supplied to and stored within the hydrogen storage system can be either compressed gaseous or liquefied hydrogen. When the vehicle is started, hydrogen gas is released from the hydrogen storage system. Pressure regulators and other equipment within the hydrogen delivery system reduce the pressure to the appropriate level for operation of the fuel cell system. The hydrogen is electro-chemically combined with oxygen (from air) within the fuel cell system to produce high-voltage electric power. That electric power is supplied to the electric propulsion power management system where it is used to power electric drive motors and/or charge batteries and ultra-capacitors.

Figure 1  
Example of High-level Schematic of Key Systems in HFCVs

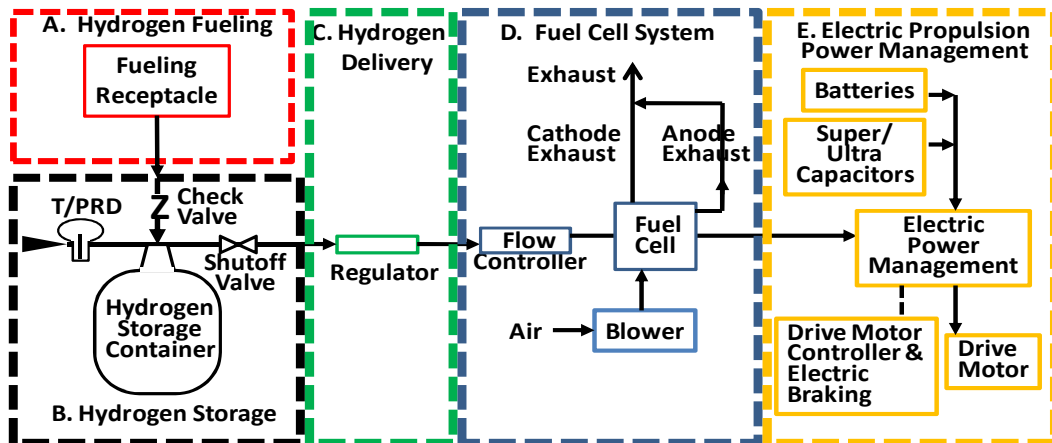

11. Figure 2 illustrates a typical layout of key components in the major systems of a typical hydrogen fuel cell vehicle (HFCV). The fuelling receptacle is shown in a typical position on the rear quarter panel of the vehicle. As with gasoline containers, hydrogen storage containers, whether compressed gas or liquefied hydrogen, are usually mounted transversely in the rear of the vehicle, but could also be mounted differently, such as lengthwise in the middle tunnel of the vehicle. Fuel cells and ancillaries are usually located (as shown) under the passenger compartment or in the traditional "engine compartment," along with the power management, drive motor controller, and drive motors. Given the size and weight of traction batteries and ultra-capacitors, these components are usually located in the vehicle to retain the desired weight balance for proper handling of the vehicle.

12. A typical arrangement of componentry of a hydrogen fuelled vehicle with compressed hydrogen storage and powered by a fuel cell is shown in Figure 2.

Figure 2  
Example of a hydrogen fuel cell vehicle

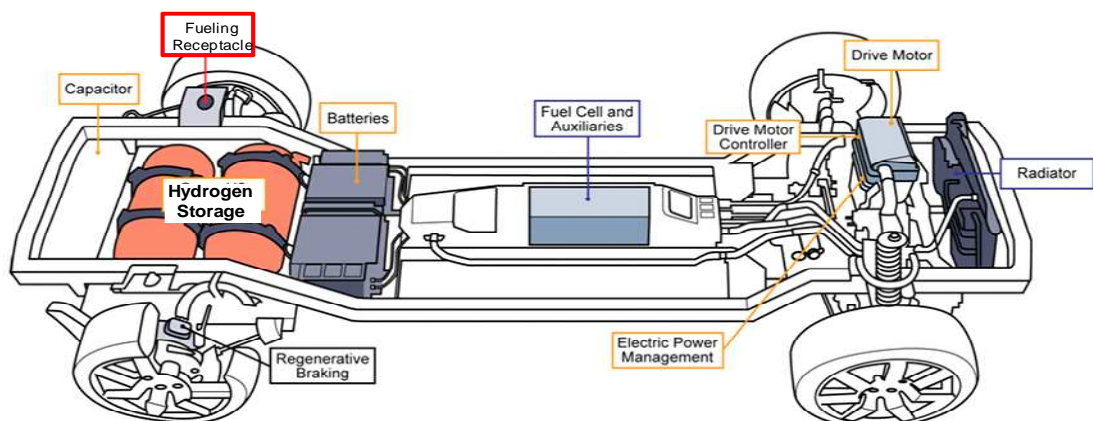

## 2. Hydrogen fuelling system

13. Either liquefied or compressed gas may be supplied to the vehicle at a fuelling station, depending on the type of hydrogen storage system in the vehicle. At present, hydrogen is most commonly dispensed to vehicles as a compressed gas that is dispensed at

pressures up to 125 per cent of the nominal working pressure (NWP) of the vehicle to compensate for transient heating from adiabatic compression during fuelling.

14. Regardless of the state of the hydrogen, the vehicles are fuelled through a special fuelling nozzle on the fuel dispenser at the fuelling station that connects with the fuelling receptacle on the vehicle to provide a "closed system" transfer of hydrogen to the vehicle. The fuelling receptacle on the vehicle contains a check valve (or other device) that prevents leakage of hydrogen out of the vehicle when the fuelling nozzle is disconnected.

### 3. Hydrogen storage system

15. The hydrogen storage system consists of all components that form the primary high pressure boundary for containment of stored hydrogen. The key functions of the hydrogen storage system are to receive hydrogen during fuelling, contain the hydrogen until needed, and then release the hydrogen to the fuel cell system for use in powering the vehicle. At present, the most common method of storing and delivering hydrogen fuel on-board is in compressed gas form. Hydrogen can also be stored as liquid (at cryogenic conditions). Each of these types of hydrogen storage systems are described in the following sections.

16. Additional types of hydrogen storage, such as cryo-compressed storage, may be covered in future revisions of this grt once their development has matured. Cryo-Compressed Hydrogen (CCH<sub>2</sub>) storage is a hybrid between liquid and compressed gas storage which can be fuelled with both cryogenic-compressed and compressed hydrogen gas.

#### (a) *Compressed hydrogen storage system*

17. Components of a typical compressed hydrogen storage system are shown in Figure 3. The system includes the container and all other components that form the "primary pressure boundary" that prevents hydrogen from escaping the system. In this case, the following components are part of the compressed hydrogen storage system:

- (a) the container;
- (b) the check valve;
- (c) the shut-off valve;
- (d) the thermally-activated pressure relief device (TPRD).



Figure 3  
**Typical compressed hydrogen storage system**

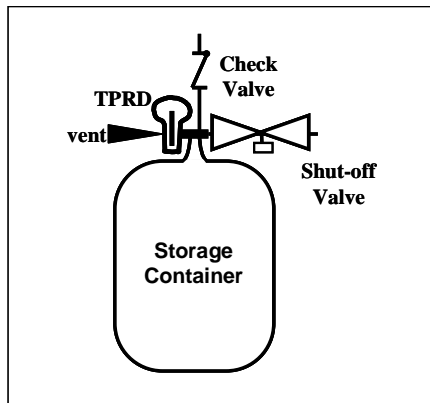

18. The hydrogen storage containers store the compressed hydrogen gas. A hydrogen storage system may contain more than one container depending on the amount that needs to be stored and the physical constraints of the particular vehicle. Hydrogen fuel has a low energy density per unit volume. To overcome this limitation, compressed hydrogen storage containers store the hydrogen at very high pressures. On current development vehicles (prior to 2011), hydrogen has typically been stored at a nominal working pressure of 35 MPa or 70 MPa, with maximum fuelling pressures of 125 per cent of nominal working pressure (43.8 MPa or 87.5 MPa respectively). During the normal "fast fill" fuelling process, the pressure inside the container(s) may rise to 25 per cent above the nominal working pressure as adiabatic compression of the gas causes heating within the containers. As the temperature in the container cools after fuelling, the pressure is reduced. By definition, the settled pressure of the system will be equal to the nominal working pressure when the container is at 15 °C. Different pressures (that are higher or lower or in between current selections) are possible in the future as commercialization proceeds.

19. Containers are currently constructed from composite materials in order to meet the challenge of high pressure containment of hydrogen at a weight that is acceptable for vehicular applications. Most high pressure hydrogen storage containers used in fuel cell vehicles consist of two layers: an inner liner that prevents gas leakage/permeation (usually made of metal or thermoplastic polymer), and an outer layer that provides structural integrity (usually made of metal or thermoset resin-impregnated fibre-reinforced composite wrapped over the gas-sealing inner liner).

20. During fuelling, hydrogen enters the storage system through a check valve. The check valve prevents back-flow of hydrogen into the fuelling line.

21. An automated hydrogen shut-off valve prevents the out-flow of stored hydrogen when the vehicle is not operating or when a fault is detected that requires isolation of the hydrogen storage system.

22. In the event of a fire, thermally activated pressure relief devices (TPRDs) provide a controlled release of the gas from the compressed hydrogen storage containers before the high temperatures in the fire weaken the containers and cause a hazardous rupture. TPRDs are designed to vent the entire contents of the container rapidly. They do not reseal or allow re-pressurization of the container. Storage containers and TPRDs that have been subjected to a fire are expected to be removed from service and destroyed.

(b) *Liquid Hydrogen Storage System*

23. Since on-road vehicle experience with liquefied hydrogen storage systems is limited and constrained to demonstration fleets, safety requirements have not been comprehensively evaluated nor have test procedures been widely examined for feasibility and relevance to known failure conditions. Therefore optional requirements and test procedures for vehicles with liquefied hydrogen storage systems are presented in section G of this preamble and paragraph 7.1. of the text of the regulation, respectively, for consideration by Contracting Parties for possible adoption into their individual regulations. It is expected that these requirements will be considered as requirements in a future gtr that applies to vehicles with liquefied hydrogen storage systems.

**4. Hydrogen fuel delivery system**

24. The hydrogen fuel delivery system transfers hydrogen from the storage system to the propulsion system at the proper pressure and temperature for the fuel cell (or ICE) to operate. This is accomplished via a series of flow control valves, pressure regulators, filters, piping, and heat exchangers. In vehicles with liquefied hydrogen storage systems, both liquid and gaseous hydrogen could be released from the storage system and then heated to the appropriate temperature before delivery to the ICE or fuel cell system. Similarly, in vehicles with compressed hydrogen storage systems, thermal conditioning of the gaseous hydrogen may also be required, particularly in extremely cold, sub-freezing weather.

25. The fuel delivery system shall reduce the pressure from levels in the hydrogen storage system to values required by the fuel cell or ICE system. In the case of a 70 MPa NWP compressed hydrogen storage system, for example, the pressure may have to be reduced from as high as 87.5 MPa to less than 1 MPa at the inlet of the fuel cell system, and typically under 1.5 MPa at the inlet of an ICE system. This may require multiple stages of pressure regulation to achieve accurate and stable control and over-pressure protection of down-stream equipment in the event that a pressure regulator fails. Over-pressure protection of the fuel delivery system may be accomplished by venting excess hydrogen gas through pressure relief valves or by isolating the hydrogen gas supply (by closing the shut-off valve in the hydrogen storage system) when a down-stream over-pressure condition is detected.

**5. Fuel cell system**

26. The fuel cell system generates the electricity needed to operate the drive motors and charge vehicle batteries and/or capacitors. There are several kinds of fuel cells, but Proton Exchange Membrane (PEM) fuel cells are the common type used in automobiles because their lower temperature of operation allows shorter start up times. The PEM fuel cells electro-chemically combine hydrogen and oxygen (in air) to generate electrical DC power. Fuel cells are capable of continuous electrical generation when supplied with hydrogen and oxygen (air), simultaneously generating electricity and water without producing carbon dioxide (CO<sub>2</sub>) or other harmful emissions typical of gasoline-fuelled internal combustion engines (ICEs).

27. As shown in Figure 1, typical fuel cell systems include a blower to feed air to the fuel cell stack. Approximately 50 to 70 per cent of the oxygen supplied to the fuel cell stack is consumed within the cells. The remainder is exhausted from the system. Most of the hydrogen that is supplied to the fuel cell system is consumed within the cells, but a small excess is required to ensure that the fuel cells will not be damaged. The excess hydrogen is either mixed with the exhaust to produce a non-flammable exhaust from the vehicle or catalytically reacted.

28. The fuel cell system also includes auxiliary components to remove waste heat. Most fuel cell systems are cooled by a mixture of glycol and water. Pumps circulate the coolant between the fuel cells and the radiator.

29. The individual fuel cells are usually electrically connected in series in a stack such that their combined voltage, the total stack voltage, is between 300 and 600 V DC. Since fuel cell stacks operate at high voltage, all reactant and coolant connections (including the coolant itself) to the fuel cell stack need to be adequately isolated from the conductive chassis of the vehicle to prevent electrical shorts that could damage equipment or harm people if the insulation is breached.

## **6. Electric propulsion and power management system**

30. The electric power generated by the fuel cell system is used to drive electric motors that propel the vehicle. As illustrated in Figure 2, many passenger fuel cell vehicles are front wheel drive with the electric drive motor and drive-train located in the "engine compartment" mounted transversely over the front axle; however, other configurations and rear-wheel drive are also viable options. Larger Sport Utility Vehicle-type fuel cell vehicles may be all-wheel drive with electric motors on the front and rear axles or with compact motors at each wheel.

31. The "throttle position" is used by the drive motor controller(s) to determine the amount of power to be sent to the drive wheels. Many fuel cell vehicles use batteries or ultra-capacitors to supplement the output of the fuel cells. These vehicles may also recapture energy during stopping through regenerative braking, which recharges the batteries or ultra-capacitors and thereby maximizes efficiency.

32. The drive motors may be either DC or AC. If the drive motors are AC, the drive motor controller shall convert the DC power from the fuel cells, batteries, and ultra-capacitors to AC. Conversely, if the vehicle has regenerative braking, the drive motor controller shall convert the AC power generated in the drive motor back to DC so that the energy can be stored in the batteries or ultra-capacitors.

## **D. Rationale for scope, definitions and applicability**

### **1. Rationale for paragraph 2 (Scope)**

33. This gtr applies to hydrogen storage systems having nominal working pressures (NWP) of 70 MPa or less, with an associated maximum fuelling pressure of 125 per cent of the nominal working pressure. Systems with NWP up to 70 MPa include storage systems currently expected to be of commercial interest for vehicle applications. In the future, if there is interest in qualifying systems to higher nominal working pressures, the test procedures for qualification will be re-examined.

34. This gtr applies to fuel storage systems securely attached within a vehicle for usage throughout the service life of the vehicle. It does not apply to storage systems intended to be exchanged in vehicle fuelling. This gtr does not apply to vehicles with storage systems using chemical bonding of hydrogen; it applies to vehicles with storage by physical containment of gaseous or liquid hydrogen.

35. The hydrogen fuelling infrastructure established prior to 2010 applies to fuelling of vehicles up to 70 MPa NWP. This gtr does not address the requirements for the fuelling station or the fuelling station/vehicle interface.

36. This gtr provides requirements for fuel system integrity in vehicle crash conditions, but does not specify vehicle crash conditions. Contracting Parties to the 1998 Agreement are expected to execute crash conditions as specified in their national regulations.

**2. Rationale for paragraphs 3.16. and 3.17. (Definitions of Service Life and Date of Removal from Service)**

37. These definitions pertain to qualification of the compressed hydrogen storage system for on-road service. The service life is the maximum time period for which service (usage) is qualified and/or authorized. This document provides qualification criteria for liquid and compressed hydrogen storage systems having a service life of 15 years or less (para. 5.1.). The service life is specified by the manufacturer.

38. The date of removal from service is the calendar date (month and year) specified for removal from service. The date of removal from service may be set by a regulatory authority. It is expected to be the date of release by the manufacturer for initial usage plus the service life.

**3. Rationale for paragraph 4 (Applicability of requirements)**

39. The performance requirements in paragraph 5. address the design qualification for on-road service. Additional requirements in Annex 7 are applicable for Contracting Parties with Type Approval systems that address the conformity of mass production to units qualified to the requirements of paragraph 5. The goal of harmonizing requirements as embodied in the gtr provides the opportunity to develop vehicles that can be deployed throughout Contracting Parties to achieve uniformity of compliance and resulting economies of scale; therefore, type approval requirements beyond those specified in Annex 7 of the text of the Regulation are not expected.

40. It is expected that all Contracting Parties will recognize vehicles that meet the full requirements of this gtr as suitable for on-road service within their jurisdictions. Contracting Parties with type approval systems may require, in addition, compliance with their requirements for conformity of production, material qualification and hydrogen embrittlement.

41. It is also understood that any individual Contracting Party may also elect to develop different requirements for additional vehicles to qualify for on-road service within its jurisdiction. For example:

(a) This gtr requires the use of hydrogen gas in fire testing of compressed gas storage (paragraph 6.2.5.). An individual Contracting Party might elect to qualify vehicles for on-road service using either hydrogen or air as the test gas in fire testing. In that case, those vehicles qualified using air could be qualified for on-road service within the jurisdiction of that individual Contracting Party.

(b) Vehicles qualified for on-road service using requirements of this gtr including 11,000 hydraulic pressure cycles in paragraph 5.1.2. testing would be recognized as suitable for on-road service in all Contracting Parties. An individual Contracting Party might elect to qualify additional vehicles for service within its individual jurisdiction using 5,500 or 7,500 pressure cycles for compressed hydrogen storage (para. 5.1.2.).

**E. Rationale for paragraph 5 (Performance requirements and scope)****1. Compressed hydrogen storage system test requirements and safety needs**

42. The containment of the hydrogen within the compressed hydrogen storage system is essential to successfully isolate the hydrogen from the surroundings and down-stream systems. The storage system is defined to include all closure surfaces that provide primary containment of high-pressure hydrogen storage. The definition provides for future advances in design, materials and constructions that are expected to provide improvements in weight, volume, conformability and other attributes.

43. *Performance test requirements* for all compressed hydrogen storage systems in on-road vehicle service are specified in paragraph 5.1. The performance-based requirements address documented on-road stress factors and usages to assure robust qualification for vehicle service. The qualification tests were developed to demonstrate capability to perform critical functions throughout service including fuelling/defuelling, parking under extreme conditions, and performance in fires without compromising the safe containment of the hydrogen within the storage system. These criteria apply to qualification of storage systems for use in new vehicle production.

44. *Conformity of Production with storage systems subjected to formal design qualification testing*: Manufacturers shall ensure that all production units meet the requirements of performance verification testing in paragraph 5.1.2. In addition, manufacturers are expected to monitor the reliability, durability and residual strength of representative production units throughout service life.

45. *Organization of requirements*: paragraph 5.1. design qualification requirements for on-road service include:

5.1.1. Verification Tests for Baseline Metrics

5.1.2. Verification Test (Hydraulic) for Performance Durability

5.1.3. Verification Test (Hydrogen Gas) for Expected On-Road Performance

5.1.4. Verification Test for Service-Terminating Performance

46. Paragraph 5.1.1. establishes metrics used in the remainder of the performance verification tests and in production quality control. Paras. 5.1.2. and 5.1.3. are the qualification tests that verify that the system can perform basic functions of fuelling, defuelling and parking under extreme on-road conditions without leak or rupture throughout the specified service life. Paragraph 5.1.4. provides confirmation that the system performs safely under the service-terminating condition of fire.

47. *Comparable stringency* with current national regulations for on-road service has been **addressed for EU regulations in an EU-sponsored evaluation of comparable stringency (C. Visvikis (TRL CPR1187, 2011) "Hydrogen-Powered Vehicles: A Comparison of the European legislation and the Draft ENECE Global Technical Regulation")**. It concludes: **"Overall, the work showed that there are fundamental differences between the European legislation and the draft global technical regulation. There are insufficient tests or real-world data to determine, with certainty, which is more stringent. There are aspects of a hydrogen storage system and its installation that are regulated in Europe, but are not included in the draft global technical regulation. However, the performance requirements in the global regulation appear, on balance, to be more stringent than those in the European legislation."** The reports adds: **„...the penetration test is a potentially significant omission from the draft global technical regulation. Hydrogen containers may be unlikely to experience gunfire during their service, but there could be implications for security ... vandalism or terrorism."**

**Comparable stringency with current national regulations for on-road service was assured through examination of the technical basis for requirements of individual contracting parties with respect to on-road safety and subsequent recognition that the relevant expected safety objective is achieved by the GTR requirement. Two examples are noteworthy.**

(a) **First example: some national regulations have required that compressed storage be subjected to 45,000 full-fill hydraulic cycles without rupture if no intervening leak occurs.**

(b) Second example: an overriding requirement for initial burst pressure (>2.2 for carbon-fiber composite containers and >3.3 for glass-fiber composite containers) has been used previously in some places for lower pressure CNG vessels. The basis for this type of burst pressure requirement for new (unused) vessels was examined. A credible quantitative, data-driven basis for historical requirements linked to demands of on-road service was not identified. Instead, modern engineering methods of identifying stressful conditions of service from decades of experience with real-world usage and designing qualification tests to replicate and compound extremes of those conditions were used to force systems to demonstrate capability to function and survive a lifetime's exposure. However, a risk factor that could be identified as not already addressed by other test requirements and for which a burst pressure test would be relevant was the demonstration of capability to resist burst from over-pressurization by a fueling station through-out service life. The more stringent test condition applies to vessels at the "end-of-life" (as simulated by extreme test conditions) rather than new (unused) vessels. Therefore, a residual (end-of-life) requirement of exposure (without burst) to 180 per cent NWP for 4 minutes was adopted based on the demonstrated equivalence of the probability for failure after 4 min at 180per cent NWP to failure after 10 hours at 150 per cent NWP (based on time to failure data for "worst-case" glass composite strands). Maximum fueling station over-pressurization is taken as 150per cent NWP. Experiments on highly insulated vessels have shown cool down from compressive heating lasting on the order of 10 hours. An additional requirement corresponding to minimum burst pressure of 200 per cent NWP for new, unused vessels has been under consideration as a screen for minimum new vessel capability with potential to complete the durability test sequence requiring burst pressure above 180 per cent NWP considering  $\pm 10$  per cent variability in new vessel strength. The historical minimum, 225 per cent NWP has been adopted in this document as a conservative placeholder without a quantitative data-driven basis but instead using previous history in some Contracting Parties with the expectation that additional consideration and data/analyses will be available to support the 225 per cent NWP value or for reconsideration of the minimum new vessel burst requirement.

~~Comparable stringency with current national regulations for on road service has been assured through two criteria: (i) replication or near replication, (ii) examination of the technical basis for requirements of individual contracting parties with respect to on road safety and subsequent recognition that the relevant expected safety objective is achieved by the gtr requirement, and/or (ii) recognition that a gtr requirement appropriately provides additional stringency. Examples of (i) are common throughout the document. Two examples of (ii) are noteworthy. First, some national regulations have required that compressed storage be subjected to 45,000 full fill hydraulic pressure cycles without rupture if no intervening leak occurs.~~

48. The requirement of paragraph 5.1.1.2. (baseline initial pressure cycle life) is **22,000** cycles. The **22,000** full-fill cycles correspond to well over 7 million vehicles kilometres travelled in lifetime service (at 350-500 km travelled per full-fuelling). Since the expected lifetime service is far less than 1 million km, the requirement for **22000** pressure cycles was judged to provide substantial margin above extreme worst-case vehicle service. Second, there are various provisions in national standards to assure sufficient strength to survive exposures to static (parking) and cyclic (fuelling) pressure exposures with residual strength. The capability to survive individual static and cyclic pressure exposures has generally been evaluated by tests that are the equivalent of paragraphs 5.1.2.4., 5.1.2.5. and 5.1.2.6., but with each performed on a separate new container. An overriding requirement for initial burst pressure (>2.2 for carbon-fibre composite containers and >3.3 for glass-fibre composite containers) was commonly used to indirectly account for un-replicated factors

such as the compounding of individually applied stresses and chemical/physical impacts and ability to survive over-pressurizations in fuelling. The gtr requirements, however, provide for direct accounting for these factors with explicit replication of the compounding of stresses and chemical/physical impacts and over-pressurizations. Unlike conditions for other gaseous fuels, specifications for hydrogen fuelling provide safeguards to limit potential over-pressurizations to extremes replicated in container testing. In addition, the gtr requirements assure residual strength for end-of-life extreme over-pressurization with retained stability sufficient to assure capability to resist burst at pressures near (within 20 per cent) of new container capability. All of the gtr requirements are explicitly derived using published data that clearly and quantitatively links the test criteria to specified aspects of safe on-road performance. Thus, criteria providing indirect inference of safe performance through-out service life and at end-of-life were replaced with criteria providing direct verification of capability for safe performance at end-of-life under compounded worst-case exposure conditions; hence, the result is added stringency in assurance in capability for safe performance throughout service life. Examples of (iii) include the gtr requirement for pressure cycle testing with hydrogen gas at extreme temperatures (para. 5.1.3.2.) rather than ambient temperature only, permeation testing with hydrogen gas at extreme temperature and at replicated end-of-life (para. 5.1.3.3.), end-of-life residual strength (para. 5.1.2.7.) after compounded exposure to multiple stress factors (para. 5.1.2.), and localized and engulfing fire testing (para. 5.1.4.).

49. The following sections (paras 5.1.1. to 5.1.4.) specify the rationale for the performance requirements established in para. 5.1. for the integrity of the compressed hydrogen storage system.

**(a) Rationale for paragraph 5.1.1. verification tests for baseline metrics**

50. Verification Tests for Baseline Metrics have several uses: (i) verify that systems presented for design qualification (the qualification batch) are consistent in their properties and are consistent with manufacturer's records for production quality control; (ii) establish the median initial burst pressure, which is used for performance verification testing (paras. 5.1.2. and 5.1.3.) and can be used for production quality control (i.e. to assure conformity of production with properties of the qualification batch), and (iii) verify that requirements are met for the minimum burst pressure and number of pressure cycles before leak.

51. The baseline initial burst pressure requirements differ from the "end-of-life" burst pressure requirements that conclude the test sequences in paragraphs 5.1.2. and 5.1.3. The baseline burst pressure pertains to a new, unused container and the "end-of-life" burst pressure pertains to a container that has completed a series of performance tests (paragraphs 5.1.2. or 5.1.3.) that replicate conditions of worst-case usage and environmental exposure in a full service life. Since fatigue accumulates over usage and exposure conditions, it is expected that the "end-of-life" burst pressure (i.e. burst strength) could be lower than that of a new and unexposed container.

*(i) Rationale for paragraph 5.1.1.1. baseline initial burst pressure*

52. Paragraph 5.1.1.1. establishes the midpoint initial burst pressure,  $BP_O$ , and verifies that initial burst pressures of systems in the qualification batch are within the range  $BP_O \pm 10$  per cent.  $BP_O$  is used as a reference point in performance verification (paras. 5.1.2.8. and 5.1.3.5.) and verification of consistency within the qualification batch.

~~Paragraph 5.1.1.1. verifies that  $BP_0$  is greater than or equal to [200 per cent] NWP to screen for capability to sustain 180 per cent NWP at end-of-life with minimal loss of strength during qualification testing.~~

**Paragraph B .5.1.1.1. verifies that BPO is greater than or equal to 225 per cent NWP, a value tentatively selected without data-driven derivation but instead based on historical usage and applied here as a placeholder with the expectation that a lower minimum value (200 per cent NWP or lower) is under evaluation and hence new data or analysis will be available for reconsideration of the topic in Phase 2 of the development of this GTR. For example, a 200 per cent minimum initial burst pressure requirement can be supported by the data-driven performance-linked justification that a greater-than 180 per cent NWP end-of-service burst requirement (linked to capability to survive the maximum fueling station over-pressurization) combined with a 20 per cent lifetime decline (maximum allowed) from median initial burst strength is equivalent to a requirement for a median initial burst strength of 225 per cent NWP, which corresponds to a minimum burst strength of 200per cent NWP for the maximum allowed 10per cent variability in initial strength. The interval between Phase I and Phase II provides opportunity for development of new data or analysis pertaining to a 225 per cent NWP (or another per cent NWP) minimum prior to resolution of the topic in Phase 2.**

53. In addition to being a performance requirement, it is expected that satisfaction of this requirement will provide assurance to the testing facility of container stability before the qualification testing specified in paras. 5.1.2., 5.1.3. and 5.1.4. is undertaken.

(ii) *Rationale for paragraph 5.1.1.2. Baseline Initial Pressure Cycle Life*

54. The requirement specifies that three (3) randomly selected new containers are to be hydraulically pressure cycled to 125 per cent NWP without rupture for [22,000] cycles or until leak occurs. Leak may not occur within a specified number of pressure cycles (number of Cycles). The specification of number of Cycles within the range 5,500 – 11,000 is the responsibility of individual Contracting Parties. That is, the number of pressure cycles in which no leakage may occur, number of Cycles, cannot be greater than 11,000, and it could be set by the Contracting Party at a lower number but not lower than 5,500 cycles for 15 years service life. The rationale for the numerical values used in this specification follows:

a. *Rationale for "Leak Before Burst" Aspect of Baseline Pressure Cycle Life Requirements*

55. The Baseline Pressure Cycle Life requirement is designed to provide an initial check for resistance to rupture due to the pressure cycling during on-road service. The Baseline Pressure Cycle test requires either (i) the occurrence of leakage (that is designed to result in vehicle shut down and subsequent repair or removal of the container from service (para. 5.2.1.4.3.)) before the occurrence of rupture, or (ii) the capability to sustain [22,000] full-fill hydraulic pressure cycles without rupture or leakage.

56. Regardless of the container failure mode, this requirement provides sufficient protection for safe container use over the life of the vehicle. The minimum distance travelled prior to a container leaking would depend on a number of factors including the number of cycles chosen by the Contracting Party and the fill mileage for the vehicle. Regardless, the minimum design of 5500 cycles before leak and using only 200 miles per fill provides over 1 million miles before the container would fail by leakage. Worst case scenario would be failure by rupture in which case the container shall be capable of withstanding [22,000] cycles. For vehicles with nominal on-road driving range of 480 km (300 miles) per full fuelling, [22,000] full fill cycles corresponds to over 10 million km (6 million miles), which is beyond a realistic extreme of on-road vehicle lifetime range (see discussion in para.5.1.1.2.2. below). Hence, either the container demonstrates the capability



to avoid failure (leak or rupture) from exposure to the pressure cycling in on-road service, or leakage occurs before rupture and thereby prevents continued service that could potentially lead to rupture.

57. A greater number of pressure cycles, [22,000], is required for demonstration of resistance to rupture (in the absence of intervening leak) compared to the number of cycles required for demonstration of resistance to leak (between 5500 and 11,000) because the higher severity of a rupture event suggests that the probability of that event per pressure cycle should be lower than the probability of the less severe leak event. Risk = (probability of event) x (severity of event).

(Note: cycling to a higher pressure than 125 per cent NWP could elicit failure in less testing time, however, that could elicit failure modes that could not occur in real world service.)

b. *Rationale for number of Cycles, Number of Hydraulic Pressure Cycles in Qualification Testing: number of Cycles Greater Than or Equal to 5500 and Less Than or Equal to 11000*

58. The number of hydraulic test pressure cycles is to be specified by individual Contracting Parties primarily because of differences in the expected worst-case lifetime vehicle range (distance driven during vehicle service life) and worst-case fuelling frequency in different jurisdictions. The differences in the anticipated maximum number of fuellings are primarily associated with high usage commercial taxi applications, which can be subjected to very different operating constraints in different regulatory jurisdictions. For example:

(a) Vehicle Fleet Odometer Data (including taxis): Sierra Research Report No. SR2004-09-04 for the California Air Resource Board (2004) reported on vehicle lifetime distance travelled by scrapped California vehicles, which all showed lifetime distances travelled below 560,000 km (350,000 miles). Based on these figures and 320 - 480 km (200 - 300 miles) driven per full fuelling, the maximum number of lifetime empty-to-full fuellings can be estimated as 1,200 – 1,800.

(b) Vehicle Fleet Odometer Data (including taxis): Transport Canada reported that required emissions testing in British Columbia, Canada, in 2009 showed the 5 most extreme usage vehicles had odometer readings in the 800,000 – 1,000,000 km (500,000 – 600,000 miles) range. Using the reported model year for each of these vehicles, this corresponds to less than 300 full fuellings per year, or less than 1 full fuelling per day. Based on these figures and 320 - 480 km (200 - 300 miles) driven per full fuelling, the maximum number of empty-to-full fuellings can be estimated as 1650 - 3100.

(c) Taxi Usage (Shifts/Day and Days/Week) Data: The New York City (NYC) Taxicab Fact Book (Schaller Consulting, 2006) reports extreme usage of 320 km (200 mi) in a shift and a maximum service life of 5 years. Less than 10 per cent of vehicles remain in service as long as 5 years. The average mileage per year is 72,000 for vehicles operating 2 shifts per day and 7 days per week. There is no record of any vehicle remaining in high usage through-out the full 5 year service life. However, if a vehicle were projected to have fuelled as often as 1.5 – 2 times per day and to have remained in service for the maximum 5-year New York City (NYC) taxi service life, the maximum number of fuellings during the taxi service life would be 2,750 – 3,600.

(d) Taxi Usage (Shifts/Day and Days/Week) Data: Transport Canada reported a survey of taxis operating in Toronto and Ottawa that showed common high usage of 20 hours per day, 7 days per week with daily driving distances of 540 – 720 km (335 – 450 mi). Vehicle odometer readings were not reported. In the extreme worst-case, it might be projected that if a vehicle could remain at this high level of usage for 7 years (the maximum reported taxi service life); then a maximum extreme driving distance of 1,400,000 –

1,900,000 km (870,000 – 1,200,000 mi) is projected. Based on 320 - 480 km (200 - 300 mi) driven per full fuelling, the projected full-usage 15-year number of full fuellings could be 2,900 – 6,000. Consistent with these extreme usage projections, the minimum number of full pressure hydraulic qualification test cycles for hydrogen storage systems is set at 5500. The upper limit on the number of full-fill pressure cycles is set at 11,000, which corresponds to a vehicle that remains in the high usage service of 2 full fuellings per day for an entire service life of 15 years (expected lifetime vehicle mileage of 3.5 – 5.3 million km (2.2 – 3.3 million miles)).

59. In establishing number of Cycles, it was recognized that practical designs of some storage system designs (such as composite wrap systems with metal liner interiors) might not qualify for service at 70 MPa NWP if number of cycles is greater than 5,500. In establishing [...] Cycles, it was recognized that if number of Cycles is specified at 5,500, some Contracting Parties may require usage constraints to assure actual fuellings do not exceed number of cycles.

**(b) Rationale for paragraph 5.1.2. Verification Test for On-Road Performance Durability (Hydraulic Sequential Tests)**

60. The verification test for on-road performance durability ensures the system is fully capable of avoiding rupture under extreme conditions of usage that include extensive fuelling frequency (perhaps associated with replacement of drive train components), physical damage and harsh environmental conditions. These durability tests focus on structural resistance to rupture. The additional attention to rupture resistance under harsh external conditions is provided because (i) the severity of consequences from rupture is high, and (ii) rupture is not mitigated by secondary factors (leaks are mitigated by onboard leak detection linked to countermeasures). Since these extreme conditions are focused on structural stress and fatigue, they are conducted hydraulically – which allows more repetitions of stress exposure in a practical test time.

*(i) Assumptions used in developing paragraph 5.1.2 test protocol.*

61. These assumption Include:

- (a) Extended and severe service worst-case = lifetime of most stressful empty-to-full (125 per cent NWP at 85°C, 80 per cent at -40°C) fuellings under extended & severe usage; 10 service-station over-pressurization events
- (b) Sequential performance of tests replicates on-road experience where a single container is subject to multiple extremes of different exposure conditions – it is not realistic to expect that a container could only encounter one type of exposure through the life of the vehicle.
- (c) Severe usage: Exposure to physical impacts
  - (i) Drop impact (para. 5.1.2.2.) – the risk is primarily an aftermarket risk during vehicle repair where a new storage system, or an older system removed during vehicle service, is dropped from a fork lift during handling. The test procedure requires drops from several angles from a maximum utility forklift height. The test is designed to demonstrate that containers have the capability to survive representative pre-installation drop impacts.
  - (ii) Surface damage (para. 5.1.2.3.) – cuts characteristic of wear from mounting straps that can cause severe abrasion of protective coatings

- (iii) On-road impacts that degrade exterior structural strength and/or penetrate protective coatings (e.g. flying stone chips) (para. 5.1.2.3.) – simulated by pendulum impact.
- (d) Severe usage: exposure to chemicals in the on-road environment (para. 5.1.2.4.)
  - (i) Fluids include fluids used on vehicles (battery acid and washer fluid), chemicals used on or near roadways (fertilizer nitrates and lye), and fluids used in fuelling stations (methanol and gasoline).
  - (ii) The primary historical cause of rupture of high pressure vehicle containers (CNG containers), other than fire and physical damage, has been stress corrosion rupture – rupture occurring after a combination of exposure to corrosive chemicals and pressurization.
  - (iii) Stress corrosion rupture of on-road glass-composite wrapped containers exposed to battery acid was replicated by the proposed test protocol; other chemicals were added to the test protocol once the generic risk of chemical exposure was recognized.
  - (iv) Penetration of coatings from impacts and expected on-road wear can degrade the function of protective coatings — recognized as a contributing risk factor for stress corrosion cracking (rupture); capability to manage that risk is therefore required.
- (e) Extreme number of fuellings/defuellings
 

Rationale for number of cycles greater than 5,500 and less than 11,000 is provided in paras. 58-59 section E.1(a)(ii)b of the preamble.
- (f) Extreme pressure conditions for fuelling/de-fuelling cycles (para. 5.1.2.4.)
  - (i) Fuelling station over-pressurization constrained by fuelling station requirements to less than or equal to 150 per cent NWP. (This requirement for fuelling stations shall be established within local codes and/or regulations for fuelling stations.)
  - (ii) Field data on the frequency of failures of high pressure fuelling stations involving activation of pressure relief controls is not available. Experience with CNG vehicles suggests overpressure by fuelling stations has not contributed significant risk for container rupture.
  - (iii) Assurance of capability to sustain multiple occurrences of over-pressurization due to fuelling station failure is provided by the requirement to demonstrate absence of leak in 10 exposures to 150 per cent NWP fuelling followed by long-term leak-free parking and subsequent fuelling/de-fuelling.
- (g) Extreme environmental conditions for fuelling/de-fuelling cycles (para.5.1.2.6.)
 

Weather records show temperatures less than or equal to -40 °C occur in countries north of the 45th parallel; temperatures ~50 °C occur in desert areas of lower latitude countries; each with frequency of sustained extreme temperature ~5 per cent in areas with verifiable government records. [Actual data shows ~5 per cent of days have a minimum temperature less than -30 °C. Therefore sustained exposure to less than -30 °C is less than 5

per cent of vehicle life since a daily minimum is not reached for a full 24 hr period] Data record examples (Environment Canada 1971-2000):

- (i) [www.climate.weatheroffice.ec.gc.ca/climate\\_normals/results\\_e.html?Province=ONTpercent20&StationName=&SearchType=&LocateBy=Province&Proximity=25&ProximityFrom=City&StationNumber=&IDType=MSC&CityName=&ParkName=&LatitudeDegrees=&LatitudeMinutes=&LongitudeDegrees=&LongitudeMinutes=&NormalsClass=A&SelNormals=&StnId=4157&](http://www.climate.weatheroffice.ec.gc.ca/climate_normals/results_e.html?Province=ONTpercent20&StationName=&SearchType=&LocateBy=Province&Proximity=25&ProximityFrom=City&StationNumber=&IDType=MSC&CityName=&ParkName=&LatitudeDegrees=&LatitudeMinutes=&LongitudeDegrees=&LongitudeMinutes=&NormalsClass=A&SelNormals=&StnId=4157&)
  - (ii) [www.climate.weatheroffice.ec.gc.ca/climate\\_normals/results\\_e.html?Province=YTpercent20percent20&StationName=&SearchType=&LocateBy=Province&Proximity=25&ProximityFrom=City&StationNumber=&IDType=MSC&CityName=&ParkName=&LatitudeDegrees=&LatitudeMinutes=&LongitudeDegrees=&LongitudeMinutes=&NormalsClass=A&SelNormals=&StnId=1617&](http://www.climate.weatheroffice.ec.gc.ca/climate_normals/results_e.html?Province=YTpercent20percent20&StationName=&SearchType=&LocateBy=Province&Proximity=25&ProximityFrom=City&StationNumber=&IDType=MSC&CityName=&ParkName=&LatitudeDegrees=&LatitudeMinutes=&LongitudeDegrees=&LongitudeMinutes=&NormalsClass=A&SelNormals=&StnId=1617&)
- (h) Extended and severe usage:
- High temperature full-fill parking up to 25 years (Prolonged Exposure to High Pressure) (para. 5.1.2.5) To avoid a performance test lasting for 25 years, a time-accelerated performance test using increased pressure developed using experimental material data on currently used metals and composites, and selecting the worst-case for stress rupture susceptibility, which is glass fibre reinforced composite. Use of laboratory data to establish the equivalence of testing for stress rupture at 100 per cent NWP for 25 years and testing at 125 per cent NWP for 1000 hours (equal probability of failure from stress rupture) is described in SAE Technical Paper 2009-01-0012 (Sloane, "Rationale for Performance-based Validation Testing of Compressed Hydrogen Storage," 2009). Laboratory data on high pressure container composite strands – documentation of time-to-rupture as a function of static stress without exposure to corrosives – is summarized in Aerospace Corp Report No. ATR-92(2743)-1 (1991) and references therein.
- (i) No formal data is available on parking duration per vehicle at different fill conditions. Examples of expected lengthy full fill occurrences include vehicles maintained by owners at near full fill conditions, abandoned vehicles and collectors' vehicles. Therefore, 25 years at full fill is taken as the test requirement.
  - (ii) The testing is performed at +85 °C because some composites exhibit a temperature-dependent fatigue rate (potentially associated with resin oxidation) (J. Composite Materials 11, 79 (1977)). A temperature of +85 °C is selected as the maximum potential exposure because under-hood maximum temperatures of +82 °C have been measured within a dark-coloured vehicle parked outside on asphalt in direct sunlight in 50 °C ambient conditions. Also, a compressed gas container, painted black, with no cover, in the box of a black pickup truck in direct sunlight in 49 °C had maximum / average measured container skin surface temperatures of 87 °C (189 °F) / 70 °C (159 °F).
  - (iii) On-road experience with CNG containers – there have not been reports of any on-road stress rupture without exposure to corrosives (stress corrosion cracking) or design anomaly (hoop wrap tensioned

for liner compression without autofretage). Paragraph 5.1.2. testing that includes chemical exposure test and 1,000 hours of static full pressure exposure simulates these failure conditions.

- (i) Residual proof pressure (para. 5.1.2.7.)
  - (i) Fuelling station over-pressurization constrained by fuelling station requirements to less than or equal to 150 per cent NWP. (This requirement for fuelling stations shall be established within local codes/regulations for fuelling stations).
  - (ii) Laboratory data on static stress rupture used to define equivalent probability of stress rupture of composite strands after 4 minutes at 180 per cent NWP as after 10 hours at 150 per cent NWP as the worst case (SAE Technical Report 2009-01-0012). Fuelling stations are expected to provide over-pressure protection up to 150 per cent NWP.
  - (iii) Testing at "end-of-life" provides assurance to sustain fuelling station failure throughout service.
- (j) Residual strength burst (para. 5.1.2.8.)
 

Requirement for a less than 20 per cent decline in burst pressure after 1000-hr static pressure exposure is linked (in the Society of Automotive Engineers (SAE) Technical Report 2009-01-0012) to assurance that requirement has allowance for  $\pm 10$  per cent manufacturing variability in assurance of 25 years of rupture resistance at 100 per cent NWP.
- (k) Rationale for not including a boss torque test requirement:
 

Note that damage to containers caused by maintenance errors is not included because maintenance errors, such as applying excessive torque to the boss, are addressed by maintenance training procedures and tools and fail safe designs. Similarly, damage to containers caused by malicious and intentional tampering is not included.

(c) **Rationale for paragraph 5.1.3. Verification Test for Expected On-Road Performance (Pneumatic Sequential Tests)**

62. The verification test for expected on-road performance requires the demonstration of capability to perform essential safety functions under worst-case conditions of expected exposures. "Expected" exposures (for a typical vehicle) include the fuel (hydrogen), environmental conditions (such as often encountered temperature extremes), and normal usage conditions (such as expected vehicle lifetime range, driving range per full fill, fuelling conditions and frequency, and parking). Expected service requires sequential exposure to parking and fuelling stresses since all vehicles encounter both uses and the capability to survive their cumulative impact is required for the safe performance of all vehicles in expected service.

63. Pneumatic testing with hydrogen gas provides stress factors associated with rapid and simultaneous interior pressure and temperature swings and infusion of hydrogen into materials; therefore, pneumatic testing is focused on the container interior and strongly linked to the initiation of leakage. Failure by leakage is marginally mitigated by secondary protection – monitoring and vehicle shut down when warranted (below a conservative level of flammability risk in a garage), which is expected to result in very timely repair before leakage can develop further since the vehicle will be out of service.

Data used in developing para. 5.1.3. test protocol include:

- (a) Proof pressure test (paragraph 5.1.3.1.) – routine production of pressure containers includes a verifying, or proof, pressure test at the point of production, which is 150 per cent NWP as industry practice, i.e. 20 per cent above the maximum service pressure.
- (b) Leak-free fuelling performance (para. 5.1.3.2.)
  - (i) Expected environmental conditions — weather records show temperatures less than or equal to -40 °C occur in countries north of the 45-th parallel; temperatures ~50 °C occur in desert areas of lower latitude countries; each with frequency of sustained extreme temperature ~5 per cent in areas with verifiable government records. [Actual data shows ~5 per cent of days have a minimum temperature below -30 °C. Therefore sustained exposure to below -30 °C is less than 5 per cent of vehicle life since a daily minimum is not reached for a full 24 hr period] Data record examples (Environment Canada 1971-2000):
    - a. [http://www.climate.weatheroffice.ec.gc.ca/climate\\_normals/results\\_e.html?Province=ONTpercent20&StationName=&SearchType=&LocateBy=Province&Proximity=25&ProximityFrom=City&StationNumber=&IDType=MSC&CityName=&ParkName=&LatitudeDegrees=&LatitudeMinutes=&LongitudeDegrees=&LongitudeMinutes=&NormalsClass=A&SelNormals=&StnId=4157&](http://www.climate.weatheroffice.ec.gc.ca/climate_normals/results_e.html?Province=ONTpercent20&StationName=&SearchType=&LocateBy=Province&Proximity=25&ProximityFrom=City&StationNumber=&IDType=MSC&CityName=&ParkName=&LatitudeDegrees=&LatitudeMinutes=&LongitudeDegrees=&LongitudeMinutes=&NormalsClass=A&SelNormals=&StnId=4157&)
    - b. [http://www.climate.weatheroffice.ec.gc.ca/climate\\_normals/results\\_e.html?Province=YTpercent20&StationName=&SearchType=&LocateBy=Province&Proximity=25&ProximityFrom=City&StationNumber=&IDType=MSC&CityName=&ParkName=&LatitudeDegrees=&LatitudeMinutes=&LongitudeDegrees=&LongitudeMinutes=&NormalsClass=A&SelNormals=&StnId=1617&](http://www.climate.weatheroffice.ec.gc.ca/climate_normals/results_e.html?Province=YTpercent20&StationName=&SearchType=&LocateBy=Province&Proximity=25&ProximityFrom=City&StationNumber=&IDType=MSC&CityName=&ParkName=&LatitudeDegrees=&LatitudeMinutes=&LongitudeDegrees=&LongitudeMinutes=&NormalsClass=A&SelNormals=&StnId=1617&)
  - (ii) Number of fuelling/defuelling cycles
    - a. The number of full fuellings required to demonstrate capability for leak-free performance in expected service is taken to be 500.
      - i. Expected vehicle lifetime range is taken to be 250,000 km (155,000 mi)

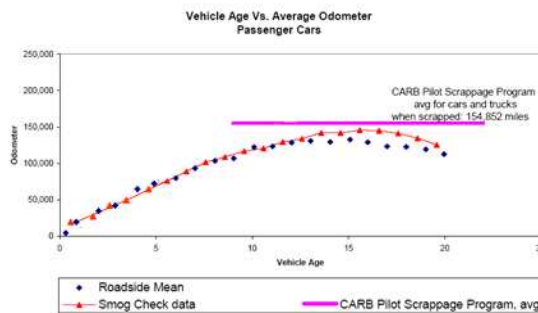

Source: Sierra Research Report No. SR2004-09-04, titled "Review of the August 2004 Proposed CARB Regulations to Control Greenhouse Gas Emissions from Motor Vehicles: Cost

Effectiveness for the Vehicle Owner or Operator," and dated 22 September 2004.

- ii. Expected vehicle range per full fuelling is taken to be greater than or equal to 500 km (300 mi) (based on 2006-2007 market data of high volume passenger vehicle manufacturers in Europe, Japan and North America).
  - iii. 500 cycles = 250,000 miles/500 miles-per-cycle ~ 155,000 miles/300 miles-per-cycle
  - iv. Some vehicles may have shorter driving ranges per full fuelling, and may achieve more than 500 full fuellings if no partial fuellings occur in the vehicle life. Demonstrated capability to perform without leak in 500 full fuellings is intended to establish fundamental suitability for on-road service leakage is subject to secondary mitigation by detection and vehicle shut-down before safety risk develops.
  - v. Since the stress of full fuellings exceeds the stress of partial fuellings, the design verification test provides a significant margin of additional robustness for demonstration of leak-free fuelling/de-fuelling capability.
- b. Qualification requirement of 500 pneumatic pressure cycles is conservative when considering failure experience:
- i. On-road experience: 70 MPa hydrogen storage systems have developed leaks in o-ring sealings during brief (less than 50 full fuellings) on-road service of demonstration prototype vehicles.
  - ii. On-road experience: 70 MPa hydrogen storage systems have developed temporary (subsequently resealing) leaks during brief (less than 50 full fuellings) on-road service of demonstration prototype vehicles.
  - iii. On-road experience: mechanical failures of CNG vehicle storage associated with gas intrusion into wrap/liner and interlaminar interfaces have developed after brief on-road service (less than 50 full fuellings).
  - iv. On-road experience: failure of CNG vehicle storage due to interior charge build-up and liner damage corona discharge is not a failure mode because static charge is carried into containers on particulate fuel impurities and ISO 14687-2 (and SAE J2719) fuel requirements limit particulates in hydrogen fuel – also, fuel cell power systems are not tolerant of particulate impurities and such impurities are expected to cause vehicles to be out of service if inappropriate fuel is dispensed.
  - v. Test experience: mechanical failures of vehicle storage systems associated with gas intrusion into wrap/liner

and interlaminar interfaces develop in ~50 full fuellings.

- vi. Test experience: 70MPa hydrogen storage systems that passed Natural Gas Vehicle (NGV2) test requirements have failed during the test conditions of para. 5.1.3. in failure modes that would be expected to occur in on-road service. The Powertech report (McDougal, M., "SAE J2579 Validation Testing Program Powertech Final Report", National Renewable Energy Laboratory Report No. SR-5600-49867 ([www.nrel.gov/docs/fy11osti/49867.pdf](http://www.nrel.gov/docs/fy11osti/49867.pdf)) cites two failures of systems with containers that have qualified for service: metal-lined composite container valve leak and in-container solenoid leak, polymer-lined composite container leak due to liner failure. The polymer-lined composite container failure by leakage was on a container that was qualified to American National Standard Association and Canadian Standards Association (ANSI/CSA) NGV2 modified for hydrogen. The metal-lined composite failure of the container valve was on a valve qualified to EIHP rev12b. Report conclusion: "The test sequences in SAE TIR J2579 have shown that containers with no known failures in service either met the requirements of the tests, or fail for reasons that are understood and are representative of future service conditions"

(iii) Fuelling conditions

- a. SAE J2601 establishes fuelling protocol — 3 minutes is fastest empty-to-full fuelling (comparable to typical gasoline fuelling; existing in installed state-of-art hydrogen fuelling stations); fuel temperature for 70 MPa fast fuelling is ~ -40 °C.
- b. Expected maximum thermal shock conditions are for a system equilibrated at an environmental temperature of ~50 °C subjected to -40 °C fuel, and for a system equilibrated at -40 °C subjected to indoor private fuelling at approximately +20 °C.
- c. Fuelling stresses are interspersed with parking stresses.

(c) Leak-free Parking at full fill (para. 5.1.3.3)

- (i) Leak and permeation are risk factors for fire hazards for parking in confined spaces such as garages.
- (ii) The leak/permeation limit is characterized by the many possible combinations of vehicle and garages, and the associated test conditions. The leak/permeation limit is defined to restrict the hydrogen concentration from reaching 25 per cent LFL by volume with worst credible conditions of a tight, very hot (55 °C) garage having a low air exchange rate (0.03 volumetric air exchanges per hour). The conservative 25 per cent LFL limit is conventionally adopted to accommodate concentration inhomogeneities. Data for hydrogen dispersion behaviour, garage and vehicle scenarios,



including garage sizes, air exchange rates and temperatures, and the calculation methodology are found in the following reference prepared as part of the EC Network of Excellence (NoE) HySafe: P. Adams, A. Bengaouer, B. Cariteau, V. Molkov, A.G. Venetsanos, "Allowable hydrogen permeation rate from road vehicles", Int. Journal of Hydrogen Energy, volume 36, issue 3, 2011 pp 2742-2749.

- (iii) The resulting discharge limit measured at **55°C** and 115 per cent NWP (full fill at **55 °C**) following specified pneumatic pressure cycling of the storage system is scalable depending on the vehicle size around a nominal value of 150 mL/min for a garage size of 30.4 m<sup>3</sup>. The scaling factor,  $R = (V_{width}+1)*(V_{height}+0.05)*(V_{length}+1)/30.4$ , accommodates alternative garage/vehicle combinations to those used in the derivation of the rate, and accommodates small vehicles that could be parked in smaller garages. These ~~vehicle~~ **vehicle-level** permeation requirements are consistent with the proposals developed by the EU (NoE) HySafe (see above reference). The permeation values measured for individual storage container systems used in a vehicle would total to less than the vehicle limit.
- (iv) **For ease of compliance testing, however, the discharge requirement has been specified in terms of storage system permeation instead of vehicle-level (iii) permeation.** ~~An alternative discharge limit based on individual cylinder properties instead of the storage system property is provided for ease of compliance testing for some systems.~~ This alternative means of compliance is consistent with the proposals developed by the EU NoE HySafe. In this case, the permeation limit measured at **55 °C** and 115 per cent NWP is 46 mL/h/L-water-capacity of the storage system. **If the total water capacity of the vehicle storage system is less greater than 330 L and the garage size is no smaller than 50 m<sup>3</sup>, then the 46 m L/h/L-water-capacity requirement results in a steady-state hydrogen concentration of no more than 1 percent.** (An upper limit per storage system of 46 mL/h/L (per container volume capacity) x 330L (system volume capacity) / 60min/hr = 253 mL/min per storage system, which comparable to that derived from the alternative approach 150 mL/min x 50/30.4 247 mL/min (scaling factor R=1.645), which results in a 1 per cent concentration). **This permeation specification has been adopted under the assumption that storage capacity ~330L is not expected for the vehicles within the scope of this gtr, so garages less than 50m<sup>3</sup> can be accommodated.**
- (v) The maximum pressure of a fully filled container at **55 °C** is 115 per cent NWP (equivalent state of charge to 125 per cent NWP at 85°C and 100 per cent NWP at 15 °C).
- (vi) A localized leak test is to be conducted to ensure that external leakage cannot sustain a flame that could weaken materials and subsequently cause loss of containment. Per Technical Report 2008-01-0726 ("Flame Quenching Limits of Hydrogen Leaks"), the lowest flow of H<sub>2</sub> that can support a flame is 0.028 mg/sec per from a typical compression fitting and the lowest leak possible from a miniature burner configuration is 0.005 mg/sec. Since the miniature burner

configuration is considered a conservative "worst case", the maximum leakage criterion is selected as 0.005 mg/sec.

- (vii) Parking provides opportunity for hydrogen saturation of interlaminar layers, wrap/liner interface, liner materials, junctures, o-rings, and joinings – fuelling stresses are applied with and without exposure to hydrogen saturation. Hydrogen saturation is marked by permeation reaching steady-state rate.
  - (viii) By requiring qualification under the worst credible case conditions of raised temperature, pressure cycling and equilibration with hydrogen, the permeation verification removes uncertainty about permeation/temperature dependence, and long term deterioration with time and usage.
- (d) Residual proof pressure (para. 5.1.3.4.)
- (i) Fuelling station over-pressurization is constrained by fuelling station requirements to pressurize at less than 150 per cent NWP. (This requirement for fuelling stations shall be established within local codes/regulations for fuelling stations.)
  - (ii) Laboratory data on static stress rupture was used to define equivalent probability of stress rupture of composite strands. It showed the rupture probability after 4 minutes at 180 per cent NWP to be equivalent for after 10 hours at 150 per cent NWP in the worst case (SAE Technical Report 2009-01-0012). Fuelling stations are expected to protect against over-pressure over 150 per cent NWP.
  - (iii) Field data on the frequency of failures of high pressure fuelling stations involving activation of pressure relief controls is not available. The small number of 70 MPa fuelling stations currently available does not support robust statistics.

- (e) Residual strength burst (para. 5.1.3.5.)

Requirement for less than 20 per cent decline in burst pressure after lifetime service is designed to ensure stability of structural components responsible for rupture resistance; it is linked (in SAE Technical Report 2009-01-0012) to assurance that requirement has allowance for 10 per cent manufacturing variability in assurance of greater than 25 years of rupture resistance at 100 per cent NWP in para. 5.1.2.5.

**As regards container liners, it is suggested that attention should be paid for deterioration of container liners. The container liner could be inspected after burst. Then, the liner and liner/end boss interface could be inspected for evidence of any deterioration, such as fatigue cracking, disbonding of plastics, deterioration of seal, or damage from electrostatic discharge. The record of findings should be shared with the container manufacturer.**

It is expected that regulatory agencies and manufacturers will monitor the condition and performance of storage systems during service life as practical and appropriate to continually verify that para. 5.1.3. performance requirements capture on-road requirements. This advisory is meant to encourage manufacturers and regulatory agencies to collect additional data.

(d) **Rationale for paragraphs 5.1.4. and 6.2.5. verification test for service-terminating performance in fire**

64. Verification of performance under service-terminating conditions is designed to prevent rupture under conditions so severe that hydrogen containment cannot be maintained. Fire is the only service-terminating condition accounted for in design qualification.

65. A comprehensive examination of CNG container in-service failures during the past decade (SAE Technical Paper 2011-01-0251 (Scheffler, McClory et al., "Establishing Localized Fire Test Methods and Progressing Safety Standards for FCVs and Hydrogen Vehicles")) showed that the majority of fire incidents occurred on storage systems that did not utilize properly designed pressure relief devices (PRDs), and the remainder resulted when PRDs did not respond to protect the container due to the lack of adequate heat exposure on the PRDs even though the localized fire was able to degrade the container wall and eventually cause the storage container to burst. The localized fire exposure has not been addressed in previous regulations or industry standards. The fire test method in para. 6.2.5 addresses both localized and engulfing fires.

66. The fire test conditions of para. 6.2.5. were based on vehicle-level tests by the Japanese Automobile Research Institute (JARI) and US manufacturers. A summary of data is found in paper SAE Technical Paper 2011-01-0251. Key findings are as follows:

(a) About 40 per cent of the vehicle laboratory fires investigated resulted in conditions that could be categorized as a localized fire since the data indicates that a composite compressed gas container could have been locally degraded before conventional PRDs on end bosses (away from the local fire exposure) would have activated. (Note: A temperature of 300°C was selected as the temperature where the localized fire condition could start as thermal gravimetric analysis (TGA) indicates that container materials begin to degrade rapidly at this temperature).

(b) While vehicle laboratory fires often lasted 30-60 minutes, the period of localized fire degradation on the storage containers lasted less than 10 minutes.

(c) The average of the maximum temperature during the localized fire period was less than 570°C with peak temperatures reaching approximately between 600 °C and 880 °C in some cases.

(d) The rise in peak temperature near the end of the localized fire period often signaled the transition to an engulfing fire condition.

67. Based upon the above findings, the temperature profile in para. 6.2.5. was adopted. The selection of 600 °C as the minimum temperature for the localized fire hold period ensures that the average temperature and time of localized fire test exposure are consistent with test data. Thermocouples located 25 mm ± 10mm from the outside surface of the test article are used to control the heat input and confirm that the required temperature profile is met. In order to improve the response and controllability of the fire during testing (as well as reproducibility of results), the use of Liquefied Petroleum Gas (LPG) and wind guards are specified. Experience indicates the controllability of the LPG fire will be approximately ±100°C in outdoor situations, producing peak temperatures that also agree favourably with test results.

68. The proposed localized fire test set-up is based on preliminary work done by Transport Canada and the National Highway Traffic Safety Administration (NHTSA) in the United States of America, but the approach was expanded to allow the storage system to be qualified by either a generic installation test or a specific vehicle installation test. Differences between the two methods are as follows:

(a) The generic (non-vehicle specific) allows the localized fire test to apply to more than one vehicle but the mitigation devices (such as shields) need to be permanently affixed to the storage system and shall protect the entire system, not just the area exposed to the localized fire. The size for the generic localized fire test was selected to be 250mm ± 50mm longitudinally with a width covering the diameter of the container.

(b) The specific vehicle installation localized fire test would be customized to align with the actual fire exposure area and would include protective features from the vehicle. If the vehicle manufacturer elects to use the specific vehicle test approach, the direction and size of the localized fire exposure is adjusted to account for vehicle features such as openings in adjacent sheet metal for lightening holes and pass-throughs for wires and piping or holes formed by the melting of materials in the path of the fire. If such openings or holes are small, the size of the localized is reduced from the generic size to create a more challenging (and realistic) test.

**(e) Rationale for paragraphs 5.1.5 and 6.2.6 qualification tests for storage-system hydrogen-flow closures**

69. The reliability and durability of hydrogen-flow closures is essential for the integrity of the full storage system. The closures are partially qualified by their function in the system-level performance tests (paragraph 5.1.). In addition, these closures are qualified individually not only to assure exceptional reliability for these moving parts, but also to enable equivalent components to be exchanged in a storage system without re-qualifying the entire storage system. Closures that isolate high pressure hydrogen from the remainder of the fuel system and the environment include:

(a) thermally activated pressure relief device (TPRD). A TPRD opens and remains open when the system is exposed to fire.

(b) check valve. A check valve prevents reverse flow in the vehicle fuelling line, e.g. a non-return valve. Equivalent to a non-return valve.

(c) shut-off valve. An automatic shut-off valve between the storage container and the vehicle fuel delivery system defaults to the closed position when unpowered.

70. Test procedures for qualification of hydrogen-flow closures within the hydrogen storage system were developed by the International Organization of Vehicle Manufacturers (OICA) as outgrowths of discussions within CSA workgroups for **TPRD1:2009** and **HGV3.1** (as yet unpublished), and reports to those CSA workgroups testing sponsored by US-DOE and performed at Powertech Laboratories to verify closure test procedures under discussion within CSA.

*(i) Rationale for TPRD qualification requirements*

71. The qualification requirements verify that the device, once activated, will fully vent the contents of the fuel container even at the end of the service life when the device has been exposed to fuelling/defuelling pressure and temperature changes and environmental exposures. The adequacy of flow rate for a given application is verified by the hydrogen storage system fire test requirements (para. 5.1.4.).

*(ii) Rationale for check valve qualification requirements*

72. These requirements are not intended to prevent the design and construction of components (e.g. components having multiple functions) that are not specifically prescribed in this standard, provided that such alternatives have been considered in testing the components. In considering alternative designs or construction, the materials or methods used shall be evaluated by the testing facility to ensure equivalent performance and

reasonable concepts of safety to that prescribed by this standard. In that case, the number of samples and order of applicable tests shall be mutually agreed upon by the manufacturer and the testing agency. Unless otherwise specified, all tests shall be conducted using hydrogen gas that complies with SAE J2719 (Information report on the development of a hydrogen quality guideline for fuel cell vehicles), or ISO 14687-2 (Hydrogen fuel-product specification). The total number of operational cycles shall be 11,000 (fuelling cycles) for the check valve and 50,000 (duty cycles) for the automatic shut-off valve.

73. Fuel flow shut-off by an automatic shut-off valve mounted on a compressed hydrogen storage container shall be fail-safe. The term "fail safe" refers to a device that reverts to a safe mode or a safe complete shutdown for all reasonable failure modes.

74. The electrical tests for the automatic shut-off valve mounted on the compressed hydrogen storage containers (para. 6.2.6.2.7.) provide assurance of performance with: (i) over temperature caused by an overvoltage condition, and (ii) potential failure of the insulation between the component's power conductor and the component casing. The purpose of the pre-cooled hydrogen exposure test (para. 6.2.6.2.10.) is to verify that all components in the flow path from the receptacle to the container that are exposed to precooled hydrogen during fuelling can continue to operate safely.

**(f) Rationale for paragraph 5.1.6. labelling**

75. The purpose of minimum labelling on the hydrogen storage containers is three-fold: (i) to document the date when the system should be removed from service, (ii) to record information needed to trace manufacturing conditions in event of on-road failure, and (iii) to document NWP to ensure installation is consistent with the vehicle fuel system and fuelling interface. Contracting Parties may specify additional labelling requirements. Since the number of pressure cycles used in qualification under para. 5.1.1.2. may vary between Contracting Parties, that number shall be marked on each container.

**2. Vehicle fuel system requirements and safety needs**

**(a) In-Use Requirements**

*(i) Fuelling receptacle rationale for paragraphs 5.2.1.1. and 6.1.7.*

76. The vehicle fuelling receptacle should be designed to ensure that the fuelling pressure is appropriate for the vehicle fuel storage system. Examples of receptacle designs can be found in ISO 17268, SAE J2600 and SAE J2799. A label shall be affixed close to the fuelling receptacle to inform the fueller/driver/owner of the type of fuel (liquid or gaseous hydrogen), NWP and date for removal of storage containers from service. Contracting parties may specify additional labelling requirements.

*(ii) Rationale for paragraph 5.2.1.2. overpressure protection for the low pressure System*

77. The hydrogen delivery system downstream of a pressure regulator is to be protected against overpressure due to the possible failure of the pressure regulator.

*(iii) Rationale for paragraph 5.2.1.3. hydrogen discharge system*

**a. Rationale for paragraph 5.2.1.3.1. pressure relief systems**

78. The vent line of storage system discharge systems (TPRDs and PRDs) should be protected by a cap to prevent blockage by intrusion of objects such as dirt, stones, and freezing water.

## b. Rationale for paragraph 5.2.1.2. fuel cell / engine exhaust systems

79. In order to ensure that the exhaust discharge from the vehicle is non-hazardous, a performance-based test is designed to demonstrate that the discharge is non-ignitable. The 3 second rolling-average accommodates extremely short, non-hazardous transients up to 8 per cent without ignition. Tests of flowing discharges have shown that flame propagation from the ignition source readily occurs above 10 per cent hydrogen, but does not propagate below 8 per cent hydrogen (SAE Technical Report 2007-01-437, Corfu et al., "Development of Safety Criteria for Potentially Flammable Discharges from Hydrogen Fuel Cell Vehicles"). By limiting the hydrogen content of any instantaneous peak to 8 per cent, the hazard to people near the point of discharge is controlled even if an ignition source is present. The time period of the rolling-average is determined to ensure that the space around the vehicle remains non-hazardous as the hydrogen from exhaust diffuses into the surroundings; this is the case of an idling vehicle in a closed garage. In order to readily gain acceptance for this situation by building officials and safety experts, it should be recognized that government/municipal building codes and internationally-recognized standards such as International Electrotechnical Commission (IEC) 60079 require that the space be less than 25 per cent Lower Flammability Limit (LFL) (or 1 per cent hydrogen) by volume. The time limit for the rolling-average was determined by assuming an extremely high hydrogen discharge rate that is equivalent to the input to a 100 kW fuel cell stack. The time was then calculated for this hydrogen discharge to fill the nominal space occupied by a passenger vehicle (4.6m x 2.6m x 2.6m) to 25 per cent LFL. The resultant time limit was conservatively estimated to be 8 seconds for a "rolling average," demonstrating that the 3-second rolling average used in this document is appropriate and accommodates variations in garage and engine size. The standard ISO instrumentation requirement is a factor of 6-10 less than the measured value. Therefore, during the test procedure according to para. 6.1.4., the 3-second rolling average requires a sensor response (90 per cent of reading) and recording rate of less than 300 milliseconds.

## (iv). Rationale for paragraph 5.2.1.4. protection against flammable conditions:

80. Single Failure Conditions. Dangerous situations can occur if unintended leakage of hydrogen reaches flammable concentrations.

(a) ~~The on board hydrogen container should be equipped with a shut off valve that can be automatically activated.~~ **Any single failure downstream of the main hydrogen shut off valve shall not result in any level of hydrogen concentration in air anywhere in the passenger compartment.**

(b) Protection against the occurrence of ~~4 per cent by volume~~ hydrogen in air (~~or greater~~) in the enclosed or semi-enclosed spaces within the vehicle that contain unprotected ignition sources is important.

(i) Vehicles may achieve this objective by design (for example, where spaces are vented to prevent increasing hydrogen concentrations).

(ii) **The vehicle achieves this objective by detection of hydrogen concentrations in air of  $2 \pm 1.0$  per cent or greater, then the warning shall be provided. If the hydrogen concentration exceeds  $3 \text{ per cent} \pm 1.0 \text{ per cent}$  by volume in air in the enclosed or semi-enclosed spaces of the vehicle, the main shutoff valve shall be closed to isolate the storage system.**

[(c) Additionally, a more stringent requirement of 2 per cent hydrogen by volume in air is applied to the passenger compartment to further limit potential exposure to combustible gases in this occupied space. As in item b above, the main hydrogen shutoff valve(s) is to be closed when (or before) this level is reached in the passenger compartment. This requirement can be met by locating a hydrogen sensor in the passenger or by utilizing

other fault detection methods to shut-off the hydrogen supply before the passenger compartment criteria is exceeded.]

(v) *Rationale for paragraph 5.2.1.5. fuel leakage*

81. Detectable leakage is not permitted.

(vi) *Rationale for paragraph 5.2.1.6. visual signal/warning system*

82. A visual signal/warning system is to alert the driver when hydrogen leakage results in concentration levels at or above 4 per cent by volume within the passenger compartment, luggage compartment, and spaces with unprotected ignition sources within the vehicle. The visual signal/warning system should also alert the driver in case of a malfunction of the hydrogen detection system. Furthermore, the system shall be able to respond to either scenario and instantly warn the driver. The shut-off signal shall be inside the occupant compartment in front of and in clear view of the driver. There is no data available to suggest that the warning function of the signal would be diminished if it is only visual. In case of a detection system failure, the signal warning light should be yellow. In case of the emergency shut-off of the valve, the signal warning light should be red.

(vii) *Lower flammability limit (LFL)*

83. (Background for paragraph 3.9.): Lowest concentration of fuel in which a gas mixture is flammable. National and international standard bodies (such as National Fire Protection Association (NFPA) and IEC) recognize 4 per cent hydrogen by volume in air as the LFL (US Department of Interior, Bureau of Mines Bulletin 503, 1952; Houf and Schefer, "Predicting Radiative Heat Fluxes and Flammability Envelopes from Unintended Releases of Hydrogen," International Journal of Hydrogen Energy 31, pp 136-151, 2007; NASA RD-WSTF-0001, 1988). The LFL, which depends on the temperature, pressure and presence of dilution gases, has been assessed using specific test methods (e.g. American Society for Testing (ASTM) E681-04). While the LFL value of 4 per cent is appropriate for evaluating flammability in general surroundings of vehicles or inside passenger compartments, this criterion may be overly restrictive for flowing gas situations where ignition requires more than 4 per cent hydrogen in many cases. Whether an ignition source at a given location can ignite the leaking gas plume depends on the flow conditions and the type of ignition. At 4 per cent hydrogen in a stagnant room-temperature mixture, combustion can only propagate in the upward direction. At approximately 8 to 10 per cent hydrogen in the mixture, combustion can also be propagated in the downward and horizontal directions and the mixture is readily combustible regardless of location of ignition source. [Coward, H.F. et al, "Limits of flammability of gases and vapors," Bureau of Mines Bulletin 503; 1952, USA; Benz, F.J. et al, "Ignition and thermal hazards of selected aerospace fluids", RD-WSTF-0001, NASA Johnson Space Center White Sands Test Facility, Las Cruces, NM, USA, October 1988; Houf, W.G. et al, "Predicting radiative heat fluxes and flammability envelopes from unintended releases of hydrogen," International Journal of Hydrogen Energy, 32 pp136-141, 2007]

(viii) *Recommended features for design of a hydrogen fuel system*

84. As any performance-based technical regulation cannot include testing requirements for every possible scenario, this section is to provide manufacturers a list of items that they should consider during the design of hydrogen fuelling systems with the intention to reduce hydrogen leaks and provide a safe product:

- (a) The hydrogen fuel system should function in a safe and proper manner and be designed to minimize the potential for hydrogen leaks, (e.g. minimize line connections to the extent possible).

- (b) The hydrogen fuel system should reliably withstand the chemical, electrical, mechanical and thermal service conditions that may be found during normal vehicle operation.
- (c) The materials used should be compatible with gaseous or liquid hydrogen, as appropriate.
- (d) The hydrogen fuel system should be installed such that it is protected against damage under normal operating conditions.
- (e) Rigid fuel lines should be secured such that they shall not be subjected to critical vibration or other stresses.
- (f) The hydrogen fuel system should protect against excess flow in the event of a failure downstream.
- (g) No component of the hydrogen fuel system, including any protective materials that form part of such components, should project beyond the outline of the vehicle or protective structure.

**(b) Post crash requirements**

*(i) Rationale for paragraph 5.2.2.1. post crash test leakage limit*

85. Allowable post-crash leakage in Federal Motor Vehicle Safety Standard (FMVSS) 301 (for the United States of America) and Regulation Nos. 94 and 95 are within 6 per cent of each other for the 60 minute period after the crash. Since the values are quite similar, the value in Regulation No. 94 of 30g/min was selected as a basis for the calculations to establish the post-crash allowable hydrogen leakage for this gtr.

86. The criterion for post-crash hydrogen leakage is based on allowing an equivalent release of combustion energy as permitted by gasoline vehicles. Using a lower heating value of 120 MJ/kg for hydrogen and 42.7 MJ/kg for gasoline based on the US DOE Transportation Data Book, the equivalent allowable leakage of hydrogen can be determined as follows:

$$W_H = 30\text{g/min gasoline leakage} \times \frac{42.7\text{MJ/kg}}{120\text{MJ/kg}} = 10.7\text{g/min hydrogen leakage}$$

For vehicles with either compressed hydrogen storage systems or liquefied hydrogen storage systems. The total allowable loss of hydrogen is therefore 642g for the 60 minute period following the crash.

87. The allowable hydrogen flow leakage can also be expressed in volumetric terms at normal temperature (0°C) and pressure as follows:

$$V_H = \frac{10.7 \text{ g/min}}{2(1.00794) \text{ g/mol}} \times 22.41 \text{ NL/mol} = 118\text{NL/min}$$

for vehicles with either compressed or liquid hydrogen storage.

88. As confirmation of the hydrogen leak rate, JARI conducted ignition tests of hydrogen leaks ranging from 131 NL/min up to 1000 NL/min under a vehicle and inside the engine compartment. Results showed that, while a loud noise can be expected from ignition of the hydrogen, the sound pressure level and heat flux were not enough (even at a 1000 NL/min leak rate) to damage the under floor area of the vehicle, release the vehicle hood, or injure a person standing 1 m from the vehicle (SAE Technical Paper 2007-01-0428



"Diffusion and Ignition Behavior on the Assumption of Hydrogen Leakage from a Hydrogen-Fuelled Vehicle"). The container shall remain attached to the vehicle at a minimum of one attachment point.

(ii) *Rationale for paragraph 5.2.2.2. post-crash concentration limit in enclosed spaces*

89. This test requirement has been established to ensure that hydrogen does not accumulate in the passenger, luggage, or cargo compartments that could potentially pose a post-crash hazard. The criteria was conservatively set to 4 per cent hydrogen by volume as the value represents the lowest possible level at which combustion can occur (and the combustion is extremely weak at this value). Since the test is conducted in parallel with the post-crash leak test and therefore will extend for at least 60 minutes, there is no need to provide margin on the criteria to manage dilution zones as there is sufficient time for the hydrogen to diffuse throughout the compartment.

(iii) *Rationale for container displacement.*

90. One of the crash safety regulations for vehicles with compressed gas fuel systems is Canada's Motor Vehicle Safety Standard (CMVSS) 301. Its characteristic provisions include the fuel container installation requirement for prevention of displacement.

### 3. Electric safety requirements and safety needs

(a) *Rationale for electric safety requirements*

91. A failure of a high voltage system may cause an Electric Shock of a (human) body. Such a shock will may happen with any source of electricity that causes a sufficient current through the skin, muscles or hair. Typically, the expression is used to denote an unwanted exposure to electricity, hence the effects are considered undesirable.

[http://en.wikipedia.org/wiki/Electric\\_shock](http://en.wikipedia.org/wiki/Electric_shock) - cite\_note-0

92. The minimum current a human can feel depends on the current type (AC or DC) and frequency. A person can feel at least 1 mA (rms) of AC at 60 Hz, while at least 5 mA for DC. The current may, if it is high enough, cause tissue damage or fibrillation which leads to cardiac arrest. 60 mA of AC (rms, 60 Hz) or 300–500 mA of DC can cause fibrillation.

93. A sustained electric shock from AC at 120 V, 60 Hz is an especially dangerous source of ventricular fibrillation because it usually exceeds the let-go threshold, while not delivering enough initial energy to propel the person away from the source. However, the potential seriousness of the shock depends on paths through the body that the currents take.

94. If the voltage is less than 200 V, then the human skin is the main contributor to the impedance of the body in the case of a macro-shock the passing of current between two contact points on the skin. The characteristics of the skin are non-linear however. If the voltage is above 450–600 V, then dielectric breakdown of the skin occurs. The protection offered by the skin is lowered by perspiration, and this is accelerated if electricity causes muscles to contract above the let-go threshold for a sustained period of time.

(b) *In-Use requirements*

95. "In-Use Requirements" are the specifications which have to be considered when the fuel cell vehicle is engineered. These have to be fulfilled to avoid any electric hazard to passengers of an electric vehicle.

96. The requirements are focusing on the electric power train operating on high voltage as well as the high voltage components and systems which are galvanically connected.

97. To avoid electrical hazards it is requested that live parts (= conductive part(s) intended to be electrically energized in normal use) are protected against direct contact.

98. Protection against direct contact inside the passenger compartment has to be checked by using a standardized Test Wire (IPXXD).

**Standardized Test Wire**



99. Outside the compartment a standardized Test Finger (IPXXB) has to be used to check whether a contact with live parts is possible or not.

### Standardized Test Finger



100. Furthermore exposed conductive parts (= parts which can be touched with the standardized Test Finger and becomes electrically energized under isolation failure conditions) have also to be protected against indirect contact. This means that e.g. conductive barriers or enclosures have to be galvanically connected securely to the electrical chassis.

101. Beside protection of direct and indirect contact isolation resistance is required for AC (Alternating Current) and DC (Direct Current) systems. Isolation resistance measured against the electrical chassis is a physical dimension describing which maximum current flowing through the human body is not dangerous.

102. While DC systems are less harmful to the humans (see para. 5.4.1.) 100  $\Omega$ /Volt are required. AC systems have to fulfill 500  $\Omega$ /Volt. For the DC systems an on-board isolation resistance monitoring system is required which warns the driver when the resistance is below 100  $\Omega$ /Volt.

103. The isolation resistance requirements of 100  $\Omega$ /Volt for DC or 500  $\Omega$ /Volt for AC allow maximum body currents of 10 mA and 2 mA respectively.

#### (c) *Post-crash requirements*

104. Post-Crash requirements are the specifications which have to be fulfilled by the vehicles after the impact. They do not describe the way how the impact has to be conducted. This is the responsibility of each Contracting Party. The requirements have to be fulfilled to avoid any electric hazard to passengers of the vehicle.

105. The requirements are focusing on the electric power train operating on high voltage as well as the high voltage components and systems which are galvanically connected.

106. After the impact of the vehicle the following three measures demonstrate that the systems are safe. It means that the remaining "electricity level" of the high voltage systems are no longer dangerous to the passengers of the vehicle.

##### (a) Absence of high Voltage

After the impact the voltage is equal or less than 30 VAC or 60 VDC

##### (b) Isolation Resistance

Isolation resistance measured against the electrical chassis is a physical dimension describing which maximum current is not dangerous to the human being.

After the impact for AC systems measured against the electrical chassis the minimum isolation resistance has to be 500  $\Omega$ /Volt and for DC systems 100  $\Omega$ /Volt.

The isolation resistance requirements of 100  $\Omega$ /Volt for DC or 500  $\Omega$ /Volt for AC allow maximum body currents of 10 mA and 2 mA respectively.

##### (c) Physical protection

After the impact it should not be possible to touch live parts after the crash, tested with the standardized Test Finger. Furthermore protection against indirect contact has also been fulfilled.

By decision of the Contracting Parties of the 1998 Agreement a fourth measure is allowed

- (d) Low Energy

After the impact the energy of the system has to be below 2.0 Joules.

## F. Rationale for storage and fuel system test procedures

107. Test procedures in para. 6. replicate on-road conditions for performance requirements specified in B 5. Most test procedures derive from test procedures specified in historical national regulations and/or industry standards.

### 1. Rationale for storage and fuel system integrity tests

- (a) *Rationale for paragraph 6.1.1. test procedure for post-crash leak test procedure for compressed hydrogen storage systems*

108. The post-crash leak test is organized as follows:

6.1.1.1. Test procedure when the test gas is hydrogen

6.1.1.2. Test procedure when the test gas is helium

109. The loss of fuel represents the allowable release for the entire compressed hydrogen storage system on the vehicle. The post-crash release can be determined by measuring the pressure loss of the compressed storage system over a time period of at least 60 minutes after the crash and then calculating the release rate of hydrogen based on the measured pressure loss and the time period using the equation of state of the compressed gas in the storage system. (See the SAE Technical Paper 2010-10B-0164, "Development of the Methodology for FCV Post-crash Fuel Leak Testing in Corporated into SAE J2578 for a complete discussion of the methodology.) In the case of multiple hydrogen storage containers that are isolated from each other after crash, it may be necessary to measure hydrogen loss individually (using the approach in para. 5.2.2.1.) and then sum the individual values to determine the total release of hydrogen gas from the storage system.

110. The methodology can also be expanded to allow the use of a non-flammable gas for crash testing. Helium has been selected as it, like hydrogen, has low molecular weight. In order to determine the ratio of volumetric flows between helium and hydrogen releases (and thus establish a required relationship between hydrogen and helium leakage, we assume that leakage from the compressed hydrogen storage system can be described as choked flow through an orifice where the orifice area (A) represents the total equivalent leakage area for the post-crash system. In this case the equation for mass flow is given by:

$$W = C \times C_d \times A \times (\rho \times P)^{1/2}$$

where  $C_d$  is the orifice discharge coefficient, A is the orifice area, P are the upstream (stagnation) fluid density and pressure, and  $\rho$  and C are given by

$$\rho = R_u \times T / M$$

and

$$C = \gamma / (\gamma + 1)^{(\gamma+1)/(\gamma-1)}$$

where  $R_u$  is the universal gas constant and T, M, and  $\gamma$  are the temperature, molecular weight, and ratio of specific heats ( $C_V/C_P$ ) for the particular gas that is

leaking. Since  $C_d$ ,  $A$ ,  $R_u$ ,  $T$ , and  $P$  are all constant for the situation of determining the relationship between post-crash helium and hydrogen leakage, the following equation describes the flow ratio on a mass basis.

$$W_{H_2} / W_{He} = C_{H_2} / C_{He} \times (M_{H_2} / M_{He})^{1/2}$$

111. Since we can determine the volumetric flow ratio by multiplying the mass flow ratio by the ratio of molecular weights ( $M$ ) at constant temperature and pressure conditions are the same.

$$V_{H_2} / V_{He} = C_{H_2} / C_{He} \times (M_{He} / M_{H_2})^{1/2}$$

112. Based on the above relationship, it is possible to determine that the ratio of the volumetric flow (and therefore the ratio gas concentration by volume) between helium test gas and hydrogen is approximately 75 per cent for the same leak passages from the storage system. Thus, the post-crash hydrogen leakage can be determined by

$$V_{H_2} = V_{He} / 0.75$$

where  $V_{He}$  is the post-crash helium leakage (NL/min).

(b) *Rationale for paragraph 6.1.2. (Test procedure for post-crash concentration test in enclosed spaces for vehicles with compressed hydrogen storage systems)*

113. The test may be conducted by measuring hydrogen or by measuring the corresponding depression in oxygen content. Sensors are to be located at significant locations in the passenger, luggage, and cargo compartments. Since the test is conducted in parallel with the post-crash leak test of the storage system and therefore will extend for at least 60 minutes, there is no need to provide margin on the criteria to manage dilution zones as there is sufficient time for the hydrogen to diffuse throughout the compartment.

114. In the case where the vehicle is not crashed with hydrogen and a leak test is conducted with compressed helium, it is necessary to define a criteria for the helium content that is equivalent to 4 per cent hydrogen by volume. Recognizing that the content of hydrogen or helium in the compartment (by volume) is proportional to the volumetric flow of the respective releases, it is possible to determine the allowable helium content by volume,  $X_{He}$ , from the equation developed in paras. 104 to 108 of the preamble by multiplying the hydrogen concentration criteria by 0.75. The criteria for helium concentration is therefore as follows:

$$X_{He} = 4 \text{ per cent } H_2 \text{ by volume} \times 0.75 = 3.0 \text{ per cent by volume.}$$

The criteria for helium concentration is therefore 3 per cent by volume in the passenger, luggage, and cargo compartments if the crash test of a vehicle with a compressed storage system is conducted with compressed helium instead of compressed hydrogen.

115. An example of hydrogen concentration measurement locations can be found in the document "Examples of hydrogen concentration measurement points for testing" (OICA report to SGS-3 based on Japanese Regulation Attachment 100).

**2. Rationale for paragraph 6.2. (Test procedures for compressed hydrogen storage systems)**

116. Most test procedures for hydrogen storage systems derive from test procedures specified in historical national regulations and/or industry standards. Key differences are the execution of tests in sequence (as opposed to historical execution of tests in parallel, each on a separate new container), and slowing of the filling rate in burst testing to correspond to in-service fuelling rates. In addition, hold times at burst pressure test points

have been extended to 4 minutes. These changes are designed to reduce the sensitivity of initial burst measurements to the fuelling rate and to evaluate capability to sustain pressure. An evaluation of the sufficiency and stringency of requirements in this gtr document compared to historical EU requirements is given in Transport Research Laboratory Project Report RPN1742 "Hydrogen-Powered Vehicles: A Comparison of the European Legislation and the draft UNECE global technical regulation" by C. Visvikis.

117. Requirements for closures of the hydrogen storage system (TPRD, automatic shut-off valve and check valve) have been developed by CSA (HGV3.1 and TPRD-1).

(a) Evaluations of cycling durability at 50,000 cycles (para. 6.2.6.2.3.) reflect multiple pressure pulses against check valves during fuelling and multiple operations of automatic shut-off valves between fuellings.

(b) Vibration tests (para. 6.2.6.2.8.) were designed to scan frequencies from 10 to 500 Hz because several component testing facilities reported that there can be more than one resonant frequency. The frequency of 17 Hz used historically in component vibration tests was established through demonstration of one vehicle traveling over a variety of road surfaces, and it reflects the influence of engine proximity. However, it is expected that the resonant frequency could change based upon the component design and mounting provisions, so to ensure the most severe condition is identified, a sweep to 500 Hz is required.

(c) The temperature sensitivity,  $T_{life} = 9.1 \times T_{act}^{0.503}$ , specified in the Accelerated Life Test (para. 6.2.6.1.2.) is based on D. Stephens (Battelle Memorial Institute) "Rationale for Long-Term Test Temperature for Thermally Activated PRDs." at [stephens@battelle.org](mailto:stephens@battelle.org); gtr Web Reference.

## **G. Optional requirements: vehicles with liquefied hydrogen storage systems / rationale**

118. Since hydrogen fuelled vehicles are in the early stages of development and commercial deployment, testing and evaluation of test methods to qualify vehicles for on-road service has been underway in recent years. However, liquefied hydrogen storage systems (LHSS) have received considerably less evaluation than have compressed gas storage systems. At the time of the development of this document, an LHSS vehicle has been proposed by only one manufacturer, and on-road vehicle experience with LHSS is very limited. The proposed LHSS requirements in this document have been discussed on a technical basis, and while they seem reasonable, they have not been validated. Due to this limited experience with LHSS vehicles, some Contracting Parties have requested more time for testing and validation. Therefore, the requirements for LHSS have been presented in section G as optional.

### **1. Background Information for liquid hydrogen storage systems**

#### **(a) Hydrogen gas has a low energy density per unit volume**

119. To overcome this disadvantage, the liquefied hydrogen storage system (LHSS) maintains the hydrogen at cryogenic temperatures in a liquefied state.

#### **(b) A typical liquefied hydrogen storage system (LHSS) is shown Figure 4**

120. Actual systems will differ in the type, number, configuration, and arrangement of the functional constituents. Ultimately, the boundaries of the LHSS are defined by the interfaces which can isolate the stored liquefied (and/or gaseous) hydrogen from the

remainder of the fuel system and the environment. All components located within this boundary are subject to the requirements defined in this Section while components outside the boundary are subject to general requirements in Section 4. For example, the typical LHSS shown in Figure 4 consists of the following regulatory elements:

- (a) liquefied hydrogen storage container(s),
- (b) shut off devices(s),
- (c) a boil-off system,
- (d) Pressure Relief Devices (PRDs),
- (e) the interconnecting piping (if any) and fittings between the above components.

Figure 4

**Typical liquefied storage system**

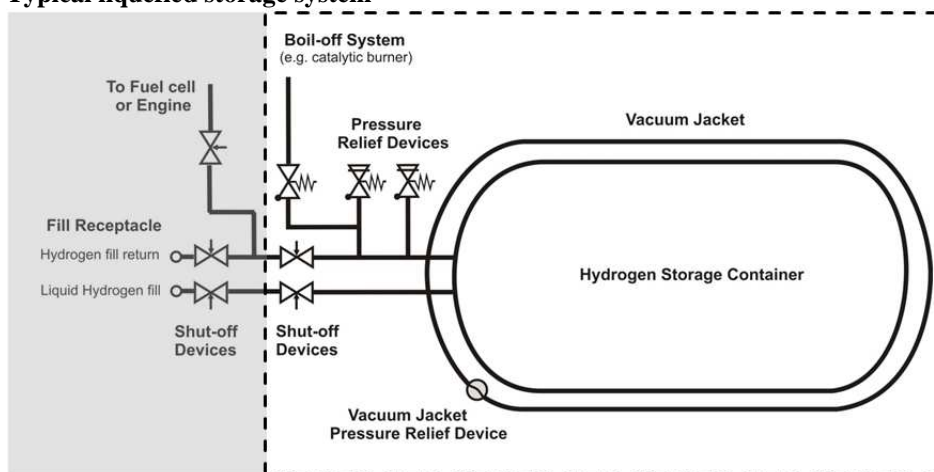

- (c) **During fuelling, liquefied hydrogen flows from the fuelling system to the storage container(s)**

121. Hydrogen gas from the LHSS returns to the filling station during the fill process so that the liquefied hydrogen can flow into liquefied hydrogen storage container(s) without over pressurizing the system. Two shut-offs are provided on both the liquefied hydrogen fill and hydrogen fill return line to prevent leakage in the event of single failures.

- (d) **Liquefied hydrogen is stored at cryogenic conditions**

122. In order to maintain the hydrogen in the liquid state, the container needs to be well insulated, including use of a vacuum jacket that surrounds the storage container. Generally accepted rules or standards (such as those listed in para. 7.) are advised for use in the proper design of the storage container and the vacuum jacket.

- (e) **During longer parking times of the vehicle, heat transfer will induce a pressure rise within the hydrogen storage container(s)**

123. A boil-off system limits heat leakage induced pressure rise in the hydrogen storage container(s) to a pressure specified by the manufacturer. Hydrogen that is vented from the LHSS may be processed or consumed in down-stream systems. Discharges from the vehicle resulting from over-pressure venting should be addressed as part of allowable leak/permeation from the overall vehicle.

**(f) Malfunction**

124. In case of malfunction of the boil-off system, vacuum failure, or external fire, the hydrogen storage container(s) are protected against overpressure by two independent Pressure Relief Devices (PRDs) and the vacuum jacket(s) is protected by a vacuum jacket pressure relief device.

**(g) When hydrogen is released to the propulsion system, it flows from the LHSS through the shut-off valve that is connected to the hydrogen fuel delivery system**

125. In the event that a fault is detected in the propulsion system or fuelling receptacle, vehicle safety systems usually require the container shut-off valve to isolate the hydrogen from the down-stream systems and the environment.

**2. Rationale for liquefied hydrogen storage system design qualification requirements of para 7.2.**

126. The containment of the hydrogen within the liquefied hydrogen storage system is essential to successfully isolating the hydrogen from the surroundings and down-stream systems. The system-level performance tests in para. 7.2. were developed to demonstrate a sufficient safety level against rupture of the container and capability to perform critical functions throughout service including pressure cycles during normal service, pressure limitation under extreme conditions and faults, and in fires.

127. Performance test requirements for all liquefied hydrogen storage systems in on-road vehicle service are specified in paragraph 7.2. These criteria apply to qualification of storage systems for use in new vehicle production.

128. This section (specifies the rationale for the performance requirements established in paragraph 7.2. for the integrity of the liquefied hydrogen storage system. Manufacturers are expected to ensure that all production units meet the requirements of performance verification testing in paragraphs 7.2.1. to 7.2.4.

**(a) Rationale for verification tests for baseline metrics for LHSSs paragraph 7.2.1.**

129. A proof pressure test and a baseline initial burst test are intended to demonstrate the structural capability of the inner container.

*(i) Rationale for proof pressure requirement in paragraphs 7.2.1.1. and 7.4.1.1.*

130. By design of the container and specification of the pressure limits during regular operation and during fault management (as demonstrated in paragraphs 7.4.2.2. and 7.4.2.3.), the pressure in the inner container could rise to 110 per cent of the Maximum Allowable Working Pressure (MAWP) during fault management by the primary pressure relief device and no higher than 150 per cent of MAWP even in "worst case" fault management situations where the primary relief device has failed and the secondary pressure relief device is required to activate and protect the system. The purpose of the proof test to 130 per cent MAWP is to demonstrate that the inner container stays below its yield strength at that pressure.

*(ii) Rationale for baseline initial burst pressure requirement paragraphs 7.2.1.2. and 7.4.1.2.*

131. By design (and as demonstrated in paragraph 5.2.3.3.), the pressure may rise up to 150 per cent of the Maximum Allowable Working Pressure (MAWP) when the secondary (backup) pressure relief device(s) may be required to activate. The burst test is intended to demonstrate margin against burst during this "worst case" situation. The pressure test levels of either the Maximum Allowable Working Pressure (in MPa) plus 0.1 MPa multiplied by



3.25, or the Maximum Allowable Working Pressure (MAWP) (in MPa) plus 0.1 MPa multiplied by 1.5 and multiplied by  $R_m/R_p$  (where  $R_m$  is ultimate tensile strength and  $R_p$  is minimum yield strength of the container material), are common values to provide such margin for metallic liners.

132. Additionally, the high burst test values (when combined with proper selection of materials demonstrate that the stress levels are acceptably low such that cycle fatigue issues are unlikely for metallic containers that have supporting design calculations. In the case of non-metallic containers, an additional test is required in paragraph 7.4.1.2. to demonstrate this capability as the calculation procedures have not yet been standardized for these materials.

**(b) Rationale for verification for expected on-road performance paragraph 7.2.2.**

*(i) Rationale for boil-off requirement paragraphs 7.2.2.1. and 7.4.2.1.*

133. During normal operation the boil-off management system shall limit the pressure below MAWP. The most critical condition for the boil-off management system is a parking period after a refuelling to maximum filling level in a liquefied hydrogen storage system with a limited cool-down period of a maximum of 48 hours.

*(ii) Rationale for hydrogen leak requirement paragraphs 7.2.2.2. and 7.4.2.2.*

134. The hydrogen discharge test shall be conducted during boil-off of the liquid storage system. Manufacturers will typically elect to react all (or most) of the hydrogen that leaves the container, but, in order to have a hydrogen discharge criteria that is comparable to the values used for Compressed Hydrogen Storage Systems, it should count any hydrogen that leaves the vehicle boil-off systems with other leakage, if any, to determine the total hydrogen discharge from the vehicles.

135. Having made this adjustment, the allowable hydrogen discharge from a vehicle with liquefied hydrogen storage is the same as for a vehicle with compressed hydrogen storage. According to the discussion in paragraphs 62 and 63 of section E1(c) of the preamble, the total discharge from a vehicle with liquefied hydrogen may therefore be 150 mL/min for a garage size of 30.4 m<sup>3</sup>. As with compressed gas, the scaling factor,  $[(V_{width}+1)*(V_{height}+0.05)*(V_{length}+1)/30.4]$ , can be used to accommodate alternative garage/vehicle combinations to those used in the derivation of the rate, and accommodates small vehicles that could be parked in smaller garages.

136. Prior to conducting this test, the primary pressure relief device is forced to activate so that the ability of the primary relief device to re-close and meet required leakage is confirmed.

*(iii) Rationale for vacuum loss requirement paragraph 7.2.2.3. and test procedure of paragraph 7.4.2.3.*

137. In order to prove the proper function of the pressure relief devices and compliance with the allowed pressure limits of the liquefied hydrogen storage system as described in section G2(b) of the preamble and verified in paragraph 7.4.1., a sudden vacuum loss due to air inflow in the vacuum jacket is considered as the "worst case" failure condition. In contrast to hydrogen inflow to the vacuum jacket, air inflow causes significantly higher heat input to the inner container due to condensation of air at cold surfaces and evaporation of air at warm surfaces within the vacuum jacket.

138. The primary pressure relief device should be a re-closing type relief valve so that hydrogen venting will cease when the effect of a fault subsides. These valves, by globally-accepted design standards, are allowed a total pressure increase of 10 per cent between the

setpoint and full activation when including allowable tolerances of the setpoint setting itself. Since the relief valve should be set at or below the MAWP, the pressure during a simulation of the fault that is managed by the primary pressure relief device should not exceed 110 per cent of Maximum Allowable Working Pressure (MAWP).

139. The secondary pressure relief device(s) should not activate during the simulation of a vacuum loss that is managed by the primary relief device as their activation may cause unnecessary instability and unnecessary wear on the secondary devices. To prove fail-safe operation of the pressure relief devices and the performance of the second pressure relief device in accordance with the requirements in paragraphs 7.2.2.3. and 7.4.2.3., a second test shall be conducted with the first pressure relief device blocked. In this case, either relief valves or burst discs may be used, and the pressure is allowed to rise to as high as 136 per cent MAWP (in case of a valve used as secondary relief device) or as high as 150 per cent MAWP (in case of a burst disc used as secondary relief device) during the simulation of a vacuum loss fault.

**(c) Rationale for paragraph 7.2.3. verification test for service-terminating conditions.**

140. In addition to vacuum degradation or vacuum loss, fire also may cause overpressure in liquefied hydrogen storage systems and thus proper operation of the pressure relief devices have to be proven in a bonfire test.

**(d) Rationale for verification of LHSS components: pressure relief device(s) and shut off valves paragraph 7.2.4.**

*(i) Rationale for pressure relief device qualification requirements (LHSS) paragraph 7.2.4.1.*

141. The qualification requirements verify that the design shall be such that the device(s) will limit the pressure of the fuel container to the specified values even at the end of the service life when the device has been exposed to fuelling/de-fuelling pressure and temperature changes and environmental exposures. The adequacy of flow rate for a given application is verified by the hydrogen storage system bonfire test and vacuum loss test requirements (paras. 7.2.3. and 7.4.3.).

*(ii) Rationale for shut-off valve qualification requirements (LHSS) paragraph 7.2.4.2.*

142. These requirements are not intended to prevent the design and construction of components (e.g. components having multiple functions) that are not specifically prescribed in this standard, provided that such alternatives have been considered in testing the components. In considering alternative designs or construction, the materials or methods used shall be evaluated by the testing facility to ensure equivalent performance and reasonable concepts of safety to that prescribed by this standard. In that case, the number of samples and order of applicable tests shall be mutually agreed upon by the manufacturer and the testing agency. Unless otherwise specified, all tests shall be conducted using pressurised gas such as air or nitrogen containing at least 10 per cent helium (see EC Reg. 406/2010 p.52 4.1.1.). The total number of operational cycles shall be 20,000 (duty cycles) for the automatic shut-off valves.

143. Fuel flow shut-off by an automatic shut-off valve mounted on a liquid hydrogen storage container shall be fail safe. The term "fail safe" shall refer to a device's ability to revert to a safe mode or a safe complete shutdown for all reasonable failure modes.

144. The electrical tests for the automatic shut-off valve mounted on the liquid hydrogen storage containers provide assurance of performance with: (i) over temperature caused by an overvoltage condition, and (ii) potential failure of the insulation between the component's power conductor and the component casing.

### 3. Rationale for vehicle fuel system design qualification requirements (LH2)

145. This section specifies requirements for the integrity of the hydrogen fuel delivery system, which includes the liquid hydrogen storage system, piping, joints, and components in which hydrogen is present. These requirements are in addition to requirements specified in paragraph 5.2., all of which apply to vehicles with liquid hydrogen storage systems with the exception of paragraph 2.1.1. The fuelling receptacle label shall designate liquid hydrogen as the fuel type. Test procedures are given in paragraph 7.5.

### 4. Rationale for test procedures for LHSSs

146. Rationale for test procedures is included within rationale for performance requirements in sections G2(a) and G2(b) of the preamble.

### 5. Rationale for paragraph 7.5. (Test procedure for post-crash concentration measurement for vehicles with liquefied hydrogen storage systems (LHSSs))

147. As with vehicles with compressed storage systems, direct measurement of hydrogen or the corresponding depression in oxygen content is possible.

148. In the case where liquefied nitrogen is used for the crash, the concentration of helium in the passenger, luggage, and cargo compartments may be measured during the helium leak test which is conducted after the crash. It is possible to establish a helium concentration criteria which is equivalent to 4 per cent hydrogen concentration by volume, but the relationship needs to be adjusted for the difference in temperature of the gas between the operating LHSS and the temperature during the helium leak test in addition to accounting for differences in physical properties. The liquefied hydrogen is stored (and will leak) at cryogenic storage temperatures (-253°C or 20K), but the system is approximately room temperature (20°C or 293K) for the leak test. In this case, the equations given in section F1(a) may be used to express the ratio of helium and hydrogen mass flows is as:

$$W_{\text{He}}/W_{\text{H}_2} = C_{\text{He}}/C_{\text{H}_2} \times (M_{\text{He}}/M_{\text{H}_2})^{1/2} \times (T_{\text{H}_2}/T_{\text{He}})^{1/2}$$

and the ratio of helium and hydrogen volumetric flows as:

$$V_{\text{He}}/V_{\text{H}_2} = C_{\text{He}}/C_{\text{H}_2} \times (M_{\text{H}_2}/M_{\text{He}})^{1/2} \times (T_{\text{He}}/T_{\text{H}_2})^{1/2}$$

where terms are as defined in A 5.2.1.1. Applying the volumetric flow ratio as defined above to account for a system that operates at cryogenic storage conditions but is leak tested at room temperature to the requirement that there be no greater than 4 per cent by volume of hydrogen in the actual vehicle, yields a value of approximately 0.8 per cent by volume of helium as the allowable value for the LHSS post-crash test based on the leakage of gas from the LHSS.

#### (a) Rationale for paragraph 7.5.1. post-crash leak test – liquefied hydrogen storage systems (LHSSs)

149. The purpose of the test is to confirm that the leakage from vehicles with LHSSs following the crash test. During the crash test, the LHSS is filled with either liquefied hydrogen (LH2) to the maximum quantity or liquefied nitrogen (LN2) to the equivalence of the maximum fill level of hydrogen by weight (which is about 8 per cent of the maximum liquefied hydrogen volume in the LHSS) depending which fluid is planned for the crash test. The LN2 fill of about 8 per cent is required to simulate the fuel weight for the crash test, and slightly more liquefied nitrogen is added to accommodate system cooling and venting prior to the test. Visual detection of unacceptable post-crash leakage as defined in paragraph 7.5.1.1 may be feasible if the LHSS can be visually inspected after the crash. When using standard leak-test fluid, the bubble size is expected to be approximately

1.5 mm in diameter. For a localized rate of 0.005 mg/sec (216 Nml/hr), the resultant allowable rate of bubble generation is about 2030 bubbles per minute. Even if much larger bubbles are formed, the leak should be readily detectable. For example, the allowable bubble rate for 6 mm bubbles would be approximately 32 bubbles per minute, thus producing a very conservative criteria if all the joints and vulnerable parts are accessible for post-crash inspection.

150. If the bubble test is not possible or desired, an overall leakage test may be conducted to produce a more objective result. In this case, the leakage criteria is the same as that developed for vehicles with compressed hydrogen storage systems. Specifically, the allowable hydrogen leakage from the LHSS is 118 NL/min or 10.7 g/min. The state of flow leaking from the LHSS may be gaseous, liquid, or a two-phase mixture of both. The leakage is expected to be in the gaseous state as the piping and shutoff valves downstream of the container are more vulnerable to crash damage than the highly insulated, double-walled LHSS container. None-the-less, the post-crash tests prescribed in this document can detect very small leak sites and thus demonstrate the acceptability even if the leakage in the liquid state. It is not necessary to address the possibility of a two-phase leak as the flow rate will be less than that what can occur in the liquid state.

151. The post-crash leak test in paragraph 7.5.1.2.1. is conducted with pressurized helium. Conduct of this test not only confirms that LHSS leakage is acceptable but also allows the post-crash helium concentration test as described in paras. 113 to 115 section F1(b) of the preamble to be performed at the same time. The helium leak test is conducted at room temperature with the LHSS pressurized with helium to normal operating pressure. The pressure level should be below the activation pressure of the pressure regulators and the PRDs. It is expected that the helium test pressure can be conducted at approximately 80 per cent of the Maximum Allowable Working Pressure (MAWP).

Leakage of hydrogen in the liquid state of an operating system is given by:

$$W_1 = C_d \times A \times (2 \times \rho_1 \times \Delta P_1)^{1/2} \quad \text{Equation A.7.5.1-1}$$

where  $W_1$  is the mass flow,  $C_d$  is the discharge coefficient,  $A$  is the area of the hole,  $\rho$  is the density, and  $\Delta P_1$  is the pressure drop between the operating system and atmosphere. This equation is for incompressible fluids such as fluids in the liquid state. Use of this equation is very conservative for this situation as a portion of the fluid often flashes (that is, changes to a gaseous state) as the fluid passes through the leakage hole, causing a reduction in density and therefore a reduction in the mass flow.

The leakage of helium gas during the leak test is given by:

$$W_{He} = C \times C_d \times A \times (\rho_{He} \times P_{He})^{1/2} \quad \text{Equation A.7.5.1-2}$$

where  $C_d$  and  $A$  are as defined above,  $\rho$  and  $P$  are the upstream (stagnation) fluid density and pressure in the LHSS.  $C$  is given by:

$$C = \gamma / (\gamma + 1)^{(\gamma+1)/(\gamma-1)} \quad \text{Equation A.7.5.1-3}$$

where  $\gamma$  is the ratio of specific heats for the helium gas that is leaking.

Since  $C_d$  and  $A$  are constants with the same values for both liquid hydrogen leaking from the operating LHSS and helium gas during the leak test, the ratio of helium to liquid hydrogen leakage can be calculated by

$$W_{He} / W_1 = C_{He} \times (\rho_{He} / \rho_1)^{1/2} \times (P_{He} / (2 \times \Delta P_1))^{1/2} \quad \text{Equation A.7.5.1-4}$$

based on combining *Equations A.7.5.1-1 and A.7.5.1-2*. *Equation A.7.5.1-4* can be used to calculate the helium mass flow at the beginning of the pressure test, but the

pressure will fall during the pressure test where as the pressure of the operating LHSS will remain approximately constant until all the liquid has been vented.

152. In order to accurately determine the allowable reduction in pressure during the leak test, the change in helium flow with pressure needs to be accounted for. Since the density of helium ( $\rho_{\text{He}}$ ) varies with pressure, the mass flow of helium during the pressure test will also vary linearly with pressure as given by:

$$W_t = P_t \times (W_{\text{He}} / P_{\text{He}}) \quad \text{Equation A.7.5.1-5}$$

where  $W_t$  and  $P_t$  are the helium mass flow and pressure during the pressure test and  $W_{\text{He}}$  and  $P_{\text{He}}$  are the initial values of leak test.

Starting with the ideal gas law,

$$P_t V = M_t \times R_g \times T \quad \text{Equation A.7.5.1-6}$$

where  $P_t$  is the test pressure,  $V$  is the volume of the LHSS,  $M_t$  is mass of the LHSS,  $R_g$  is the helium gas constant on a mass basis, and  $T$  is the temperature of the LHSS. Differentiating *Equation 6* with time leads to

$$\partial P_t / \partial t = R_g \times T / V \times \partial M_t / \partial t \quad \text{Equation A.7.5.1-7}$$

where  $\partial P_t / \partial t$  is the change in pressure during the helium pressure test. Since the change in mass within the LHSS ( $\partial M_t / \partial t$ ) is equal to the helium mass flow during the test period ( $W_t$ ), *Equation 5* for  $W_t$  can be substituted into *Equation 7*. After re-arranging terms, the equation becomes

$$\partial P_t / P_t = R_g \times T / V \times (W_{\text{He}} / P_{\text{He}}) \times \partial t = (W_{\text{He}} / M_{\text{He}}) \times \partial t \quad \text{Equation A.7.5.1-8}$$

where  $M_{\text{He}}$  is the initial mass of helium in the LHSS for the pressure test.

Integrating the above differential equation results in expressions for the allowable pressure at the end of the helium leak test and the corresponding allowable pressure loss over the test period. The expressions are:

$$P_{\text{allowable}} = P_{\text{He}} \times \exp(-W_{\text{He}} / M_{\text{He}} \times t_{\text{period}}) \quad \text{Equation A.7.5.1-9}$$

and

$$\Delta P_{\text{allowable}} = P_{\text{He}} \times (1 - \exp(-W_{\text{He}} / M_{\text{He}} \times t_{\text{period}})) \quad \text{Equation A.7.5.1-10}$$

where  $t_{\text{period}}$  is the period of the test.

153. Use of the above equations can be best illustrated by providing an example for a typical passenger vehicle with a 100 litre (L) volume LHSS. Per ground rule, the basic safety parameters are established to be the same as that for the compressed hydrogen storage System. Specifically, the period of the leak test is 60 minutes and the average  $\text{H}_2$  leakage shall be equivalent to 10.7 g/min. Using these parameters for the example yields the following:

Post-crash test period ( $t_{\text{period}}$ ) = 60 minutes

Allowable Liquid  $\text{H}_2$  Leakage ( $W_l$ ) = 10.7 g/min = 118 NL/min of gas after flashing

Maximum Allowable Working Pressure (MAWP) = 6 atm (gauge) = 7 atm (absolute)

Selected Helium Test Pressure ( $P_{\text{He}}$ ) below Pressure Regulator Setpoints = 5.8 atm (absolute)

Ratio of specific heat ( $k$ ) for helium = 1.66

$C$  for helium = 0.725 from *Equation A.7.5.1-3*

Helium Density at Initial Test Pressure = 0.956 g/L  
 Density of Liquified Hydrogen = 71.0 g/L  
 Liquid Hydrogen Leakage Pressure Drop ( $\Delta P_1$ ) = 5.8 atm – 1 atm = 4.8 atm  
 Mass Ratio of Helium to Liquid H<sub>2</sub> Leakage ( $W_{He} / W_l$ ) = 0.0654  
 Allowable Initial Helium Leakage ( $W_{He}$ ) = 0.70 g/min = 3.92 NL/min  
 Initial Mass of Helium in the LHSS for the test ( $M_{He}$ ) = 95.6 g from *Equation A.7.5.1-6*  
 Allowable Reduction in Helium Pressure ( $\Delta P_{allowable}$ ) = 2.06 atm from *Equation A.7.5.1-10*

154. The above example illustrates how the equations can be used to determine the reduction in helium pressure over the 60 minutes test period for the leak test. The calculations were repeated over the likely range of container volume (from 50L to 500L) and typical container pressure ratings (from 6 atm to 9atm gauge) in order to understand the sensitivity of the allowable pressure drop to key parameters. See Figure 5. Since the allowable pressure drop are above 0.5 atm (typically substantially above 0.5 atm) for all likely container sizes, it was decided to adopt a simple criterion of 0.5 atm for all containers with a storage capacity greater than 200 litres in order to simplify the execution of the leak test and the determination of criteria for the passing the test. Similarly, a criterion of 2 atm was adopted for containers less than or equal to 100 litres, and a criterion of 1 atm for containers greater than 100 litres and less than or equal to 200 litres.

Figure 5.  
**Allowable pressure loss during the LHSS leak test**

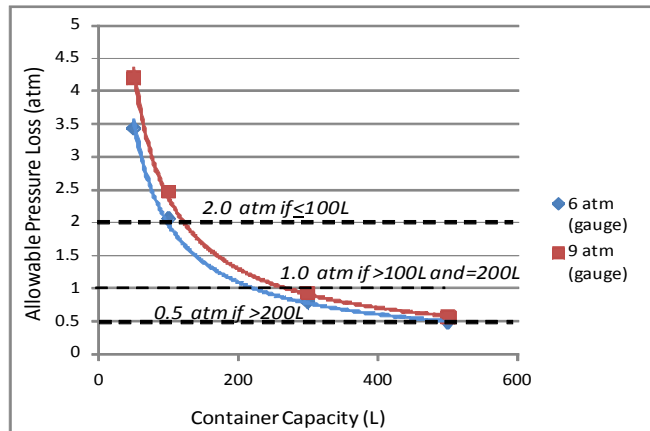

155. While the methodology results in straight-forward test method with an objective result from a commonly-used type of test, it should be noted that the criterion is very conservative in that the methodology assumes liquid leakage rather than the more likely gaseous leakage from the piping and valves downstream of the LHSS container. For example, the ratio of hydrogen gas leakage can be determined using *Equation A.7.5.1-2* and the resulting ratio of allowable helium gas leakage to hydrogen gas leakage is a factor of 5.14 higher than that calculated assuming liquefied hydrogen leaks.

## H. National provisions for material compatibility (including hydrogen embrittlement) and Conformity of Production

### 1. Material compatibility and hydrogen embrittlement

156. The SGS subgroup recognized the importance of requirements for material compatibility and hydrogen embrittlement and started the work in these items. Compliance with material qualification requirements ensures that manufacturers consistently use materials that are appropriately qualified for hydrogen storage service and that meet the design specifications of the manufacturers. However, due to time constraint and other policy and technical issues, agreement was not reached during Phase 1. Therefore, the SGS working group recommended that Contracting Parties continue using their national provisions on material compatibility and hydrogen embrittlement and recommended that requirements for these topics be deferred to Phase 2 of the gtr activity.

### 2. National requirements complimentary to gtr requirements

157. The qualification performance requirements (paragraph 5.) provide qualification requirements for on-road service for hydrogen storage systems. The goal of harmonization of requirements as embodied in the United Nations Global Technical Regulations provides the opportunity to develop vehicles that can be deployed throughout Contracting Parties to achieve uniformity of compliance, and thereby, deployment globally. Therefore, Type Approval requirements are not expected beyond requirements that address conformity of production and associated verification of material properties (including requirements for material acceptability with respect to hydrogen embrittlement).

## I. Topics for the next phase in developing the gtr for hydrogen-fuelled vehicles

158. Since hydrogen fuelled vehicles and fuel cell technologies are in early stages of development of commercial deployment, it is expected that revisions to these requirements may be suggested by an extended time of on-road experience and technical evaluations. It is further expected that with additional experience or additional time for fuller technical consideration, the requirements presented as optional requirements in this document (LHSS Section G of the preamble) s could be adopted as requirements with appropriate modifications.

Focus topics for Phase 2 are expected to include:

- (a) Potential scope revision to address additional vehicle classes
- (b) Potential harmonization of crash test specifications
- (c) Requirements for material compatibility and hydrogen embrittlement
- (d) Requirements for the fuelling receptacle
- (e) Evaluation of performance-based test for long-term stress rupture proposed in Phase 1
- (f) Consideration of research results reported after completion of Phase 1 – specifically research related to electrical safety, hydrogen storage systems, and post-crash safety
- (g) Consideration of 200 per cent NWP or lower as the minimum burst requirement**

**(h) Consider Safety guard system for the case of isolation resistance breakdown**

**1. The following test procedure will be considered for long-term stress rupture:**

(a) Three containers made from the new material (e.g. a composite fibre reinforced polymer) shall be burst; the burst pressures shall be within  $\pm 10$  per cent of the midpoint,  $BP_o$ , of the intended application. Then,

(i) Three containers shall be held at  $> 80$  per cent  $BP_o$  and at  $65 (\pm 5) ^\circ\text{C}$ ; they shall not rupture within 100 hrs; the time to rupture shall be recorded.

(ii) Three containers shall be held at  $> 75$  per cent  $BP_o$  and at  $65 (\pm 5) ^\circ\text{C}$ ; they shall not rupture within 1000hrs; the time to rupture shall be recorded.

(iii) Three containers shall be held at  $> 70$  per cent  $BP_o$  and at  $65 (\pm 5) ^\circ\text{C}$ ; they shall not rupture within one year.

(iv) The test shall be discontinued after one year. Each container that has not ruptured within the one year test period undergoes a burst test, and the burst pressure is recorded.

(b) The container diameter shall be  $> 50$  per cent of the diameter of intended application and of comparable construction. The tank may have a filling (to reduce interior volume) if  $> 99$  per cent of the interior surface area remains exposed.

(c) Containers constructed of carbon fibre composites and/or metal alloys are excused from this test.

(d) Containers constructed of glass fibre composites that have an initial burst pressure  $> 330$  per cent NWP are excused from this test, in which case  $BP_{min} = 330$  per cent NWP shall be applied in paragraph 5.1.1.1. (Baseline Initial Burst Pressure).

(e) There are carbon fibre containers that use glass fibre as the protective layer, and some of these containers contribute about 2 per cent of rise in burst pressure. In this case, it shall be demonstrated, by calculation, etc., that the pressure double the maximum filling pressure or above can be ensured by carbon fibre excluding glass fibre. If it can be demonstrated that the rise in burst pressure due to the glass fibre protective layer is 2 per cent or below and if the burst pressure is  $2.00 \text{ NWP} \times 1.02 = 2.04 \text{ NWP}$  or more, the said calculation may be omitted.

(f) Introduction of glass fibre containers that have an initial burst pressure of 330 per cent NWP is to be optional for each Contracting Party.

**J. Existing Regulations, Directives, and International Standards**

**1. Vehicle fuel system integrity**

*(a) National regulations and directives*

(a) European Union – Regulation 79/2009 – Type-approval of hydrogen-powered motor vehicles

(b) European Union – Regulation 406/2010 — implementing EC Regulation 79/2009

(c) Japan — Safety Regulation Article 17 and Attachment 17 – Technical Standard for Fuel Leakage in Collision

(d) Japan — Attachment 100 – Technical Standard For Fuel Systems Of Motor Vehicle Fueled By Compressed Hydrogen Gas



- (e) Canada — Motor Vehicle Safety Standard (CMVSS) 301.1 – Fuel System Integrity
- (f) Canada — Motor Vehicle Safety Standard (CMVSS) 301.2 – CNG Vehicles
- (g) Korea — Motor Vehicle Safety Standard, Article 91 – Fuel System Integrity
- (h) United States — Federal Motor Vehicle Safety Standard (FMVSS) No. 301 - Fuel System Integrity.
- (i) United States — FMVSS No. 303 – CNG Vehicles
- (j) **China – GB/T 24548-2009 Fuel cell electric vehicles – terminology**
- (k) **China -- GB/T 24549-2009 Fuel cell electric vehicles - safety requirements**
- (l) **China -- GB/T 24554-2009 Fuel cell engine - performance - test methods**

(b) *National and International standards.*

- (a) ISO 17268 — Compressed hydrogen surface vehicle refuelling connection devices
- (b) ISO 23273-1 — Fuel cell road vehicles — Safety specifications — Part 1: Vehicle functional safety
- (c) ISO 23273-2 — Fuel cell road vehicles — Safety specifications — Part 2: Protection against hydrogen hazards for vehicles fuelled with compressed hydrogen
- (d) ISO 14687-2 — Hydrogen Fuel — Product Specification — Part 2: Proton exchange membrane (PEM) fuel cell applications for road vehicles
- (e) SAE J2578 — General Fuel Cell Vehicle Safety
- (f) SAE J2600 – Compressed Hydrogen Surface Vehicle Fueling Connection Devices
- (g) SAE J2601 – Fueling Protocols for Light Duty Gaseous Hydrogen Surface Vehicles
- (h) SAE J2799 – Hydrogen Quality Guideline for Fuel Cell Vehicles

## 2. Storage system

(a) *National regulations and directives:*

- (a) China — Regulation on Safety Supervision for Special Equipment
- (b) China — Regulation on Safety Supervision for Gas Cylinder
- (c) Japan — JARI S001(2004) Technical Standard for Containers of Compressed Hydrogen Vehicle Fuel Devices
- (d) Japan — JARI S002(2004) Technical Standard for Components of Compressed Hydrogen Vehicle Fuel Devices
- (e) Japan — KHK 0128(2010) Technical Standard for Compressed Hydrogen Vehicle Fuel Containers with Maximum Filling Pressure up to 70MPa
- (f) Korea — High Pressure Gas Safety Control Law
- (g) United States — FMVSS 304 - Compressed Natural Gas fuel Container Integrity
- (h) European Union — Regulation 406/2010 implementing EC Regulation 79/2009
- (i) **China — QC/T 816-2209 Hydrogen supplying and refueling vehicles - specifications**

(b) *National and International standards:*

- (a) CSA B51 Part 2 — High-pressure cylinders for the on-board storage of natural gas and hydrogen as fuels for automotive vehicles
- (b) CSA NGV2-2000 – Basic Requirements for Compressed Natural Gas Vehicle (NGV) Fuel Containers
- (c) CSA TPRD-1-2009 – Pressure Relief Devices For Compressed Hydrogen Vehicle Fuel Containers
- (d) CSA HGV 3.1-2011 – Fuel System Component for Hydrogen Gas Power Vehicles (Draft)
- (e) ISO 13985:2006 — Liquid Hydrogen – Land Vehicle Fuel Tanks
- (f) ISO 15869:2009 — Gaseous Hydrogen and Hydrogen Blends – Land Vehicle Fuel Tanks (Technical Specification)
- (g) SAE J2579 — Fuel Systems in Fuel Cell and Other Hydrogen Vehicles

**3. Electric safety**

(a) *National regulations and directives:*

- (a) Canada — CMVSS 305—Electric Powered Vehicles: Electrolyte Spillage and Electrical Shock Protection
- (b) ECE — Regulation 100 - Uniform Provisions Concerning the Approval of Battery Electric Vehicles with Regard to Specific Requirements for the Construction and Functional Safety
- (c) Japan — Attachment 101 – Technical Standard for Protection of Occupants against High Voltage in Fuel Cell Vehicles
- (d) Japan — Attachment 110 – Technical Standard for Protection of Occupants against High Voltage in Electric Vehicles and Hybrid Electric Vehicles
- (e) Japan — Attachment 111 – Technical Standard for Protection of Occupants against High Voltage after Collision in Electric Vehicles and Hybrid Electric Vehicles
- ~~(f) China — GB/T 24548-2009 Fuel cell electric vehicles — terminology~~
- ~~(g) China — GB/T 24549-2009 Fuel cell electric vehicles — safety requirements~~
- ~~(h) China — GB/T 24554-2009 Fuel cell engine — performance — test methods~~
- (i) Korea — Motor Vehicle Safety Standard, Article 18-2 – High Voltage System
- (j) Korea — Motor Vehicle Safety Standard, Article 91-4 – Electrolyte Spillage and Electric Shock Protection
- ~~(k) China — QC/T 816-2209 Hydrogen supplying and refueling vehicles — specifications~~
- (l) United States — FMVSS 305 - Electric-Powered Vehicles: Electrolyte Spillage and Electrical Shock Protection

(b) *National and International Industry standards:*

- (a) ISO 23273-3 — Fuel cell road vehicles — Safety specifications — Part 3: Protection of persons against electric shock
- (b) SAE J1766 — Electric and Hybrid Electric Vehicle Battery Systems Crash Integrity Testing

(c) SAE J2578 — General Fuel Cell Vehicle Safety

## K. Benefits and Costs

159. At this time, the gtr does not attempt to quantify costs and benefits for this first stage. While the goal of the gtr is to enable increased market penetration of HFCVs, the resulting rates and degrees of penetration are not currently known or estimatable. Therefore, a quantitative cost-benefit analysis was not possible.

160. Some costs are anticipated from greater market penetration of HFCVs. For example, building the infrastructure required to make HFCVs a viable alternative to conventional vehicles will entail significant investment costs for the private and public sectors, depending on the country. Especially in the early years of HFCV sales, individual purchasers of HFCVs are also likely to face greater costs than purchasers of conventional gasoline or diesel vehicles, the same goes for manufacturers of new HFCVs (However, costs incurred by HFCV purchasers and manufacturers would essentially be voluntary, as market choice would not be affected).

161. While some costs are expected, the contracting parties believe that the benefits of gtr are likely to greatly outweigh costs. Widespread use of HFCVs, with the establishment of the necessary infrastructure for fuelling, is anticipated to reduce the number of gasoline and diesel vehicles on the road, which should reduce worldwide consumption of fossil fuels.<sup>1</sup> Perhaps most notably, the reduction in greenhouse gas and criteria pollutant emissions (such as NO<sub>2</sub>, SO<sub>2</sub>, and particulate matter) associated with the widespread use of HFCVs is anticipated to result in significant societal benefits over time by alleviating climate change and health impact costs. The gtr may also lead to decreases in fuelling costs for the operators of HFCVs, as hydrogen production is potentially unlimited and expected to become more cost-effective than petroleum production for conventional vehicles.<sup>2</sup> Furthermore, decreased demand for petroleum is likely to lead to energy and national security benefits for those countries with widespread HFCV use, as reliance on foreign oil supplies decreases.<sup>3</sup> Additionally, although not attributable to this gtr, the gtr may create benefits in terms of facilitating OEM compliance with applicable fuel economy and greenhouse gas emission standards by promoting a wider production and use of HFCVs.

162. The contracting parties have also not been able to estimate net employment impacts of the gtr. The new market for innovative design and technologies associated with HFCVs may create significant employment benefits for those countries with ties to HFCV production. On the other hand, employment losses associated with the lower production of conventional vehicles could offset those gains. The building and retrofitting of infrastructure needed to support hydrogen production and storage is likely to generate net additions to the job market in the foreseeable future.

---

<sup>1</sup> Potential renewable sources of hydrogen include electrolysis, high-temperature water splitting, thermochemical conversion of biomass, photolytic and fermentative micro-organism systems and photo-electrical systems. See <http://www.hydrogen.energy.gov/production.html> (last accessed August 24, 2011).

<sup>2</sup> [...]

<sup>3</sup> The renewable sources of hydrogen described in Footnote [1] are all capable of domestic production. Natural gas, nuclear energy, and coal may be other domestic sources. Available from [www.hydrogen.energy.gov/production.html](http://www.hydrogen.energy.gov/production.html) (last accessed August 24, 2011).

## B. Text of Regulation

### 1. Purpose

This regulation specifies safety-related performance requirements for hydrogen-fuelled vehicles. The purpose of this regulation is to minimize human harm that may occur as a result of fire, burst or explosion related to the vehicle fuel system and/or from electric shock caused by the vehicle's high voltage system.

### 2. Scope

This regulation applies to all hydrogen fuelled vehicles of Category 1-1 and 1-2, with a gross vehicle mass (GVM) of 4,536 **[4,500]** kilograms or less, **excluding vehicles that use blended hydrogen fuel.**

**[optional: restrict the scope to only carbon fiber wrapped container]**

### 3. Definitions

#### **Possible definition needed for blended hydrogen fuel**

For the purpose of this regulation, the following definitions shall apply:

- 3.1. "*Active driving possible mode*" is the vehicle mode when application of pressure to the accelerator pedal (or activation of an equivalent control) or release of the brake system causes the electric power train to move the vehicle.
- 3.2. "*Automatic disconnect*" is a device that, when triggered, conductively separates the electrical energy sources from the rest of the high voltage circuit of the electrical power train.
- 3.3. "*Burst-disc*" is the non-reclosing operating part of a pressure relief device which, when installed in the device, is designed to burst at a predetermined pressure to permit the discharge of compressed hydrogen.
- 3.4. "*Check valve*" is a non-return valve that prevents reverse flow in the vehicle fuel line.
- 3.5. "*Concentration of hydrogen*" is the percentage of the hydrogen moles (or molecules) within the mixture of hydrogen and air (Equivalent to the partial volume of hydrogen gas).
- 3.6. "*Container*" (for hydrogen storage) is the component within the hydrogen storage system that stores the primary volume of hydrogen fuel.
- 3.7. "*Conductive connection*" is the connection using contactors to an external power supply when the rechargeable energy storage system (RESS) is charged.
- 3.8. "*Coupling system*" for charging the rechargeable energy storage system (RESS) is the electrical circuit used for charging the RESS from an external electric power supply including the vehicle inlet.

- 3.9. "*Date of removal from service*" is the date (month and year) specified for removal from service.
- 3.10. "*Date of manufacture*" (of a compressed hydrogen container) is the date (month and year) of the proof pressure test carried out during manufacture.
- 3.11. "*Direct contact*" indicates the contact of persons with high voltage live parts.
- 3.12. "*Enclosed or semi-enclosed spaces*" indicates the special volumes within the vehicle (or the vehicle outline across openings) that are external to the hydrogen system (storage system, fuel cell system and fuel flow management system) and its housings (if any) where hydrogen may accumulate (and thereby pose a hazard), as it may occur in the passenger compartment, luggage compartment, cargo compartment and space under the hood.
- 3.13. "*Enclosure*" is the part enclosing the internal units and providing protection against any direct contact.
- 3.14. "*Electric energy conversion system*" is a system (e.g. fuel cell) that generates and provides electrical power for vehicle propulsion.
- 3.15. "*Electric power train*" is the electrical circuit which may include the traction motor(s), and may also include the RESS, the electrical power conversion system, the electronic converters, the traction motors, the associated wiring harness and connectors and the coupling system for charging the RESS.
- 3.16. "*Electrical chassis*" is a set of conductive parts electrically linked together, whose electrical potential is taken as reference.
- 3.17. "*Electrical circuit*" is an assembly of connected high voltage live parts that is designed to be electrically energized in normal operation.
- 3.18. "*Electrical isolation*" is the electrical resistance between a vehicle high voltage bus source and any vehicle conductive structure.
- 3.19. "*Electrical protection barrier*" is the part providing protection against direct contact with live parts from any direction of access.
- 3.20. "*Electronic converter*" is a device capable of controlling and/or converting electric power for propulsion.
- 3.21. "*Exhaust point of discharge*" is the geometric centre of the area where fuel cell purged gas is discharged from the vehicle.
- 3.22. "*Exposed conductive part*" is the conductive part that can be touched under the provisions of the IPXXB protection degree and becomes electrically energized under isolation failure conditions. This includes parts under a cover that can be removed without using tools.
- 3.23. "*External electric power supply*" is an alternating current (AC) or direct current (DC) that provides electric power outside of the vehicle.
- 3.24. "*Fuel cell system*" is a system containing the fuel cell stack(s), air processing system, fuel flow control system, exhaust system, thermal management system and water management system.
- 3.25. "*Fuelling receptacle*" is the equipment to which a fuelling station nozzle attaches to the vehicle and through which fuel is transferred to the vehicle. The fuelling receptacle is used as an alternative to a fuelling port.
- 3.26. "*High voltage*" is the classification of an electric component or circuit, if its maximum working voltage is greater than 60 V and less than or equal to 1500

- V of direct current (DC), or greater than 30 V and less than or equal to 1000 V of alternating current (AC).
- 3.27. "*High Voltage Bus*" is the electrical circuit, including the coupling system, for charging the RESS that operates on high voltage.
- 3.28. "*Hydrogen-fuelled vehicle*" indicates any motor vehicle that uses compressed gaseous or liquefied hydrogen as a fuel to propel the vehicle, including fuel cell and internal combustion engine vehicles.
- 3.29. "*Hydrogen storage system*" indicates a pressurized container, pressure relief devices (PRDs) and shut off device that isolate the stored hydrogen from the remainder of the fuel system and the environment.
- 3.30. "*Indirect contact*" is the contact of persons with exposed conductive parts.
- 3.31. "*Live parts*" is the conductive part intended to be electrically energized in normal use.
- 3.32. "*Luggage compartment*" is the space in the vehicle for luggage accommodation, bounded by the roof, hood, floor, side walls, as well as by the electrical barrier and enclosure provided for protecting the power train from direct contact with live parts, being separated from the passenger compartment by the front bulkhead or the rear bulkhead.
- 3.33. "*Liquefied hydrogen storage system*" indicates liquefied hydrogen storage container(s) pressure relief devices (PRDs), shut off device, a boil-off system and the interconnection piping (if any) and fittings between the above components.
- 3.34. "*Lower flammability limit (LFL)*" is the lowest concentration of fuel at which a gaseous fuel mixture is flammable at normal temperature and pressure. The lower flammability limit for hydrogen gas in air is 4 per cent by volume (para. 82 of the *Preamble*).
- 3.35. "*Maximum allowable working pressure (MAWP)*" is the highest gauge pressure to which a pressure container or storage system is permitted to operate under normal operating conditions.
- 3.36. "*Maximum fuelling pressure (MFP)*" is the maximum pressure applied to compressed system during fuelling. The maximum fuelling pressure is 125 per cent of the Nominal Working Pressure.
- 3.37. "*Nominal working pressure (NWP)*" is the gauge pressure that characterizes typical operation of a system. For compressed hydrogen gas containers, NWP is the settled pressure of compressed gas in fully fuelled container or storage system at a uniform temperature of 15 °C.
- 3.38. "*On-board isolation resistance monitoring system*" is the device that monitors isolation resistance between the high voltage buses and the electrical chassis.
- 3.39. "*Open type traction battery*" is a type of battery requiring liquid and generating hydrogen gas that is released into the atmosphere.
- 3.40. "*Passenger compartment (for electric safety assessment)*" is the space for occupant accommodation, bounded by the roof, floor, side walls, doors, outside glazing, front bulkhead and rear bulkhead - or rear gate -, as well as by the electrical barriers and enclosures provided for protecting the power train from direct contact with live parts.

- 3.41. "*Pressure relief device (PRD)*" is a device that, when activated under specified performance conditions, is used to release hydrogen from a pressurized system and thereby prevent failure of the system.
- 3.42. "*Pressure relief valve*" is a pressure relief device that opens at a preset pressure level and can re-close.
- 3.43. "*Protection IPXXB*" indicates protection from contact with high voltage live parts provided by either an electrical barrier or an enclosure; it is tested using a Jointed Test Finger (IPXXB), as described in paragraph 6.3.3.
- 3.44. "*Protection IPXXD*" indicates protection from contact with high voltage live parts provided by either an electrical barrier or an enclosure and tested using a Test Wire (IPXXD), as described in paragraph 6.3.3.
- 3.45. "*Rechargeable energy storage system (RESS)*" is the rechargeable energy storage system that provides electric energy for electrical propulsion.
- 3.46. "*Rupture and burst*" both mean to come apart suddenly and violently, break open or fly into pieces due to the force of internal pressure.
- 3.47. "*Service disconnect*" is the device for deactivation of an electrical circuit when conducting checks and services of the RESS, fuel cell stack, etc.
- 3.48. "*Service life*" (of a compressed hydrogen container) indicates the time frame during which service (usage) is authorized.
- 3.49. "*Shut-off valve*" is a valve between the storage container and the vehicle fuel system that can be automatically activated; this valve defaults to "closed" position when not connected to a power source.
- 3.50. "*Single failure*" is a failure caused by a single event, including any consequential failures resulting from this failure.
- 3.51. "*Solid insulator*" is the insulating coating of wiring harnesses provided in order to cover and prevent the high voltage live parts from any direct contact. This includes covers for insulating the high voltage live parts of connectors and varnish or paint for the purpose of insulation.
- 3.52. "*Thermally-activated pressure relief device (TPRD)*" is a non- reclosing PRD that is activated by temperature to open and release hydrogen gas.
- 3.53. "*Type approval*" indicates a certification of a recognised body stating that prototype or pre-production samples of a specific vehicle, vehicle system or vehicle system component meet the relevant specified performance standards, and that the final production versions also comply, as long as conformity of production is confirmed.
- 3.54. "*Vehicle fuel system*" is an assembly of components used to store or supply hydrogen fuel to a fuel cell (FC) or internal combustion engine (ICE).
- 3.55. "*Working voltage*" is the highest value of an electrical circuit voltage root mean square (rms), specified by the manufacturer or determined by measurement, which may occur between any conductive parts in open circuit conditions or under normal operating condition. If the electrical circuit is divided by galvanic isolation, the working voltage is defined for each divided circuit, respectively.

## 4. Applicability of Requirements

- 4.1. The requirements of paragraph 5. (using test conditions and procedures in paragraph 6.) apply to all compressed hydrogen fuelled vehicles.
- 4.2. Each contracting party under the UN 1998 Agreement shall maintain its existing national crash tests (frontal, side, rear and rollover) and use the limit values of section paragraph 5.2.2. for compliance.
- 4.3. The requirements of paragraph 5.3. apply to all hydrogen-fuelled vehicles using high voltage.

## 5. Performance Requirements

- 5.1. Compressed hydrogen storage system

This section specifies the requirements for the integrity of the compressed hydrogen storage system. The hydrogen storage system consists of the high pressure storage container and primary closure devices for openings into the high pressure storage container. Figure 1 shows a typical compressed hydrogen storage system consisting of a pressurized container, three closure devices and their fittings. The closure devices include:

- a thermally-activated pressure relief device (TPRD);
- a check valve that prevents reverse flow to the fill line; and
- an automatic shut-off valve that can close to prevent flow from the container to the fuel cell or ICE engine. Any shut-off valve, and TPRD that form the primary closure of flow from the storage container shall be mounted directly on or within each container. At least one component with a check valve function shall be mounted directly on or within each container.

Figure 1.

### Typical Compressed Hydrogen Storage System

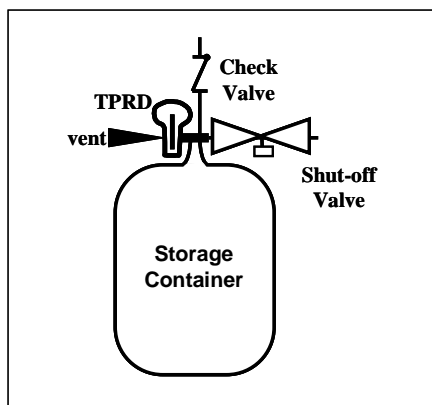

All new compressed hydrogen storage systems produced for on-road vehicle service shall have a NWP of 70 MPa or less and a service life of 15 years or less, and be capable of satisfying the requirements of paragraph 5.1.

The hydrogen storage system shall meet the performance test requirements specified in this paragraph. The qualification requirements for on-road service are:



- 5.1.1. Verification Tests for Baseline Metrics
- 5.1.2. Verification Test for Performance Durability
- 5.1.3. Verification Test for Expected On-Road System Performance
- 5.1.4. Verification Test for Service Terminating System Performance in Fire
- 5.1.5. Verification Test for Durability of Closure Performance

The test elements within these performance requirements are summarized in Table 1. The corresponding test procedures are specified in paragraph 6.

Table 1

## **Overview of Performance Qualification Test Requirements**

---

### **1.1.1. Verification Tests for Baseline Performance Metrics**

*1.1.1.1. Baseline Initial Burst Pressure*

*1.1.1.2. Baseline Initial Pressure Cycle Life*

---

### **1.1.2. Verification Test for Performance Durability (sequential hydraulic tests)**

1.1.2.1. Proof Pressure Test

1.1.2.2. Drop (Impact) Test

1.1.2.3. Surface damage

1.1.2.4. Chemical Exposure and Ambient Temperature Pressure Cycling Tests

1.1.2.5. High Temperature Static Pressure Test

1.1.2.6. Extreme Temperature Pressure Cycling

1.1.2.7. Residual Proof Pressure Test

1.1.2.8. Residual Strength Burst Test

### **1.1.3. Verification Test for Expected On-road Performance (sequential pneumatic tests)**

1.1.3.1. Proof Pressure Test

1.1.3.2. Ambient and Extreme Temperature Gas Pressure Cycling Test (pneumatic)

1.1.3.3. Extreme Temperature Static Gas Pressure Leak/Permeation Test (pneumatic)

1.1.3.4. Residual Proof Pressure Test

1.1.3.5. Residual Strength Burst Test (Hydraulic)

### **1.1.4. Verification Test for Service Terminating Performance in Fire**

### **1.1.5. Verification Test for Closure Durability**

---

5.1.1. Verification Tests for Baseline Metrics

5.1.1.1. Baseline Initial Burst Pressure

Three (3) new containers randomly selected from the design qualification batch of at least 10 containers, are hydraulically pressurized until burst (para. 6.2.2.1. test procedure). The manufacturer shall supply documentation (measurements and statistical analyses) that establish the midpoint burst pressure of new storage containers, BPO.

All containers tested shall have a burst pressure within  $\pm 10$  per cent of BPO and greater than or equal to a minimum BP<sub>min</sub> of 225 per cent NWP.

**[In addition, [Contracting Parties may require] containers having glass-fiber composite as a primary constituent to have a minimum burst pressure greater than 330 percent NWP.]**

5.1.1.2. Baseline Initial Pressure Cycle Life (PCL)

Three (3) new containers randomly selected from the design qualification batch are hydraulically pressure cycled at 20( $\pm 5$ )°C to 125 per cent NWP without rupture for 22,000 cycles or until a leak occurs (para. 6.2.2.2. test procedure). Leakage shall not occur within a number of Cycles, where the number of Cycles is set individually by each Contracting Party at 5,500, 7,500 or 11,000 cycles for a 15-year service life.

5.1.2. Verification Tests for Performance Durability (Hydraulic sequential tests)

If all three PCL measurements made in para. 5.1.1.2. are greater than 11,000 cycles, or if they are all within  $\pm 25$  per cent of each other, then only one (1) container is tested in para. 5.1.2. Otherwise, three (3) containers are tested in para. 5.1.2.

A hydrogen storage container shall not leak during the following sequence of tests, which are applied in series to a single system and which are illustrated in Figure 2. At least one system randomly selected from the design qualification batch shall be tested to demonstrate the performance capability. Specifics of applicable test procedures for the hydrogen storage system are provided in para. 6.2.3.

Figure 2  
Verification Test for Performance Durability (hydraulic)

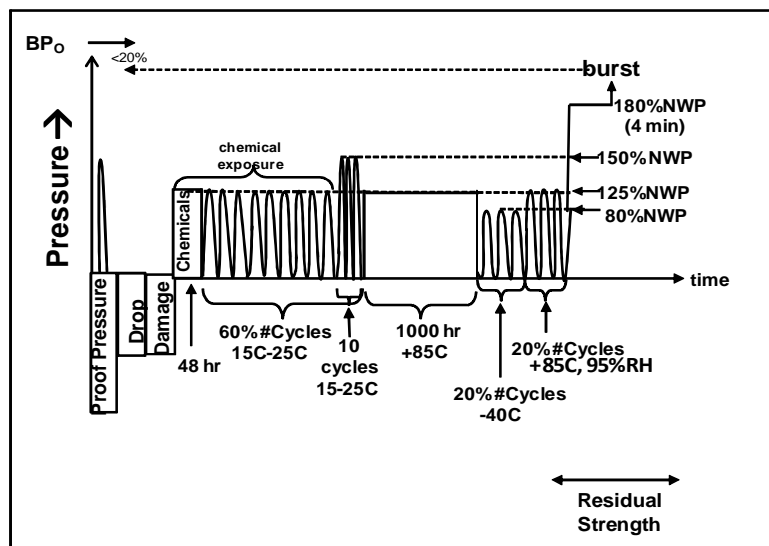

- 5.1.2.1. Proof Pressure Test. A storage container is pressurized to 150 per cent NWP and held for 30 sec (para. 6.2.3.1. test procedure). A storage container that has undergone a proof pressure test in manufacture is exempt from this test.
- 5.1.2.2. Drop (Impact) Test. The storage container is dropped at several impact angles (para. 6.2.3.2. test procedure).
- 5.1.2.3. Surface Damage Test. The storage container is subjected to surface damage (para. 6.2.3.3. test procedure).
- 5.1.2.4. Chemical Exposure and Ambient-Temperature Pressure Cycling Test. The storage container is exposed to chemicals found in the on-road environment and pressure cycled to 125 per cent NWP at 20° ( $\pm 5$ )°C for 60 per cent number of Cycles pressure cycles (para. 6.2.3.4.). Chemical exposure is discontinued before the last 10 cycles, which are conducted to 150 per cent NWP.
- 5.1.2.5. High Temperature Static Pressure Test. The storage container is pressurized to 125 per cent NWP at 85°C for 1,000 hr (para. 6.2.3.5. test procedure).
- 5.1.2.6. Extreme Temperature Pressure Cycling. The storage container is pressure cycled at -40°C to 80 per cent NWP for 20 per cent number of Cycles and at +85°C and 95 per cent relative humidity to 125 per cent NWP for 20 per cent number of Cycles (para. 6.2.2.2.).
- 5.1.2.7. Hydraulic Residual Pressure Test. The storage container is pressurized to 180 per cent NWP and held 4 minutes without burst (para. 6.2.3.1. test procedure).
- 5.1.2.8. Residual Burst Strength Test. The storage container undergoes a hydraulic burst test to verify that the burst pressure is ~~within~~ **at least 80** 20 per cent of the baseline initial burst pressure (**BP<sub>0</sub>**) determined in para. 5.1.1.1. (para. 6.2.2.1. test procedure).
- 5.1.3. Verification Test for Expected On-road Performance (Pneumatic sequential tests)

A hydrogen storage system shall not leak during the following sequence of tests, which are illustrated in Figure 3. Specifics of applicable test procedures for the hydrogen storage system are provided in paragraph 6.

Figure 3.  
**Verification Test for Expected On-Road Performance (pneumatic/hydraulic)**

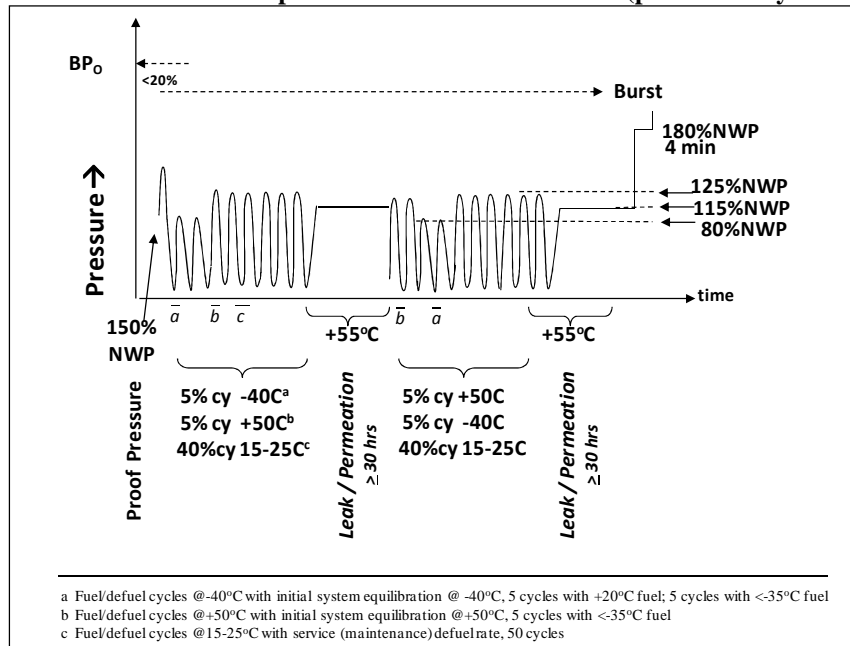

- 5.1.3.1. Proof Pressure Test: A system is pressurized to 150 per cent NWP for 30 seconds (paragraph 6.2.3.1.).
- 5.1.3.2. Ambient and Extreme Temperature Gas Pressure Cycling Test. The system is pressure cycled using hydrogen gas for 500 cycles (paragraph 6.2.4.1. test procedure).
  - (a) The pressure cycles are divided into two groups: Half of the cycles (250) are performed before exposure to static pressure (para. 5.1.3.3.) and the remaining half of the cycles (250) are performed after the initial exposure to static pressure (para. 5.1.3.3.) as illustrated in Figure 3.
  - (b) In each group of pressure cycling, 25 cycles are performed to 125 per cent NWP at +50 °C and 95 per cent relative humidity, then 25 cycles to 80 per cent NWP at -40°C, and the remaining 200 cycles to 125 per cent NWP at 20° (±5) C.
  - (c) The hydrogen gas fuel temperature is -40 °C.
  - (d) During the first group of 250 pressure cycles, five cycles are performed after temperature equilibration of the system at 50°C and 95 per cent relative humidity; five cycles are performed after equilibration at -40 °C; and five cycles are performed with fuel having a temperature of +20(±5)°C after equilibration at - 40 °C.
  - (e) Fifty pressure cycles are performed using a de-fuelling rate greater than or equal to the maintenance de-fuelling rate.
- 5.1.3.3. Extreme Temperature Static Pressure Leak/Permeation Test. The system is held at 115 per cent NWP and 55°C with hydrogen gas until steady-state permeation or 30 hours, whichever is longer (para. 6.2.4.2. test procedure).

- (a) The test is performed after each group of 250 pneumatic pressure cycles in paragraph 5.1.3.2.
- (b) ~~The maximum allowable hydrogen discharge from the compressed hydrogen storage system is  $R \cdot 150 \text{ Nml/min}$  where  $R = (V_{\text{width}} + 1) \cdot (V_{\text{height}} + 0.5) \cdot (V_{\text{length}} + 1) / 30.4 \text{ m}^3$  and  $V_{\text{width}}$ ,  $V_{\text{height}}$  and  $V_{\text{length}}$  are the vehicle width, height and length respectively in metres.~~
- (c) ~~Alternatively,~~ The maximum allowable hydrogen discharge from the compressed hydrogen storage system ~~with a total water capacity of less than 330L~~ is 46 mL/h/L water capacity of the storage system.
- (d) If the measured permeation rate is greater than 0.005 mg/sec (3.6 cc/min), a localized leak test is performed to ensure no point of localized external leakage is greater than 0.005 mg/sec (3.6 cc/min) (para. 6.2.4.3. test procedure).
- 5.1.3.4. Residual Proof Pressure Test (hydraulic). The storage container is pressurized to 180 per cent NWP and held 4 minutes without burst (para. 6.2.3.1. test procedure).
- 5.1.3.5. Residual Strength Burst Test (hydraulic). The storage container undergoes a hydraulic burst to verify that the burst pressure is within 20 per cent of the baseline burst pressure determined in para. 5.1.1.1. (para. 6.2.2.1. test procedure).
- 5.1.4. Verification Test for Service Terminating Performance in Fire
- This section describes the fire test with compressed hydrogen as the test gas. Containers tested with hydrogen gas shall be accepted by all Contracting Parties. However, Contracting Parties under the 1998 Agreement may choose to use compressed air as an alternative test gas for certification of a container for use only within their countries or regions.
- A hydrogen storage system is pressurized to NWP and exposed to fire (para. 6.2.5.1. test procedure). A temperature-activated pressure relief device shall release the contained gases in a controlled manner without rupture.
- 5.1.5. Verification Test for Performance Durability of Primary Closures
- Manufacturers shall maintain records that confirm that closures that isolate the high pressure hydrogen storage system (the TPRD(s), check valve(s) and shut-off valve(s) shown in Figure 1) meet the requirements described in the remainder of this Section.
- The entire storage system does not have to be re-qualified (para. 5.1.) if these closure components (components in Figure 1 excluding the storage container) are exchanged for equivalent closure components having comparable function, fittings, materials, strength and dimensions, and qualified for performance using the same qualification tests as the original components. However, a change in TPRD hardware, its position of installation or venting lines requires re-qualification with fire testing according to para. 5.1.4.
- 5.1.5.1. TPRD Qualification Requirements
- Design qualification testing shall be conducted on finished pressure relief devices which are representative of normal production. The TPRD shall meet the following performance qualification requirements:

- (a) Pressure Cycling Test (para. 6.2.6.1.1.)
- (c) Accelerated Life Test (para. 6.2.6.1.2.)
- (d) Temperature Cycling Test (para. 6.2.6.1.3.)
- (e) Salt Corrosion Resistance Test (para. 6.2.6.1.4.)
- (f) Vehicle Environment Test (para. 6.2.6.1.5.)
- (g) Stress Corrosion Cracking Test (para. 6.2.6.1.6.)
- (h) Drop and Vibration Test (para. 6.2.6.1.7.)
- (i) Leak Test (para. 6.2.6.1.8.)
- (j) Bench Top Activation Test (para. 6.2.6.1.9.)
- (k) Flow Rate Test (para. 6.2.6.1.10.)

5.1.5.2. Check Valve and Automatic Shut-Off Valve Qualification on Requirements

Design qualification testing shall be conducted on finished check valves and shut-off valves which are representative of normal production. The valve units shall meet the following performance qualification requirements:

- (a) Hydrostatic Strength Test (para. 6.2.6.2.1.)
- (b) Leak Test (para. 6.2.6.2.2.)
- (c) Extreme Temperature Pressure Cycling Test (para. 6.2.6.2.3.)
- (d) Salt Corrosion Resistance Test (para. 6.2.6.2.4.)
- (e) Vehicle Environment Test (para. 6.2.6.2.5.)
- (f) Atmospheric Exposure Test (para. 6.2.6.2.6.)
- (g) Electrical Tests (para. 6.2.6.2.7.)
- (h) Vibration Test (para. 6.2.6.2.8.)
- (i) Stress Corrosion Cracking Test (para. 6.2.6.2.9.)
- (j) Pre-Cooled Hydrogen Exposure Test (para. 6.2.6.2.10.)

5.1.6. Labelling

A label shall be permanently affixed on each container with at least the following information: Name of the Manufacturer, Serial Number, Date of Manufacture, NWP, Type of Fuel, and Date of Removal from Service. Each container shall also be marked with the number of cycles used in the testing programme as per para. 5.1.1.2. Any label affixed to the container in compliance with this section shall remain in place and be legible for the duration of the manufacturer's recommended service life for the container.

Date of removal from service shall not be more than 15 years after the date of manufacture.

5.2. Vehicle fuel system

This section specifies requirements for the integrity of the hydrogen fuel delivery system, which includes the hydrogen storage system, piping, joints, and components in which hydrogen is present.

5.2.1. In-Use Fuel System Integrity:

- 5.2.1.1. Fuelling Receptacle Requirements
- 5.2.1.1.1. A compressed hydrogen fuelling receptacle shall prevent reverse flow to the atmosphere. Test procedure is visual inspection.
- 5.2.1.1.2. Fuelling receptacle label A label shall be provided close to the fuelling receptacle; for instance inside a refilling hatch, showing the following information: fuel type, NWP, date of removal from service of containers.
- 5.2.1.1.3. The fuelling receptacle shall be mounted on the vehicle to ensure positive locking of the fuelling nozzle. The receptacle shall be protected from tampering and the ingress of dirt and water (e.g. installed in a compartment which can be locked). Test procedure is by visual inspection.
- 5.2.1.1.4. The fuelling receptacle shall not be mounted within the external energy absorbing elements of the vehicle (e.g. bumper) and shall not be installed in the passenger compartment, luggage compartment and other places where hydrogen gas could accumulate and where ventilation is not sufficient. Test procedure is by visual inspection.
- 5.2.1.2. Over-pressure Protection for the Low Pressure System (test procedure para. 6.1.6.)
- The hydrogen system downstream of a pressure regulator shall be protected against overpressure due to the possible failure of the pressure regulator. The set pressure of the overpressure protection device shall be lower than or equal to the maximum allowable working pressure for the appropriate section of the hydrogen system.
- 5.2.1.3. Hydrogen Discharge Systems
- 5.2.1.3.1. Pressure Relief Systems (test procedure paragraph 6.1.6.)
- (a) **Storage system TPRDs.** The outlet of the vent line, if present, for hydrogen gas discharge from TPRD(s) of the storage system shall be protected by a cap.
- (b) **Storage system TPRDs.** The hydrogen gas discharge from TPRD(s) of the storage system shall not be directed:
- (i) into enclosed or semi-enclosed spaces;
  - (ii) into or towards any vehicle wheel housing;
  - (iii) towards hydrogen gas containers;
  - (iv) forward from the vehicle, or horizontally (parallel to road) from the back or sides of the vehicle.
- [(c) Other pressure relief devices (such as a burst disk) **may be used outside the hydrogen storage system.** The hydrogen gas discharge from other pressure relief devices shall not be directed:
- (i) towards exposed electrical terminals, exposed electrical switches or other ignition sources;
  - (ii) into or towards the vehicle passenger or cargo compartments;
  - (iii) into or towards any vehicle wheel housing;
  - (iv) towards hydrogen gas containers.]
- 5.2.1.3.2. Vehicle Exhaust System

At the vehicle exhaust system's point of discharge, the hydrogen concentration level shall:

- (a) not exceed 4 per cent average by volume during any moving three-second time interval during normal operation including start-up and shutdown;
- (b) and not exceed 8 per cent at any time (para. 6.1.4. test procedure).

5.2.1.4. Protection against Flammable Conditions: Single Failure Conditions

5.2.1.4.1. Hydrogen leakage and/or permeation from the hydrogen storage system shall not directly vent into the passenger, luggage, or cargo compartments, or to any enclosed or semi-enclosed spaces within the vehicle that contains unprotected ignition sources.

5.2.1.4.2. Any single failure downstream of the main hydrogen shut off valve shall not result in **any level of** a hydrogen concentration in the air ~~greater than [2 per cent] by volume~~ anywhere in the passenger compartment according to test procedure para. 6.1.3.2.

5.2.1.4.3. If, during operation, a single failure results in a hydrogen concentration exceeding **2±1.0** per cent by volume in air in the enclosed or semi-enclosed spaces of the vehicle, then a warning shall be provided (para. 5.2.1.6.). If the hydrogen concentration exceeds **3±1.0** per cent by volume in the air in the enclosed or semi-enclosed spaces of the vehicle, the main shutoff valve shall be closed to isolate the storage system. (See test procedure, para. 6.1.3.).

5.2.1.5. Fuel System Leakage

The hydrogen fuelling line and the hydrogen system(s) downstream of the main shut off valve(s) shall not leak. Compliance shall be verified at NWP (para. 6.1.5. test procedure).

5.2.1.6. Tell-tale Signal Warning to Driver

The warning shall be given by a visual signal or display text with the following properties:

- (a) Visible to the driver while in the driver's designated seating position with the driver's seat belt fastened.
- (b) Yellow in colour if the detection system malfunctions and shall be red in compliance with section para. 5.2.1.4.3.
- (c) When illuminated, shall be visible to the driver under both daylight and night time driving conditions.
- (d) Remains illuminated ~~while the cause~~ **when 2±1.0** per cent concentration or detection malfunction) exists and the ignition locking system is in the "On" ("Run") position or the propulsion system is activated.
- (e) ~~Extinguishes at the next propulsion system start cycle only if the cause for alerting the driver has been corrected.~~

5.2.2. Post-crash fuel system integrity

5.2.2.1. Fuel Leakage Limit: the volumetric flow of hydrogen gas leakage shall not exceed an average of 118 NL per minute for 60 minutes after the crash (in para. 6.1.1. test procedures).



- 5.2.2.2. Concentration Limit in Enclosed Spaces: Hydrogen gas leakage shall not result in a hydrogen concentration in the air greater than **3±1.0** per cent] by volume in the passenger, luggage and cargo compartments (para. 6.1.2. test procedures). **The requirement is satisfied if it is confirmed that the shut-off valve of the storage system has closed within 5 seconds of the crash and no leakage from the storage system.**
- 5.2.2.3. Container Displacement. The storage container(s) shall remain attached to the vehicle at a minimum of one attachment point.
- 5.3. Electrical safety
- 5.3.1. Electrical Safety requirements - in-use
- 5.3.1.1. General
- Paragraph 5.3.1. applies to the electric power train of fuel cell vehicles equipped with one or more traction motor(s) operated by electric power and not permanently connected to the grid, as well as their high voltage components and systems which are conductively connected to the high voltage bus of the electric power train.
- 5.3.1.2. Requirements for protection against electric shock
- 5.3.1.2.1. Protection against electric shock
- These electrical safety requirements apply to high voltage buses under conditions where they are not connected to external high voltage power supplies.
- 5.3.1.2.2. Protection against direct contact
- The protection against direct contact with live parts shall comply with paragraphs 5.3.1.2.2.1. and 5.3.1.2.2.2. These protections (solid insulator, electrical protection barrier, enclosure, etc.) shall not be opened, disassembled or removed without the use of tools.
- 5.3.1.2.2.1. For protection of live parts inside the passenger compartment or luggage compartment, the protection degree IPXXD shall be provided.
- 5.3.1.2.2.2. For protection of live parts in areas other than the passenger compartment or luggage compartment, the protection degree IPXXB shall be satisfied.
- 5.3.1.2.2.3. Connectors
- Connectors (including vehicle inlet) are deemed to meet this requirement if:
- they comply with paragraphs 5.3.1.2.2.1. and 5.3.1.2.2.2. when separated without the use of tools or
  - they are located underneath the floor and are provided with a locking mechanism or
  - they are provided with a locking mechanism and other components shall be removed with the use of tools in order to separate the connector or
  - the voltage of the live parts becomes equal or below DC 60V or equal or below AC 30V (rms) within 1 second after the connector is separated

5.3.1.2.2.4. Service disconnect

For a service disconnect which can be opened, disassembled or removed without tools, it is acceptable if protection degree IPXXB is satisfied when it is opened, disassembled or removed without tools.

5.3.1.2.2.5. Marking

5.3.1.2.2.5.1. The symbol shown in Figure 4 shall appear on or near the RESS. The symbol background shall be yellow, the bordering and the arrow shall be black.

Figure 4

**Marking of high voltage equipment**

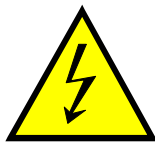

5.3.1.2.2.5.2. The symbol shall be visible on enclosures and electrical protection barriers, which, when removed, expose live parts of high voltage circuits. This provision is optional to any connectors for high voltage buses. This provision shall not apply to any of the following cases

- (a) where electrical protection barriers or enclosures cannot be physically accessed, opened, or removed; unless other vehicle components are removed with the use of tools.
- (b) where electrical protection barriers or enclosures are located underneath the vehicle floor

5.3.1.2.2.5.3. Cables for high voltage buses which are not located within enclosures shall be identified by having an outer covering with the colour orange.

5.3.1.2.3. Protection against indirect contact

5.3.1.2.3.1. ~~Isolation Resistance Monitoring.~~ For protection against electric shock which could arise from indirect contact, the exposed conductive parts, such as the conductive electrical protection barrier and enclosure, shall be conductively connected and secured to the electrical chassis with electrical wire or ground cable, by welding, or by connection using bolts, etc. so that no dangerous potentials are produced.

5.3.1.2.3.2. The resistance between all exposed conductive parts and the electrical chassis shall be lower than 0.1 ohm when there is current flow of at least 0.2 amperes. Demonstrated by using one of the test procedures described in para. 6.3.4.

This requirement is satisfied if the galvanic connection has been established by welding. In case of doubts a measurement shall be made.

5.3.1.2.3.3. In the case of motor vehicles which are connected to the grounded external electric power supply through the conductive connection, a device to enable the conductive connection of the electrical chassis to the earth ground shall be provided. If AC high voltage buses and DC high voltage buses are galvanically connected, isolation resistance between the high voltage bus and the electrical chassis shall have a minimum value of 500 Ω/volt of the working voltage.

The device shall enable connection to the earth ground before exterior voltage is applied to the vehicle and retain the connection until after the exterior voltage is removed from the vehicle.

Compliance to this requirement may be demonstrated either by using the connector specified by the car manufacturer, or by analysis (e.g. visual inspection, drawings etc.).

5.3.1.2.4. Isolation resistance **monitoring system**

- 5.3.1.2.4.1. In fuel cell vehicles, DC high voltage buses shall have an on-board isolation resistance monitoring system together with a warning to the driver if the isolation resistance drops below the minimum required value of 100 ohms/volt. The function of the on-board isolation resistance monitoring system shall be confirmed as described in para. 6.3.2.

The isolation resistance between the high voltage bus of the coupling system for charging the RESS, which is not energized in conditions other than that during the charging of the RESS, and the electrical chassis need not to be monitored.

- 5.3.1.2.4.2. Electric power train consisting of separate Direct Current or Alternating Current buses

If AC high voltage buses and DC high voltage buses are conductively isolated from each other, isolation resistance between the high voltage bus and the electrical chassis shall have a minimum value of 100 ohms/volt of the working voltage for DC buses, and a minimum value of 500 ohms/volt of the working voltage for AC buses.

The measurement shall be conducted according to para. 6.3.1.

[5.3.1.2.4.3. **Electric power train consisting of combined DC- and AC-buses**

**If AC high voltage buses and DC high voltage buses are galvanically connected, isolation resistance between the high voltage bus and the electrical chassis shall have a minimum value of 500  $\Omega$ /volt of the working voltage.**

**However, if all AC high voltage buses are protected by one of the two following measures, isolation resistance between the high voltage bus and the electrical chassis shall have a minimum value of 100 ohms/volt of the working voltage.**

- (a) **double or more layers of solid insulators, electrical protection barriers or enclosures that meet the requirement in paragraph 5.3.1.2.3. independently, for example wiring harness;**
- (b) **mechanically robust protections that have sufficient durability over vehicle service life such as motor housings, electronic converter cases or connectors.]**

- 5.3.1.2.4.4. Isolation resistance requirement for the coupling system for charging the RESS.

For the vehicle inlet intended to be conductively connected to the grounded external AC power supply and the electrical circuit that is conductively connected to the vehicle inlet during charging the RESS, the isolation resistance between the high voltage bus and the electrical chassis shall be at least 1M ohms when the charger coupler is disconnected. During the

measurement, the RESS may be disconnected. The measurement shall be conducted according to para. 6.3.1.

5.3.1.3. Functional safety

At least a momentary indication shall be given to the driver when the vehicle is in "active driving possible mode".

However, this provision does not apply under conditions where an internal combustion engine provides directly or indirectly the vehicle's propulsion power upon start up.

When leaving the vehicle, the driver shall be informed by a signal (e.g. optical or audible signal) if the vehicle is still in the active driving possible mode.

If the on-board RESS can be externally charged, vehicle movement by its own propulsion system shall be impossible as long as the connector of the external electric power supply is physically connected to the vehicle inlet.

This requirement shall be demonstrated by using the connector specified by the car manufacturer.

The state of the drive direction control unit shall be identified to the driver.

5.3.2. Electric safety requirements – post-crash

5.3.2.1. General

Fuel cell vehicles equipped with electric power train shall meet the requirements of paragraphs 5.3.2.2. to 5.3.2.4. This can be met by a separate impact test provided that the electrical components do not influence the occupant protection performance of the vehicle type as defined in the impact regulation. In case of this condition the requirements of paras. 5.3.2.2. to 5.3.2.4. shall be checked in accordance with the methods set out in para. 6.3.5.

5.3.2.2. Protection against electric shock

After the impact at least one of the three criteria specified in paragraphs 5.3.2.2.1. to 5.3.2.2.3. shall be met.

If the vehicle has an automatic disconnect function, or device(s) that conductively divide the electric power train circuit during driving condition, at least one of the following criteria shall apply to the disconnected circuit or to each divided circuit individually after the disconnect function is activated. However criteria defined in para. 5.3.2.2.2. shall not apply if more than a single potential of a part of the high voltage bus is not protected under the conditions of protection IPXXB.

In the case that the test is performed under the condition that part(s) of the high voltage system are not energized, the protection against electric shock shall be proved by either para. 5.3.2.2.2. or para. 5.3.2.2.3. for the relevant part(s).

5.3.2.2.1. Absence of high voltage

The voltages  $V_b$ ,  $V_1$  and  $V_2$  of the high voltage buses shall be equal or less than 30 VAC or 60 VDC within 60 seconds after the impact as specified in para. 6.3.5. and para. 6.3.5.2.2.

5.3.2.2.2. Isolation resistance

The criteria specified in the paragraphs 5.3.2.2.2.1. and 5.3.2.2.2.2. below shall be met.

The measurement shall be conducted in accordance with paragraph 6.3.5.2.3. of paragraph 6.3.5.

5.3.2.2.2.1. Electrical power train consisting of separate DC- and AC-buses

If the AC high voltage buses and the DC high voltage buses are conductively isolated from each other, isolation resistance between the high voltage bus and the electrical chassis ( $R_i$ , as defined in paragraph 6.3.5.2.3. of 6.3.5.) shall have a minimum value of 100  $\Omega$ /volt of the working voltage for DC buses, and a minimum value of 500  $\Omega$ /volt of the working voltage for AC buses.

5.3.2.2.2.2. Electrical power train consisting of combined DC- and AC-buses

If the AC high voltage buses and the DC high voltage buses are conductively connected they shall meet one of the following requirements:

- (a) isolation resistance between the high voltage bus and the electrical chassis ( $R_i$ , as defined in paragraph 6.3.5.2.3. of 6.3.5.) shall have a minimum value of 500  $\Omega$ /volt of the working voltage.
- (b) isolation resistance between the high voltage bus and the electrical chassis ( $R_i$ , as defined in paragraph 6.3.5.2.3. of 6.3.5.) shall have a minimum value of 100  $\Omega$ /volt of the working voltage and the AC bus meets the physical protection as described in para. 5.3.2.2.3.
- (c) isolation resistance between the high voltage bus and the electrical chassis ( $R_i$ , as defined in paragraph 6.3.5.2.3. of 6.3.5.) shall have a minimum value of 100  $\Omega$ /volt of the working voltage and the AC bus meets the absence of high voltage as described in para. 5.3.2.2.1.

**[5.3.2.2.3. Physical protection**

**For protection against direct contact with high voltage live parts, the protection IPXXB shall be provided.**

**In addition, for protection against electric shock which could arise from indirect contact, the resistance between all exposed conductive parts and electrical chassis shall be lower than 0.1 ohm when there is current flow of at least 0.2 amperes.**

**This requirement is satisfied if the galvanic connection has been established by welding. In case of doubts a measurement shall be made.]**

5.3.2.3. Electrolyte spillage

In the period from the impact until 30 minutes after no electrolyte from the RESS shall spill into the passenger compartment and no more than 7 per cent of electrolyte shall spill from the RESS outside the passenger compartment.

The manufacturer shall demonstrate compliance in accordance with paragraph 6.3.5.2.6. of 6.3.5.

5.3.2.4. RESS retention

RESS located inside the passenger compartment shall remain in the location in which they are installed and RESS components shall remain inside RESS boundaries.

No part of any RESS that is located outside the passenger compartment for electric safety assessment shall enter the passenger compartment during or after the impact test.

The manufacturer shall demonstrate compliance in accordance with paragraph 6.3.5.2.7. of 6.3.5.

## 6. Test Conditions and Procedures

### 6.1. Compliance Tests for Fuel System Integrity

#### 6.1.1. Post-Crash Compressed Hydrogen Storage System Leak Test

The crash tests used to evaluate post-crash hydrogen leakage are those already applied in the jurisdictions of each contracting party.

Prior to conducting the crash test, instrumentation is installed in the hydrogen storage system to perform the required pressure and temperature measurements if the standard vehicle does not already have instrumentation with the required accuracy.

The storage system is then purged, if necessary, following manufacturer directions to remove impurities from the container before filling the storage system with compressed hydrogen or helium gas. Since the storage system pressure varies with temperature, the targeted fill pressure is a function of the temperature. The target pressure shall be determined from the following equation:

$$P_{\text{target}} = NWP \times (273 + T_o) / 288$$

where NWP is the Nominal Working Pressure (MPa),  $T_o$  is the ambient temperature to which the storage system is expected to settle, and  $P_{\text{target}}$  is the targeted fill pressure after the temperature settles.

The container is filled to a minimum of 95 per cent of the targeted fill pressure and allowed to settle (stabilize) prior to conducting the crash test.

The main stop valve and shut-off valves for hydrogen gas, located in the downstream hydrogen gas piping, are kept open immediately prior to the impact.

#### 6.1.1.1. Post-crash leak test — compressed hydrogen storage system filled with compressed hydrogen

The hydrogen gas pressure,  $P_o$  (MPa), and temperature,  $T_o$  (C), is measured immediately before the impact and then at a time interval,  $\Delta t$  (min), after the impact. The time interval,  $\Delta t$ , starts when the vehicle comes to rest after the impact and continues for at least 60 minutes. The time interval,  $\Delta t$ , is increased if necessary in order to accommodate measurement accuracy for a storage system with a large volume operating up to 70MPa; in that case,  $\Delta t$  can be calculated from the following equation:

$$\Delta t = V_{\text{CHSS}} \times NWP / 1000 \times ((-0.027 \times NWP + 4) \times R_s - 0.21) - 1.7 \times R_s$$

where  $R_s = P_s / NWP$ ,  $P_s$  is the pressure range of the pressure sensor (MPa), NWP is the Nominal Working Pressure (MPa),  $V_{\text{CHSS}}$  is the volume of the compressed hydrogen storage system (L), and  $\Delta t$  is the time interval (min). If the calculated value of  $\Delta t$  is less than 60 minutes,  $\Delta t$  is set to 60 minutes.

The initial mass of hydrogen in the storage system can be calculated as follows:

$$P_o' = P_o \times 288 / (273 + T_o)$$

$$\rho_o' = -0.0027 \times (P_o')^2 + 0.75 \times P_o' + 0.5789$$

$$M_o = \rho_o' \times V_{CHSS}$$

Correspondingly, the final mass of hydrogen in the storage system,  $M_f$ , at the end of the time interval,  $\Delta t$ , can be calculated as follows:

$$P_f' = P_f \times 288 / (273 + T_f)$$

$$\rho_f' = -0.0027 \times (P_f')^2 + 0.75 \times P_f' + 0.5789$$

$$M_f = \rho_f' \times V_{CHSS}$$

where  $P_f$  is the measured final pressure (MPa) at the end of the time interval, and  $T_f$  is the measured final temperature ( $^{\circ}\text{C}$ ).

The average hydrogen flow rate over the time interval (that shall be less than the criteria in B 5.2.2.1.) is therefore

$$V_{H_2} = (M_f - M_o) / \Delta t \times 22.41 / 2.016 \times (P_{\text{target}} / P_o)$$

where  $V_{H_2}$  is the average volumetric flow rate (NL/min) over the time interval and the term  $(P_{\text{target}} / P_o)$  is used to compensate for differences between the measured initial pressure,  $P_o$ , and the targeted fill pressure  $P_{\text{target}}$ .

#### 6.1.1.2. Post-Crash Leak Test — Compressed hydrogen storage system filled with compressed helium

The helium gas pressure,  $P_o$  (MPa), and temperature  $T_o$  ( $^{\circ}\text{C}$ ), are measured immediately before the impact and then at a predetermined time interval after the impact. The time interval,  $\Delta t$ , starts when the vehicle comes to rest after the impact and continues for at least 60 minutes.

The time interval,  $\Delta t$ , shall be increased if necessary in order to accommodate measurement accuracy for a storage system with a large volume operating up to 70MPa; in that case,  $\Delta t$  can be calculated from the following equation:

$$\Delta t = V_{CHSS} \times NWP / 1000 \times ((-0.028 \times NWP + 5.5) \times R_s - 0.3) - 2.6 \times R_s$$

where  $R_s = P_s / NWP$ ,  $P_s$  is the pressure range of the pressure sensor (MPa),  $NWP$  is the Nominal Working Pressure (MPa),  $V_{CHSS}$  is the volume of the compressed storage system (L), and  $\Delta t$  is the time interval (min). If the value of  $\Delta t$  is less than 60 minutes,  $\Delta t$  is set to 60 minutes.

The initial mass of hydrogen in the storage system is calculated as follows:

$$P_o' = P_o \times 288 / (273 + T_o)$$

$$\rho_o' = -0.0043 \times (P_o')^2 + 1.53 \times P_o' + 1.49$$

$$M_o = \rho_o' \times V_{CHSS}$$

The final mass of hydrogen in the storage system at the end of the time interval,  $\Delta t$ , is calculated as follows:

$$P_f' = P_f \times 288 / (273 + T_f)$$

$$\rho_f' = -0.0043 \times (P_f')^2 + 1.53 \times P_f' + 1.49$$

$$M_f = \rho_f' \times V_{CHSS}$$

where  $P_f$  is the measured final pressure (MPa) at the end of the time interval, and  $T_f$  is the measured final temperature (C).

The average helium flow rate over the time interval is therefore

$$V_{He} = (M_f - M_o) / \Delta t \times 22.41 / 4.003 \times (P_o / P_{target})$$

where  $V_{He}$  is the average volumetric flow rate (NL/min) over the time interval and the term  $P_o / P_{target}$  is used to compensate for differences between the measured initial pressure ( $P_o$ ) and the targeted fill pressure ( $P_{target}$ ).

Conversion of the average volumetric flow of helium to the average hydrogen flow is done with the following expression:

$$V_{H2} = V_{He} / 0.75$$

where  $V_{H2}$  is the corresponding average volumetric flow of hydrogen (that shall be less than the criteria in B 5.2.2.1. to pass).

#### 6.1.2. Post-Crash Concentration Test for Enclosed Spaces

The measurements are recorded in the crash test that evaluates potential hydrogen (or helium) leakage (test procedure para. 6.1.1.).

Sensors are selected to measure either the build-up of the hydrogen or helium gas or the reduction in oxygen (due to displacement of air by leaking hydrogen/helium).

Sensors are calibrated to traceable references to ensure an accuracy of  $\pm 5$  per cent at the targeted criteria of 4 per cent hydrogen or 3 per cent helium by volume in air, and a full scale measurement capability of at least 25 per cent above the target criteria. The sensor shall be capable of a 90 per cent response to a full scale change in concentration within 10 seconds.

Prior to the crash impact, the sensors are located in the passenger, luggage, and cargo compartments of the vehicle as follows:

- (a) At a distance within 250 mm of the headliner above the driver's seat or near the top centre the passenger compartment.
- (b) At a distance within 250 mm of the floor in front of the rear (or rear most) seat in the passenger compartment.
- (c) At a distance within 100 mm of the top of luggage and cargo compartments within the vehicle *that are not directly affected by the particular crash impact to be conducted.*

The sensors are securely mounted on the vehicle structure or seats and protected for the planned crash test from debris, air bag exhaust gas and projectiles. The measurements following the crash are recorded by instruments located within the vehicle or by remote transmission.

The vehicle may be located either outdoors in an area protected from the wind and possible solar effects or indoors in a space that is large enough or ventilated to prevent the build-up of hydrogen to more than 10 per cent of the targeted criteria in the passenger, luggage, and cargo compartments.

Post-crash data collection in enclosed spaces commences when the vehicle comes to a rest. Data from the sensors are collected at least every 5 seconds and continue for a period of 60 minutes after the test. A first-order lag (time



constant) up to a maximum of 5 seconds may be applied to the measurements to provide "smoothing" and filter the effects of spurious data points.

The filtered readings from each sensor shall be below the targeted criteria of **3±1.0** per cent for hydrogen and **3±1.0** per cent for helium at all times throughout the 60 minutes post-crash test period.

- 6.1.3. Compliance Test for Single Failure Conditions
- Either test procedure of para. 6.1.3.1. or para. 6.1.3.2. shall be executed:
- 6.1.3.1. Test Procedure for Vehicle Equipped with Hydrogen Gas Leakage Detectors
- 6.1.3.1.1. Test Condition
- 6.1.3.1.1.1. Test vehicle. The propulsion system of the test vehicle is started, warmed up to its normal operating temperature, and left operating for the test duration. If the vehicle is not a fuel cell vehicle, it is warmed up and kept idling. If the test vehicle has a system to stop idling automatically, measures are taken so as to prevent the engine from stopping.
- 6.1.3.1.1.2. Test gas. Two mixtures of air and hydrogen gas: **2±1.0** per cent concentration (or less) of hydrogen in the air to verify function of the warning, and **3±1.0** per cent concentration (or less) of hydrogen in the air to verify function of the shut-down. The proper concentrations are selected based on the recommendation (or the detector specification) by the manufacturer.
- 6.1.3.1.2. Test method
- 6.1.3.1.2.1. Preparation for the test. The test is conducted without any influence of wind.
- (a) A test gas induction hose is attached to the hydrogen gas leakage detector.
- (b) The hydrogen leak detector is enclosed with a cover to make gas stay around hydrogen leak detector.
- 6.1.3.1.2.2. Execution of the test
- (a) Test gas is blown to the hydrogen gas leakage detector.
- (b) Proper function of the warning system is confirmed when tested with the gas to verify function of the warning.
- (c) The main shut-off valve is confirmed to be closed when tested with the gas to verify function of the shut-down. For example, the monitoring of the electric power to the shut-off valve or of the sound of the shut-off valve activation may be used to confirm the operation of the main shut-off valve of the hydrogen supply.
- 6.1.3.2. ~~Alternative~~ Test Procedure for integrity of enclosed spaces and detection systems.
- 6.1.3.2.1. Preparation:
- 6.1.3.2.1.1. The test is conducted without any influence of wind.
- 6.1.3.2.1.2. Special attention is paid to the test environment as during the test flammable mixtures of hydrogen and air may occur.
- 6.1.3.2.1.3. Prior to the test the vehicle is prepared to allow remotely controllable hydrogen releases from the hydrogen system. The number, location and flow

capacity of the release points downstream of the main hydrogen shutoff valve are defined by the vehicle manufacturer taking worst case leakage scenarios into account. As a minimum, the total flow of all remotely controlled releases shall be adequate to trigger demonstration of the automatic "warning" and hydrogen shut-off functions.

- 6.1.3.2.1.4. For the purpose of the test, hydrogen concentration detectors are installed in enclosed or semi enclosed volumes on the vehicle where hydrogen can accumulate from the simulated hydrogen releases (see para. 6.1.3.2.1.3.).
- 6.1.3.2.2. Procedure:
  - 6.1.3.2.2.1. Vehicle doors, windows and other covers are closed.
  - 6.1.3.1.2.2. The propulsion system is started, allowed to warm up to its normal operating temperature and left operating at idle for the test duration.
  - 6.1.3.2.2.3. A leak is simulated using the remote controllable function.
  - 6.1.3.2.2.4. The hydrogen concentration is measured continuously until the concentration does not rise for 3 minutes. **When testing for compliance with B.5.2.1.4.3,** the simulated leak is then increased using the remote controllable function until the main hydrogen shutoff valve is closed and the tell-tale warning signal is activated. The monitoring of the electric power to the shut-off valve or of the sound of the shut-off valve activation may be used to confirm the operation of the main shut-off valve of the hydrogen supply.
  - 6.1.3.2.2.5. **When testing for compliance with B.5.2.1.4.3,** the test is successfully completed if the tell-tale warning and shut-off function are executed at (or below) the levels specified in paragraph ~~5.2.1.4.2.~~ and 5.2.1.4.3.; otherwise, the test is failed and the system is not qualified for vehicle service.
- 6.1.4. Compliance Test for the Vehicle Exhaust System
  - 6.1.4.1. The power system of the test vehicle (e.g. fuel cell stack or engine) is warmed up to its normal operating temperature.
  - 6.1.4.2. The measuring device is warmed up before use to its normal operating temperature.
  - 6.1.4.3. The measuring section of the measuring device is placed on the centre line of the exhaust gas flow within 100 mm from the exhaust gas outlet external to the vehicle.
  - 6.1.4.4. The exhaust hydrogen concentration is continuously measured during the following steps:
    - (a) The power system is shut down
    - (b) Upon completion of the shut-down process, the power system is immediately started.
    - (c) After a lapse of one minute, the power system is turned off and measurement continues until the power system shut-down procedure is completed.
  - 6.1.4.5. The measurement device shall have a measurement response time of less than 300 milliseconds.
- 6.1.5. Compliance Test for Fuel Line Leakage

- 6.1.5.1. The power system of the test vehicle (e.g. fuel cell stack or engine) is warmed up and operating at its normal operating temperature with the operating pressure applied to fuel lines.
- 6.1.5.2. Hydrogen leakage is evaluated at accessible sections of the fuel lines from the high-pressure section to the fuel cell stack (or the engine), using a gas detector or leak detecting liquid, such as soap solution.
- 6.1.5.3. Hydrogen leak detection is performed primarily at joints
- 6.1.5.4. When a gas leak detector is used, detection is performed by operating the leak detector for at least 10 seconds at locations as close to fuel lines as possible.
- 6.1.5.5. When a leak detecting liquid is used, hydrogen gas leak detection is performed immediately after applying the liquid. In addition, visual checks are performed a few minutes after the application of liquid in order to check for bubbles caused by trace leaks.
- 6.1.6. Installation verification  
The system is visually inspected for compliance.
- 6.2. Test Procedures for Compressed Hydrogen Storage
- 6.2.1. Test procedures for qualification requirements of compressed hydrogen storage are organized as follows:
- Section 6.2.2 is the Test Procedures for Baseline Performance Metrics (requirement of para. 5.1.1.)**
- Section 6.2.3 is the Test Procedures for Performance Durability (requirement of para. 5.1.2.)**
- Section 6.2.4 is the Test Procedures for Expected On-Road Performance (requirement of para. 5.1.3.)**
- Section 6.2.5 is the Test Procedures for Service Terminating Performance in Fire (requirement of para. 5.1.4.)**
- Section 6.2.6 is the Test Procedures for Primary Closures with the Hydrogen Storage System (requirement of para. 5.1.5.)**
- 6.2.2. Test Procedures for Baseline Performance Metrics Part (requirement of para. 5.1.1.)
- 6.2.2.1. Burst Test (Hydraulic). The burst test is conducted at 20(±5)°C using a non-corrosive fluid. The rate of pressurization is less than or equal to 1.4 MPa/s for pressures higher than 150 per cent of the nominal working pressure. If the rate exceeds 0.35 MPa/s at pressures higher than 150 per cent NWP, then either the container is placed in series between the pressure source and the pressure measurement device, or the time at the pressure above a target burst pressure exceeds 5 seconds. The burst pressure of the container shall be recorded.
- 6.2.2.2. Pressure Cycling Test (Hydraulic). The test is performed in accordance with the following procedure:
- The container is filled with a non-corrosive fluid.
  - The container and fluid are stabilized at the specified temperature and relative humidity at the start of testing; the environment, fuelling fluid

and container skin are maintained at the specified temperature for the duration of the testing. The container temperature may vary from the environmental temperature during testing.

- (c) The container is pressure cycled between 2 ( $\pm 1$ ) MPa and the target pressure at a rate not exceeding 10 cycles per minute for the specified number of cycles.
- (d) The temperature of the hydraulic fluid within the container is maintained and monitored at the specified temperature.

6.2.3. Test Procedures for Performance Durability (Part paragraph 5.1.2.)

6.2.3.1. Proof Pressure Test. The system is pressurized smoothly and continually with a non-corrosive hydraulic fluid until the target test pressure level is reached and then held for the specified time. ~~not less than 30 seconds. The component shall not leak or suffer permanent deformation. All mechanical components shall be functional after completion of the test.~~

6.2.3.2. Drop (Impact) Test (Unpressurized). ~~The storage container is~~ drop tested at ambient temperature without internal pressurization or attached valves. The surface onto which the containers are dropped shall be a smooth, horizontal concrete pad or other flooring type with equivalent hardness.

- (a) **The orientation of the container being dropped (per requirement B.5.1.2.2) is determined as follows: One or more additional container(s) shall be dropped in each of the orientations described below. The drop orientations may be executed with a single container or as many as four containers may be used to accomplish the four drop orientations.**
  - (i) Dropped once from a horizontal position with the bottom 1.8 m above the surface onto which it is dropped.
  - (ii) Dropped once onto **the end of the container from a vertical position with the ported end downward** with a potential energy of not less than 488J, with the height of the lower end no greater than 1.8 m.
  - (iii) **Dropped once onto the end of the container from a vertical position with the ported end upward with a potential energy of not less than 488 J, with the height of the lower end no greater than 1.8 m. If the container is symmetrical (identical ported ends), this drop orientation is not required**
  - (iv) Dropped once at a 45° angle **from the vertical orientation with a ported end downward** with its centre of gravity 1.8 m above the ground. However, if the bottom is closer to the ground than 0.6 m, the drop angle shall be changed to maintain a minimum height of 0.6 m and a centre of gravity of 1.8 m above the ground.

**The four drop orientations** are illustrated below.

Figure 5

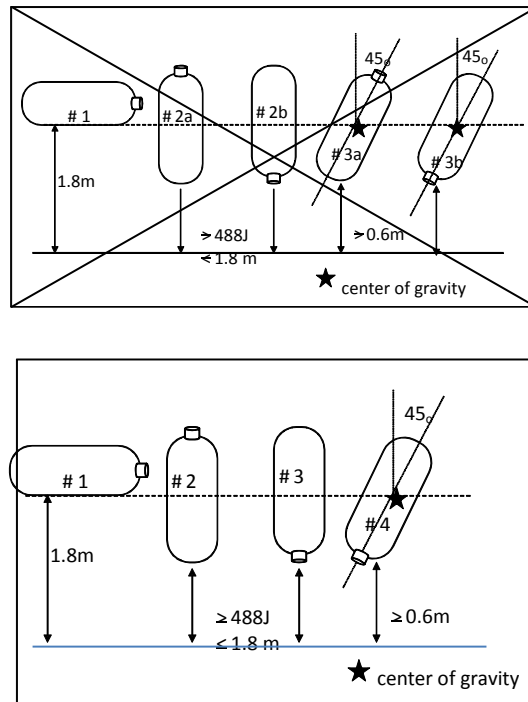

No attempt shall be made to prevent the bouncing of containers, but the containers may be prevented from falling over during the vertical drop test described in b) above.

~~A single container may be used to accomplish more than one of the three drop specifications. (The three drop specifications may be executed with a single container, or as many as three containers may be used to accomplish the three drop specifications.)~~

~~If a single container is subjected to all three drop specifications and leakage does not occur within number of Cycles (5,500, 7,500 or 11,000), then that container will undergo further testing as specified in paragraph 5.1.2.~~

**If more than one container is used to execute all three drop specifications, then those containers shall undergo pressure cycling according to B 6.2.2.2. until either leakage or [22,000] cycles without leakage have occurred. Leakage shall not occur within number of Cycles (5,500, 7,500 or 11,000).**

The **orientation of the container being dropped per requirement B.5.1.2.2.** ~~new container that will undergo further testing as specified in paragraph 5.1.2.,~~ shall be identified as follows:

- (a) **If a single container was subjected to all four drop orientations, then the container being dropped per requirement B.5.1.2.2 shall be dropped in all four orientations.**
- (b) **If more than one container is used to execute the four drop orientations, and if all containers reach [22,000] cycles without leakage, then the orientation of the container being dropped per requirement B.5.1.2.2 is the 45° orientation (iv), and that container shall then undergo further testing as specified in paragraph 5.1.2.**

- (c) **If more than one container is used to execute the four drop orientations and if** any container does not reach [22,000] cycles without leakage, then the new container shall be subjected to the drop orientation(s) that resulted in the lowest number of cycles to leakage and then will undergo further testing as specified in paragraph 5.1.2.

6.2.3.3. Surface Damage Test (Unpressurized). The test proceeds in the following sequence:

- (a) **Surface Flaw Generation:** Two longitudinal saw cuts are made on the bottom outer surface of the unpressurized horizontal storage container along the cylindrical zone close to but not in the shoulder area. The first cut is at least 1.25 mm deep and 25 mm long toward the valve end of the container. The second cut is at least 0.75 mm deep and 200 mm long toward the end of the container opposite the valve.
- (b) **Pendulum Impacts:** The upper section of the horizontal storage container is divided into five distinct (not overlapping) areas 100 mm in diameter each (see Figure 6). After 12 hours preconditioning at  $-40\text{ }^{\circ}\text{C}$  in an environmental chamber, the centre of each of the five areas sustains the impact of a pendulum having a pyramid with equilateral faces and square base, the summit and edges being rounded to a radius of 3 mm. The centre of impact of the pendulum coincides with the centre of gravity of the pyramid. The energy of the pendulum at the moment of impact with each of the five marked areas on the container is 30 J. The container is secured in place during pendulum impacts and not under pressure.

Figure 6  
Side view of tank

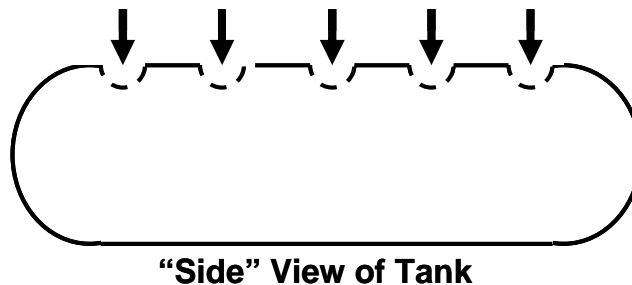

6.2.3.4. Chemical Exposure and Ambient Temperature Pressure Cycling Test. Each of the 5 areas of the unpressurized container preconditioned by pendulum impact (paragraph 6.4.2.5.2.) is exposed to one of five solutions:

- (a) 19 per cent (by volume) sulphuric acid in water (battery acid),
- (b) 25 per cent (by weight) sodium hydroxide in water,
- (c) 5 per cent (by volume) methanol in gasoline (fluids in fuelling stations),
- (d) 28 per cent (by weight) ammonium nitrate in water (urea solution), and
- (e) 50 per cent (by volume) methyl alcohol in water (windshield washer fluid).

The test container is oriented with the fluid exposure areas on top. A pad of glass wool approximately 0.5 mm thick and 100 mm in diameter is placed on each of the five preconditioned areas. A sufficient amount of the test fluid is applied to the glass wool sufficient to ensure that the pad is wetted across its surface and through its thickness for the duration of the test.

The exposure of the container with the glass wool is maintained for 48 hrs with the container held at 125 per cent NWP (applied hydraulically) and 20 ° (±5)C before the container is subjected to further testing.

Pressure cycling is performed to the specified target pressures according to paragraph 6.2.2.2. at 20(±5)°C for the specified numbers of cycles. The glass wool pads are removed and the container surface is rinsed with water the final 10 cycles to specified final target pressure are conducted.

- 6.2.3.5. Static Pressure Test (Hydraulic). The storage system is pressurized to the target pressure in a temperature-controlled chamber. The temperature of the chamber and the non-corrosive fuelling fluid is held at the target temperature within ±5°C for the specified duration.
- 6.2.4. Test Procedures for Expected On-Road Performance (para. 5.1.3.)  
(Pneumatic test procedures are provided; Hydraulic Test elements are described in para. 6.3.2)
- 6.2.4.1. Gas Pressure Cycling Test (Pneumatic). At the onset of testing, the storage system is stabilized at the specified temperature, relative humidity and fuel level for at least 24 hrs. The specified temperature and relative humidity is maintained within the test environment throughout the remainder of the test. (When required in the test specification, the system temperature is stabilized at the external environmental temperature between pressure cycles.) The storage system is pressure cycled between less than 2(±1) MPa and the specified maximum pressure (±1MPa). If system controls that are active in vehicle service prevent the pressure from dropping below a specified pressure, the test cycles shall not go below that specified pressure. The fill rate is controlled to a constant 3-minute pressure ramp rate, but with the fuel flow not to exceed 60 g/s; the temperature of the hydrogen fuel dispensed to the container is controlled to the specified temperature. The defuelling rate is controlled to greater than or equal to the intended vehicle's maximum fuel-demand rate. The specified number of pressure cycles is conducted. If devices and/or controls are used in the intended vehicle application to prevent an extreme internal temperature, the test may be conducted with these devices and/or controls (or equivalent measures).
- 6.2.4.2. Gas Permeation Test (Pneumatic). A storage system is fully filled with hydrogen gas (full fill density equivalent to 100 per cent NWP at 15 °C is 113 per cent NWP at 55 °C) and held at 55 °C in a sealed container. The total steady-state discharge rate due to leakage and permeation from the storage system is measured.
- 6.2.4.3. Localized Gas Leak Test (Pneumatic). A bubble test may be used to fulfil this requirement. The following procedure is used when conducting the bubble test:
- (a) The exhaust of the shutoff valve (and other internal connections to hydrogen systems) shall be capped for this test (as the test is focused at external leakage).

At the discretion of the tester, the test article may be immersed in the leak-test fluid or leak-test fluid applied to the test article when resting in open air. Bubbles can vary greatly in size, depending on conditions. The tester estimates the gas leakage based on the size and rate of bubble formation.

- (b) Note: For a localized rate of 0.005 mg/sec (3.6 NmL/min), the resultant allowable rate of bubble generation is about 2,030 bubbles per minute for a typical bubble size of 1.5 mm in diameter. Even if much larger bubbles are formed, the leak should be readily detectable. For an unusually large bubble size of 6 mm in diameter, the allowable bubble rate would be approximately 32 bubbles per minute.

6.2.5. Test Procedures for Service Terminating Performance in Fire (para. 5.1.4.)

6.2.5.1. Fire Test (pneumatic)

The hydrogen container assembly consists of the compressed hydrogen storage system with additional relevant features, including the venting system (such as the vent line and vent line covering) and any shielding affixed directly to the container (such as thermal wraps of the container(s) and/or coverings/barriers over the TPRD(s)).

Either one of the following two methods are used to identify the position of the system over the initial (localized) fire source:

6.2.5.1.1. Method I: Qualification for a Generic (Non-Specific) Vehicle Installation

If a vehicle installation configuration is not specified (and the qualification of the system is not limited to a specific vehicle installation configuration) then the localized fire exposure area is the area on the test article farthest from the TPRD(s). The test article, as specified above, only includes thermal shielding or other mitigation devices affixed directly to the container that are used in all vehicle applications. Venting system(s) (such as the vent line and vent line covering) and/or coverings/barriers over the TPRD(s) are included in the container assembly if they are anticipated for use in any application. If a system is tested without representative components, retesting of that system is required if a vehicle application specifies the use of these type of components.

6.2.5.1.2. Method 2: Qualification for a Specific Vehicle Installation

If a specific vehicle installation configuration is specified and the qualification of the system is limited to that specific vehicle installation configuration, then the test setup may also include other vehicle components in addition to the hydrogen storage system. These vehicle components (such as shielding or barriers, which are permanently attached to the vehicle's structure by means of welding or bolts and not affixed to the storage system) shall be included in the test setup in the vehicle-installed configuration relative to the hydrogen storage system. This localized fire test is conducted on the worst case localized fire exposure areas based on the four fire orientations: fires originating from the direction of the passenger compartment, cargo/luggage compartment, wheel wells or ground-pooled gasoline.

The container may be subjected to engulfing fire without any shielding components, as described in paragraph 6.2.5.2.



The following test requirements apply whether Method 1 or 2 (above) is used:

- (a) The container assembly is filled with compressed hydrogen gas at 100 per cent of NWP. The container assembly is positioned horizontally approximately 100 mm above the fire source. (Note: as stated in para. 5.1.4., contracting parties under the 1998 Agreement may choose to use compressed air as an alternative test gas for certification of the container for use in their countries or regions.)

#### Localized Portion of the Fire Test

- (b) The localized fire exposure area is located on the test article furthest from the TPRD(s). If Method 2 is selected and more vulnerable areas are identified for a specific vehicle installation configuration, the more vulnerable area that is furthest from the TPRD(s) is positioned directly over the initial fire source.
- (c) The fire source consists of LPG burners configured to produce a uniform minimum temperature on the test article measured with a minimum 5 thermocouples covering the length of the test article up to 1.65 m maximum (at least 2 thermocouples within the localized fire area, and at least 3 thermocouples equally spaced and no more than 0.5 m apart in the remaining area) located 25 mm  $\pm$  10mm from the outside surface of the test article along its longitudinal axis. At the option of the manufacturer or testing facility, additional thermocouples may be located at TPRD sensing points or any other locations for optional diagnostic purposes.
- (d) Wind shields are applied to ensure uniform heating.
- (e) The fire source initiates within a 250 mm  $\pm$ 50 mm longitudinal expanse positioned under the localized exposure area of the test article. The width of the fire source encompasses the entire diameter (width) of the storage system. If Method 2 is selected, the length and width shall be reduced, if necessary, to account for vehicle-specific features.
- (f) As shown in Figure 7 the temperature of the thermocouples in the localized fire area has increased continuously to at least 600 °C within 3 minutes of ignition, and a temperature of at least 600 °C is maintained for the next 5 minutes. The temperature in the localized fire area shall not exceed 900 °C during this period. Compliance to the thermal requirements begins 1 minute after entering the period with minimum and maximum limits and is based on a 1-minute rolling average of each thermocouple in the region of interest. (Note: The temperature outside the region of the initial fire source is not specified during these initial 8 minutes from the time of ignition.)

[The below profiles for fire time are being considered by SGS group:

Figure 7

#### Temperature profile of fire test

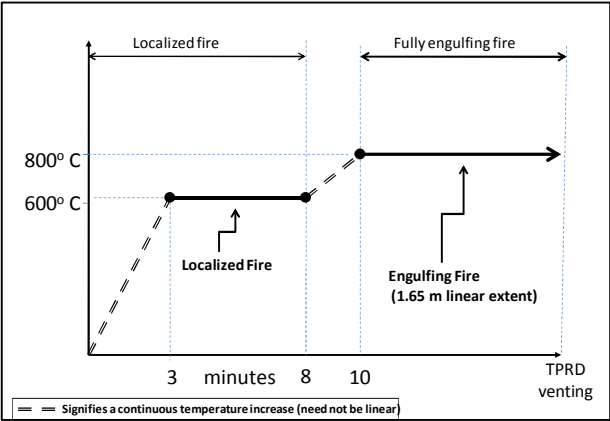
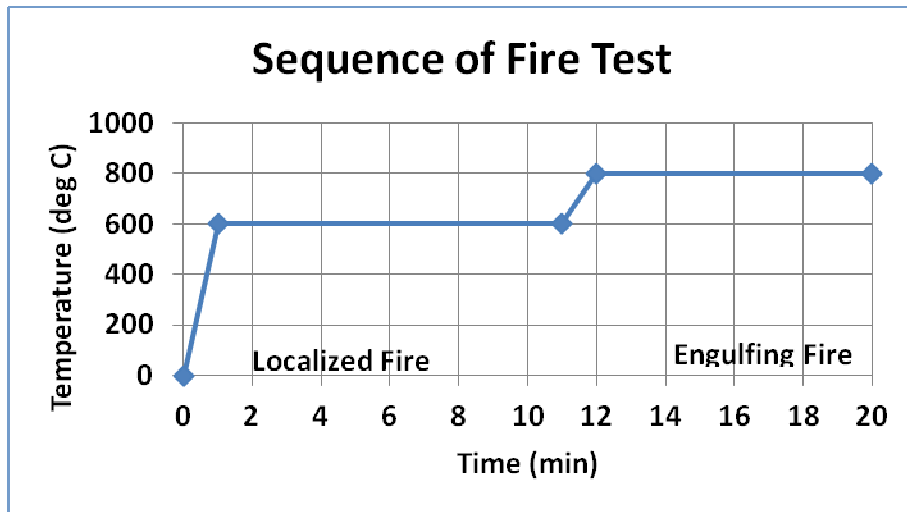

Figure 8  
Sequence of fire test



]

#### Engulfing Portion of the Fire Test

Within the next 2-minute interval, the temperature along the entire surface of the test article shall be increased to at least 800 °C and the fire source is extended to produce a uniform temperature along the entire length up to 1.65 meters and the entire width of the test article (engulfing fire). The minimum temperature is held at 800°C, and the maximum temperature shall not exceed 1100 °C. Compliance to thermal requirements begins 1 minute after entering the period with constant minimum and maximum limits and is based on a 1-minute rolling average of each thermocouple.

The test article is held at temperature (engulfing fire condition) until the system vents through the TPRD and the pressure falls to less than 1 MPa. The venting shall be continuous (without interruption), and the storage system shall not rupture. An additional release through leakage (not including release through the TPRD) that results in a flame with length greater than 0.5 m beyond the perimeter of the applied flame shall not occur.

#### Documenting Results of the Fire Test

The arrangement of the fire is recorded in sufficient detail to ensure the rate of heat input to the test article is reproducible. The results include the elapsed time from ignition of the fire to the start of venting through the TPRD(s), and the maximum pressure and time of evacuation until a pressure of less than 1 MPa is reached. Thermocouple temperatures and container pressure are recorded at intervals of every 10 sec or less during the test. Any failure to maintain specified minimum temperature requirements based on the 1-minute rolling averages invalidates the test result. Any failure to maintain specified maximum temperature requirements based on the 1-minute rolling averages invalidates the test result only if the test article failed during the test.

#### 6.2.5.2. Engulfing fire test:

The test unit is the compressed hydrogen storage system. The storage system is filled with compressed hydrogen gas at 100 per cent NWP. The container

is positioned horizontally with the container bottom approximately 100 mm above the fire source. Metallic shielding is used to prevent direct flame impingement on container valves, fittings, and/or pressure relief devices. The metallic shielding is not in direct contact with the specified fire protection system (pressure relief devices or container valve).

A uniform fire source of 1.65 m (65 in) length provides direct flame impingement on the container surface across its entire diameter. The test shall continue until the container fully vents (until the container pressure falls below 0.7MPa (100 psi)). Any failure or inconsistency of the fire source during a test shall invalidate the result.

Flame temperatures shall be monitored by at least three thermocouples suspended in the flame approximately 25 mm (1 in) below the bottom of the container. Thermocouples may be attached to steel cubes up to 25 mm (1 in) on a side. Thermocouple temperature and the container pressure shall be recorded every 30 seconds during the test.

Within five minutes after the fire is ignited, an average flame temperature of not less than 590°C (as determined by the average of the two thermocouples recording the highest temperatures over a 60 second interval) is attained and maintained for the duration of the test.

If the container is less than 1.65 m in length, the centre of the container shall be positioned over the centre of the fire source. If the container is greater than 1.65m in length, then if the container is fitted with a pressure relief device at one end, the fire source shall commence at the opposite end of the container. If the container is greater than 1.65 m in length and is fitted with pressure relief devices at both ends, or at more than one location along the length of the container, the centre of the fire source shall be centred midway between the pressure relief devices that are separated by the greatest horizontal distance.

The container shall vent through a pressure relief device without bursting.

6.2.6. Test Procedures for Primary Closures within the Compressed Gaseous Hydrogen Storage System (para. 5.1.5. requirement).

6.2.6.1. Compressed Hydrogen Storage TPRD Qualification Performance Tests

Testing is performed with hydrogen gas having gas quality compliant with ISO 14687-2/SAE J2719. All tests are performed at ambient temperature 20 (±5)°C unless otherwise specified. The TPRD qualification performance tests are specified as follows:

6.2.6.1.1. Pressure Cycling Test.

Five TPRD units undergo 11,000 internal pressure cycles with hydrogen gas having gas quality compliant with ISO 14687-2/SAE J2719. The first five pressure cycles are between < 2(±1)MPa and 150 per cent NWP(±1MPa); the remaining cycles are between 2(±1)MPa and 125 per cent NWP(±1MPa). The first 1500 pressure cycles are conducted at a TPRD temperature of +85 °C. The remaining cycles are conducted at a TPRD temperature of +55 °C. The maximum pressure cycling rate is ten cycles per minute. Following this test, the pressure relief device shall meet the requirements of the Leak Test (B 6.2.6.1.8.), Flow Rate Test (paragraph 6.2.6.1.10.) and the Bench Top Activation Test (paragraph 6.2.6.1.9.).

6.2.6.1.2. Accelerated Life Test.

Eight TPRD units undergo testing; three at the manufacturer's specified activation temperature,  $T_{act}$ , and five at an accelerated life temperature,  $T_{life} = 9.1 \times T_{act}^{0.503}$ . The TPRD is placed in an oven or liquid bath with the temperature held constant ( $\pm 1$  °C). The hydrogen gas pressure on the TPRD inlet is 125 per cent NWP ( $\pm 1$ MPa). The pressure supply may be located outside the controlled temperature oven or bath. Each device is pressurized individually or through a manifold system. If a manifold system is used, each pressure connection includes a check valve to prevent pressure depletion of the system when one specimen fails. The three TPRDs tested at  $T_{act}$  shall activate in less than ten hours. The five TPRDs tested at  $T_{life}$  shall not activate in less than 500 hours.

#### 6.2.6.1.3. Temperature Cycling Test

- (a) An unpressurized TPRD is placed in a liquid bath maintained at  $-40$ °C at least two hours. The TPRD is transferred to a liquid bath maintained at  $+85$  °C within five minutes, and maintained at that temperature at least two hours. The TPRD is transferred to a liquid bath maintained at  $-40$  °C within five minutes.
- (b) Step (a) is repeated until 15 thermal cycles have been achieved.
- (c) With the TPRD conditioned for a minimum of two hours in the  $-40$  °C liquid bath, the internal pressure of the TPRD is cycled with hydrogen gas between  $< 2$ MPa and 80 per cent NWP for 100 cycles while the liquid bath is maintained at  $-40$  °C.
- (d) Following the thermal and pressure cycling, the TPRD shall meet the requirements of the Leak Test (para. 6.2.6.1.8.), except that the Leak Test and Flow Rate Test (para. 6.2.6.1.10.) are conducted at  $-40$ °C, and the Bench Top Activation Test (para. 6.2.6.1.9.).

#### 6.2.6.1.4. Salt Corrosion Resistance Test

Two TPRD units are tested. Any non-permanent outlet caps are removed. Each TPRD unit is installed in a test fixture in accordance with the manufacturer's recommended procedure so that external exposure is consistent with realistic installation. Each unit is pressurized to 125 per cent of the service pressure and exposed for 150 hours to a salt spray (fog) test as specified in ASTM B117 (Standard Practice for Operating Salt Spray (Fog) Apparatus) except that in the test of one unit, the pH of the salt solution shall be adjusted to  $4.0 \pm 0.2$  by the addition of sulphuric acid and nitric acid in a 2:1 ratio, and in the test of the other unit, the pH of the salt solution shall be adjusted to  $10.0 \pm 0.2$  by the addition of sodium hydroxide.

If the component is expected to operate in vehicle underbody service conditions, then it is exposed for 500 hours to the salt spray (fog) test. The temperature within the fog chamber is maintained at  $30-35$  °C). Following these tests, each pressure relief device shall meet the requirements of the Leak Test (para. 6.2.6.1.8.), Flow Rate Test (para. 6.2.6.1.10.) and Bench Top Activation Test (para. 6.2.6.1.9.).

#### 6.2.6.1.5. Vehicle Environment Test

Resistance to degradation by external exposure to automotive fluids is determined by the following test, by comparable published data or by known properties (e.g. 300 series stainless steel). The decision about the

applicability of test data and known properties is at the discretion of the testing authority.

- (a) The inlet and outlet connections of the TPRD are connected or capped in accordance with the manufacturers installation instructions. The external surfaces of the TPRD are exposed for 24 hours at 20 ( $\pm$ 5) °C to each of the following fluids:
  - (i) Sulphuric acid - 19 per cent solution by volume in water;
  - (ii) Sodium hydroxide - 25 per cent solution by weight in water
  - (iii) Ammonium nitrate - 28 per cent by weight in water; and
  - (iv) Windshield washer fluid (50 per cent by volume methyl alcohol and water).

The fluids are replenished as needed to ensure complete exposure for the duration of the test. A distinct test is performed with each of the fluids. One component may be used for exposure to all of the fluids in sequence.

- (b) After exposure to each fluid, the component is wiped off and rinsed with water and examined. The component shall not show signs of mechanical degradation that could impair the function of the component such as cracking, softening, or swelling. Cosmetic changes such as pitting or staining are not failures.
- (c) At the conclusion of all exposures, the unit(s) shall comply with the requirements of the Leak Test (para. 6.2.6.1.8.), Flow Rate Test (para. 6.2.6.1.10.) and Bench Top Activation test (para. 6.2.6.1.9.).

#### 6.2.6.1.6. Stress Corrosion Cracking Test.

For TPRDs containing components made of a copper-based alloy (e.g. brass), one TPRD unit is tested. The TPRD is disassembled, all copper-based alloy components are degreased and then the TPRD is reassembled before it is continuously exposed for ten days to a moist ammonia-air mixture maintained in a glass chamber having a glass cover.

Aqueous ammonia having a specific gravity of 0.94 is maintained at the bottom of the glass chamber below the sample at a concentration of at least 20 ml per litre of chamber volume. The sample is positioned 35( $\pm$ 5) mm above the aqueous ammonia solution and supported in an inert tray. The moist ammonia-air mixture is maintained at atmospheric pressure at +35° ( $\pm$ 5)C. Copper-based alloy components shall not exhibit cracking or delaminating due to this test.

#### 6.2.6.1.7. Drop and Vibration Test

- (a) Six TPRD units are dropped from a height of 2 m at ambient temperature onto a smooth concrete surface. Each sample is allowed to bounce on the concrete surface after the initial impact. One unit is dropped in six orientations (opposing directions of 3 orthogonal axes). If each of the six dropped samples does not show visible exterior damage that indicates that the part is unsuitable for use, it shall proceed to step (b).
- (b) Each of the six TPRD units dropped in step (a) and one additional unit not subjected to a drop are mounted in a test fixture in accordance

with manufacturer's installation instructions and vibrated 30 minutes along each of the three orthogonal axes at the most severe resonant frequency for each axis. The most severe resonant frequencies are determined using an acceleration of 1.5 g and sweeping through a sinusoidal frequency range of 10 to ~~500~~ **40 Hz** within 10 minutes. The resonance frequency is identified by a pronounced increase in vibration amplitude. If the resonance frequency is not found in this range, the test shall be conducted at 500 Hz. Following this test, each sample shall not show visible exterior damage that indicates that the part is unsuitable for use. It shall subsequently meet the requirements of the Leak Test (para. 6.2.6.1.8.), Flow Rate Test (para. 6.2.6.1.10.) and Bench Top Activation Test (para. 6.2.6.1.9.).

#### 6.2.6.1.8. Leak Test

The TPRD unit is held at 125 per cent NWP with hydrogen gas for one hour at ambient temperature before leakage is measured. Accuracy, response time and calibration of the measurement method are documented. The total hydrogen leak rate shall be less than 216 Nml/hr.

#### 6.2.6.1.9. Bench Top Activation Test

Two new TPRD units are tested without being subjected to other design qualification tests in order to establish a baseline time for activation. Additional pre-tested units (pre-tested according to paras. 6.2.6.1.1., 6.2.6.1.3., 6.2.6.1.4., 6.2.6.1.5. or 6.2.6.1.7.) undergo bench top activation testing as specified in other tests in para. 6.2.6.1.

- (a) The test setup consists of either an oven or chimney which is capable of controlling air temperature and flow to achieve 600 ( $\pm 10$ )°C in the air surrounding the TPRD. The TPRD unit is not exposed directly to flame. The TPRD unit is mounted in a fixture according to the manufacturer's installation instructions; the test configuration is to be documented.
- (b) A thermocouple is placed in the oven or chimney to monitor the temperature. The temperature remains within the acceptable range for two minutes prior to running the test.
- (c) The pressurized TPRD unit is inserted into the oven or chimney, and the time for the device to activate is recorded. Prior to insertion into the oven or chimney, one new (not pre-tested) TPRD unit is pressurized to no more than 25 per cent NWP (the pre-tested); TPRD units are pressurized to no more than 25 per cent NWP; and one new (not pre-tested) TPRD unit is pressurized to 100 per cent NWP.
- (d) TPRD units previously subjected to other tests in para. 6.2.6.1. shall activate within a period no more than two minutes longer than the baseline activation time of the new TPRD unit that was pressurized to up to 25 per cent NWP.
- (e) The difference in the activation time of the two TPRD units that had not undergone previous testing shall be no more than 2 minutes.

#### 6.2.6.1.10. Flow Rate Test

- (a) Eight TPRD units are tested for flow capacity. The eight units consist of three new TPRD units and one TRPD unit from each of the

following previous tests: paras. 6.2.6.1.1., 6.2.6.1.3., 6.2.6.1.4., 6.2.6.1.5. and 6.2.6.1.7.

- (b) Each TPRD unit is activated according to para. 6.2.6.1.9. After activation and without cleaning, removal of parts, or reconditioning, each TPRD unit is subjected to flow test using hydrogen, air or an inert gas.
- (c) Flow rate testing is conducted with a gas inlet pressure of 2 ( $\pm$  0.5) MPa. The outlet is at ambient pressure. The inlet temperature and pressure are recorded.
- (d) Flow rate is measured with accuracy within  $\pm$  2 per cent. The lowest measured value of the eight pressure relief devices shall not be less than 90 per cent of the highest flow value.
- (e) Flow rate is recorded as the lowest measured value of the eight pressure relief devices tested in NL per minute (0 °C and 1 atmosphere) corrected for hydrogen.

#### 6.2.6.2. Compressed Hydrogen Storage Qualification Performance Tests for Check Valve and Automatic Shut-Off Valve

Testing shall be performed with hydrogen gas having gas quality compliant with ISO 14687-2/SAE J2719. All tests are performed at ambient temperature 20 ( $\pm$ 5)°C unless otherwise specified. The check valve and automatic shut-off valve qualification performance tests are specified as follows:

##### 6.2.6.2.1. Hydrostatic Strength Test

The outlet opening in components is plugged and valve seats or internal blocks are made to assume the open position. One unit is tested without being subjected to other design qualification tests in order to establish a baseline burst pressure, other units are tested as specified in subsequent tests of para. 6.2.6.2.

- (a) A hydrostatic pressure of 250 per cent NWP is applied to the inlet of the component for three minutes. The component is examined to ensure that rupture has not occurred.
- (b) The hydrostatic pressure is then increased at a rate of less than or equal to 1.4 MPa/sec until component failure. The hydrostatic pressure at failure is recorded. The failure pressure of previously tested units shall be no less than 80 per cent of the failure pressure of the baseline, unless the hydrostatic pressure exceeds 400 per cent NWP.

##### 6.2.6.2.2. Leak Test

One unit is tested at ambient temperature without being subjected to other design qualification tests. Three temperature regimes are specified:

- (a) Ambient temperature: condition the unit at 20( $\pm$ 5) °C; test at 5 per cent NWP and 150 per cent NWP
- (b) High temperature: condition the unit at +85 °C; test at 5 per cent NWP and 150 per cent NWP
- (c) Low temperature: condition the unit at -40 °C; test at 5 per cent NWP and 100 per cent NWP. Additional units undergo leak testing as



specified in other tests in para. 6.2.6.2. with uninterrupted exposure to the temperatures specified in those tests.

The outlet opening is plugged with the appropriate mating connection and pressurized hydrogen is applied to the inlet. At all specified test temperatures, the unit is conditioned for one minute by immersion in a temperature controlled fluid (or equivalent method). If no bubbles are observed for the specified time period, the sample passes the test. If bubbles are detected, the leak rate is measured by an appropriate method. The leak rate shall not exceed 216 Nml/hr of hydrogen gas.

#### 6.2.6.2.3. Extreme Temperature Continuous Valve Cycling Test:

- (a) The total number of operational cycles is 50,000. The valve unit are installed in a test fixture corresponding to the manufacturer's specifications for installation. The operation of the unit is continuously repeated using hydrogen gas at all specified pressures.

An operational cycle shall be defined as follows:

- (i) A check valve is connected to a test fixture and pressure is applied in six pulses to the check valve inlet with the outlet closed. The pressure is then vented from the check valve inlet. The pressure is lowered on the check valve outlet side to < 60 per cent NWP prior to the next cycle.
- (ii) An automatic shut-off valve is connected to a test fixture and pressure is applied continuously to the both the inlet and outlet sides.

An operational cycle consists of one full operation and reset within an appropriate period as determined by the testing agency.

- (b) Testing is performed on a unit stabilized at the following temperatures:
- (i) Ambient Temperature Cycling. The unit undergoes operational (open/closed) cycles at 125 per cent NWP through 90 per cent of the total cycles with the part stabilized at 20 ( $\pm 5$ ) °C. At the completion of the ambient temperature operational cycles, the unit shall comply with the ambient temperature leak test specified in para. 6.2.6.2.2.
- (ii) High Temperature Cycling. The unit then undergoes operational cycles at 125 per cent NWP through 5 per cent of the total operational cycles with the part stabilized at +85 °C. At the completion of the +85°C cycles, the unit shall comply with the high temperature (+85 °C) leak test specified in paragraph 6.2.6.2.2.
- (iii) Low Temperature Cycling. The unit then undergoes operational cycles at 100 per cent NWP through 5 per cent of the total cycles with the part stabilized at -40 °C. At the completion of the -40 °C operational cycles, the unit shall comply with the low temperature (-40 °C) leak test specified in paragraph 6.2.6.2.2.
- (c) Check valve Chatter Flow Test. Following 11,000 operational cycles and leak tests, the check valve is subjected to 240 hours of chatter

flow at a flow rate that causes the most chatter (valve flutter). At the completion of the test the check valve shall comply with the ambient temperature leak test (para. 6.2.6.2.2.) and the strength test (para. 6.2.6.2.1.).

#### 6.2.6.2.4. Salt Corrosion Resistance Test

Components having all surfaces in contact with hydrogen composed of AISI series 300 Austenitic stainless steels are exempt from corrosion resistance testing. Materials used in valve units are subjected to this test except where the applicant submits declarations of results of tests carried out on the material provided by the manufacturer.

The component is supported in its normally installed position and exposed for 150 hours to a salt spray (fog) test as specified in ASTM B117 (Standard Practice for Operating Salt Spray (Fog) Apparatus). If the component is expected to operate in vehicle underbody service conditions, it is subsequently exposed for 500 hours to the salt spray (fog) test. The temperature within the fog chamber is maintained at 30 °-35 °C). The saline solution consists of 5 per cent sodium chloride and 95 per cent distilled water, by weight. Immediately after the corrosion test, the sample is rinsed and gently cleaned of salt deposits, examined for distortion, and then shall comply with the requirements of the ambient temperature leak test (para. 6.2.6.2.2.) and the Hydrostatic Strength Test (para. 6.2.6.2.1.).

#### 6.2.6.2.5. Vehicle Environment Test

Resistance to degradation by exposure to automotive fluids is determined by the following test, by comparable published data or by known properties (e.g. 300 series stainless steel). The decision about the applicability of test data and known properties is at the discretion of the testing authority.

- (a) The inlet and outlet connections of the valve unit are connected or capped in accordance with the manufacturers installation instructions. The external surfaces of the valve unit are exposed for 24 hours at 20 (±5) °C to each of the following fluids:
  - (i) Sulphuric acid -19 per cent solution by volume in water;
  - (ii) Sodium hydroxide - 25 per cent solution by weight in water
  - (iii) Ammonium nitrate – 28 per cent by weight in water; and
  - (iv) Windshield washer fluid (50 per cent by volume methyl alcohol and water).

The fluids are replenished as needed to ensure complete exposure for the duration of the test. A distinct test is performed with each of the fluids. One component may be used for exposure to all of the fluids in sequence.

- (b) After exposure to each chemical, the component is wiped off and rinsed with water.
- (c) At the conclusion of all exposures, the unit(s) shall comply with the requirements of the ambient temperature leakage test (para. 6.2.6.2.2.) and Hydrostatic Strength Test (para. 6.2.6.2.1.).

#### 6.2.6.2.6. Atmospheric Exposure Test

The atmospheric exposure test applies to qualification of check valves; it does not apply to qualification of automatic shut-off valves.

- (a) All non-metallic materials that provide a fuel containing seal, and that are exposed to the atmosphere, for which a satisfactory declaration of properties is not submitted by the applicant, shall not crack or show visible evidence of deterioration after exposure to oxygen for 96 hours at 70°C at 2 MPa in accordance with ASTM D572 (Standard Test Method for Rubber- Deterioration by Heat and Oxygen)
- (b) All elastomers shall demonstrate resistance to ozone by one or more of the following:
  - (i) Specification of elastomer compounds with established resistance to ozone.
  - (ii) Component testing in accordance with ISO 1431/1, ASTM D1149, or equivalent test methods.

#### 6.2.6.2.7. Electrical Tests

The electrical tests apply to qualification of the automatic shut-off valve; they do not apply to qualification of check valves.

- (a) Abnormal Voltage Test. The solenoid valve is connected to a variable DC voltage source. The solenoid valve is operated as follows:
  - (i) An equilibrium (steady state temperature) hold is established for one hour at 1.5 times the rated voltage.
  - (ii) The voltage is increased to two times the rated voltage or 60 volts, whichever is less, and held for one minute.
  - (iii) Any failure shall not result in external leakage, open valve or a similar unsafe condition.

The minimum opening voltage at NWP and room temperature shall be less than or equal to 9 V for a 12 V system and less than or equal to 18 V for a 24 V system.

- (b) Insulation Resistance Test. 1,000 V D.C. is applied between the power conductor and the component casing for at least two seconds. The minimum allowable resistance for that component is 240 kΩ.

#### 6.2.6.2.8. Vibration Test

The valve unit is pressurized to its 100 per cent NWP with hydrogen, sealed at both ends, and vibrated for 30 minutes along each of the three orthogonal axes at the most severe resonant frequencies. The most severe resonant frequencies are determined by acceleration of 1.5 g with a sweep time of 10 minutes within a sinusoidal frequency range of 10 to ~~500~~ **40Hz**. If the resonance frequency is not found in this range the test is conducted at ~~500~~ **40Hz**. Following this test, each sample shall not show visible exterior damage that indicates that the performance of the part is compromised. At the completion of the test, the unit shall comply with the requirements of the ambient temperature leak test specified in para. 6.2.6.2.2.

#### 6.2.6.2.9. Stress Corrosion Cracking Test

For the valve units containing components made of a copper-based alloy (e.g. brass), one valve unit is tested. The valve unit is disassembled, all copper-

based alloy components are degreased and then the valve unit is reassembled before it is continuously exposed for ten days to a moist ammonia-air mixture maintained in a glass chamber having a glass cover.

Aqueous ammonia having a specific gravity of 0.94 is maintained at the bottom of the glass chamber below the sample at a concentration of at least 20 ml per litre of chamber volume. The sample is positioned 35(±5) mm above the aqueous ammonia solution and supported in an inert tray. The moist ammonia-air mixture is maintained at atmospheric pressure at +35(±5) °C. Copper-based alloy components shall not exhibit cracking or delaminating due to this test.

6.2.6.10. Pre-Cooled Hydrogen Exposure Test

The valve unit is subjected to pre-cooled hydrogen gas at -40 °C at a flow rate of 30 g/s at external temperature of 20(±5) °C for a minimum of three minutes. The unit is de-pressurized and re-pressurized after a two minute hold period. This test is repeated ten times. This test procedure is then repeated for an additional ten cycles, except that the hold period is increased to 15 minutes. The unit shall then comply with the requirements of the ambient temperature leak test specified in para. 6.2.6.2.2.

6.3. Test Procedures for Electrical Safety (para. 5.3.)

6.3.1. Isolation Resistance Measurement Method

6.3.1.1. General

The isolation resistance for each high voltage bus of the vehicle is measured or shall be determined by calculating the measurement values of each part or component unit of a high voltage bus (hereinafter referred to as the "divided measurement").

6.3.1.2. Measurement Method

The isolation resistance measurement is conducted by selecting an appropriate measurement method from among those listed in para. 6.3.1.2.1. to 6.3.1.2.2., depending on the electrical charge of the live parts or the isolation resistance.

The range of the electrical circuit to be measured is clarified in advance, using electrical circuit diagrams.

Moreover, modifications necessary for measuring the isolation resistance may be carried out, such as removal of the cover in order to reach the live parts, drawing of measurement lines and change in software.

In cases where the measured values are not stable due to the operation of the on-board isolation resistance monitoring system, necessary modifications for conducting the measurement may be carried out by stopping the operation of the device concerned or by removing it. Furthermore, when the device is removed, a set of drawings will be used to prove that the isolation resistance between the live parts and the electrical chassis remains unchanged.

Utmost care shall be exercised to avoid short circuit and electric shock since this confirmation might require direct operations of the high-voltage circuit.

6.3.1.2.1. Measurement method using DC voltage from off-vehicle sources

6.3.1.2.1.1. Measurement instrument

An isolation resistance test instrument capable of applying a DC voltage higher than the working voltage of the high voltage bus is used.

6.3.1.2.1.2. Measurement method

An insulator resistance test instrument is connected between the live parts and the electrical chassis. The isolation resistance is subsequently measured by applying a DC voltage at least half of the working voltage of the high voltage bus.

If the system has several voltage ranges (e.g. because of boost converter) in conductive connected circuit and some of the components cannot withstand the working voltage of the entire circuit, the isolation resistance between those components and the electrical chassis can be measured separately by applying their own working voltage with those components disconnected.

6.3.1.2.2. Measurement method using the vehicle's own RESS as DC voltage source

6.3.1.2.2.1. Test vehicle conditions

The high voltage-bus is energized by the vehicle's own RESS and/or energy conversion system and the voltage level of the RESS and/or energy conversion system throughout the test shall be at least the nominal operating voltage as specified by the vehicle manufacturer.

6.3.1.2.2.2. Measurement instrument

The voltmeter used in this test shall measure DC values and has an internal resistance of at least 10 M $\Omega$ .

6.3.1.2.2.3. Measurement method

6.3.1.2.2.3.1. First step

The voltage is measured as shown in Figure 1 and the high voltage Bus voltage ( $V_b$ ) is recorded.  $V_b$  shall be equal to or greater than the nominal operating voltage of the RESS and/or energy conversion system as specified by the vehicle manufacturer.

Figure 9  
Measurement of  $V_b$ ,  $V_1$ ,  $V_2$

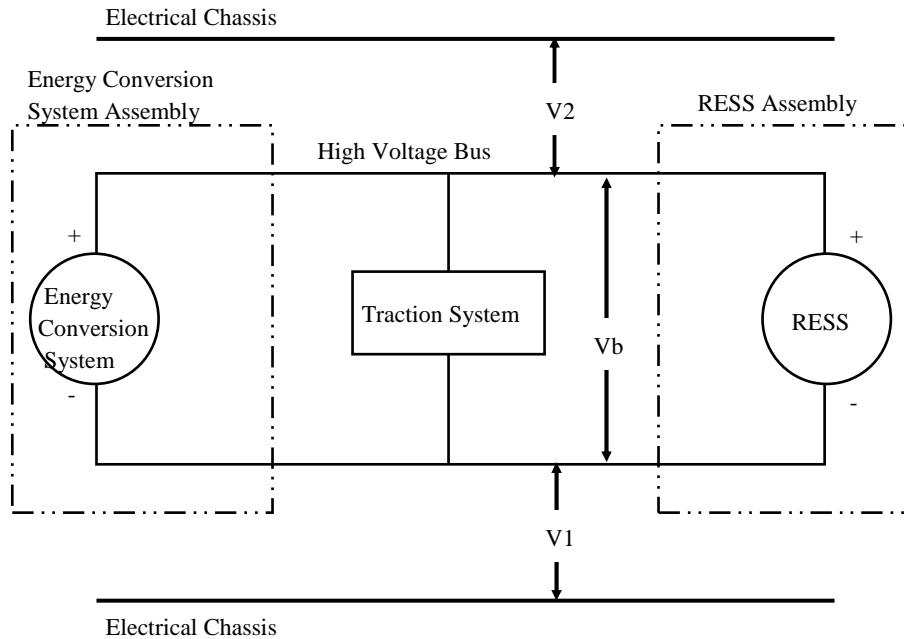

6.3.1.2.2.3.2. Second step

The voltage ( $V_1$ ) between the negative side of the high voltage bus and the electrical chassis is measured and recorded (see Figure 9).

6.3.1.2.2.3.3. Third step

The voltage ( $V_2$ ) between the positive side of the high voltage bus and the electrical chassis is measured and recorded (see Figure 9).

6.3.1.2.2.3.4. Fourth step

If  $V_1$  is greater than or equal to  $V_2$ , a standard known resistance ( $R_o$ ) is inserted between the negative side of the high voltage bus and the electrical chassis. With  $R_o$  installed, the voltage ( $V_1'$ ) between the negative side of the high voltage bus and the electrical chassis is measured (see Figure 2).

The electrical isolation ( $R_i$ ) is calculated according to the following formula:

$$R_i = R_o \cdot (V_b / V_1' - V_b / V_1) \text{ or } R_i = R_o \cdot V_b \cdot (1 / V_1' - 1 / V_1)$$

The resulting  $R_i$ , which is the electrical isolation resistance value (in  $\Omega$ ), is divided by the working voltage of the high voltage bus in volt (V):

$$R_i \Omega / V = R_i \Omega / \text{Working voltage (V)}$$

Figure 10  
Measurement of  $V1'$

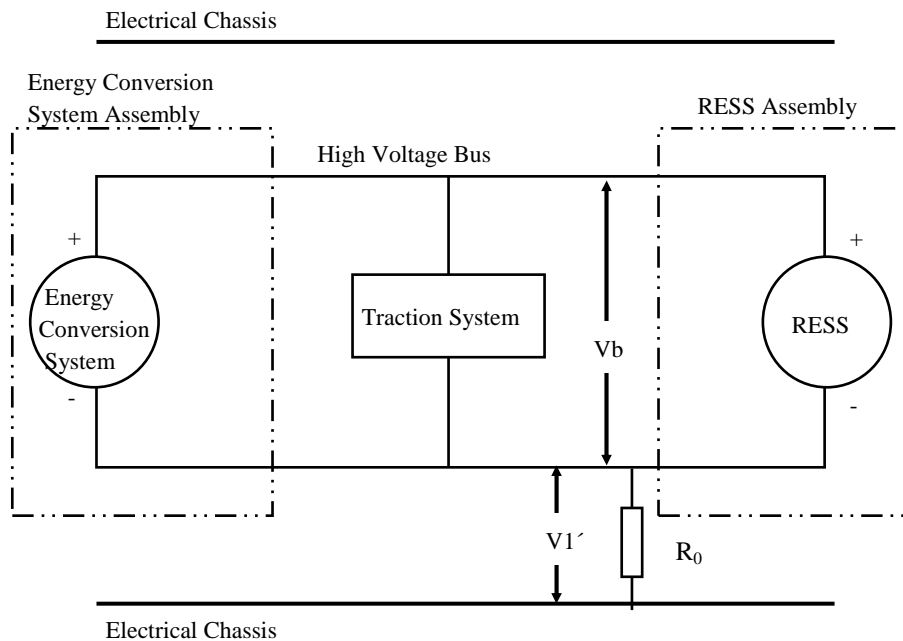

If  $V_2$  is greater than  $V_1$ , a standard known resistance ( $R_0$ ) is inserted between the positive side of the high voltage bus and the electrical chassis. With  $R_0$  installed, the voltage ( $V_2'$ ) between the positive side of the high voltage bus and the electrical chassis is measured. (See Figure 10). The electrical isolation ( $R_i$ ) is calculated according to the formula shown below. This electrical isolation value (in ohms) is divided by the nominal operating voltage of the high voltage bus (in volts). The electrical isolation ( $R_i$ ) is calculated according to the following formula:

$$R_i = R_0 \cdot (V_b / V_2' - V_b / V_2) \text{ or } R_i = R_0 \cdot V_b \cdot (1 / V_2' - 1 / V_2)$$

The resulting  $R_i$ , which is the electrical isolation resistance value (in  $\Omega$ ), is divided by the working voltage of the high voltage bus in volts (V).

$$R_i \Omega / V = R_i \Omega / \text{Working voltage}$$

Figure 11  
Measurement of  $V_2$

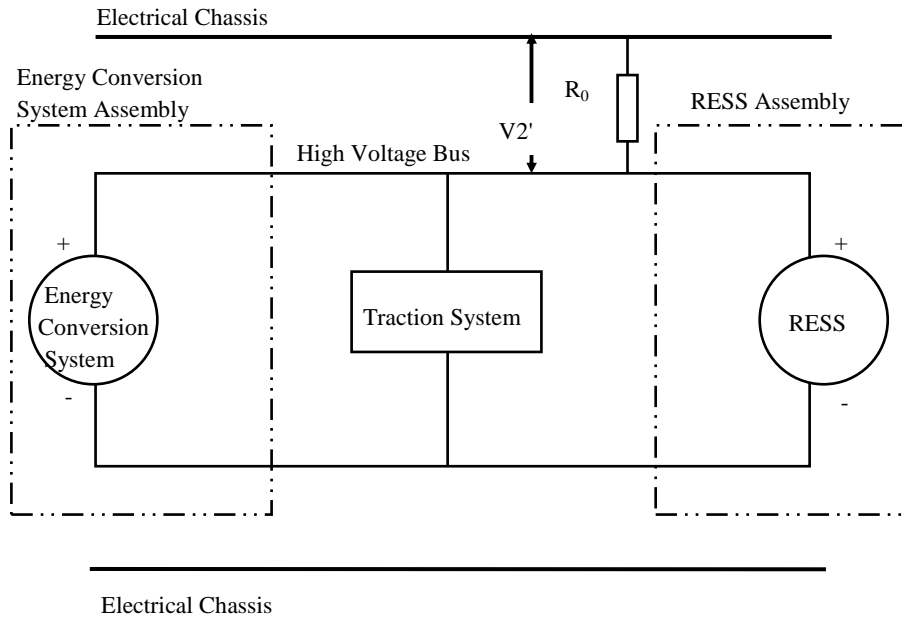

6.3.1.2.2.3.5. Fifth step

The electrical isolation value  $R_i$  (in ohms) divided by the working voltage of the high voltage bus (in volts) results in the isolation resistance (in ohms/volt).

(Note 1: The standard known resistance  $R_0$  (in ohms) is the value of the minimum required isolation resistance (in ohms/V) multiplied by the working voltage of the vehicle plus/minus 20 per cent (in volts).  $R_0$  is not required to be precisely this value since the equations are valid for any  $R_0$ ; however, a  $R_0$  value in this range should provide good resolution for the voltage measurements.)

6.3.2. Confirmation Method for Functions of On-board Isolation Resistance Monitoring System

The function of the on-board isolation resistance monitoring system is confirmed by the following method or a method equivalent to it.

A resistor is inserted that does not cause the isolation resistance between the terminal being monitored and the electrical chassis to drop below the minimum required isolation resistance value. The warning signal shall be activated.

6.3.3. Protection against direct contacts of Parts under Voltage

6.3.3.1. Access probes

Access probes to verify the protection of persons against access to live parts are given in table 2.

6.3.3.2. Test conditions



The access probe is pushed against any openings of the enclosure with the force specified in table 1. If it partly or fully penetrates, it is placed in every possible position, but in no case shall the stop face fully penetrate through the opening.

Internal electrical protection barriers are considered part of the enclosure.

A low-voltage supply (of not less than 40 V and not more than 50 V) in series with a suitable lamp is connected, if necessary, between the probe and live parts inside the electrical protection barrier or enclosure.

The signal-circuit method is also applied to the moving live parts of high voltage equipment.

Internal moving parts may be operated slowly, where this is possible.

#### 6.3.3.3. Acceptance conditions

The access probe does not touch live parts.

If this requirement is verified by a signal circuit between the probe and live parts, the lamp shall not light.

In the case of the test for IPXXB, the jointed test finger may penetrate to its 80 mm length, but the stop face (diameter 50 mm x 20 mm) shall not pass through the opening. Starting from the straight position, both joints of the test finger are successively bent through an angle of up to 90 degree with respect to the axis of the adjoining section of the finger and are placed in every possible position.

In case of the tests for IPXXD, the access probe may penetrate to its full length, but the stop face shall not fully penetrate through the opening.

Table 2

**Access probes for the tests for protection of persons against access to hazardous parts**

First numeral	Addit. letter	Access probe (Dimensions in mm)	Test force
2	B	<p style="text-align: center;"><b>Jointed test finger</b></p>  <p style="text-align: center;">See Fig.1 for full dimensions</p> <p style="text-align: center;">Insulating material</p> <p style="text-align: center;">Jointed test finger (Metal)</p> <p style="text-align: center;">Stop face (Ø 50 x 20)</p> <p style="text-align: center;">Ø 12</p> <p style="text-align: center;">80</p>	10 N±10%
4, 5, 6	D	<p style="text-align: center;"><b>Test wire 1.0 mm diameter, 100 mm long</b></p>  <p style="text-align: center;">Sphere 35±0.2</p> <p style="text-align: center;">Approx. 100</p> <p style="text-align: center;">100±0.2</p> <p style="text-align: center;">Ø 10</p> <p style="text-align: center;">Handle (Insulating material)</p> <p style="text-align: center;">Stop face (Insulating material)</p> <p style="text-align: center;">Rigid test wire (Metal)</p> <p style="text-align: center;">Edges free from burrs</p> <p style="text-align: center;">Ø 1 +0.05 / 0</p>	1N±10%

Figure 12  
**Jointed Test Fingers**



Material: metal, except where otherwise specified

Linear dimensions in millimetres

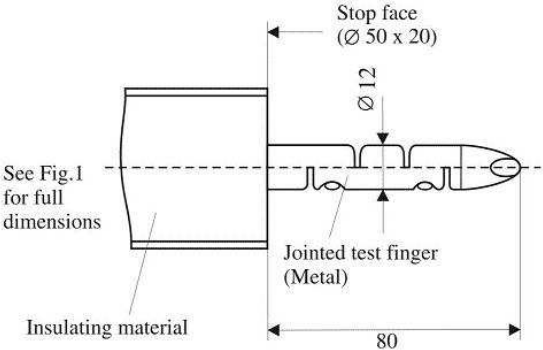
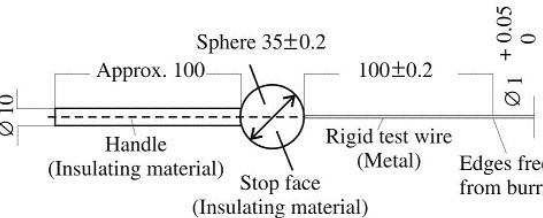
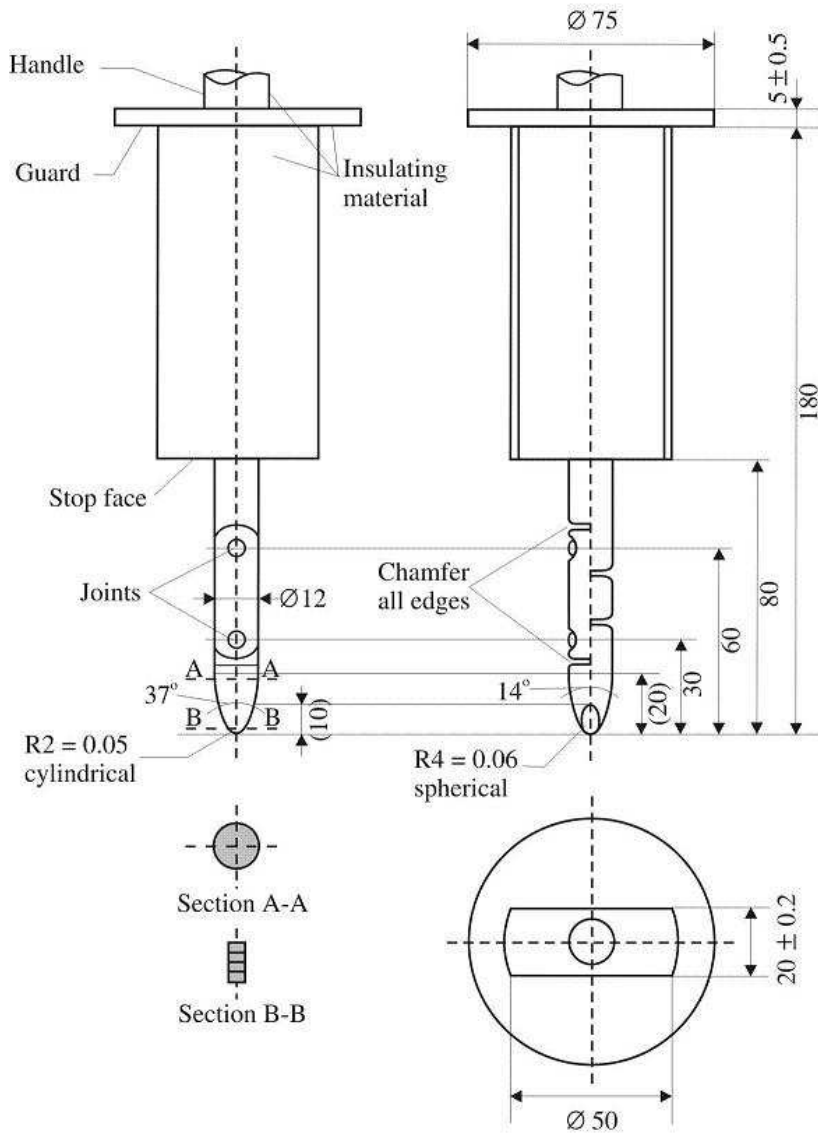
Tolerances on dimensions without specific tolerance:

on angles, 0/10'

on linear dimensions:

up to 25 mm: 0/-0.05

over 25 mm:  $\pm 0.2$

Both joints shall permit movement in the same plane and the same direction through an angle of 90° with a 0 to +10° tolerance.

#### 6.3.4. Test Method for Measuring Electric Resistance

Test method using a resistance tester.

The resistance tester is connected to the measuring points (typically, electrical chassis and electro conductive enclosure/electrical protection barrier) and the resistance is measured using a resistance tester that meets the specification that follows.

Resistance tester: Measurement current at least 0.2 A

Resolution 0.01 Ω or less

The resistance R shall be less than 0.1 ohm.

Test method using D.C. power supply, voltmeter and ammeter.

Example of the test method using D.C. power supply, voltmeter and ammeter is shown below.

Figure 13

**Connection to Barrier/Enclosure**

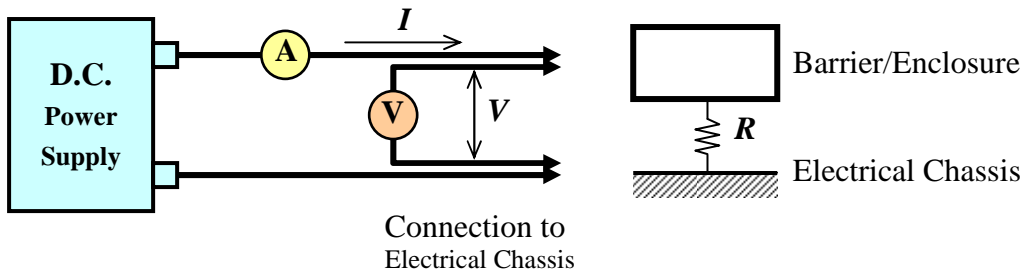

**Test Procedure**

The D.C. power supply, voltmeter and ammeter are connected to the measuring points (Typically, electrical chassis and electro conductive enclosure/electrical protection barrier).

The voltage of the D.C. power supply is adjusted so that the current flow becomes more than 0.2 A.

The current "I " and the voltage "V " are measured.

The resistance "R " is calculated according to the following formula:  
 $R = V / I$

The resistance R shall be less than 0.1 ohm.

Note:

If lead wires are used for voltage and current measurement, each lead wire shall be independently connected to the electrical protection barrier/enclosure/electrical chassis. Terminal can be common for voltage measurement and current measurement.

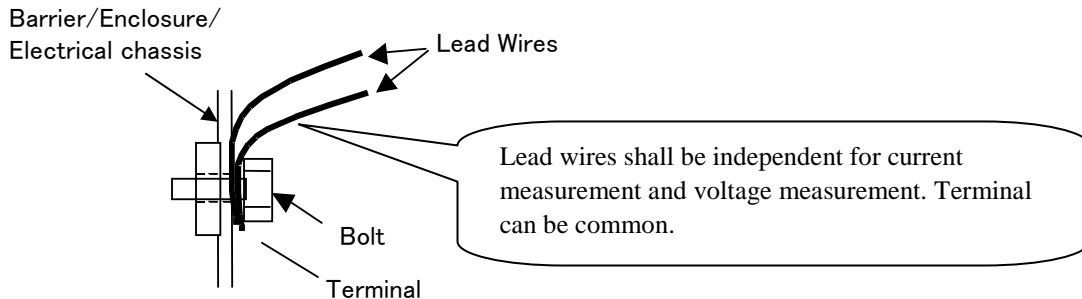

### 6.3.5. Test Conditions and Test Procedure regarding Post Crash

#### 6.3.5.1. Test Conditions

##### 6.3.5.1.1. General

The test conditions specified in paragraphs 6.3.5.1.2 to 6.3.5.1.4. are used.

Where a range is specified, the vehicle shall be capable of meeting the requirements at all points within the range.

##### 6.3.5.1.2. Electrical power train adjustment

6.3.5.1.2.1. The RESS may be at any state of charge, which allows the normal operation of the power train as recommended by the manufacturer.

6.3.5.1.2.2. The electrical power train shall be energized with or without the operation of the original electrical energy sources (e.g. engine-generator, RESS or electric energy conversion system), however:

6.3.5.1.2.2.1. It is permissible to perform the test with all or parts of the electrical power train not being energized insofar as there is no negative influence on the test result. For parts of the electrical power train not energized, the protection against electric shock shall be proved by either physical protection or isolation resistance and appropriate additional evidence.

6.3.5.1.2.2.2. If the power train is not energized and an automatic disconnect is provided, it is permissible to perform the test with the automatic disconnect being triggered. In this case it shall be demonstrated that the automatic disconnect would have operated during the impact test. This includes the automatic activation signal as well as the conductive separation considering the conditions as seen during the impact.

6.3.5.1.3. ~~It is allowed to modify~~ **Contracting parties may allow modifications to the fuel system so that an appropriate amount of fuel can be used to run the engine or the electrical energy conversion system.**

6.3.5.1.4. The vehicle conditions other than specified in paras. 6.3.5.1.1 to 6.3.5.1.3. are in the crash test protocols of the contracting parties.

6.3.5.2. Test Procedures for the protection of the occupants of vehicles operating on electrical power from high voltage and electrolyte spillage

This section describes test procedures to demonstrate compliance with the electrical safety requirements of para. 5.3.2.

Before the vehicle impact test conducted, the high voltage bus voltage ( $V_b$ ) (see figure 1) is measured and recorded to confirm that it is within the operating voltage of the vehicle as specified by the vehicle manufacturer.

6.3.5.2.1. Test setup and equipment

If a high voltage disconnect function is used, measurements are taken from both sides of the device performing the disconnect function.

However, if the high voltage disconnect is integral to the RESS or the energy conversion system and the high-voltage bus of the RESS or the energy conversion system is protected according to protection IPXXB following the impact test, measurements may only be taken between the device performing the disconnect function and electrical loads.

The voltmeter used in this test measures DC values and have an internal resistance of at least 10 M $\Omega$ .

6.3.5.2.2. The following instructions may be used if voltage is measured.

After the impact test, determine the high voltage bus voltages ( $V_b$ ,  $V_1$ ,  $V_2$ ) (see figure 14).

The voltage measurement is made not earlier than 5 seconds, but not later than 60 seconds after the impact.

This procedure is not applicable if the test is performed under the condition where the electric power train is not energized.

Figure 14  
Measurement of  $V_b$ ,  $V_1$ ,  $V_2$

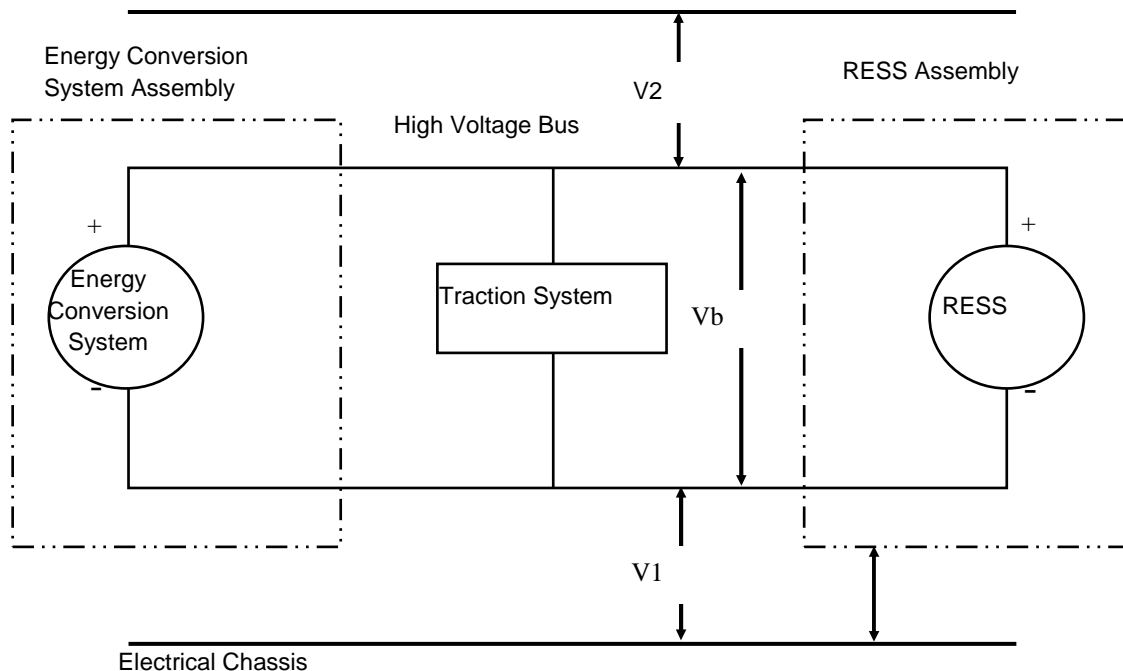

#### 6.3.5.2.3. Isolation resistance

See para. 6.3.1.2 "Measurement method"

All measurements for calculating voltage(s) and electrical isolation are made after a minimum of 5 seconds after the impact.

For example, megohmmeter or oscilloscope measurements are an appropriate alternative to the procedure described above for measuring isolation resistance. In this case it may be necessary to deactivate the on-board isolation resistance monitoring system.

#### [6.3.5.2.4. Physical Protection

Following the vehicle crash test, any parts surrounding the high voltage components are opened, disassembled or removed without the use of tools. All remaining surrounding parts shall be considered part of the physical protection.

The Jointed Test Finger described in para. 6.3.3. is inserted into any gaps or openings of the physical protection with a test force of  $10\text{ N} \pm 10\text{ per cent}$  for electrical safety assessment. If partial or full penetration into the physical protection by the Jointed Test Finger occurs, the Jointed Test Finger shall be placed in every position as specified below.

Starting from the straight position, both joints of the test finger are rotated progressively through an angle of up to 90 degrees with respect to the axis of the adjoining section of the finger and are placed in every possible position.

Internal electrical protection barriers are considered part of the enclosure

If appropriate, a low-voltage supply (of not less than 40 V and not more than 50 V) in series with a suitable lamp is connected between the Jointed Test Finger and high voltage live parts inside the electrical protection barrier or enclosure

6.3.5.2.5. Acceptance conditions

The requirements of para. 5.3.2.2.3. are met if the Jointed Test Finger described in para. 6.3.3. is unable to contact high voltage live parts.

If necessary a mirror or a fibrescope may be used in order to inspect whether the Jointed Test Finger touches the high voltage buses.

If this requirement is verified by a signal circuit between the Jointed Test Finger and high voltage live parts, the lamp shall not light.

6.3.5.2.6. Electrolyte spillage

Appropriate coating shall be applied, if necessary, to the physical protection in order to confirm any electrolyte leakage from the RESS after the impact test.

Unless the manufacturer provides the means to differentiate among the leakage of different liquids, all liquid leakage is considered as an electrolyte.

6.3.5.2.7. RESS retention

Compliance shall be determined by visual inspection

## **7. Vehicles with a liquid hydrogen storage system (LHSSs)**

7.1. LHSS optional requirements

As described in para. 7 of the preamble, individual Contracting Parties may elect to adopt the gtr with or without the LHSS requirements in para. 7.

Para. 7. is organized as follows:

Para. 7.2. LHSS design qualification requirements

Para. 7.3. LHSS fuel system integrity

Para. 7.4. Test procedures for LHSS design qualification

Para. 7.5. Test procedures for LHSS fuel system integrity

7.2. LHSS design qualification requirements

This Section specifies the requirements for the integrity of a liquefied hydrogen storage system.

The hydrogen storage system qualifies for the performance test requirements specified in this Section. All liquefied hydrogen storage systems produced for on-road vehicle service shall be capable of satisfying requirements of para. 7.2.

The manufacturer shall specify a maximum allowable working pressure (MAWP) for the inner container.

The test elements within these performance requirements are summarized in Table 3.



These criteria apply to qualification of storage systems for use in new vehicle production. They do not apply to re-qualification of any single produced system for use beyond its expected useful service or re-qualification after a potentially significant damaging event.

Table 3

---

**Overview of Performance Qualification Requirements**

---

**Para. 7.2.1. Verification of Baseline Metrics**

7.2.1.1. Proof pressure

7.2.1.2. Baseline initial burst pressure, performed on the inner container

7.2.1.3. Baseline Pressure cycle life

---

**Para. 7.2.2. Verification of Expected On-road Performance**

Para. 7.2.2.1. Boil-off

Para. 7.2.2.2. Leak

Para. 7.2.2.3. Vacuum loss

**Para. 7.2.3. Verification for Service Terminating Performance: Bonfire**

---

**Para. 7.2.4. Verification of Components**

---

**7.2.1. Verification of Baseline Metrics**
**7.2.1.1. Proof pressure**

A system is pressurized to a pressure  $p_{test} \geq 1.3$  (MAWP  $\pm$  0.1 MPa) in accordance with test procedure para. 7.4.1.1. without visible deformation, degradation of container pressure, or detectable leakage.

**7.2.1.2. Baseline Initial Burst Pressure**

The burst test is performed per the test procedure in para. 7.4.1.2. on one sample of the inner container that is not integrated in its outer jacket and not insulated.

The burst pressure shall be at least equal to the burst pressure used for the mechanical calculations. For steel containers that is either:

(a) the Maximum Allowable Working Pressure (MAWP) (in MPa) plus 0.1 MPa multiplied by 3.25;

or

(b) the Maximum Allowable Working Pressure (MAWP) (in MPa) plus 0.1 MPa multiplied by 1.5 and multiplied by  $R_m/R_p$ , where  $R_m$  is the minimum ultimate tensile strength of the container material and  $R_p$  (minimum yield strength) is 1.0 for austenitic steels and  $R_p$  is 0.2 for other steels.

**7.2.1.3. Baseline Pressure Cycle Life**

When using metallic containers and/or metallic vacuum jackets, the manufacturer shall either provide a calculation in order to demonstrate that the container is designed according to current regional legislation or accepted standards (e.g. in US the ASME Boiler and Pressure Vessel Code, in Europe EN 1251-1 and EN 1251-2 and in all other countries an applicable regulation for the design of metallic pressure containers), or define and perform suitable tests (including para. 7.4.1.3.) that prove the same level of safety compared to a design supported by calculation according to accepted standards.

For non-metallic containers and/or vacuum jackets, in addition to para. 7.4.1.3. testing, suitable tests shall be designed by the manufacturer to prove the same level of safety compared to a metallic container.

## 7.2.2. Verification for Expected On-road Performance

### 7.2.2.1. Boil-off

The boil-off test is performed on a liquid hydrogen storage system equipped with all components as described in para. 7.1.2. of the preamble (Figure 4). The test is performed on a system filled with liquid hydrogen per the test procedure in para. 7.4.2.1. and shall demonstrate that the boil-off system limits the pressure in the inner storage container to below the maximum allowable working pressure.

### 7.2.2.2. Leak

After the boil-off test in para. 7.2.2.1., the system is kept at boil-off pressure and the total discharge rate due to leakage shall be measured per the test procedure in para. 7.4.2.2.. The maximum allowable discharge from the hydrogen storage system is  $R*150$  NmL/min where  $R = (V_{width}+1)*(V_{height}+0.5)*(V_{length}+1)/30.4$  and  $V_{width}$ ,  $V_{height}$ ,  $V_{length}$  are the vehicle width, height, length (m), respectively.]

### 7.2.2.3. Vacuum loss

The vacuum loss test is performed on a liquid hydrogen storage system equipped with all components as described in para. 7.1.2. of the preamble (Figure 7.1.2. of the preamble). The test is performed on a system filled with liquid hydrogen per the test procedure in para. 7.4.2.3. and shall demonstrate that both primary and secondary pressure relief devices limit the pressure to the values specified in para. 7.4.2.3. in case vacuum pressure is lost.

## 7.2.3. Verification of Service-Terminating Conditions: Bonfire

At least one system shall demonstrate the working of the pressure relief devices and the absence of rupture under the following service-terminating conditions. Specifics of test procedures are provided in para. 7.4.3.

A hydrogen storage system is filled to half-full liquid level and exposed to fire in accordance with test procedure para. 7.4.3. The pressure relief device(s) shall release the contained gas in a controlled manner without rupture.

For steel containers the test is passed when the requirements relating to the pressure limits for the pressure relief devices as described in para. 7.4.3. are fulfilled. For other container materials, an equivalent level of safety shall be demonstrated.

## 7.2.4. Verification of Components

The entire storage system does not have to be re-qualified (para. 7.2.) if container shut-off devices and pressure relief devices (components in Figure 4 of the preamble excluding the storage container) are exchanged for equivalent components having comparable function, fittings, and dimensions, and qualified for performance using the same qualification (paras. 7.2.4.1. and 7.2.4.2.) as the original components.

7.2.4.1. Pressure Relief Devices Qualification Requirements

Design qualification testing shall be conducted on finished pressure relief devices which are representative of normal production. The pressure relief devices shall meet the following performance qualification requirements:

- (a) Pressure Test (para. 7.4.4.1. test procedure)
- (b) External leakage Test (para. 7.4.4.2. test procedure)
- (c) Operational Test (para. 7.4.4.4. test procedure)
- (d) Corrosion Resistance Test (para. 7.4.4.4. test procedure)
- (e) Temperature cycle Test (para. 7.4.4.8. test procedure)

7.2.4.2. Shut-off Valves Qualification Requirements

Design qualification testing shall be conducted on finished shut-off valves (in Figure 4 of the preamble named shut-off devices) which are representative for normal production. The valve shall meet the following performance qualification requirements:

- (a) Pressure Test (para. 7.4.4.1. test procedure)
- (b) External leakage Test (para. 7.4.4.2. test procedure)
- (c) Endurance Test (para. 7.4.4.3. test procedure)
- (d) Corrosion Resistance Test (para. 7.4.4.5. test procedure)
- (e) Resistance to dry-heat Test (para. 7.4.4.6. test procedure)
- (f) Ozone ageing Test (para. 7.4.4.7. test procedure)
- (g) Temperature cycle Test (para. 7.4.4.8. test procedure)
- (h) Flex Line Cycle Test (para. 7.4.4.9. test procedure)

7.2.5. Labelling

A label shall be permanently affixed on each container with at least the following information: Name of the Manufacturer, Serial Number, Date of Manufacture, MAWP, Type of Fuel. Any label affixed to the container in compliance with this section shall remain in place. Contracting parties may specify additional labelling requirements.

7.3. LHSS Fuel System Integrity

This section specifies requirements for the integrity of the hydrogen fuel delivery system, which includes the liquid hydrogen storage system, piping, joints, and components in which hydrogen is present. These requirements are in addition to requirements specified in para. 5.2., all of which apply to vehicles with liquid hydrogen storage systems with the exception of para. 5.2.1.1. The fuelling receptacle label shall designate liquid hydrogen as the fuel type. Test procedures are given in para. 7.5.

7.3.1. Flammable materials used in the vehicle shall be protected from liquefied air that may condense on elements of the fuel system.

7.3.2. The insulation of the components shall prevent liquefaction of the air in contact with the outer surfaces, unless a system is provided for collecting and vaporizing the liquefied air. The materials of the components nearby shall be compatible with an atmosphere enriched with oxygen.

7.4. Test Procedures for LHSS Design Qualification

7.4.1. Verification Tests for Baseline Metrics

7.4.1.1. Proof pressure test

The inner container and the pipe work situated between the inner container and the outer jacket shall withstand an inner pressure test at room temperature according to the following requirements.

The test pressure  $p_{\text{test}}$  is defined by the manufacturer and shall fulfil the following requirements:

$$p_{\text{test}} \geq 1.3 (\text{MAWP} \pm 0.1 \text{ MPa})$$

- (a) For metallic containers, either  $p_{\text{test}}$  is equal to or greater than the maximum pressure of the inner container during fault management (as determined in para. 7.4.2.3.) or the manufacturer proves by calculation that at the maximum pressure of the inner container during fault management no yield occurs.
- (b) For non-metallic containers,  $p_{\text{test}}$  is equal to or greater than the maximum pressure of the inner container during fault management (as determined in para. 7.4.2.3.).

The test is conducted according to the following procedure:

- (a) The test is conducted on the inner storage container and the interconnecting pipes between inner storage container and vacuum jacket before the outer jacket is mounted.
- (b) The test is either conducted hydraulically with water or a glycol/water mixture, or alternatively with gas. The container is pressurized to test pressure  $p_{\text{test}}$  at an even rate and kept at that pressure for at least 10 minutes.
- (c) The test is done at ambient temperature. In the case of using gas to pressurize the container, the pressurization is done in a way that the container temperature stays at or around ambient temperature.

The test is passed successfully if, during the first 10 minutes after applying the proof pressure, no visible permanent deformation, no visible degradation in the container pressure and no visible leakage are detectable.

7.4.1.2. Baseline Initial Burst Pressure

The test is conducted according to the following procedure:

- (a) The test is conducted on the inner container at ambient temperature.
- (b) The test is conducted hydraulically with water or a water/glycol mixture.

- (c) The pressure is increased at a constant rate, not exceeding 0.5 MPa/min until burst or leakage of the container occurs.
- (d) When the Maximum Allowable Working Pressure (MAWP) is reached there is a wait period of at least ten minutes at constant pressure, during which time the deformation of the container can be checked.
- (e) The pressure is recorded or written during the entire test.

For steel inner containers, the test is passed successfully if at least one of the two passing criteria described in para. 5.2.1.2. is fulfilled. For inner containers made out of an aluminium alloy or other material, a passing criterion shall be defined which guarantees at least the same level of safety compared to steel inner containers.

#### 7.4.1.3. Baseline Pressure Cycle Life

Containers and/or vacuum jackets are pressure cycled with a number of cycles at least three times the number of possible full pressure cycles (from the lowest to highest operating pressure) for an expected on-road performance. The number of pressure cycles is defined by the manufacturer under consideration of operating pressure range, size of the storage and, respectively, maximum number of refuellings and maximum number of pressure cycles under extreme usage and storage conditions. Pressure cycling is conducted between atmospheric pressure and MAWP at liquid nitrogen temperatures, e.g. by filling the container with liquid nitrogen to certain level and alternately pressurizing and depressurizing it with (pre-cooled) gaseous nitrogen or helium.

#### 7.4.2. Verification for Expected On-road Performance

##### 7.4.2.1. Boil-off test

The test is conducted according to the following procedure:

- (a) For pre-conditioning, the container is fuelled with liquid hydrogen to the specified maximum filling level. Hydrogen is subsequently extracted until it meets half filling level, and the system is allowed to completely cool down for at least 24 hours and a maximum of 48 hours.
- (b) The container is filled to the specified maximum filling level.
- (c) The container is pressurized until boil-off pressure is reached.
- (d) The test lasts for at least another 48 hours after boil-off started and is not terminated before the pressure stabilizes. Pressure stabilization has occurred when the average pressure does not increase over a two hour period.

The pressure of the inner container is recorded or written during the entire test. The test is passed successfully if the following requirements are fulfilled:

- (a) The pressure stabilizes and stays below MAWP during the whole test.
- (b) The pressure relief devices are not allowed to open during the whole test.

The pressure of the inner container shall be recorded or written during the entire test. The test is passed when the following requirements are fulfilled:

- (a) The pressure shall stabilize and stay below MAWP during the whole test.
- (b) The pressure relief devices are not allowed to open during the whole test.

7.4.2.2. Leak test

The test shall be conducted according to the procedure described in para. 7.4.4.2.

7.4.2.3. Vacuum loss test

The first part of the test is conducted according to the following procedure:

- (a) The vacuum loss test is conducted with a completely cooled-down container (according to the procedure in para. 7.4.2.1.).
- (b) The container is filled with liquid hydrogen to the specified maximum filling level.
- (c) The vacuum enclosure is flooded with air at an even rate to atmospheric pressure.
- (d) The test is terminated when the first pressure relief device does not open any more.

The pressure of the inner container and the vacuum jacket is recorded or written during the entire test. The opening pressure of the first safety device is recorded or written. The first part of test is passed if the following requirements are fulfilled:

- (a) The first pressure relief device opens below or at MAWP and limit the pressure to not more than 110 per cent of the MAWP.
- (b) The first pressure relief device does not open at pressure above MAWP.
- (c) The secondary pressure relief device does not open during the entire test.

After passing the first part, the test shall be repeated subsequently to re-generation of the vacuum and cool-down of the container as described above.

- (a) The vacuum is re-generated to a value specified by the manufacturer. The vacuum shall be maintained at least 24 hours. The vacuum pump may stay connected until the time directly before the start of the vacuum loss.
- (b) The second part of the vacuum loss test is conducted with a completely cooled-down container (according to the procedure in para. 7.4.2.1.).
- (c) The container is filled to the specified maximum filling level.
- (d) The line downstream the first safety relief device is blocked and the vacuum enclosure is flooded with air at an even rate to atmospheric pressure.

- (e) The test is terminated when the second pressure relief device does not open any more.

The pressure of the inner container and the vacuum jacket is recorded or written during the entire test. For steel containers the second part of the test is passed if the second pressure relief device does not open below 110 per cent of the set pressure of the first safety relief device and limits the pressure in the container to a maximum 136 per cent of the MAWP if a safety valve is used, or, 150 per cent of the MAWP if a burst disk is used as the second safety relief device. For other container materials, an equivalent level of safety shall be demonstrated.

#### 7.4.3. Verification Test for Service-Terminating Performance Due to Fire

The tested liquid hydrogen storage system shall be representative of the design and the manufacturing of the type to be homologated. Its manufacturing shall be completely finished and it shall be mounted with all its equipment.

The first part of the test is conducted according to the following procedure:

- (a) The bonfire test is conducted with a completely cooled-down container (according to the procedure in para. 7.4.2.1.).
- (b) The container contained during the previous 24 hours a volume of liquid hydrogen at least equal to half of the water volume of the inner container.
- (c) The container is filled with liquid hydrogen so that the quantity of liquid hydrogen measured by the mass measurement system is half of the maximum allowed quantity that may be contained in the inner container.
- (d) A fire burns 0.1 m underneath the container. The length and the width of the fire exceed the plan dimensions of the container by 0.1 m. The temperature of the fire is at least 590 °C. The fire shall continue to burn for the duration of the test.
- (e) The pressure of the container at the beginning of the test is between 0 MPa and 0.01 MPa at the boiling point of hydrogen in the inner container.
- (f) The test shall continue until the storage pressure decreases to or below the pressure at the beginning of the test, or alternatively in case the first PRD is a re-closing type, the test shall continue until the safety device has opened for a second time.
- (g) The test conditions and the maximum pressure reached within the container during the test are recorded in a test certificate signed by the manufacturer and the technical service.

The test is passed if the following requirements are fulfilled:

- (a) The secondary pressure relief device is not operated below 110 per cent of the set pressure of the primary pressure relief device.
- (b) The container shall not burst and the pressure inside the inner container shall not exceed the permissible fault range of the inner container.

The permissible fault range for steel containers is as follows:

- (a) If a safety valve is used as secondary pressure relief device, the pressure inside the container does not exceed 136 per cent of the Maximum Allowable Working Pressure (MAWP) of the inner container.
- (b) If a burst disk is used outside the vacuum area as secondary pressure relief device, the pressure inside the container is limited to 150 per cent of the Maximum Allowable Working Pressure (MAWP) of the inner container.
- (c) If a burst disk is used inside the vacuum area as secondary pressure relief device, the pressure inside the container is limited to 150 per cent of the Maximum Allowable Working Pressure plus 0.1 MPa (MAWP  $\pm$  0.1 MPa) of the inner container.

For other materials, an equivalent level of safety shall be demonstrated.

#### 7.4.4. Component Verification Tests

Testing shall be performed with hydrogen gas having gas quality compliant with ISO 14687-2/SAE J2719. All tests shall be performed at ambient temperature 20( $\pm$ 5) $^{\circ}$ C unless otherwise specified. The TPRD qualification performance tests are specified as follows:

##### 7.4.4.1. Pressure Test

A hydrogen containing component shall withstand without any visible evidence of leak or deformation a test pressure of 150 per cent Maximum Allowable Working Pressure (MAWP) with the outlets of the high pressure part plugged. The pressure shall subsequently be increased from 150 per cent to 300 per cent Maximum Allowable Working Pressure (MAWP). The component shall not show any visible evidence of rupture or cracks.

The pressure supply system shall be equipped with a positive shut-off valve and a pressure gauge having a pressure range of not less than 150 per cent and no more than 200 per cent of the test pressure; the accuracy of the gauge shall be 1 per cent of the pressure range.

For components requiring a leakage test, this test shall be performed prior to the pressure test.

##### 7.4.4.2. External leakage Test

A component shall be free from leakage through stem or body seals or other joints, and shall not show evidence of porosity in casting when tested as described in para. 7.4.4.3.3. at any gas pressure between zero and its Maximum Allowable Working Pressure (MAWP).

The test shall be performed on the same equipment at the following conditions:

- (a) at ambient temperature;
- (b) at the minimum operating temperature or at liquid nitrogen temperature after sufficient conditioning time at this temperature to ensure thermal stability;
- (c) at the maximum operating temperature after sufficient conditioning time at this temperature to ensure thermal stability.



During this test, the equipment under test shall be connected to a source of gas pressure. A positive shut-off valve and a pressure gauge having a pressure range of not less than 150 per cent and not more than 200 per cent of the test pressure shall be installed in the pressure supply piping; the accuracy of the gauge shall be 1 per cent of the pressure range. The pressure gauge shall be installed between the positive shut-off valve and the sample under test.

Throughout the test, the sample shall be tested for leakage, with a surface active agent without formation of bubbles or measured with a leakage rate less than 216 Nml/hour.

#### 7.4.4.3. Endurance Test

7.4.4.3.1. A component shall be capable of conforming to the applicable leakage test requirements of paras. 7.4.4.2. and 7.4.4.9., after being subjected to 20000 operation cycles.

7.4.4.3.2. The appropriate tests for external leakage and seat leakage, as described in paras. 7.4.4.2. and 7.4.4.9. shall be carried out immediately following the endurance test.

7.4.4.3.3. The shut-off valve shall be securely connected to a pressurized source of dry air or nitrogen and subjected to 20000 operation cycles. A cycle shall consist of one opening and one closing of the component within a period of not less than  $10 \pm 2$  seconds.

7.4.4.3.4. The component shall be operated through 96 per cent of the number of specified cycles at ambient temperature and at the MAWP of the component. During the off cycle the downstream pressure of the test fixture shall be allowed to decay to 50 per cent of the MAWP of the component.

7.4.4.3.5. The component shall be operated through 2 per cent of the total cycles at the maximum material temperature ( $-40\text{ }^{\circ}\text{C}$  to  $+85\text{ }^{\circ}\text{C}$ ) after sufficient conditioning time at this temperature to ensure thermal stability and at MAWP. The component shall comply with paras. 7.4.4.2. and 7.4.4.9. at the appropriate maximum material temperature ( $-40\text{ }^{\circ}\text{C}$  to  $+85\text{ }^{\circ}\text{C}$ ) at the completion of the high temperature cycles.

7.4.4.3.6. The component shall be operated through 2 per cent of the total cycles at the minimum material temperature ( $-40\text{ }^{\circ}\text{C}$  to  $+85\text{ }^{\circ}\text{C}$ ) but not less than the temperature of liquid nitrogen after sufficient conditioning time at this temperature to ensure thermal stability and at the MAWP of the component. The component shall comply with paras. 7.4.4.2. and 7.4.4.9. at the appropriate minimum material temperature ( $-40\text{ }^{\circ}\text{C}$  to  $+85\text{ }^{\circ}\text{C}$ ) at the completion of the low temperature cycles.

#### 7.4.4.4. Operational Test

The operational test shall be carried out in accordance with EN 13648-1 or EN 13648 2. The specific requirements of the standard are applicable.

#### 7.4.4.5. Corrosion Resistance Test

Metallic hydrogen components shall comply with the leakage tests referred to paras. 7.4.4.2. and 7.4.4.9. after being submitted to 144 hours salt spray test according to ISO 9227 with all connections closed.

A copper or brass hydrogen containing component shall comply with the leakage tests referred to paras. 7.4.4.2. and 7.4.4.9. and after being submitted

to 24 hours immersion in ammonia according to ISO 6957 with all connections closed.

7.4.4.6. Resistance to dry-heat Test

The test shall be carried out in compliance with ISO 188. The test piece shall be exposed to air at a temperature equal to the maximum operating temperature for 168 hours. The change in tensile strength shall not exceed  $\pm 25$  per cent. The change in ultimate elongation shall not exceed the following values:

maximum increase 10 per cent,

maximum decrease 30 per cent.

7.4.4.7. Ozone ageing Test

The test shall be in compliance with ISO 1431-1. The test piece, which shall be stressed to 20 per cent elongation, shall be exposed to air at +40 °C with an ozone concentration of 50 parts per hundred million during 120 hours.

No cracking of the test piece is allowed.

7.4.4.8. Temperature cycle Test

A non-metallic part containing hydrogen shall comply with the leakage tests referred to in paras. 7.4.4.2. and 7.4.4.9. after having been submitted to a 96 hours temperature cycle from the minimum operating temperature up to the maximum operating temperature with a cycle time of 120 minutes, under Maximum Allowable Working Pressure (MAWP).

7.4.4.9. Flex Line Cycle Test

Any flexible fuel line shall be capable of conforming to the applicable leakage test requirements referred to in para. 7.4.4.2., after being subjected to 6,000 pressure cycles.

The pressure shall change from atmospheric pressure to the Maximum Allowable Working Pressure (MAWP) of the container within less than five seconds, and after a time of at least five seconds, shall decrease to atmospheric pressure within less than five seconds.

The appropriate test for external leakage, as referred to in para. 7.4.4.2., shall be carried out immediately following the endurance test.

7.5. Test Procedures for LHSS Fuel System

7.5.1. Post-Crash Leak Test — Liquid Hydrogen Storage

Prior to the vehicle crash test, the following steps are taken to prepare the Liquefied Hydrogen Storage System (LHSS):

(a) If the vehicle does not already have the following capabilities as part of the standard vehicle, and tests in para. 6.1.1. are to be performed; the following shall be installed before the test:

(i) LHSS Pressure Sensor. The pressure sensor shall have a full scale of reading of at least 150 per cent of MAWP, an accuracy of at least 1 per cent of full scale, and capable of reading values of at least 10 kPa.

(ii) LHSS Temperature Sensor. The temperature sensor shall be capable of measuring cryogenic temperatures expected before

crash. The sensor is located on an outlet, as near as possible to the container.

- (iii) Fill and drain ports. The ability to add and remove both liquefied and gaseous contents of the LHSS before and after the crash test shall be provided.
- (b) The LHSS is purged with at least 5 volumes of nitrogen gas.
- (c) The LHSS is filled with nitrogen to the equivalence of the maximum fill level of hydrogen by weight.
- (d) After fill, the (nitrogen) gas vent is to be closed, and the container allowed to equilibrate.
- (e) The leak-tightness of the LHSS is confirmed.

After the LHSS pressure and temperature sensors indicate that the system has cooled and equilibrated, the vehicle shall be crashed per state or regional regulation. Following the crash, there shall be no visible leak of cold nitrogen gas or liquid for a period of at least 1 hour after the crash. Additionally, the operability of the pressure controls or Pressure Relief Devices (PRDs) shall be proven to ensure that the LHSS is protected against burst after the crash. If the LHSS vacuum has not been compromised by the crash, nitrogen gas may be added to the LHSS via the fill / drain port until pressure controls and/or PRDs are activated. In the case of re-closing pressure controls or PRDs, activation and re-closing for at least 2 cycles shall be demonstrated. Exhaust from the venting of the pressure controls or the PRDs shall not be vented to the passenger, luggage, or cargo compartments during these post-crash tests.

Following confirmation that the pressure control and/or safety relief valves are still functional, a leak test shall be conducted on the LHSS using the procedures in either para. 6.1.1.1. or para. 6.1.1.2.

Either test procedure para. 7.5.1.1. or the alternative test procedure para. 7.5.1.2. (consisting of paras. 7.5.1.2.1. and 7.5.1.2.2.) may be undertaken to satisfy test procedure para. 7.5.1.

#### 7.5.1.1. Post-Crash Leak Test for the Liquefied Hydrogen Storage Systems (LHSSs)

The following test would replace both the leak test in para. 7.5.1.2.1. and gas concentration measurements as defined in para. 7.5.1.2.2. Following confirmation that the pressure control and/or safety relief valves are still functional; the leak tightness of the LHSS may be proven by detecting all possible leaking parts with a sniff sensor of a calibrated Helium leak test device used in sniff modus. The test can be performed as an alternative if the following pre-conditions are fulfilled:

- (a) No possible leaking part shall be below the liquid nitrogen level on the storage container
- (b) All possible leaking parts are pressurized with helium gas when the LHSS is pressurized.
- (c) Required covers and/or body panels and parts can be removed to gain access to all potential leak sites.

Prior to the test the manufacturer shall provide a list of all possible leaking parts of the LHSS. Possible leaking parts are:

- (a) Any connectors between pipes and between pipes and the container

- (b) Any welding of pipes and components downstream the container
- (c) Valves
- (d) Flexible lines
- (e) Sensors

Prior to the leak test overpressure in the LHSS should be released to atmospheric pressure and afterwards the LHSS should be pressurized with helium to at least the operating pressure but well below the normal pressure control setting (so the pressure regulators do not activate during the test period). The test is passed if the total leakage amount (i.e. the sum of all detected leakage points) is less than 216 Nml/hr.

#### 7.5.1.2. Alternative Post-Crash Tests for Liquefied Hydrogen Storage Systems

Both tests of paras. 7.5.1.2.1. and 7.5.1.2.2. are conducted under the test procedure of para. 7.5.1.2.

##### 7.5.1.2.1. Alternative Post-Crash Leak Test for the Liquefied Hydrogen Storage Systems

Following confirmation that the pressure control and/or safety relief valves are still functional, the following test may be conducted to measure the post-crash leakage. The concentration test in para. 6.1.1.1 shall be conducted in parallel for the 60 minute test period if the hydrogen concentration has not already been directly measured following the vehicle crash.

The container shall be vented to atmospheric pressure and the liquefied contents of the container shall be removed and the container shall be heated up to ambient temperature. The heat-up could be done, e.g. by purging the container sufficient times with warm nitrogen or increasing the vacuum pressure.

If the pressure control set point is less than 90 per cent of the MAWP, the pressure control shall be disabled so that it does not activate and vent gas during the leak test.

The container shall then be purged with helium by either:

- (a) flowing at least 5 volumes through the container
- or
- (b) pressurizing and de-pressurizing the container the LHSS at least 5 times.

The LHSS shall then be filled with helium to 80 per cent of the MAWP of the container or to within 10 per cent of the primary relief valve setting, whichever results in the lower pressure, and held for a period of 60 minutes. The measured pressure loss over the 60 minute test period shall be less than less than or equal to the following criterion based on the liquid capacity of the LHSS:

- (a) 2 atm allowable loss for 100L systems or less;
- (b) 1 atm allowable loss for systems greater than 100L and less than or equal to 200L; and
- (c) 0.5 atm allowable for systems greater than 200L.

##### 7.5.1.2.2. Post-Crash Enclosed Spaces Test

The measurements shall be recorded in the crash test that evaluates potential liquid hydrogen leakage in test procedure para. 7.5.1.2.1. if the LHSS contains hydrogen for the crash test or during the helium leak test in test procedure para. 6.1.2.

Select sensors to measure the build-up of hydrogen or helium (depending which gas is contained within the Liquefied Hydrogen Storage Systems (LHSSs) for the crash test. Sensors may measure either measure the hydrogen/helium content of the atmosphere within the compartments or measure the reduction in oxygen (due to displacement of air by leaking hydrogen/helium).

The sensors shall be calibrated to traceable references, have an accuracy of 5 per cent of reading at the targeted criteria of 4 per cent hydrogen (for a test with liquefied hydrogen) or 0.8 per cent helium by volume in the air (for a test at room temperature with helium), and a full scale measurement capability of at least 25 per cent above the target criteria. The sensor shall be capable of a 90 per cent response to a full scale change in concentration within 10 seconds.

The installation in vehicles with LHSSs shall meet the same requirements as for vehicles with compressed hydrogen storage systems in para. 6.1.2. Data from the sensors shall be collected at least every 5 seconds and continue for a period of 60 minutes after the vehicle comes to a rest if post-crash hydrogen is being measured or after the initiation of the helium leak test if helium build-up is being measured. Up to a 5 second rolling average may be applied to the measurements to provide "smoothing" and filter effects of spurious data points. The rolling average of each sensor shall be below the targeted criteria of 4 per cent hydrogen (for a test with liquefied hydrogen) or 0.8 per cent helium by volume in the air (for a test at room temperature with helium) at all times throughout the 60 minute post-crash test period.

---